

**NORTHGATE**

TAKING CARE OF EVERY ASPECT

# OVERHEAD COMO

## CASSETTES

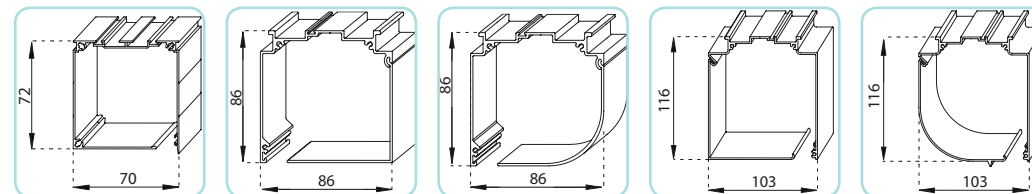

C70

C85

CT85

C100

CT100

## BOTTOM RAILS

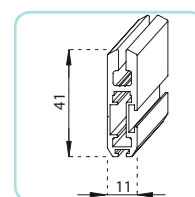

11x41

## GUIDES

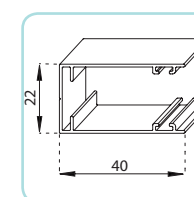

22x40

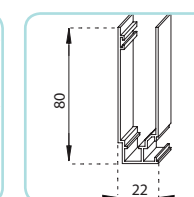

22x80

## ROLLER TUBES

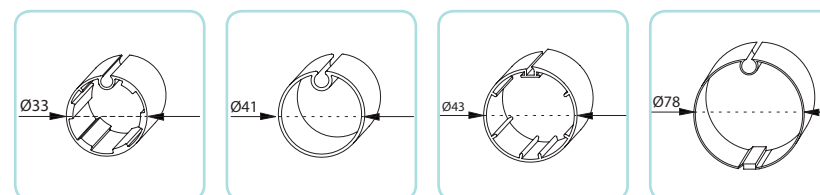

Ø33

Ø41

Ø43

Ø78

**NORTHGATE**

TAKING CARE OF EVERY ASPECT

Northgate, PO Box 200, Barnet, Herts EN4 9EW

**Tel** 020 8441 4545 **Fax** 020 8441 4888**Website** [www.northgateuk.com](http://www.northgateuk.com) **Email** [enquiries@northgateuk.com](mailto:enquiries@northgateuk.com)

The contained information in this catalogue may be imprecise because of possible technical modifications made after printing. The manufacturer reserves the right to make technical modifications without advance notice. Before making orders consult your manufacturer or retailer. The roller blind Como is designed for the sun protection of the space where it is located. Every other use is inappropriate and dangerous. Northgate cannot be considered responsible for possible damages caused by improper, erroneous and unreasonable use. The roller blind Como must be installed perpendicular to the horizontal area. When the danger of icing is present the roller blind cannot be operated, in case of strong wind it is necessary to wrap up the roller blind. The fabric can have folds that do not influence the proper functioning of the roller blind.

## OVERHEAD COMO

Northgate's Internal Como Roller Blind with a double head box satisfies the needs for an internal blind with any type of inclination. With its fabric side guides, it is possible to use Como for both filtering and black out effect. Matching cover boxes range from 60 mm to 100 mm depending on the size of the aperture. This system is available in both manual and electric.

<b>ROLLER TUBE</b>	Material:	Aluminium tube with recess	
<b>CASSETTE</b>	Material/Finishing:	Powder-coated extruded aluminium	
	Inspectable:	Yes (85-100mm)	
<b>BOTTOM RAIL</b>	Benefits:	Seal brush	
	Material:	Powder-coated extruded aluminium	
<b>GUIDES</b>	Benefits:	Seal brush	
	Material/Finishing:	Powder-coated extruded aluminium	
<b>SCREWS</b>	Inspectable:	No	
<b>HANDLINGS</b>	Material:	Stainless steel	
	Motor:	Alternating current AC 230v / 14 - 16 rpm	
<b>BRACKETS</b>	Gear:	With folded joint, folding crank handle and removable crank rod	
	Finishing:	Powder-coated stainless steel	
<b>INSTALLATION TYPES</b>		Reveal fix	
		Front fix	
<b>GUIDES INSTALLATION</b>		Front	
		In reveal	
<b>DIMENSIONS</b>	Width (mm):	600 min - 2000 max	
	Height (mm):	Depending on the fabric	
		<b>GEAR</b>	<b>MOTOR</b>
<b>FABRIC CONFECTIONING</b>	With guides:	2200 max	3000 max
	Roller tube:	Cable with tape	
<b>CERTIFICATION</b>	Bottom rail:	Fold with rigid rod	
		<b>CE</b>	13561

## TECHNICAL OPERATING SPACE

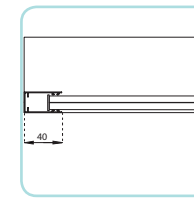

22x40 guide

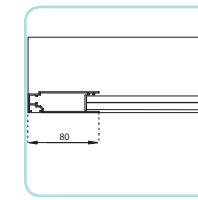

22x80 guide

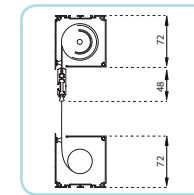

C70 cassette

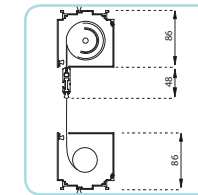

C85/C185 cassette

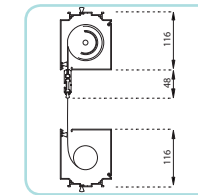

C100/CT100 cassette

## FIXING METHODS

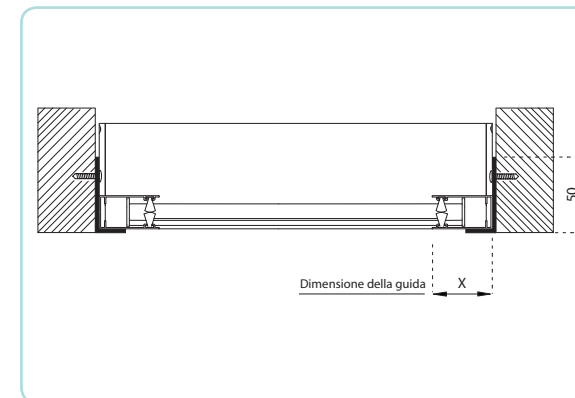

Reveal fix

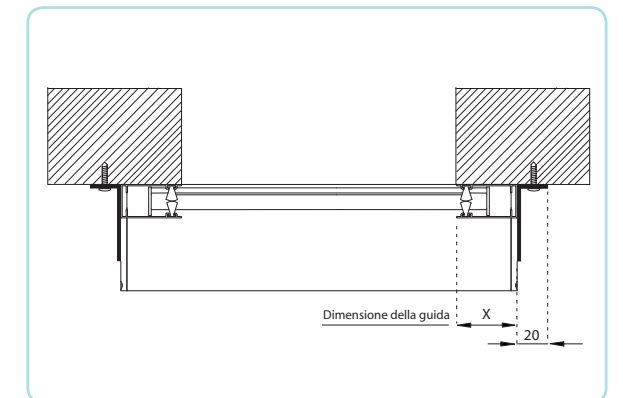

Front fix

## CONFIGURATIONS



C70 with 22x40 guide



C85/C100 with 22x80 guide

**N** **LIFETIME WARRANTY** This fabric range comes with a full **Lifetime Warranty** as standard.

For more information and images please visit our website at:

**WWW.NORTHGATEUK.COM/COMO**