

# swift ramp system

## Installation Instructions

### General

This installation manual is for in domestic/residential situations. For commercial/public or higher load requirements, please request additional installation information.

In the following text the word *ramp* is used for modules that are installed with an inclination and *platform* for modules that are aimed for a horizontal installation.

#### General

Always start at the top. Connect the highest module to the building. Check that the ground is firm enough. If needed place paving slabs or similar under the supporting legs. Once installation is complete always check that all screws are tightened, locking pins connect the handrails and that the installation is stable.

#### Screw-connections at the EU-ramp

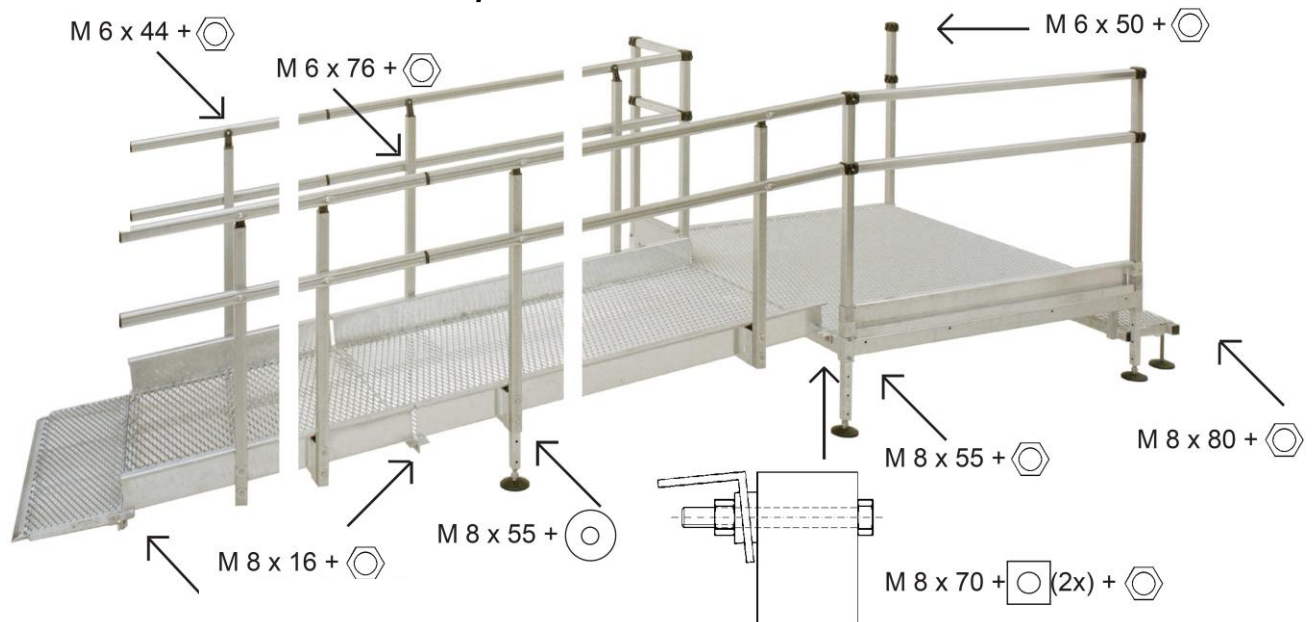

#### Alternative for handrails

The handrails can be placed in different ways. The pictures show handrail option A.

1. For maximum space and ergonomics both handrails are placed on the outside of the stanchions. **This is our recommended standard.** The handrails will be in line with the handrails of the platforms.
2. The lower handrail can be placed on the inside of the stanchions this may help a wheelchair user.





## Installation

This installation manual is for swift ramp system of width 1,3 meter.

Joining two modules (a ramp with another ramp or platform) should be done with 4 pcs of M8 screw (stainless steel).

### Ramps and platforms for high mounting (type H)

Ramps and platforms that are to be mounted up to 1,4 meter have longer stanchions. Please note that this changes the way of mounting instructed in step 3 (page 5) and steps 2 and 3 (page 3).

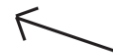

M 8 x 55 +  resp 



M 8 x 45 + 

# Platform Installation

To connect to an existing step use one of the connections modules. **Note that the platform always has to be connected/anchored to the existing building.** Picture A.

The big platforms, 1,5 x 1,5 m and 1,5 x 1,9 m, can be put over an existing step even if the door comes very close to the step surface. The distance has to be minimum 22 mm. If needed, the pipes under the platform can be removed.

Picture B.

If platform type H (max height 1,4 m) should be installed see Page 2 (step 2 and 3)

## Installation stages

1. Before the supporting legs are mounted to the platform put the threaded pins (M16) in place.
2. Mount the supporting legs into the corner pipes of the platform. Put the screws only in the bottom holes of the corner pipes.
3. Slide the four stanchions for the railings over the supporting legs. Put the second screw into the corner pipes of the platform. Note that you always should have two screws connecting the supporting legs with the corner pipes.
4. Adjust the height of the platform by turning the threaded pins (M16).
5. Depending on how much pressure the ground can take, it can be necessary to put concrete paving slabs or similar under the supporting legs.
6. Mounting of toe-plates/kerbs should be done clock-wise. Start by mounting the short piece of square pipe.
7. Slide the first toe-plate (length 1,1/1,5/1,9 m) over the stanchions.
8. Continue with the rest of the toe-plates (length 1,1/1,5/1,9 m).
9. Mount the last short square pipe.
10. If needed mount short toe-plate, 0,4 m, and its stanchion.
11. Slide the plastic railing couplings over the stanchions and mount with screws. Mounting of handrails and balustrade modules (type 3 and 4) should be done clock-wise with repeating steps 11, 12 and 13 for each side.
12. Mount the handrails.
13. Connect the upper handrails and couplings with the locking-pins.
14. To connect the platform handrail to a to a ramp handrail the pin must be only inserted in the upper or lower hole because of the angle. To do this you must cut one side of the pin 5mm from the end (see pic 10 page 5)



Picture A



Picture B



Step 1



Step 2



Step 3 and 6

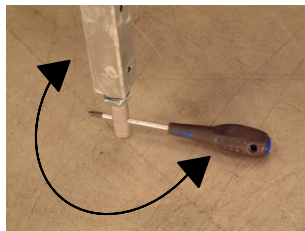

Step 4



Step 7



Step 7 and 8



Step 9

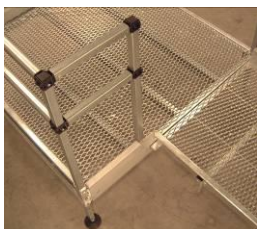

Step 10 -13



Step 11

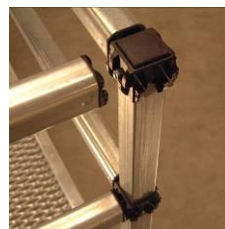

Step 12



Step 13



Step 13

# Low Mounting Platform Installation

## Note

Maximum height for mounting of this platform is 200 mm.

To connect to an existing step use one of the connections modules. **Note that the platform always has to be connected/anchored to the existing building.**

The big platforms, 1,5 x 1,5 m and 1,5 x 1,9 m, can be put over an existing step even if the door comes very close to the step surface. The distance has to be minimum 22 mm. If needed, the pipes under the platform can be removed.

## Installation steps (legs)

1. Press the plastic blocks with M16-nut into the pipes in the corners of the platform.
2. Put nuts on each threaded pin (M16).
3. Put the threaded pins into the plastic blocks.
4. Adjust the height of the platform by turning the threaded pins.
5. Tighten the nuts.
6. If necessary use the square washers and lock them with the nuts.

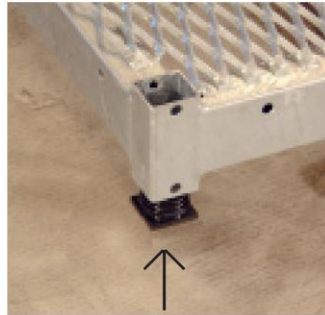

## Installation steps (toe-plates)

Toe-plates should be mounted to the 35x35-pipes. Mounting of toe-plates should be done **clock-wise**.

1. Connect the 35x35-pipes into the corners of the platform.
2. Slide the short piece of square pipe (40x40) over the 35x35-pipe.
3. Slide the first toe-plate (length 1,1/1,5/1,9 m) over the pipes.
4. Continue with the rest of the toeplates (length 1,1/1,5/1,9 m).
5. Mount the last short square pipe (40x40).
6. Lock the toe-plates by putting screws into the top holes of the 35x35-pipes.
7. If needed mount the short toe-plate (0,4 m).



## Top corner

If no toe-plate is connected to one of the corners you can fill the hole with the small piece of 35x35-pipe, by hanging it on a M8-screw.



# Ramp Installation

## Installation stages

1. Put the plastic end covers into the corners of the ramp.  
As an alternative begin with step 6 before step 2.
- 2 A. If connected to a platform see detail on page 1. Note how the special washers should be placed. If a short toe-plate (0,4 m) should be placed on the same side of the platform see picture on page 2.
- 2 B. If connected to an existing step use one of the connection modules. The smaller one can be used in two ways, see pictures. Note that the platform always has to be connected/anchored to the existing building. For alternative 1 you can use the special washers to adjust the inclination of the ramp.
- 2 C. If connected to another ramp module use the stainless steel screws.
3. If ramp modules are connected to each other there has to be supporting legs. Normally two legs are placed on the highest of two modules, before the actual connecting. The supporting legs should be slid inside the railings stanchions. For choosing the proper holes in the legs, see page Measurements 3 B. Note that you always should have two screws connecting the supporting legs to the brackets at the side of the ramp. For ramps with max height 1,4 m (type H) see Page 2 as well. There is special brackets that can be used if no railing is required.
4. Before the supporting legs are mounted to the ramp put the threaded pins (M16) in place.
5. It may be necessary to put concrete paving slabs or similar under the supporting legs.
6. Mount the railings stanchions, including supporting legs, into the ramp module. Do not tighten the nuts until you have mounted the handrails.
7. Adjust the height of the ramp by turning the threaded pins (M16).
8. Mount the handrails. (See page 1).
9. Connect the handrails with the locking-pins. Normally you only connect the upper handrails.
10. To connect the ramp handrail to a to a platform handrail the pin must be only inserted in the upper or lower hole because of the angle. To do this you must cut one side of the pin 5mm from the end (see pic 10)
11. Tighten all screws and nuts.



Step 1



Step 2 B, alt 1

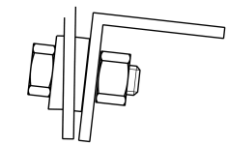

Step 2 B, alt 2

module to

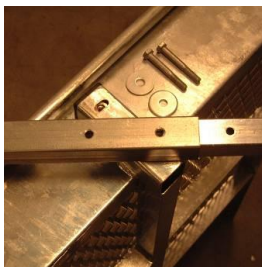

Step 5

12. Mount the connection  
the ground.



Step 7

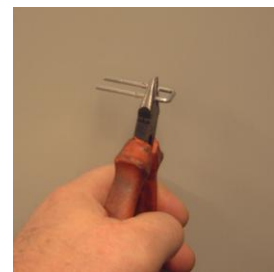
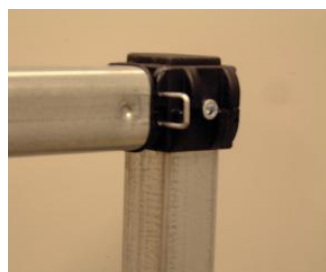
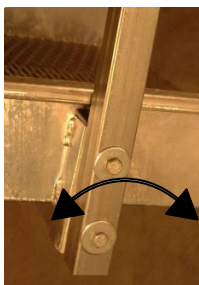
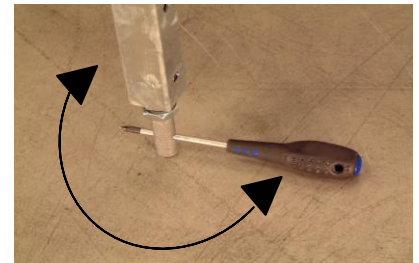

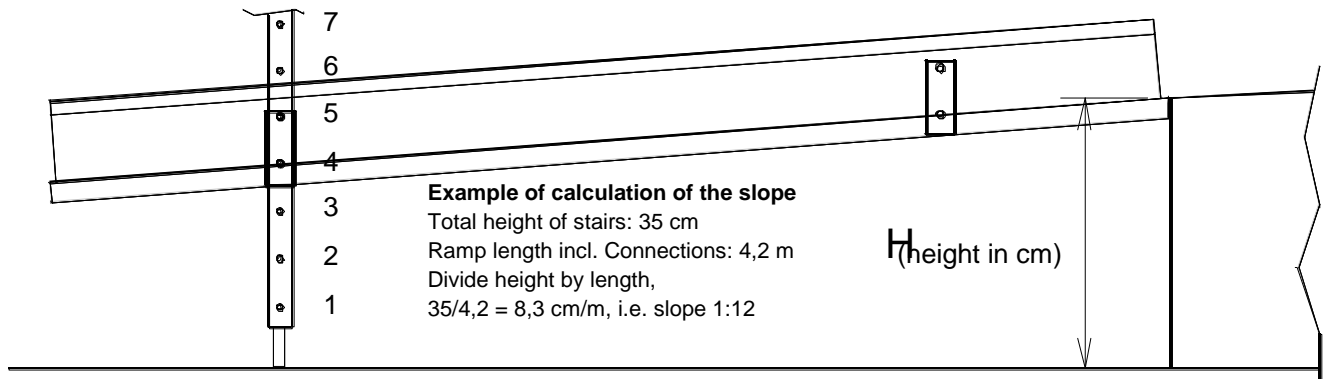

1. Measure the height (H) where the ramp is to be connected.
2. Do not forget to consider the slope of the ground if not flat.
3. Check the table below to see where the leg shall be placed on the module.

RAMP 1,35 m Hole	1:10		1:12		1:15		1:20		Slope					
	Height bracket		Height bracket		Height bracket		Height bracket		relation	angle	cm/m			
1 and 2	24		22		21		19		1:10	5.71	10.0			
2 and 3	24	31	22	29	21	28	19	26	1:12	4.76	8.3			
3 and 4	31	38	29	36	28	35	26	33	1:15	3.80	6.7			
4 and 5	38	45	36	43	35	42	33	40	1:20	2.86	5.0			
5 and 6	45	52	43	50	42	49	40	47	<b>Note</b> Normally 2 legs per module are mounted On the module closest to the ground no legs mounted.					
6 and 7	52	59	50	57	49	56	47	54						
7 and 8	59	66	57	64	56	63	54	61						
8 and 9	66	73	64	71	63	70	61	68						
9 and 10	73	80	71	78	70	77	68	75						
10 and 11	80	87	78	85	77	84	75	82						
11 and 12	87	94	85	92	84	91	82	89						
<b>Height difference</b> At a slope of 1:12  the height difference is as follows: Ramp 1,35 m, 11 cm Ramp 1,9 m, 16 cm Ramp 2,3 m, 19 cm														
RAMP 1,9 m Hole	1:10		1:12		1:15		1:20					<b>Height difference</b> At a slope of 1:15 the height difference is as follows: Ramp 1,35 m, 9 cm Ramp 1,9 m, 13 cm Ramp 2,3 m, 15 cm		
1 and 2	30		27		25		22							
2 and 3	30	37	27	34	25	32	22	29						
3 and 4	37	44	34	41	32	39	29	36						
4 and 5	44	51	41	48	39	46	36	43						
5 and 6	51	58	48	55	46	53	43	50						
6 and 7	58	65	55	62	53	60	50	57						
7 and 8	65	72	62	69	60	67	57	64						
8 and 9	72	79	69	76	67	74	64	71						
9 and 10	79	86	76	83	74	81	71	78						
10 and 11	86	93	83	90	81	88	78	85						
11 and 12	93	100	90	97	88	95	85	92						
RAMP 2,3 m Hole	1:10		1:12		1:15		1:20		<b>Height difference</b> At a slope of 1:20  the height difference is as follows: Ramp 1,35 m, 7 cm Ramp 1,9 m, 10 cm Ramp 2,3 m, 12 cm					
1 and 2	34		31		27		24							
2 and 3	34	41	31	38	27	34	24	31						
3 and 4	41	48	38	45	34	41	31	38						
4 and 5	48	55	45	52	41	48	38	45						
5 and 6	55	62	52	59	48	55	45	52						
6 and 7	62	69	59	66	55	62	52	59						
7 and 8	69	76	66	73	62	69	59	66						
8 and 9	76	83	73	80	69	76	66	73						
9 and 10	83	90	80	87	76	83	73	80						
10 and 11	90	97	87	94	83	90	80	87						
11 and 12	97	104	94	101	90	97	87	94						
<b>Example</b> H = 50 cm Ramp 2,3 m Slope = 1:12 Use hole 4 and 5														

## Options

### ***Installation of legs (if no railing)***

#### **Alternative 1** (recommended main alternative)

Leg, telescopic, (831910) and Mounting-kit for leg (831917). Cut the leg if needed.

If a ramp has a railing on the opposite side, this alternative should be used.

#### **Alternative 2**

Leg, angled, (831975) and Tubular mounting-kit for two angled legs (831978/831979).

#### ***Using "Alternative 2" at step connection***

"Alternative 2" (Leg, angled, (831975) and Tubular mounting-kit for two angled legs (831978/831979)) can be used as a support to Connection module to step (the picture shows artnr 838265), if not enough support is at the step/door-side.

Note that there has be legs at the ramps top end.

#### ***Installation of U-shaped railing end***

Note that the U-shape is not symmetric. The longest end should be mounted at the top handrail.

1. Connect the U-shape to the handrails with the brass pins.
2. Put in the locking-pins, four pieces per U-shape.





**Step Kits**

Start at the top. Note that the treads should be mounted on the inside of the upper tube.

Supporting leg-kit should be mounted on the lowest tread if there is no handrail. If there is a handrail the leg should be placed inside the handrail upright. Start by removing the plastic cap.

Closed riser should be mounted if needed.

For stairs with five or more steps only handrail option B should be used.

**Handrails for steps**

1. Remove the plastic cap from the outer tube of the lowest tread.
2. Mount the bracket (note orientation) together with the stanchion and leg.
3. Mount the top bracket between the plastic couplings.
4. If railing includes D-shaped end, mount it in the end of the handrail.
5. Mount the handrails.
6. Mount the plastic cups in the end of the handrails.
7. If handrail is option B, mount the upright bars.

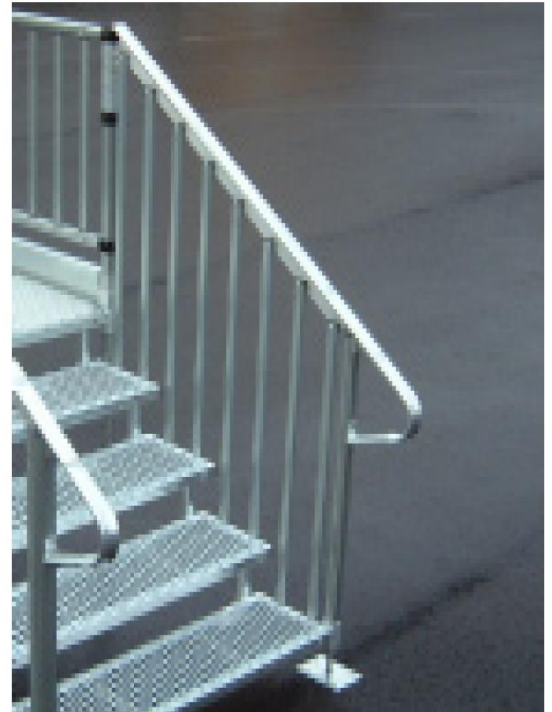

Handrail option B with D-shaped end



Handrail option A without D-shaped end

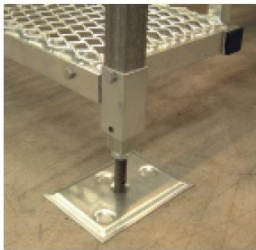

Step 1 - 4



Step 5 and 7



Step 6



Step 7 (w/o U-bend) Step 7



**Gate**

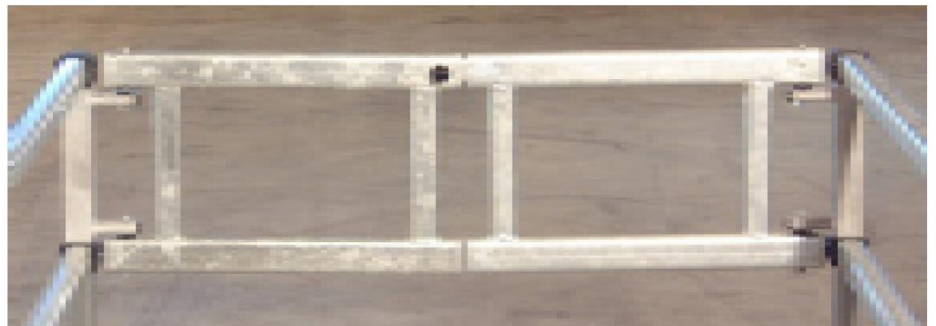

The hinges should be mounted between the plastic couplings at the handrail uprights on the platform.