

KITCHEN TOOLS
& UTENSILS

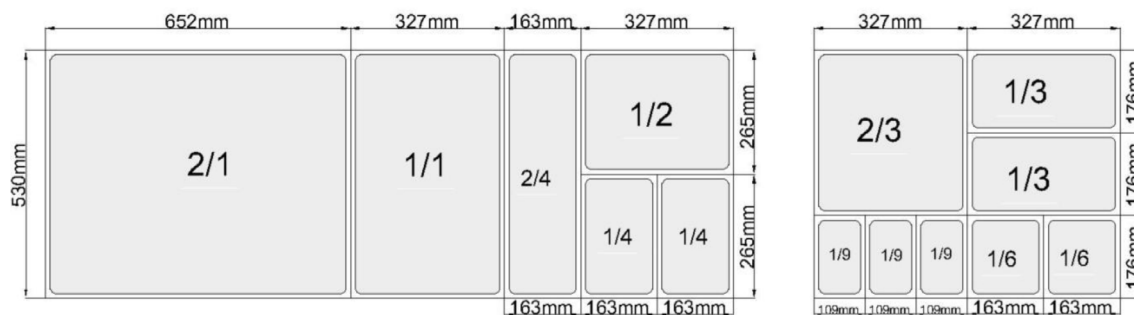



STAINLESS STEEL GASTRONORM PANS - EUROPEAN STYLE

SAFICO Gastronorm Pans are constructed with 18/8 stainless steel to EN 361 Standard and meets all professional needs. Double-reinforced corners and edges reduce distortion and prevent the pans from jamming together during storage. Sits firmly over steam table wells to minimise heat loss. NSF Listed.



SAFICO Stainless Steel GN Pan

Size / Depth	2cm / 0.07cm	4cm / 0.07cm	6.5cm / 0.07cm	10cm / 0.07cm	15cm / 0.07cm	20cm / 0.07cm
GN 1/1	02-001-00235	02-001-00236	02-001-00237	02-001-00238	02-001-00239	02-001-00240
GN 1/2	02-001-00241	02-001-00242	02-001-00243	02-001-00244	02-001-00245	02-001-00246
GN 1/3	02-001-00247	02-001-00248	02-001-00249	02-001-00250	02-001-00251	02-001-00252
GN 1/4			02-001-00253	02-001-00254	02-001-00255	02-001-00256
GN 1/6			02-001-00257	02-001-00258	02-001-00259	02-001-00260
GN 1/9			02-001-00261	02-001-00262		
GN 2/1	02-001-00263	02-001-00264	02-001-00265	02-001-00266	02-001-00267	02-001-00563
GN 2/3	02-001-00279	02-001-00280	02-001-00281	02-001-00282	02-001-00283	02-001-00284
GN 2/4	02-001-00285		02-001-00286	02-001-00287	02-001-00288	



SAFICO PERFORATED Stainless Steel GN Pan

Size / Depth	2cm / 0.07cm	4cm / 0.07cm	6.5cm / 0.07cm	10cm / 0.07cm	15cm / 0.07cm	20cm / 0.07cm
GN 1/1	02-001-00268	02-001-00269	02-001-00270	02-001-00271	02-001-00272	
GN 1/2		02-001-00274	02-001-00275	02-001-00276	02-001-00277	02-001-00273
GN 2/1			02-001-00278			



SAFICO Stainless Steel Non-Stick GN Pan

Size / Depth	2cm	4cm	6.5cm
GN 1/1	02-001-00289	02-001-00290	02-001-00291
GN 1/2	02-001-00292	02-001-00293	02-001-00294
GN 1/3			02-001-00295
GN 2/3			02-001-00296

SAFICO Stainless Steel False Bottom / Drain Shelf

Product Code	Size
02-001-00312	For Size 1/1
02-001-00313	For Size 1/2
02-001-00314	For Size 1/3



SAFICO Stainless Steel Slotted Lid

Product Code	For GN Pan	Thickness
02-001-00297	1/1	0.07cm
02-001-00298	1/2	0.07cm
02-001-00299	1/3	0.07cm
02-001-00300	1/4	0.07cm
02-001-00301	1/6	0.07cm
02-001-00302	1/9	0.07cm
02-001-00303	2/3	0.07cm

SAFICO Stainless Steel Solid Lid

Product Code	For GN Pan	Thickness
02-001-00304	1/1	0.07cm
02-001-00305	1/2	0.07cm
02-001-00306	1/3	0.07cm
02-001-00307	1/4	0.07cm
02-001-00308	1/6	0.07cm
02-001-00309	1/9	0.07cm
02-001-00310	2/3	0.07cm
02-001-00311	2/4	0.07cm



STEELCRAFT BY SAFICO Stainless Steel GN Pan

Size / Depth	2cm / 0.06cm	4cm / 0.06cm	6.5cm / 0.06cm	10cm / 0.06cm	15cm / 0.07cm	20cm / 0.07cm
GN 1/1	02-001-00315	02-001-00316	02-001-00317	02-001-00318	02-001-00319	02-001-00320
GN 1/2	02-001-00327	02-001-00328	02-001-00329	02-001-00330	02-001-00331	02-001-00332
GN 1/3	02-001-00339	02-001-00340	02-001-00341	02-001-00342	02-001-00343	02-001-00344
GN 1/4	02-001-00345		02-001-00346	02-001-00347	02-001-00348	02-001-00349
GN 1/6			02-001-00350	02-001-00351	02-001-00352	02-001-00353
GN 1/9			02-001-00354	02-001-00355	02-001-00356	
GN 2/1	02-001-00357					
GN 2/3	02-001-00358	02-001-00359	02-001-00360	02-001-00361	02-001-00362	02-001-00363
GN 2/4				02-001-00364	02-001-00365	



STEELCRAFT BY SAFICO PERFORATED Stainless Steel GN Pan

Size / Depth	2cm / 0.06cm	4cm / 0.06cm	6.5cm / 0.06cm	10cm / 0.06cm	15cm / 0.07cm	20cm / 0.07cm
GN 1/1	02-001-00321	02-001-00322	02-001-00323	02-001-00324	02-001-00325	02-001-00326
GN 1/2	02-001-00333	02-001-00334	02-001-00335	02-001-00336	02-001-00337	02-001-00338



STEELCRAFT BY SAFICO Stainless Steel Food Pan

Size / Depth	6.5cm / 0.06cm	10cm / 0.06cm	15cm / 0.06cm	20cm / 0.06cm
GN 1/1	02-001-00416	02-001-00417	02-001-00418	02-001-00419
GN 1/2	02-001-00420	02-001-00421	02-001-00422	
GN 1/3	02-001-00423	02-001-00424	02-001-00425	
GN 1/4	02-001-00426	02-001-00427	02-001-00428	
GN 1/6	02-001-00429	02-001-00430	02-001-00431	
GN 1/9	02-001-00433	02-001-00432		



STEELCRAFT BY SAFICO Stainless Steel Solid Cover for Food Pan

Product Code	For GN Pan	Thickness
02-001-00434	Size 1/1	0.06cm
02-001-00435	Size 1/2	0.06cm
02-001-00436	Size 1/3	0.06cm
02-001-00437	Size 1/4	0.06cm
02-001-00438	Size 1/6	0.06cm
02-001-00439	Size 1/9	0.06cm



STEELCRAFT BY SAFICO Stainless Steel Solid Cover*

Product Code	For GN Pan	Thickness
02-001-00366	Size 1/1	0.07cm
02-001-00367	Size 1/2	0.07cm
02-001-00368	Size 1/3	0.07cm
02-001-00369	Size 1/4	0.07cm
02-001-00370	Size 1/6	0.07cm
02-001-00371	Size 1/9	0.07cm
02-001-00372	Size 2/3	0.07cm
02-001-00373	Size 2/1	0.09cm
02-001-00374	Size 2/4	0.07cm

*This series may be used on SAFICO and STEELCRAFT by SAFICO pans



Stainless Steel 3-Compartment Pan Organizer for GN 1/6 Pans

Product Code	Height
02-001-00452	15cm



STEELCRAFT BY SAFICO Stainless Steel Divided Food Pan

Product Code	Size	Height
02-001-00415	For Size 1/1	6.5cm



CCK Stainless Steel Holder for 1/6 Size Pan

Height	4"	6"
1/6	02-001-00445	02-001-00444
2 x 1/6	02-001-00447	02-001-00446
3 x 1/6	02-001-00449	02-001-00448



CAMBRO AMBER H-Pan (Temperature tolerance -40°C to 190°C)

Size / Depth	2.5"	4"	6"
GN 1/1	02-001-00008	02-001-00009	02-001-00010
GN 1/2	02-001-00011	02-001-00012	02-001-00013
GN 1/3	02-001-00014	02-001-00015	02-001-00016
GN 1/6	02-001-00020	02-001-00021	02-001-00022
GN 1/9	02-001-00023	02-001-00024	



SAFICO Stainless Steel Adaptor Bar

Product Code	Dimension	Size
02-001-00450	20.5"	For Size 1/1
02-001-00451	12.75"	For Size 1/2

CAMBRO AMBER Heat-Resistant Plastic GN H-Pan Lid

Size	Flat Lid	Flip Lid	Flat Lid w/ Handle	Notched Lid w/ Handle	Notched Flip Lid
GN 1/1	02-001-00460		02-001-00467(XX)	02-001-00472(XX)	
GN 1/2	02-001-00461	02-001-00034(XX)	02-001-00468	02-001-00473(XX)	02-001-00048(XX)
GN 1/3	02-001-00463(XX)	02-001-00035(XX)	02-001-00469	02-001-00474	02-001-00047(XX)
GN 1/4	02-001-00464(XX)		02-001-00470	02-001-00475(XX)	
GN 1/6	02-001-00465	02-001-00036(XX)	02-001-00471	02-001-00476	02-001-00049(XX)
GN 1/9	02-001-00466(XX)				

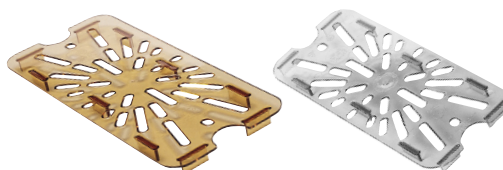
**CAMBRO Drain Shelf for GN Pan**

Size	Amber	Clear (Plastic)	Translucent (Polypropylene)
GN 1/1	02-001-00001(XX)	02-001-00069	02-001-00489
GN 1/2	02-001-00002(XX)	02-001-00070	02-001-00490
GN 1/3	02-001-00003	02-001-00071	02-001-00491
GN 1/4	02-001-00004(XX)	02-001-00072	02-001-00492(XX)
GN 1/6	02-001-00005	02-001-00073	02-001-00493
GN 1/9	02-001-00006(XX)	02-001-00074	

Camwear Drain Shelves ensure that food and condiments stay fresh longer by keeping liquids separate from food. The finger notch allows you to place it in the bottom of your existing Camwear Food Pan to keep food product elevated and out of juices preserving freshness and food quality. CW Drain Shelves withstand temperatures from -40°C to 99°C.

Polypropylene Drain Shelves ensure that food and condiments stay fresh longer by keeping liquids separate from food. The finger notch allows you to place it in the bottom of your existing Translucent Food Pan to keep food product elevated and out of juices preserving freshness and food quality. Polypropylene Drain Shelves withstand temperatures from -40°C to 70°C.

**CAMBRO BLACK Polycarbonate GN Pan**

Size / Depth	6.5cm	10cm	15cm	20cm
GN 1/1	02-001-00050	02-001-00051	02-001-00052	
GN 1/2	02-001-00053	02-001-00054	02-001-00055	
GN 1/3	02-001-00056	02-001-00057	02-001-00058	02-001-00059
GN 1/4	02-001-00060	02-001-00061	02-001-00062	
GN 1/6	02-001-00063	02-001-00064	02-001-00065	
GN 1/9	02-001-00066	02-001-00067		

**CAMBRO WHITE Polycarbonate GN Pan**

Size / Depth	6.5cm	10cm	15cm
GN 1/1	02-001-00166	02-001-00164	02-001-00165
GN 1/2	02-001-00167	02-001-00168	02-001-00169(XX)
GN 1/3	02-001-00170	02-001-00171	02-001-00172
GN 1/4		02-001-00173(XX)	
GN 1/6	02-001-00174		02-001-00175
GN 1/9	02-001-00176(XX)		



PADERNO Plastic GN Pan / Grid / Lid

Size	Plastic GN Pan (Height: 20cm)	Grid	Lid
GN 2/1	02-001-00413(XX)	02-001-00441(XX)	02-001-00414(XX)



CAMBRO TRANSLUCENT Polypropylene Food Pan / GN Lids

Size / Depth	Food Pan Height: 10cm	Food Pan Height: 15cm	Flat Lid w/ Handle	Notched Lid w/ Handle	Flat Lid
GN 1/1	02-001-00477	02-001-00478(XX)	02-001-00507		
GN 1/2	02-001-00479	02-001-00480	02-001-00508		
GN 1/3	02-001-00481	02-001-00482	02-001-00509	02-001-00512(XX)	
GN 1/4	02-001-00483	02-001-00484	02-001-00510		
GN 1/6	02-001-00485	02-001-00486	02-001-00511	02-001-00513(XX)	
GN 1/9	02-001-00487				02-001-00506(XX)



CAMBRO CLEAR Polycarbonate Food Pan

Size / Depth	6.5cm	10cm	15cm	20cm
GN 1/1	02-001-00669	02-001-00670	02-001-00671	02-001-00672
GN 1/2	02-001-00673	02-001-00674	02-001-00675	02-001-00668
GN 1/3	02-001-00676	02-001-00677	02-001-00678	02-001-00679
GN 1/4		02-001-00680	02-001-00681	
GN 1/6	02-001-00682	02-001-00683	02-001-00684	
GN 1/9	02-001-00685	02-001-00686		
GN 2/4	02-001-00516			

CAMBRO CLEAR Polycarbonate Plastic GN Lid



Size / Depth	Flat Lid	Flat Lid w/ Handle	Notched Lid w/ Handle	Notched Flip Lid	Flip Lid	Grip Lid
GN 1/1	02-001-00077	02-001-00084	02-001-00092			02-001-00127
GN 1/2	02-001-00078	02-001-00085	02-001-00093	02-001-00089	02-001-00124	02-001-00128
GN 1/3	02-001-00079	02-001-00086	02-001-00094	02-001-00090	02-001-00125	02-001-00129
GN 1/4	02-001-00080	02-001-00087	02-001-00095			
GN 1/6	02-001-00081	02-001-00088	02-001-00096	02-001-00091	02-001-00126	02-001-00130
GN 1/9	02-001-00082		02-001-00097(XX)			
GN 2/4	02-001-00488(XX)					

CAMBRO CLEAR Polycarbonate Food Pan Colander

Size / Depth	Height 3" (7.6cm)	Height 5" (12.7cm)
GN 1/2	02-001-00118	
GN 1/3	02-001-00121	02-001-00120(XX)
GN 1/6	02-001-00123	02-001-00122

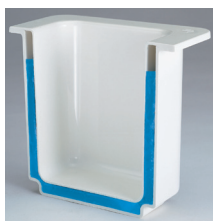

02-001-00185/186/187

02-001-00131/132/133

CAMBRO CLEAR Coldfest Insulated Pan / Plastic Flat Cover

Size / Depth	ABS GN Pan w/ Gel Core Height: 15cm	Flat Cover
GN 1/2	02-001-00185	02-001-00131(XX)
GN 1/3	02-001-00186	02-001-00132(XX)
GN 1/6	02-001-00187	02-001-00133(XX)

UNICA TRANSLUCENT Polypropylene GN Pan

Size / Depth	6.5cm	10cm	15cm	20cm
GN 1/1	02-001-00392	02-001-00393	02-001-00394	02-001-00395
GN 1/2	02-001-00396	02-001-00397	02-001-00398	02-001-00399
GN 1/3	02-001-00400	02-001-00401	02-001-00402	02-001-00403
GN 1/4	02-001-00404	02-001-00405	02-001-00406	
GN 1/6	02-001-00407	02-001-00408	02-001-00409	
GN 1/9	02-001-00410	02-001-00411		

UNICA TRANSLUCENT Polypropylene Drain Shelf / Lid

Size	Drain Shelf	Lid
GN 1/1	02-001-00381	02-001-00386
GN 1/2	02-001-00382	02-001-00387
GN 1/3	02-001-00383	02-001-00388
GN 1/4	02-001-00384	02-001-00389
GN 1/6	02-001-00385	02-001-00390
GN 1/9		02-001-00391

UNICA Colour Clip for GN Pans & Lids

Product Code	Colour
02-001-00518	Blue
02-001-00519	Green
02-001-00520	Gray
02-001-00521	Red
02-001-00522	White
02-001-00523	Yellow



JIWINS CLEAR Polycarbonate Food Pan

Size / Depth	6.5cm	10cm	15cm	20cm
GN 1/1	02-001-00193	02-001-00194	02-001-00195	02-001-00196
GN 1/2	02-001-00197	02-001-00198	02-001-00199	02-001-00200
GN 1/3	02-001-00201	02-001-00202	02-001-00203	02-001-00204
GN 1/4	02-001-00205	02-001-00206	02-001-00207	
GN 1/6	02-001-00208	02-001-00209	02-001-00210	
GN 1/9	02-001-00211	02-001-00212		
GN 2/1			02-001-00583	02-001-00584



JIWINS Polycarbonate Drain Shelf / Lids

Size / Depth	Plastic Drain Shelf for Food Pan	PE Seal Lid	Lid without Handle	Lid with Handle	Notched Lid with Handle
GN 1/1	02-001-00188	02-001-00229	02-001-00213	02-001-00219	02-001-00224
GN 1/2	02-001-00189	02-001-00230	02-001-00214	02-001-00220	02-001-00225
GN 1/3	02-001-00190	02-001-00231	02-001-00215	02-001-00221	02-001-00226
GN 1/4	02-001-00191	02-001-00232	02-001-00216	02-001-00222	02-001-00227
GN 1/6	02-001-00192	02-001-00233	02-001-00217	02-001-00223	02-001-00228
GN 1/9		02-001-00234	02-001-00218		
GN 2/1			02-001-00585		



Stainless Steel Perforated Pail / Bucket

Product Code	Dimension
02-002-00146	Ø27 x H25cm
02-002-00147	Ø32 x H30cm
02-002-00148	Ø37 x H35cm



CCK TAPED BODY Stainless Steel Water Pail / Bucket

Product Code	Dimension	Capacity
02-002-00149	Ø12 x H11"	14.0ℓ
02-002-00150	Ø13 x H11.2"	17.0ℓ
02-002-00151	Ø14 x H12"	23.0ℓ



CAMBRO PE Pail w/ Capacity Markings & Lid

Product Code	Capacity	Colour
02-002-00145	21ℓ - 22qt	<input type="checkbox"/> White



PIAZZA Stainless Steel Graduated Bucket with Bottom Ring / Lid

Dimension	Bucket/Lid	Capacity	Product Code
Ø27 x H24cm	Bucket	10.0ℓ	02-002-00153(XX)
	Lid		02-002-00155(XX)
Ø28 x H25.8cm	Bucket	12.0ℓ	02-002-00154
	Lid		02-002-00156(XX)



Stainless Steel Japanese Style Bucket / Pail with Base

Product Code	Dimension	Capacity
02-002-00157	Ø26.5 x H25.5cm	10.0ℓ
02-002-00158	Ø29.5 x H30cm	15.0ℓ



Stainless Steel Pail with Graduation

Product Code	Dimension	Capacity
02-002-00159(XX)	Ø30 x H12.6cm	13.0ℓ
02-002-00161(XX)	Ø22.5 x H20.5cm	5.5ℓ
02-002-00162(XX)	Ø29.5 x H25cm	12.0ℓ



Stainless Steel Fryer Container with Grill Net

Product Code	Dimension
02-002-00389	33 x 24cm



ZEBRA Stainless Steel Wash Basin

Product Code	Dimension	Capacity
02-002-00084	Ø36 x H11cm	7.0ℓ
02-002-00085	Ø40 x H12.5cm	10.0ℓ
02-002-00086	Ø50 x H14cm	16.0ℓ
02-002-00087	Ø55 x H15.5cm	24.0ℓ
02-002-00088	Ø60 x H17.5cm	32.0ℓ
02-002-00089	Ø70 x H19.5cm	48.0ℓ



Stainless Steel Wash Basin

Product Code	Dimension
02-002-00133	Ø12 x H5cm
02-002-00134	Ø14 x H5.5cm
02-002-00135	Ø16 x H6cm
02-002-00136	Ø18 x H6.5cm



Stainless Steel Oil Pot (Basin)

Product Code	Dimension
02-002-00256	9"
02-002-00257	10"
02-002-00258	11"

FOUR BRIGHT Aluminium Utility Basin

Product Code	Dimension
02-002-00015	Ø20 x H10.5cm
02-002-00016	Ø22 x H12cm
02-002-00017	Ø24 x H13cm
02-002-00018	Ø26 x H14cm
02-002-00019	Ø28 x H14.5cm
02-002-00020	Ø30 x H15.2cm
02-002-00021	Ø32 x H16cm



Stainless Steel Oil Pot Local Style

Product Code	Dimension
02-002-00259	22cm
02-002-00260	24cm
02-002-00261	26cm



02-002-00223



02-002-00226

CCK Stainless Steel Oil Pot

Product Code	Dimension	Capacity	Type
02-002-00223	Ø8 x H7.8"	5.7ℓ	Local
02-002-00224	Ø8.6 x H6.5"	6.0ℓ	Local
02-002-00225	Ø8 x H5.8"	5.0ℓ	Basin
02-002-00226	Ø9 x H5.8"	6.0ℓ	Basin
02-002-00227	Ø10 x H16"	7.5ℓ	Basin
02-002-00228	Ø11 x H6.5"	9.5ℓ	Basin



LACOR Stainless Steel Semi-Spherical Mixing Bowl

Product Code	Dimension	Capacity
02-002-00034(XX)	Ø22 x H11cm	2.7ℓ
02-002-00035(XX)	Ø26 x H13cm	4.0ℓ



Stainless Steel Tapered Mixing Bowl (Beaded Edge)

Product Code	Dimension
02-002-00137	Ø16 x H8cm
02-002-00138	Ø20 x H9.5cm
02-002-00139	Ø24 x H10.5cm
02-002-00140	Ø28 x H12.5cm
02-002-00141	Ø32 x H13.5cm
02-002-00142	Ø36 x H15.5cm
02-002-00143	Ø40 x H18cm



CCK Stainless Steel Mixing Bowl

Product Code	Dimension	Capacity
02-002-00001	Ø20 x H8cm	1.75ℓ
02-002-00002	Ø26 x H11cm	3.9ℓ
02-002-00003	Ø28 x H11cm	4.8ℓ
02-002-00004	Ø30 x H12cm	5.6ℓ
02-002-00005	Ø32 x H13cm	7.0ℓ
02-002-00006	Ø34 x H14cm	8.0ℓ
02-002-00007	Ø36 x H15cm	10.5ℓ
02-002-00008	Ø43 x H14cm	14.0ℓ
02-002-00009	Ø45 x H15cm	18.0ℓ
02-002-00010	Ø52 x H16cm	22.0ℓ
02-002-00011	Ø58 x H17cm	30.0ℓ
02-002-00012	Ø61 x H18cm	38.0ℓ
02-002-00013	Ø65 x H19cm	44.5ℓ
02-002-00014	Ø70 x H20cm	54.0ℓ



Stainless Steel Mixing Bowl, Economy

Product Code	Dimension	Capacity
02-002-00109	Ø14 x H6.8cm	0.52ℓ
02-002-00110	Ø17.2 x H7.2cm	1.1ℓ
02-002-00111	Ø19.2 x H8.3cm	1.45ℓ
02-002-00112	Ø21.5 x H8.4cm	1.7ℓ
02-002-00113	Ø23.5 x H8.6cm	2.15ℓ
02-002-00114	Ø16.5 x H6cm	0.7ℓ
02-002-00115	Ø20 x H6.5cm	1.4ℓ
02-002-00116	Ø23 x H7cm	1.9ℓ
02-002-00117	Ø25.5 x H8cm	2.85ℓ
02-002-00118	Ø27 x H8.5cm	3.8ℓ
02-002-00119	Ø29.5 x H9.5cm	4.75ℓ
02-002-00120	Ø33.5 x H10cm	7.6ℓ
02-002-00121	Ø36 x H11.5cm	9.5ℓ
02-002-00122	Ø41 x H12cm	12.5ℓ
02-002-00123	Ø45 x H14cm	15.5ℓ
02-002-00124	Ø48 x H15cm	19.0ℓ
02-002-00125	Ø26 x H9.5cm	2.65ℓ
02-002-00126	Ø28 x H10cm	3.6ℓ
02-002-00127	Ø30 x H11cm	4.5ℓ
02-002-00128	Ø32 x H11cm	5.5ℓ
02-002-00129	Ø34 x H11cm	7.0ℓ
02-002-00130	Ø36 x H12cm	8.3ℓ



ZEBRA Stainless Steel Mixing Bowl

Product Code	Dimension	Capacity
02-002-00071	Ø15 x H6.5cm	0.7ℓ
02-002-00072	Ø18 x H7.5cm	1.2ℓ
02-002-00073	Ø21 x H8.5cm	2.0ℓ
02-002-00074	Ø24 x H9.5cm	3.2ℓ
02-002-00075	Ø27 x H11cm	4.2ℓ
02-002-00076	Ø30 x H12cm	5.8ℓ
02-002-00077	Ø33 x H13cm	7.7ℓ
02-002-00078	Ø36 x H14cm	10.3ℓ
02-002-00079	Ø40 x H16cm	14.5ℓ
02-002-00080	Ø45 x H17.5cm	19.6ℓ
02-002-00081	Ø50 x H19.5cm	24.0ℓ



Stainless Steel Mixing Bowl, Japan

Product Code	Dimension	Capacity
02-002-00091	Ø15 x H6.5cm	0.85ℓ
02-002-00092	Ø18 x H7.5cm	1.83ℓ
02-002-00093	Ø21 x H8.5cm	2.2ℓ
02-002-00094	Ø24 x H9.5cm	3.2ℓ
02-002-00095	Ø27 x H10.5cm	4.55ℓ
02-002-00096	Ø30 x H11.5cm	6.3ℓ
02-002-00097	Ø33 x H12.5cm	8.2ℓ
02-002-00098	Ø36 x H13.5cm	10.5ℓ
02-002-00099	Ø39 x H14.5cm	12.6ℓ
02-002-00100	Ø42 x H15.5cm	16.2ℓ
02-002-00101	Ø45 x H16.5cm	20.5ℓ
02-002-00102	Ø50 x H18.5cm	25.0ℓ
02-002-00103	Ø55 x H20.5cm	35.0ℓ
02-002-00104	Ø60 x H22.5cm	45.0ℓ



LACOR 18-10 Stainless Steel Spherical Mixing Bowl with Handles

Product Code	Dimension	Capacity
02-002-00023	Ø22 x H11cm	2.7ℓ
02-002-00024	Ø26 x H13cm	4.0ℓ
02-002-00025	Ø32 x H17cm	9.5ℓ
02-002-00026	Ø36 x H18cm	12.0ℓ
02-002-00027	Ø40 x H21cm	14.5ℓ



LACOR 18-10 Stainless Steel Conical Mixing Bowl with Handles

Product Code	Dimension	Capacity
02-002-00028	Ø28 x H13.2cm	5.0ℓ
02-002-00029	Ø32 x H14.5cm	7.0ℓ
02-002-00030	Ø36 x H16cm	11.0ℓ
02-002-00031	Ø40 x H18cm	15.0ℓ
02-002-00032	Ø45 x H20cm	22.0ℓ
02-002-00033	Ø50 x H22cm	30.0ℓ



LACOR 18/10 Stainless Steel Mixing Bowl Stand

Product Code	Dimension
02-002-00022	Ø20cm



SCHNEIDER Plastic Microwaveable Mixing Bowl

Product Code	Dimension	Capacity
02-002-00063	Ø19 x 7.9cm	1.0ℓ
02-002-00064	Ø24 x 11.5cm	2.5ℓ
02-002-00065	Ø28 x 13.5cm	4.5ℓ
02-002-00066	Ø32.5 x 14.7cm	6.0ℓ
02-002-00067	Ø36 x 16.5cm	9.0ℓ
02-002-00068	Ø40 x 18.5cm	13.0ℓ



SAFICO 18/10 Stainless Steel Conical Mixing Bowl

Product Code	Dimension
02-002-00051	Ø20 x H10cm
02-002-00052	Ø24 x H11.2cm
02-002-00053	Ø28 x H11.9cm
02-002-00054	Ø32 x H14cm
02-002-00055	Ø36 x H15cm
02-002-00056	Ø40 x H17cm



MARINEX Glass Bowl without Lid

Product Code	Dimension	Capacity
02-002-00039	Ø21 x H9cm	1.5ℓ
02-002-00040	Ø27 x H10.3cm	3.0ℓ
02-002-00041	Ø29 x H10.5cm	4.0ℓ



MAUVIEL M'PASSION Copper Eggwhite Beating Bowl with Handle

Product Code	Dimension	Capacity
02-002-00042(XX)	Ø26 x H13cm	4.6ℓ
02-002-00043	Ø30 x H15cm	7.0ℓ
02-002-00044(XX)	Ø35 x H18cm	12.0ℓ
02-002-00045	Ø40 x H20cm	16.7ℓ



MAUVIEL M'PASSION Copper Eggwhite Beating Bowl with Ring

Product Code	Dimension	Capacity
02-002-00046	Ø26 x H13cm	4.6ℓ
02-002-00047	Ø30 x H15cm	7.0ℓ
02-002-00048	Ø35 x H18cm	12.0ℓ
02-002-00049	Ø40 x H20cm	16.7ℓ



MAUVIEL M'PASSION Stainless Steel Support for Beating Bowl

Product Code	Dimension
02-002-00050(XX)	48 x 35.5 x 17.5cm



Stainless Steel Utility Bowl

Product Code	Dimension
02-002-00131	Ø12 x H6.5cm
02-002-00132	Ø14 x H7.5cm



ZEBRA Stainless Steel Bowl

Product Code	Dimension	Capacity
02-002-00234	9cm	9.5ℓ
02-002-00235	10cm	12.0ℓ
02-002-00236	11cm	14.5ℓ



Stainless Steel Footed Bowl

Product Code	Dimension
02-002-00105	Ø14 x H8cm
02-002-00106	Ø16 x H8.5cm
02-002-00107	Ø18 x H10.5cm
02-002-00108	Ø20 x H11cm



CCK Stainless Steel Sauce / Condiment Bowl

Product Code	Dimension	Capacity
02-002-00218	Ø14 x H8cm	1.0ℓ
02-002-00219	Ø16 x H10.5cm	1.65ℓ
02-002-00220	Ø18 x H11cm	2.4ℓ
02-002-00221	Ø20 x H12.5cm	3.5ℓ



Stainless Steel Sauce / Condiment Bowl

Product Code	Dimension
02-002-00252	12cm
02-002-00253	14cm
02-002-00254	16cm
02-002-00255	18cm



ZEBRA Stainless Steel Water Bowl

Product Code	Dimension
02-002-00248	12cm
02-002-00249	14cm
02-002-00250	16cm
02-002-00251	18cm



Stainless Steel Steaming Bowl

Product Code	Dimension
02-002-00280	Ø11 x H7.5cm



CCK Stainless Steel Chicken Steaming Bowl

Product Code	Dimension	Capacity
02-002-00222	Ø12.5 x H10cm	0.6ℓ



ZEBRA Stainless Steel Colour Bowl

Dimension	Blue	Green	Pink	Yellow
Ø11cm	02-002-00237	02-002-00238	02-002-00239	02-002-00240
Ø15cm	02-002-00241	02-002-00242	02-002-00243	02-002-00244



Stainless Steel Mar Bowl with Holes

Product Code	Dimension
02-002-00263	16cm
02-002-00264	18cm
02-002-00265	20cm



Stainless Steel Round Mar Bowl

Product Code	Dimension
02-002-01098	Ø10cm
02-002-00272	Ø12cm
02-002-00273	Ø14cm
02-002-00274	Ø16cm
02-002-00275	Ø18cm
02-002-00276	Ø20cm
02-002-00277	Ø22cm
02-002-00278	Ø24cm
02-002-00279	Ø26cm



LACOR 18-10 Stainless Steel Spherical Footer Colander with Handles

Product Code	Dimension	Capacity
02-002-00343	Ø32 x H18cm	9.5ℓ
02-002-00344	Ø36 x H19cm	12.0ℓ
02-002-00345	Ø40 x H21cm	14.5ℓ



Stainless Steel Colander

Product Code	Dimension
02-002-00398	Ø8 x H4cm
02-002-00399	Ø11 x H5cm
02-002-00400	Ø14 x H5.5cm
02-002-00401	Ø17 x H6.5cm
02-002-00402	Ø20 x H7.5cm
02-002-00403	Ø23 x H8.5cm
02-002-00404	Ø26 x H9.5cm
02-002-00405	Ø29 x H11cm



Stainless Steel Mar Bowl

Product Code	Dimension
02-002-00266	Ø12cm
02-002-00267	Ø14cm
02-002-00268	Ø16cm
02-002-00269	Ø18cm
02-002-00270	Ø20cm
02-002-00271	Ø22cm



CCK Stainless Steel Ingredient Dish Footed

Product Code	Dimension
02-002-00215	Ø12"
02-002-00216	Ø13"
02-002-00217	Ø14"



Aluminium Colander with Handle & Base

Product Code	Dimension	Capacity
02-002-00380	Ø39 x H19cm	11qt
02-002-00381	Ø42 x H24cm	16qt



LACOR Stainless Steel Rectangle French Fry Colander

Product Code	Dimension
02-002-00352(XX)	50 x 39 x 8cm



LACOR 18-10 Stainless Steel Conical Colander with Stand

Product Code	Dimension	Capacity
02-002-00346	Ø28 x H17cm	13.2ℓ
02-002-00347	Ø32 x H20cm	14.5ℓ
02-002-00348	Ø36 x H23cm	16.0ℓ
02-002-00349	Ø40 x H26cm	18.0ℓ
02-002-00350	Ø45 x H29cm	20.0ℓ
02-002-00351	Ø50 x H33cm	22.0ℓ



Stainless Steel Colander

Product Code	Dimension
02-002-01063	Ø18cm
02-002-01064	Ø20cm
02-002-01065	Ø22.5cm
02-002-01066	Ø25cm
02-002-01067	Ø27.5cm
02-002-01068	Ø30cm
02-002-01069	Ø33cm
02-002-00367	Ø36cm



Plastic Rectangle Deep Colander

Product Code	Dimension
02-002-00382	48 x 35.5 x 17.5cm



Plastic Round Colander

Product Code	Dimension
02-002-00383	Ø16.5 x H6cm
02-002-00384	Ø20 x H7.5cm
02-002-00385	Ø25 x H9cm



Plastic Round Colander

Product Code	Dimension
02-002-00325	Ø17.8 x H7cm
02-002-00326	Ø21.4 x H8.5cm
02-002-00323	Ø24.5 x H8.4cm
02-002-00327	Ø27 x H9.7cm
02-002-00324	Ø28.5 x H9cm
02-002-00328	Ø29.4 x H11.4cm
02-002-00330	Ø31 x H11.5cm
02-002-00329	Ø39 x H14.6cm
02-002-00331	Ø45 x H15cm
02-002-00332	Ø49.5 x H15cm



Plastic Round Colander

Product Code	Dimension
02-002-00386	Ø34 x H13.5cm
02-002-00387	Ø38 x H14.5cm



Plastic Round Colander

Product Code	Dimension
02-002-00388	Ø58 x H21.5cm



Plastic Rectangle Colander

Product Code	Dimension
02-002-00333	13.8 x 9.3 x 5cm
02-002-00334	15.2 x 15.2 x 5.8cm
02-002-00335	27.4 x 20.7 x 7.4cm
02-002-00336	29 x 23.8 x 7cm
02-002-00337	36 x 26.2 x 9.5cm
02-002-00338	40.2 x 31.3 x 11.2cm
02-002-00339	41.5 x 30 x 10.2cm
02-002-00340	46.9 x 33 x 10.7cm
02-002-00341	50 x 40 x 18.5cm



Plastic Rectangle Colander

Product Code	Dimension
02-002-00370	20 x 15 x 6cm
02-002-00371	22 x 17 x 7cm
02-002-00372	26 x 20 x 10cm
02-002-00373	28 x 23 x 7cm
02-002-00374	28 x 23 x 10cm
02-002-00375	30 x 26 x 13cm
02-002-00376	32 x 26 x 9cm
02-002-00377	33 x 28 x 13cm
02-002-00378	40 x 32 x 10cm
02-002-00379	45 x 36 x 13cm
02-002-00354	50 x 40 x 18cm



Bamboo Round Flat Colander

Product Code	Dimension
02-002-00368	Ø23cm



Bamboo Square Flat Colander

Product Code	Dimension
02-002-00369	22 x 22cm



Bamboo Round Bottom Colander

Product Code	Dimension
02-002-00390	Ø17"
02-002-00391	Ø19"
02-002-00392	Ø21"
02-002-00393	Ø24"



Stainless Steel Flavouring / Condiment Bowl with Lid

Product Code	Dimension
02-002-00296	Ø12cm
02-002-00297	Ø14cm
02-002-00298	Ø16cm
02-002-00299	Ø18cm
02-002-00300	Ø20cm



SAFICO Stainless Steel Round Food Storage Canister without Lid

Product Code	Dimension	Capacity
02-002-00230	Ø16 x H13.5cm	2.5ℓ
02-002-00231	Ø20 x H17cm	5.0ℓ
02-002-00232	Ø28 x H23.5cm	14.0ℓ
02-002-00233	Ø24 x H20cm	8.0ℓ



MAUVIEL M'COOK Stainless Steel Roasting Pan w/ Bronze Handles

Product Code	Dimension
01-001-00846	35 x 25 x 7cm
01-001-00847	40 x 30 x 8.5cm



PADERNO Stainless Steel Heavy-Duty Roast Pan with Lid

Product Code	Dimension
01-001-00906(XX)	61 x 43 x 15cm



LACOR 18-10 Stainless Steel Heavy Duty Roast Pan with Movable Handles

Product Code	Dimension
01-001-00977	40 x 30 x 8cm
01-001-00978	50 x 40 x 8cm
01-001-00979	60 x 45 x 8cm
01-001-00980	70 x 45 x 9.5cm



LACOR Stainless Steel Roast Pan with Movable Handles

Product Code	Dimension
01-001-00981	30 x 22 x 5cm
01-001-00983	35 x 26 x 5.3cm
01-001-00985	40 x 20 x 5.6cm
01-001-00987	45 x 32 x 7.5cm



LACOR Stainless Steel Roast Pan with Movable Handles

Product Code	Dimension
01-001-00982	30 x 22 x 7.5cm
01-001-00984	35 x 26 x 7.8cm
01-001-00986	40 x 28 x 8.5cm
01-001-00988	45 x 32 x 9cm



LACOR Aluminium Heavy Duty Roast Pan

Product Code	Dimension	Capacity
01-001-00989	40 x 30 x 6cm	7.45ℓ
01-001-00990	45 x 32 x 7cm	10.4ℓ
01-001-00991	50 x 35 x 8cm	12.6ℓ
01-001-00992	55 x 37 x 9cm	16.3ℓ
01-001-00993	60 x 40 x 9cm	19.0ℓ
01-001-00994	65 x 43 x 10cm	24.3ℓ
01-001-00995	70 x 45 x 10cm	28.7ℓ



SUNNEX Aluminium Bakewell Pan

Product Code	Dimension (L x B x H)	Capacity
01-001-00851	31.8 x 21.6 x 3.8cm	2.2ℓ
01-001-00852	36.8 x 26.7 x 3.8cm	3.1ℓ
01-001-00853	41.9 x 30.5 x 3.8cm	4.1ℓ
01-001-00854	47 x 35.6 x 3.8cm	5.0ℓ
01-001-00855	52.1 x 41.9 x 3.8cm	7.3ℓ
01-001-00856	61 x 45.7 x 3.8cm	8.6ℓ



SUNNEX Aluminium Roasting Deep Dish with Integrated Handles

Product Code	Dimension (L x B x H)
01-001-00858	47 x 35.6 x 10.2cm
01-001-00859	52.1 x 41.9 x 10.2cm
01-001-00860	61 x 45.7 x 10.2cm
01-001-00861	36.8 x 26.7 x 7cm
01-001-00862	41.9 x 30.5 x 7cm
01-001-00863	47 x 35.6 x 7cm
01-001-00864	52.1 x 41.9 x 7cm
01-001-00865	61 x 45.7 x 7cm

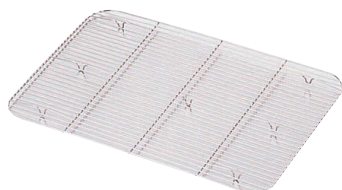

AG Stainless Steel (18/8) Wire Grid

Product Code	Dimension	No.
02-002-01088	42.8 x 27.7cm	No. 6
02-002-01089	36 x 24.2cm	No. 8
02-002-01090	30.7 x 22.1cm	No. 10
02-002-01091	28.5 x 21.5cm	No. 12



AG Stainless Steel (18/8) Rectangle Pan

Product Code	Dimension (L x B x H)	Size
02-002-01023	47.5 x 33.3 x 8.2cm	No. 6
02-002-01024	40.6 x 29.3 x 6.4cm	No. 8
02-002-01025	35.3 x 26.4 x 6.1cm	No. 10
02-002-01026	32.2 x 25.2 x 5.3cm	No. 12
02-002-01027	28.6 x 23.1 x 4.9cm	No. 15
02-002-01028	24.8 x 20.2 x 3.7cm	No. 21
02-002-01029	21 x 17 x 3.1cm	No. 30
02-002-01030	18.7 x 14.2 x 3cm	No. 36
02-002-01031	15.5 x 12.6 x 2.7cm	No. 40



AG Stainless Steel (18/8) Cake Tray

Product Code	Dimension (L x B x H)
02-002-01032	21.6 x 15.3 x 1.9cm
02-002-01033	28.4 x 20.2 x 1.9cm
02-002-01034	31.7 x 22.8 x 2cm
02-002-01035	34.8 x 25 x 2.1cm
02-002-01036	38.4 x 28.5 x 2.3cm
02-002-01037	41.5 x 30.6 x 2.3cm



Stainless Steel Deep Roasting Pan

Product Code	Dimension (L x B x H)
01-001-00876	13 x 10 x 5cm
01-001-00878	16 x 12 x 6.5cm
01-001-00879	18 x 12.5 x 7cm
01-001-00880	20 x 14 x 7.5cm
01-001-00877	22 x 16.4 x 7.5cm
01-001-00881	25.3 x 17.5 x 8cm

Stainless Steel Rectangular Deep Tray

Product Code	Dimension (L x B x H)
02-002-01136	25 x 19.1 x 4.3cm
02-002-01137	28 x 21.9 x 5cm
02-002-01138	30.5 x 23.6 x 5.3cm
02-002-01139	33.5 x 25.3 x 6.1cm
02-002-01140	39.5 x 27.5 x 6.4cm
02-002-01141	46 x 32 x 8.4cm
02-002-01142	56 x 35 x 9cm

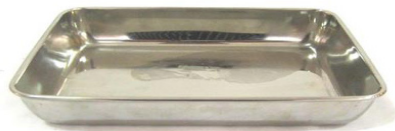

Stainless Steel Rectangle Pan

Product Code	Dimension (L x B x H)
02-002-01143	24 x 19 x 5cm
02-002-01144	30 x 23.5 x 5cm
02-002-01145	35 x 27.5 x 5cm
02-002-01146	40 x 30 x 6cm



FISCHER Stainless Steel Butchery Tray

Product Code	Dimension (L x B x H)
02-002-00180(XX)	32.5 x 23 x 4cm
02-002-00181	51 x 36 x 4cm
02-002-00182(XX)	42 x 32 x 4cm



ZEBRA Stainless Steel Rectangular Tray

Product Code	Dimension
02-002-00201	25 x 21cm
02-002-00202	30 x 25cm
02-002-00203	36 x 29cm
02-002-00204	41 x 32.7cm
02-002-00205	46 x 36.7cm



ZEBRA Stainless Steel Round Dish

Product Code	Dimension
02-002-00245	9"
02-002-00246	10"



Stainless Steel Rectangle Tray

Product Code	Dimension (L x B x H)
02-002-01128	25 x 19.1 x 2cm
02-002-01129	28 x 21.9 x 2cm
02-002-01130	30.5 x 23.6 x 2cm
02-002-01131	33.5 x 25 x 2cm
02-002-01132	39.5 x 27 x 2cm
02-002-01133	45.5 x 32 x 2cm
02-002-01134	56 x 35 x 2cm
02-002-01135	56 x 40 x 2cm



FISCHER Stainless Steel Grid for Butchery Tray

Product Code	Dimension
02-002-00183(XX)	27 x 17.5cm
02-002-00184(XX)	36 x 26cm
02-002-00185	45 x 29cm



FOUR BRIGHT Aluminium Rectangle Tray

Product Code	Dimension
02-002-00191	28 x 20cm
02-002-00190	33 x 24cm
02-002-00210	35 x 26 x 3cm
02-002-00189	38 x 28cm
02-002-00211	40 x 29 x 3cm
02-002-00212	44 x 32 x 3cm
02-002-00213	49 x 37 x 3cm
02-002-00214	54 x 40 x 3cm



FOUR BRIGHT Aluminium Rectangle Deep Pan

Product Code	Dimension (L x B x H)	Size
02-002-00188	33 x 22.5 x 5cm	3
02-002-00187	36 x 27 x 6cm	2
02-002-00186	40 x 30 x 6.5cm	1



Stainless Steel 2-Compartment Condiment Box with Lid

Product Code	Dimension (L x B x H)
02-002-00287	22 x 15 x 6cm



Stainless Steel 3-Compartment Condiment Box with Lid

Product Code	Dimension (L x B x H)
02-002-00288	33 x 15 x 6cm



Stainless Steel 4-Compartment Condiment Box with Lid

Product Code	Dimension (L x B x H)
02-002-00289	30 x 22 x 6.5cm



Stainless Steel 6-Compartment Condiment Box with Lid

Product Code	Dimension (L x B x H)
02-002-00290	32 x 30 x 6.5cm



Stainless Steel Condiment Dispenser

Product Code	Dimension (L x B x H)	Capacity
02-002-00291	23 x 16 x 10cm	3x1 pint / 473ml
02-002-00292	30 x 16 x 10cm	4x1 pint / 473ml
02-002-00293	38 x 16 x 10cm	5x1 pint / 473ml
02-002-00294	38 x 16 x 10cm	6x1 pint / 473ml



SAN JAMAR Stainless Steel Condiment Dispenser

Product Code	Dimension (L x B x H)	Capacity
02-002-00315	8.9 x 23.2 x 14.6cm	3x1 pint / 473ml
02-002-00316	8.9 x 30.8 x 14.6cm	4x1 pint / 473ml
02-002-00317	8.9 x 38.1 x 14.6cm	5x1 pint / 473ml
02-002-00318	8.9 x 45.7 x 14.6cm	6x1 pint / 473ml



SAN JAMAR Stainless Steel Condiment Dispenser with Individual Notched Lid

Product Code	Dimension (L x B x H)	Capacity
02-002-00319	8.9 x 15.2 x 14.6cm	1x1 qt / 946ml
02-002-00320	8.9 x 30.5 x 14.6cm	2x1 qt / 946ml



JIWINS Plastic Condiment Dispenser

Product Code	Dimension (L x B x H)	Capacity
02-002-00281	50 x 16 x 9cm	4x1 pint / 473ml
02-002-00282	50 x 16 x 9cm	6x1 pint / 473ml



SAN JAMAR Dome Condiment Dispenser

Product Code	Capacity	Capacity
02-002-00304	3x2 qt / 946ml	Dome center, 2 x handles
02-002-00305	4x3 qt / 946ml	Dome center, 2 x handles
02-002-00306	1x2 qt, 4x1qt / 946ml	Garnish center 2 snap-on caddies, handles
02-002-00307	6x1 qt / 946ml	Garnish center 2 snap-on caddies, handles



SAN JAMAR Dome Stacker Condiment Dispenser

Product Code	Capacity
02-002-00308	3x2 qt / 946ml 6x1qt / 946ml (chillable)



SAN JAMAR Mini Dome Condiment Dispenser

Product Code	Capacity	Garnish Center
02-002-00310	2x1 pt / 473mℓ	



SAN JAMAR Mini Dome Condiment Dispenser with Notched Lids

Product Code	Capacity	Dome stacker 2 notched lids, 2 standaround lids
02-002-00311	4x1.5qt / 473mℓ 4x1 pt / 473mℓ	



SAN JAMAR Mini Dome Stacker Condiment Dispenser

Product Code	Capacity
02-002-00312	2x2 qt / 473mℓ 1x1 qt / 473mℓ



SAN JAMAR Plastic Condiment Tray Insert

Product Code	Dimension (L x B x H)	Capacity
02-002-00313	6.4 x 12.7 x 7.3cm	1 pint / 473mℓ



SAN JAMAR Plastic Condiment Tray Insert

Product Code	Dimension (L x B x H)	Capacity
02-002-00314	14.9 x 7 x 14cm	1qt / 946mℓ



SAN JAMAR Deep Tray Insert

Product Code	Capacity
02-002-00302	2qt / 1.8ℓ



SAN JAMAR Deep Tray Insert for Dome Condiment Dispenser

Product Code	Capacity
02-002-00303	3 pint / 1.4ℓ



SAN JAMAR Chillable Standaround Tray Insert

Product Code	Capacity
02-002-00301	1 pint / 473mℓ



SAN JAMAR EZ-Chill Refreezable Ice Pack

Product Code	Capacity
02-002-00309	6pcs/pack



SAN JAMAR Stainless Steel Garnish Tray with Ice Packs

Product Code	Dimension (L x B x H)	Capacity
02-002-00321	147 x 457 x 137mm	3x1 qt / 946mℓ, 3 x Ice packs



TABLECRAFT *Stainless Steel Expandable Countertop Squeeze Bottle*

Product Code	Dimension (L x B x H)	
02-002-00917	10.5" x 3.75" x 2"	Holds up to 6 bottles

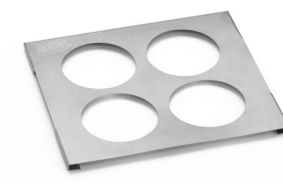

TABLECRAFT *Stainless Steel Four Hole Squeeze Bottle Holder*

Product Code	Dimension	
02-002-00918	6.25" x 7"	Holds 12oz and 16oz bottles. For 1/6 pan size. Pan not included.



TABLECRAFT *Stainless Steel Six Hole Squeeze Bottle Holder*

Product Code	Dimension	
02-002-00919	12.75" x 7"	Holds 12oz, 16oz and 24oz bottles. For 1/3 pan size. Pan not included.



TABLECRAFT *Stainless Steel Eight Hole Squeeze Bottle Holder*

Product Code	Dimension	
02-002-00920	12.75" x 7"	Holds 12oz and 16oz bottles. For 1/3 pan size. Pan not included.



TABLECRAFT *PE Dual Way Squeeze Bottle with InveraTop™*

Product Code	Dimension	Capacity
02-002-00902	5.3cm opening	16oz / 473mℓ



TABLECRAFT *NATURAL Squeeze Bottle One Tip*

Product Code	Dimension	Capacity
02-002-00903	6.3cm opening	20oz / 591mℓ



TABLECRAFT *NATURAL Squeeze Bottle Triple Tip*

Product Code	Dimension	Capacity
02-002-00904	6.3cm opening	16oz / 473mℓ
02-002-00905	6.3cm opening	24oz / 710mℓ
02-002-00914	6.3cm opening	32oz / 946mℓ



TABLECRAFT *NATURAL Dual Way Squeeze Bottle*

Product Code	Dimension	Capacity
02-002-00907	6.3cm opening	24oz / 710mℓ



TABLECRAFT *NATURAL Squeeze Bottle with Natural Cane Tiptop, Dual Way*

Product Code	Capacity
02-002-00908	16oz / 473mℓ
02-002-00909	24oz / 710mℓ



Metal Stand Adjustable T-Stand for 02-002-00928

Product Code	Dimension
02-002-00926	36 x 30 x 89cm

TABLECRAFT PE Dual Way Squeeze Bottle with InveraTop™

Product Code	Dimension	Capacity	
02-002-00910	5.3cm opening	12oz / 355ml	Works with slow-flowing condiments such as barbecue and mayonnaise
02-002-00913	5.3cm opening	24oz / 710ml	Works with slow-flowing condiments such as barbecue and mayonnaise

JIWINS PE Squeeze Bottle

Dimension	Capacity	Clear	Red	Yellow
Ø5 x 17.5cm	8oz / 236ml	02-002-00884	02-002-00973	02-002-00886
Ø5.5 x 20.6cm	12oz / 355ml	02-002-00878	02-002-00971	02-002-00880
Ø7 x 24cm	24oz / 710ml	02-002-00881	02-002-00972	02-002-00883

A-STAR Plastic Multi Purpose Squeeze Bottle with Cover

Dimension	Capacity	Green	Red	White	Yellow
7 x 18cm	12oz / 350ml	02-002-00889	02-002-00974	02-002-00891	02-002-00892
7.5 x 26.8cm	25oz / 750ml	02-002-00893	02-002-00894	02-002-00895	02-002-00896

Plastic Refillable Container with Squeeze Pump

Product Code	Dimension	Capacity	Plastic Refillable Container	Plastic Squeeze Dispenser	Accessory Stand
02-002-00928	18.5cm Thread: Ø4cm	6l	02-002-00927 Dimension: 18.5cm Thread: Ø4cm	02-002-00925 Dimension: 17 x 17 x 22.5cm	02-002-00926 Dimension: 36 x 30 x 89cm

WESTMARK Stainless Steel Garnishing / Cocoa Castor

Product Code	Dimension	Capacity
02-002-00942	Ø7.5 x H10cm	9oz (4 Shaker Plates)

Stainless Steel Condiment Can with Mesh

Product Code	Dimension
02-002-00949	Ø6 x H8cm



Stainless Steel Sugar Dredger with Mesh Cover

Product Code	Dimension	Capacity
02-002-00950	Ø7 x H9cm	10oz



Stainless Steel Sugar / Icing Shaker

Product Code	Dimension	Capacity
02-002-00943	Ø7 x H9cm	10oz



Stainless Steel Sugar / Icing Shaker with Handle

Product Code	Dimension	Capacity
02-002-00944	Ø7 x H9cm	10oz



Stainless Steel Sesame Can

Product Code	Dimension	
02-002-00951	Ø6.5 x H10cm	3.5mm hole



Stainless Steel Salt / Sesame Can

Product Code	Dimension
02-002-00941	Ø7.2 x H9cm



Stainless Steel Pepper Shaker w/ Handle & 'P' Cover

Product Code	Dimension	Capacity
02-002-00945	Ø7 x H9cm	10oz



Stainless Steel Pepper Shaker w/ 'P' Cover

Product Code	Dimension	Capacity
02-002-00946	Ø7 x H9cm	10oz



Stainless Steel Pepper Can

Product Code	Dimension
02-002-00940	Ø7.2 x H9cm



Stainless Steel Salt / Pepper Can

Product Code	Dimension
02-002-00939	Ø6.5 x H11cm



Stainless Steel Salt Shaker w/ Handle & 'S' Cover

Product Code	Dimension	Capacity
02-002-00947	Ø7 x H9cm	10oz



Stainless Steel Salt Shaker w/ 'S' Cover

Product Code	Dimension	Capacity
02-002-00948	Ø7 x H9cm	10oz



Stainless Steel Multi Purpose Shaker

Product Code	Dimension
02-002-00952	Ø6.5 x H9.5cm



Stainless Steel Shaker for Salt or Pepper

Product Code	Dimension	Capacity
02-002-00953	Ø5 x H7cm	8oz
02-002-00954	Ø7 x H8.5cm	9.5oz
02-002-00955	Ø7 x H11.5cm	12oz



TABLECRAFT Swirled Cheese Shaker w/ Chrome Perforated Top

Product Code	Capacity
02-002-01107	6oz



CAMBRO Plastic Shaker with Salt & Pepper Lid

Product Code
02-002-00975



CAMBRO Plastic Shaker with Cheese Lid

Product Code
02-002-00933



CAMBRO Salt and Pepper Lid Only

Product Code	Colour
02-002-00936(XX)	Beige



CAMBRO Plastic Shaker with Medium Ground Lid

Product Code
02-002-00935



WESTMARK Stainless Steel Strainer

Product Code	Dimension
02-002-00423	Ø20 x L42cm



LACOR Stainless Steel Food Mill with 2 Discs

Product Code	Dimension	Capacity	
02-002-00422	Ø20 x H9cm	1.5l	Light-duty
02-002-00420	Ø26 x H13cm	5.0l	Heavy-duty
02-002-00421	Ø32 x H15cm	8.0l	Heavy-duty



LACOR Stainless Steel Food Mill with 2 Discs

Product Code	Dimension	Capacity
02-002-00419	Ø30 x H12.5cm	3.5l



L. TELLIER Stainless Steel Food Mill w/ 3 Stainless Steel Discs

Product Code	Dimension	
02-002-00417	Ø31 x H25cm	Sieves 1.5mm, 2.5mm, 4.0mm



Accessories Sieve

L. TELLIER Food Mill C/W 1 Disc, Stainless Steel Sieve

Product Code	Dimension	
02-002-00411	Ø37 x H32cm	Comes with 1 Sieve Ø3.0mm
02-002-00412	Ø1.0mm	
02-002-00413	Ø1.5mm	Accessories Sieve
02-002-00414	Ø2.0mm	
02-002-00416	Ø3.0mm	
02-002-00415	Ø4.0mm	



Stainless Steel Flour Sieve w/ Hand Press

Product Code	Dimension
02-002-00711	Ø12 x H13cm



CCK Stainless Steel Flour Sieve Heavy Duty

Product Code	Dimension
02-002-00688	Ø10"
02-002-00689	Ø12"
02-002-00690	Ø14"
02-002-00691	Ø16"



Stainless Steel Flour Sieve with 4 Interchangeable Mesh

Product Code	Dimension	
02-002-01093	Ø26cm	Mesh 1: 0.075 x Ø0.016cm, Mesh 2: 0.1 x Ø0.024cm, Mesh 3: 0.2 x Ø0.028cm, Mesh 4: 0.3 x Ø0.038cm



Accessories Sieve

L. TELLIER Stainless Steel Food Mill on Stand with 1 Sieve (P10)

Product Code	Dimension	
02-002-00406(XX)	Ø39 x H80cm	Comes with 1 Sieve Ø3.0mm
02-002-00407(XX)	Ø1.0mm	
02-002-00408(XX)	Ø1.5mm	Accessories Sieve
02-002-00409(XX)	Ø2.0mm	
02-002-00410(XX)	Ø4.0mm	



LACOR Stainless Steel Flour Sieve P50

Product Code	Dimension
02-002-00692(XX)	Ø30cm



LACOR Stainless Steel Sieve P25

Product Code	Dimension
02-002-00693(XX)	Ø30cm



Stainless Steel Flour Sieve

Product Code	Dimension
02-002-00699	Ø16cm
02-002-00700	Ø18cm
02-002-00701	Ø21cm
02-002-00702	Ø23cm
02-002-00703	Ø26cm
02-002-00704	Ø29cm
02-002-00705	Ø35cm
02-002-00706	Ø40cm
02-002-00707	Ø45cm



Stainless Steel Potato Ricer / Press

Product Code	Dimension
02-002-00427	30.5 x 9.5cm



Stainless Steel Potato Masher

Product Code	Dimension
02-002-00428	28 x 7cm
02-002-00429	Ø12 x H60cm
02-002-00430	Ø15 x H80cm



MICROPLANE GOURMET Stainless Steel Grater

Product Code	Dimension	Type	
02-002-00447	30 x 7.5cm	Fine	Use to zest citrus, grate hard round cheeses,spices, chillies and ginger.
02-002-00446	30 x 7.5cm	Medium Ribbon	Use to grate chocolate, coconut,soft cheeses, zucchini and onion.
02-002-00445	30 x 7.5cm	Coarse	Use to grate hard round cheeses, coconut,carrots, garlic and chocolate.
02-002-00449	30 x 7.5cm	Extra Coarse	Use to grate zucchini, potatoes,soft cheeses, carrots and cabbage.
02-002-00451	30 x 7.5cm	Ultra Coarse	For use with cabbage, soft cheeses, zucchini,carrots, potatoes, apples and other foods that require larger grating surface



MICROPLANE PROFESSIONAL Stainless Steel Grater

Product Code	Dimension	Type	
02-002-00457	33 x 7.6cm	Fine / Spice	Use to zest citrus, grate hard round cheeses,spices, chillies and ginger.
02-002-00456	33 x 7.6cm	Medium Ribbon	Use to grate chocolate, coconut,soft cheeses, zucchini and onion.
02-002-00455	33 x 7.6cm	Coarse	Use to grate hard round cheeses, coconut,carrots, garlic and chocolate.
02-002-00459	33 x 7.6cm	Extra Coarse	Use to grate zucchini, potatoes,soft cheeses, carrots and cabbage.



MICROPLANE SPECIALTY 4-Sided Box Grater (Dishwasher safe)

Product Code	Dimension	Type
02-002-00461	13 x 8 x 26cm	Ultra coarse; Fine/zester; Medium ribbon; Slicer



LACOR Stainless Steel Potato Grater

Product Code	Dimension	Type
02-002-00436	25.5 x 11cm	Flat Fine
02-002-00437	25.5 x 11cm	Flat Slice / Fine / Coarse
02-002-00435	25.5 x 11cm	Flat Coarse



LACOR Stainless Steel Grater

Product Code	Dimension	Type
02-002-00439	22 x 3.5cm	Long Fine
02-002-00440	22 x 3.5cm	Long Medium
02-002-00438	22 x 3.5cm	Long Coarse



LACOR Stainless Steel 4-Sided Box Grater

Product Code	Dimension
02-002-00434	11 x 9 x 23cm



LACOR Stainless Steel Nutmeg Grater

Product Code	Dimension
02-002-00441	Ø4 x L14cm



LACOR Stainless Steel Rotary Cheese Grater with 2 Blades

Product Code	Dimension
02-002-00442	20 x 13.5 x 10cm



BOSKA ROMANO Hand Grater

Product Code	Dimension
02-002-00432	No sharp edges. 1 press function.



MICROPLANE GOURMET Stainless Steel Star Parmesan Grater

Product Code	Dimension
02-002-00450	30 x 7.5cm

Star blade creates pillow soft mounds out of hard round cheeses, chocolate, garlic, spices and ginger.



MICROPLANE GOURMET Plastic Slider Attachment for Graters

Product Code	Dimension
02-002-00452	Use to grate small items such as garlic and nutmeg.



Stainless Steel Triangle 3-Sided Grater

Product Code	Dimension
02-002-00466	21 x 15 x 4cm



Stainless Steel Cheese Grater

Product Code	Dimension
02-002-00465	15.5 x 5.7cm



L. TELLIER Stainless Steel Cheese Grater

Product Code	Dimension
02-002-00433(XX)	19.4 x 11 x 11.5cm



MICROPLANE GOURMET Stainless Steel Large Shaver

Product Code	Dimension
02-002-00448	30 x 7.5cm



MICROPLANE PROFESSIONAL Stainless Steel Large Shaver

Product Code	Dimension
02-002-00458	33 x 7.6cm



Cast Aluminium Heavy Duty Ginger Grater

Product Code
02-002-00463



MICROPLANE PREMIUM Stainless Steel Spice Grater

Product Code	Dimension
02-002-00453	12.3 x 1.1cm



MICROPLANE PREMIUM Stainless Steel Zester

Product Code	Dimension	
02-002-00454	30 x 3.3cm	PREMIUM range. Use to zest citrus, grate hard round cheeses and ginger.



ATLANTIC CHEF Lemon Zester

Product Code	
02-002-00431	5 Holes



LACOR Stainless Steel Manual Onion Chopper

Product Code	Dimension	Capacity
02-002-00468	Ø9.5 x H22cm	200ml



WESTMARK Aluminium Coated Garlic Press

Product Code	Dimension
02-002-00471	16 x 5.2 x 3.3cm



MICROPLANE Garlic Cutter

Red	Black
02-002-00470	02-002-00469



WESTMARK KERNEX Aluminium Coated Cherry Stoner

Product Code	Dimension
02-002-00490	14 x 4 x 2.5cm



WESTMARK OLIVUS Aluminium Coated Olive Stoner

Product Code	Dimension
02-002-00491	17 x 5 x 1cm



LACOR Stainless Steel Egg Slicer

Product Code	Dimension
02-002-00496	Ø10cm



LACOR Stainless Steel 2-Way Egg Slicer

Product Code	Dimension
02-002-00497	15 x 10 x 3.7cm



IMPERIA STENDIPASTA Wd Square Pasta Drying Rack

Product Code	Dimension
02-002-00505	27 x 10cm



IMPERIA Raviolamp 24-24 Squares

Product Code	Dimension	
02-002-00498	28.5 x 11cm	Ravioli Classici



IMPERIA Raviolamp 36-36 Squares

Product Code	Dimension	
02-002-00499	32 x 14cm	Ravioli Classici

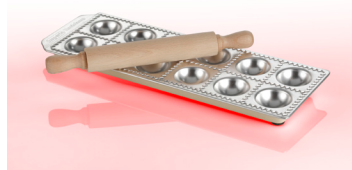

IMPERIA Raviolamp 12-12 Circles

Product Code	Dimension	
02-002-00500	33.5 x 11.5cm	Ravioli Chef



IMPERIA Raviolamp 10-10 Stars

Product Code	Dimension	
02-002-00501	32 x 14cm	Stelline Little Star

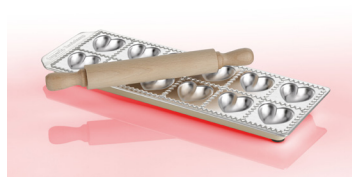

IMPERIA Raviolamp 12-12 Hearts

Product Code	Dimension	
02-002-00502	33.5 x 11.5cm	Cuoricini Little Hearts



IMPERIA Raviolamp 18-18 Triangles

Product Code	Dimension	
02-002-00503	33.5 x 11.5cm	Triangular Tortelli Classici



IMPERIA Raviolamp 6-6 Semi Circles

Product Code	Dimension	
02-002-00504	33.5 x 11.5cm	Sorrisi Giant Smiles



Stainless Steel Citrus Juice Press

Product Code	Dimension
02-002-00485	16 x 11 x 8.5cm



WESTMARK Stainless Steel Lemon Pourer

Product Code	Dimension	Colour
02-002-00487	Ø3.5 x 7.5cm	Clear



WESTMARK LIMONA Aluminium Citrus Fruit Press

Product Code	Dimension
02-002-00483	Ø12 x L23.8cm



Stainless Steel Citrus Juice Press

Product Code	Dimension
02-002-00486	Ø9x L28cm



Stainless Steel Lime / Citrus Squeezer

Product Code	Dimension
02-002-00488	8.35 x 7.3cm



Aluminium Standing Fruit Press

Product Code	Dimension
02-002-00484	31 x 11 x 23cm



Mortar & Pestle

Product Code	Dimension	Colour
02-002-00474	Ø12 x 9.5cm	Marble (White)
02-002-00476	Ø10 x H9cm	Smooth Black w/ Flower
02-002-00477	Ø12 x H10cm	Smooth Black w/ Flower



JAMIE OLIVER Large Pestle & Mortar

Product Code	Dimension
02-002-01112	20cm



Stainless Steel French Fry Scoop

Product Code	Dimension	
02-002-00506	19 x 23cm	With Right Handle
02-002-00507	19 x 23cm	With 2 Handles



TRAEX French Fry Scoop

Product Code	Dimension	
02-002-00508	22.9 x 20.5 x 5cm	For Right-Handers
02-002-00509	22.9 x 20.5 x 5cm	With 2 Handles

Ice Cream Scoop Size Chart (for Stockel items)

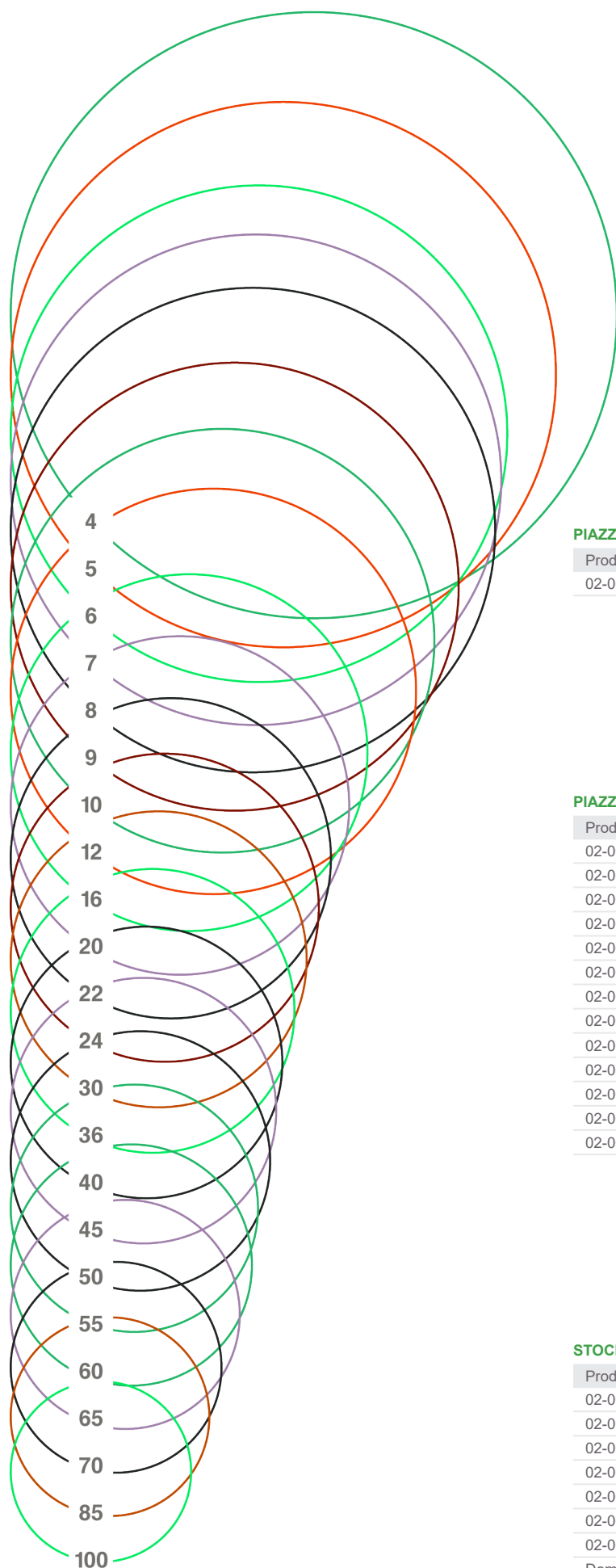

PIAZZA Stainless Steel Oval Ice Cream Scoop

Product Code	Dimension	Capacity
02-002-00537	6 x 4.5cm	1/30ℓ



PIAZZA Stainless Steel Ice Cream Scoop

Product Code	Dimension	Capacity
02-002-00520	Ø3.2cm	1/100ℓ
02-002-00521	Ø3.7cm	1/70ℓ
02-002-00522	Ø4.0cm	1/60ℓ
02-002-00523	Ø4.3cm	1/50ℓ
02-002-00524	Ø4.6cm	1/40ℓ
02-002-00525	Ø4.9cm	1/36ℓ
02-002-00526	Ø5.2cm	1/30ℓ
02-002-00527	Ø5.5cm	1/24ℓ
02-002-00528	Ø6.0cm	1/20ℓ
02-002-00529	Ø6.3cm	1/16ℓ
02-002-00530	Ø6.9cm	1/12ℓ
02-002-00531	Ø7.4cm	1/10ℓ
02-002-00532	Ø7.8cm	1/8ℓ



STOCKEL Stainless Steel Ice Cream Scoop with Colour Plastic Handle

Product Code	Dimension	Capacity	No.
02-002-00577	Ø3.0cm	10ml	100
02-002-00578	Ø3.5cm	14ml	70
02-002-00579	Ø4.3cm	20ml	50
02-002-00580	Ø4.9cm	33ml	30
02-002-00581	Ø5.1cm	42ml	24
02-002-00582	Ø5.6cm	50ml	20
02-002-00583	Ø5.9cm	63ml	16

Domestic. Stainless steel 18/10, Light blue short plastic handle



STOCKEL Stainless Steel Ice Cream Scoop / Portioner

Product Code	Dimension	Capacity	No.
02-002-00563	Ø3.0cm	10mℓ	100
02-002-00564	Ø3.5cm	14mℓ	70
02-002-00565	Ø4.0cm	16mℓ	60
02-002-00566	Ø4.3cm	20mℓ	50
02-002-00567	Ø4.5cm	25mℓ	40
02-002-00568	Ø4.9cm	33mℓ	30
02-002-00569	Ø5.1cm	42mℓ	24
02-002-00570	Ø5.6cm	50mℓ	20
02-002-00571	Ø5.9cm	63mℓ	16
02-002-00572	Ø6.7cm	83mℓ	12
02-002-00573	Ø7.0cm	100mℓ	10
02-002-00574	Ø8.0cm	125mℓ	8
02-002-00575	Ø9.0cm	200mℓ	5

Stainless Steel 18/10. Handle solid brass chrome-plated



ZEROLL Ice Cream Scoop

Product Code	Capacity	Capacity
02-002-00550	1.0oz	■ #30 Red
02-002-00551	1.5oz	■ #24 Silver
02-002-00552	2.0oz	■ #20 Gold
02-002-00553	2.5oz	■ #16 Green
02-002-00554	3.0oz	■ #12 Blue
02-002-00555	4.0oz	■ #10 Brown



SAN JAMAR SAF-T Ice Scoop & Guardian System

Product Code	Dimension	Capacity
02-002-00597	24.8 x 11 x 16.4cm	6-10oz / 177-295mℓ
02-002-00598	24.8 x 12.2 x 17.1cm	12-16oz / 354-473mℓ
02-002-00599	28.3 x 14 x 18.8cm	20-24oz / 591-709mℓ
02-002-00600	35.6 x 18.1 x 20.9cm	64-86oz / 1.8-2.5ℓ



STOCKEL Ice Cream Scoop with Creamic Coated

Product Code	Dimension	Capacity	No.
02-002-00562	Ø4.9 x L12.5cm	33mℓ	30
02-002-00561	Ø5.1 x L12.5cm	42mℓ	24
02-002-00560	Ø5.6 x L12.5cm	50mℓ	20
02-002-00559	Ø5.9 x L12.5cm	63mℓ	16

Heat conductive fluid in handle, blue ceramic non-stick coating



Stainless Steel Ice Cream Spade

Product Code	Dimension
02-002-00558	9" x 8"



ZEROLL Aluminium Tubmate Ice Cream Spade

Product Code	Dimension
02-002-00556	10"



SAN JAMAR Banquet / Beverage SAF-T Scoop

Product Code	Dimension	Capacity
02-002-00601	10 x 7.5 x 4cm	4-6oz / 118-177mℓ
02-002-00602	13.5 x 7.5 x 5cm	6-10oz / 177-295mℓ
02-002-00603	13.5 x 8.5 x 6cm	12-16oz / 354-473mℓ
02-002-00604	17 x 10.7 x 7cm	20-24oz / 591-709mℓ
02-002-00605	23.6 x 15.8 x 8cm	64-86oz / 1.8-2.5ℓ

Accessory: 02-002-00596



SAN JAMAR SAF-T Ice Scoop Caddy

Product Code	Dimension	Colour
02-002-00596	28.7 x 23.1 x 20.4cm	■ Blue



TABLECRAFT Aluminium Ice Scoop

Product Code	Dimension	Capacity
02-002-01103	7.25 x 2.75 x 1.75cm	5oz / 147ml
02-002-01100	8.75 x 3.125 x 2.25cm	12oz / 354ml
02-002-01101	10.5 x 4 x 2.5cm	24oz / 709ml
02-002-01102	12 x 4.6 x 3.86cm	38oz / 1.1ℓ
02-002-01104	14.25 x 5.25 x 3.5cm	58oz / 1.7ℓ
02-002-01105	16 x 6.5 x 3.75cm	85oz / 2.5ℓ



Aluminium Ice Scoop, Round Mouth

Product Code	Dimension	Capacity
02-002-00610	12 x 6.1 x 4cm	6oz / 177ml
02-002-00611	13.5 x 8 x 5cm	12oz / 354ml
02-002-00612	18 x 10 x 7cm	24oz / 709ml
02-002-00613	21 x 12 x 9cm	38oz / 1.1ℓ



JIWINS CLEAR Plastic Ice Scoop

Product Code	Dimension	Capacity
02-002-00592	25 x 8 x 7cm	177ml
02-002-00591	28 x 12 x 12cm	946ml
02-002-00590	33 x 15 x 14cm	1.8ℓ



Stainless Steel Flat Base Ice Scoop

Product Code	Dimension	Capacity
02-002-00615	12 x 6.5 x 3.5cm	177ml
02-002-00616	16 x 8.8 x 4cm	345ml
02-002-00617	20.5 x 11.5 x 5.5cm	709ml
02-002-00618	24 x 12 x 8cm	1ℓ



ZEBRA Stainless Steel Measuring Mug

Product Code	Capacity
02-002-00652	800ml



Aluminium Flat Ice Scoop

Product Code	Dimension	Capacity
02-002-00606	L13 x 7 x 4cm (excluding handle) Full Length: 21cm	6oz / 177ml
02-002-00607	L15.5 x 9 x 4.5cm (excluding handle) Full Length: 25cm	12oz / 354ml
02-002-00608	L20 x 11 x 5.5cm (excluding handle) Full Length: 31cm	24oz / 709ml
02-002-00609	L23.5 x 12 x 7cm (excluding handle) Full Length: 35cm	36oz / 1ℓ



LACOR Stainless Steel Ice Scoop

Product Code	Dimension	Capacity
02-002-00593	19 x 5 x 3cm	60ml
02-002-00594	21.5 x 6 x 4cm	110ml
02-002-00595	23.5 x 7.5 x 5cm	200ml



LACOR Stainless Steel Ice Scoop

Product Code	Dimension	Capacity
02-002-00614	24 x 8.5 x 3cm	4oz / 118ml



Stainless Steel All Round Flour Scoop

Product Code	Dimension
02-002-00619	Ø7.1 x L26.7cm
02-002-00620	Ø12 x L36.5cm



Stainless Steel Conical Measuring Jug / Cup

Product Code	Capacity	Colour
02-002-00659	0.25ℓ	Speckled Gray
02-002-00660	1.0ℓ	Speckled Gray
02-002-00661	2.0ℓ	Speckled Gray



AG Stainless Steel 18-8 Measuring Cup

Product Code	Capacity
02-002-01070	0.5ℓ
02-002-01071	1.0ℓ
02-002-01072	3.0ℓ
02-002-01073	5.0ℓ
02-002-01092	2.0ℓ



CAMBRO CLEAR Polycarbonate Measuring Cup

Product Code	Capacity
02-002-00623	225mℓ
02-002-00625	500mℓ
02-002-00621	1.0ℓ
02-002-00622	2.0ℓ
02-002-00624	4.0ℓ



JIWINS CLEAR Polycarbonate Measuring Cup

Product Code	Capacity
02-002-00630	250mℓ
02-002-00631	500mℓ
02-002-00632	1.0ℓ
02-002-00633	2.0ℓ
02-002-00634	3.0ℓ



MARINEX Glass Round Measuring Jug

Product Code	Capacity
02-002-00644	0.25ℓ
02-002-00645	0.5ℓ
02-002-00646	1.0ℓ



CAMBRO CLEAR Polycarbonate Measuring Scoop

Product Code	Capacity
02-002-00629	6oz / 177mℓ
02-002-00626	12oz / 354mℓ
02-002-00627	24oz / 709mℓ
02-002-00628	64oz / 1.8ℓ



A-STAR Plastic Measuring Scoop

Product Code	Capacity
02-002-00640	10oz / 295mℓ
02-002-00641	16oz / 473mℓ
02-002-00642	24oz / 709mℓ



Plastic Measuring Cup (Microwave-Safe)

Product Code	Capacity
02-002-00653	0.5ℓ
02-002-00654	1.0ℓ
02-002-00655	2.0ℓ
02-002-00656	3.0ℓ
02-002-00657	5.0ℓ



SCHNEIDER Plastic Measuring Jug

Product Code	Capacity	Matching Lid
02-002-00647	1.0ℓ	02-002-00649
02-002-00648	2.0ℓ	02-002-00650



Stainless Steel Measuring Spoon (5pcs)

Product Code	Capacity
02-002-00662	1/8 tsp (0.6ml), 1/4 tsp (1.2ml), 1/2 tsp (2.5ml), 1 tsp (5ml), 1 tbsp (15ml)



Plastic Measuring Spoon (5pcs)

Product Code	Capacity
02-002-00663	1ml, 5ml, 15ml, 50ml, 100ml



Plastic Measuring Cup and Spoon Set (11pcs)

Product Code	Capacity
02-002-00664	1/8 tsp (0.6ml), 1/4 tsp (1.2ml), 1/2 tsp (2.5ml), 1 tsp (5ml), 1/2 tbsp (7.5ml), 1 tbsp (15ml), 1/8 cup (31ml), 1/4 cup (62ml), 1/3 cup (83ml), 1/2 cup (125ml), 1 cup (250ml)



CARLISLE Measuring Spoon with Short Handle

Product Code	Capacity	Colour
02-002-00993	1oz / 29ml	Yellow
02-002-00992	1.5oz / 44ml	Brown
02-002-00995	2oz / 59ml	Red
02-002-00994	2.5oz / 74ml	Orange
02-002-00996	3oz / 88ml	White
02-002-00997	4oz / 118ml	Green
02-002-00998	6oz / 177ml	Black
02-002-00999	8oz / 236ml	Blue



CARLISLE Measuring Perforated Spoon with Short Handle

Product Code	Capacity	Colour
02-002-01000	2oz / 59ml	Red
02-002-01001	4oz / 118ml	Green



Stainless Steel Measuring Spoon (4pcs)

Product Code	Capacity
02-002-00658	59ml, 79ml, 118ml, 237ml



LACOR Stainless Steel Footed Measuring Cup

Product Code	Capacity
02-002-00643	1.0l



CCK Stainless Steel Sausage Funnel

Product Code	Dimension
02-002-00679	Ø4.5 x H8.75cm



WESTMARK Plastic Mixing Jug with Lid & Scale

Product Code	Dimension	Capacity
02-002-00651	Ø15 x H20cm	1.4l



LACOR Stainless Steel Funnel

Product Code	Dimension
02-002-00672	Ø12cm
02-002-00673	Ø16cm
02-002-00674	Ø20cm
02-002-00675	Ø24cm



LACOR Stainless Steel Funnel with Removable Filter

Product Code	Dimension
02-002-00678	Ø10cm
02-002-00676	Ø12cm
02-002-00677	Ø14cm



SCHNEIDER Plastic Funnel

Product Code	Dimension
02-002-00665	Ø5cm
02-002-00666	Ø6cm
02-002-00667	Ø8cm
02-002-00668	Ø10cm
02-002-00669	Ø12cm
02-002-00670	Ø14cm
02-002-00671	Ø16.4cm



WESTMARK Stainless Steel Preserve Funnel

Product Code	Dimension
02-002-00687	Ø13cm



Plastic Funnel

Product Code	Dimension
02-002-00682	Ø8cm
02-002-00683	Ø10cm
02-002-00684	Ø12.5cm
02-002-00685	Ø15cm



Stainless Steel Nut / Crab Cracker with Pick

Product Code	Dimension
02-002-00715	Cracker: 16cm / Pick: 19.7cm



LACOR Stainless Steel Lobster Cracker / Plier

Product Code	Dimension
02-002-00712	18.5cm



LACOR Stainless Steel Nut / Lobster Cracker

Product Code	Dimension
02-002-00713	17cm



Aluminium Lobster Cracker

Product Code	Dimension
02-002-00716	15cm



EDLUND Stainless Steel Manual Can Opener (SG-2 Series)

NSF Certified and Dishwasher safe. Opens: 4 to 6 cans/minute
Recommended Daily Use: Up to 15 cans per day.

Product Code	Model	Bar Length	Add. Info.
02-002-00727	13100	16"	With standard bar & stainless steel base. For up to 11" tall cans with stainless steel base
02-002-00728	13300	22"	With long bar & stainless steel base. For up to 17" tall cans with stainless steel base



EDLUND Stainless Steel Manual Can Opener (#2 Series)

Opens: 4 cans/minute Recommended Daily Use: Up to 15 cans per day.

Product Code	Model	Bar Length	Add. Info.
02-002-00726	12100	7"	Table Style Can Opener with new plated steel base (for cans up to 7" tall) "Old Reliable"



EDLUND Stainless Steel Manual Can Opener (S-11 Series)

NSF Certified and Dishwasher safe. Opens: 4 to 6 cans/minute
Recommended Daily Use: Up to 50 cans per day.

Product Code	Model	Bar Length	Add. Info.
02-002-00732	15000	23"	For up to 11" tall cans with cast stainless steel base
02-002-00733	15320	16"	For up to 17" tall cans with stainless steel clamp base and long bar
02-002-00734	15420	75"	For up to 11" tall cans with stainless steel clamp base and long bar. Complete with spare knife, gear and cleaning tool
02-002-00741(XX)	15020	23"	For up to 11" tall cans with stainless steel clamp base. Available with clamp instead of screws/ secures the underside of the table)



EDLUND Stainless Steel Manual Can Opener (#1 Series)

NSF Certified and Dishwasher safe. Opens: 4 to 6 cans/minute
Recommended Daily Use: Up to 50 cans per day.

Product Code	Model	Bar Length	Add. Info.
02-002-00724	11000	19.5"	Can Opener with new plated steel base (for cans up to 11" tall) "Old Reliable"
02-002-00725	11300	19.5"	With new stainless steel base.



EDLUND Stainless Steel Manual Can Opener (G-2 Series)

NSF Certified. Opens: 4 cans/minute Recommended Daily Use: Up to 15 cans per day.

Product Code	Model	Bar Length	Add. Info.
02-002-00736	16700	29.5"	For up to 17" tall cans with cast stainless steel base
02-002-00735	16200	22.5"	For up to 17" tall cans with stainless steel base
02-002-00742(XX)	16100	23"	For up to 17" tall cans with plated steel base
02-002-00743(XX)	16500	29.5"	For up to 17" tall cans with plated steel base



EDLUND Stainless Steel Manual Can Opener (#U-12 Series)

NSF Certified. Opens: 4 to 6 cans/minute Recommended Daily Use: Up to 50 cans per day.

Product Code	Model	Bar Length	Add. Info.
02-002-00729	14100	23"	For up to 11" tall cans with plated steel base
02-002-00730	14200	23"	For up to 11" tall cans with stainless steel base
02-002-00731	14600	29.5"	For up to 17" tall cans with stainless steel base
02-002-00739	14010	22"	For up to 11" tall cans with stainless steel clamp base
02-002-00740(XX)	14500	29.5"	For up to 17" tall cans with plated steel base



EDLUND CROWN PUNCH Manual Crown Punch Can Opener

Product Code	Model	Dimension	Add. Info.
02-002-00737(XX)	70100	20 x 14 x 20cm	Suitable for cans up to Ø6.5xH10.5". Recommended for up to 200 cans per day. Standard 10" blade. Check with our sales consultants for blade options for different can sizes.



EDLUND Accessories Clamp Base for S-11 / U-12 / G-2

Product Code	For
02-002-00744	For S-11 / U-12 / G-2 series



02-002-00745



02-002-00746



02-002-00747



02-002-00748



02-002-00749



02-002-00750

EDLUND Replacement Parts Knife and Gear

Product Code	For
02-002-00745	02-002-00724
02-002-00746	02-002-00726
02-002-00747	02-002-00735 / 742(XX) / 743(XX)
02-002-00748	02-002-00730 / 731 / 741(XX) / 739

*Other additional replacement parts may be available upon request

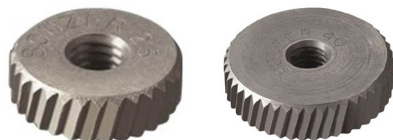

BONZER Spare Wheel Kit for Can Opener

Product Code	Dimension
02-002-00723	2.5cm
02-002-00721	4cm



BONZER Spare Blade for Bonzer Can Openers

Product Code	Dimension	Capacity
02-002-00722	Ø20 x 30 x 38cm	3.3t



UENO Can Opener

Product Code	Dimension
02-002-00753	7.3cm



BONZER Table Mount Can Opener with Stainless Steel Stem & Base

Product Code	Dimension	For up to
02-002-00718	28" x 5" x 4"	14" cans



BONZER Can Opener with Yellow Collar

Product Code	Dimension	For up to
02-002-00719	30" x 5" x 4"	16" cans. EZ20



BONZER Can Opener with Green Collar

Product Code	Dimension	For up to
02-002-00720	38" x 5" x 4"	25" cans. EZ40



SUNNEX Stainless Steel Can Opener

Product Code	Dimension
02-002-00751	17cm



Can Opener

Product Code
02-002-00766



CULINARE Lift Off Can Opener

Product Code	Dimension
02-002-00759	15.5cm



ZYLISS 5-Way Opener

Product Code	Colour
02-002-00754	Green



Aluminium Meat Tenderizer

Product Code	Type
02-002-00767	2-Face



Aluminium Square Meat Tenderizer

Product Code	Dimension
02-002-00768	60 x 5 x 5cm



FISCHER Butcher String

Product Code	Dimension	Capacity
02-002-00770	Ø10.5 x L14.5cm	1kg/2500mtr



Cooking String Roll in Blister Card with Cutter

Product Code	Dimension
02-002-00773	60m



FISCHER Stainless Steel Larding Needles with Plastic Handle

Product Code	Dimension
02-002-00777	25cm



FISCHER Stainless Steel Standaround String Holder

Product Code	Dimension
02-002-00771	17.5 x 14 x 21.5cm



FISCHER Stainless Steel String Holder on Stand

Product Code	Dimension
02-002-00772	19 x 12 x 16cm



FISCHER Stainless Steel Curved Trussing Needles

Product Code	Dimension
02-002-00774(XX)	Ø0.3 x L15cm
02-002-00775	Ø0.3 x L20cm
02-002-00776(XX)	Ø0.3 x L25cm



FISCHER Stainless Steel Straight Trussing Needles

Product Code	Dimension
02-002-00778(XX)	Ø0.3 x L15cm
02-002-00779(XX)	Ø0.3 x L25cm



CCK Stainless Steel Chicken Hanging Hook

Product Code	Type
02-002-00780	3-Star
02-002-00781	4-Star



CCK Stainless Steel S-Hook

Product Code	Length	Thickness
02-002-00791	4"	Thick
02-002-00792	5"	Thick
02-002-00793	6"	Thick
02-002-00794	7"	Thick
02-002-00795	8"	Thick
02-002-00796	9"	Thick
02-002-00797	12"	Thick
02-002-00798	4"	Thin
02-002-00799	5"	Thin
02-002-00800	6"	Thin
02-002-00801	7"	Thin
02-002-00802	8"	Thin
02-002-00803	9"	Thin



CCK Stainless Steel Chicken Hook

Product Code	Length	Thickness
02-002-00804	4"	Straight
02-002-00805	5"	Straight
02-002-00806	6"	Straight
02-002-00807	7"	Straight



CCK S'PORE STYLE Stainless Steel BBQ Charsiew Skewer (1.5mm Thick)

Product Code	Dimension
02-002-00814	8"
02-002-00815	10"
02-002-00817	12"
02-002-00819	14"
02-002-00821	16"
02-002-00823	18"
02-002-00825	20"



CCK Stainless Steel Chicken Hook with Wooden Handle

Product Code	Length
02-002-00782	14"
02-002-00783	16"
02-002-00784	18"
02-002-00785	20"
02-002-00786	22"
02-002-00787	24"
02-002-00788	30"
02-002-00789	42"



CCK STOVE Stainless Steel BBQ Hand Hook Long Handle

Product Code	Dimension
02-002-00808(XX)	143cm



CCK Stainless Steel 'J' Hook

Product Code	Dimension
02-002-00809	17cm



CCK HK Stainless Steel BBQ Charsiew Skewer

Product Code	Dimension
02-002-00810	14"
02-002-00811	16"
02-002-00812	18"
02-002-00813	20"



CCK S'PORE STYLE Stainless Steel BBQ Charsiew Skewer (1mm Thin)

Product Code	Dimension
02-002-00816	10"
02-002-00818	12"
02-002-00820	14"
02-002-00822	16"
02-002-00824	18"
02-002-00826	20"



CCK Stainless Steel BBQ Needle with Ring Handle

Product Code	Dimension
02-002-00832	24"



CCK Gold-Coin Chicken Needle / Skewer

Product Code	Dimension
02-002-00833	



CCK Stainless Steel Roast Pigeon Skewer 3-Prong

Product Code	Dimension
02-002-00851	16.5"



CCK S'PORE STYLE Roast Piglet Skewer 3-Prong

Product Code	Dimension
02-002-00834	22"
02-002-00835	26"



CCK Roast Piglet Skewer 2-Prong

Product Code	Dimension
02-002-00836	22"
02-002-00838	26"



CCK Stainless Steel Roast Piglet Skewer 2-Prong

Product Code	Dimension
02-002-00837	24"



CCK HANGING TYPE Stainless Steel Roast Piglet Skewer

Product Code	Dimension
02-002-00840	22"
02-002-00841	24"



CCK Stainless Steel Pig Fork

Product Code	Dimension
02-002-00842	22"
02-002-00843	24"
02-002-00844	26"



CCK Stainless Steel Attachable Handle for Pig Fork

Product Code	Dimension
02-002-00845	31.5"



CCK Accessory Wooden Handle for Roast Piglet Skewer

Product Code	Dimension
02-002-00839	



CCK Round Roast Pork Spike / Docket with Wooden Handle

Product Code	Dimension
02-002-00864	16cm



CCK Stainless Steel Rectangle Roast Pork Spike / Docket Heavy Duty

Product Code	Dimension
02-002-00865	16cm



CCK HK *Stainless Steel Char Siew Hanger Inverted Y*

Product Code	Dimension
02-002-00827	16"



CCK *Stainless Steel BBQ Chicken, Char Siew Meat Ring with 2 Hooks*

Product Code	Dimension
02-002-00846	12"



CCK *Stainless Steel Roast Piglet Ring with 2 Hooks*

Product Code	Dimension
02-002-00848	13"



CCK *Stainless Steel Roast Duck Tail Needle*

Product Code	Dimension
02-002-00981	6"



Aluminium Order Rack (Tab Grabber)

Product Code	Dimension
02-002-00963	18"
02-002-00964	24"
02-002-00965	36"
02-002-00966	48"



Stainless Steel Food Sign

Product Code	Dimension	
02-002-00967	11 x 11cm	"Uncooked"
02-002-00968	11 x 11cm	"Cooked"



CCK S'PORE STYLE *Stainless Steel Char Siew 'T' Hanger*

Product Code	Dimension
02-002-00828	14"
02-002-00829	16"
02-002-00830	18"
02-002-00831	20"



CCK *Stainless Steel Roast Duck Ring with 2 Hooks*

Product Code	Dimension
02-002-00980	12"



CCK *Stainless Steel BBQ Meat Ring with 2 Short Hooks*

Product Code	Dimension
02-002-00849	7"



CCK BBQ Aluminium Rod with 2 Short Rods

Product Code	Dimension
02-002-00867	Long 18" / Short 6.5"
02-002-00866	Long 18" / Short 7"



SAN JAMAR *Anodized Aluminium Slide Rack (Tab Grabber)*

Product Code	Dimension
02-002-00956	12"
02-002-00957	18"
02-002-00958	24"
02-002-00959	36"
02-002-00960	44"



TOKAI Plastic BBQ Mini Refillable Gas Torch

Product Code
02-002-00868



TOKAI Plastic BBQ Gas Lighter

Product Code
02-002-00869



Spark-L Gas Igniter

Product Code	Dimension
02-002-00871	21"



Battery Operated Ignition Gun

Product Code	Dimension
02-002-00874	23"
02-002-00875	13.5"



Stainless Steel One-Pc Soup Ladle

Product Code	Dimension
02-003-00062	Ø7cm
02-003-00063	Ø8cm
02-003-00064	Ø9cm



Stainless Steel Frying One-Pc Ladle with Long Handle, Economy

Product Code	Dimension
02-003-00047	50cm
02-003-00048	60cm
02-003-00049	80cm



Stainless Steel Frying Ladle

Product Code	Dimension	Capacity
02-003-00038	Size 1	12 Tahils
02-003-00039	Size 2	10 Tahils
02-003-00040	Size 3	8 Tahils
02-003-00041	Size 4	6 Tahils
02-003-00042	Size 5	4 Tahils



Stainless Steel Frying Ladle

Product Code	Dimension	Capacity
02-003-00864	Size 1	12 Tahils
02-003-00865	Size 2	10 Tahils
02-003-00866	Size 3	8 Tahils



ALEGACY Stainless Steel One-Pc Perforated Food Portioner

Product Code	Capacity	Colour
02-002-00510	2oz	Red
02-002-00511	3oz	Beige
02-002-00512	4oz	Green
02-002-00513	6oz	Black
02-002-00514	8oz	Blue



ALEGACY Stainless Steel One-Pc Solid Food Portioner

Product Code	Capacity	Colour
02-002-00515	2oz	Red
02-002-00516	3oz	Beige
02-002-00517	4oz	Green
02-002-00518	6oz	Black
02-002-00519	8oz	Blue



STEELCRAFT Stainless Steel One-Pc Ladle

Product Code	Dimension	Capacity
02-003-00230	Ø6.5 x L33.5cm	0.07ℓ
02-003-00231	Ø8 x L33.5cm	0.13ℓ
02-003-00232	Ø9 x L43cm	0.2ℓ
02-003-00233	Ø10 x L47cm	0.25ℓ
02-003-00234	Ø12 x L49cm	0.5ℓ
02-003-00235	Ø14 x L55cm	0.75ℓ
02-003-00236	Ø16 x L56.5cm	1.0ℓ
02-003-00237	Ø20 x L5	2.0ℓ
02-003-00239	Ø5 x L30cm	0.5oz
02-003-00240	Ø5.5 x L31cm	1oz
02-003-00241	Ø7 x L31cm	2oz
02-003-00242	Ø8 x L36.5cm	3oz
02-003-00243	Ø8.3 x L37cm	4oz
02-003-00244	Ø9.7 x L38cm	6oz
02-003-00245	Ø10.5 x L38cm	8oz
02-003-00246	Ø12.3 x L38.5cm	12oz
02-003-00247	Ø13 x L340cm	16oz
02-003-00248	Ø11 x L44.5cm	0.34ℓ
02-003-00249	Ø18 x L55.5cm	1.5ℓ



AG Stainless Steel 18-8 Horizontal Gravy Ladle

Product Code	Capacity
02-003-00841	30cc
02-003-00842	70cc



AG Stainless Steel 18-8 Horizontal Perforated Ladle

Product Code	Capacity
02-003-00843	70cc



Stainless Steel Short Ladle

Product Code	Dimension	Capacity
02-003-00250	Ø5.5 x L16.5cm	1oz
02-003-00251	Ø6 x L17cm	1.5oz
02-003-00252	Ø7 x L19cm	2oz



ALEGACY 18-8 Stainless Steel One-Pc Ladle

Product Code	Dimension	Capacity
02-003-00204	9" Handle	0.5oz
02-003-00205	9.25" Handle	1oz
02-003-00206	9.25" Handle	2oz
02-003-00207	10" Handle	3oz
02-003-00208	13" Handle	4oz
02-003-00209	13" Handle	6oz
02-003-00210	13.5" Handle	8oz
02-003-00211	15" Handle	12oz



AG Stainless Steel 18-8 Ladle

Product Code	Capacity
02-003-00830	10cc
02-003-00831	20cc
02-003-00832	36cc
02-003-00833	90cc
02-003-00834	144cc
02-003-00835	180cc
02-003-00836	270cc
02-003-00837	360cc
02-003-00838	540cc
02-003-00839	1000cc
02-003-00840	1800cc



LACOR Stainless Steel Perforated Ladle

Product Code	Dimension	Capacity
02-003-00227	Ø8 x L30cm	0.12ℓ
02-003-00228	Ø10 x L38cm	0.25ℓ
02-003-00229	Ø12 x L38cm	0.5ℓ



Stainless Steel Ladle with Round Handle

Product Code	Dimension
02-003-00253	37cm



ZEBRA Stainless Steel Ladle with Bakelite Handle

Product Code	Dimension
02-003-00643	35 x 7cm



ZEBRA Stainless Steel Slotted Ladle with Bakelite Handle

Product Code	Dimension
02-003-00645	35 x 7.2cm



EPIPUREAN GOURMET Nylon Ladle with Wood Fibre Handle with Measurement

Product Code	Dimension	Capacity
02-003-00216	32.5 x 8.4cm	1/8, 1/4, 1/2 cup
Heat resistant up to 204°C		



Non-Stick Rice Scoop

Product Code	Dimension
02-003-00752	7.5"



Stainless Steel Rice Ladle with Round Handle

Product Code	Dimension
02-003-00754	26cm



Stainless Steel Rice Scoop

Product Code	Dimension	Material
02-003-00755	L-Size	Wooden Handle



Stainless Steel Rice Scoop Ladle

Product Code	Capacity
02-003-00756	6 Tahils



Worldcraft Teflon Rice Scoop

Product Code
02-003-00751



Wooden Rice Scoop / Paddle

Product Code	Dimension
02-003-00762	50.2cm



Wooden Rice Scoop

Product Code	Dimension
02-003-00759	22.5cm
02-003-00760	23cm
02-003-00761	27cm



Stainless Steel Frying Turner with Long Handle, ET

Product Code	Dimension
02-003-00065	45 x 16cm
02-003-00066	60 x 16cm
02-003-00067	80 x 16cm



Stainless Steel Slotted Frying Turner with Long Handle, ET

Product Code	Dimension
02-003-00070	12 x 55cm
02-003-00071	16 x 78cm



Stainless Steel Frying One-Pc Turner with Long Handle, Economy

Product Code	Dimension
02-003-00043	50cm
02-003-00044	60cm
02-003-00045	80cm
02-003-00046	120cm



CCK Stainless Steel Frying Turner

Product Code	Dimension	Capacity
02-003-00008	45.5 x 12.2cm	0.2ℓ
02-003-00009	48.5 x 12.2cm	0.25ℓ



Stainless Steel Frying Ladle, Standard

Product Code	Dimension	Size
02-003-00050	54 x 12cm	Size 1
02-003-00051	45 x 11cm	Size 2
02-003-00052	44 x 10cm	Size 3



Stainless Steel Frying Turner

Product Code	Dimension
02-003-00867	43cm Size 2
02-003-00868	40cm Size 3



Stainless Steel Frying Ladle, Economy

Product Code	Dimension	Size
02-003-00053	49.5 x 13.5cm	Size 1
02-003-00054	47 x 12.7cm	Size 2
02-003-00055	45 x 11.8cm	Size 3
02-003-00056	44 x 11cm	Size 4
02-003-00057	41 x 10.4cm	Size 5



CCK Stainless Steel Turner with Long Handle

Product Code	Dimension
02-003-00010	36" x 6"
02-003-00011	48" x 6"
02-003-00012	60" x 6"



ATLANTIC CHEF Spatula

Product Code	Dimension
02-003-00073	9cm



ATLANTIC CHEF Serrated Spatula

Product Code	Dimension
02-003-00074	9cm



ATLANTIC CHEF Mini Square Spatula with Plastic Handle

Product Code	Dimension
02-003-00075	6.3 x 6.3cm



ATLANTIC CHEF Turner

Product Code	Dimension
02-003-00794	19 x 7.6cm
02-003-00793	20 x 10cm

ATLANTIC CHEF Heavy Duty Stainless Steel Turner

Product Code	Dimension
02-003-00097	15.2 x 12.7cm
02-003-00096	12.7 x 10.2cm

ATLANTIC CHEF Teppanyaki Turner

Product Code	Dimension
02-003-00095	10 x 12cm

ATLANTIC CHEF Large Fish Turner

Product Code	Dimension
02-003-00098	22.5 x 9.5cm

ATLANTIC CHEF Slotted Fish Turner

Product Code	Dimension
02-003-00082	16 x 7.2cm

ATLANTIC CHEF Pie Turner

Product Code	Dimension
02-003-00076	12.7 x 5cm
02-003-00077	12.7 x 7.6cm

ATLANTIC CHEF Perforated Offset Turner / Spatula

Product Code	Dimension
02-003-00081	20 x 7.6cm

ATLANTIC CHEF Offset Turner / Spatula

Product Code	Dimension
02-003-00083	10 x 6.3cm
02-003-00078	12.7 x 7.6cm
02-003-00079	15 x 7.6cm
02-003-00080	20 x 7.6cm

ATLANTIC CHEF Baker's Spatula

Product Code	Dimension
02-003-00084	15cm
02-003-00085	20cm
02-003-00086	25cm
02-003-00087	30cm

ATLANTIC CHEF Offset Baker's Spatula

Product Code	Dimension
02-003-00091	11.5cm
02-003-00092	15cm
02-003-00088	20cm
02-003-00089	25cm
02-003-00090	30cm

GIESSER Confectioner's Spatula Straight Plastic Handle

Product Code	Dimension
02-003-00108	10cm
02-003-00117	31cm



GIESSER Angular Broad Spatula with Plastic Handle

Product Code	Dimension	Colour
02-003-00119	16.5 x 11.5cm	Black
02-003-00120	16 x 11cm	Black



GIESSER Spatula Angular Resilient Plastic Handle

Product Code	Dimension	Handle Colour
02-003-00121	16 x 10cm	Black
02-003-00122	21 x 15cm	Black
02-003-00123	26 x 20cm	Black
02-003-00124	26 x 20cm	White
02-003-00125	31 x 25cm	Black



ZEBRA Nylon Turner with Bakelite Handle

Product Code	Dimension	Type
02-003-00024	38 x 9.8cm	Slotted
02-003-00025	38 x 9.8cm	

ZEBRA Stainless Steel Turner with Bakelite Handle

Product Code	Dimension
02-003-00031	M
02-003-00032	L



Stainless Steel Perforated Turner

Product Code	Dimension
02-003-00190	46cm



LACOR Stainless Steel One-Pc Fish Turner

Product Code	Dimension
02-003-00141	20.5 x 8cm



GIESSER Spatula Blunt Resilient Plastic Handle

Product Code	Dimension	Handle Colour
02-003-00109	16cm	Black
02-003-00110	16cm	White
02-003-00111	21cm	Black
02-003-00112	21cm	Blue
02-003-00113	21cm	Green
02-003-00114	21cm	Red
02-003-00115	21cm	White
02-003-00116	26cm	Black
02-003-00118	36cm	Black



ZEBRA Nylon Turner with Bakelite Handle

Product Code	Dimension	Type
02-003-00024	38 x 9.8cm	Slotted
02-003-00025	38 x 9.8cm	



Stainless Steel Turner

Product Code	Dimension
02-003-00189	46cm



SAFICO 18/8 Stainless Steel Slotted Turner with Hollow Handle

Product Code	Dimension
02-003-00145	34.5cm



Steak Turner, Small with Black Handle

Product Code	Dimension	Handle
02-003-00177	16 x 7.6cm	12.5cm



Perforated Hamburger Turner with Black Handle

Product Code	Dimension	Handle
02-003-00178	24 x 7.6cm	13cm



Hamburger Turner with Black Handle

Product Code	Dimension	Handle
02-003-00179	24 x 7.6cm	13cm



EPIPUREAN GOURMET Turner with Wooden Fibre Handle (Heat resistant up to 260°C)

Product Code	Dimension
02-003-00103	32.5 x 7.8cm



EPIPUREAN Wooden Fibre Slotted Saute Turner (Heat resistant up to 260°C)

Product Code	Dimension	Handle
02-003-00104	30 x 6.9cm	Natural
02-003-00105	30 x 6.9cm	Slate



EPIPUREAN Wooden Fibre Angled Turner (Heat resistant up to 176°C)

Product Code	Dimension	Handle
02-003-00106	30 x 5.3cm	Natural
02-003-00107	30 x 5.3cm	Slate



MYE Wooden Curved Turner (Acacia-Oiled)

Product Code	Dimension
02-003-00144	30 x 9cm



Bamboo Pan Turner

Product Code	Dimension
02-003-00195	12" Rounded Edge Turner



TABLECRAFT Plastic Spatula with Rubber Blade

Product Code	Dimension
02-003-00149	10" / 25.4cm
02-003-00150	14" / 35.5cm
02-003-00151	16" / 40.6cm



Silicon Spatula with Wooden Handle

Product Code	Dimension
02-003-00174	9.5 x 30.5cm
02-003-00072	12 x 33.5cm



CARLISLE Plastic Nylon Paddle Scraper with Nylon Handle

Product Code	Dimension	Colour
02-003-00102(XX)	40" / 101cm	<input type="checkbox"/> White



L' TELLIER Beechwood Crepe Spatula

Product Code	Dimension
02-003-00132	40cm

TABLECRAFT Plastic Icing Spatula with Rubber Blade

Product Code	Dimension
02-003-00158	9.5" / 24.1cm



TABLECRAFT High Heat Spatula

Product Code	Dimension	
02-003-00152	10 3/8" / 26cm	Resistant to 260°C
02-003-00153	14" / 35.5cm	Resistant to 260°C
02-003-00154	16 3/8" / 41.1cm	Resistant to 260°C



MATFER Pelton Spatula (6pcs/pkt)

Product Code	Dimension	
02-003-00143	30cm	Withstands up to 220°C



TABLECRAFT High Heat Spoon-Shaped Spatula

Product Code	Dimension	
02-003-00155	10 3/8" / 26cm	Resistant to 260°C
02-003-00156	14" / 35.5cm	Resistant to 260°C
02-003-00157	16 3/8" / 41.1cm	Resistant to 260°C



Stainless Steel Stirring Spatula

Product Code	Dimension
02-003-00180	24" / 64 x 12cm
02-003-00181	30" / 75.6 x 12cm
02-003-00182	36" / 90.5 x 12cm
02-003-00183	42" / 100.7 x 12cm
02-003-00184	48" / 124 x 12cm
02-003-00185	54" / 135.6 x 12cm
02-003-00186	60" / 150 x 12cm



Stainless Steel Heavy Solid Spatula

Product Code	Dimension
02-003-00191	52cm



L'TELLIER Beechwood Spatula

Product Code	Dimension
02-003-00133	25cm
02-003-00134	30cm
02-003-00135	35cm
02-003-00136	40cm
02-003-00137	50cm
02-003-00138	60cm



Dim Sum Bamboo Spatula (Haom-Tiew)

Product Code	Dimension
02-003-00175	21cm



MATFER Beechwood Spatula

Product Code	Dimension
02-003-00140(XX)	80cm
02-003-00139	100cm



Stainless Steel Heavy Perforated Spatula

Product Code	Dimension
02-003-00192	52cm



Stainless Steel Perforated Stirring Spatula

Product Code	Dimension
02-003-00187	42" / 100.7 x 12cm



LACOR Silicon Spatula with Thermometer Probe

Product Code	Dimension	Range
02-003-00020	29cm	-50°C to 300°C



Stainless Steel Slotted Spatula with Round Handle

Product Code	Dimension
02-003-00194	37cm



Stainless Steel Scraper with Black Handle

Product Code	Dimension
02-003-00176	25 x 10cm



L'TELLIER Beechwood Round Crepe Spreader

Product Code	Dimension
02-003-00130	18cm



L'TELLIER Beechwood Crepe Spreader

Product Code	Dimension
02-003-00131	24cm



Aluminium Pizza Peel with Wooden Handle

Product Code	Dimension
02-003-00163	30cm with Handle 50cm
02-003-00164	35cm with Handle 50cm



CARLISLE Plastic Nylon Paddle Scraper

Product Code	Dimension
02-003-00100(XX)	48"
02-003-00099(XX)	72"



SAN JAMAR Rapi-Kool Cold Paddles

Product Code	Capacity
02-003-00147	64oz
02-003-00146	128oz



Aluminium Pizza Shovel with Stainless Steel Pipe Handle

Product Code	Dimension
02-003-00165	Ø32 x L100cm



Stainless Steel One-Pc Perforated Basting Spoon

Product Code	Dimension
02-003-00188	46cm



Wooden Paddle

Product Code	Dimension
02-003-00203	18"
02-003-00198	24"
02-003-00199	30"
02-003-00200	36"
02-003-00201	48"
02-003-00202	60"



CCK Stainless Steel Wok Stand

Product Code	Dimension
02-003-00017	Ø11.4" 2 Ring



CCK Wooden Wok Hammer

Product Code	Dimension
02-003-00018	32cm



CCK HK Bamboo Wok Brush Heavy Duty

Product Code	Dimension
02-003-00016	10.5"



Stainless Steel Chinese Strainer with Coarse Wire Net & Bamboo Handle

Product Code	Dimension
02-003-00306	Ø5"
02-003-00307	Ø6"
02-003-00308	Ø7"
02-003-00309	Ø8"
02-003-00310	Ø9"
02-003-00311	Ø10"
02-003-00312	Ø11"
02-003-00313	Ø12"



CCK Stainless Steel Chinese Strainer with Stainless Steel Handle

Product Code	Dimension
02-003-00355	Ø7"
02-003-00356	Ø8"
02-003-00357	Ø9"
02-003-00358	Ø10"



Bamboo Wok Brush

Product Code	Dimension
02-003-00059	Ø3" x 11.5" - Ø4.5 x 29cm



SPARTA Potato Brush with Medium Firm Polyester Bristle

Product Code	Dimension	Colour
02-002-00494	6cm	<input type="checkbox"/> White



Stainless Steel Chinese Strainer with Stainless Steel Handle

Product Code	Capacity
02-003-00294	10.5"
02-003-00295	12"



Stainless Steel Chinese Strainer with Bamboo Handle

Product Code	Dimension
02-003-00314	Ø6"
02-003-00315	Ø7"
02-003-00316	Ø8"
02-003-00317	Ø9"
02-003-00318	Ø10"
02-003-00319	Ø11"
02-003-00320	Ø12"



CCK Stainless Steel Chinese Strainer with Bamboo Handle

Product Code	Dimension
02-003-00337	Ø7"
02-003-00338	Ø8"
02-003-00339	Ø9"
02-003-00340	Ø10"
02-003-00341	Ø11"
02-003-00342	Ø12"



LACOR 18-10 Stainless Steel Meshed Chinese Strainer / Chinois

Product Code	Dimension
02-003-00381	Ø20cm
02-003-00382	Ø22cm
02-003-00383	Ø24cm



CCK Steel Iron Chinese Strainer (Fine)

Product Code	Dimension
02-003-00346	Ø10"
02-003-00347	Ø11"
02-003-00348	Ø12"



LACOR 18-10 Stainless Steel Chinese Strainer / Chinois

Product Code	Dimension
02-003-00374	Ø14cm
02-003-00375	Ø16cm
02-003-00376	Ø18cm
02-003-00377	Ø20cm
02-003-00378	Ø22cm
02-003-00379	Ø24cm
02-003-00380	Ø26cm



Steel Iron Chinese Strainer with Coarse Wire Net

Product Code	Dimension
02-003-00301	Ø10"
02-003-00302	Ø11"
02-003-00303	Ø12"
02-003-00304	Ø13"
02-003-00305	Ø14"

DE BUYER Stainless Steel Strainer

Product Code	Dimension
02-003-00366(XX)	Ø10cm
02-003-00367(XX)	Ø16cm
02-003-00368(XX)	Ø18cm



LACOR Stainless Steel Mesh Conical Strainer

Product Code	Dimension
02-003-00390	Ø8cm
02-003-00391	Ø10cm
02-003-00392	Ø12cm
02-003-00393	Ø14cm
02-003-00394	Ø16cm
02-003-00395	Ø18cm



CCK Stainless Steel X'tra Long Handle Fine Mesh Strainer

Product Code	Dimension
02-003-00359	Ø14"
02-003-00360(XX)	Ø16"



LACOR 18-10 Stainless Steel Strainer

Product Code	Dimension	Capacity
02-003-00369	Ø20cm x H12cm	3.6ℓ
02-003-00370	Ø24cm x H14cm	6.5ℓ
02-003-00371	Ø28cm x H15cm	9.3ℓ



Stainless Steel Strainer Fine Mesh with Stainless Steel Handle

Product Code	Dimension
02-003-00296	10.5"
02-003-00297	12"



LACOR Stainless Steel Mesh Bowl Strainer

Product Code	Dimension
02-003-00396	Ø8cm
02-003-00384	Ø10cm
02-003-00385	Ø12cm
02-003-00386	Ø14cm
02-003-00387	Ø16cm
02-003-00388	Ø18cm
02-003-00389	Ø20cm
02-003-00397	Ø23cm



Stainless Steel Bowl Strainer with Black Handle

Product Code	Dimension
02-003-00282	6"
02-003-00283	7"
02-003-00284	8"
02-003-00285	10"



Stainless Steel Fine Mesh Bowl Strainer with Black Handle

Product Code	Dimension
02-003-00286	8"
02-003-00287	10"



Stainless Steel Double Mesh Bowl Strainer with Rosewood Handle

Product Code	Dimension
02-003-00288	16cm
02-003-00289	20cm
02-003-00290	25cm



Stainless Steel Tea Strainer with Red Handle

Product Code	Dimension
02-003-00406	Ø7cm
02-003-00407	Ø8cm
02-003-00408	Ø10cm



MATFER Exoglass Bouillon Strainer

Product Code	Dimension
02-003-00401	Ø20cm x H22cm



MATFER Holder for Bouillon Strainer

Product Code	Dimension
02-003-00402(XX)	Ø14/20 x H21.5cm



Stainless Steel Bouillon Strainer with Reinforced Bar

Product Code	Dimension
02-003-00409	Ø20 x 14cm
02-003-00410	Ø22 x 23cm



CCK Stainless Steel Noodle Strainer Square Holes with Bamboo Handle

Product Code	Dimension
02-003-00343	Ø10"
02-003-00344	Ø11"
02-003-00345	Ø12"



Stainless Steel Noodle Strainer Square Holes with Bamboo Handle

Product Code	Dimension
02-003-00330	Ø6"
02-003-00331	Ø7"
02-003-00332	Ø8"
02-003-00333	Ø9"
02-003-00334	Ø10"
02-003-00335	Ø11"
02-003-00336	Ø12"



CCK Stainless Steel Deep Noodle Strainer with Bamboo Handle

Product Code	Dimension
02-003-00364	Ø6"
02-003-00365	Ø6.5"



Stainless Steel Deep Noodle Strainer with Bamboo Handle

Product Code	Dimension
02-003-00321	Ø6"
02-003-00322	Ø6.5"



CCK Stainless Steel Deep Noodle Strainer with Stainless Steel Handle

Product Code	Dimension
02-003-00349	Ø5.5"
02-003-00350	Ø6"
02-003-00351	Ø6.5"



CCK CHINA Stainless Steel Deep Noodle Strainer with Stainless Steel & Bamboo Handle

Product Code	Dimension
02-003-00352	Ø5"
02-003-00353	Ø6"
02-003-00354	Ø6.5"



02-003-00444



02-003-00445



02-003-00281



02-003-00291



02-003-00298



02-003-00405



02-003-00411

Stainless Steel Noodle Strainer Square Holes with Bamboo Handle

Product Code	Dimension	Height of Basket	Full Product Length
02-003-00444	Ø11.5cm	14cm	36cm
02-003-00445	Ø13cm	15cm	37cm
02-003-00281	Ø13.5cm	16.5cm	36cm
02-003-00291	Ø14cm	15cm	36cm
02-003-00298	Ø14cm	14cm	37cm
02-003-00405	Ø14cm	15cm	37cm
02-003-00411	Ø14cm	11.5cm	36cm



Stainless Steel Fine Mesh Oil Strainer with Bamboo Handle

Product Code	Dimension
02-003-00323	Ø6"
02-003-00324	Ø7"
02-003-00325	Ø8"
02-003-00326	Ø9"
02-003-00327	Ø10"
02-003-00328	Ø11"
02-003-00329	Ø12"



Stainless Steel Meshed Conical Soup Strainer

Product Code	Dimension
02-003-00438	Ø15cm
02-003-00439	Ø17.5cm
02-003-00440	Ø20cm
02-003-00441	Ø22.5cm
02-003-00442	Ø25cm



Stainless Steel Herbal Basket Strainer

Product Code	Dimension
02-003-00446	Ø15 x H15cm
02-003-00447	Ø17.5 x H17.5cm
02-003-00448	Ø20 x H20cm
02-003-00449	Ø22.5 x H22.5cm
02-003-00451	Ø30 x H30cm



Stainless Steel Egg / Oil Strainer

Product Code	Dimension
02-003-00542	Ø14.6 x 4.6cm
02-003-00543	Ø18.2 x 5.8cm
02-003-00544	Ø21.5 x 6.6cm
02-003-00545	Ø23.5 x 7.5cm
02-003-00546	Ø27.5 x 8.7cm



CCK Stainless Steel Fine Soup Strainer with 2 Handles

Product Code	Dimension
02-003-00550	Ø12 x H4.75cm
02-003-00551	Ø13 x H5.5cm
02-003-00552	Ø14 x H5cm
02-003-00553	Ø15 x H5cm
02-003-00554	Ø16 x H5cm
02-003-00555	Ø18 x H5cm
02-003-00556	Ø20 x H5.5cm



Stainless Steel One-Pc Skimmer

Product Code	Dimension
02-003-00507	Ø8 x L36.5cm
02-003-00501	Ø10 x L42cm
02-003-00502	Ø12 x L48cm
02-003-00503	Ø14 x L53cm
02-003-00504	Ø16 x L58cm
02-003-00505	Ø18 x L63cm
02-003-00506	Ø20 x L67cm



Stainless Steel Ball Strainer

Product Code	Dimension
02-003-00452	Ø8.3cm
02-003-00453	Ø10cm
02-003-00454	Ø13cm
02-003-00455	Ø14.5cm



CCK Stainless Steel Egg Strainer with 2 Handles

Product Code	Dimension
02-003-00547	Ø8"
02-003-00548	Ø9"
02-003-00549	Ø10"



Stainless Steel Skimmer with Round Handle

Product Code	Dimension
02-003-00514	34.5cm



Stainless Steel Skimmer

Product Code	Dimension
02-003-00499	Ø4.3/4" x 14"
02-003-00500	Ø6" x 14"

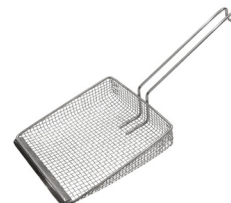

Stainless Steel Square Shape Japanese Style Skimmer

Product Code	Dimension
02-003-00456	17.5 x 42.5cm



Stainless Steel Half-Moon Shape Japanese Style Skimmer

Product Code	Dimension
02-003-00458	15.5 x 14.6cm



Stainless Steel Round Shape Japanese Style Skimmer

Product Code	Dimension
02-003-00457	20cm



ALEGACY Round Reinforced Fine Mesh Skimmer

Product Code	Dimension
02-003-00497	Ø6.1/2" - 16.5cm



LACOR Wire Mesh Skimmer

Product Code	Dimension
02-003-00481	Ø24cm
02-003-00482	Ø28cm



ALEGACY Square Reinforced Fine Mesh Skimmer

Product Code	Dimension
02-003-00498	L6.1/2" - 16.5cm



LACOR Stainless Steel One-Pc Wire Skimmer

Product Code	Dimension
02-003-00475	Ø14 x L51cm
02-003-00477	Ø16 x L53cm
02-003-00479	Ø18 x L62cm
02-003-00480	Ø20 x L62cm



Stainless Steel Fine Mesh Skimmer

Product Code	Dimension
02-003-00459	Ø15cm
02-003-00460	Ø16.5cm
02-003-00461	Ø19cm
02-003-00462	Ø21.5cm
02-003-00463	Ø24cm



Stainless Steel Oil Skimmer

Product Code	Dimension
02-003-00464	Ø22cm
02-003-00465	Ø24cm
02-003-00466	Ø26cm
02-003-00467	Ø28cm
02-003-00468	Ø30cm



Stainless Steel Wire Skimmer

Product Code	Dimension
02-003-00795	Ø13cm
02-003-00796	Ø15cm
02-003-00797	Ø18cm
02-003-00798	Ø20cm
02-003-00799	Ø24cm



CCK Stainless Steel Fine Mesh Oil Skimmer with Stainless Steel Handle

Product Code	Dimension
02-003-00495	Ø10"
02-003-00496	Ø12"



CCK Stainless Steel Sor-Hock / Oil Skimmer (Perforated)

Product Code	Dimension
02-003-00487	Ø9"
02-003-00488	Ø10"
02-003-00489	Ø11"
02-003-00490	Ø12"



CCK Stainless Steel Oil Skimmer (Big Hole)

Product Code	Dimension
02-003-00483	Ø9"
02-003-00484	Ø10"
02-003-00485	Ø11"
02-003-00486	Ø12"



CCK Stainless Steel Oil Skimmer / Sor-Hock Stand

Product Code	Dimension
02-003-00491	Ø7"
02-003-00492	Ø8"
02-003-00494	Ø10"



CCK TRIPOT Stainless Steel Wire Mesh Yam Cake Fryer

Product Code	Dimension
02-003-00526	Ø12"
02-003-00527	Ø14"
02-003-00528	Ø16"
02-003-00529	Ø18"



Wooden Handle for Skimmer / Wok

Product Code	Dimension	Thick
02-003-00522	8"	Thick



CCK TRIPOT Stainless Steel Yam Cake Flat Fryer

Product Code	Dimension
02-003-00530	Ø12"
02-003-00531	Ø14"
02-003-00532	Ø16"
02-003-00533	Ø18"



Stainless Steel Bird Nest Fryer

Product Code	Dimension
02-003-00523	Ø9cm
02-003-00524	Ø13cm
02-003-00525	Ø17cm



CCK Stainless Steel Deep Fry Wire Basket with 2 Baskets

Product Code	Dimension
02-003-00534	Ø20"
02-003-00535	Ø22"
02-003-00536	Ø24"





Stainless Steel Rectangle Deep Frying Basket

Product Code	Dimension
02-003-00541	22 x 20 x 13cm
02-003-00540	31 x 17 x 13cm



Rectangle Fry Basket

Product Code	Dimension
02-003-00537	13" x 6.1/2" x 5.1/4"
02-003-00538	13.3/8" x 5.1/2" x 5.1/4"



TABLECRAFT Taco Fry Basket

Product Code	Capacity
02-003-00539(XX)	Holds Eight 6" Taco Shells



Stainless Steel 1/1 GN Grid Fry Basket Premium

Product Code	Dimension
02-003-00809	53 x 32.5 x 3.7cm



Stainless Steel Water Scoop with Handle

Product Code	Dimension
02-003-00273	20cm



Stainless Steel Water Scoop Light Duty

Product Code	Dimension
02-003-00255	16 x 7cm
02-003-00256	18 x 7.5cm
02-003-00257	20 x 8.5cm



CCK S'PORE STYLE Stainless Steel Long Handle Scoop

Product Code	Dimension
02-003-00261	Ø3 x L16.2cm
02-003-00266	Ø3.5 x L16.8cm
02-003-00262	Ø4 x L17cm
02-003-00267	Ø4.5 x L17.6cm
02-003-00263	Ø5 x L18cm
02-003-00268	Ø5.5 x L18.6cm
02-003-00264	Ø6 x L19cm
02-003-00269	Ø6.5 x L19.6cm
02-003-00265	Ø7 x L20cm



CCK Stainless Steel Water Scoop

Product Code	Dimension	Capacity
02-003-00270	Ø18 x H8.5cm	3 Katis
02-003-00271	Ø19 x H9.5cm	4 Katis
02-003-00272	Ø20 x H10cm	5 Katis



Stainless Steel Water Scoop with Spout

Product Code	Dimension
02-003-00274	Ø16 x H8cm
02-003-00275	Ø18 x H9cm
02-003-00276	Ø20 x H8.8cm



Stainless Steel Water Scoop with Long Handle

Product Code	Dimension
02-003-00277	Ø18 x L45cm
02-003-00278	Ø18 x L60cm



Stainless Steel Star Shape Egg Ring

Product Code
02-003-00783



Stainless Steel Heart Shape Egg Ring

Product Code
02-003-00784



Stainless Steel Round Egg Ring

Product Code	Dimension
02-003-00779	Ø3"
02-003-00780	Ø3.5"
02-003-00781	Ø4"
02-003-00782	Ø4.5"



CCK Nylon Fish Net Aluminium Handle

Product Code	Dimension	
02-003-00791	Ø10"	#3
02-003-00790	Ø12"	#2
02-003-00789	Ø14"	#1



LAVA ECO Cast Iron Square Grill Steak Press / Weight

Product Code	Dimension
02-003-00741	21 x 21cm

*Please refer to Chapter 4 for Hamburger Press



SAN JAMAR Disposable T-Stick (+71°C)

Product Code	Capacity	Colour
02-003-00748	250pcs/pkt	Black

Disposable thermometer sticks for verifying minimum internal temperature



CCK Paper for Steaming Malay Cake

Product Code	Dimension	
02-003-00764	40 x 44cm	By packet



CCK Paper for Char Siew Bun

Product Code	Dimension	
02-003-00765	6.5 x 6.5cm	Approx. 3,800 pcs



CCK Paper for Steaming Sausage Roll

Product Code	Dimension
02-003-00766	2.5 x 4cm



CCK Paper for Steaming Big Bun

Product Code	Dimension
02-003-00767	9 x 9cm



CCK Herbal / Fish Bag

Product Code	Dimension
02-003-00768	11" x 13"
02-003-00769	12" x 12"
02-003-00770	15" x 15"
02-003-00771	10" x 12"



CCK Steaming Rice Bag

Product Code	Dimension
02-003-00773	Size 2



CCK Deep Frying Paper Bag

Product Code	Dimension	
02-003-00774	11.4 x 10cm	200pcs/pkt



CCK Fun Cheong Cloth

Product Code	Dimension
02-003-00772	22" x 16.8"



SAN JAMAR Cheese Cloth

Product Code	Dimension	
02-003-00776	7315 x 91cm	1 Roll
02-003-00777	183 x 183cm	1 Pack



Coconut Squeezer Bag

Product Code
02-003-00778



Wooden Cloth Peg

Product Code	
02-003-00775	Set of 36

**CCK** Stainless Steel 4-Prong Rice Fork

Product Code	Dimension
02-003-00610	11"

**LACOR** Stainless Steel 2-Prong Fork

Product Code	Dimension
02-003-00628	50 x 7cm

**LACOR** Stainless Steel 3-Prong Fork

Product Code	Dimension
02-003-00629(XX)	50 x 7cm



Stainless Steel Cooling Fork

Product Code	Dimension
02-003-00651	33 x 3.5cm



Wooden Rice Fork

Product Code	Dimension
02-003-00757	17" x 2"
02-003-00758	20" x 3"

**CLIFTON** Double Ended Tasting Spoon

Product Code	Dimension
02-003-00611	15cm
02-003-00612	18cm
02-003-00613	21cm

**DAUDIGNAC** Stainless Steel Deco Spoon

Product Code	Dimension
02-003-00614	2 Pcs Stainless Steelet with Wooden Handle
02-003-00615	2 Pcs Stainless Steelet with Stainless Steel Handle

**MATFER** Exoglass Spoon

Product Code	Dimension
02-003-00634	30cm
02-003-00635	38cm
02-003-00636	45cm Handle 20cm

**LACOR** Silicone Spoon with Thermometer Probe

Product Code	Dimension	Range
02-003-00632	29cm	-50° to 300°C

**MYE ACACIA-OILED** Wooden Spoon

Product Code	Dimension
02-003-00637	35 x 7cm



Stainless Steel One-Pc Basting Spoon

Product Code	Dimension
02-003-00652	46cm



ZEBRA Stainless Steel Basting Spoon

Product Code	Dimension
02-003-00646	Ø7 x L29cm



Stainless Steel One-Pc Basting Spoon

Product Code	Dimension
02-003-00647	13"
02-003-00648	15"



Stainless Steel Basting Spoon with Bakelite Handle

Product Code	Dimension
02-003-00649	13"
02-003-00650	15"



Stainless Steel Perforated Basting Spoon

Product Code	Dimension
02-003-00653	13"
02-003-00654	15"



Stainless Steel Perforated Basting Spoon with Bakelite Handle

Product Code	Dimension
02-003-00655	13"
02-003-00656	15"



Stainless Steel Slotted Basting Spoon

Product Code	Dimension
02-003-00657	13"
02-003-00658	15"



Stainless Steel Slotted Basting Spoon with Bakelite Handle

Product Code	Dimension
02-003-00659	13"
02-003-00660	15"



LACOR Stainless Steel One-Pc Perforated Basting Spoon

Product Code	Dimension
02-003-00631	Ø7.5 x L47cm



LACOR Stainless Steel One-Pc Horizontal Basting Spoon

Product Code	Dimension
02-003-00633(XX)	Ø7.5 x L34cm



LACOR *Stainless Steel One-Pc Solid Basting Spoon*

Product Code	Dimension
02-003-00630	Ø7.5 x L47cm



LACOR *Stainless Steel Baster with Syringe & Cleaning Brush*

Product Code	Dimension
02-003-00749	30cm



LACOR *Stainless Steel Burger Tong*

Product Code	Dimension
02-003-00702	24cm



EDLUND *Stainless Steel Heavy Duty Grip Tong*

Product Code	Dimension
02-003-00689	10"
02-003-00691	12"
02-003-00693	16"



EDLUND *Stainless Steel Heavy Duty Grip Tong with Lock*

Product Code	Dimension
02-003-00690	10"
02-003-00692	12"
02-003-00694	16"



EDLUND *Stainless Steel Heavy Duty Scallop Tong*

Product Code	Dimension
02-003-00697	9"
02-003-00695	12"
02-003-00696	16"



EDLUND *Stainless Steel Heavy Duty Scallop Tong with Lock*

Product Code	Dimension
02-003-00700	9"
02-003-00698	12"
02-003-00699	16"



WESTMARK *High Heat Double Turner & Kitchen Tongs*

Product Code	Dimension	
02-003-00705	29.5cm	Heat resistant up to 210°C/ 410°F



Stainless Steel Oven Tray Grip Tong with Rubber

Product Code	Dimension
02-003-00710	19cm



Multi Purpose Grips

Product Code	Dimension
02-003-00708	18.5cm



Stainless Steel Scallop Tong with Plastic Handle

Product Code	Black	Yellow	Red	Green	Blue
9.5"	02-003-00667	02-003-00668	02-003-00669	02-003-00670	02-003-00671
12"	02-003-00672	02-003-00673	02-003-00674	02-003-00675	02-003-00676
16"	02-003-00677		02-003-00678	02-003-00679	02-003-00680

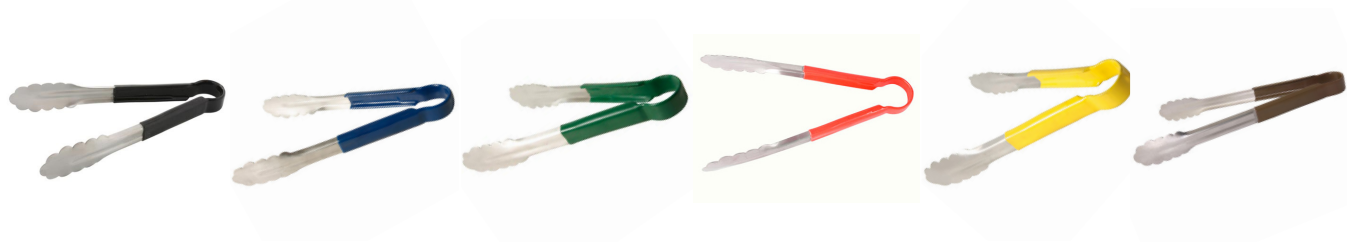

Stainless Steel Scallop Tong with Plastic Handle

Product Code	Black	Blue	Green	Red	Yellow	Brown
23cm	02-003-00711	02-003-00712	02-003-00713	02-003-00714	02-003-00715	02-003-00716
30.5cm	02-003-00717	02-003-00718	02-003-00719	02-003-00720	02-003-00721	02-003-00722
40.6cm	02-003-00723	02-003-00724	02-003-00725	02-003-00726	02-003-00727	



Stainless Steel Steak Tong

Product Code	Dimension
02-003-00728	15"
02-003-00729	46.5cm



Stainless Steel Utility Tong

Product Code	Dimension
02-003-00731	9"
02-003-00732	12"
02-003-00733	16"



Stainless Steel Utility Tong with Locking Ring

Product Code	Dimension
02-003-00734	9"
02-003-00735	12"
02-003-00736	16"



MASTRAD Stainless Steel Silicone Quick Tongs

Product Code	Dimension	Colour
02-003-00816	38cm	Black



MASTRAD Stainless Steel Silicone Express Tongs

Product Code	Dimension	Colour
02-003-00817	28cm	Black
02-003-00819	28cm	Green
02-003-00820	28cm	Red

MASTRAD Stainless Steel Silicone Multi-Purpose Tongs

Product Code	Dimension	Colour
02-003-00812	26cm	Black
02-003-00814	26cm	Green
02-003-00815	26cm	Red



CLIFTON *Stainless Steel Fine Tip Micro Tweezers*

Product Code	Dimension
02-003-00683	13cm
02-003-00682	16cm



CLIFTON *Stainless Steel Sushi Tweezer*

Product Code	Dimension
02-003-00688	14.5cm
02-003-00687	20cm



CLIFTON *Stainless Steel Round Tip Micro Tweezers*

Product Code	Dimension
02-003-00684	13cm
02-003-00685	16cm
02-003-00686	30cm



WESTMARK *Stainless Steel Pincer Tong*

Product Code	Dimension
02-003-00704	29cm



GIESSER *Fish Pincer*

Product Code	Dimension
02-003-00701	16.2cm



Stainless Steel Tweezer Flat

Product Code	Dimension
02-003-00730	10.5cm



CCK *Stainless Steel Duck Feather Tweezer*

Product Code	Dimension
02-003-00681	15.5cm



Long Bamboo Chopstick

Product Code	Dimension
02-003-00737	18"



Wooden Long Chopstick

Product Code	Dimension
02-003-00738	43cm



CCK Wooden Chopstick

Product Code	Dimension
02-003-00739	20"



Bamboo Chopsticks

Product Code	Dimension	
02-003-00740	10"	10 pairs/pkt



LACOR Stainless Steel Extra 8 Whisk

Product Code	Dimension
02-003-00558	25cm
02-003-00559	30cm
02-003-00560	35cm
02-003-00561	40cm
02-003-00562	45cm
02-003-00563	50cm
02-003-00564	55cm
02-003-00565	60cm



LACOR Stainless Steel Super 12 Whisk

Product Code	Dimension
02-003-00569	25cm
02-003-00570	30cm
02-003-00571	35cm
02-003-00572	40cm
02-003-00573	45cm
02-003-00574	50cm



LACOR Stainless Steel Whisk with Fibreglass Handle

Product Code	Dimension
02-003-00575	25cm
02-003-00576	30cm
02-003-00577	35cm
02-003-00578	40cm
02-003-00579	45cm
02-003-00580	50cm



DE BUYER Stainless Steel 8-Wire Whisk with Non-Slip Handle

Product Code	Dimension
02-003-00581	25cm
02-003-00582	30cm
02-003-00583	35cm
02-003-00584	40cm
02-003-00585	45cm
02-003-00586	50cm



MATFER Exoglass Piano Whisk

Product Code	Dimension	Handle
02-003-00590	25cm	10cm
02-003-00591	30cm	11cm
02-003-00592	35cm	13cm
02-003-00593	40cm	16cm
02-003-00594	45cm	20cm
02-003-00595	50cm	26cm



LACOR Stainless Steel Kettle Whisk

Product Code	Dimension
02-003-00566	100cm
02-003-00567	120cm



SUNNEX Stainless Steel 12-Wire Egg Whisk with U-Hook

Product Code	Dimension
02-003-00598	25cm
02-003-00599	30cm
02-003-00600	35cm
02-003-00601	40cm
02-003-00602	45cm



SUNNEX Stainless Steel 8-Wire French Whisk with U-Hook

Product Code	Dimension
02-003-00603	25cm
02-003-00604	30cm
02-003-00605	35cm
02-003-00606	40cm
02-003-00607	45cm



MATFER Exoglass Rigid Wires Whisk

Product Code	Dimension	Handle
02-003-00596	40cm	16cm
02-003-00597	45cm	20cm

Special for mayonnaise and other stiff creams



LACOR Stainless Steel Mini Whisk

Product Code	Dimension
02-003-00568	20cm



IBILI Stainless Steel Mini Whisk

Product Code	Dimension
02-003-00589	15cm



Chrome-Plated Mini Whisks with Ring

Product Code	Dimension
02-003-00609	4pcs/set



Stainless Steel Pastry Blender / Masher with Plastic Handle

Product Code	Dimension
02-003-00608	11.7 x 11.5cm



LACOR Stainless Steel Wall Hanger for Utensils with Hooks

Product Code	Dimension	
02-003-00785	100cm	For 12 Hooks
02-003-00786	60cm	For 8 Hooks



Stainless Steel Cutlery Holder

Product Code	Dimension
02-003-00788	Ø10 x 17cm



Stainless Steel Bean Curd Pail / Bucket with Lid

Product Code	Dimension	Capacity
02-004-00008	Ø26 x H26cm	10ℓ
02-004-00009	Ø29 x H29cm	15ℓ
02-004-00010	Ø32 x H32cm	20ℓ
02-004-00020(XX)	Ø35 x H35cm	28ℓ



Wooden Round Bean Curd Bucket with Lid (Excludes Stainless Steel Insert)

Product Code	Dimension
02-004-00011	Ø14 x H14.5cm
02-004-00012	Ø16 x H15cm
02-004-00013	Ø18 x H15.5cm
02-004-00014	Ø20 x H18cm



CCK Stainless Steel Bean Curd Scoop with Wooden Handle

Product Code	Dimension
02-004-00016	19 x 8cm



CCK Stainless Steel Bean Curd Scoop with Stainless Steel Handle

Product Code	Dimension	Handle
02-004-00015	10.1 x 9.9cm	4"



CCK Stainless Steel Bean Curd Scoop without Handle

Product Code	Dimension
02-004-00017	14 x 11cm



Stainless Steel Square Bean Curd Box

Product Code	Dimension
02-004-00018	24 x 24 x 5cm
02-004-00019	27 x 27 x 5cm



CCK Stainless Steel Stool

Product Code	Dimension
02-004-00021	14" x 12" x 10"



CCK Stainless Steel Maltose Box with Cover

Product Code	Dimension
02-004-00022	48 x 32 x 28cm
02-004-00024(XX)	53 x 35 x 31cm



CCK Stainless Steel Maltose Box Stand for 02-004-00022

Product Code	Dimension
02-004-00023	54.5 x 3 x 112.5cm



CCK Stainless Steel Maltose Box Stand for 02-004-00024

Product Code	Dimension
02-004-00025(XX)	60 x 35 x 112cm



Tempura Chopstick, Rose Wood Handle

Product Code	Dimension
02-004-00033	35cm
02-004-00034	42cm



Bamboo Sushi Mat

Product Code	Dimension
02-004-00036	24 x 24cm



L'TELLIER Stainless Steel Cream Whipper Gastro

Product Code	Dimension	Capacity
02-004-00001	28cm / 550g	0.5l
02-004-00002	35cm / 800g	1.0l



MOSA N2O Cream Charger

Product Code	Dimension
02-004-00006	10pcs/pkt



CCK Stainless Steel Maltose Box Stand with Wheel

Product Code	Dimension
02-004-00026(XX)	54.5 x 32 x 112cm



Bamboo Sushi Mat 5-Thread

Product Code	Dimension
02-004-00035	27 x 18cm



Round Wooden Sushi Rice Basin

Product Code	Dimension
02-004-00028	Ø45cm
02-004-00029	Ø48cm
02-004-00030	Ø52cm
02-004-00031	Ø60cm
02-004-00032	Ø72cm



MOSA Stainless Steel Cream Whipper

Product Code	Capacity
02-004-00004	0.5l
02-004-00005	1.0l



MOSA Aluminium Soda Siphon with Plastic Head Set

Product Code	Capacity	Colour
02-004-00041	1.0l	■ Black
02-004-00042	1.0l	□ Silver
02-004-00043	1.0l	□ White



MOSA CO2 Soda Charger

Product Code	Quantity
02-004-00003	10pcs/pkt



L'TELLIER Stainless Steel Egg Cracker

Product Code	Dimension
02-004-00038	Ø6.5 x L10cm



METTLER TOLEDO Digital Platform Scales

Product Code	Platform Size	Maximum Load	Increment
02-005-00015(XX)	30.5 x 35.5cm	30kg	10g
02-005-00016(XX)	30.5 x 35.5cm	60kg	20g
02-005-00017(XX)	42 x 55cm	150kg	50g
02-005-00018(XX)	42 x 55cm	300kg	50g
02-005-00019(XX)	42 x 55cm	60kg	10g
02-005-00020(XX)	60 x 80cm	600kg	100g



EDLUND Digital Portion Control Scale

Product Code	Dimension	Max. Load	Increment
02-005-00009	25 x 18 x 6cm	5kg	1g

Plastic body with stainless steel platform



ADE GERMANY KYLIE Digital Kitchen Scale

Product Code	Dimension	Max. Load	Increment
02-005-00001(XX)	14 x 23.5 x 1.3cm	5kg	1g

Kylie Silver-Grey / Black Range



L'TELLIER Stainless Steel Egg Knocker

Product Code	Dimension
02-004-00037	11cm



WESTMARK Stainless Steel Egg Shell Cutter

Product Code	Dimension
02-004-00039	9 x 8 x 1cm



Digj 2-Sided Digital Weighing Scale

Product Code	Maximum Load	Increment
02-005-00005	3kg	0.5g
02-005-00006	6kg	1g
02-005-00007	15kg	2g
02-005-00008	30kg	5g



TANITA Digital Weighing Scale

Product Code	Dimension	Max. Load	Increment
02-005-00024	18.3 x 25.5 x 6.8cm Platform: 18.3 x 18.3cm	1kg	1g
02-005-00025	18.3 x 25.5 x 6.8cm Platform: 18.3 x 18.3cm	2kg	2g
02-005-00026	18.3 x 25.5 x 6.8cm Platform: 18.3 x 18.3cm	5kg	5g

4 x AA batteries (Not included)



ADE GERMANY ANJA Digital Kitchen Scale

Product Code	Dimension	Max. Load	Increment
02-005-00002	Ø16.5 x 2.2cm	5kg	1g

Anja Silver-Grey / Black Range



ADE GERMANY SLIM Digital Kitchen Scale

Product Code	Dimension	Max. Load	Increment
02-005-00004	23 x 15 x 1.2cm	5kg	1g

Slim White Range



TANITA Digital Weighing Scale with Plastic Bowl

Product Code	Dimension	Max. Load	Increment
02-005-00022	20 x 15 x 4cm Bowl: Ø6.2 x 18cm	2kg	1g



MIKI Electric Pocket Digital Scale

Product Code	Dimension	Max. Load	Increment
02-005-00021	62.2 x 53.7mm	500g	0.01g

Battery and pouch included.



ORCHID FLAT TOP Weighing Scale

Product Code	Dimension	Max. Load	Increment
02-005-00078	23.5 x 19 x 22cm	2kg	25g
02-005-00079	23.5 x 19 x 22cm	2kg	10g
02-005-00080	30 x 20 x 26.5cm	5kg	20g
02-005-00081	30 x 20 x 26.5cm	5kg	25g
02-005-00082	30 x 28 x 26cm	10kg	50g
02-005-00083	30 x 28 x 26cm	12kg	50g
02-005-00084	30 x 28 x 26cm	12kg	50g
02-005-00085	30 x 28 x 26cm	12kg	50g
02-005-00086	30 x 28 x 26cm	12kg	50g
02-005-00087	31 x 25 x 26.5cm	20kg	100g
02-005-00088	31 x 25 x 26.5cm	20kg	100g
02-005-00089	31 x 25 x 26.5cm	30kg	100g
02-005-00090	31 x 25 x 26.5cm	30kg	100g



Plastic Electronic Digital Scale with Bowl

Product Code	Dimension	Max. Load	Increment
02-005-00027	Ø20.5 x H11cm	3kg	1g

Using AAA Battery. Not included.



Electronic Digital Scale with Glass Plate

Product Code	Maximum Load	Increment
02-005-00028	5kg	1g

Battery not included.



ORCHID FLAT TOP Weighing Scale

Product Code	Dimension	Max. Load	Increment
02-005-00067	23.5 x 19 x 22cm	2kg	25g
02-005-00068	30 x 20 x 26.5cm	5kg	20g
02-005-00069	30 x 20 x 26.5cm	5kg	25g
02-005-00070	30 x 28 x 26cm	10kg	50g
02-005-00071	30 x 28 x 26cm	15kg	50g
02-005-00072	31 x 25 x 26.5cm	20kg	100g
02-005-00073	31 x 25 x 26.5cm	20kg	100g
02-005-00074	31 x 25 x 26.5cm	30kg	100g
02-005-00075	31 x 25 x 26.5cm	30kg	100g
02-005-00076	37 x 30 x 36cm	50kg	100g
02-005-00077	35 x 25 x 38cm	100kg	200g



CCK Stainless Steel Kitchen Scale Round Plate

Product Code	Maximum Load	Increment
02-005-00041	15kg	50g



CCK Weighing Scale

Product Code	Maximum Load	Increment
02-005-00038	20lbs	15kt
02-005-00039	26lbs	20kt



LACOR Chrome Weighing Scale with Plastic Bowl

Product Code	Maximum Load	Increment
02-005-00032	1kg	5g



LACOR Stainless Steel Weighing Scale with Bowl

Product Code	Dimension	Max. Load	Increment
02-005-00033	Ø20 x H13.5cm	3kg	25g



Plastic Weighing Scale

Product Code	Maximum Load	Increment
02-005-00091	1kg	5g
02-005-00092	2kg	10g
02-005-00093	5kg	100g
02-005-00037	5lbs	3.75 katis

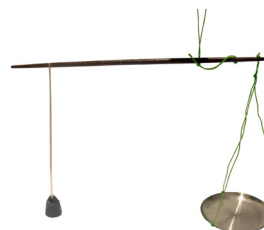

CCK Chinese Dim Sum Scale

Product Code
02-005-00036



COOPER ATKINS 2 Mini Loggers with Mount

Product Code	Dimension	Range
02-005-00096	5 x 6.7cm	-40°C to 85°C

Records at specific intervals from 1 min. to 4hrs.
Water resistant. 2pcs/pkt



COOPER ATKINS Digital Thermometer Hygrometer

Product Code	Dimension	Range
02-005-00099	10.5 x 6.4 x 1.5cm	-10°C to 50°C, 10 to 99% RH



COOPER ATKINS Digital Hygrometer Wall / Desk Mount

Product Code	Range
02-005-00100(XX)	Temp. 0°C to 50°C Humidity 25% - 90% RH

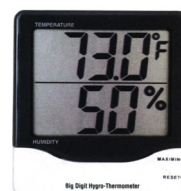

BLUE GIZMO Big Display Thermo-Hygrometer

Product Code	Dimension	Range
02-005-00097	11 x 10cm	-10°C to +60°C / Accuracy: +-1°C Humidity: 10% - 99% R.H. +-5% R.H.



BLUE GIZMO Analog Thermo-Hygrometer

Product Code	Dimension	Range
02-005-00098	16cm	0°C to +120°C Humidity 0% to 100% Accuracy Temp: +-1°Cm Humidity: +-5%rH



COOPER ATKINS Infrared & Probe Thermometer

Product Code	Dimension	Range
02-005-00107	4.5 x 2.5 x 15.7cm	Infra -33°C to 220°C / -27°F to 428°F Probe -55°C to 330°C / -67°F to 626°F



BLUE GIZMO 2-in-1 Non-Contact Infrared Thermometer with Probe

Product Code	Dimension	Range
02-005-00103	16.4 x 4.5 x 2cm	-33°C to +220°C / Accuracy below -5°C +1°C, -5°C - 65°C +0.5°C, above 65°C +1% of reading



BLUE GIZMO Noncontact Infrared Thermometer

Product Code	Dimension	Range
02-005-00102		-35°C to +630°C / Accuracy +2.5°C from -35°C to 0°C, +1.5°C from 0°C - 100°C, +2°C from 100°C - 630°C
02-005-00104	18 x 13 x 4cm	-32°C to +535°C / Accuracy +3°C for -32°C - 20°C, +2°C for 20°C - 100°C, +2% above 100°C



COOPER ATKINS Infrared Thermometer with Laser Sighting

Product Code	Dimension	Range
02-005-00105	5.5 x 3.5 x 18.5cm	-40°C to 280°C / -40°F to 536°F



COOPER ATKINS Mini Infrared Pocket Thermometer

Product Code	Dimension	Range
02-005-00106	4 x 1.5 x 7cm	-33°C to 220°C



COOPER ATKINS Infrared Gun-Style Thermometer w/ Thermocouple Jack

Product Code	Range
02-005-00108(XX)	-60°C to 500°C



CLIFTON Sous Vide Thermometer & Probe Kit

Product Code	Dimension	Range
02-005-00112	12.7cm	-99°C to 299.9°C



WESTMARK Digital Wireless Roasting Thermometer

Product Code	Dimension	Range
02-005-00130	7.5 x 5.5 x 1.3cm Wire 10.5cm	0°C to 250°C

Mobile receiver range up to 30m



COOPER ATKINS Aquatuff Waterproof Thermocouple

Product Code	Dimension	Range
02-005-00094(XX)	16.5 x 5.7 x 3.2cm	-73°C to 537°C



COOPER ATKINS Needle Probe with Stainless Steel Braided Cable Type K Thermocouple

Product Code	Range
02-005-00162	-40°C to 260°C 1 Year Warranty



COOPER ATKINS Waterproof Digital Pocket Test Thermometer

Product Code	Dimension	Range
02-005-00116	12.7cm	-40°C to 232°C



COOPER ATKINS *Electronic Stem Thermometer*

Product Code	Dimension	Range
02-005-00117	12.7cm	-40°C to 150°C



COOPER ATKINS *Digital Waterproof Pocket Probe Test Thermometer*

Product Code	Dimension	Range
02-005-00118(XX)	7cm	-40°C to 200°C



BLUE GIZMO *Digital Pocket Thermometer*

Product Code	Dimension	Range
02-005-00109	9cm	-40°C to +200°C / Accuracy +/- 1°C
02-005-00111	17cm	-10°C to +200°C / Accuracy +/- 1°C



Digital Pocket Test Thermometer

Product Code	Range	Battery included
02-005-00120	-50°C to 300°C	Battery included



COOPER ATKINS *Needle Probe Type K Thermometer*

Product Code	Dimension	Range
02-005-00095(XX)	Shaft: 10cm Cable: 61cm	-40°C to 205°C . Response time: 4s



COOPER ATKINS *Test Thermometer*

Product Code	Dimension	Range
02-005-00115	20.3cm	-10°C to 100°C



COOPER ATKINS *Espresso Thermometer with Clip*

Product Code	Dimension	Range
02-005-00142	17.8cm	-10°C to 104°C



COOPER ATKINS *Pocket Test Thermometer*

Product Code	Dimension	Range
02-005-00113	12.7cm	-20°C to 100°C
02-005-00114	12.7cm	10°C to 285°C



COOPER ATKINS *Digital Refrigerator / Freezer Thermometer*

Product Code	Dimension	Range
02-005-00132	9 x 1.3 x 8.6cm	-30°C to 50°C



BLUE GIZMO *Digital Freezer Fridge Thermometer with Frame*

Product Code	Range
02-005-00131	-30°C to +50°C / Accuracy: +/- 0.8°C for -20°C - +10°C, +/- 1°C otherwise



COOPER ATKINS *Refrigerator / Freezer Thermometer*

Product Code	Dimension	Range
02-005-00133	Ø5.1cm	-29°C to 27°C/ Accuracy: +/- 1°C

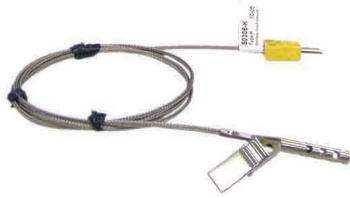

COOPER ATKINS Air Probe for Oven or Cooler / Freezer with Clip

Product Code	Range	
02-005-00161	-74°C to 315°C	1 Year Warranty



COOPER ATKINS Refrigerator / Freezer Thermometer Horizontal Glass Tube

Product Code	Dimension	Range
02-005-00136	12.7cm	-40°C to 25°C



COOPER ATKINS Cooler Thermometer

Product Code	Dimension	Range
02-005-00139	Ø3.8cm	-30°C to 50°C



COOPER ATKINS Coolit-Rite Digital Waterproof Cooling Validator

Product Code	Dimension	Range
02-005-00140	46.6cm	-20°C to 150°C Timer range 6hrs59mins



COOPER ATKINS Oven Thermometer

Product Code	Dimension	Range
02-005-00126	5cm	50°C to 300°C



COOPER ATKINS Refrigerator / Freezer Thermometer

Product Code	Dimension	Range
02-005-00135	7.6cm	-40°C to 50°C



COOPER ATKINS Refrigerator / Freezer Thermometer (2pcs/pkt)

Product Code	Dimension	Range
02-005-00134	Ø5.1cm	-29°C to 27°C/ Accuracy: +1°C



COOPER ATKINS Professional Stainless Steel Cooling Thermometer

Product Code	Dimension	Range
02-005-00138	46.6cm	30°F to 165°F / Accuracy +2°F



COOPER ATKINS Vessel Clip for Monitoring Thermometers

Product Code	
02-005-00123	



COOPER ATKINS Oven Thermometer (2pcs/pkt)

Product Code	Dimension	Range
02-005-00127	5cm	50°C to 300°C



COOPER ATKINS Cast Aluminium Grill Thermometer

Product Code	Dimension	Range
02-005-00129	Ø6.35cm	50°C to 300°C



COOPER ATKINS Hot Holding Thermometer

Product Code	Dimension	Range
02-005-00143	Ø5.1cm	40°C to 80°C



COOPER ATKINS Hot Holding Cabinet Thermometer (2pcs/pkt)

Product Code	Dimension	Range
02-005-00144	Ø5.1cm	40°C to 80°C



COOPER ATKINS Candy / Jelly / Deep Fry Thermometer

Product Code	Dimension	Range
02-005-00121	15.2cm	90°C to 200°C



L'TELLIER Candy Thermometer

Product Code	Range	
02-005-00124	+80°C +200°C / 1°C graduation	Plastic Housing



L'TELLIER Candy Thermometer

Product Code	Range	
02-005-00125	+80°C +200°C / 1°C graduation	Stainless Steel Housing



COOPER ATKINS Tank / Kettle / Deep Fry Thermometer

Product Code	Dimension	Range
02-005-00122	38.1cm	10°C to 285°C



COOPER ATKINS Meat Thermometer

Product Code	Dimension	Range
02-005-00141	15.2cm	54°C to 88°C



WESTMARK Tin-Plated Canning Thermometer

Product Code	Dimension	Range
02-005-00147	42 x 4 x 4cm	60°C to 110°C



L'TELLIER Baker Thermometer (Plastic Holding)

Product Code	Dimension	Range
02-005-00145	35.5cm	-10°C to 60°C / 1°C graduation



MATFER Baker Thermometer

Product Code	Dimension	Range
02-005-00146	17cm	0°C to 60°C



MATFER Stainless Steel Test Tube for Density Meter

Product Code	Dimension	Range
02-005-00149(XX)	Ø3.6 x 17.5cm	17.5cl



ATAGO Digital Hand-Held Refractometer

Product Code	Dimension	Range
02-005-00152	3.1 x 5.5 x 10.9cm	(BRIX 0.0-53%) Accuracy +0.2%
02-005-00154(XX)	3.1 x 5.5 x 10.9cm	(BRIX 0.0-25%)



COOPER ATKINS 24 Hours Large Timer with Memory

Product Code	Dimension
02-005-00155	17.8 x 10.2 x 14.1cm



COOPER ATKINS Digital Solar Panel Thermometer

Product Code	Dimension	Range
02-005-00137	11.5cm	-50°C to 70°C



ATAGO Water-Resistant Refractometer

Product Code	Dimension	Range
02-005-00150	3.2 x 3.4 x 16.8cm	(BRIX 0.0-53%) Accuracy +0.5%

x1pc Small size 19cm, x1pc Large size 23cm



COOPER ATKINS Electric Timer / Stopwatch with Lanyard Rope

Product Code	Dimension	Range
02-005-00156	Ø6cm	Up to 99mins59s



COOPER ATKINS Waterproof Digital Timer with Large LCD

Product Code	Dimension	Range
02-005-00157	8.3 x 7.6 x 2.5cm	Up to 99mins59s



Digital Timer

Product Code	Range
02-005-00160	Up to 99mins