



Operating Manual



WHISPER



M-Series



MB-Series



MS-Series

Precision Gas Mass Flow Meters

The Fastest Flow Controller Company in the World!



RECALIBRATION

Your Alicat instrument is a precision device and Alicat strongly recommends that you send it to us on a yearly basis for recalibration.

A yearly recalibration does a few things:

- ▶ It insures that your unit is functioning according to specification.
- ▶ Contamination may cause the instrument to measure flow improperly. Recalibration insures the instrument is clean and free from debris.
- ▶ Recalibration maintains your LIFETIME WARRANTY!

Sending your unit for recalibration is easy and inexpensive. Recalibrations are usually shipped within five days of receipt, so it's fast too.

Please keep the original box to return your Alicat instrument for recalibration.

For more information regarding recalibration see page 34.

ACCESSORIES

Now that you have your Alicat instrument are you sure you've got everything you need? Alicat accessories can make your job easier.

Many of our customers also order:

- ▶ Power Supplies — A universal wall power supply that makes it easy to power your Alicat unit just about anywhere in the world.
- ▶ BB9 — Alicat's multi-drop box that allows easy connection of up to nine Alicat instruments to a single USB, RS-232 or RS-485 port.
- ▶ MD8DB9 — An RS-232 to 8 pin Mini-DIN cable to connect your Alicat instrument to a computer. A variety of other cables are also available.
- ▶ Flow Vision™ SC — A GUI based Windows® program that allows easy computer access and control for one or multiple Alicat instruments.
- ▶ Fittings and filters — Keep your instrument properly connected to your process and free from harmful contamination.

See pages 39-42 for a complete description and list of Alicat accessories.

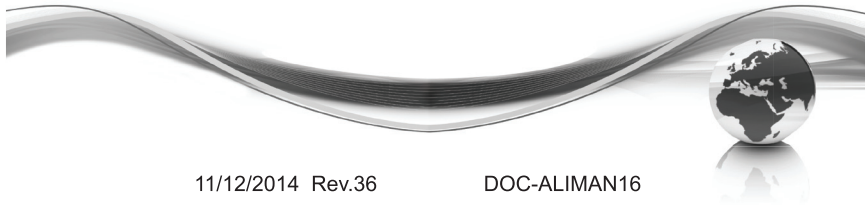

Thank you for purchasing an Alicat Gas Flow Meter.

Please take the time to read the information contained in this manual. This will help to ensure that you get the best possible service from your instrument. This manual covers the following Alicat Scientific instruments:

M-Series Mass Gas Flow Meters

WHISPER Low Pressure Drop Mass Flow Meters

MS-Series Mass Gas Flow Meters

MS-Series Flow Meters are for use with certain aggressive gases (see page 59).

This includes M-Series devices labeled as approved for CSA Class 1 Div 2 and ATEX Class 1 Zone 2 hazardous environments. See pages 79 and 80 for Special Conditions regarding the use of CSA/ATEX labeled devices.

MB-Series Portable Mass Gas Flow Meters

WHISPER Portable Low Pressure Drop Mass Gas Flow Meters

All MB-Series and Whisper Portable Gas Flow Meters operate in accordance with the instructions found in this manual. Please see page 38 for information regarding portable meter operation.

Unless otherwise noted, the instructions in this manual are applicable to all of the above instruments.

Full specifications for each device can be found on pages 50 through 64.



Please contact Alicat at 1-888-290-6060 or info@alicat.com if you have any questions regarding the use or operation of this device.



Many Alicat meters are built for specific applications. Two meters with the same flow range and part number may look and act quite differently depending upon the application the meter was built for. Care should be taken when moving a meter from one application to another.



You can find a number of instructional videos related to the operation of this device by visiting the Alicat web site or scanning the QR code below.

<http://www.alicat.com/support/instructional-videos/>



TABLE OF CONTENTS	Page
GETTING STARTED	6
MOUNTING	6
PLUMBING	7
POWER AND SIGNAL CONNECTIONS	8
INPUT SIGNALS	9
Analog Input Signal	9
RS-232 / RS-485 Digital Input Signal	10
OUTPUT SIGNALS	11
RS-232 / RS-485 Digital Output Signal	11
Standard Voltage (0-5 Vdc) Output Signal	11
Optional 0-10 Vdc Output Signal	11
Optional Current (4-20 mA) Output Signal	11
Optional 2nd Analog Output Signal	11
Information for Alicat TFT (Color Display) Instruments	13
DISPLAYS AND MENUS	14
MAIN	15
Gas Absolute Pressure	15
Gas Temperature	15
Tare	15
Volumetric Flow Rate	16
Mass Flow Rate	16
<i>Flashing Error Message</i>	16
SELECT MENU	17
GAS SELECT	18
Composer	19
COMMUNICATION SELECT	21
Unit ID	21
Baud	21
MISCELLANEOUS	22
MISC1	22
Zero Band	22
Pressure Averaging	22
Flow Averaging	22
LCD Contrast	20
MISC2	23
Standard Temperature and Pressure	23
DIAG TEST	24
Rotate Display	24
MANUFACTURER DATA	24
RS-232 or RS-485 Output and Input	25
Configuring HyperTerminal®	25
Streaming Mode	25
Tareing via RS-232 or RS-485	26
Changing from Streaming to Polling Mode	26

TABLE OF CONTENTS	Page
Gas Select	27
Creating and Deleting Gas Mixtures using RS-232 or RS-485	28
Collecting Data	29
Data Format	29
Sending a Simple Script File to HyperTerminal®	30
Operating Principle	31
Standard Gas Data Tables	31
Gas Lists with Viscosities, Densities and Compressibilities	33
Troubleshooting	41
Maintenance and Recalibration	42
Option: Totalizing Mode	43
Option: Portable Meters and Gauges	44
Option: Remote Electronics	45
Option: Remote Panel Display	45
Accessory: BB9 Multi-Drop Box	46
Accessory: Flow Vision™ SC	47
Accessory: Flow Vision™ MX	47
Accessories	48
M-Series Technical Specifications	50
WHISPER Technical Information	55
MS-Series Technical Information	59
PROFIBUS Technical Specifications and Pin-out Diagram	64
Eight Pin Mini-DIN Pin-Out	65
Locking Industrial Connector Pin-Out	66
DB9 Pin-Out Diagrams	67
DB15 Pin-Out Diagrams	73
Information for CSA and ATEX Labeled Devices	79

GETTING STARTED

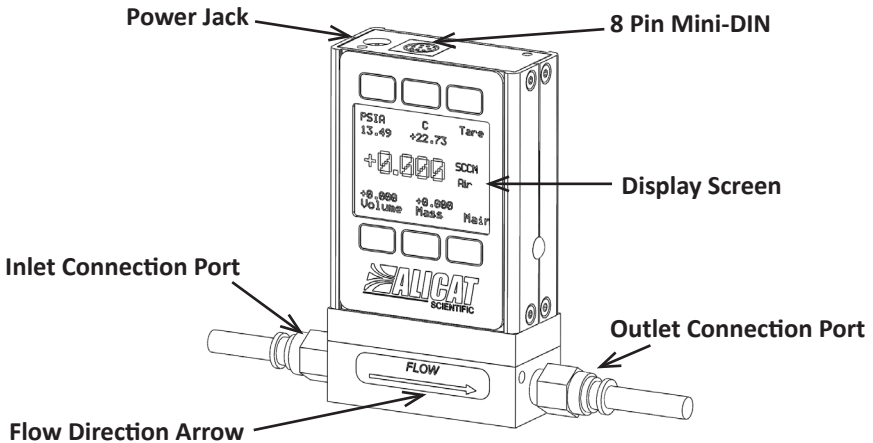

Medium Mass Flow Meter

MOUNTING

M-Series Gas Flow Meters have holes on the bottom for mounting to flat panels. See pages 50-64.

M-Series Meters can usually be mounted in any position.

No straight runs of pipe are required upstream or downstream of the meter.

PLUMBING

 ***Your meter is shipped with plastic plugs fitted in the port openings. To lessen the chance of contaminating the flow stream do not remove these plugs until you are ready to install the device.***

Make sure that the gas will flow in the direction indicated by the flow arrow.

Standard M-Series Gas Flow Meters have female inlet and outlet port connections. Welded VCR and other specialty fittings may have male ports.

The inlet and outlet port sizes (process connections) for different flow ranges are shown on pages 50-64.

Meters with M5 (10-32) ports have O-ring face seals and require no sealant or tape. Do not use tape with welded or O-ring fittings.

For non M5 (10-32) ports use thread sealing Teflon[®] tape to prevent leakage around the port threads.

Do not wrap the first two threads. This will minimize the possibility of getting tape into the flow stream and flow body.

 ***Do not use pipe dopes or sealants on the process connections as these compounds can cause permanent damage to the meter should they get into the flow stream.***



We recommend the use of in-line sintered filters to prevent large particulates from entering the measurement head of the instrument. Suggested maximum particulate sizes are as follows:

5 microns for units with FS flow ranges of 0-1 sccm or less.

20 microns for units with FS flow ranges between 0-2 sccm and 0-1 slpm.

50 microns for units with FS flow ranges of 0-1 slpm or more.



Connecting Fittings and Filters

<http://www.alicat.com/support/instructional-videos/>

PRESSURE

Maximum operating line pressure for M-Series units is 145 psig (1 MPa).

If the line pressure is higher than 145 psig (1 MPa), use a pressure regulator upstream from the flow meter to reduce the pressure to 145 psig (1 MPa) or less.

Maximum operating line pressure for WHISPER units is 50 psig.



Exceeding the maximum specified line pressure may cause permanent damage to the solid-state differential pressure sensor.



DO NOT SUBJECT AN M-SERIES DIFFERENTIAL PRESSURE SENSOR TO UPSTREAM-DOWNSTREAM PRESSURE DIFFERENTIALS EXCEEDING 75 PSID.

DO NOT SUBJECT A WHISPER DIFFERENTIAL PRESSURE SENSOR TO UPSTREAM-DOWNSTREAM PRESSURE DIFFERENTIALS EXCEEDING 15 PSID.

While high static pressure will typically not damage the dp sensor, sudden pressure “spikes” can result in complete failure of the sensor.

A common cause of this problem is instantaneous application of high-pressure gas as from a snap acting solenoid valve either upstream or downstream of the meter. If you suspect that your pressure sensor is damaged please discontinue use of the meter and contact Alicat.

POWER AND SIGNAL CONNECTIONS

Power can be supplied to your meter through either the power jack (power jack not available on CSA/ATEX approved devices) or the 8 pin Mini-DIN connector.

An AC to DC adapter which converts line AC power to DC voltage and current as specified below is required to use the power jack.

Meters require a 7-30 Vdc power supply with a 2.1 mm female positive center plug capable of supplying at least 100mA.



Note: 4-20mA analog output requires at least 15 Vdc.

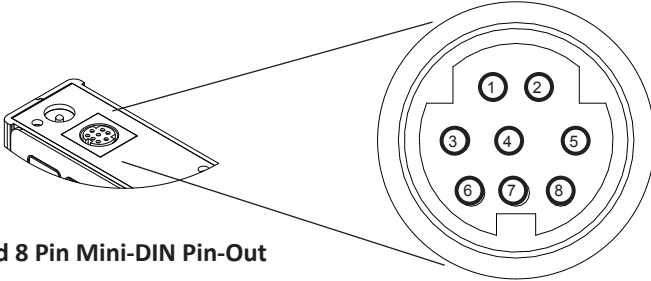

Standard 8 Pin Mini-DIN Pin-Out

Pin	Function	Mini-DIN cable color
1	Not Connected (or optional 4-20mA Primary Output Signal)	Black
2	Static 5.12 Vdc [or optional Secondary Analog Output (4-20mA, 5Vdc, 10Vdc) or Basic Alarm]	Brown
3	Serial RS-232RX / RS-485(-) Input Signal (receive)	Red
4	Meters/Gauges = Remote Tare (Ground to Tare) Controllers = Analog Set-Point Input	Orange
5	Serial RS-232TX / RS-485(+) Output Signal (send)	Yellow
6	0-5 Vdc (or optional 0-10 Vdc) Output Signal	Green
7	Power In (as described above)	Blue
8	Ground (common for power, digital communications, analog signals and alarms)	Purple

Note: The above pin-out is applicable to all the flow meters and controllers with the Mini-DIN connector. The availability of different output signals depends on the options ordered. Optional configurations are noted on the unit's calibration sheet.



CAUTION! DO NOT CONNECT POWER TO PINS 1 THROUGH 6 AS PERMANENT DAMAGE CAN OCCUR!



It is common to mistake Pin 2 (labeled 5.12 Vdc Output) as the standard 0-5 Vdc analog output signal. In fact Pin 2 is normally a constant 5.12 Vdc that reflects the system bus voltage and can be used as a source for the set-point signal.



For 6 Pin Locking Industrial Connector, DB9, and DB15 Pin-outs, see pages 66 to 78. For PROFIBUS Pin-out, see page 64

INPUT SIGNALS

Analog Input Signal

Apply analog input to Pin 4 as shown on page 8.

For 6 Pin Locking Connector, DB9 and DB15 Pin-outs, see pages 66 to 78.

For PROFIBUS Pin-out, see page 64.

Standard 0-5 Vdc is the standard analog input signal. Apply the 0-5 Vdc input signal to pin 4, with common ground on pin 8.

Optional 0-10 Vdc: If specified at time of order, a 0-10 Vdc input signal can be applied to pin 4, with common ground on pin 8.

Optional 4-20 mA: If specified at time of order, a 4-20 mA input signal can be applied to pin 4, with common ground on pin 8.

 **NOTE:** This is a current sinking device. The receiving circuit is essentially a 250 ohm resistor to ground.

 **NOTE:** 4-20 mA output requires at least 15 Vdc power input.





CAUTION! DO NOT CONNECT THIS DEVICE TO "LOOP POWERED" SYSTEMS, AS THIS WILL DESTROY PORTIONS OF THE CIRCUITRY AND VOID THE WARRANTY. IF YOU MUST INTERFACE WITH EXISTING LOOP POWERED SYSTEMS, ALWAYS USE A SIGNAL ISOLATOR AND A SEPARATE POWER SUPPLY.

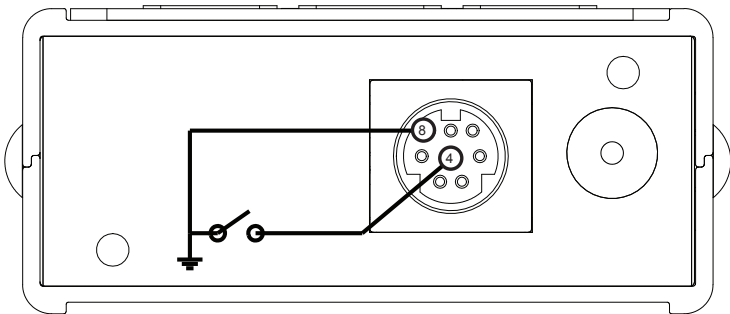

Electrical Connections and Basic Wiring

<http://www.alicat.com/support/instructional-videos/>



 A remote tare can be achieved by momentarily grounding pin 4 to tare as shown above.

RS-232 / RS-485 Digital Input Signal

To use the RS-232 or RS-485 input signal, connect the RS-232 / RS-485 Output Signal (Pin 5), the RS-232 / RS-485 Input Signal (Pin 3), and Ground (Pin 8) to your computer serial port as shown below. (See page 25 for details on accessing RS-232 / RS-485 input.)

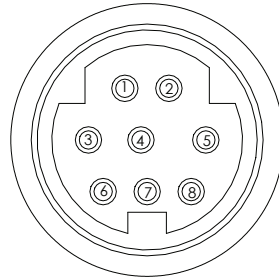
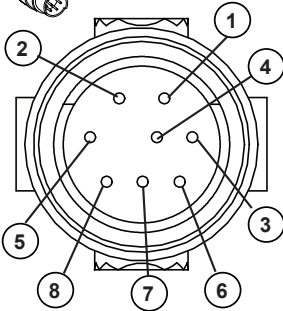
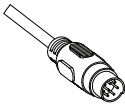
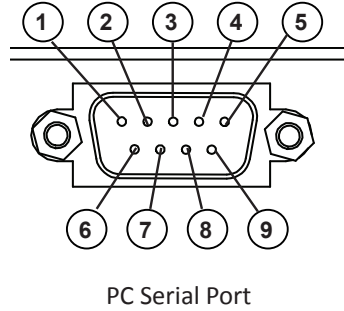
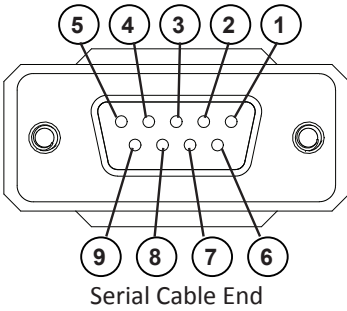
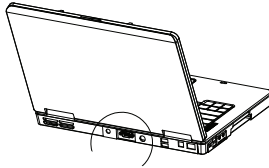
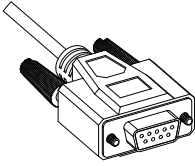

9 Pin Serial Connection		8 Pin MiniDIN Connection	
Pin	Function	Function	Pin
5	Ground	Ground	8
3	Transmit	Receive	3
2	Receive	Transmit	5

DB9 to Mini-DIN Connection for RS-232 / RS-485 Signals



Communication Set Up

<http://www.alicat.com/support/instructional-videos/>

OUTPUT SIGNALS

RS-232 / RS-485 Digital Output Signal

To use the RS-232 or RS-485 output signal, it is necessary to connect the RS-232 / RS-485 Output Signal (Pin 5), the RS-232 / RS-485 Input Signal (Pin 3), and Ground (Pin 8) to your computer serial port as shown on page 8. (See page 25 for details on accessing RS-232 / RS-485 output.)

Standard Voltage (0-5 Vdc) Output Signal

M-Series flow meters equipped with a 0-5 Vdc (optional 0-10 Vdc) will have this output signal available on Pin 6. This output is generally available in addition to other optionally ordered outputs. This voltage is usually in the range of 0.010 Vdc for zero flow and 5.0 Vdc for full-scale flow. The output voltage is linear over the entire range. Ground for this signal is common on Pin 8.

Optional 0-10 Vdc Output Signal

If your meter was ordered with a 0-10 Vdc output signal, it will be available on Pin 6. (See the Calibration Data Sheet that shipped with your meter to determine which output signals were ordered.) This voltage is usually in the range of 0.010 Vdc for zero flow and 10.0 Vdc for full-scale flow. The output voltage is linear over the entire range. Ground for this signal is common on Pin 8.

Optional Current (4-20 mA) Output Signal

If your meter was ordered with a 4-20 mA current output signal, it will be available on Pin 1. (See the Calibration Data Sheet that shipped with your meter to determine which output signals were ordered.) The current signal is 4 mA at 0 flow and 20 mA at the meter's full scale flow. The output current is linear over the entire range. Ground for this signal is common on Pin 8. (Current output units require 15-30Vdc power.)

Optional 2nd Analog Output Signal

You may specify an optional 2nd analog output on Pin 2 at time of order. (See the Calibration Data Sheet that shipped with your meter to determine which output signals were ordered.) This output may be a 0-5 Vdc, 0-10 Vdc, or 4-20 mA analog signal that can represent any measured parameter. With this optional output, a meter could output the mass flow rate (0-5 Vdc on pin 6) and the absolute pressure (0-5 Vdc on pin 2).



If your device is CSA/ATEX approved or equipped with the optional six pin industrial connector, please contact Alicat.



CAUTION! DO NOT CONNECT THIS DEVICE TO "LOOP POWERED" SYSTEMS, AS THIS WILL DESTROY PORTIONS OF THE CIRCUITRY AND VOID THE WARRANTY. IF YOU MUST INTERFACE WITH EXISTING LOOP POWERED SYSTEMS, ALWAYS USE A SIGNAL ISOLATOR AND A SEPARATE POWER SUPPLY.



CAUTION! DO NOT CONNECT THIS DEVICE TO "LOOP POWERED" SYSTEMS, AS THIS WILL DESTROY PORTIONS OF THE CIRCUITRY AND VOID THE WARRANTY. IF YOU MUST INTERFACE WITH EXISTING LOOP POWERED SYSTEMS, ALWAYS USE A SIGNAL ISOLATOR AND A SEPARATE POWER SUPPLY.

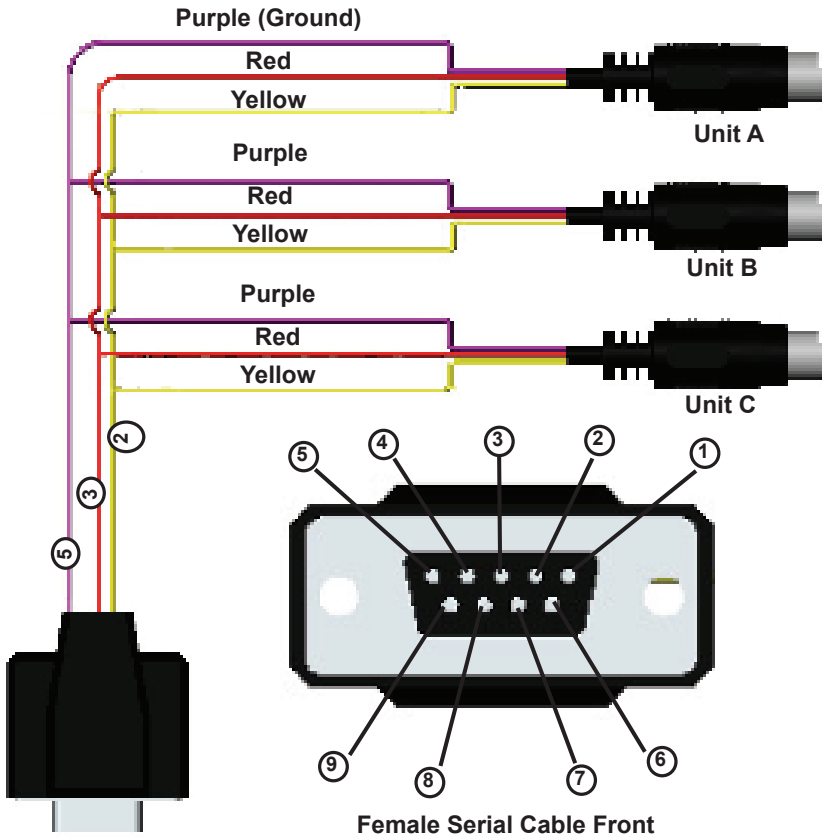

Typical Multiple Device (Addressable) Wiring Configuration



The easiest way to connect multiple devices is with a Multi-Drop Box (see page 46).

Information for Alicat TFT (Color Display) Instruments

Alicat TFT (color display) instruments have a high contrast back-lit LCD display. TFT instruments operate in accordance with Alicat standard operating instructions for our monochrome menus and displays with the following differences.

Multi-Color Display Color Codes:

GREEN: Green labels identify the parameters and/or adjustments associated with the button directly above or below the label.

WHITE: The color of each parameter is displayed in white while operating under normal conditions.

RED: The color of a parameter is displayed in red when operating conditions for that parameter exceed 128% of the device's specifications.

YELLOW: Yellow is the equivalent of the selection arrow on the monochrome display.

LCD Contrast:

LCD contrast is ranged from 1 to 11 on color displays with 11 being the greatest contrast.

Display On/Off:

Pushing the button under the Alicat name will turn the device display on or off. This feature is not available on monochrome displays.

Technical Data for TFT (Color Display) Meters, Gauges and Controllers

The following specifications are applicable to Alicat **TFT** (color display) meters, gauges and controllers only. All other operating specifications are shown in the Technical Data page for standard Alicat instruments. All standard device features and functions are available and operate in accordance with the Alicat operating manual provided with the device.

Specification	Meter or Gauge	Small Valve Controller	Large Valve Controller
Supply Voltage	7 to 30 Vdc	12 to 30 Vdc	24 to 30 Vdc
Supply Current	80 mA @ 12Vdc 70 mA @ 24Vdc	290 mA @ 12Vdc 200 mA @ 24Vdc	780 mA @ 24Vdc

DISPLAYS AND MENUS

The device screen defaults to **Main** display as soon as power is applied to the meter.

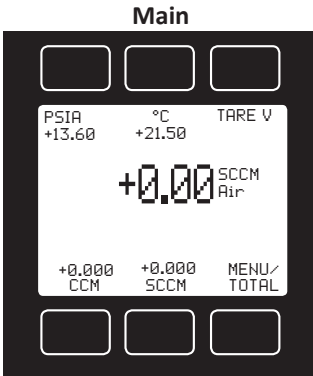

The **Main** display shows pressure, temperature, volumetric flow and mass flow.

Pressing the button adjacent to a parameter will make that parameter the primary display unit.

By hitting the **MENU** button at the bottom right of the screen you will enter the **Select Menu** display.

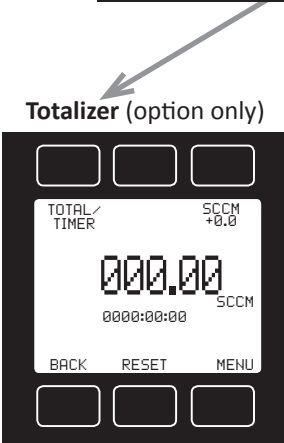

If your meter was ordered with the **Totalizer** option (page 43), pushing the **TOTAL** button once will bring up the **Totalizing Mode** display. Pushing **MENU** will bring up the **Select Menu** display.

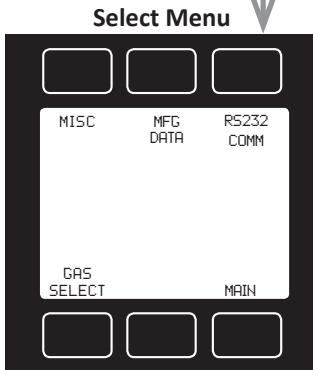

Select Menu

From **Select Menu** you can change the selected gas, interact with your RS-232 / RS-485 settings or read manufacturer's data.

Push **MAIN** to return to the Main display.

MAIN

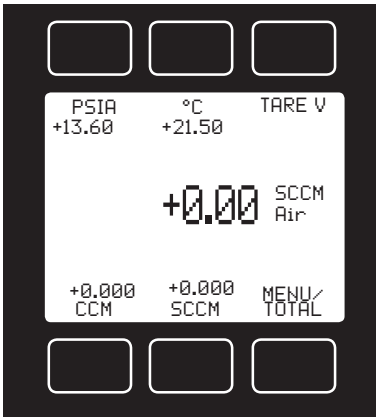

This mode defaults on power up, with mass flow as the primary displayed parameter.

The following parameters are displayed in the Main mode.

Gas Absolute Pressure: This sensor references hard vacuum and reads incoming pressure both above and below local atmospheric pressure. This parameter is moved to the primary display by pushing the button above **PSIA**.

The engineering unit associated with absolute pressure is pounds per square inch absolute (psia). This can be converted to gage pressure (psig) by subtracting local atmospheric pressure from the absolute pressure reading:

$$\text{PSIG} = \text{PSIA} - (\text{Local Atmospheric Pressure})$$

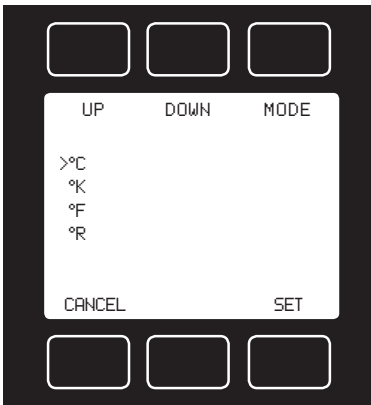

Gas Temperature: M-Series flow meters measure the incoming temperature of the gas flow. The temperature is displayed in degrees Celsius (°C). This parameter is moved to the primary display by pushing the button above **°C**.

Pushing the button again allows you to select °C (Celsius), °K (Kelvin), °F (Fahrenheit) or °R (Rankine) for the temperature scale.

To select a temperature scale, use the UP and DOWN buttons to position the arrow in front of the desired scale.

Press SET to record your selection and return to the MAIN display. The selected temperature scale will be displayed on the screen.

Tare: Pushing the **TARE V** button tares the flow meter and provides it with a reference point for zero flow. This is an important step in obtaining accurate measurements. It is best to zero the flow meter each time it is powered up. If the flow reading varies significantly from zero after an initial tare, give the unit a minute or so to warm up and re-zero it.

If possible, zero the unit near the expected operating pressure by positively blocking the flow downstream of the flow meter prior to pushing the TARE button.



Zeroing the unit while there is any flow will directly affect the accuracy by providing a false zero point.

If in doubt about whether a zero flow condition exists, remove the unit from the line and positively block both ports before pressing the TARE button. If the unit reads a significant negative value

when removed from the line and blocked, it was given a false zero. It is better to zero the unit at atmospheric pressure and a confirmed no flow condition than to give it a false zero under line pressure.

Volumetric Flow Rate: This parameter is located in the lower left of the display. It is moved to the primary display by pushing the button below **CCM** in this example. Your display may show a different unit of measure.

Mass Flow Rate: The mass flow rate is the volumetric flow rate corrected to a standard temperature and pressure (typically 14.696 psia and 25 °C).

This parameter is located in the lower middle of the display. It can be moved to the primary display by pushing the button below **SCCM** in this example. Your display may show a different unit of measure preceded by the letter **S**.

 **To get an accurate volumetric or mass flow rate, the gas being measured must be selected. See Gas Select, page 18.**

MENU: Pressing **MENU** switches the screen to the **Select Menu** display.



Flashing Error Message: An error message (**MOV** = mass overrange, **VOV** = volumetric overrange, **POV** = pressure overrange, **TOV** = temperature overrange) flashes when a measured parameter exceeds the range of the sensor. When any item flashes, neither the flashing parameter nor the mass flow measurement is accurate. Reducing the value of the flashing parameter to within specified limits will return the unit to normal operation and accuracy.

If the unit does not return to normal operation contact Alicat.

SELECT MENU

From Select Menu you can change the selected gas, interact with your RS-232 / RS-485 settings or read manufacturer's data.

Press the button next to the desired operation to bring that function to the screen.

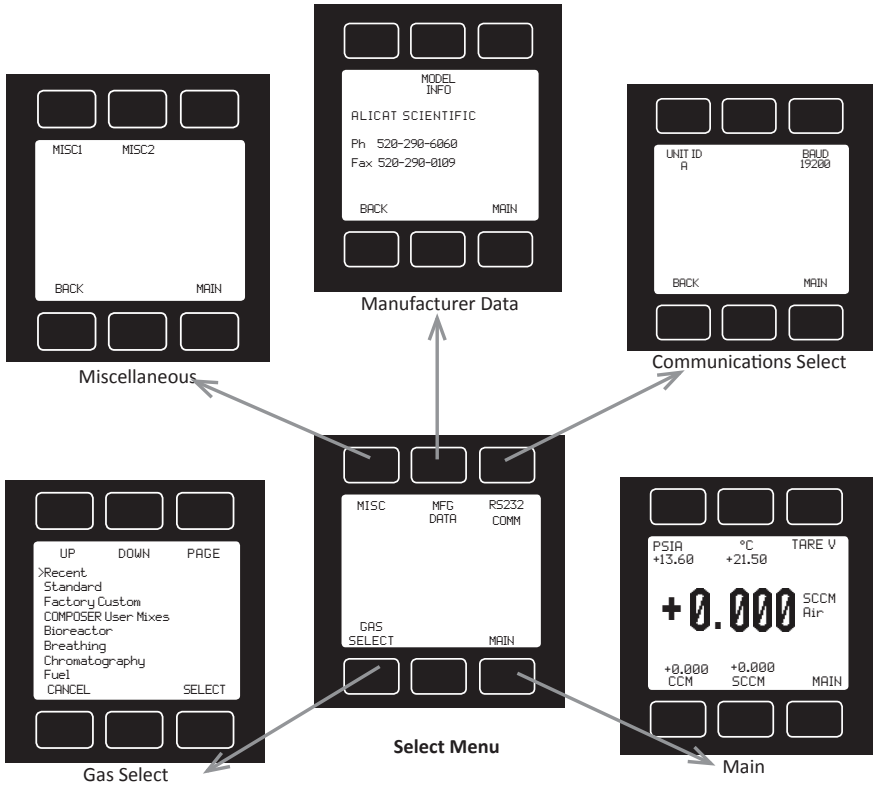

An explanation for each screen can be found on the following pages.

GAS SELECT

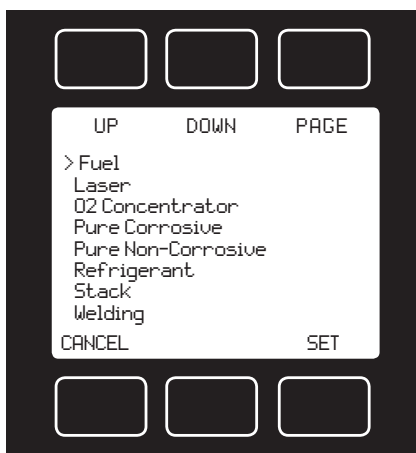
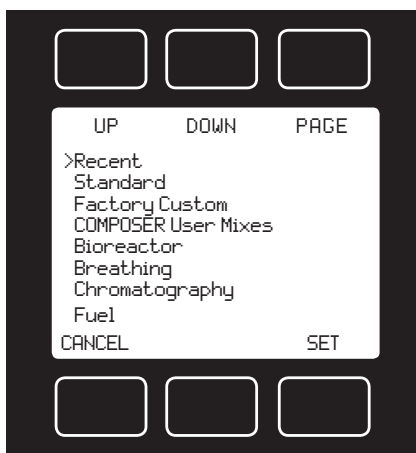

Gas Select allows you to set your device to up to 150 standard gases and mixes. You can also use **COMPOSER** to program and store up to 20 additional gas mixes.

Gas Select is accessed by pressing the button below **GAS SELECT** on the Select Menu display.

To select a gas, use the UP and DOWN buttons to position the arrow in front of the desired gas category.

- » Recent: Eight most recent selections
- » Standard: Gases and mixes standard on earlier Alicat instruments (page 32)
- » Factory Custom: Present only if customer requested gases were added at the factory
- » COMPOSER User Mixes: Gas mixes programmed by the user (page 19)
- » Bioreactor (page 36)
- » Breathing (page 37)
- » Chromatography (page 39)
- » Fuel (page 38)
- » Laser (page 38)
- » O2 Concentrator (page 39)
- » Pure Corrosive* (page 33)
- » Pure Non-Corrosive (page 32)
- » Refrigerant* (page 34)
- » Stack (page 39)
- » Welding (page 35)

Press PAGE to view a new page in the gas category list.

Press SELECT to view the gases in the selected category. Align the arrow with the desired gas. Press SET to record your selection and return to the MAIN display. The selected gas will be displayed on the screen.

* Pure Corrosive and Refrigerant gases are only available on **S-Series** instruments that are compatible with these gases.

Note: Gas Select may not be available on units ordered with a custom gas or blend.

See pages 32 -39 for a full list of gases in each category.

COMPOSER

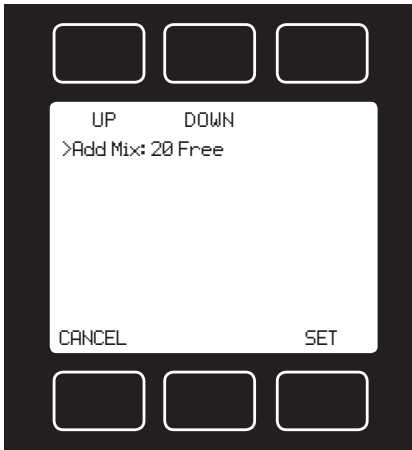

Composer allows you to program and save up to 20 custom gas mixes containing 2 to 5 component gases found in the gas lists (pages 32-39). The minimum resolution is 0.01%.

Composer is accessed by selecting **COMPOSER User Mixes** on the GAS SELECT display.

Press SET when the arrow is aligned with Add Mix.

Name the mix by pressing the UP and DOWN buttons for letters, numerals and symbols.

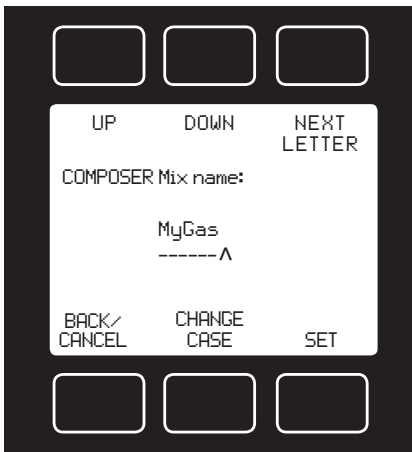

CHANGE CASE – Toggles the letter case. Letters remain in selected case until CHANGE CASE is pushed again.

Press SET to save the name.

After naming the mix, press **ADD GAS** and select the gas category and the component gas.

Select the digit with arrow and adjust the % with the UP and DOWN buttons. Press set to save. Add up to 4 more gases as needed. The total must equal 100% or an error message will appear.

GAS OPTNS allows you to adjust the percentage of the constituents or delete a gas from the mix. Gas mixes cannot be adjusted after they have been saved.

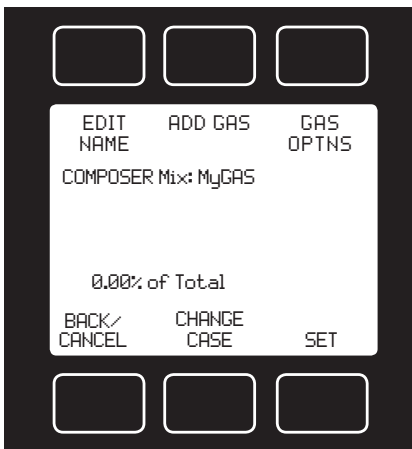

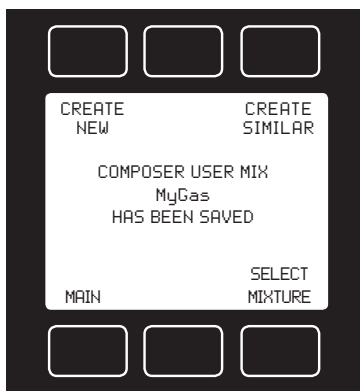
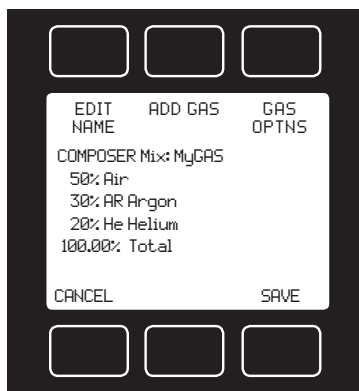
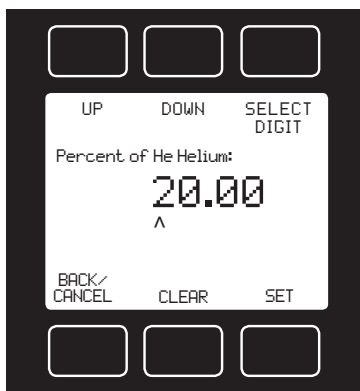
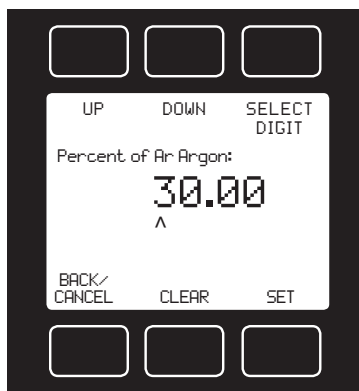
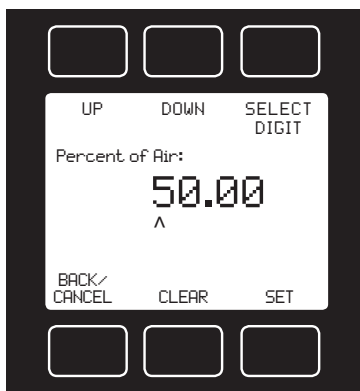

Once the mix has been saved, you may press **CREATE SIMILAR** to compose an additional mix based on the mix you have just saved. This CREATE SIMILAR option is not available after leaving this screen.

Press **CREATE NEW** to add a completely new mix.

Press **SELECT MIXTURE** to bring the custom mix onto the MAIN display.

COMMUNICATION SELECT

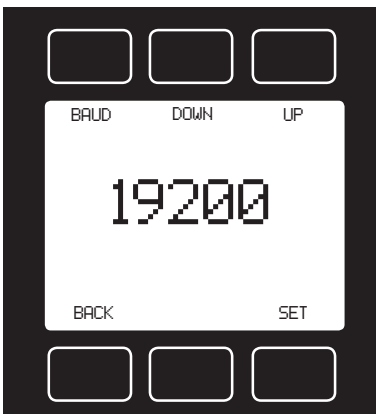
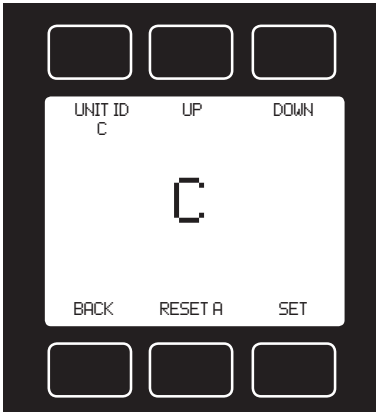
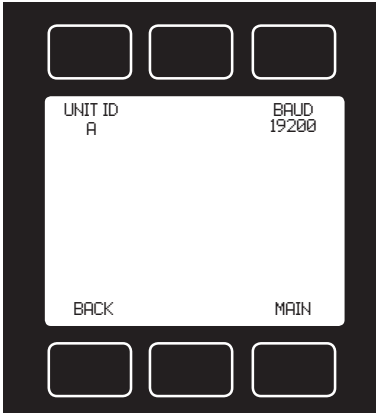

Access **Communication Select** by pressing the button above **RS232 COMM** or **RS485 COMM** on the **Select Menu** display.

Unit ID – Valid unit identifiers are the letters A-Z and @. The identifier allows you to assign a unique address to each device so that multiple units can be connected to a single RS-232 or RS-485 computer port.

Press **UNIT ID**. Use the UP and DOWN buttons to change the Unit ID. Press SET to record the ID. Press Reset to return to the previously recorded Unit ID.

Any Unit ID change will take effect when Communication Select is exited.

If the symbol @ is selected as the Unit ID, the device will enter streaming mode when Communication Select is exited. See RS-232 Communications (page 25) for information about the streaming mode.

Baud – Both this instrument and your computer must send/receive data at the same baud rate. The default baud rate for this device is 19200 baud.

Press the Select button until the arrow is in front of **Baud**. Use the UP and DOWN buttons to select the baud rate that matches your computer. The choices are 38400, 19200, 9600, or 2400 baud.

Any baud rate change will not take effect until power to the unit is cycled.

MISCELLANEOUS

Miscellaneous is accessed by pressing the **MISC** button on the Select Menu display. Next select either **MISC1** or **MISC2**.

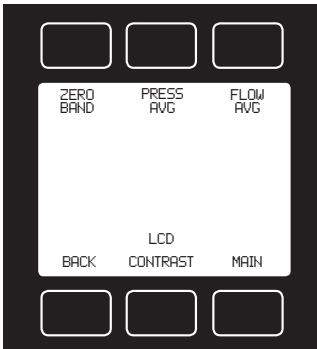

MISC1 will display as shown at left.

ZERO BAND refers to Display Zero Deadband.

Zero deadband is a value below which the display jumps to zero. This deadband is often desired to prevent electrical noise from showing up on the display as minor flows or pressures that do not exist. Display Zero Deadband does not affect the analog or digital signal outputs.

ZERO BAND can be adjusted between 0 and 3.2% of the sensor's Full Scale (FS).

Press **ZERO BAND**. Then use SELECT to choose the digit with the arrow and the UP and DOWN buttons to change the value. Press SET to record your value. Press CLEAR to return to zero.

Pressure Averaging and Flow Averaging may be useful to make it easier to read and interpret rapidly fluctuating pressures and flows. Pressure and flow averaging can be adjusted between 1 (no averaging) and 256 (maximum averaging).

These are geometric running averages where the number between 1 and 256 can be considered roughly equivalent to the response time constant in milliseconds.

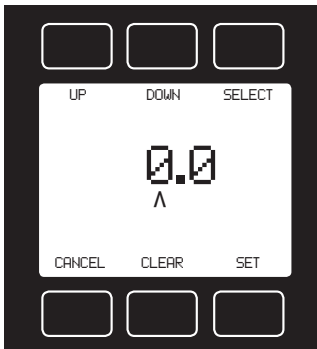

This can be effective at "smoothing" high frequency process oscillations such as those caused by diaphragm pumps.

Press **PRESS AVG**. Then use SELECT to choose the digit with the arrow and the UP and DOWN buttons to change the value. Press SET to record your value. Press CLEAR to return to zero.

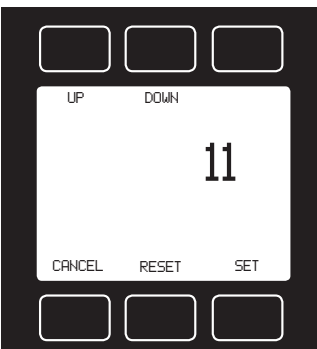

Press **FLOW AVG**. Then use SELECT to choose the digit with the arrow and the UP and DOWN buttons to change the value. Press SET to record your value. Press CLEAR to return to zero.

Setting a higher number will equal a smoother display.

LCD CONTRAST: The display contrast can be adjusted between 0 and 30, with zero being the lightest and 30 being the darkest. Use the UP and DOWN buttons to adjust the contrast. Press SET when you are satisfied. Press CANCEL to return to the MISC display.

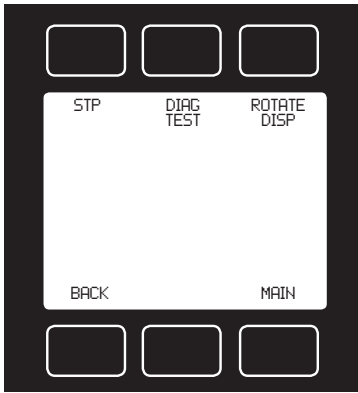

MISC2 will display as shown at left.

STP refers to the functions that allow selection of standard temperature and pressure conditions. This feature is generally useful for comparison purposes to other devices or systems using different STP parameters.

The **STP** menu is comprised of the **STP TEMP** and **STP PRESS** screens.

STP TEMP allows you to select from seven standard temperature protocols. The arrow position will automatically default to the currently stored value.

Once a selection has been made and recorded using the **SET** button, a change acknowledgement message will be displayed on screen.

Selecting **RETURN** will revert screen to the Main display. If the **SET** selection is already the currently stored value, a message indicating that fact will appear.

STP PRESS enables you to select from one of two standard pressure settings.

The arrow position will automatically default to the currently stored value.

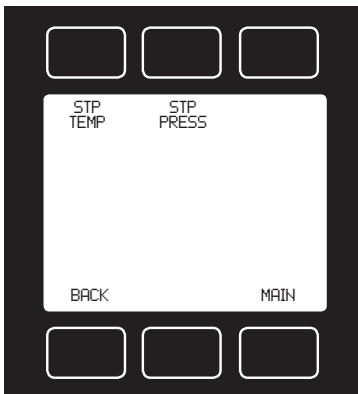

Once a selection has been made and recorded using the **SET** button, a change acknowledgement message will be displayed on screen.

Selecting **RETURN** will revert screen to the Main display. If the **SET** selection is already the currently stored value, a message indicating that fact will appear.

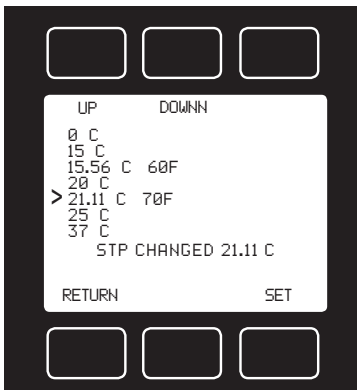

STP TEMP Display

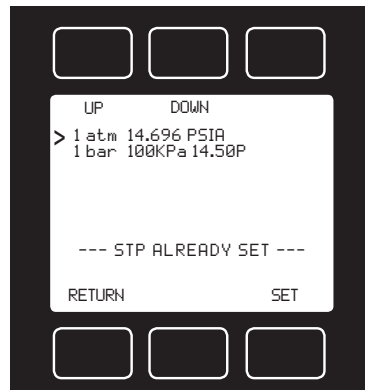

STP PRESS Display

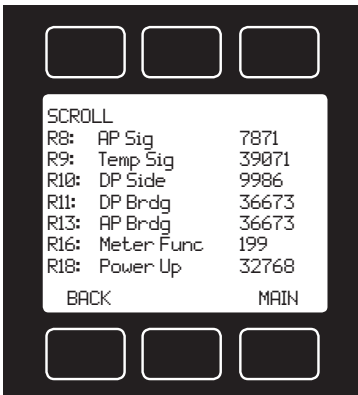

DIAG TEST: This diagnostic screen displays the initial register values configured by the factory, which is useful for noting factory settings prior to making any changes. It is also helpful for troubleshooting with Alicat customer service personnel.

Select the **DIAG TEST** button from the **MISC2** screen to view a list of select register values. Pressing the **SCROLL** button will cycle the display through the register screens. An example screen is shown at left.

Press **ROTATE DISP** and **SET** to **Inverted 180°** if your device is inverted. The display and buttons will rotate together.

MANUFACTURER DATA

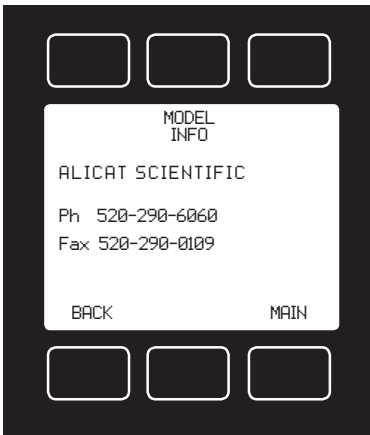

Manufacturer Data is accessed by pressing the **MFG DATA** button on the Select Menu display.

The initial display shows the name and telephone number of the manufacturer.

Press **MODEL INFO** to show important information about your flow device including the model number, serial number, and date of manufacture.

Press **BACK** to return to the **MFG DATA** display.

Push **MAIN** to return to the Main display.

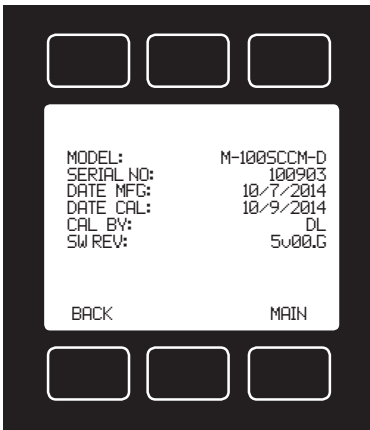

RS-232 / RS-485 Output and Input

Configuring HyperTerminal®:

1. Open your HyperTerminal® RS-232 / RS-485 terminal program (installed under the “Accessories” menu on all Microsoft Windows® operating systems).
2. Select “Properties” from the file menu.
3. Click on the “Configure” button under the “Connect To” tab. Be sure the program is set for: 19,200 baud (or matches the baud rate selected in the RS-232 / RS-485 communications menu on the meter) and an 8-N-1-None (8 Data Bits, No Parity, 1 Stop Bit, and no Flow Control) protocol.
4. Under the “Settings” tab, make sure the Terminal Emulation is set to ANSI or Auto Detect.
5. Click on the “ASCII Setup” button and be sure the “Send Line Ends with Line Feeds” box is not checked and the “Echo Typed Characters Locally” box and the “Append Line Feeds to Incoming Lines” boxes are checked. Those settings not mentioned here are normally okay in the default position.
6. Save the settings, close HyperTerminal® and reopen it.

Streaming Mode (RS-485 units do not have a streaming mode)

In the **default** Polling Mode, the screen should be blank except the blinking cursor. In order to get the data streaming to the screen, hit the “Enter” key several times to clear any extraneous information. Type “* @= @” followed by “Enter” (or using the RS-232 / RS-485 communication select menu, select @ as identifier and exit the screen). If data still does not appear, check all the connections and COM port assignments.

Streaming Mode – Advanced

The streaming data rate is controlled by register 91. The recommended default rate of data provision is once every 50 milliseconds and this is suitable for most purposes.

If a slower or faster streaming data rate is desired, register 91 can be changed to a value from 1 millisecond to 65535 milliseconds, or slightly over once every minute.

Below approximately 40 milliseconds, data provision will be dependent upon how many parameters are selected. Fewer data parameters can be streamed more quickly than more. It is left to the user to balance streaming speed with number of parameters streamed.

To read register 91, type “*r91” followed by “Enter”.

To modify register 91, type “*w91=X”, where X is a positive integer from 1 to 65535, followed by “Enter”.

To return to the recommended factory default streaming speed, type “*w91= 50”.



Communication Set Up

<http://www.alicat.com/support/instructional-videos/>

Tareing via RS-232 / RS-485:

Tare –Tareing (or zeroing) the flow meter provides it with a reference point for zero flow. This is a simple but important step in obtaining accurate measurements. It is good practice to “zero” the flow meter each time it is powered up. A unit may be Tared by following the instructions on page 10 or it may be Tared via RS-232 / RS-485 input.

To send a Tare command via RS-232 / RS-485, enter the following strings:

In Polling Mode: Address\$\$V<Enter> (e.g. B\$\$V<Enter>)

Changing From Streaming to Polling Mode:

When the meter is in the Streaming Mode (*RS-485 units do not have a streaming mode*), the screen is updated approximately 10-60 times per second (depending on the amount of data on each line) so that the user sees the data essentially in real time. It is sometimes desirable, and necessary when using more than one unit on a single RS-232 line, to be able to poll the unit.

In Polling Mode the unit measures the flow normally, but only sends a line of data when it is “polled”. Each unit can be given its own unique identifier or address. Unless otherwise specified each unit is shipped with a default address of capital A. Other valid addresses are B thru Z.

Once you have established communication with the unit and have a stream of information filling your screen:

1. Type `*@=A` followed by “Enter” (or using the RS-232 / RS-485 communication select menu, select A as identifier and exit the screen) to stop the streaming mode of information. Note that the flow of information will not stop while you are typing and you will not be able to read what you have typed. Also, the unit does not accept a backspace or delete in the line so it must be typed correctly. If in doubt, simply hit enter and start again. If the unit does not get exactly what it is expecting, it will ignore it. If the line has been typed correctly, the data will stop.
2. You may now poll the unit by typing A followed by “Enter”. This does an instantaneous poll of unit A and returns the values once. You may type A “Enter” as many times as you like. Alternately you could resume streaming mode by typing `*@=@` followed by “Enter”. Repeat step 1 to remove the unit from the streaming mode.
3. To assign the unit a new address, type `*@=New Address`, e.g. `*@=B`. Care should be taken not to assign an address to a unit if more than one unit is on the RS-232 / RS-485 line as all of the addresses will be reassigned. Instead, each should be individually attached to the RS-232 / RS-485 line, given an address, and taken off. After each unit has been given a unique address, they can all be put back on the same line and polled individually.

Gas Select – The selected gas can be changed via RS-232 / RS-485 input. To change the selected gas, enter the following commands:

In Polling Mode: Address\$\$#<Enter> (e.g. B\$\$#<Enter>)

Where # is the number of the gas selected from the table below. Note that this also corresponds to the gas select menu on the flow controller screen (the **Standard** gas category is shown in the example below):

#	GAS	
0	Air	Air
1	Argon	Ar
2	Methane	CH4
3	Carbon Monoxide	CO
4	Carbon Dioxide	CO2
5	Ethane	C2H6
6	Hydrogen	H2
7	Helium	He
8	Nitrogen	N2
9	Nitrous Oxide	N2O
10	Neon	Ne
11	Oxygen	O2
12	Propane	C3H8
13	normal-Butane	n-C4H10
14	Acetylene	C2H2
15	Ethylene	C2H4
16	iso-Butane	i-C2H10
17	Krypton	Kr
18	Xenon	Xe
19	Sulfur Hexafluoride	SF6
20	75% Argon / 25% CO2	C-25
21	90% Argon / 10% CO2	C-10
22	92% Argon / 8% CO2	C-8
23	98% Argon / 2% CO2	C-2
24	75% CO2 / 25% Argon	C-75
25	75% Argon / 25% Helium	HE-75
26	75% Helium / 25% Argon	HE-25
27	90% Helium / 7.5% Argon / 2.5% CO2 (Praxair - Helistar® A1025)	A1025
28	90% Argon / 8% CO2 / 2% Oxygen (Praxair - Stargon® CS)	Star29
29	95% Argon / 5% Methane	P-5

For example, to select Propane, enter: \$\$12<Enter>

Creating and Deleting Gas Mixtures with COMPOSER™ using RS-232 or RS-485

Note: All commands must be prefixed with the unit ID if the unit is not in streaming mode.

You may create and store up to 20 gas mixtures containing up to five constituent gases each.

Create a Gas Mixture

To create a gas mixture, enter a single-line command according to the following formula: [Unit ID]GM [Gas Name] [Gas Mix Number] [Percent 1] [Gas Number 1] [Percent 2] [Gas Number 2] ...

Gas Name: Name your mixture using a maximum of 6 characters.

Gas Mix Number: COMPOSER™ user mixes have Alicat gas numbers between 236 and 255. You can assign any number in this range to your new mixture. If another mixture with the same number exists, it will be overwritten, even if that gas is currently selected on the unit. If you enter a 0 here, the new mix will be assigned the next available number between 236 and 255.

Percent 1: The percentage of the first constituent gas. The percentage of each constituent must be between 0.01 and 99.99. Values entered beyond two decimal points will be rounded to the nearest 0.01%.

Gas Number 1: The Alicat gas number of the first constituent gas.

Percent 2: The percentage of the first constituent gas. Values entered beyond two decimal points will be rounded to the nearest 0.01%.

Gas Number 2: The Alicat gas number of the first constituent gas.

Additional Gases: (Optional) The above pattern of [Percent] + [Gas Number] may be repeated for additional constituent gases up to a total of 5 constituents. The sum of all percentages must be 100.00.

On success, the unit ID (if set) is returned followed by a space. The number of the gas mixture is then returned, followed by the percentages and names of each constituent in the mix. If the gas is not successfully mixed, a "?" is returned.

Delete a Gas Mixture

To delete a gas mixture, enter:

[Unit ID]GD [Gas Number]: The number of the COMPOSER™ user mixture you wish to delete from the unit

Only COMPOSER™ user mixtures can be deleted with this command.

On success, the unit ID (if set) is returned followed by a space and the number of the gas deleted. If the gas is not successfully deleted, a "?" is returned.

Collecting Data:

The RS-232 / RS-485 output updates to the screen many times per second. Very short-term events can be captured simply by disconnecting (there are two telephone symbol icons at the top of the HyperTerminal® screen for disconnecting and connecting) immediately after the event in question. The scroll bar can be driven up to the event and all of the data associated with the event can be selected, copied, and pasted into Microsoft® Excel® or other spreadsheet program as described below.

For longer term data, it is useful to capture the data in a text file. With the desired data streaming to the screen, select "Capture Text" from the Transfer Menu. Type in the path and file name you wish to use. Push the start button. When the data collection period is complete, simply select "Capture Text" from the Transfer Menu and select "Stop" from the sub-menu that appears.

Data that is selected and copied, either directly from HyperTerminal® or from a text file can be pasted directly into Excel®. When the data is pasted it will all be in the selected column. Select "Text to Columns..." under the Data menu in Excel® and a Text to Columns Wizard (dialog box) will appear. Make sure that "Fixed Width" is selected under Original Data Type in the first dialog box and click "Next". In the second dialog box, set the column widths as desired, but the default is usually acceptable. Click on "Next" again. In the third dialog box, make sure the column data format is set to "General", and click "Finish". This separates the data into columns for manipulation and removes symbols such as the plus signs from the numbers. Once the data is in this format, it can be graphed or manipulated as desired. ***For extended term data capture see page 30.***

Data Format:

The data stream on the screen represents the flow parameters of the main mode in the units shown on the display.

For mass flow meters, there are five columns of data representing pressure, temperature, volumetric flow, mass flow and the selected gas.

The first column is absolute pressure (normally in psia), the second column is temperature (normally in °C), the third column is volumetric flow rate (in the units specified at time of order and shown on the display), and the fourth column is mass flow (also in the units specified at time of order and shown on the display). For instance, if the meter was ordered in units of scfm, the display on the meter would read 2.004 scfm and the last two columns of the output below would represent volumetric flow and mass flow in cfm and scfm respectively.

+014.70	+025.00	+02.004	+02.004	Air
+014.70	+025.00	+02.004	+02.004	Air
+014.70	+025.00	+02.004	+02.004	Air
+014.70	+025.00	+02.004	+02.004	Air
Pressure	Temp	Vol. Flow	Mass Flow	Gas

M-Series Mass Flow Meter Data Format

Note: On units with the totalizer function the fifth column will be the totalizer value, with gas select moving to a sixth column.

Sending a Simple Script File to HyperTerminal®

It is sometimes desirable to capture data for an extended period of time. Standard streaming mode information is useful for short term events, however, when capturing data for an extended period of time, the amount of data and thus the file size can become too large very quickly. Without any special programming skills, you can use HyperTerminal® and a text editing program such as Microsoft® Word® to capture text at defined intervals.

1. Open your text editing program, MS Word for example.
2. Set the cap lock on so that you are typing in capital letters.
3. Beginning at the top of the page, type A<Enter> repeatedly. If you're using MS Word, you can tell how many lines you have by the line count at the bottom of the screen. The number of lines will correspond to the total number of times the flow device will be polled, and thus the total number of lines of data it will produce.

For example: A
 A
 A
 A
 A
 A
 A

will get a total of six lines of data from the flow meter, but you can enter as many as you like.

The time between each line will be set in HyperTerminal.

4. When you have as many lines as you wish, go to the File menu and select save. In the save dialog box, enter a path and file name as desired and in the "Save as Type" box, select the plain text (.txt) option. It is important that it be saved as a generic text file for HyperTerminal to work with it.
5. Click Save.
6. A file conversion box will appear. In the "End Lines With" drop down box, select CR Only. Everything else can be left as default.
7. Click O.K.
8. You have now created a "script" file to send to HyperTerminal. Close the file and exit the text editing program.
9. Open HyperTerminal and establish communication with your flow device as outlined in the manual.
10. Set the flow device to Polling Mode as described in the manual. Each time you type A<Enter>, the meter should return one line of data to the screen.
11. Go to the File menu in HyperTerminal and select "Properties".
12. Select the "Settings" tab.
13. Click on the "ASCII Setup" button.

14. The “Line Delay” box is defaulted to 0 milliseconds. This is where you will tell the program how often to read a line from the script file you’ve created. 1000 milliseconds is one second, so if you want a line of data every 30 seconds, you would enter 30000 into the box. If you want a line every 5 minutes, you would enter 300000 into the box.

15. When you have entered the value you want, click on OK and OK in the Properties dialog box.

16. Go the Transfer menu and select “Send **Text** File...” (NOT Send File...).

17. Browse and select the text “script” file you created.

18. Click Open.

19. The program will begin “executing” your script file, reading one line at a time with the line delay you specified and the flow device will respond by sending one line of data for each poll it receives, when it receives it.

You can also capture the data to another file as described in the manual under “Collecting Data”. You will be simultaneously sending it a script file and capturing the output to a separate file for analysis.

Operating Principle

All M-Series Gas Flow Meters (and MC Series Gas Flow Controllers) are based on the accurate measurement of volumetric flow. The volumetric flow rate is determined by creating a pressure drop across a unique internal restriction, known as a Laminar Flow Element (LFE), and measuring differential pressure across it. The restriction is designed so that the gas molecules are forced to move in parallel paths along the entire length of the passage; hence laminar (streamline) flow is established for the entire range of operation of the device. Unlike other flow measuring devices, in laminar flow meters the relationship between pressure drop and flow is linear.



Please visit the Alicat web site for a detailed explanation this principle.

<http://www.alicat.com/technical-information/theory-of-operation/>

STANDARD GAS DATA TABLES: Those of you who have older Alicat products may notice small discrepancies between the gas property tables of your old and new units. Alicat Scientific, Inc. has incorporated the latest data sets from NIST (including their REFPROP 9 data where available) in our products’ built-in gas property models. Be aware that the calibrators that you may be using may be checking against older data sets such as the widely distributed Air Liquide data. This may generate apparent calibration discrepancies of up to 0.6% of reading on well behaved gases and as much as 3% of reading on some gases such as propane and butane, unless the standard was directly calibrated on the gas in question.

As the older standards are phased out, this difference in readings will cease to be a problem. If you see a difference between the Alicat meter and your in-house standard, in addition to calling Alicat Scientific at (520) 290-6060, call the manufacturer of your standard for clarification as to which data set they used in their calibration. This comparison will in all likelihood resolve the problem.

GAS SELECT > Standard:

M Meters will display: Acetylene, Air, Argon, Butane, Carbon Dioxide, Carbon Monoxide, Ethane, Ethylene (Ethene), Helium, Hydrogen, Iso-Butane, Krypton, Methane, Neon, Nitrogen, Nitrous Oxide, Oxygen, Propane, Sulfur Hexafluoride, Xenon, A-25, A-75, A1025, C-2, C-8, C-10, C-25, C-75, P-5, Star29.

MS Meters add the following: Ammonia, Chlorine Gas, Hydrogen Sulfide, Nitric Oxide, Nitrogen Trifluoride, Propylene, Sulfur Dioxide, and Nitrogen Dioxide to 0.5% in an inert carrier, Refrigerant gases.

PURE NON-CORROSIVE GASES			25°C			0°C		
Gas Number	Short Name	Long Name	Absolute Viscosity	Density 14.696 PSIA	Compressibility 14.696 PSIA	Absolute Viscosity	Density 14.696 PSIA	Compressibility 14.696 PSIA
14	C2H2	Acetylene	104.44800	1.07200	0.9928000	97.374	1.1728	0.9905
0	Air	Air	184.89890	1.18402	0.9996967	172.574	1.2930	0.9994
1	Ar	Argon	226.23990	1.63387	0.9993656	210.167	1.7840	0.9991
16	i-C4H10	i-Butane	74.97846	2.44028	0.9735331	68.759	2.6887	0.9645
13	n-C4H10	n-Butane	74.05358	2.44930	0.9699493	67.690	2.7037	0.9591
4	CO2	Carbon Dioxide	149.31840	1.80798	0.9949545	137.107	1.9768	0.9933
3	CO	Carbon Monoxide	176.49330	1.14530	0.9996406	165.151	1.2505	0.9993
60	D2	Deuterium	126.59836	0.16455	1.0005970	119.196	0.1796	1.0006
5	C2H6	Ethane	93.54117	1.23846	0.9923987	86.129	1.3550	0.9901
15	C2H4	Ethylene (Ethene)	103.18390	1.15329	0.9942550	94.697	1.2611	0.9925
7	He	Helium	198.45610	0.16353	1.0004720	186.945	0.1785	1.0005
6	H2	Hydrogen	89.15355	0.08235	1.0005940	83.969	0.0899	1.0006
17	Kr	Krypton	251.32490	3.43229	0.9979266	232.193	3.7490	0.9972
2	CH4	Methane	110.75950	0.65688	0.9982472	102.550	0.7175	0.9976
10	Ne	Neon	311.12640	0.82442	1.0004810	293.822	0.8999	1.0005
8	N2	Nitrogen	178.04740	1.14525	0.9998016	166.287	1.2504	0.9995
9	N2O	Nitrous Oxide	148.41240	1.80888	0.9945327	136.310	1.9779	0.9928
11	O2	Oxygen	205.50210	1.30879	0.9993530	191.433	1.4290	0.9990
12	C3H8	Propane	81.46309	1.83204	0.9838054	74.692	2.0105	0.9785
19	SF6	Sulfur Hexafluoride	153.53200	6.03832	0.9886681	140.890	6.6162	0.9849
18	Xe	Xenon	229.84830	5.39502	0.9947117	212.157	5.8980	0.9932

PURE CORROSIVES*			25°C			0°C		
Gas Number	Short Name	Long Name	Absolute Viscosity	Density 14.696 PSIA	Compressibility 14.696 PSIA	Absolute Viscosity	Density 14.696 PSIA	Compressibility 14.696 PSIA
32	NH3	Ammonia	100.92580	0.70352	0.9894555	91.930	0.7715	0.9848612
80	1Butene	Butylene (1-Butene)	81.62541	2.35906	0.9721251	74.354	2.6036	0.9614456
81	cButene	Cis-Butene (cis-2-butene)	79.96139	2.36608	0.9692405	Liquid	Liquid	Liquid
82	iButene	Iso-Butene	80.84175	2.35897	0.9721626	73.640	2.6038	0.9613501
83	tButene	Trans-Butene	80.28018	2.36596	0.9692902	Liquid	Liquid	Liquid
84	COS	Carbonyl Sulfide	124.09600	2.48322	0.9888443	113.127	2.7202	0.985328
33	Cl2	Chlorine	134.56600	2.93506	0.9874470	125.464	3.1635	0.98407
85	CH3OCH3	Dimethylether	90.99451	1.91822	0.9816453	82.865	2.1090	0.9745473
34	H2S	Hydrogen Sulfide (H2S)	123.86890	1.40376	0.9923556	112.982	1.5361	0.9898858
31	NF3	NF3 (Nitrogen Trifluoride)	175.42500	2.91339	0.9963859	162.426	3.1840	0.9951506
30	NO	NO (Nitric Oxide)	190.05950	1.22672	0.9997970	176.754	1.3394	0.9995317
36	C3H6	Propylene (Propylene)	85.59895	1.74509	0.9856064	78.129	1.9139	0.9809373
86	SiH4	Silane (SiH4)	115.94400	1.32003	0.9945000	107.053	1.4433	0.99282
35	SO2	Sulfur Dioxide	127.83100	2.66427	0.9828407	116.717	2.9312	0.9750866

*Pure Corrosive gases are only available on S-Series instruments that are compatible with these gases. Gas numbers 33 and 35 are not available on controllers.

REFRIGERANTS			25°C				0°C				
Gas Number	Short Name	Long Name	Absolute Viscosity	Density 14.696 PSIA	Compressibility 14.696 PSIA	Absolute Viscosity	Density 14.696 PSIA	Compressibility 14.696 PSIA	Absolute Viscosity	Density 14.696 PSIA	Compressibility 14.696 PSIA
100	R-11	Trichlorofluoromethane	101.60480	5.82358	0.9641448	Liquid	Liquid	Liquid	Liquid	Liquid	Liquid
101	R-115	Chloropentafluoroethane	125.14780	6.43293	0.9814628	114.891	7.0666	0.9752287	114.891	7.0666	0.9752287
102	R-116	Hexafluoroethane	137.81730	5.70097	0.9895011	126.635	6.2458	0.9858448	126.635	6.2458	0.9858448
103	R-124	Chlorotetrafluoroethane	115.93110	5.72821	0.9738286	105.808	6.3175	0.963807	105.808	6.3175	0.963807
104	R-125	Pentafluoroethane	129.61740	4.98169	0.9847599	118.793	5.4689	0.979137	118.793	5.4689	0.979137
105	R-134A	Tetrafluoroethane	118.18820	4.25784	0.9794810	108.311	4.6863	0.9713825	108.311	4.6863	0.9713825
106	R-14	Tetrafluoromethane	172.44680	3.61084	0.9962553	159.688	3.9467	0.9948964	159.688	3.9467	0.9948964
107	R-142b	Chlorodifluoroethane	104.20190	4.21632	0.9742264	95.092	4.6509	0.9640371	95.092	4.6509	0.9640371
108	R-143a	Trifluoroethane	110.86600	3.49451	0.9830011	101.344	3.8394	0.9765755	101.344	3.8394	0.9765755
109	R-152a	Difluoroethane	100.81320	2.75903	0.9785245	91.952	3.0377	0.9701025	91.952	3.0377	0.9701025
110	R-22	Difluoromonochloromethane	126.30390	3.58679	0.9853641	115.325	3.9360	0.9801128	115.325	3.9360	0.9801128
111	R-23	Trifluoromethane	149.13160	2.88404	0.9922734	136.997	3.1568	0.9895204	136.997	3.1568	0.9895204
112	R-32	Difluoromethane	126.13140	2.15314	0.9875960	115.303	2.3619	0.9827161	115.303	2.3619	0.9827161
113	RC-318	Octafluorocyclobutane	115.04690	8.42917	0.9700156	104.785	9.3017	0.9594738	104.785	9.3017	0.9594738
114	R-404A	44% R-125 / 4% R-134A / 52% R-143A	120.30982	4.18002	0.9836342	111.584	4.5932	0.9770889	111.584	4.5932	0.9770889
115	R-407C	23% R-32 / 25% R-125 / 52% R-134A	123.55369	3.95268	0.9826672	112.698	4.3427	0.9762849	112.698	4.3427	0.9762849
116	R-410A	50% R-32 / 50% R-125	130.24384	3.56538	0.9861780	122.417	3.9118	0.9811061	122.417	3.9118	0.9811061
117	R-507A	50% R-125 / 50% R-143A	121.18202	4.23876	0.9838805	112.445	4.6573	0.9774207	112.445	4.6573	0.9774207

*Refrigerant gases are only available on S-Series instruments that are compatible with these gases.

WELDING GASES		Long Name	25°C			0°C		
Gas Number	Short Name		Absolute Viscosity	Density 14.696 PSIA	Compressibility 14.696 PSIA	Absolute Viscosity	Density 14.696 PSIA	Compressibility 14.696 PSIA
23	C-2	2% CO2 / 98% Ar	224.71480	1.63727	0.9993165	208.673	1.7877	0.998993
22	C-8	8% CO2 / 92% Ar	220.13520	1.64749	0.9991624	204.199	1.7989	0.9987964
21	C-10	10% CO2 / 90% Ar	218.60260	1.65091	0.9991086	202.706	1.8027	0.9987278
140	C-15	15% CO2 / 85% Ar	214.74960	1.65945	0.9989687	198.960	1.8121	0.9985493
141	C-20	20% CO2 / 80% Ar	210.86960	1.66800	0.9988210	195.198	1.8215	0.9983605
20	C-25	25% CO2 / 75% Ar	206.97630	1.67658	0.9986652	191.436	1.8309	0.9981609
142	C-50	50% CO2 / 50% Ar	187.53160	1.71972	0.9977484	172.843	1.8786	0.9969777
24	C-75	75% CO2 / 25% Ar	168.22500	1.76344	0.9965484	154.670	1.9271	0.995401
25	He-25	25% He / 75% Ar	231.60563	1.26598	0.9996422	216.008	1.3814	0.9999341
143	He-50	50% He / 50% Ar	236.15149	0.89829	0.9999188	220.464	0.9800	1.00039
26	He-75	75% He / 25% Ar	234.68601	0.53081	1.0001954	216.937	0.5792	1.000571
144	He-90	90% He / 10% Ar	222.14566	0.31041	1.0003614	205.813	0.3388	1.00057
27	A1025	90% He / 7.5% Ar / 2.5% CO2	214.97608	0.31460	1.0002511	201.175	0.3433	1.000556
28	Star29	Stargon C5 90% Ar / 8% CO2 / 2% O2	219.79340	1.64099	0.9991638	203.890	1.7918	0.998798

BIOREACTOR GASES			25°C				0°C			
Gas Number	Short Name	Long Name	Absolute Viscosity	Density 14.696 PSIA	Compressibility 14.696 PSIA	Absolute Viscosity	Density 14.696 PSIA	Compressibility 14.696 PSIA		
145	Bio-5M	5% CH4 / 95% CO2	148.46635	1.75026	0.9951191	136.268	1.9134	0.9935816		
146	Bio-10M	10% CH4 / 90% CO2	147.54809	1.69254	0.9952838	135.383	1.8500	0.993893		
147	Bio-15M	15% CH4 / 85% CO2	146.55859	1.63484	0.9954484	134.447	1.7867	0.9941932		
148	Bio-20M	20% CH4 / 80% CO2	145.49238	1.57716	0.9956130	133.457	1.7235	0.994482		
149	Bio-25M	25% CH4 / 75% CO2	144.34349	1.51950	0.9957777	132.407	1.6603	0.9947594		
150	Bio-30M	30% CH4 / 70% CO2	143.10541	1.46186	0.9959423	131.290	1.5971	0.9950255		
151	Bio-35M	35% CH4 / 65% CO2	141.77101	1.40424	0.9961069	130.102	1.5340	0.9952803		
152	Bio-40M	40% CH4 / 60% CO2	140.33250	1.34664	0.9962716	128.834	1.4710	0.9955239		
153	Bio-45M	45% CH4 / 55% CO2	138.78134	1.28905	0.9964362	127.478	1.4080	0.9957564		
154	Bio-50M	50% CH4 / 50% CO2	137.10815	1.23149	0.9966009	126.025	1.3450	0.9959779		
155	Bio-55M	55% CH4 / 45% CO2	135.30261	1.17394	0.9967655	124.462	1.2821	0.9961886		
156	Bio-60M	60% CH4 / 40% CO2	133.35338	1.11642	0.9969301	122.779	1.2193	0.9963885		
157	Bio-65M	65% CH4 / 35% CO2	131.24791	1.05891	0.9970948	120.959	1.1564	0.9965779		
158	Bio-70M	70% CH4 / 30% CO2	128.97238	1.00142	0.9972594	118.987	1.0936	0.9967567		
159	Bio-75M	75% CH4 / 25% CO2	126.51146	0.94395	0.9974240	116.842	1.0309	0.9969251		
160	Bio-80M	80% CH4 / 20% CO2	123.84817	0.88650	0.9975887	114.501	0.9681	0.9970832		
161	Bio-85M	85% CH4 / 15% CO2	120.96360	0.82907	0.9977533	111.938	0.9054	0.9972309		
162	Bio-90M	90% CH4 / 10% CO2	117.83674	0.77166	0.9979179	109.119	0.8427	0.9973684		
163	Bio-95M	95% CH4 / 5% CO2	114.44413	0.71426	0.9980826	106.005	0.7801	0.9974957		

BREATHING GASES			25°C			0°C		
Gas Number	Short Name	Long Name	Absolute Viscosity	Density 14.696 PSIA	Compressibility 14.696 PSIA	Absolute Viscosity	Density 14.696 PSIA	Compressibility 14.696 PSIA
164	EAN-32	32% O ₂ / 68% N ₂	186.86315	1.19757	0.9996580	174.925	1.3075	0.9993715
165	EAN	36% O ₂ / 64% N ₂	187.96313	1.20411	0.9996401	175.963	1.3147	0.9993508
166	EAN-40	40% O ₂ / 60% N ₂	189.06268	1.21065	0.9996222	176.993	1.3218	0.9993302
167	HeOx-20	20% O ₂ / 80% He	217.88794	0.39237	1.0002482	204.175	0.4281	1.000593
168	HeOx-21	21% O ₂ / 79% He	218.15984	0.40382	1.0002370	204.395	0.4406	1.000591
169	HeOx-30	30% O ₂ / 70% He	219.24536	0.50683	1.0001363	205.140	0.5530	1.000565
170	HeOx-40	40% O ₂ / 60% He	218.59913	0.62132	1.0000244	204.307	0.6779	1.000502
171	HeOx-50	50% O ₂ / 50% He	216.95310	0.73583	0.9999125	202.592	0.8028	1.000401
172	HeOx-60	60% O ₂ / 40% He	214.82626	0.85037	0.9998006	200.467	0.9278	1.000257
173	HeOx-80	80% O ₂ / 20% He	210.11726	1.07952	0.9995768	195.872	1.1781	0.9998019
174	HeOx-99	99% O ₂ / 1% He	205.72469	1.29731	0.9993642	191.646	1.4165	0.9990796
175	EA-40	Enriched Air-40% O ₂	189.42518	1.21429	0.9996177	177.396	1.3258	0.9993261
176	EA-60	Enriched Air-60% O ₂	194.79159	1.24578	0.9995295	182.261	1.3602	0.9992266
177	EA-80	Enriched Air-80% O ₂	200.15060	1.27727	0.9994412	186.937	1.3946	0.9991288
178	Metabol	Metabolic Exhalant (16% O ₂ / 78.04% N ₂ / 5% CO ₂ / 0.96% Ar)	180.95936	1.20909	0.9994833	170.051	1.3200	0.9992587

FUEL GASES			25°C				0°C				
Gas Number	Short Name	Long Name	Absolute Viscosity	Density 14.696 PSIA	Compressibility 14.696 PSIA	Absolute Viscosity	Density 14.696 PSIA	Compressibility 14.696 PSIA	Absolute Viscosity	Density 14.696 PSIA	Compressibility 14.696 PSIA
185	Syn Gas-1	40% H2 + 29% CO + 20% CO2 + 11% CH4	155.64744	0.79774	0.9989315	144.565	0.8704	0.9992763	144.565	0.8704	0.9992763
186	Syn Gas-2	64% H2 + 28% CO + 1% CO2 + 7% CH4	151.98915	0.43715	1.0001064	142.249	0.4771	1.000263	142.249	0.4771	1.000263
187	Syn Gas-3	70% H2 + 4% CO + 25% CO2 + 1% CH4	147.33686	0.56024	0.9991225	136.493	0.6111	0.9997559	136.493	0.6111	0.9997559
188	Syn Gas-4	88% H2 + 14% CO + 3% CH4	133.63682	0.24825	1.0003901	125.388	0.2709	1.000509	125.388	0.2709	1.000509
189	Nat Gas-1	93% CH4 / 3% C2H6 / 1% C3H8 / 2% N2 / 1% CO2	111.77027	0.70709	0.9979255	103.189	0.7722	0.9973965	103.189	0.7722	0.9973965
190	Nat Gas-2	95% CH4 / 3% C2H6 / 1% N2 / 1% CO2	111.55570	0.69061	0.9980544	103.027	0.7543	0.9974642	103.027	0.7543	0.9974642
191	Nat Gas-3	95.2% CH4 / 2.5% C2H6 / 0.2% C3H8 / 0.1% C4H10 / 1.3% N2 / 0.7% CO2	111.49608	0.68980	0.9980410	102.980	0.7534	0.9974725	102.980	0.7534	0.9974725
192	Coal Gas	50% H2 / 35% CH4 / 10% CO / 5% C2H4	123.68517	0.44281	0.9993603	115.045	0.6589	0.996387	115.045	0.6589	0.996387
193	Endo	75% H2 + 25% N2	141.72100	0.34787	1.0005210	133.088	0.3797	1.000511	133.088	0.3797	1.000511
194	HHO	66.67% H2 / 33.33% O2	180.46190	0.49078	1.0001804	168.664	0.5356	1.000396	168.664	0.5356	1.000396
195	HD-5	LPG 96.1% C3H8 / 1.5% C2H6 / 0.4% C3H6 / 1.9% n-C4H10	81.45829	1.83428	0.9836781	74.933	2.0128	0.9784565	74.933	2.0128	0.9784565
196	HD-10	LPG 85% C3H8 / 10% C3H6 / 5% n-C4H10	81.41997	1.85378	0.9832927	74.934	2.0343	0.9780499	74.934	2.0343	0.9780499

LASER GASES			25°C				0°C				
Gas Number	Short Name	Long Name	Absolute Viscosity	Density 14.696 PSIA	Compressibility 14.696 PSIA	Absolute Viscosity	Density 14.696 PSIA	Compressibility 14.696 PSIA	Absolute Viscosity	Density 14.696 PSIA	Compressibility 14.696 PSIA
179	LG-4.5	4.5% CO2 / 13.5% N2 / 82% He	199.24300	0.36963	1.0001332	187.438	0.4033	1.000551	187.438	0.4033	1.000551
180	LG-6	6% CO2 / 14% N2 / 80% He	197.87765	0.39910	1.0000471	186.670	0.4354	1.00053	186.670	0.4354	1.00053
181	LG-7	7% CO2 / 14% N2 / 79% He	197.00519	0.41548	0.9999919	186.204	0.4533	1.000514	186.204	0.4533	1.000514
182	LG-9	9% CO2 / 15% N2 / 76% He	195.06655	0.45805	0.9998749	184.835	0.4997	1.000478	184.835	0.4997	1.000478
183	HeNe-9	9% Ne / 91% He	224.68017	0.22301	1.0004728	211.756	0.2276	1.000516	211.756	0.2276	1.000516
184	LG-9.4	9.4% CO2 / 19.25% N2 / 71.35% He	193.78311	0.50633	0.9998243	183.261	0.5523	1.000458	183.261	0.5523	1.000458

O2 CONCENTRATOR GASES				25°C			0°C		
Gas Number	Short Name	Long Name	Absolute Viscosity	Density 14.696 PSIA	Compressibility 14.696 PSIA	Absolute Viscosity	Density 14.696 PSIA	Compressibility 14.696 PSIA	
197	OCG-89	89% O2 / 7% N2 / 4% Ar	204.53313	1.31033	0.9993849	190.897	1.4307	0.9990695	
198	OCG-93	93% O2 / 3% N2 / 4% Ar	205.62114	1.31687	0.9993670	191.795	1.4379	0.9990499	
199	OCG-95	95% O2 / 1% N2 / 4% Ar	206.16497	1.32014	0.9993580	192.241	1.4414	0.99904	

STACK GASES				25°C			0°C		
Gas Number	Short Name	Long Name	Absolute Viscosity	Density 14.696 PSIA	Compressibility 14.696 PSIA	Absolute Viscosity	Density 14.696 PSIA	Compressibility 14.696 PSIA	
200	FG-1	2.5% O2 / 10.8% CO2 / 85.7% N2 / 1% Ar	175.22575	1.22550	0.9992625	165.222	1.3379	0.9990842	
201	FG-2	2.9% O2 / 14% CO2 / 82.1% N2 / 1% Ar	174.18002	1.24729	0.9991056	164.501	1.3617	0.9989417	
202	FG-3	3.7% O2 / 15% CO2 / 80.3% N2 / 1% Ar	174.02840	1.25520	0.9990536	164.426	1.3703	0.9988933	
203	FG-4	7% O2 / 12% CO2 / 80% N2 / 1% Ar	175.95200	1.24078	0.9991842	166.012	1.3546	0.9990116	
204	FG-5	10% O2 / 9.5% CO2 / 79.5% N2 / 1% Ar	177.65729	1.22918	0.9992919	167.401	1.3419	0.9991044	
205	FG-6	13% O2 / 7% CO2 / 79% N2 / 1% Ar	179.39914	1.21759	0.9993996	168.799	1.3293	0.9991932	

CHROMATOGRAPHY GASES				25°C			0°C		
Gas Number	Short Name	Long Name	Absolute Viscosity	Density 14.696 PSIA	Compressibility 14.696 PSIA	Absolute Viscosity	Density 14.696 PSIA	Compressibility 14.696 PSIA	
29	P-5	5% CH4 / 95% Ar	223.91060	1.58505	0.9993265	207.988	1.7307	0.9990036	
206	P-10	10% CH4 90% Ar	221.41810	1.53622	0.9992857	205.657	1.6774	0.99895	

TROUBLESHOOTING

Display does not come on or is weak.

Check power and ground connections. Please reference the technical specifications (pages 50-64) to assure you have the proper power for your model.

Flow reading is approximately fixed either near zero or near full scale regardless of actual line flow.

Differential pressure sensor may be damaged. Avoid installations that can subject the sensor to excessive pressure differentials (see page 7). A common cause of this problem is instantaneous application of high-pressure gas as from a snap acting solenoid valve upstream of the meter. If you suspect that your pressure sensor is damaged please discontinue use of the meter and contact Alicat.

Displayed mass flow, volumetric flow, pressure or temperature is flashing and message MOV, VOV, POV or TOV is displayed:

Our flow meters and controllers display an error message (MOV = mass overrange, VOV = volumetric overrange, POV = pressure overrange, TOV = temperature overrange) when a measured parameter exceeds the range of the sensors in the device. When any item flashes on the display, neither the flashing parameter nor the mass flow measurement is accurate. Reducing the value of the flashing parameter to within specified limits will return the unit to normal operation and accuracy. If the unit does not return to normal contact Alicat.

Meter reads negative flow when there is a confirmed no flow condition.

This is an indication of an improper tare. If the meter is tared while there is flow, that flow is accepted as zero flow. When an actual zero flow condition exists, the meter will read a negative flow. Simply re-tare at the confirmed zero flow condition. Also note that while the meter is intended for positive flow, it will read negative flow with reasonable accuracy, but not to the full scale flow rate (it is not calibrated for bi-directional flow) and no damage will result.

Meter does not agree with another meter I have in line.

Volumetric meters are affected by pressure drops. Volumetric flow meters should not be compared to mass flow meters. Mass flow meters can be compared against one another provided there are no leaks between the two meters and they are set to the same standard temperature and pressure. Both meters must also be calibrated (or set) for the gas being measured. M-Series mass flow meters are normally set to Standard Temperature and Pressure conditions of 25° C and 14.696 psia. Note: it is possible to special order meters with a customer specified set of standard conditions. The calibration sheet provided with each meter lists its standard conditions.

When performing this comparison it is best to use the smallest transition possible between the two devices. Using small transitions will minimize lag and dead volume.

Flow flutters or is jumpy.

The meters are very fast and will pick up any actual flow fluctuations such as from a diaphragm pump, etc. Also, inspect the inside of the upstream connection for debris such a Teflon tape shreds.

Note: M-Series meters feature a programmable geometric running average (GRA) that can aid in allowing a rapidly fluctuating flow to be read (see “Pressure Averaging” and “Flow Averaging” page 20).

The output signal is lower than the reading at the display.

This can occur if the output signal is measured some distance from the meter, as voltage drops in the wires increase with distance. Using heavier gauge wires, especially in the ground wire, can reduce this effect.

RS-232 / RS-485 Serial Communications is not responding.

Check that your meter is powered and connected properly. Be sure that the port on the computer to which the meter is connected is active. Confirm that the port settings are correct per the RS-232 instructions in this manual (Check the RS-232 / RS-485 communications select screen for current meter readings). Close Hyperterminal® and reopen it. Reboot your PC. See pages 10, 11 and 25 for more information on RS-232 / RS-485 signals and communications.

Slower response than specified.

M-Series Meters feature a programmable Geometric Running Average (GRA). Depending on the full scale range of the meter, it may have the GRA set to enhance the stability/readability of the display, which would result in slower perceived response time. Please see “Pressure Averaging” and “Flow Averaging” on page 20.

Jumps to zero at low flow.

M-Series Meters feature a programmable zero deadband. The factory setting is usually 0.5% of full scale. This can be adjusted between NONE and 3.2% of full scale. See page 20.

Discrepancies between old and new units.

Please see “Standard Gas Data Tables” explanation on page 31.

Maintenance and Recalibration

General: M-Series Flow Meters require minimal maintenance. They have no moving parts. The single most important thing that affects the life and accuracy of these devices is the quality of the gas being measured. The meter is designed to measure CLEAN, DRY, NON-CORROSIVE gases.

Moisture, oil and other contaminants can affect the laminar flow elements. We recommend the use of in-line sintered filters to prevent large particulates from entering the measurement head of the instrument. Suggested maximum particulate sizes are as follows:

5 microns for units with FS flow ranges of 0-1 sccm or less.

20 microns for units with FS flow ranges between 0-2 sccm and 0-1 slpm.

50 microns for units with FS flow ranges of 0-1 slpm or more.

Recalibration: The recommended period for recalibration is once every year. A label located on the back of the meter lists the most recent calibration date. The meter should be returned to the factory for recalibration within one year from the listed date. Before calling to schedule a recalibration, please note the serial number on the back of the meter. The Serial Number, Model Number, and Date of Manufacture are also available on the Model Info display (page 24).

Cleaning: M-Series Flow Meters require no periodic cleaning. If necessary, the outside of the meter can be cleaned with a soft dry cloth. Avoid excess moisture or solvents.

For repair, recalibration or recycling of this product contact:

Alicat Scientific, Inc.
7641 N Business Park Drive
Tucson, Arizona 85743
USA
Phone: 520-290-6060
Fax: 520-290-0109
e-mail: info@alicat.com
Web site: www.alicat.com

Option: Totalizing Mode

Meters can be purchased with the Totalizing Mode option. This option adds an additional mode screen that displays the total flow (normally in the units of the main flow screen) that has passed through the device since the last time the totalizer was cleared.

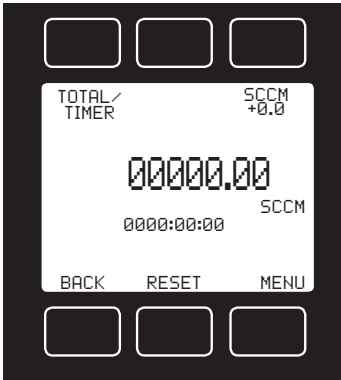

The Totalizing Mode screen is accessed by pushing the TOTAL button on the MAIN display.

TOTAL/TIMER: Pushing the TOTAL/TIMER button will cycle the large numbers on the display between total mass and time elapsed.

Rollover – The customer can also specify at the time of order what the totalizer is to do when the maximum count is reached. The following options may be specified:

No Rollover – When the counter reaches the maximum count it stops counting until the counter is cleared.

Rollover – When the counter reaches the maximum count it automatically rolls over to zero and continues counting until the counter is cleared.

Rollover with Notification – When the counter reaches the maximum count it automatically rolls over to zero, displays an overflow error, and continues counting until the counter is cleared.

TOTAL MASS: The counter can have as many as seven digits. At the time of order, the customer must specify the range. This directly affects the maximum count. For instance, if a range of 1/100ths of a liter is specified on a meter which is totalizing in liters, the maximum count would be 99999.99 liters. If the same unit were specified with a 1 liter range, the maximum count would be 9999999 liters.

ELAPSED TIME: The small numbers below the mass total show the elapsed time since the last reset in hours, minutes and seconds. The maximum measurable elapsed time is 9999 hours 59 minutes 59 seconds. The hours count resets when RESET is pushed, an RS-232 or RS-485 clear is executed or on loss of power. Press ELAPSED TIME to show this as the primary display.

RESET – The counter can be reset to zero at any time by pushing the RESET button. To clear the counter via RS-232 or RS-485, establish serial communication with the meter or controller as described in the RS-232 or RS-485 section of the manual. To reset the counter, enter the following commands:

In Polling (addressable) Mode: Address\$\$T <Enter> (e.g. B\$\$T <Enter>)

Alicat Portable Meters and Gauges

Alicat Rechargeable Flow Meters and Pressure Gauges use a Li-Ion 3.7V cell located in the top section of the device. **The Li-Ion cell must not be removed.**

Normal battery life of a fully-charged cell is 18 hours with a monochrome display or 5 hours with a TFT color display, when the backlight is set to 10. Dimming the backlight will increase battery life.

The battery can be charged through either the micro-USB port or the mini-DIN connector. When the device is connected to external power it will function normally while the battery is charging. **Note: If the battery has no charge, a charge time of one minute will be required before the unit can be turned on.** Charge rates will be fastest through the micro-USB port using the included power supply or equivalent. The device will charge fastest when it is turned off.

Recharge Time: 3.5 hours with 2A USB supply. The micro-USB port is for charging purposes only. The green/red indicator LED on top of the device will light up green to indicate that the unit is charging. The green LED will turn off when the battery is charged and the power switch is turned to "I" for ON.

The indicator LED flashes red when the device has about 1 hour of battery life remaining. The LED will flash red at a faster rate when the device has about 15 minutes of battery life remaining. It is highly recommended that the device be charged immediately. When the battery charge runs out with a color display, the display will shut off and device performance is no longer guaranteed. When the battery charge runs out on a monochrome display, the display contrast will turn to 0 and device performance is no longer guaranteed.



Output signals from the meter are passed through the mini-DIN connector on top of the device. Rechargeable battery units do not support 0-10V analog output. Receiver resistance must be below 250Ω.

Turn the power switch on top of the device to "O" for OFF when it is not in use.



Warning: If the device is left ON until the battery can no longer power it, the charge indicator will fall out of sync with the actual charge. The device can be re-synched by fully charging the battery once.

A Battery Charge Indicator appears below Tare on the display:

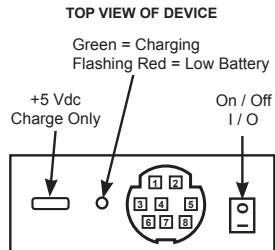
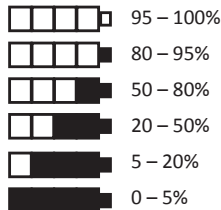
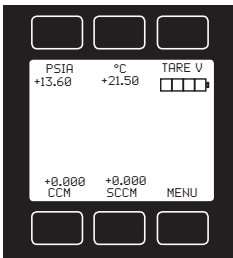

CAUTION! DO NOT OPERATE OR STORE THE DEVICE OUTSIDE OF THE -10° TO +50°C TEMPERATURE RANGE. IF INTERNAL SENSORS DETECT THAT THE TEMPERATURE IS OUTSIDE OF THIS RANGE, THE DISPLAY CONTRAST WILL TURN TO 0 AND THE METER'S PERFORMANCE IS NO LONGER GUARANTEED.

THE SAFE CHARGING TEMPERATURE RANGE IS 0° TO +45°C. IF INTERNAL SENSORS DETECT TEMPERATURES OUTSIDE OF THIS RANGE, THE BATTERY WILL NOT CHARGE.

Option: Remote Electronics for High Line or Gas Temperatures

Some applications involve operating temperatures outside the standard Alicat device specifications. A solution using remote electronics is available. (This option is not applicable for liquid devices.)

The flow body's components are minimized to only the required sensors. The flow data is sent to the microprocessor electronics up to 6 feet away from the sensor package.

Relocating the sensitive electronics allows for installation of the flow body in ambient temperatures as high as 85° Celsius with gas temperatures under 100° Celsius.

In these applications we recommend our custom gauge calibration at a gas temperature of up to 70° Celsius. This will reduce zero shift errors that occur when actual gas flow temperatures deviate substantially from the gas calibration temperature.

This configuration is also used in integrations that require a compact flow package at the installation point.



Option: Remote Panel Display



Our Remote Display option offers the flexibility of using Alicat's display with units that are embedded inside processes or instrument enclosures.

The Remote Display retains all of the same features as our standard display.

The Remote Display is ideal for:

- OEMs Remote Panel Mounting
- Embedded Systems
- Gas Panels
- Fuel Cell Test Stations
- Leak Detection Systems
- Artificial Environments

Accessory: BB9 Multi-Drop Box



The **BB9 Multi-Drop Box** makes it convenient to wire multiple flow and/or pressure devices to a single RS-232 or RS-485 port. **Now available with a USB interface!**

The Multi-Drop Box has nine 8 pin mini-DIN ports available. The ports are to be used with a standard double ended 8 pin mini-DIN (DC-62) style cable going from the box to each flow or pressure device.

A single DB9 D-SUB type connector (COM PORT) connects, using the included cable, to the serial connector on a PC or laptop.

All of the flow and/or pressure devices are powered via a terminal block on the front of the box.

If more than nine devices will be required, additional Multi-Drop Boxes can be daisy chained together with a double ended 8 pin mini-DIN cable plugged into any receptacle on both boxes.

BB9 Power Supply for Large Valve Controllers: The PS24VHC (Power Supply 24Vdc High Current) is a 6.5Amp 24Vdc power supply designed for running multiple large controllers on a BB9.

The 6.5Amp power supply can run as many as 8 large valve controllers, which makes it ideal for the BB9 and multiple large valve (or small valve / large valve combination) controllers on a BB9.

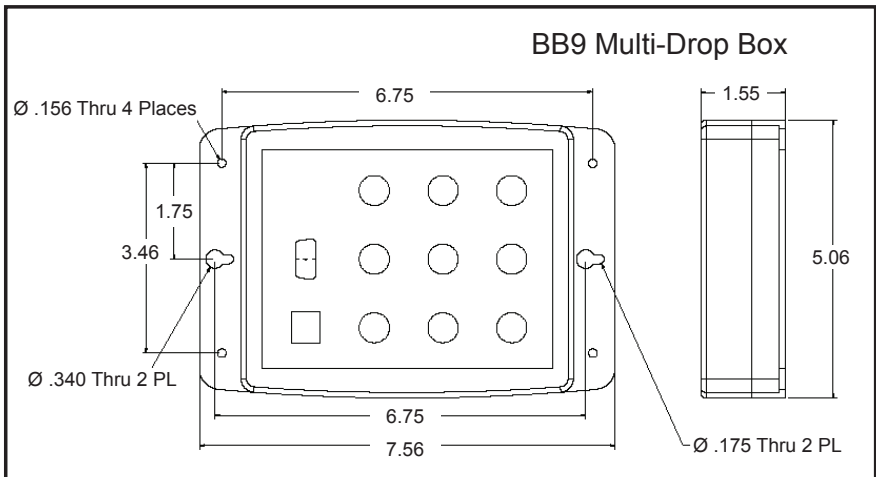

Accessory: Flow Vision™ SC Software

Flow Vision™ SC is an intuitive software interface to help your test cycles run smoother and shorten your engineering time!

Flow Vision™ SC lets you connect to and communicate with multiple Alicat units simultaneously. Now you can view virtual displays, control tabs, charts and data lines from every connected Alicat device on the same screen.

Flow Vision™ SC supports all RS-232 and RS-485 Serial communication functions, including: **gas selection, taring, set-point control, valve tuning and flow averaging.**

Session Saving: Save and reload your configuration data with confidence.

Script Building: Create scripts to adjust a controller's set-point value at variable specified time intervals.

Charting: Chart as many parameters as you want off as many devices as you want, with color coding, zooming, and printing functionality.

Alarms: Create software alarms that will notify you of given parameter conditions.

Data Capture & Logging: Capture and log data to either a .csv file or a .txt file. Improved Data Logging and Data Log File Splitting for easy to manage data.

Accessory: Flow Vision™ MX Software

Alicat's New Flow Vision™ MX software gives you an easy way to do GAS BLENDING using Alicat Mass Flow Controllers and your own PC.

Flow Vision™ MX software is a simple way to connect up to six Alicat mass flow controllers and create your own gas mix concentrations.

Using our inexpensive **BB9-USB** and a single USB connection you can:

- **Create** your own gas blends
- **Adjust** flow rates
- **Save** your specific blend formulas.

All the controllers can be powered through the BB9-USB with a single power supply.

Just connect your unique gases to each controller, select the gas type either locally on the controller or through Flow Vision™ MX, manifold the flow outputs and create your gas mix.

Accessories

Part Number	Description
FLOWVISIONSC	Flow Vision™ SC software for interface with all Alicat instruments
FLOWVISIONMX	Flow Vision™ MX software for gas blending
BB9	9 position Multi-Drop Box
BB9-I	9 position Multi-Drop Box, Industrial connectors
PVPS24U	Universal 100-240 VAC to 24 Volt DC Power Supply Adapter
PS24VHC	High current power supply for BB9 use with Large Valve Controllers
PCASE	Industrial carry and storage case for portable meters/gauges
DC-61	8 Pin Male Mini-DIN connector cable, single ended, 6 foot length
DC-251	8 Pin Male Mini-DIN connector cable, single ended, 25 foot length
DC-301	8 Pin Male Mini-DIN connector cable, single ended, 30 foot length
DC-501	8 Pin Male Mini-DIN connector cable, single ended, 50 foot length
DC-751	8 Pin Male Mini-DIN connector cable, single ended, 75 foot length
DC-6RT	8 Pin Male Right Angle Mini-Din Cable, single ended, 6 foot length
DC-62	8 Pin Male Mini-DIN connector cable, double ended, 6 foot length
DC-252	8 Pin Male Mini-DIN connector cable, double ended, 25 foot length
DC-502	8 Pin Male Mini-DIN connector cable, double ended, 50 foot length
DC-602	8 Pin Male Mini-DIN connector cable, double ended, 60 foot length
MD8DB9	8 Pin Male Mini-DIN to DB9 Female Adapter, 6 foot length
DBC-251	DB15 cable, single ended, 25 foot length
510199	DB9 cable, double-ended female, 3 meter length
IC10	Industrial cable, 6 Pin, single ended, 10 foot length
IC10-18G	18 gauge industrial cable, 6 Pin, single ended, 10 foot length
IC20	Industrial cable, 6 Pin, single ended, 20 foot length
IC24-18G	18 gauge industrial cable, 6 Pin, single ended, 24 foot length
IC50	Industrial cable, 6 Pin, single ended, 50 foot length
IC-102	Industrial cable, 6 pin double ended, 10 foot length
USB-RS232	RS-232 to USB Converter

Accessories

MNPT to Compression Fittings	
10-32 - 1/8"	SS-200-1-0157
10-32 - 1/4"	SS-400-1-0256
1/8" - 1/8"	SS-200-1-2
1/8" - 1/4"	SS-400-1-2
1/8" - 3/8"	SS-600-1-2
1/8" - 1/2"	SS-810-1-2
1/8" - 3mm	SS-3M0-1-2
1/8" - 4mm	SS-4M0-1-2
1/8" - 6mm	SS-6M0-1-2
1/8" - 8mm	SS-8M0-1-2
1/8" - 12mm	SS-12M0-1-2
1/4" - 1/8"	SS-200-1-4
1/4" - 1/4"	SS-400-1-4
1/4" - 3/8"	SS-600-1-4
1/4" - 1/2"	SS-810-1-4
1/4" - 3mm	SS-3M0-1-4
1/4" - 4mm	SS-4M0-1-4
1/4" - 6mm	SS-6M0-1-4
1/4" - 8mm	SS-8M0-1-4
1/4" - 12mm	SS-12M0-1-4
1/2" - 1/8"	SS-200-1-8
1/2" - 1/4"	SS-400-1-8
1/2" - 3/8"	SS-600-1-8
1/2" - 1/2"	SS-810-1-8
1/2" - 3/4"	SS-1210-1-8
1/2" - 6mm	SS-6M0-1-8
1/2" - 8mm	SS-8M0-1-8
1/2" - 12mm	SS-12M0-1-8
1/2" - 16mm	SS-16M0-1-8
3/4" - 1/4"	SS-400-1-12
3/4" - 1/2"	SS-810-1-12
3/4" - 3/4"	SS-1210-1-12
3/4" - 12mm	SS-12M0-1-12
3/4" - 16mm	SS-16M0-1-12

Filters & Elements FNPT-MNPT	
10-32 5μ	510053
10-32 20μ	510054
1/8" 20μ	ILF-1/8-20
1/4" 40μ	ILF-1/4-40
1/2" 40μ	ILF-1/2-40*
3/4" 40μ	ILF-3/4-40*
20μ element	ILFE20
40μ element	ILFE40
40μ element	ILFE40L*

Filters & Elements FNPT-FNPT*	
10-32 5μ	CF-303-20-316
*requires MNPT to MNPT coupler to interface with Alicat flow bodies	

10-32 Male UNF to 1/8 FNPT Adapter	
410133	
Male M5 (10-32) Buna-N O-ring face seal to 1/8" Female NPT	

Technical Data for Alicat M Mass Flow Meters

0 to 0.5 sccm Full Scale through 0 to 4000 slpm Full Scale

Standard Operating Specifications (Contact Alicat for available options)

Performance	M-Series Mass Flow Meter
Accuracy at calibration conditions after tare	± (0.8% of Reading + 0.2% of Full Scale)
High Accuracy at calibration conditions after tare	± (0.4% of Reading + 0.2% of Full Scale) High Accuracy option not available for units ranged under 5 sccm or over 500 slpm.
Accuracy for Bidirectional Meters at calibration conditions after tare	± (0.8% of reading + 0.2% of total span from positive full scale to negative full scale)
Repeatability	± 0.2% Full Scale
Zero Shift and Span Shift	0.02% Full Scale / °Celsius / Atm
Operating Range / Turndown Ratio	0.5% to 100% Full Scale / 200:1 Turndown
Maximum Measurable Flow Rate	128% Full Scale
Typical Response Time	10 ms (Adjustable)
Warm-up Time	< 1 Second

Operating Conditions	M-Series Mass Flow Meter
Mass Reference Conditions (STP)	25°C & 14.696 psia (standard — others available on request)
Operating Temperature	-10 to +50 °Celsius
Humidity Range (Non-Condensing)	0 to 100%
Maximum Internal Pressure (Static)	145 psig
Maximum Allowable Instantaneous Differential Pressure Across Device (Inlet to Outlet)	75 psid
Proof Pressure	175 psig
Mounting Attitude Sensitivity	None
Ingress Protection	IP40
Wetted Materials	303 & 302 Stainless Steel, Viton®, Silicone RTV (Rubber), Glass Reinforced Nylon, Aluminum. If your application demands a different material, please contact Alicat.

Communications / Power	M-Series Mass Flow Meter
Monochrome LCD or Color TFT Display with integrated touchpad	Simultaneously displays Mass Flow, Volumetric Flow, Pressure and Temperature
Digital Output Signal ¹ Options	RS-232 Serial / RS-485 Serial / Modbus / PROFIBUS ³
Analog Output Signal ² Options	0-5 Vdc / 1-5 Vdc / 0-10 Vdc / 4-20 mA
Optional Secondary Analog Output Signal ²	0-5 Vdc / 1-5 Vdc / 0-10 Vdc / 4-20 mA
Electrical Connection Options	8 Pin Mini-DIN / 9-pin D-sub (DB9) / 15-pin D-sub (DB15) / 6 pin locking
Supply Voltage	7 to 30 Vdc (15-30 Vdc for 4-20 mA outputs)
Supply Current	0.040 Amp (+ output current on 4-20 mA)
<p>1. The Digital Output Signal communicates Mass Flow, Volumetric Flow, Pressure and Temperature</p> <p>2. The Analog Output Signal and Optional Secondary Analog Output Signal communicate your choice of Mass Flow, Volumetric Flow, Pressure or Temperature</p> <p>3. If selecting PROFIBUS, no analog signal is available. See PROFIBUS specifications for supply voltages and currents (www.alicat.com/profibus). PROFIBUS and Modbus units do not have the display.</p>	

Range Specific Specifications

Full Scale Flow Mass Meter	Pressure Drop at FS Flow (psid) venting to atmosphere ¹	Mechanical Dimensions	Process Connections ²
0.5 sccm to 1 sccm	1.0	3.9"H x 2.4"W x 1.1"D	M-5 (10-32) Female Thread ³
2 sccm to 50 sccm	1.0		
100 sccm to 20 slpm	1.0	4.1"H x 2.4"W x 1.1"D	1/8" NPT Female
50 slpm	2.0	4.4"H x 4.0"W x 1.6"D	1/4" NPT Female
100 slpm	2.5		
250 slpm	2.1	5.0"H x 4.0"W x 1.6"D	1/2" NPT Female
500 slpm	4.0		
1000 slpm	6.0	5.0"H x 4.0"W x 1.6"D	3/4" NPT Female (A 1-1/4" NPT Female optional process connection is available for 2000 slpm meters.)
1500 slpm	9.0		
2000 slpm	5.0	5.3"H x 5.2"W x 2.9"D	1-1/4" NPT Female
3000 slpm	7.1	5.3"H x 5.2"W x 2.9"D	
4000 slpm	4.4	7.6"H x 5.2"W x 2.9"D	2" NPT Female

1. Lower Pressure Drops Available, please see our **WHISPER-Series** mass flow controllers at www.alicat.com/whisper.

2. Compatible with Beswick®, Swagelok® tube, Parker®, face seal, push connect and compression adapter fittings. VCR and SAE connections upon request.

3. Shipped with M-5 (10-32) Male Buna-N O-ring face seal to 1/8" Female NPT fittings.

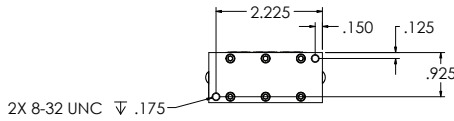
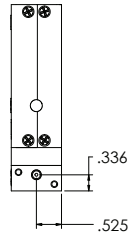
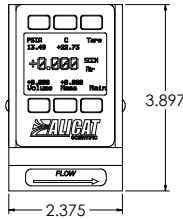
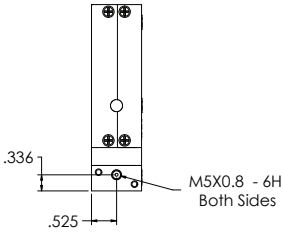
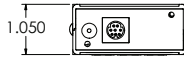

- M-Series:**
- 0 - 0.5 sccm
 - 0 - 1 sccm
 - 0 - 2 sccm
 - 0 - 5 sccm
 - 0 - 10 sccm
 - 0 - 20 sccm
 - 0 - 50 sccm

0.5 sccm to 50 sccm approximate shipping weight: 0.8 lb

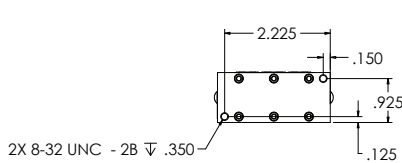
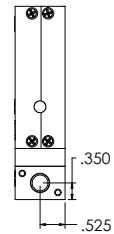
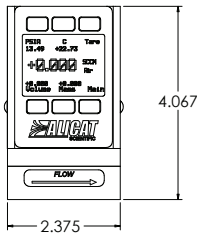
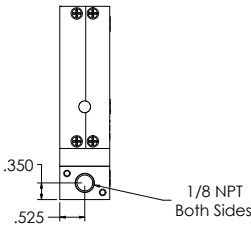
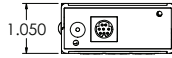

- M-Series:**
- 0 - 100 sccm
 - 0 - 200 sccm
 - 0 - 500 sccm
 - 0 - 1 slpm
 - 0 - 2 slpm
 - 0 - 5 slpm
 - 0 - 10 slpm
 - 0 - 20 slpm

100 sccm to 20 slpm approximate shipping weight: 1.0 lb

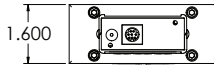

M-Series:
0 – 50 slpm
0 – 100 slpm

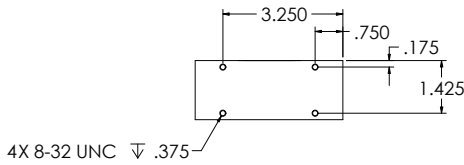
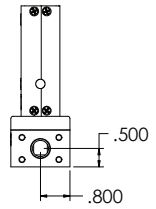
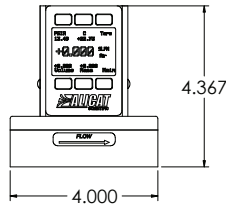
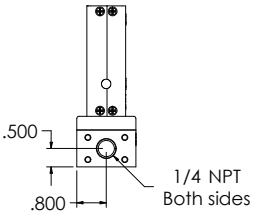

50 slpm to 100 slpm approximate shipping weight: 2.4 lb.

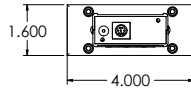

M-Series:
0 – 250 slpm

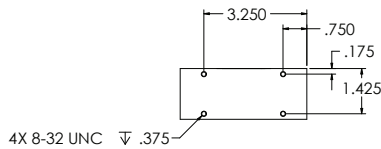
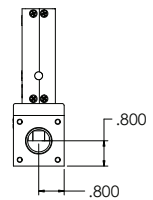
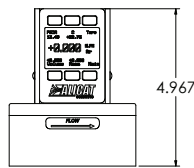
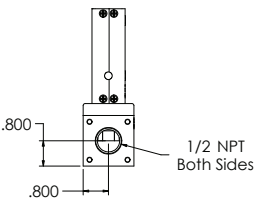

250 slpm approximate shipping weight: 3.2 lb.

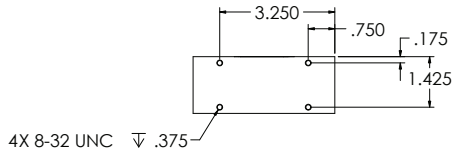
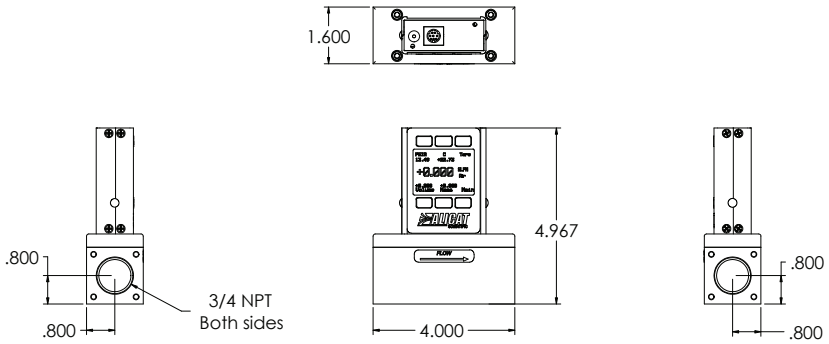

M-Series:
0 – 500 slpm
0 – 1000 slpm
0 – 1500 slpm

500 slpm to 1500 slpm approximate shipping weight: 3.5 lb

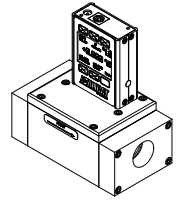
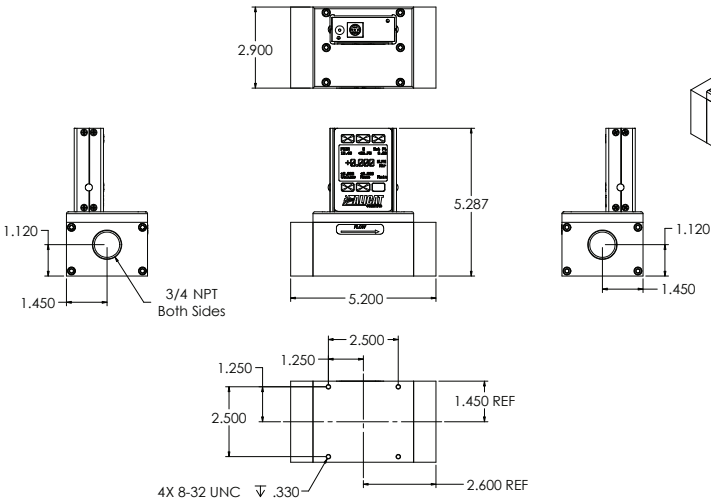

M-Series:
0 – 2000 slpm

2000 slpm approximate shipping weight: 4.5 lb

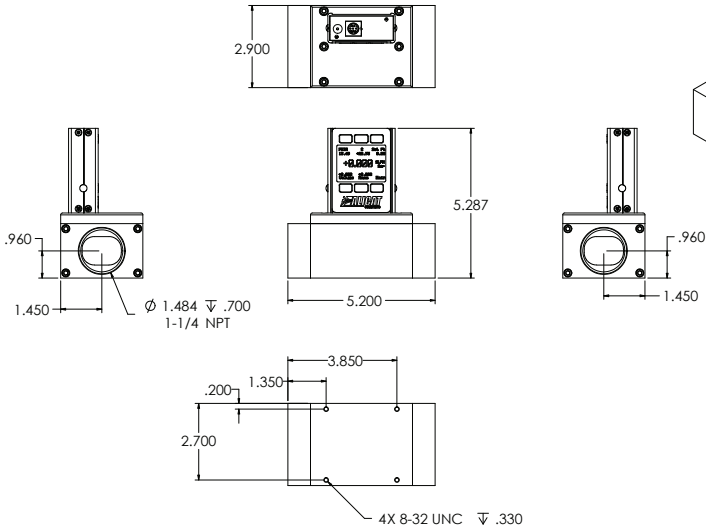

3000 slpm approximate shipping weight: 4.5 lb

M-Series:
0 – 4000 slpm

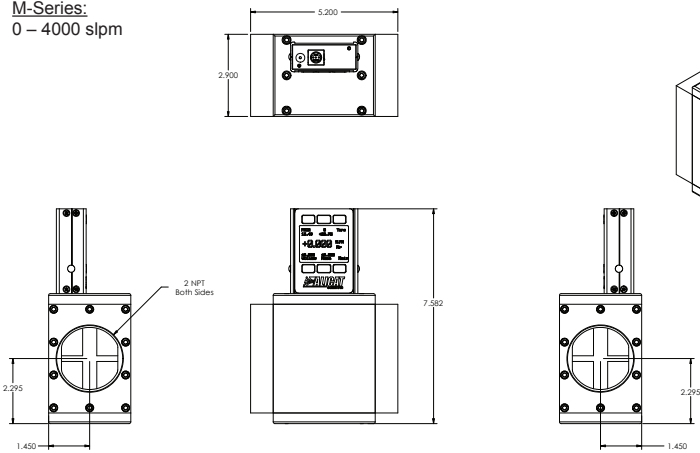

4000 slpm approximate shipping weight: 12.2 lb

Technical Data for WHISPER Low Pressure Drop Mass Flow Meters 0 to 0.5 sccm Full Scale through 0 to 500 slpm Full Scale

Standard Operating Specifications (Contact Alicat for available options.)

Performance	Whisper Mass Flow Meter
Accuracy at calibration conditions after tare	± (0.8% of Reading + 0.2% of Full Scale)
High Accuracy at calibration conditions after tare	± (0.4% of Reading + 0.2% of Full Scale) High Accuracy option not available for units ranged under 5 sccm or over 500 slpm.
Accuracy for Bidirectional Meters at calibration conditions after tare	± (0.8% of reading + 0.2% of total span from positive full scale to negative full scale)
Repeatability	± 0.2% Full Scale
Zero Shift and Span Shift	0.02% Full Scale / °Celsius / Atm
Operating Range / Turndown Ratio	0.5% to 100% Full Scale / 200:1 Turndown
Maximum Measurable Flow Rate	128% Full Scale
Typical Response Time	10 ms (Adjustable)
Warm-up Time	< 1 Second

Operating Conditions	Whisper Mass Flow Meter
Mass Reference Conditions (STP)	25°C & 14.696 psia (standard — others available on request)
Operating Temperature	-10 to +50 °Celsius
Humidity Range (Non-Condensing)	0 to 100%
Maximum Pressure	45 psig
Maximum Allowable Instantaneous Differential Pressure Across Device (Inlet to Outlet)	15 psid
Proof Pressure	175 psig
Mounting Attitude Sensitivity	None
Ingress Protection	IP40
Wetted Materials	303 & 302 Stainless Steel, Viton®, Silicone RTV (Rubber), Glass Reinforced Nylon, Aluminum If your application demands a different material, please contact Alicat.

Communications / Power	Whisper Mass Flow Meter
Monochrome LCD or Color TFT Display with integrated touchpad	Simultaneously displays Mass Flow, Volumetric Flow, Pressure and Temperature
Digital Output Signal ¹ Options	RS-232 Serial / RS-485 Serial / Modbus / PROFIBUS3
Analog Output Signal ² Options	0-5 Vdc / 1-5 Vdc / 0-10 Vdc / 4-20 mA
Optional Secondary Analog Output Signal ²	0-5 Vdc / 1-5 Vdc / 0-10 Vdc / 4-20 mA
Electrical Connection Options	8 Pin Mini-DIN / 9-pin D-sub (DB9) / 15-pin D-sub (DB15) / 6 pin locking
Supply Voltage	7 to 30 Vdc (15-30 Vdc for 4-20 mA outputs)
Supply Current	0.040 Amp (+ output current on 4-20 mA)

1. The **Digital Output Signal** communicates Mass Flow, Volumetric Flow, Pressure and Temperature
2. The **Analog Output Signal** and **Optional Secondary Analog Output Signal** communicate your choice of Mass Flow, Volumetric Flow, Pressure or Temperature
3. If selecting PROFIBUS, no analog signal is available. See PROFIBUS specifications for supply voltages and currents (www.alicat.com/profibus). PROFIBUS and Modbus units do not have the display.

Range Specific Specifications

Full Scale Flow Mass Meter	Pressure Drop at FS Flow (psid)venting to atmosphere	Mechanical Dimensions	Process Connections ¹
0.5 sccm to 2 sccm	0.06	3.9"H x 2.4"W x 1.1"D	M-5 (10-32) Female Thread²
5 sccm to 20 sccm	0.07		
50 sccm	0.07	4.1"H x 2.4"W x 1.1"D	1/8" NPT Female
100 sccm to 200 sccm	0.06		
500 sccm	0.07		
1 slpm to 5 slpm	0.07		
10 slpm	0.08	4.3"H x 2.7"W x 1.1"D	1/4" NPT Female
20 slpm	0.25	4.4"H x 4.0"W x 1.6"D	
40 slpm	0.12	5.0"H x 4.0"W x 1.6"D	1/2" NPT Female
50 slpm	0.14	5.0"H x 4.0"W x 1.6"D	3/4" NPT Female
100 slpm	0.24		
250 slpm	0.60		
500 slpm	0.39		
		5.3"H x 5.2"W x 2.9"D	3/4" NPT Female

1. Compatible with Beswick®, Swagelok® tube, Parker®, face seal, push connect and compression adapter fittings. VCR and SAE connections upon request.
2. Shipped with M-5 (10-32) Male Buna-N O-ring face seal to 1/8" Female NPT fittings.

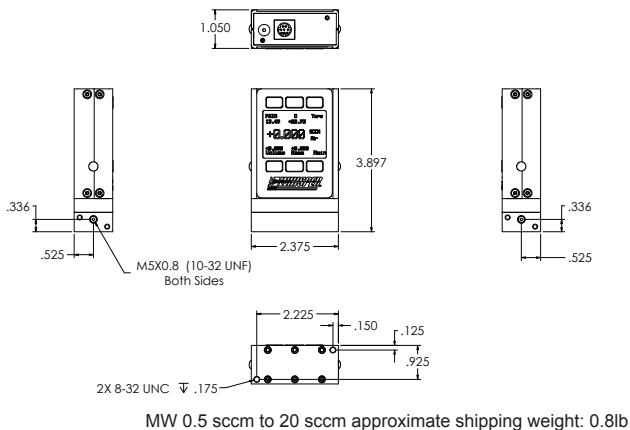

- WHISPER MW:
 0 – 0.5 sccm
 0 – 1 sccm
 0 – 2 sccm
 0 – 5 sccm
 0 – 10 sccm
 0 – 20 sccm

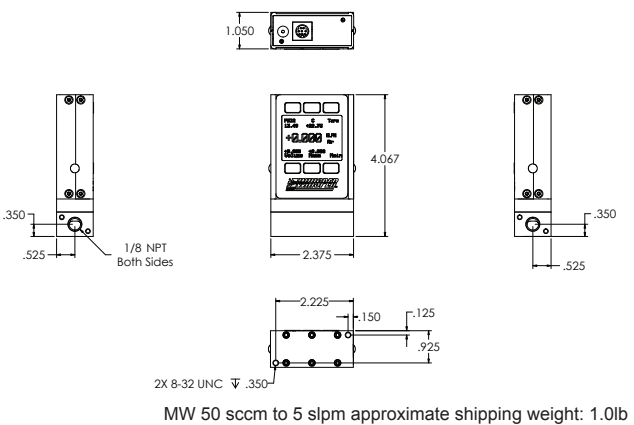

- WHISPER MW:
 0 – 50 sccm
 0 – 100 sccm
 0 – 200 sccm
 0 – 500 sccm
 0 – 1 slpm
 0 – 2 slpm
 0 – 5 slpm

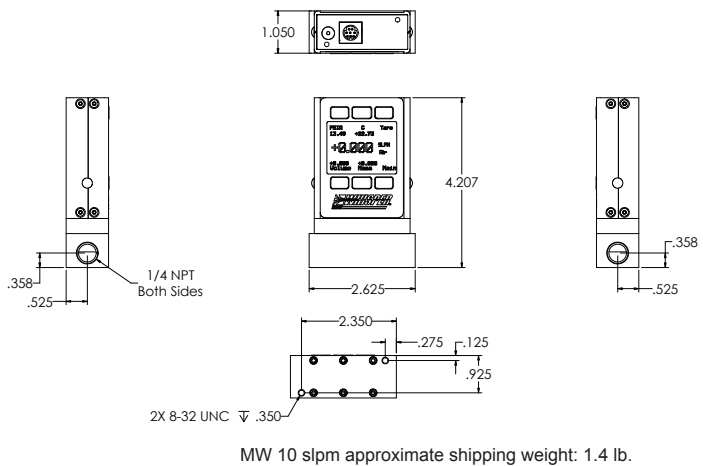

- WHISPER MW:
 0 – 10 slpm

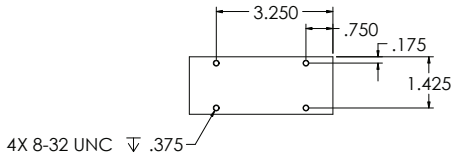
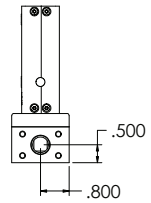
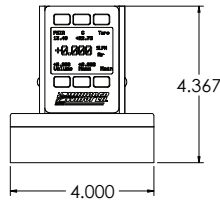
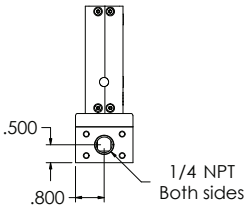
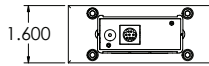

WHISPER MW:
0 – 20 slpm

MW 20 slpm approximate shipping weight: 2.4 lb.

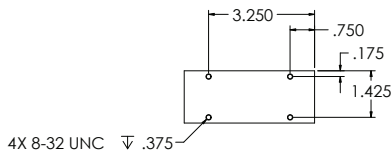
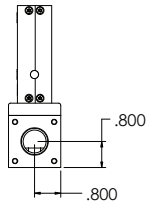
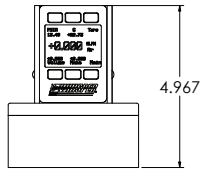
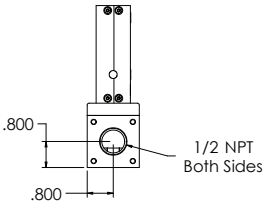
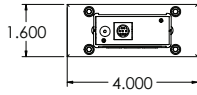

WHISPER MW:
0 – 40 slpm

MW 40 slpm approximate shipping weight: 3.2 lb.

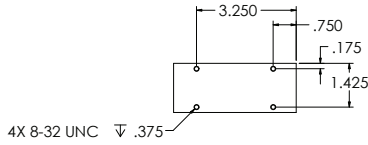
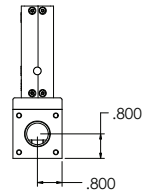
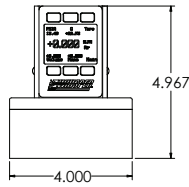
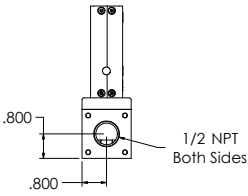
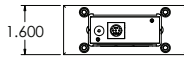

WHISPER MW:
0 – 50 slpm
0 – 100 slpm
0 – 250 slpm

MW 50 slpm to 250 slpm approximate shipping weight: 3.5lb

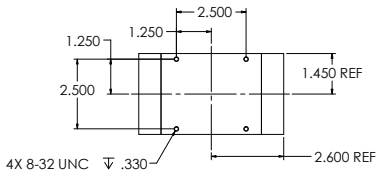
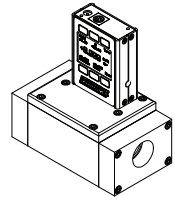
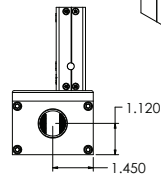
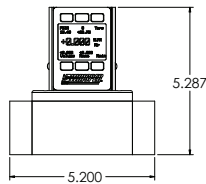
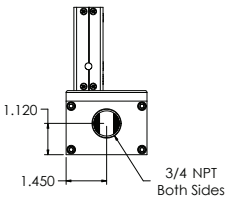
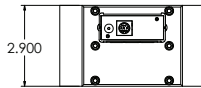

WHISPER MW:
0 – 500 slpm

MW 500 slpm approximate shipping weight: 4.5lb

Technical Data for Alicat MS-Series Mass Flow Meters

Alicat MS instruments are built for use with aggressive gases. For the most part, these instruments maintain the specifications of equivalently ranged M-Series devices.

Standard Compatible Gas List for MS-Series Meters

0	Air	Air	23	98% Ar / 2% CO2	C-2
1	Argon	Ar	24	75% CO2 / 25% Ar	C-75
2	Methane	CH4	25	75% Ar / 25% He	HE-75
3	Carbon Monoxide	CO	26	75% He / 25% Ar	HE-25
4	Carbon Dioxide	CO2	27	90% He / 7.5% Ar / 2.5% CO2 Helistar® A1025	A1025
5	Ethane	C2H6	28	90% Ar / 8% CO2 / 2% O2 Stargon® CS	Star29
6	Hydrogen	H2	29	95% Ar / 5% CH4	P-5
7	Helium	He	30	Nitric Oxide	NO
8	Nitrogen	N2	31	Nitrogen Trifluoride	NF3
9	Nitrous Oxide	N2O	32	Ammonia	NH3
10	Neon	Ne	33	Chlorine Gas	Cl2
11	Oxygen	O2	34	Hydrogen Sulfide	H2S
12	Propane	C3H8	35	Sulfur Dioxide	SO2
13	normal-Butane	n-C4H10	36	Propylene	C3H6
14	Acetylene	C2H2	In addition, the following gases are available upon request:		
15	Ethylene	C2H4	Nitrogen Dioxide to 0.5% in an inert carrier		NO2
16	iso-Butane	i-C4H10	Refrigerant gases to 100%		
17	Krypton	Kr			
18	Xenon	Xe			
19	Sulfur Hexafluoride	SF6			
20	75%Ar / 25% CO2	C-25			
21	90% Ar / 10% CO2	C-10			
22	92% Ar / 8% CO2	C-8			

If your application requires another gas or gas mixture, please contact Info@alicat.com or call 888-290-6060. We will do our best to accommodate your request.

Please refer to the Technical Data for the equivalently ranged M-Series instrument for all operating specifications except:

Operating Range	1% to 100%	Full Scale
Turndown Ratio	100 : 1	
Wetted Materials	316LSS, FFKM (Kalrez) standard; Viton, EPDM, Buna, Neoprene as needed for some gases.	

The dimensions of MS instruments may vary from their standard M-Series counterparts. Dimensional drawings for MS instruments are shown on pages 52-55.

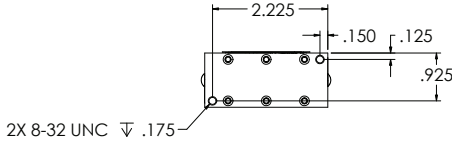
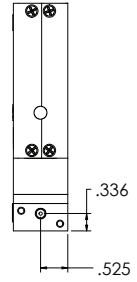
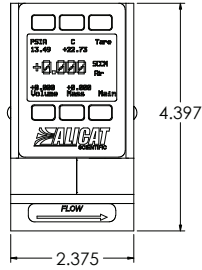
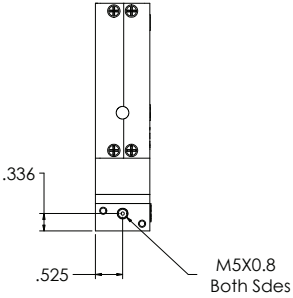
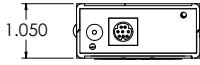

- MS-Series:**
- 0 – 0.5 sccm
 - 0 – 1 sccm
 - 0 – 2 sccm
 - 0 – 5 sccm
 - 0 – 10 sccm
 - 0 – 20 sccm
 - 0 – 50 sccm

0.5 sccm to 50 sccm approximate shipping weight: 0.81b

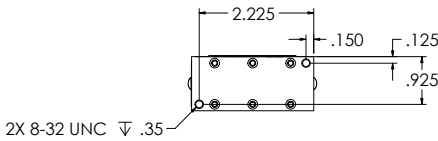
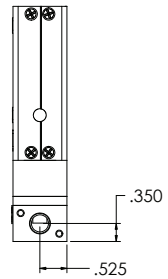
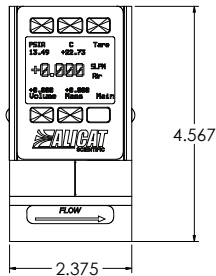
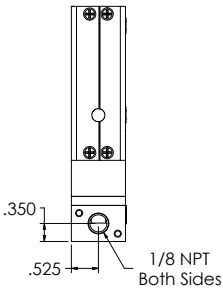
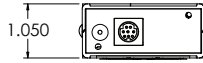

- MS-Series:**
- 0 – 100 sccm
 - 0 – 200 sccm
 - 0 – 500 sccm
 - 0 – 1 slpm
 - 0 – 2 slpm
 - 0 – 5 slpm
 - 0 – 10 slpm
 - 0 – 20 slpm

100 sccm to 20 slpm approximate shipping weight: 1.0 lb

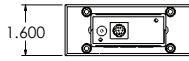

MS-Series:
 0 – 50 slpm
 0 – 100 slpm

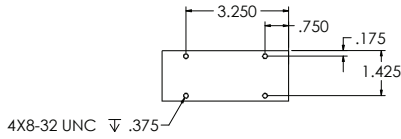
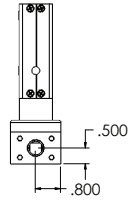
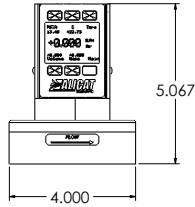
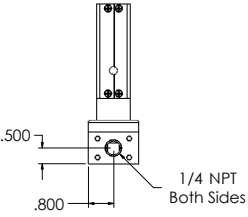

50 slpm to 100 slpm approximate shipping weight: 2.4 lb.

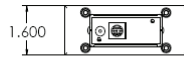

MS-Series:
 0 – 250 slpm

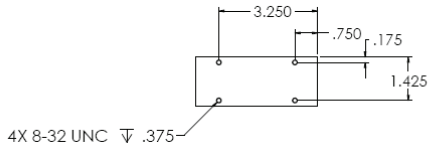
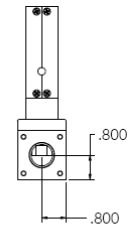
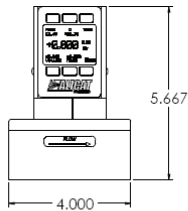
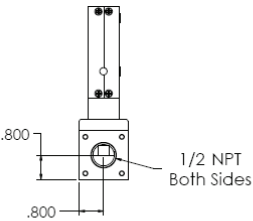

250 slpm approximate shipping weight: 3.2 lb.

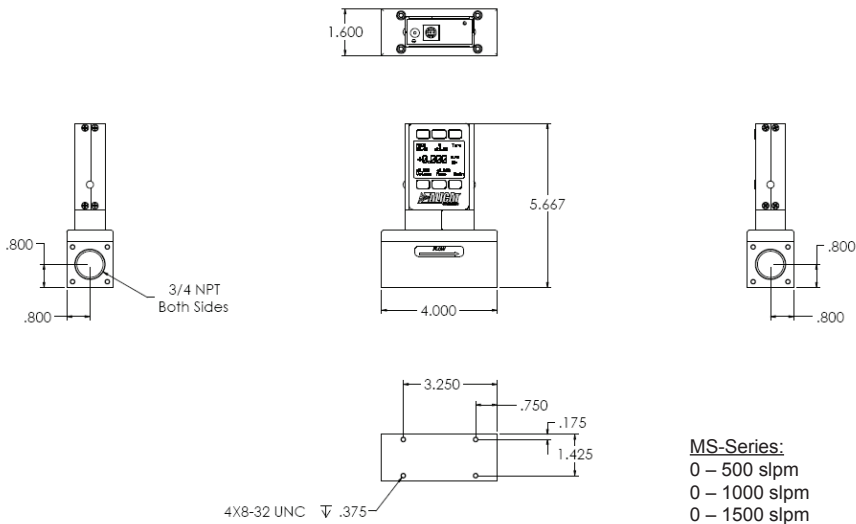

500 slpm to 1500 slpm approximate shipping weight: 3.5 lb

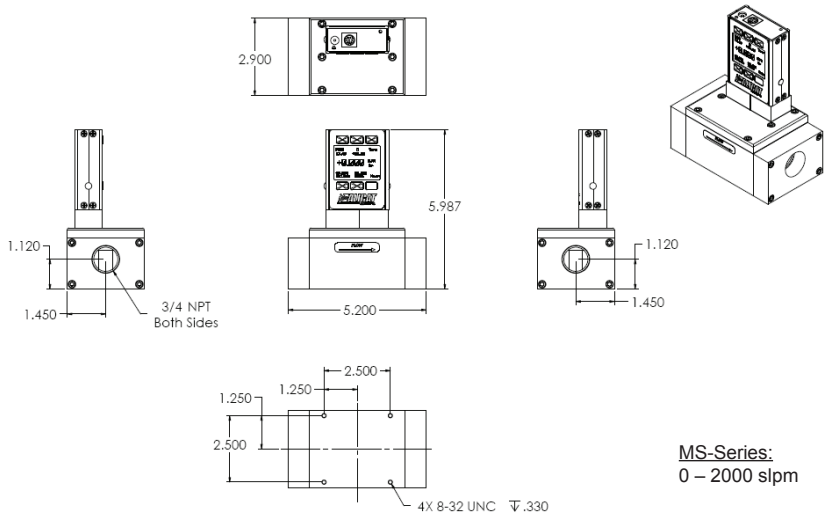

2000 slpm approximate shipping weight: 4.5 lb

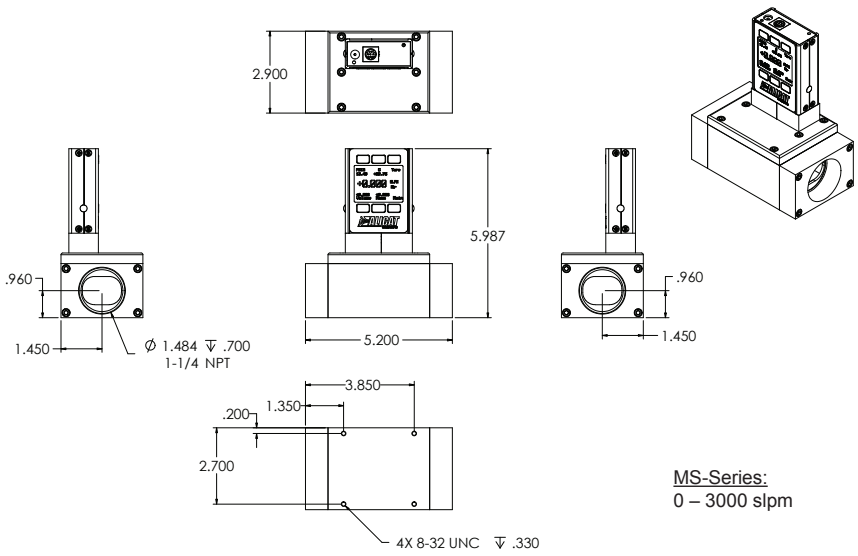

3000 slpm approximate shipping weight: 4.5 lb

MS-Series:
0 – 4000 slpm

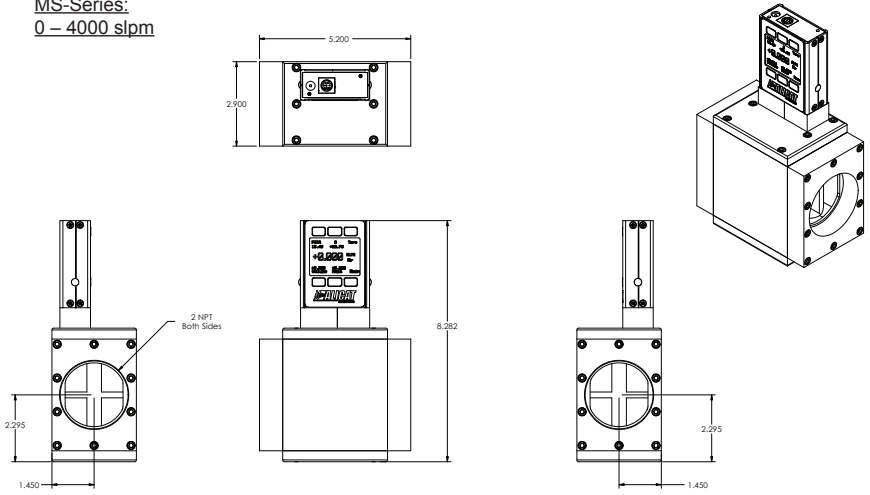

Technical Data for PROFIBUS Meters, Gauges and Controllers

NOTICE: The following specifications are applicable to Alicat PROFIBUS enabled meters, gauges and controllers only.

All other operating specifications are shown in the Technical Data page for standard Alicat instruments.

All standard device features and functions are available and operate in accordance with the standard Alicat Scientific device operating manual provided with the device.

Specification	Meter or Gauge	Small Valve Controller	Large Valve Controller	Description
Input /Output Signal Digital				PROFIBUS DP
Electrical Connections	DB9			
Supply Voltage:	7 to 30 Vdc	12 to 30 Vdc	24 to 30 Vdc	
Supply Current	80mA @ 12Vdc 65mA @ 24Vdc	295mA @ 12Vdc 280mA @ 24Vdc	780mA @ 24Vdc	

Power and Signal Connections:

Connect to the device using two DB9 connectors.

The female top connection is PROFIBUS.

The male connection on the side is power and RS-232 or RS-485.

Pin out diagrams for all PROFIBUS enabled Alicat devices are shown:

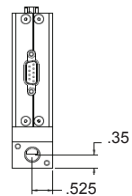
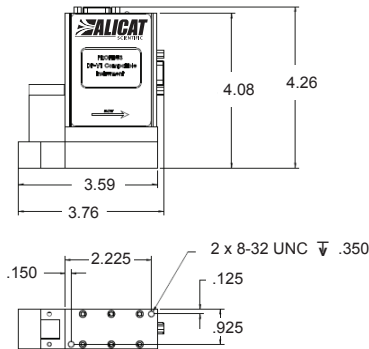
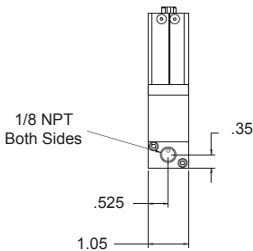
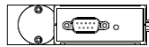
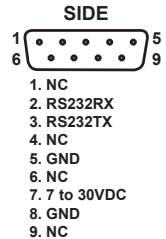
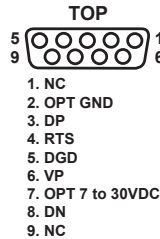

MC-1SLPM-PROFIBUS

PROFIBUS MC1SLPM shown to provide PROFIBUS connector dimensions only. Flow body and valve dimensions will vary with range. Please see Alicat's device specifications for complete dimensions.

PROFIBUS units do not have a display screen.

Eight Pin Mini-DIN Connector Pin-Outs

If your Alicat Instrument was ordered with the standard Eight Pin Mini-DIN connection, please be sure to reference the following pin-out diagram.

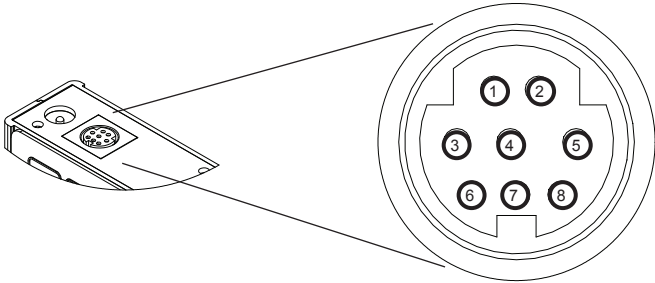

Standard 8 Pin Mini-DIN Pin-Out

Pin	Function	Mini-DIN cable color
1	Inactive (or optional 4-20mA Primary Output Signal)	Black
2	Static 5.12 Vdc [or optional Secondary Analog Output (4-20mA, 5Vdc, 10Vdc) or Basic Alarm]	Brown
3	Serial RS-232RX / RS-485(-) Input Signal (receive)	Red
4	Meters/Gauges = Remote Tare (Ground to Tare) Controllers = Analog Set-Point Input	Orange
5	Serial RS-232TX / RS-485(+) Output Signal (send)	Yellow
6	0-5 Vdc (or optional 0-10 Vdc) Output Signal	Green
7	Power In (as described above)	Blue
8	Ground (common for power, digital communications, analog signals and alarms)	Purple

Note: The above pin-out is applicable to all the flow meters and controllers with the Mini-DIN connector. The availability of different output signals depends on the options ordered. Optional configurations are noted on the unit's calibration sheet.

Locking Industrial Connector Pin-Outs

If your Alicat Instrument was ordered with a Six Pin Locking Industrial connection, please be sure to reference the following pin-out diagram.

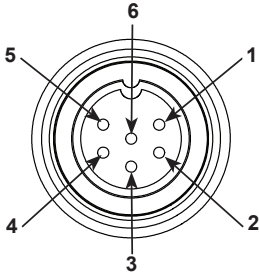

Male Connector: Cable

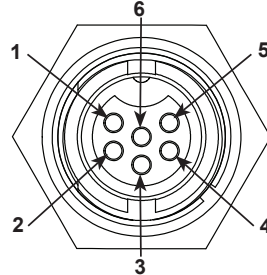

Female Connector: Device

Pin	Function
1	Power In (+)
2	RS-232TX / RS-485(+)
3	RS-232RX / RS-485(-)
4	Meters/Gauges = Remote Tare (Ground to Tare) Controllers = Analog Set-Point Input
5	Ground (common for power, communications and signals)
6	Signal Out (Voltage or Current as ordered)



The above pin-out is applicable to all the flow meters and controllers ordered with the industrial connector. The availability of different output signals depends on the flow meter options ordered.



The locking industrial connector is standard on all CSA/ATEX approved devices. RS-485 is not available on CSA/ATEX approved devices.



If your instrument was ordered with a DB9 connection, be sure to check the Calibration Label on the device and reference the appropriate pin-out diagram.

Standard DB9 Pin-out

The following pin-out chart describes the safest and generally compatible arrangement when connecting a non-Alicat DB9 wire to a **DB9** equipped Alicat. Not all features may be available between brands, but the common denominators are featured in our DB9 offerings, along with some options for customization.

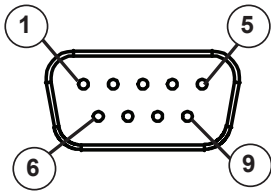

Male Connector Front View

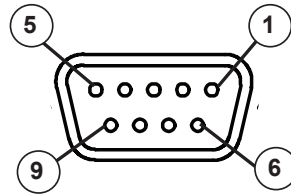

Female Connector Front View

Pin	Function
1	Not Connected (4-20mA analog output signal optional)
2	5.12 Vdc or (secondary analog output (4-20mA, 5Vdc, 10Vdc or alarm optional)
3	Serial RS-232RX or RS-485(-)
4	Analog Input Signal [4-20mA, 5Vdc, or 10Vdc] (short to ground for remote tare function on non-controllers)
5	Serial RS-232TX or RS-485(+)
6	0-5 Vdc Output Signal (or 0-10 Vdc optional)
7	Power In (+Vdc)
8	Ground (common for power, digital communications, analog signals and alarms)
9	Ground (common for power, digital communications, analog signals and alarms)

Note: The above pin-out is applicable to all the flow meters and controllers with the **DB9** connector. The availability of different output signals depends on the options ordered. Optional configurations are noted on the unit's calibration sheet.



Do not connect RS-485 to RS-232 units or cables. Damage will occur! Check part number or contact factory to verify RS-485 functionality.



Due to variance in cable manufacturing, please identify proper wiring/pins via continuity check & color when using blunt cut multi-strand cables.



If your instrument was ordered with a DB9 connection, be sure to check the Calibration Label on the device and reference the appropriate pin-out diagram.

DB9A Pin-out

The following pin-out chart describes the safest and generally compatible arrangement when connecting a non-Alicat DB9 wire to a **DB9A** equipped Alicat. Not all features may be available between brands, but the common denominators are featured in our DB9N offerings, along with some options for customization.

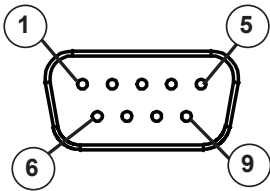

Male Connector Front View

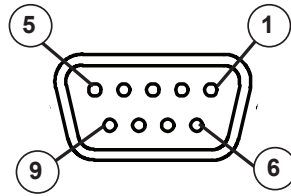

Female Connector Front View

Pin	Function
1	Not Connected
2	0-5 Vdc Output Signal (or 0-10 Vdc optional)
3	Power In (+Vdc)
4	Ground (common for power, digital communications, analog signals and alarms)
5	Serial RS-232TX or RS-485 (+)
6	Analog Input Signal [4-20mA, 5Vdc, or 10Vdc] (short to ground for remote tare function on non-controllers)
7	Ground (common for power, digital communications, analog signals and alarms)
8	Ground (common for power, digital communications, analog signals and alarms)
9	Serial RS-232RX or RS-485 (-)

Note: The above pin-out is applicable to all the flow meters and controllers with the **DB9A** connector. The availability of different output signals depends on the options ordered. Optional configurations are noted on the unit's calibration sheet.



Do not connect RS-485 to RS-232 units or cables. Damage will occur! Check part number or contact factory to verify RS-485 functionality.



Due to variance in cable manufacturing, please identify proper wiring/pins via continuity check & color when using blunt cut multi-strand cables.



If your instrument was ordered with a DB9 connection, be sure to check the Calibration Label on the device and reference the appropriate pin-out diagram.

DB9N Pin-out

The following pin-out chart describes the safest and generally compatible arrangement when connecting a non-Alicat DB9 wire to a **DB9N** equipped Alicat. Not all features may be available between brands, but the common denominators are featured in our DB9N offerings, along with some options for customization.

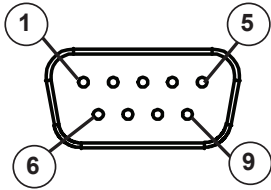

Male Connector Front View

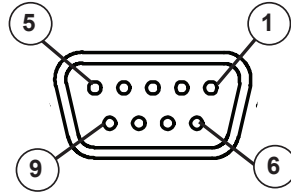

Female Connector Front View

Pin	Function
1	Power In (+Vdc)
2	Analog Input Signal [4-20mA, 5Vdc, or 10Vdc] (short to ground for remote tare function on non-controllers)
3	0-5 Vdc Output Signal (or 0-10 Vdc optional)
4	Not Connected
5	Ground (common for power, digital communications, analog signals and alarms)
6	Ground (common for power, digital communications, analog signals and alarms)
7	Serial RS-232RX or RS-485 (-)
8	Serial RS-232TX or RS-485 (+)
9	Not Connected
<p>Note: The above pin-out is applicable to all the flow meters and controllers with the DB9N connector. The availability of different output signals depends on the options ordered. Optional configurations are noted on the unit's calibration sheet.</p>	



Do not connect RS-485 to RS-232 units or cables. Damage will occur! Check part number or contact factory to verify RS-485 functionality.



Due to variance in cable manufacturing, please identify proper wiring/pins via continuity check & color when using blunt cut multi-strand cables.



If your instrument was ordered with a DB9 connection, be sure to check the Calibration Label on the device and reference the appropriate pin-out diagram.

DB9R Pin-out

The following pin-out chart describes the safest and generally compatible arrangement when connecting a non-Alicat DB9 wire to a **DB9R** equipped Alicat. Not all features may be available between brands, but the common denominators are featured in our DB9R offerings, along with some options for customization.

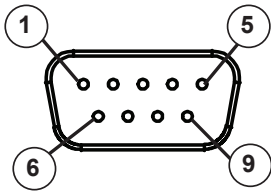

Male Connector Front View

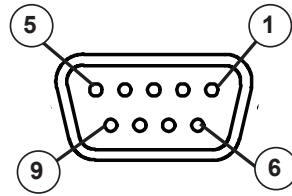

Female Connector Front View

Pin	Function
1	Serial RS-232TX or RS-485 (+)
2	0-5 Vdc Output Signal (or 0-10 Vdc optional)
3	Analog Input Signal [4-20mA, 5Vdc, or 10Vdc] (short to ground for remote tare function on non-controllers)
4	Ground (common for power, digital communications, analog signals and alarms)
5	Not Connected
6	Serial RS-232RX or RS-485 (-)
7	Power In (+Vdc)
8	Ground (common for power, digital communications, analog signals and alarms)
9	Ground (common for power, digital communications, analog signals and alarms)

Note: The above pin-out is applicable to all the flow meters and controllers with the **DB9R** connector. The availability of different output signals depends on the options ordered. Optional configurations are noted on the unit's calibration sheet.



Do not connect RS-485 to RS-232 units or cables. Damage will occur! Check part number or contact factory to verify RS-485 functionality.



Due to variance in cable manufacturing, please identify proper wiring/pins via continuity check & color when using blunt cut multi-strand cables.



If your instrument was ordered with a DB9 connection, be sure to check the Calibration Label on the device and reference the appropriate pin-out diagram.

DB9T Pin-out

The following pin-out chart describes the safest and generally compatible arrangement when connecting a non-Alicat DB9 wire to a **DB9T** equipped Alicat. Not all features may be available between brands, but the common denominators are featured in our DB9T offerings, along with some options for customization.

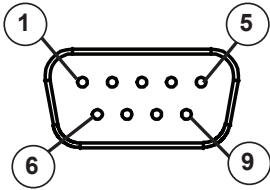

Male Connector Front View

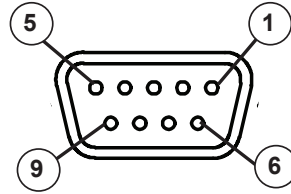

Female Connector Front View

Pin	Function
1	Serial RS-232TX or RS-485 (+)
2	0-5 Vdc Output Signal (or 0-10 Vdc optional)
3	Power In (+Vdc)
4	Ground (common for power, digital communications, analog signals and alarms)
5	Not Connected
6	Analog Input Signal [4-20mA, 5Vdc, or 10Vdc] (short to ground for remote tare function on non-controllers)
7	Ground (common for power, digital communications, analog signals and alarms)
8	Ground (common for power, digital communications, analog signals and alarms)
9	Serial RS-232RX or RS-485 (-)

Note: The above pin-out is applicable to all the flow meters and controllers with the **DB9T** connector. The availability of different output signals depends on the options ordered. Optional configurations are noted on the unit's calibration sheet.



Do not connect RS-485 to RS-232 units or cables. Damage will occur! Check part number or contact factory to verify RS-485 functionality.



Due to variance in cable manufacturing, please identify proper wiring/pins via continuity check & color when using blunt cut multi-strand cables.



If your instrument was ordered with a DB9 connection, be sure to check the Calibration Label on the device and reference the appropriate pin-out diagram.

DB9U Pin-out

The following pin-out chart describes the safest and generally compatible arrangement when connecting a non-Alicat DB9 wire to a **DB9U** equipped Alicat. Not all features may be available between brands, but the common denominators are featured in our DB9U offerings, along with some options for customization.

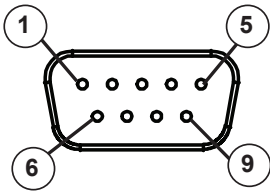

Male Connector Front View

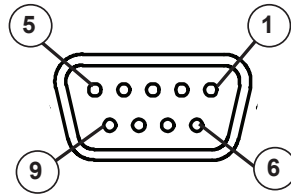

Female Connector Front View

Pin	Function
1	Serial RS-232RX or RS-485(-)
2	0-5 Vdc Output Signal (or 0-10 Vdc optional)
3	Power In (+Vdc)
4	Ground (common for power, digital communications, analog signals and alarms)
5	Not Connected
6	Analog Input Signal [4-20mA, 5Vdc, or 10Vdc] (short to ground for remote tare function on non-controllers)
7	Ground (common for power, digital communications, analog signals and alarms)
8	Ground (common for power, digital communications, analog signals and alarms)
9	Serial RS-232TX or RS-485(+)

Note: The above pin-out is applicable to all the flow meters and controllers with the **DB9U** connector. The availability of different output signals depends on the options ordered. Optional configurations are noted on the unit's calibration sheet.



Do not connect RS-485 to RS-232 units or cables. Damage will occur! Check part number or contact factory to verify RS-485 functionality.



Due to variance in cable manufacturing, please identify proper wiring/pins via continuity check & color when using blunt cut multi-strand cables.

DB15 Pin-Outs

If your instrument was ordered with a DB15 connection, be sure to check the Calibration Label on the device and reference the appropriate pin-out diagram.

The following pin-out chart describes the safest and generally compatible arrangement when connecting a non-Alicat DB15 wire to a **DB15** equipped Alicat. Not all features may be available between brands, but the common denominators are featured in our DB15 offerings, along with some options for customization.

DB15 – Pin-Out Alicat Style

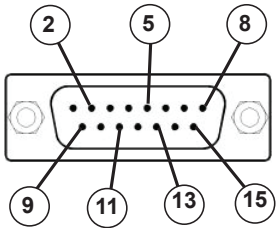

Male Connector Front View

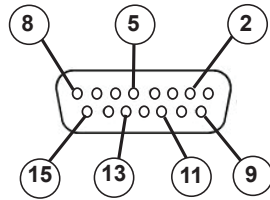

Female Connector Front View

Pin Number	Function
1	Ground
2	Primary Analog Signal Output
3	Ground
4	N/C
5	Power Supply (+Vdc)
6	N/C
7	N/C
8	Analog Tare (meters — when grounded) Analog Set-Point Input (controllers)
9	Power Supply Common
10	Ground
11	Secondary Analog Signal Output / fixed 5.12Vdc
12	N/C
13	RS-232 RX (receive) or RS-485 –
14	Ground
15	RS-232 TX (send) or RS-485 +

Check your device's calibration certificate and user manual for the actual electrical input/output requirements, as all instruments are custom configured to some extent.

NOTE: Pins 1, 3, 9, 10 and 14 are connected together inside of the device and are common grounding points.

N/C = Not Connected/Open (can be used for custom pin assignments – please consult factory).

DB15 Pin-Outs

If your instrument was ordered with a DB15 connection, be sure to check the Calibration Label on the device and reference the appropriate pin-out diagram.

The following pin-out chart describes the safest and generally compatible arrangement when connecting a non-Alicat DB15 wire to a **DB15A** equipped Alicat. Not all features may be available between brands, but the common denominators are featured in our DB15 offerings, along with some options for customization.

DB15A – Pin-Out “Aalborg XFM” Style

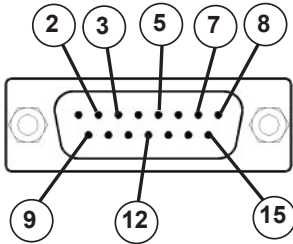

Male Connector Front View

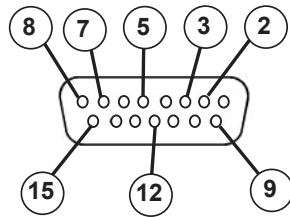

Female Connector Front View

Pin Number	Function
1	Ground
2	Primary Analog Signal Output
3	Analog Tare (meters — when grounded)* Analog Set-Point Input (controllers)*
4	Ground
5	Power Supply Common
6	Ground
7	Power Supply (+Vdc)
8	RS-232 Tx (send) / RS-485, A (-) [receive]
9	Ground
10	N/C
11	N/C
12	Secondary Analog Signal Output / fixed 5.12Vdc*
13	N/C
14	N/C
15	RS-232 Rx (receive) / RS-485, A (+) [send]

Check your device’s calibration certificate and user manual for the actual electrical input/output requirements, as all instruments are custom configured to some extent.

* Added to allow for full use of features on Alicat devices, may not be present on host wiring

NOTE: Pins 1, 4, 5, 6 and 9 are connected together inside of the device and are common grounding points.

N/C = Not Connected/Open (can be used for custom pin assignments – please consult factory).

DB15 Pin-Outs

If your instrument was ordered with a DB15 connection, be sure to check the Calibration Label on the device and reference the appropriate pin-out diagram.

The following pin-out chart describes the safest and generally compatible arrangement when connecting a non-Alicat DB15 wire to a **DB15B** equipped Alicat. Not all features may be available between brands, but the common denominators are featured in our DB15 offerings, along with some options for customization.

DB15B – Pin-Out “Brooks” Style

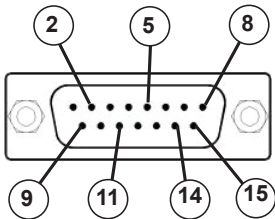

Male Connector Front View

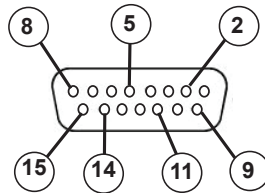

Female Connector Front View

Pin Number	Function
1	Ground
2	Primary Analog Signal Output
3	N/C
4	N/C
5	Power Supply (+Vdc)
6	N/C
7	N/C
8	Analog Tare (meters — when grounded) Analog Set-Point Input (controllers)
9	Power Supply Common
10	Ground
11	Secondary Analog Signal Output / fixed 5.12Vdc
12	N/C
13	N/C
14	RS-232 RX (receive) or RS-485 –
15	RS-232 TX (send) or RS-485 +

Check your device's calibration certificate and user manual for the actual electrical input/output requirements, as all instruments are custom configured to some extent.

NOTE: Pins 1, 9, and 10 are connected together inside of the device and are common grounding points.

N/C = Not Connected/Open (can be used for custom pin assignments – please consult factory).

DB15 Pin-Outs

If your instrument was ordered with a DB15 connection, be sure to check the Calibration Label on the device and reference the appropriate pin-out diagram.

The following pin-out chart describes the safest and generally compatible arrangement when connecting a non-Alicat DB15 wire to a **DB15K** equipped Alicat. Not all features may be available between brands, but the common denominators are featured in our DB15 offerings, along with some options for customization.

DB15K – Pin-Out “MKS” Style

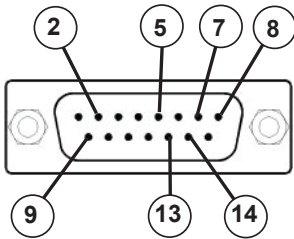

Male Connector Front View

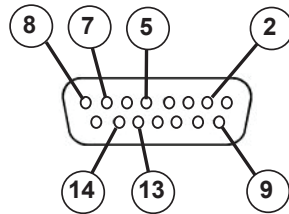

Female Connector Front View

Pin Number	Function
1	N/C
2	Primary Analog Signal Output
3	N/C
4	N/C
5	Power Supply Common
6	N/C
7	Power Supply (+Vdc)
8	Analog Tare (meters — when grounded) Analog Set-Point Input (controllers)
9	Secondary Analog Signal Output / fixed 5.12Vdc *
10	N/C
11	Ground
12	Ground
13	RS-232 RX (receive) or RS-485 – *
14	RS-232 TX (send) or RS-485 + *
15	Ground

Check your device's calibration certificate and user manual for the actual electrical input/output requirements, as all instruments are custom configured to some extent.

NOTE: Pins 5, 11, 12 and 15 are connected together inside of the device and are common grounding points.

N/C = Not Connected/Open (can be used for custom pin assignments – please consult factory).

* Added to allow for full use of features on Alicat devices, may not be present on host wiring.

DB15 Pin-Outs

If your instrument was ordered with a DB15 connection, be sure to check the Calibration Label on the device and reference the appropriate pin-out diagram.

The following pin-out chart describes the safest and generally compatible arrangement when connecting a non-Alicat DB15 wire to a **DB15H** equipped Alicat. Not all features may be available between brands, but the common denominators are featured in our DB15 offerings, along with some options for customization.

DB15H – Pin-Out “Hastings H” Style

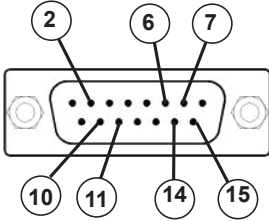

Male Connector Front View

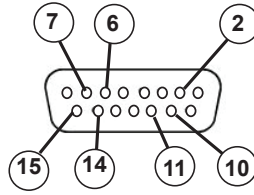

Female Connector Front View

Pin Number	Function
1	N/C
2	RS-232 RX (receive) or RS-485 – *
3	N/C
4	N/C
5	Ground
6	Primary Analog Signal Output
7	Power Supply Common
8	N/C
9	N/C
10	Secondary Analog Signal Output / fixed 5.12Vdc *
11	Power Supply (+Vdc)
12	Ground
13	N/C
14	Analog Tare (meters — when grounded) Analog Set-Point Input (controllers)
15	RS-232 TX (send) or RS-485 + *

Check your device’s calibration certificate and user manual for the actual electrical input/output requirements, as all instruments are custom configured to some extent.

NOTE: Pins 5, 7 and 12 are connected together inside of the device and are common grounding points.

N/C = Not Connected/Open (can be used for custom pin assignments – please consult factory).

* Added to allow for full use of features on Alicat devices, may not be present on host wiring.

DB15 Pin-Outs

If your instrument was ordered with a DB15 connection, be sure to check the Calibration Label on the device and reference the appropriate pin-out diagram.

The following pin-out chart describes the safest and generally compatible arrangement when connecting a non-Alicat DB15 wire to a **DB15S** equipped Alicat. Not all features may be available between brands, but the common denominators are featured in our DB15 offerings, along with some options for customization.

DB15S – Pin-Out “Sierra” Style

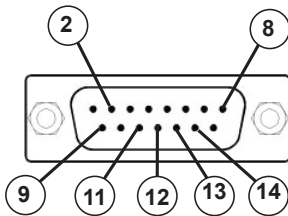

Male Connector Front View

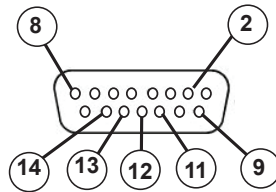

Female Connector Front View

Pin Number	Function
1	Ground
2	Primary Analog Signal Output
3	N/C
4	N/C
5	Ground
6	N/C
7	N/C
8	Analog Tare (meters — when grounded) Analog Set-Point Input (controllers)
9	Power Supply Common
10	Ground
11	Secondary Analog Signal Output / fixed 5.12Vdc *
12	RS-232 RX (receive) or RS-485 – *
13	Power Supply (+Vdc)
14	RS-232 TX (send) or RS-485 + *
15	Ground

Check your device’s calibration certificate and user manual for the actual electrical input/output requirements, as all instruments are custom configured to some extent.

NOTE: Pins 1, 5, 9, 10 and 15 are connected together inside of the device and are common grounding points.

N/C = Not Connected/Open (can be used for custom pin assignments – please consult factory).

* Added to allow for full use of features on Alicat devices, may not be present on host wiring.

Additional Information for Alicat CSA and ATEX Approved Devices
See the following page for Special Conditions regarding the use of these units!



EEx nA IIC T4

Class I, Div. 2 Group A, B, C and D T4

24 Vdc, 0.800A max

Class I, Zone 2 AEx nA IIC T4



WARNINGS:

EXPLOSION HAZARD – DO NOT DISCONNECT WHILE CIRCUIT IS LIVE UNLESS AREA IS KNOWN TO BE NON-HAZARDOUS.

EXPLOSION HAZARD – SUBSTITUTION OF COMPONENTS MAY IMPAIR SUITABILITY FOR CLASS I, DIVISION 2.

All Alicat CSA/ATEX approved devices are equipped with a locking 6 pin industrial connector. The power and signal connections are shown below.

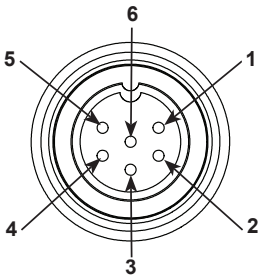

Male Connector: Cable

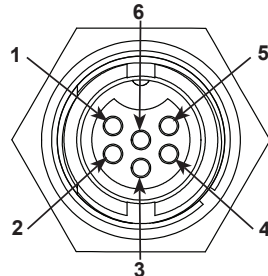

Female Connector: Device

Pin	Function
1	Power In (+)
2	RS-232TX
3	RS-232RX
4	Remote Tare Meters (Ground to Tare) Analog Set-Point Input (Controllers)
5	Ground (common for power, communications and signals)
6	Signal Out (Voltage or Current as ordered)

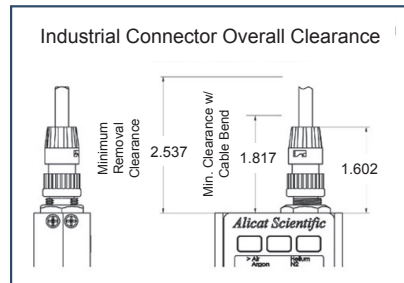

Clearance Requirements for Industrial Connector

USE of Alicat instruments (M, MW, MS, MC, MCW, MCS, MCR, MCRW, MCRS, P, PS, PC, PCS, PCR and PCRS product families only) in Class 1 Division 2 applications.



CSA certifies the use of this product for general use as well as use in hazardous locations as defined by Class 1 Division 2 Group A, B, C and D T4.

CSA certification is indicated by the product label as shown below and not by the statements in this, or any accompanying documentation.

Special Conditions:

To comply with CSA certification the following information is included in the product literature:

- When equipment is properly labeled, it is suitable in Class I, Division 2, Group A, B, C and D, T4
 - Tamb. -40°C to +50°C
- Electrical Rating 24Vdc, 0.800A max
- Instruments shall be powered by a CSA certified, UL listed, Class II external power supply suitable for the application
- Instruments shall be housed in an enclosure with a minimum IP54 rating or location providing equivalent protection
- Instrument's final approval shall be provided by the local authority having jurisdiction

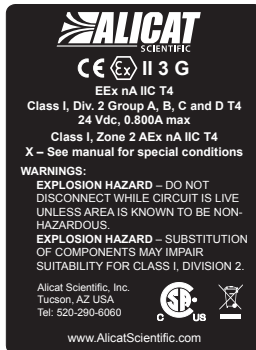

USE of Alicat instruments (M, MS, MC, MCS, MCR, MCRS, P, PS, PC, PCS, PCR and PCRS product families only) in applications requiring ATEX Certification.

Properly labeled Alicat instruments comply to the following ATEX standard:



 II 3 G EEx nA IIC T4 (-40°C ≤ Ta ≤ +50°C)

The examination certificate was issued by the CSA in accordance with accepted practices and procedures. This confirms compliance with the European ATEX Directive or Group II Category 3G equipment.

ATEX certification is indicated by the product label as shown above and not by the statements in this, or any accompanying documentation.

Special Conditions:

- Properly labeled equipment is only certified for use in ambient temperatures in the range of -40°C to +50°C only
- Electrical Rating 24Vdc, 0.800A max
- Instruments shall be powered by a CSA certified, UL listed, Class II external power supply suitable for the application
- Instruments shall be housed in an enclosure with a minimum IP54 rating or location providing equivalent protection
- Instrument's final approval shall be provided by the local authority having jurisdiction

Serial Number: _____

Model Number: _____

Notice: Alicat Scientific, Inc. reserves the right to make any changes and improvements to the products described in this manual at any time and without notice. This manual is copyrighted. This document may not, in whole or in part, be copied, reproduced, translated, or converted to any electronic medium or machine readable form, for commercial purposes, without prior written consent from the copyright holder.

Note: Although we provide assistance on Alicat Scientific products both personally and through our literature, it is the complete responsibility of the user to determine the suitability of any product to their application.

Limited Lifetime Warranty

Alicat Scientific, Inc. warrants to the original purchaser (hereinafter referred to as "Buyer") that instruments manufactured by Alicat Scientific (hereinafter referred to as "Product") shall be free from defects in materials and workmanship for the life of the Products.

Under this warranty, the Products will be repaired or replaced at manufacturer's option, without charge for parts or labor when the Product is carried or shipped prepaid to the factory together with proof of purchase. The foregoing shall constitute the exclusive and sole remedy in lieu of other remedies of the Buyer for any breach by Alicat Scientific of this warranty to the maximum extent permitted by law.

This warranty does not apply to any Product which has not been installed or used in accordance with the Product operation and installation specifications provided to Buyer verbally or in writing by Alicat Scientific for the proper and normal use of the Product.

Buyer agrees hereunder that Alicat reserves the right to void any warranty, written or implied, if upon Alicat's examination of Product shall disclose to Alicat's satisfaction that the Product failure was due solely, or in part, to accident, misuse, neglect, abuse, alteration, improper installation, unauthorized repair or improper testing by Buyer or agent of Buyer.

Alicat Scientific shall not be liable under any circumstances for indirect, special, consequential, or incidental damages in connection with, or arising out of, the sale, performance, or use of the Products covered by this warranty.

Alicat Scientific does not recommend, warrant or assume responsibility for the use of the Products in life support applications or systems.

Alicat's warranties as herein above set forth shall not be enlarged, diminished or affected by, and no obligation or liability shall arise or grow out of Alicat's rendering of technical advice in connection with Buyer's order of the Products furnished hereunder.

If Product becomes obsolete, Alicat Scientific, at its own discretion, reserves the right to repair the Product with available replacement parts or upgrade the Product to a current, commercially available version of the original Product. Should upgrading the Product be deemed necessary by Alicat, Buyer hereby agrees to pay an upgrade fee equal to seventy percent of the retail value of the replacement Product. Alicat Scientific hereunder makes no claim that replacement Products will look, function or operate in the same or similar manner as the original product.

When a Product is returned to Alicat Scientific for recalibration this service is considered normal preventative maintenance. Recalibration of Product shall not be treated as a warranty service unless recalibration of Product is required as the result of repairs to Product pursuant to this Warranty. Failure of Buyer to send Product to Alicat Scientific for recalibration on a yearly basis after a period of 36 months from date of manufacture will remove any and all obligations regarding repair or replacement of Product as outlined by this Warranty to Buyer from Alicat Scientific.

This Warranty is in lieu of all other relevant warranties, expressed or implied, including the implied warranty of merchantability and the implied warranty of fitness for a particular purpose, and any warranty against infringement of any patent.

Continued use or possession of Products after expiration of the applicable warranty period stated above shall be conclusive evidence that the warranty is fulfilled to the full satisfaction of Buyer.

Alicat makes no warranty as to experimental, non-standard or developmental Products.

Accessories purchased from Alicat are not covered by this warranty.

Conformity / Supplemental Information:

The product complies with the requirements of the Low Voltage Directive 2006/95/EC and the EMC Directive 2004/108/EC and carries the CE Marking accordingly. Contact the manufacturer for more information.

Gas Viscosity, Density and Compressibility:

#	Gas	Absolute Viscosity* 25°C	Density ** 25°C	Compressibility 25°C	
0	Air	184.8989	1.1840	0.9997	
1	Argon	226.2399	1.6339	0.9994	
2	Methane	110.7595	0.6569	0.9982	
3	Carbon Monoxide	176.4933	1.1453	0.9996	
4	Carbon Dioxide	149.3184	1.8080	0.9950	
5	Ethane	93.5412	1.2385	0.9924	
6	Hydrogen	H2	0.08235	1.0006	
7	Helium	He	0.16353	1.0005	
8	Nitrogen	N2	178.0474	1.1453	0.9998
9	Nitrous Oxide	N2O	148.4124	1.8089	0.9945
10	Neon	Ne	311.1264	0.8244	1.0005
11	Oxygen	O2	205.5021	1.3088	0.9994
12	Propane	C3H8	81.4631	1.8320	0.9838
13	normal-Butane	n-C4H10	74.0536	2.4493	0.9699
14	Acetylene	C2H2	104.4480	1.0720	0.9928
15	Ethylene	C2H4	103.1839	1.1533	0.9943
16	iso-Butane	i-C4H10	74.7846	2.4403	0.9735
17	Krypton	Kr	251.3249	3.4323	0.9979
18	Xenon	Xe	229.8483	5.3950	0.9947
19	Sulfur Hexafluoride	SF6	153.5320	6.0383	0.9887

Flow Conversions:

SCFM	1.00 = 28.3160	SLPM	SLPM	100.00 = 3.5316	SCFM
SCFH	1.00 = 0.4719	SLPM	SLPM	100.00 = 211.9093	SCFH
SCIM	100.00 = 1.6390	SLPM	SLPM	1.00 = 61.0128	SCIM
SCIH	1000.00 = 0.2732	SLPM	SLPM	1.00 = 3660.7688	SCIH

alicat.com

#	Gas	Absolute Viscosity* 25°C	Density ** 25°C	Compressibility 25°C	
20	75%Ar / 25% CO2	C-25	206.9763	1.6766	0.9987
21	90%Ar / 10% CO2	C-10	218.6026	1.6509	0.9991
22	92% Ar / 8% CO2	C-8	220.1352	1.6475	0.9992
23	98% Ar / 2% CO2	C-2	224.7148	1.6373	0.9993
24	75% CO2 / 25% Ar	C-75	168.2250	1.7634	0.9966
25	75% Ar / 25% He	HE-75	231.6056	1.2660	0.9997
26	75% He / 25% Ar	HE-25	234.6860	0.5308	1.0002
27	90% He / 7.5% Ar / 2.5% CO2	A1025	214.9760	0.3146	1.0003
28	90% Ar / 8% CO2 / 2% O2	Star29	219.7934	1.6410	0.9992
29	95% Ar / 5% CH4	P-5	223.9106	1.5850	0.9993

*In micropoise (1 Poise = gram / (cm) (sec))

**Grams/Liter

Reference: NIST REFPROP 9 Database

ALICAT

SCIENTIFIC

7641 N Business Park Drive
Tucson AZ 85743 USA

Phone: 888-290-6060 Fax: 520-290-0109
A HALMA COMPANY

The Fastest Flow Controller Company in the World!