

GENT Xenex range of

1,2,4 and 8 zone fire Control and Repeat panels

These instructions must be left on site with the person responsible for the fire alarm system.

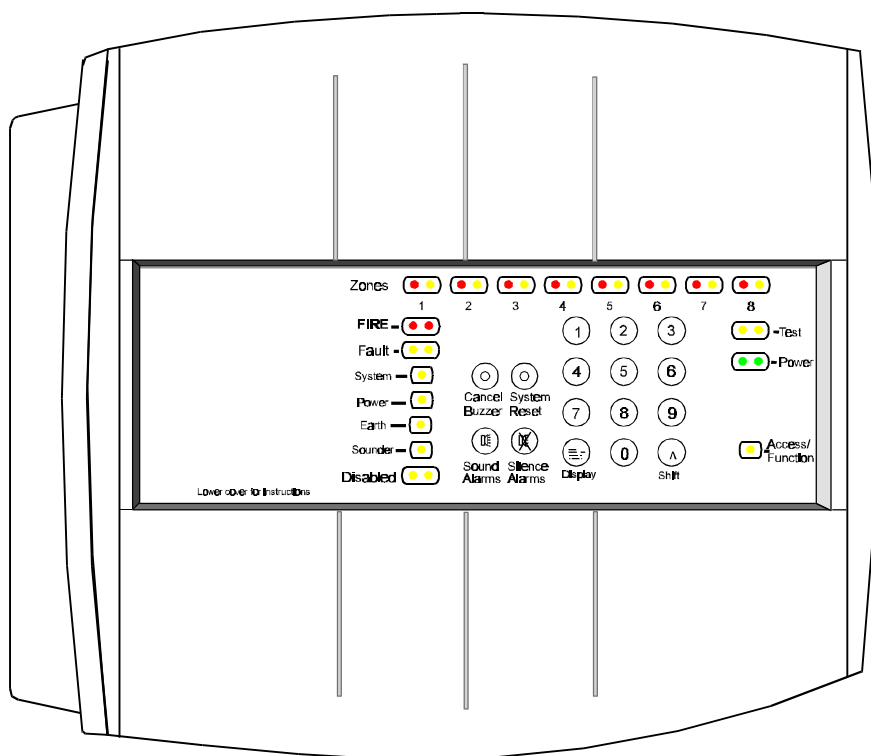

Figure 1 Fire alarm control / repeat panel

cdm64

This publication covers the:

- GENT range XEN1, XEN2, XEN4 and XEN8 fire alarm control panels.
- GENT XEN RPT fire alarm repeat panel.

Design and installation

Specifications	2
System design	5
Cables	8
Notes to the Installer	9
Panel fixing	10

Commissioning

Commissioning	13
Installed system tests	14
Access levels 2 & 3	15
System test functions	16
Panel configuration functions	17

Operation

User responsibility	19
Fault indications	21
Operating instructions	23

Parts list	25
-------------------	-----------

Specification for the Control panel

UK Model No. (with batteries)	XEN1	XEN2	XEN4	XEN8
Number of Zone (detection) circuits	1 - Zone	2 - Zone	4 - Zone	8 - Zone
Zone circuit load (maximum)	2mA per zone			
Number of Sounder circuits	2	2	4	8
Sounder circuit (shared load)	1A at 24V d.c. nominal		1.5A at 24V d.c. nominal	
End-of-line unit	Zone circuit: Capacitor (diode) unit Sounder circuit: 22K ohms resistor			
Standards	EN54 : Parts 2 & 4			
Flush fixing kit	✓	✓	✓	✓
Colour	Front cover - Grey RAL 7000 (standard)			
Assembled panel size (in mm)	395 wide x 274 high x 87 deep			
Weight (with batteries)	5.1Kg	5.1Kg	6.6Kg	6.6Kg
Operating temperature and humidity	0 - 40°C low to +95% RH non condensing			
Storage temperature and humidity	-5°C to +50°C low to +95% RH condensing			
Approvals	LPCB approval to be acquired			
Emission	BS EN50081-1:1992: Part 1 Residential, Commercial & Light industry Class B limits			
Immunity	BS EN50130-4: 1995: Part 4 Alarm systems : Electromagnetic compatibility Product family standard: <i>Immunity requirements for components of fire, intruder and social alarm systems</i>			
IP rating (BS5490)	IP31 (indoor)			
Mains operating voltage	230V ac +10% -6% 50Hz			
Knock-In cable entry points	13 - top & 13 - back			
Terminal size	2.5mm ² maximum			
Battery supply (sealed lead acid)	2-off12V 2.1Ah		2-off12V 2.8Ah	
Battery standby with 1mA load per zone and 1A total sounder alarm load	72hr standby plus 0.5hr with alarm load			
Auxiliary contacts (operates with fire)	Pair of normally closed (NC) and a pair of normally open (NO) contacts rated 1A @ 24V dc resistive load (Maximum 100m cable distance)			
Common Fault	Open collector - normally On (with 1K ohms limiting resistor)			
Common Fire	Open collector - normally Off (with 1K ohms limiting resistor)			
Class change	Normally open push button, up to 100m cable distance away from the panel			
24V Power supply (with foldback current limit)	100mA maximum at 24V d.c. nominal		250mA maximum at 24V d.c. nominal	
User access: By means of code entry via numeric key pad (AL1 Authorised user - No code is required)	AL2 Site security		3 digit code - 123	
	AL3 Site engineering		3 digit code - 321	
Key pad button controls	Sound alarm, Silence alarm, System Reset & Cancel buzzer & numeric keypad.			
Buzzer for local audible indications	Fire & System Fault - continuous sound Fault - intermittent sound (via piezoelectric buzzer operating at 2KHz 70dB(A) at 1m)			
Visual indications	FIRE & ZONES-fire (Red LEDs 'lights') ZONES-fault, Fault, System, Power, Earth, Sounder, Disable, Test, Power, Access/Function (Yellow LEDs 'lights') Power on (Green LED 'light')			
Repeat panel connections	Serial port , see also repeat panel specification			

Specification for the Repeat panel

UK Model number	XEN RPT
Number of Zones	8 - Zone (standard size)
Standard	EN54 : Parts 2 & 4
Flush fixing kit	✓
Colour	Front cover - Grey RAL 7000
Assembled panel size (in mm)	395 wide x 274 high x 87 deep
Weight (with batteries)	5.1Kg
Operating temperature and humidity	0 - 40°C low to +95% RH non condensing
Storage temperature and humidity	-5°C to +50°C low to +95% RH condensing
Approvals	LPCB approval to be acquired
Emission	BS EN50081-1:1992: Part 1 Residential, Commercial & Light industry Class B limits
Immunity	BS EN50130-4: 1995: Part 4 Alarm systems : Electromagnetic compatibility Product family standard: <i>Immunity requirements for components of fire, intruder and social alarm systems</i>
IP rating (BS5490)	IP31 (indoor)
Mains operating voltage	230V ac +10% -6% 50Hz
Knock-In cable entry points	Top & back entries
Terminal size	2.5mm ² maximum
Battery supply (sealed lead acid)	2-off 12V 2.1Ah
Standby duration	72hr standby
User access: By means of code entry via numeric key pad (AL1 Authorised user - No code is required)	AL2 Site security 3 digit code - 123 AL3 Site engineering 3 digit code - 321 <i>NOTE: Only a limited number of functions are accessible at the repeat panel.</i>
Key pad button controls	Sound alarm, Silence alarm, System Reset & Cancel buzzer & numeric keypad.
Buzzer for local audible indications	Fire & System Fault - continuous sound Fault - intermittent sound (via piezoelectric buzzer operating at 2KHz 70dB(A) at 1m)
Visual indications	FIRE & ZONES-fire (Red LEDs 'lights') ZONES-fault, Fault, System, Power, Earth, Sounder, Disable, Test, Power, Access/Function (Yellow LEDs 'lights') Power on (Green LED 'light')
Repeat panel (standard 8 zone)	A maximum of up to 6 repeat panels connected in series to the control panel
Repeat panel connections	Serial port

Zone circuit products (24Vdc)

See control panel specification for zone circuit loading.

Part number	Product	Operating voltage	Quiescent current	Alarm current
17640-01	Optical smoke detector	16V dc to 32Vdc	90uA	10mA Maximum can be upto 65mA limited by the control panel
17630-01	Ionisation smoke detector		50uA	
17650-01	Fixed temperature heat detector		45uA	
17660-01	Rate of rise heat detector		45uA	
17670-01	High temperature heat detector		90uA	
17615-01	Duct detector		90uA	
17906-49	Remote external LED for detector		-	
07011-31	Beam detector		see note	
14112-08	Manual call point (surface) 470R		n/a	As per detectors
14112-18	Manual call point (flush) 470R		n/a	

NOTE: If the beam detector is used then it must be powered from an external power supply.

Sounder circuit products (24Vdc)

See control panel specification sounder circuit loading.

Part number	Product	Alarm current
12511-37	Electronic sounder (red)	20mA
12511-52	Electronic sounder (grey)	20mA
12141-04	Electronic bell (red) IP40	30mA
12141-54	Electronic bell (grey) IP40	30mA
02601-31	Sounder	18mA
02300-01	Xenon flasher (red)	125mA
02300-01	Xenon beacon (red)	45mA

Door holders

NOTE: The door holder circuit should be controlled by the control panel's auxiliary contacts, using external power supply.

Part number	Product	Current
04390-31	Door holder (24Vdc)	22mA
04390-55	Door holder (240Vac)	17.5mA

System design

The design of the fire detection and alarm system should be to *BS 5839:Part 1:1988 Code of Practice for system design installation and servicing*. Supplemented with customer requirements.

Mains Supply Connection

The mains supply to the control panel should be via a fused spur unit rated:
 5A for 1 & 2 Zone panel
 7A for 4 & 8 Zone panel

Standby Supply

With the recommended battery the control panel will provide a standby supply under mains failure conditions, for a period of 72 hours followed by 30 minutes of alarm load, see specification.

24V supply

The power supply terminals '24+' and '0' may drive external ancillary equipment and is designed to be used in conjunction with auxiliary contacts and common fire and fault outputs, see *control panel specification*.

NOTE: The use of the 24V supply will affect the panel standby capability.

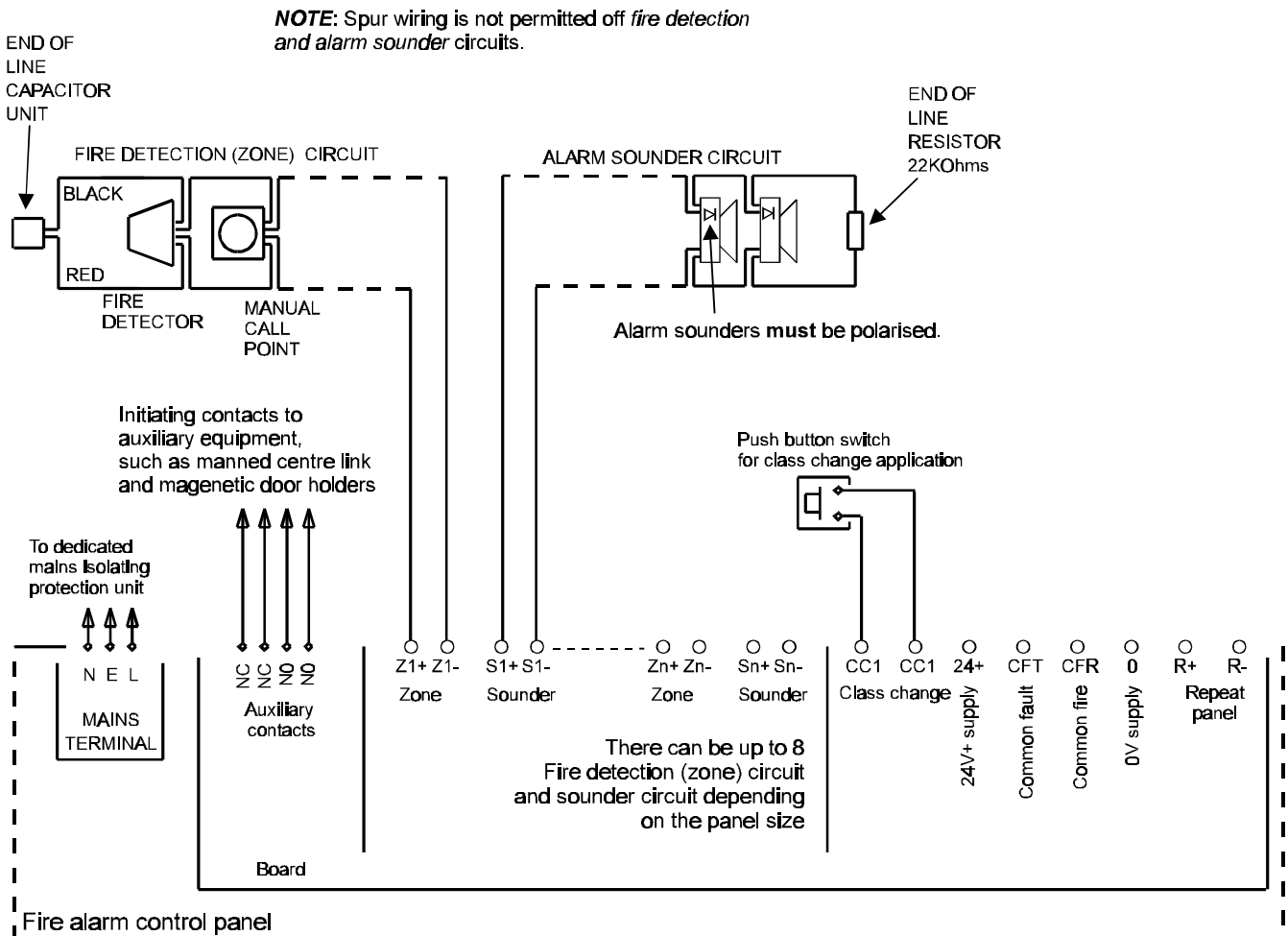

Figure 2 System schematic

cdm65

Fire Detection (Zone Circuits)

See parts list for compatible parts.

Each zone circuit can have up to 2mA load. An end-of-line capacitor unit is required for zone circuit monitoring, which must be fitted after the last detector or manual call point on the circuit. **All manual call points used must have a 470 ohms series resistor.**

NOTE: If a Beam detector is used, then it must be powered from an independent supply.

Where a zone circuit is not being used, the *end-of-line* capacitor unit must be fitted across its terminals in the panel.

Alarm (Sounder circuits)

NOTE: All sounder circuits (sectors) will always operate together in the event of a fire condition.

See parts list for compatible parts.

To comply with the requirements of BS 5839: Part 1:1988, a minimum of two alarm sounder circuits should be used on all installations.

1 & 2 Zone Panel	4 & 8 Zone Panel
1A maximum Alarm sounder load per panel	1.5A maximum Alarm sounder load per panel

The load must be shared between the sounder circuits.

The alarm sounder circuits are regularly pulse monitored for failure. It is important that the last alarm sounder is fitted with a 22K Ohm end-of-line resistor.

Where a sounder circuit is not being used, the *end-of-line* resistor must be fitted across its terminals in the control panel.

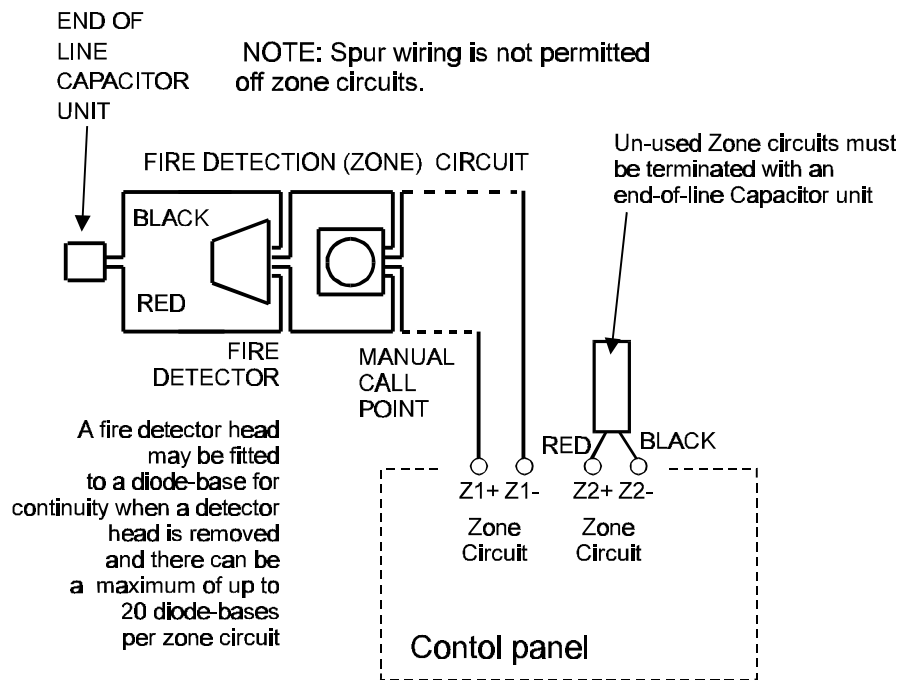

Figure 3 Zone circuit connections

cdm68

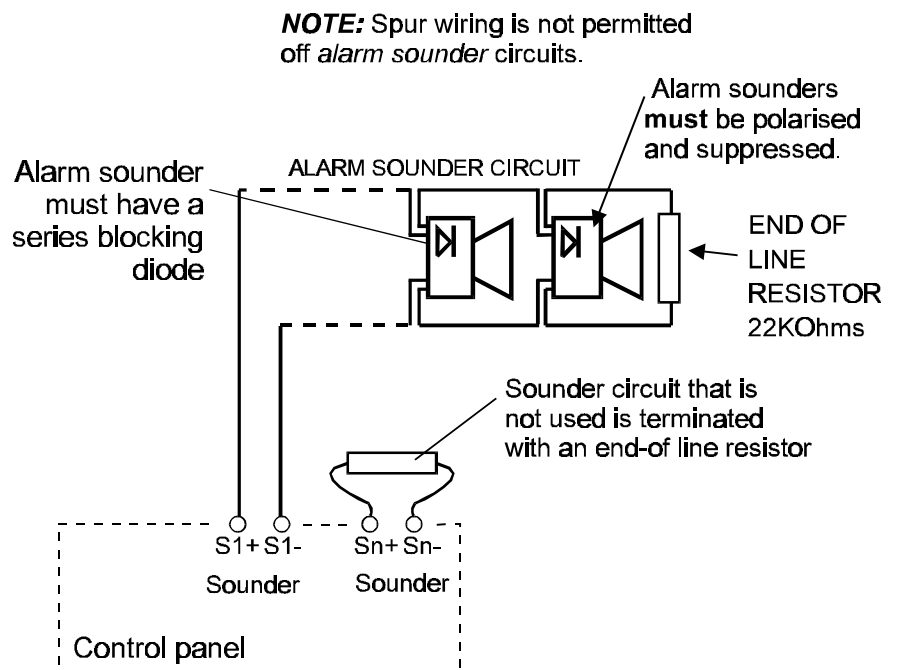

Figure 4 Alarm sounder connections

cdm67

Auxiliary Contacts

These are normally open (NO) and normally closed (NC) contacts that switch over when the panel goes into a fire condition.

The contacts are rated at 24V d.c. 1A for a resistive load and should not be used to switch voltages in excess of 50V.

The auxiliary circuits should be powered from an independent power supply.

Class Change

A pair of unmonitored terminals allow only the system alarm sounders to be actuated from a remote position. It is considered that the major use for these will be for class change functions in schools and colleges.

NOTE: *There is no indication at the panel of class change push button operation.*

Common Fire and fault

The **common fault** output is a normally closed electronic switch, which opens with a fault condition, this is for a fail safe operation.

The **common fire** output is normally open electronic switch that closes with a fire condition.

NOTE: *Each electronic switch has an in-line 1K ohms resistor.*

The +24V & 0V is a power supply for use with auxiliary contacts, common fire and common fault circuits, see specification.

Repeat Panel

There can be up to 6 repeat panels series connected from the control panel. A repeat panel duplicates fire and fault indications together with system controls.

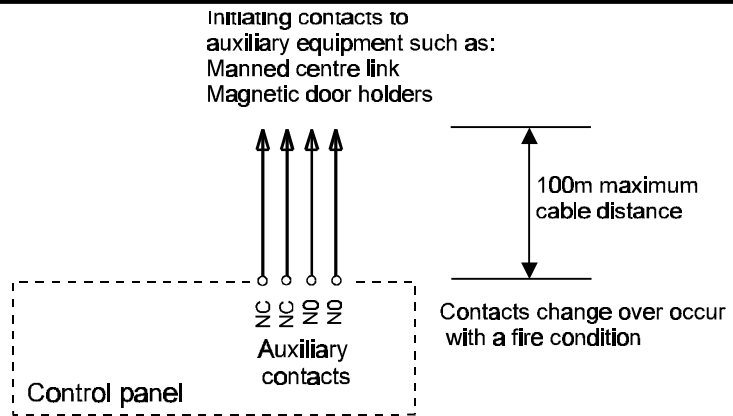

Figure 5 Auxiliary contact circuit

cdm72

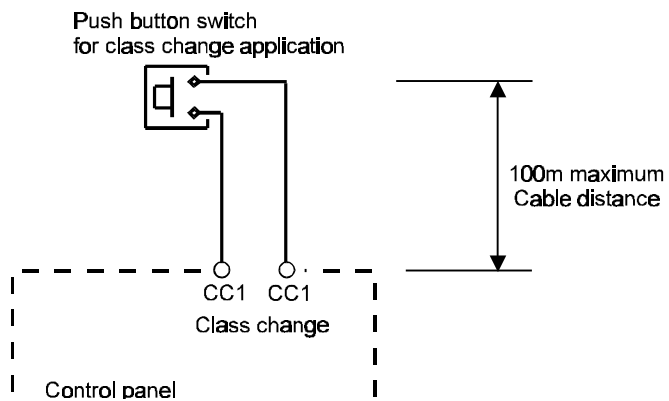

Figure 6 Class change circuit

cdm73

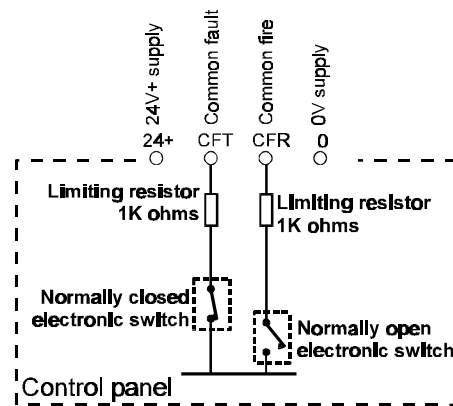

Figure 7 Fire fault & 24V outputs

cdm74

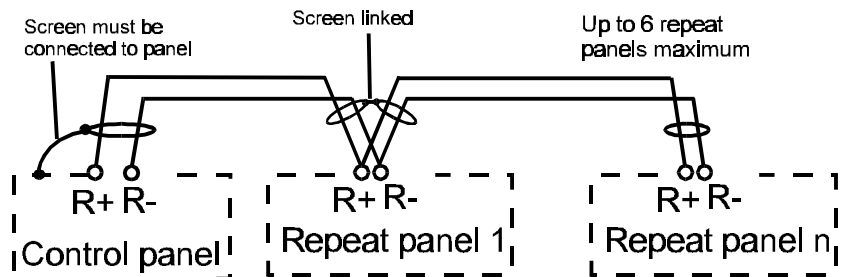

Figure 8 Control to repeat panel connections

cdm75

Cables

For the wiring of:

Length per circuit	Type of circuit	Recommended cables, also see BS5839:Part 1 guidance
2m	Mains power supply cord	see power supply cord
1Km	Zone circuit	See BS5839:Part 1 guidance
1Km	Sounders circuit	
100m	Auxiliary circuit	
100m	Common fire and fault circuit	
100m	Class change circuit	
500m	Repeat panel link	Belden type screened 2-core twisted pair

The guidance of BS5839 : Part 1: 1988 should be followed.

The use of cables, such as (MICC or Belden) are recommended.

Generally available electrical installation cable may be used, providing the cable is:

- to BS6387
- with no more than **2 - cores**
- each core having no less than **1.5mm²** cross section area
- with an inherent or through metal conduit screen for earth continuity in order to produce electrical protection and screening
- having protection from heat and mechanical damage

Power supply cord

This should be a 3-core cord having a rated current of:

- 5A with a nominal core cross sectional area of 0.75mm² provided the length of the cord does not exceed 2m.

Cable termination

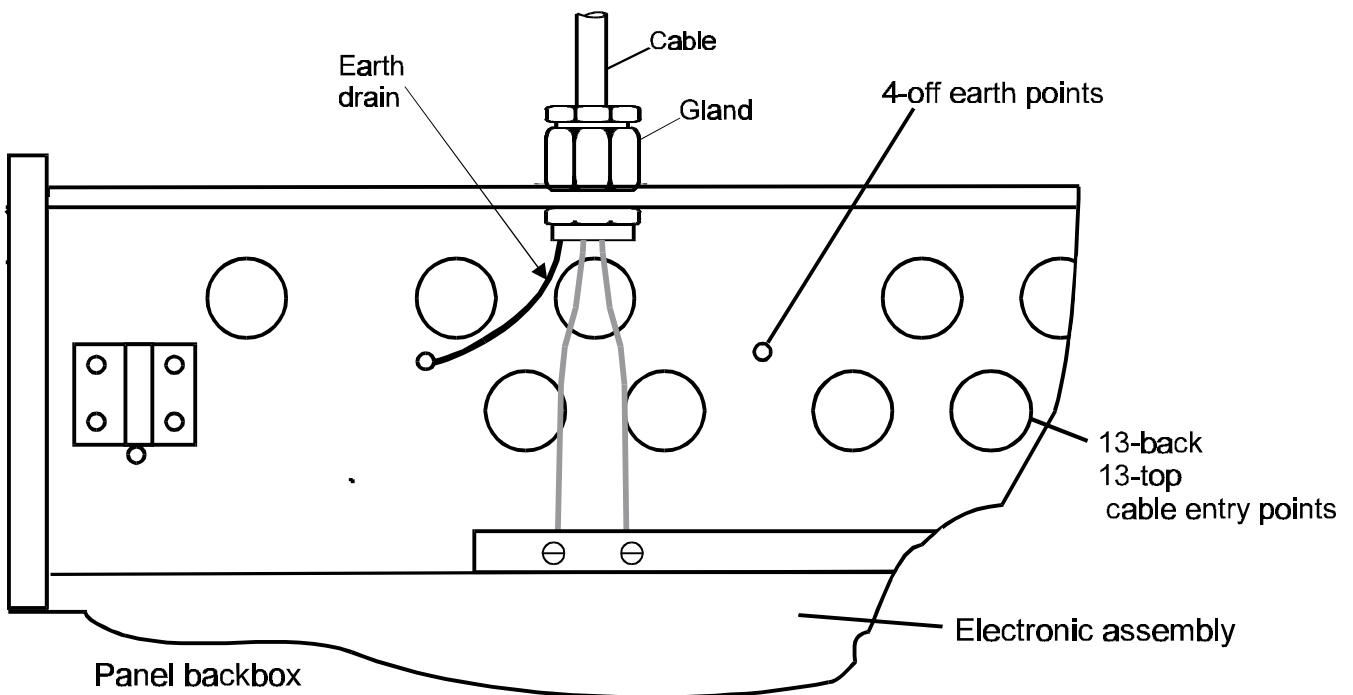

Figure 9 Panel cable entry and earth points

cdm158

Notes to the installer

Checks

- The power-up and commissioning is done by the servicing organisation.
- The wires between the termination point and terminals should be **short** and **straight** as possible.
- The cables of the fire detection and alarm system and other systems should usually be separated by at least **160mm**, unless dedicated conduit or ducting is used.
- Do not use any part of building structure for earthing.
- The cable length between the Repeat LED unit and respective fire detector where used , should not exceed **10m**
- Cable Glands should be used on the equipment for the mains supply cable.
- Unused knockouts on product enclosure that have been removed, should not be left open.

Requirements

It is recommended that the installer follow the general requirements of:

- *BS5839:Part 1:1988*, which is the *code of practice relating to the fire detection and alarm systems for buildings*.
- the relevant parts of the *BS 7671 Requirements for Electrical Installation Institute of Electrical Engineers Wiring Regulations 16th edition*.

Second fix installation

To prevent the possibility of damage or dirt degrading the performance or appearance of the System products:

the installation of second fix items should be delayed until all major building work in the area is complete.

Fixtures and fittings

It is the installers responsibility to provide:

- adequate fixtures and fittings for the type of construction surface onto which a product is to be installed.
- as an aid to this decision, the weight and overall size of each full assembly together with implications on cable entries and routing should be taken into consideration.

NOTE: All these procedures assume that the cable, gland, steel box (BESA box) and other related accessories are provided by the installer.

As fitted wiring drawings

The installer should acquire:

- site specific information from the interested parties, for details on the location of products for installation
- the acquired information together with this guide and the relevant standards should be used to assist the work.

Earth continuity

To maintain earth continuity, the cable screen must be continued through each system device, whether the earth is connected to a device or not.

Panel fixing

- a) Remove panel from its packing, but retain the carton for storage of spare parts and loose items.
- b) Remove the top and bottom inner plates, see Figure 10.
- c) Check the spares parts supplied with those listed in *Table 1*. If replacement parts are required at any time, only spares that are of the same specification should be used.
- d) Remove the transformer and earth connections from the *electronic assembly*, and then remove the electronic assembly from the panel, see Figure 11. Store the electronic assembly in a safe place until required.
- e) Remove the appropriate knock-in on the panel case for cable entry.
- f) Hold the panel on the wall in the desired mounting position and mark the positions of the fixing holes. See *Figure 11* for case fixing details.
- g) Secure the panel to the wall using suitable fixing such that adequate support is provided to the control panel assembly. A top centre keyhole fixing is provided on the case to allow the panel to be hooked whilst the bottom two fixing points are located.
- h) Connect the mains supply cable to the panel. The cable:
 - must be through one of the dedicated cable entry into the panel
 - via an **unswitched fused spur** unit, rated **5A** for the 1&2 Zone Control and Repeat panels and **7A** for 4&8 Zone panels.

The fused spur isolator cover should be red and marked:
FIRE ALARM - DO NOT SWITCH OFF

The fused spur units must be fed from a dedicated switch or protective device at the local mains supply distribution board.

Description For fuses also see Figure 12	Quantity supplied with control panel				Repeat panel
	1 - zone	2 - zone	4 - zone	8 - zone	8 - zone only
22K end-of-line resistor	2	2	4	8	
Capacitor unit	1	2	4	8	
End-of-line label	3	4	8	16	
Fuse 5A 20mm x 5mm AS (mains terminal block)			1	1	
Fuse 3.15A 20mm x 5mm AS (mains terminal block and power 1 & 2 - F1 &F2)	2	2	2	2	2
Fuse 5A 20mm x 5mm QB (battery F3)	1	1	1	1	1
Fuse 0.5A 20mm x 5mm QB (sector)	2	2	2	2	
Fuse 0.16A 20mm x 5mm QB (sector)			2	6	
Battery link	1	1	1	1	1
Zone designation label	1	1	1	1	1

Table 1 Spare parts supplied with each panel

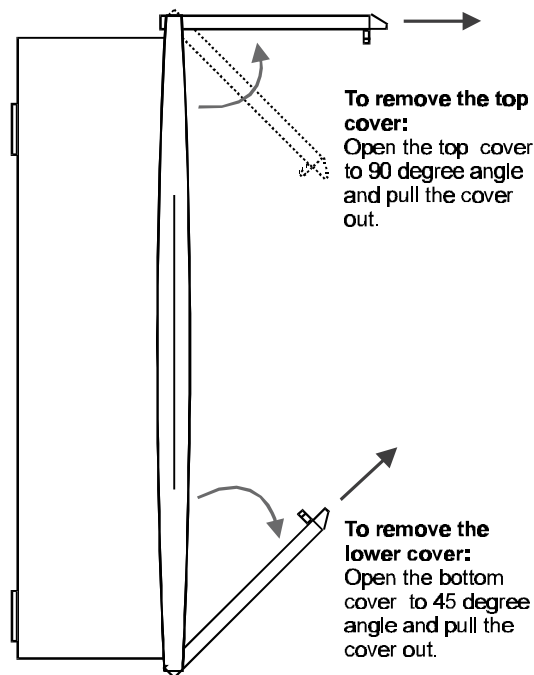

Figure 10 How to remove the outer covers
cdm77

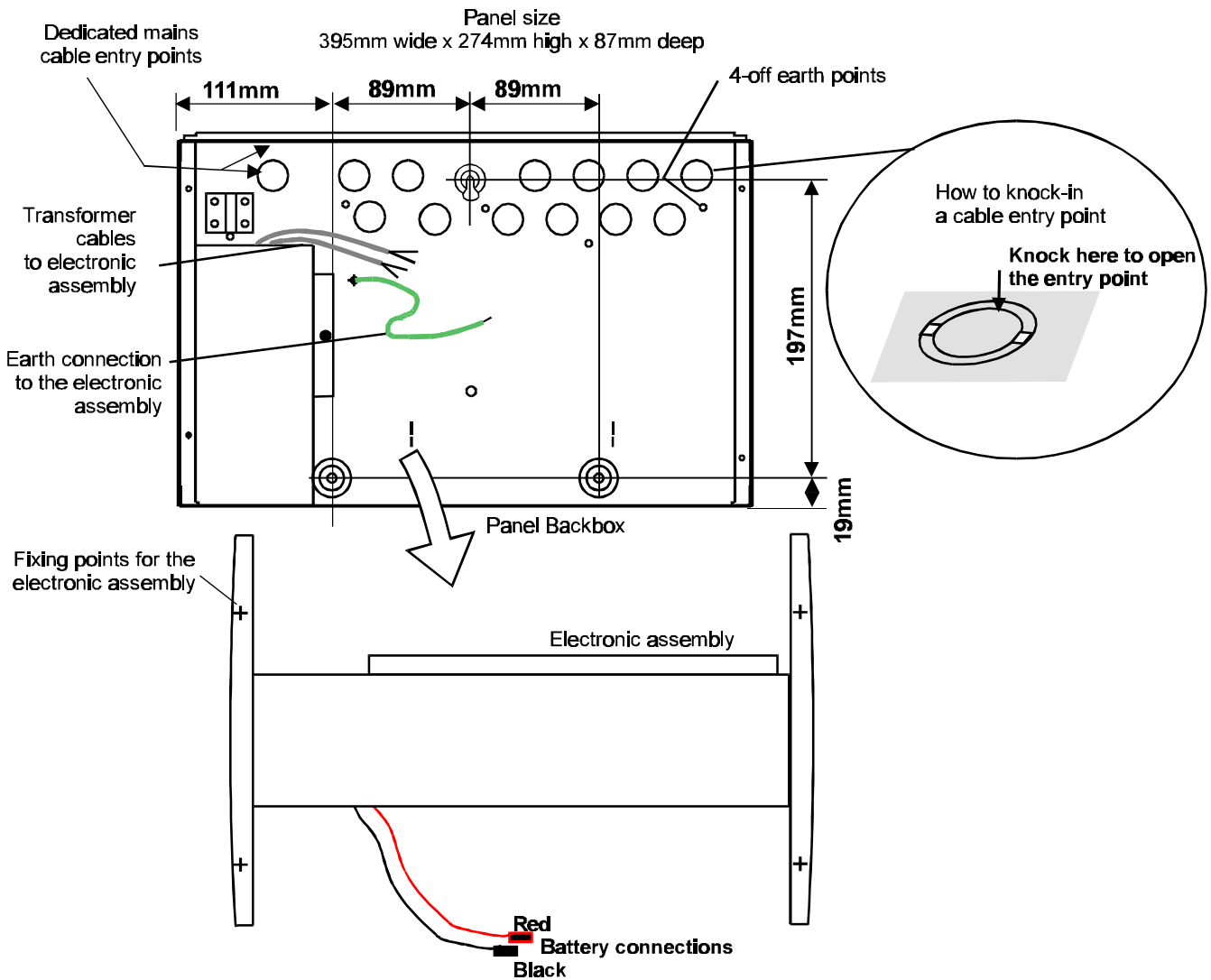

Figure 11 Panel fixings

cdm69

- i) Wire the system. With the exception of mains cable, all other cables should remain unconnected at the panel.
- j) Refit the *electronic assembly* into the panel and connect the transformer and earth cables previously removed, see Figure 11.

For the unconnected cable leave **300mm** tail wire length and mark each core identifying its final point of connection.

The system wiring can be tested whilst not connected to the respective terminals at each system equipment.

NOTE: Each terminal in a panel will accept a maximum conductor size of 2.5mm square.

NOTE: The installation of all outstanding parts are usually carried out during Commissioning of the System.

Store all spare parts and loose components including the batteries inside the panel carton and keep in a safe place until required.

CAUTION: DO NOT undertake high voltage insulation tests WITH THE CABLES CONNECTED to their terminals. Such a test may damage the electronic circuitry in the system equipment.

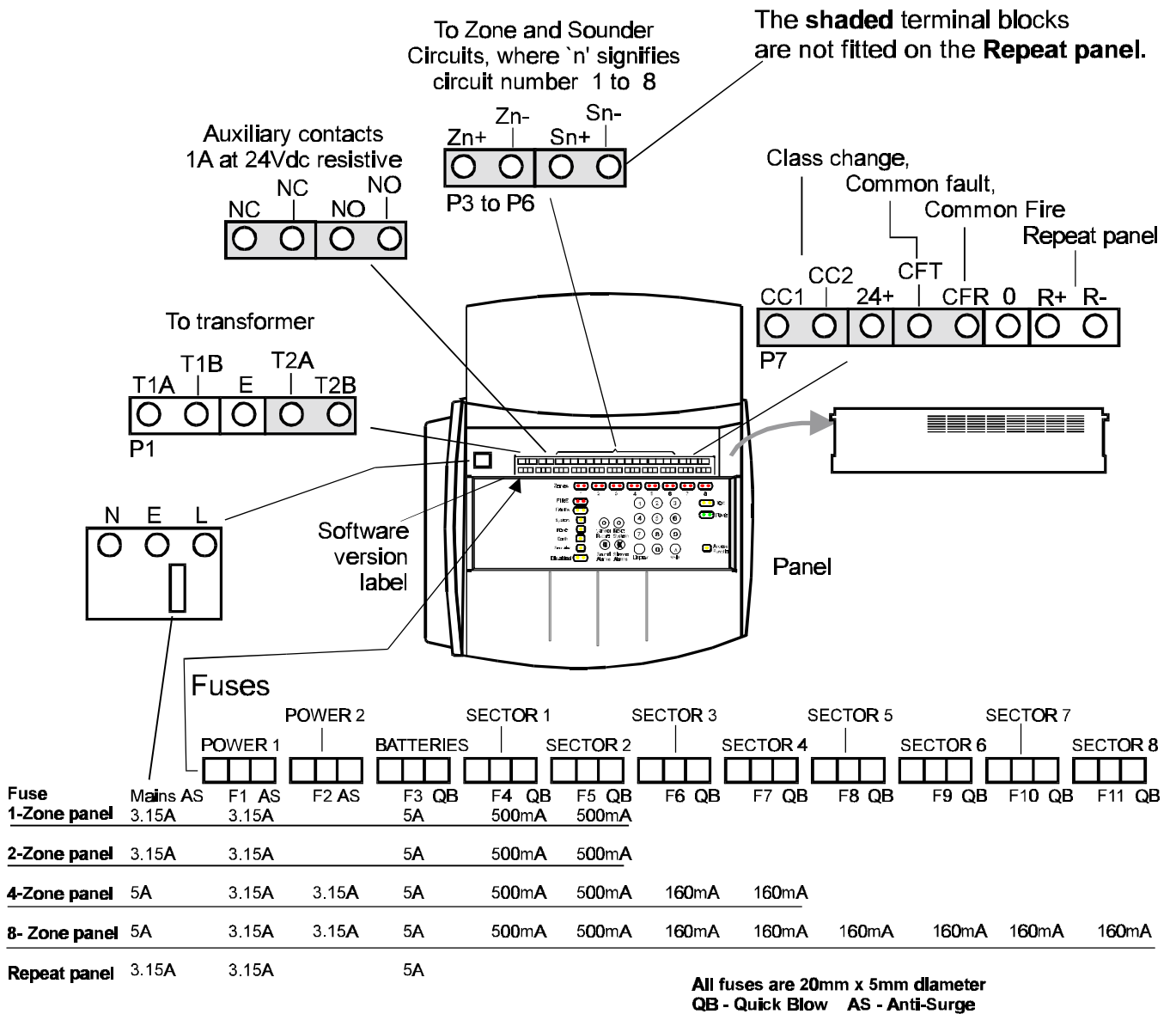

Figure 12 Panel terminals and fuses

cdm70

Commissioning

The total system should be tested in accordance with the commissioning requirements of BS5839:Part 1:1988 or other standard specified by the system purchaser.

NOTE: The commissioning procedures assume that the system has been installed as per instructions in this booklet.

System checks

- Acquire as fitted drawings
- check the system has been installed to the project requirements.
- if appropriate, action the installer to carry out changes to the system.

Initial power up

- a) Disconnect cables to terminals of zone, sounder, class change, auxiliary, common fire and fault circuits. Ensure each cable is marked for reconnection to respective terminals later.
- b) Connect end-of-line units to zones and sounder circuits for initial power up.
- c) Check mains connection and switch on the mains power to the control panel.
- d) Now connect the battery supply, see Figure 13.
- e) Check the panel provides a normal healthy indication, with the green light lit.

Zone circuit tests

- a) Transfer the end-of-line capacitor unit to the last device (detector or manual call point) on a zone circuit.
- b) Connect the zone cable to the zone circuit terminals.
- c) Carry out zone open circuit and short circuit tests and check appropriate indications are given.
- d) Repeat the above for other zone circuits.

Sounder circuit tests

- a) Transfer the end-of-line resistor unit to the last device on a sounder circuit.
- b) Connect the sounder circuit cable to the sounder circuit terminals.
- c) Carry out sounder open and short circuit tests and check appropriate indications are given.
- d) Repeat the above for other sounder circuits.

a) Open the lower outer cover

Control panel

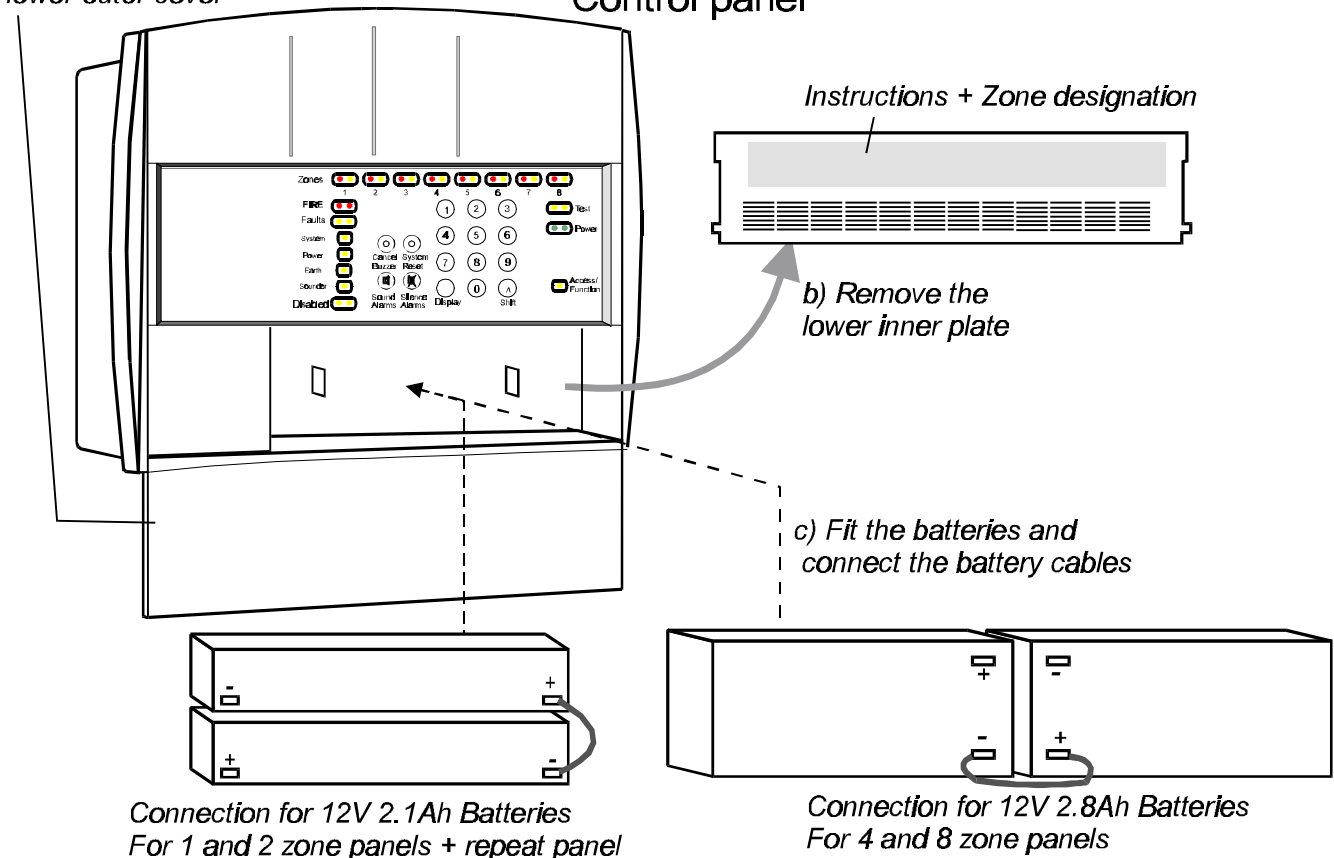

Figure 13 Battery installation

cdm71

Installed system tests

The fire detection and alarm system should be tested to ensure it operates to meet the standards and project requirements.

Configuration

The control and repeat panels are factory set to the requirements of EN54 Parts 2 and 4.

The operation of the control and repeat panels and the system may be re-configured to site specific needs, see system test functions and Panel configuration functions.

CAUTION: *Any special configurations may cause the system and equipment to operate outside the requirements of European standards.*

Test mode A or B operation

To facilitate tests on the fire detection and alarm system the control panel can be set to operate in a test mode, see System test functions.

With **Test mode A or B** active: a triggered manual call point or fire detector in the test zone will give:

Test A	Test B
<p>Fire indication for 10 seconds duration followed by a system reset</p>	<p>System alarm sounds for the first 2 seconds and at the same time a Fire indication is given for 10 seconds duration followed by a system reset</p>

Table 2 Test mode operation

NOTE: *A detector that is still full of smoke or heat will retrigger into a fire condition until the smoke or heat in the area is cleared.*

Repeat panel configuration

There can be up to 6 repeat panels connected in series to the the control panel.

Each repeat panel connected to the system is required to be given an address at both the **control and repeat panels**, see Panel configuration section.

Sound level test

Sound level tests should be conducted to standard requirements and to customer satisfaction.

Other equipment tests

Where external equipment is connected to the control panel using auxiliary, common fire and fault terminals, then these must be tested to project requirements.

Zone designation label

- a) Write on to the zone designation label the name that identifies the area protected by each zone circuit.
- b) Fix the label over the zone designation part of the lower inner plate, see figure 13.

Log book

Fill in system details on the first three pages of the log book.

On completion

Ensure the persons responsible for the system are made aware of

- system operation
- access codes to controls
- basic controls
- their responsibility
- and the need to log system events in the log book.

Access levels 2 and 3

The control and repeat panels provides system security by coded password entry to controls.

There are three coded access levels to user controls, also see Table 3.

- Access level 1 (AL1)** is for *authorised user*.
- Access level 2 (AL2)** is for *site security*.
- Access level 3 (AL3)** is for *site engineer*.

Access codes

The factory set codes for:

- AL1 - No code required
- AL2 - is 123 (default)
- AL3 - is 321 (default)

The AL2 and AL3 are 3-digit codes.

NOTE: The standard AL2 and AL3 access codes are factory set. These codes may be changed to user defined codes.

Access Levels->	AL1	AL2 Code: ☛123	AL3 Code: ☛321
What is accessible			
Cancel buzzer (fire and fault)	☛☛②	✓	✓
System Reset		✓	✓
Sound alarms		✓*	✓*
Silence alarms		✓	✓
Disable / Enable sounders		✓	✓
Disable / Enable zone(s)		✓	✓
Zone(s) only Test A		☛☛①	✓
Zone(s) with sounders Test B		☛☛①	✓
Cancel Test A / Test B		☛☛①	✓
Display test	☛☛②	✓	✓
All indications	✓	✓	✓
Zone designations (located behind lower cover)	✓	✓	✓
Instructions (located behind lower cover)	✓	✓	✓
Change to AL2 and AL3 user password			✓
Repeat panel address			✓
A Shaded option is not applicable to the repeat panel.			

- ① This option may be moved to AL3, see Panel configuration section
- ② This option may be moved to AL2, see Panel configuration section
- ☛ factory setting

Table 3 Controls accessible at various user levels

System test functions

To ease the testing of the system it is necessary to gain access to some of these functions.

NOTE: It is only necessary to enter the access code once, provided the 2 minute timeout is not exceeded between button presses.

Access code

AL2 Code : 123 may be used to gain access to the test functions. Depending on how the system is configured it may be necessary to use AL3 code 321 instead of AL2 code.

The factory set AL2 and AL3 codes are 123 and 321 respectively on first power-up. If the codes are changed at any time then the power-up codes are not applicable.

NOTE: It is important to leave the system in a normal operating condition on completion of commissioning.

How to	Controls	Result
How to do a Display test	Enter the 3 digit code (n) (n) (n) then: press shift (A) and display (E) buttons	All indicators are lit (flashing indication for zone fire/fault) and the buzzer sounds for 10 seconds duration
How to set the panel to operate Test mode A	Enter the 3 digit code (n) (n) (n) then: press (A) (3) and the respective zone (1) - (8)	This will allow the zone circuit(s) to be tested without an alarm of fire.
How to set the panel to operate Test mode B	Enter the 3 digit code (n) (n) (n) then: Press (A) (4) and the respective zone (1) - (8)	This will allow the zone circuit(s) to be tested with 2 second alarm of fire.
How to Cancel Test mode A/B	Enter the 3 digit code (n) (n) (n) then: Press (A) (5) and the respective zone (1) - (8)	This will cancel any active Test mode, either A or B.
How to Disable a zone	Enter the 3 digit code (n) (n) (n) then: Press (A) (1) and the respective zone (1) - (8)	A fired detector in disabled zone(s) will not cause the panel to go into a fire condition.
How to Enable a zone	Enter the 3 digit code (n) (n) (n) then: Press (A) (2) and the respective zone (1) - (8)	This will re-enable all previously disabled zone circuit(s).
How to Disable sounders	Enter the 3 digit code (n) (n) (n) then: Press (A) (1) and followed by (0)	This will disable the Sounder circuits operation.
How to Enable sounders	Enter the 3 digit code (n) (n) (n) then: Press (A) (2) and (0)	This will re-enable previously disabled sounder circuits.
How to change AL2 password	Enter the AL3 3-digit code (n) (n) (n) then: Press (A) (9) (0) (0) (1) followed by the new 3-digit code (n) (n) (n) and (A) (0)	This will allow a previous AL2 password to be changed to a new 3-digit code
How to change AL3 password	Enter the AL3 3-digit code (n) (n) (n) then press (A) (9) (0) (0) (2) followed by the new 3-digit code (n) (n) (n) and (A) (0)	This will allow a previous AL3 password to be changed to a new 3-digit code
How to exit from AL2, AL3 or AL4 to AL1	Press (A) (0)	This will exit the current access level and return to AL1

Panel configuration functions

To ease the commissioning of the system it is necessary to gain access to some of these functions.

NOTE: *It is only necessary to enter the access code once, provided the 2 minute timeout is not exceeded between button presses.*

Access code

AL3 Code : 321 may be used to gain access to these commissioning functions.

The AL3 code is: 321 on first power-up. If the code is changed at any time then the power-up code is not applicable.

NOTE: *It is important to leave the system in a normal operating condition on completion of commissioning.*

How to:	Controls	Result	Factory default
How to terminate the EEPROM programming mode	Press Shift A followed by 9	This will terminate the programming mode at any stage, and return the EEPROM to a protected state.	
How to set a repeat panel address at the control panel There can be up to 6 repeat panels in a system.	Enter the AL3 3-digit code n n n then: Press A 9 0 0 0 followed by location 0 3 8 and the repeat panel address 0 0 1 and then A 0 .	At the Control panel location 038 an entry is made of the first repeat panel address 001 Depending on the number of repeat panels used, similarly at locations 039, 040, 041, 042 and 043 entries are made of the 2nd, 3rd, 4th, 5th and 6th repeat panel addresses, which may be 002, 003, 004, 005 and 006 respectively.	Repeat panel address is 000
How to set a repeat panel address at the repeat panel There can be up to 6 repeat panels in a system.	Enter the AL3 3-digit code n n n then: Press A 9 0 0 0 followed by location 0 3 8 and repeat panel address 0 0 1 and A 0 .	At the Repeat panel location 038 an entry is made of the repeat panel address, in this case it is 001. Other repeat panels can be given an address from the range 002 to 006, which must be entered in location 038 ..	Repeat panel address is 001
How to move 'Cancel buzzer' from access level AL1 to AL2	Enter the AL3 3-digit code n n n then: Press A 9 0 0 0 followed by location 0 3 2 , and data 0 0 1 and A 0 .	This will move the Cancel buzzer button access to level 2.	
How to move 'Cancel buzzer' from access level AL2 to AL1	Enter the AL3 3-digit code n n n then: Press A 9 0 0 0 followed by location 0 3 2 , and data 0 0 0 and A 0 .	This will move the 'Cancel buzzer' button access to level 1.	✓

How to:	Controls	Result	Factory default
How to move 'Test A&B' and Cancel Test from access level AL3 to AL2	Enter the AL3 3-digit code (n)(n)(n) then: Press (A)9(0)(0)(0) followed by location (0)(3)(4) , and data (0)(0)(1) and (A)(0) .	This action will move the 'Test A&B and Cancel test' functions from AL3 to AL2.	✓
How to move 'Test A&B' and Cancel test from AL2 to AL3	Enter the AL3 3-digit code (n)(n)(n) then: Press (A)9(0)(0)(0) followed by location (0)(3)(4) , and data (0)(0)(0) and (A)(0) .	This action will move the 'Test A&B and Cancel test' functions from AL2 to AL3.	
How to set the most recent fire as a steady indication.	Enter the AL3 3-digit code (n)(n)(n) then: Press (A)9(0)(0)(0) followed by location (0)(3)(5) , data (0)(0)(0) and (A)(0) .	This will result in the most recent fire being displayed as a steady indication.	✓
How to set the most recent fire as a pulsing indication.	Enter the AL3 3-digit code (n)(n)(n) then: Press (A)9(0)(0)(0) followed by location (0)(3)(5) , data (0)(0)(1) and (A)(0) .	This will result in the most recent fire being displayed as a pulsing indication.	
How to set the auxiliary relay to operate (energise) with sound alarms.	Enter the AL3 3-digit code (n)(n)(n) then: Press (A)9(0)(0)(0) followed by location (0)(3)(7) data (0)(0)(1) and (A)(0) .	This will result in the auxiliary relay activation with sounders.	
How to set the auxiliary relay to operate (energise) with fire condition.	Enter the AL3 3-digit code (n)(n)(n) then: Press (A)9(0)(0)(0) followed by location (0)(3)(7) data (0)(0)(0) and (A)(0) .	This will result in the auxiliary relay activation with a fire condition.	✓
How to move 'Display test' from access level AL2 to AL1.	Enter the AL3 3-digit code (n)(n)(n) then: Press (A)9(0)(0)(0) followed by location (0)(3)(3) data (0)(0)(1) and (A)(0) .	This will move the 'Display test' button access to AL1.	✓
How to move 'Display test' from access level AL1 to AL2.	Enter the AL3 3-digit code (n)(n)(n) then: Press (A)9(0)(0)(0) followed by location (0)(3)(3) data (0)(0)(0) and (A)(0) .	This will move the 'Display test' button access to AL2.	

User Responsibility

It is recommended that the **persons responsible** for the fire alarm system, should become familiar with the procedures on how to operate the controls and interpret indications given at the control and repeat panels. Adequate **training** should also have been given from appointed personnel.

Daily

The British Standard code of practice for *Fire detection and alarm systems for buildings, BS 5839:Part1:1988*, states that the system should be inspected daily to ensure that a normal indication is given at the control and indicating equipment and that any previously indicated **fault** condition has received appropriate attention.

- a) It recommends entry into the Log Book provided of all the system events for future reference.
- b) The person inspecting the protected premises can ensure that the use of the area(s) inspected has not changed such that the detection and alarm devices have become inappropriate.
- c) The area(s) can be inspected to check that no unsafe practices that could lead to fire are being undertaken.

Weekly

At Weekly intervals a different **Fire detector** or **Manual Call Point** of the system should be tested to ensure the system is capable of operating under alarm condition.

- a) The operation of the alarm sounders should be checked, which also provides a regular reminder to those occupying the premises that there is a fire alarm system with a particular characteristic sound.
- b) The test should be performed at a regular time to avoid confusion between a test and a genuine fire alarm.

Quarterly

At quarterly intervals the system should be inspected and any work necessary should be performed by trained maintenance engineer.

Battery Replacement

NOTE: Any servicing work on the System must be carried out by servicing organisation.

Under normal operating conditions the maintenance free **lead acid** batteries in the Control and Repeat panels can have a useful life of up to **5 years** from the date of manufacture.

NOTE: It is recommended that these batteries are replaced at 4 Yearly intervals from the date the System is first commissioned.

Testing a Manual Call Point

Push the test key through the hole in the underside of the call point to engage the test cam mechanism and push to operate the cam mechanism.

At this point the test key is retained in the call point and pulling it out will reset the glass.

NOTE: The alarm sounders in the system will be activated by this test. To **silence alarms and reset the system**, see **operating instructions**.

Replacing a broken Glass

WARNING: Take appropriate precautions when clearing broken glass to prevent injury.

NOTE: A weather resistant version of manual call points will have two gaskets, a Cover/glass gasket and a Spacer/cover gasket, which must be installed in their respective position.

These procedures assume the cover on the manual call point is open and any broken glass has been cleared.

- a) Feed the glass upward to push the cams down and fit under slider, locate bottom of glass into recess.
- b) Hold the bottom of glass in position and rotate the thumbwheel quadrant to raise the top of the glass.
- c) Fit the call point cover by hooking it into the top of the unit and making sure that the glass is properly seated (held down) tighten the cover fixing screw.

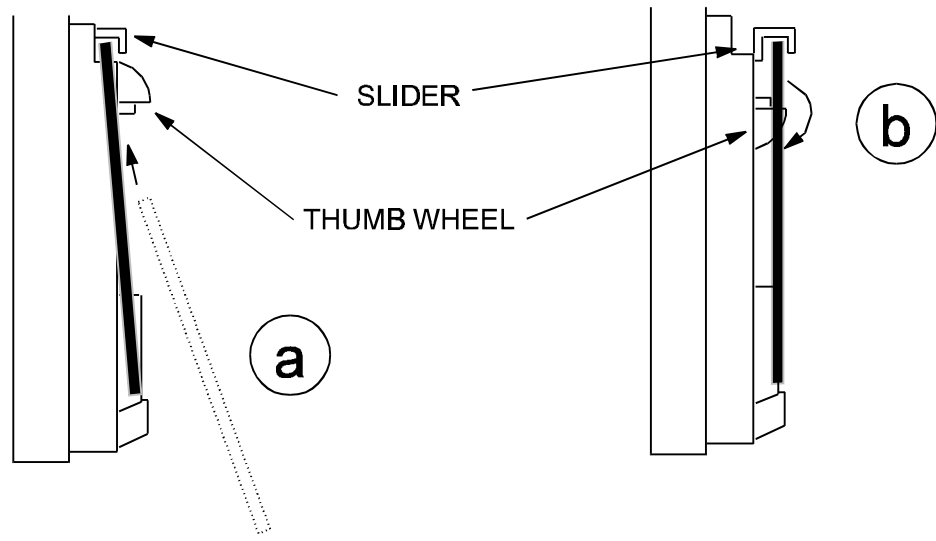
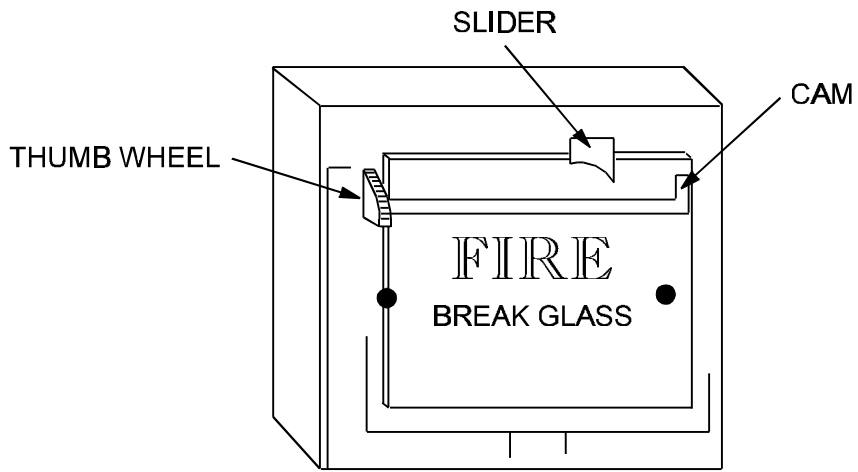



Figure 15 Replacing a broken MCP glass

emfl216

Fault indications

All fault repairs should be carried out by the servicing organisation.





In a fault condition:

- the common Fault  light is lit
- appropriate fault  light is also lit
- internal Fault Buzzer sounds intermittent tone
- Multiple faults are simultaneously annunciated when this does not cause confusion.

NOTE: Normally the fault lights will be automatically extinguished once the fault condition is rectified.

NOTE: If the system detects a fire during a fault condition the fault indicators may be extinguished.

How to silence the fault buzzer

Press the 3 digit code    if required and then press Cancel Buzzer .

Notice the buzzer is silenced but visual indications remain active.

NOTE: The sounder circuits are pulse monitored for failure. The monitoring signal is only applied to the circuits for a short duration at regular intervals.

Faults	Cause
What is a Zone fault?	A zone fault occurs when a zone circuit cable is open circuit or short circuit, or the end-of-line capacitor unit has been disconnected or a detector has been removed.
What is a Sounder fault?	A sounder fault occurs when a sounder circuit cable is open circuit or short circuit, or the end-of-line resistor unit has been disconnected.
What is a Mains power fault?	A mains failure occurs when the mains power supply to the panel is removed. This can occur on mains fuse failure or mains supply disconnection.
What is a Battery power fault?	A battery supply failure occurs when the battery supply to the panel has failed (due to aging process) or is disconnected or the battery fuse has failed.
What is an Earth fault?	An earth fault occurs when there is an electrical path for current flow from the system to earth connections.
What is a Repeat panel link fault?	A repeat panel link fault occurs when there is a communication failure between the control and repeat panels.
What is a System Fault?	A system fault occurs in the event the microprocessor failure.

Table 4 Types of faults

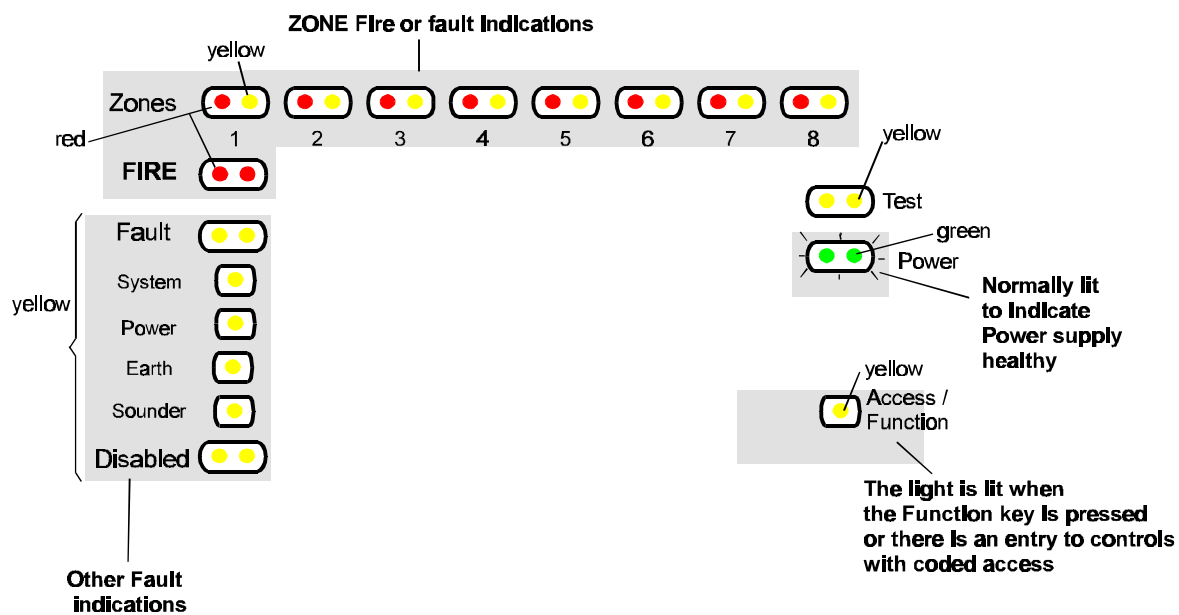

Figure 14 Fault indicators

cdm95

Indications	Visual										Audible			Signal out		Action to remove the indication	
	Zone Fire (1 to 8) - Red	FIRE (common) - Red	Zone Fault (1 to 8) - Yellow	Fault - Yellow	System - Yellow	Power - Yellow	Earth - Yellow	Sounder - Yellow	Disabled - Yellow	Test - Yellow	Power - Green①	Access / Function - Yellow	Buzzer	Sounder circuits	Auxiliary relay contacts Normally de-energised		Common Fault (normally active)
Conditions																	
Normal indication															norm	act	deact
Fire	On	On								On			On	On	C/O	act	act
New Fire (In another zone)	On*	On								On			On	On	C/O	act	act
Zone fault			Pul							On				Pul	norm	deact	deact
Sounder fault							Pul			On				Pul	norm	deact	deact
Mains power fault										Pul				Pul	norm	deact	deact
Battery power fault										Pul				Pul	norm	deact	deact
Earth fault										Pul				Pul	norm	deact	deact
Repeat panel link fault										Pul				Pul	norm	deact	deact
System fault (Software)										Pul				Pul	norm	deact	deact
Disable Zone			On							On~				On	norm	deact	deact
Disable Sounder											On			On	norm	act	deact
Test A or B (Normal)			Pul+								On			On	norm	act	deact
Test A (fire)②	On		Pul											On	norm	act	deact
Test B (fire)③	On		Pul											On	norm	act	deact
Access level AL2,3 or 4															norm	act	deact
Function key press															norm	act	deact

On - Steady indication Pul - Slow pulsing indication Pul+ - Fast pulsing indication C/O - Contact change over
 norm - normal deact - deactivated act - activate ① Pulsing indication in the event of mains failure * - programmable to give a flashing indication
 ② Test A (fire) - automatic fire reset after 10 seconds ③ Test B (fire) - sound alarm for 2 seconds and system reset after 8 seconds ~ - pulsing at repeat panel

Operating instructions

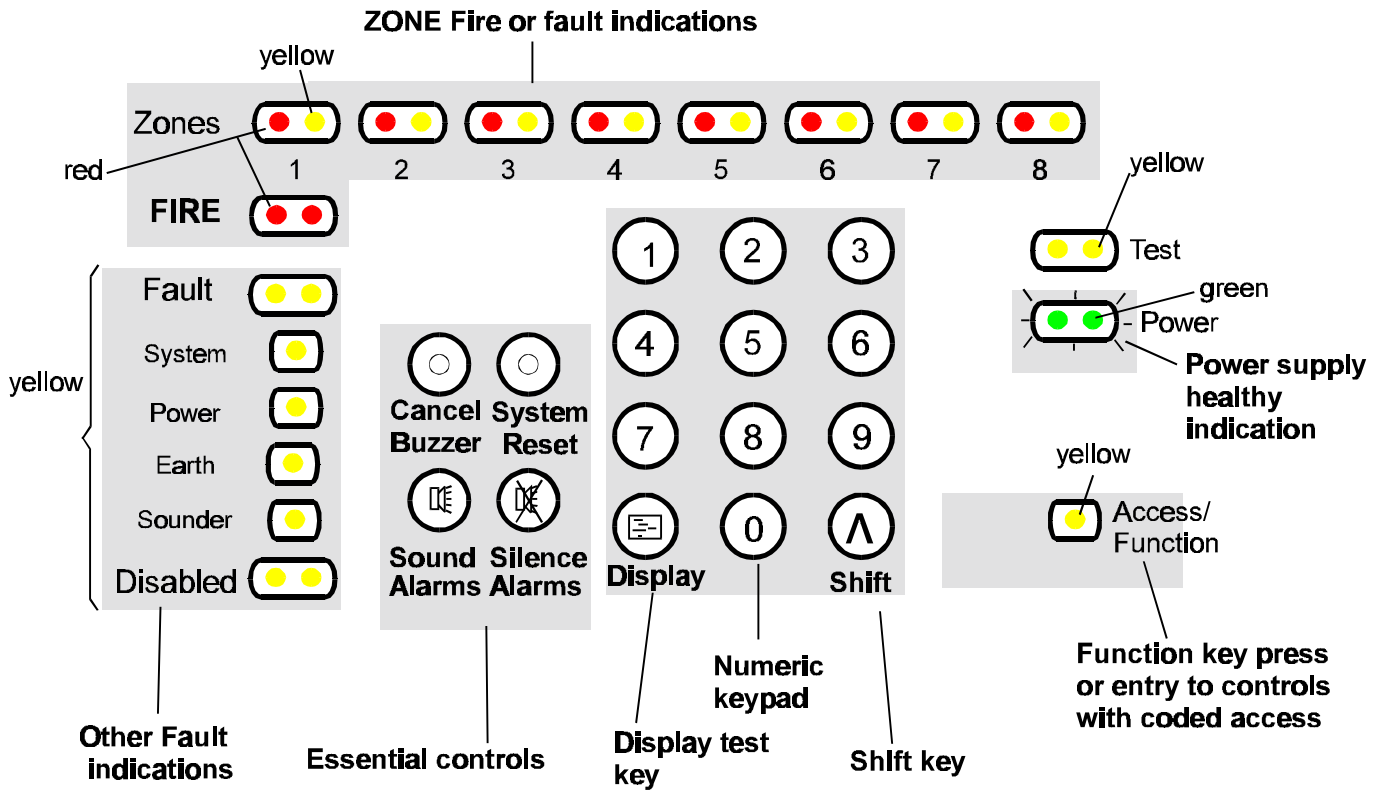

Figure 16 Controls and indications

cdm66

Normal indications



Under normal condition the panel should give a healthy indication,

with only the **green**  **Power light lit.**

The control panel provides system security by password entry to controls.





Fire Condition

In the event of an automatic fire detection the indications given are:

- FIRE  light is lit.
- Zones-fire  light is lit.
- buzzer sounds continuous tone.
- system alarm sounders are activated
- if applicable, auxiliary equipment is actuated
- if applicable, automatic link to the Fire Brigade is initiated.

After the emergency is over

After emergency is over silence the alarms and reset the system:





- a) Enter the **3 digit code**    to gain access to the controls.
- b) Press the **Silence Alarms**  button.

Notice the system alarm sounders are silenced and local buzzer sounds intermittent tone.

- b) After the cause of the alarm has been investigated, ensure smoke and excess heat have had time to clear from automatic detectors and broken manual call point glasses have been replaced where necessary. Press the **System Reset**  button. Notice the indications return to their pre fire status.





To Sound Alarms

To re-sound the alarm sounders during a fire condition:





- a) Enter the **3 digit code**    to gain access to the controls.
- b) Press the **Sound Alarms**  button.
Notice the system alarm Sounders are activated.

To Silence Alarms

To silence system alarm sounders after they have been actuated:

- a) Enter the **3 digit code**    to gain access to the controls.
- b) Press the **Silence Alarms**  button.
Notice the system alarm Sounders are silenced.

To carry out a lamp test





- a) Enter the **3 digit code**    to gain access to the controls.
- b) Press the 'shift'  button and then the **display**  button.
Notice the all indicators are lit and the buzzer sounds continuous for 12 seconds.

Fault Condition

In the event of an automatic fault detection the indications given are:

- Fault light is lit
- fault indicators are lit (except for system fault which is a continuous sound)
- buzzer sounds intermittent.

To Cancel fault buzzer

- a) Enter the **3 digit code**    to gain access to the controls.
- b) After investigating fault, press the **Buzzer**  button. Notice the buzzer is silenced but other indications remain active.

The fault indications are normally automatically extinguished once the fault condition has been rectified.

Action to rectify fault

Suggested action to rectify fault condition:

NOTE: *All fault rectification work must be done by the servicing organisation.*

The fault indicators may be extinguished during a fire condition.

See commissioning section. The mains failure condition overrides all other fault indications in order to preserve battery standby capacity.

Parts list
Xenex Panels

Part number	Description
XEN1	1 Zone control panel
XEN2	2 Zone control panel
XEN4	4 Zone control panel
XEN8	8 Zone control panel
XENRPT	Repeat panel

Fire Detectors

Part number	Description
17640-01	Optical smoke
17630-01	Ionisation smoke
17650-01	Fixed temperature heat
17660-01	Rate of rise heat
17670-01	High temperature heat
17601-01	Base (BS5839:Part1)
17615-01	Duct detector
07011-31	Beam detector

<p>NOTE: <i>The beam detector should be powered from an independent power supply.</i></p>
--

Manual call points (MCP)

Part number	Description
14112-08	Manual call point (surface)Red 470R
14112-45	Manual call point (surface)Red 470R c/w cover
14112-08	Manual call point flush (red) 470R
14112-58	Manual call point flush (red) 470R c/w cover
14112-19	MCP Surface water resistant kit
14112-09	Pack of 10 glasses
14115-08	Keyswitch (red) surface 470R

14115-18 Keyswitch
(red) flush 470R

24Vdc Sound signals

Part number	Description
12511-37	Electronic sounder (red)
12511-52	Electronic sounder (grey)
12511-19	Water resistant kit for 2511 sounders
12143-04	Electronic bell (red) IP55
12141-54	Electronic bell (Grey)
02601-31	Sounder 6-28V
02300-01	Xenon flasher (red) - 125mA
02300-01	Xenon beacon (red) - 45mA

24Vdc Ancilliary

Part number	Description
04390-31	Magnetic Door holder - 22mA
04390-92	Door holder floor plate
04390-99	Door bracket

NOTE: *The door holders should be powered from an independent power supply.*

Accessories

Part number	Description
4015-502	12V 2.1Ah battery (2-off required for 1 & 2 zone panel plus repeat panel)
4015-509	12V 2.8Ah battery (2-off required for 4 & 8 zone panel)
2534-142	Spares pack for XEN1
2534-143	Spares pack for XEN2
2534-144	Spares pack for XEN4
2534-145	Spares pack for XEN8
2534-146	Spares pack - XENRPT

Log Book

SITE ADDRESS

A Log of system events MUST be kept by the responsible persons on site and must be available at all times together with the system access codes.

GENT Contract No. _____

Site ID: _____

For Service

Normal Hours Mon-Fri _____

Tel. _____

Outside Normal Hours _____

Tel. _____

Manned Centre Telephone _____

Manned Centre Code No. _____

Responsible Persons on SITE: _____

To comply with the requirements of *BS5839 : Part 1 : 1988* and to allow those concerned with the fire detection and alarm systems to monitor the long term performance of the system, it is important that a log is kept which includes all the events relating to the performance of the system.

AL2 password	AL3 password

For each zone record the location description.

Zone number	Description of the zonal location
Zone 1	
Zone 2	
Zone 3	
Zone 4	
Zone 5	
Zone 6	
Zone 7	
Zone 8	

System configuration record

This information will assist the servicing organisation to keep a record of how the system is configured.

Mark in the table below any deviation(s) from the standard factory settings.

Detection and zone circuit configuration

Zone number	1	2	3	8	5	6	7	8
Normal zone operation (<i>factory setting</i>)								
Non latching zone operation								
First fire to be a pulsing indication (<i>factory setting</i>)						Detection band A (<i>factory setting</i>)		
First fire to be a steady indication						Detection Band B		
						Detection Band C		
Zone short circuit to give a fault (<i>factory setting</i>)								
Zone short circuit to give a fire								

Sounders and system reset configuration

Silence alarms and reset to operate independently (<i>factory setting</i>)		
Silence alarms and reset to operate as per BS5839: Part 4		
Reset to also action the silence alarms		
Sound alarms to operate in fire condition only (<i>factory setting</i>)		
Sound alarms to operate at any time		
Auxiliary relay to energise with fire (<i>factory setting</i>)		
Auxiliary relay to energise with sound alarms		

Access level

Access levels	AL1	AL2	AL3
Cancel buzzer (AL1 - factory setting)			N/A
Test A & B mode, Cancel Test (AL2 - factory setting)	N/A		
Display test (AL1 - factory setting)			N/A

Repeat panel information

Repeat panel	EEPROM location	EEPROM Data (address)	Name of the area where the panel is installed on site
1st Repeat panel			
2nd Repeat panel			
3rd Repeat panel			
4th Repeat panel			
5th Repeat panel			
6th Repeat panel			

GENT SALES & SERVICE CENTRES**South East**

Telephone: 0181 300 7784
Fax: 0181 302 7739

Scotland

Telephone: 0141 429 5446
Fax: 0141 420 1731

Head Office

Waterside Road
Hamilton Industrial Park
Leicester, LE5 1TN
Telex: 342367
Fax: 0116 246 2300
Tel: 0116 246 2000

South West

Telephone: 0117 961 8340
Fax: 0117 961 8292

Northern Ireland

Taylor
The Mount
2 Woodstock Link
Belfast
BT6 8DD
Telephone: 01232 730 150
Fax: 01232 730 199

International division

Waterside Road, Hamilton Ind.
Park, Leicester, LE5 1TN, UK
Telephone: (44) 116 246 2200
Fax: (44) 116 246 2018
Telex: 342367 GENT G

Midlands

Telephone: 0116 246 2400
Telex:342367 Fax: 0116 246 2017

North

Telephone: 01204 531155
Fax: 01204 531177

GENT Xenex range of

1,2,4 and 8 zone fire Control and Repeat panels

This publication is for internal use only.

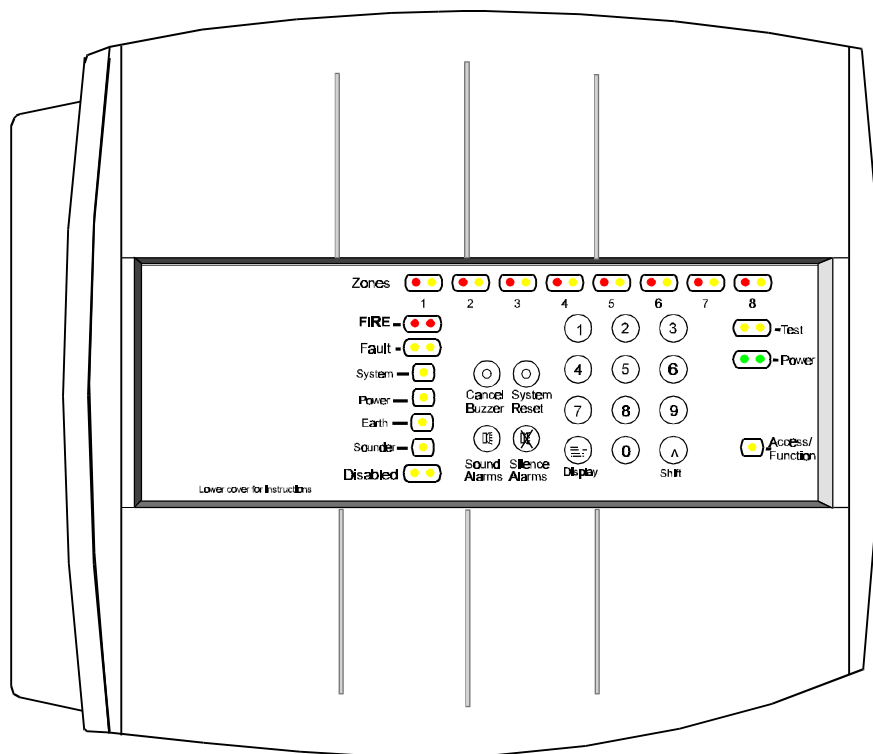

Figure 1 Fire alarm control / repeat panel

cdm64

This publication covers the:

- GENT range XEN1, XEN2, XEN4 and XEN8 fire alarm control panels.
- GENT XEN RPT fire alarm repeat panel.

Design and installation

Specifications	2
System design	5
Cables	8
Notes to the Installer	9
Panel fixing	10

Commissioning

Commissioning	13
Installed system tests	14
Access levels 2 & 3	15
System test functions	16
Panel configuration functions	17
Servicing organisation's access codes	19
Factory functions	20

Operation

User responsibility	21
Fault indications	24
Operating instructions	26

Parts list **28**

Log book **31**

Specification for the Control panel

UK Model No. (with batteries)	XEN1	XEN2	XEN4	XEN8
Number of Zone (detection) circuits	1 - Zone	2 - Zone	4 - Zone	8 - Zone
Zone circuit load (maximum)	2mA per zone			
Number of Sounder circuits	2	2	4	8
Sounder circuit (shared load)	1A at 24V d.c. nominal		1.5A at 24V d.c. nominal	
End-of-line unit	Zone circuit: Capacitor (diode) unit Sounder circuit: 22K ohms resistor			
Standards	EN54 : Parts 2 & 4			
Flush fixing kit	✓	✓	✓	✓
Colour	Front cover - Grey RAL 7000 (standard)			
Assembled panel size (in mm)	395 wide x 274 high x 87 deep			
Weight (with batteries)	5.1Kg	5.1Kg	6.6Kg	6.6Kg
Operating temperature and humidity	0 - 40°C low to +95% RH non condensing			
Storage temperature and humidity	-5°C to +50°C low to +95% RH condensing			
Approvals	LPCB approval to be acquired			
Emission	BS EN50081-1:1992: Part 1 Residential, Commercial & Light industry Class B limits			
Immunity	BS EN50130-4: 1995: Part 4 Alarm systems : Electromagnetic compatibility Product family standard: <i>Immunity requirements for components of fire, intruder and social alarm systems</i>			
IP rating (BS5490)	IP31 (indoor)			
Mains operating voltage	230V ac +10% -6% 50Hz			
Knock-In cable entry points	13 - top & 13 - back			
Terminal size	2.5mm ² maximum			
Battery supply (sealed lead acid)	2-off12V 2.1Ah		2-off12V 2.8Ah	
Battery standby with 1mA load per zone and 1A total sounder alarm load	72hr standby plus 0.5hr with alarm load			
Auxiliary contacts (operates with fire)	Pair of normally closed (NC) and a pair of normally open (NO) contacts rated 1A @ 24V dc resistive load (Maximum 100m cable distance)			
Common Fault	Open collector - normally On (with 1K ohms limiting resistor)			
Common Fire	Open collector - normally Off (with 1K ohms limiting resistor)			
Class change	Normally open push button, up to 100m cable distance away from the panel			
24V Power supply (with foldback current limit)	100mA maximum at 24V d.c. nominal		250mA maximum at 24V d.c. nominal	
User access: By means of code entry via numeric key pad (AL1 Authorised user - No code is required)	AL2 Site security	3 digit code - 123		
	AL3 Site engineering	3 digit code - 321		
	AL4 Engineers	4 digit code - 7426		
	Servicing organisation	4 digit code - 4083		
	Reset AL2 & AL3 codes	4 digit code - 2623		
Key pad button controls	Sound alarm, Silence alarm, System Reset & Cancel buzzer & numeric keypad.			
Buzzer for local audible indications	Fire & System Fault - continuous sound Fault - intermittent sound (via piezoelectric buzzer operating at 2KHz 70dB(A) at 1m)			
Visual indications	FIRE & ZONES-fire (Red LEDs 'lights') ZONES-fault, Fault, System, Power, Earth, Sounder, Disable, Test, Power, Access/Function (Yellow LEDs 'lights') Power on (Green LED 'light')			
Repeat panel connections	Serial port , see also repeat panel specification			

Specification for the Repeat panel

UK Model number	XEN RPT
Number of Zones	8 - Zone (standard size)
Standard	EN54 : Parts 2 & 4
Flush fixing kit	✓
Colour	Front cover - Grey RAL 7000
Assembled panel size (in mm)	395 wide x 274 high x 87 deep
Weight (with batteries)	5.1Kg
Operating temperature and humidity	0 - 40°C low to +95% RH non condensing
Storage temperature and humidity	-5°C to +50°C low to +95% RH condensing
Approvals	LPCB approval to be acquired
Emission	BS EN50081-1:1992: Part 1 Residential, Commercial & Light industry Class B limits
Immunity	BS EN50130-4: 1995: Part 4 Alarm systems : Electromagnetic compatibility Product family standard: <i>Immunity requirements for components of fire, intruder and social alarm systems</i>
IP rating (BS5490)	IP31 (indoor)
Mains operating voltage	230V ac +10% -6% 50Hz
Knock-In cable entry points	Top & back entries
Terminal size	2.5mm ² maximum
Battery supply (sealed lead acid)	2-off 12V 2.1Ah
Standby duration	72hr standby
User access: By means of code entry via numeric key pad (AL1 Authorised user - No code is required)	AL2 Site security 3 digit code - 123 AL3 Site engineering 3 digit code - 321 AL4 Engineers 4 digit code - 7426 Servicing organisation 4 digit code - 4083 Reset AL2 & AL3 codes 4 digit code - 2623 <i>NOTE: Only a limited number of functions are accessible at the repeat panel.</i>
Key pad button controls	Sound alarm, Silence alarm, System Reset & Cancel buzzer & numeric keypad.
Buzzer for local audible indications	Fire & System Fault - continuous sound Fault - intermittent sound (via piezoelectric buzzer operating at 2KHz 70dB(A) at 1m)
Visual indications	FIRE & ZONES-fire (Red LEDs 'lights') ZONES-fault, Fault, System, Power, Earth, Sounder, Disable, Test, Power, Access/Function (Yellow LEDs 'lights') Power on (Green LED 'light')
Repeat panel (standard 8 zone)	A maximum of up to 6 repeat panels connected in series to the control panel
Repeat panel connections	Serial port

Zone circuit products (24Vdc)

See control panel specification for zone circuit loading.

Part number	Product	Operating voltage	Quiescent current	Alarm current
17640-01	Optical smoke detector	16V dc to 32Vdc	90uA	10mA Maximum can be upto 65mA limited by the control panel
17630-01	Ionisation smoke detector		50uA	
17650-01	Fixed temperature heat detector		45uA	
17660-01	Rate of rise heat detector		45uA	
17670-01	High temperature heat detector		90uA	
17615-01	Duct detector		90uA	
17906-49	Remote external LED for detector		-	
07011-31	Beam detector		see note	
14112-08	Manual call point (surface) 470R		n/a	As per detectors
14112-18	Manual call point (flush) 470R		n/a	

NOTE: If the beam detector is used then it must be powered from an external power supply.

Sounder circuit products (24Vdc)

See control panel specification sounder circuit loading.

Part number	Product	Alarm current
12511-37	Electronic sounder (red)	20mA
12511-52	Electronic sounder (grey)	20mA
12141-04	Electronic bell (red) IP40	30mA
12141-54	Electronic bell (grey) IP40	30mA
02601-31	Sounder	18mA
02300-01	Xenon flasher (red)	125mA
02300-01	Xenon beacon (red)	45mA

Door holders

NOTE: The door holder circuit should be controlled by the control panel's auxiliary contacts, using external power supply.

Part number	Product	Current
04390-31	Door holder (24Vdc)	22mA
04390-55	Door holder (240Vac)	17.5mA

System design

The design of the fire detection and alarm system should be to *BS 5839:Part 1:1988 Code of Practice for system design installation and servicing.* Supplemented with customer requirements.

Mains Supply Connection

The mains supply to the control panel should be via a fused spur unit rated:
 5A for 1 & 2 Zone panel
 7A for 4 & 8 Zone panel

Standby Supply

With the recommended battery the control panel will provide a standby supply under mains failure conditions, for a period of 72 hours followed by 30 minutes of alarm load, see specification.

24V supply

The power supply terminals '24+' and '0' may drive external ancillary equipment and is designed to be used in conjunction with auxiliary contacts and common fire and fault outputs, see *control panel specification.*

NOTE: The use of the 24V supply will affect the panel standby capability.

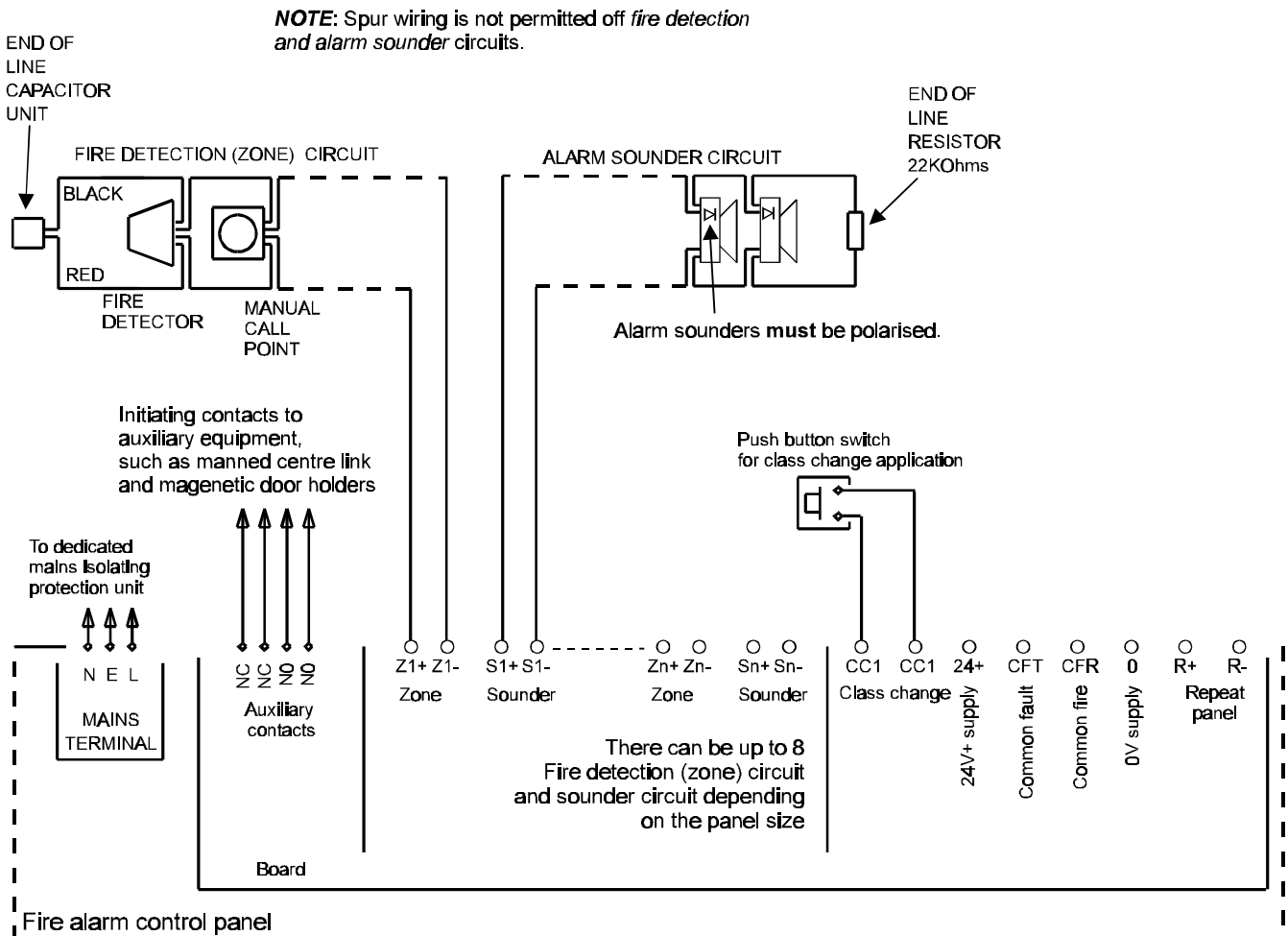

Figure 2 System schematic

cdm65

Fire Detection (Zone Circuits)

See parts list for compatible parts.

Each zone circuit can have up to 2mA load. An end-of-line capacitor unit is required for zone circuit monitoring, which must be fitted after the last detector or manual call point on the circuit.

All manual call points used must have a 470 ohms series resistor.

NOTE: If a Beam detector is used, then it must be powered from an independent supply.

Where a zone circuit is not being used, the *end-of-line* capacitor unit must be fitted across its terminals in the panel.

Alarm (Sounder circuits)

NOTE: All sounder circuits (sectors) will always operate together in the event of a fire condition.

See parts list for compatible parts.

To comply with the requirements of BS 5839: Part 1:1988, a minimum of two alarm sounder circuits should be used on all installations.

1 & 2 Zone Panel	4 & 8 Zone Panel
1A maximum Alarm sounder load per panel	1.5A maximum Alarm sounder load per panel

The load must be shared between the sounder circuits.

The alarm sounder circuits are regularly pulse monitored for failure. It is important that the last alarm sounder is fitted with a 22K Ohm end-of-line resistor.

Where a sounder circuit is not being used, the *end-of-line* resistor must be fitted across its terminals in the control panel.

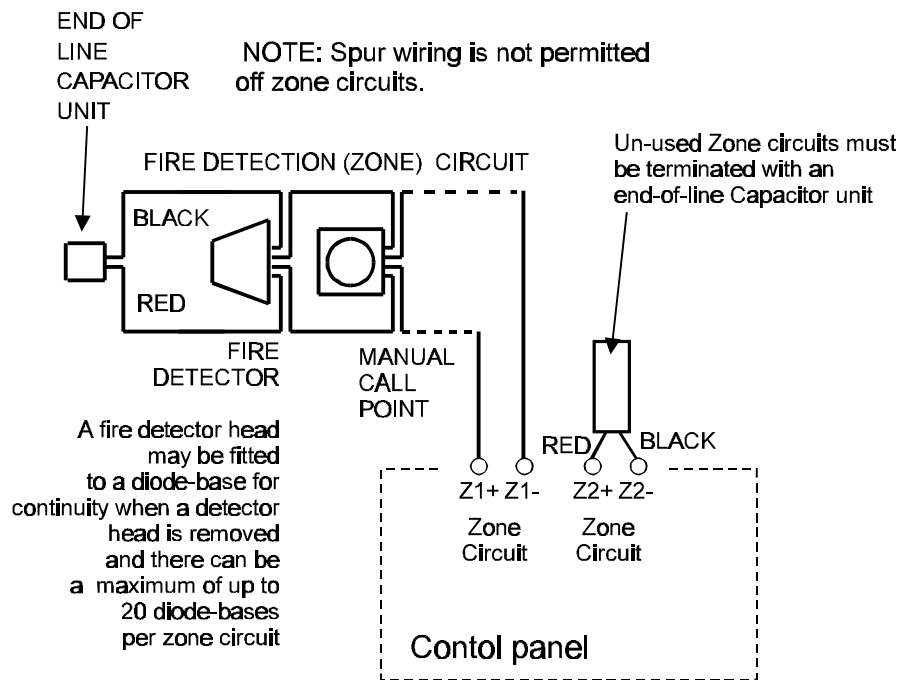

Figure 3 Zone circuit connections

cdm68

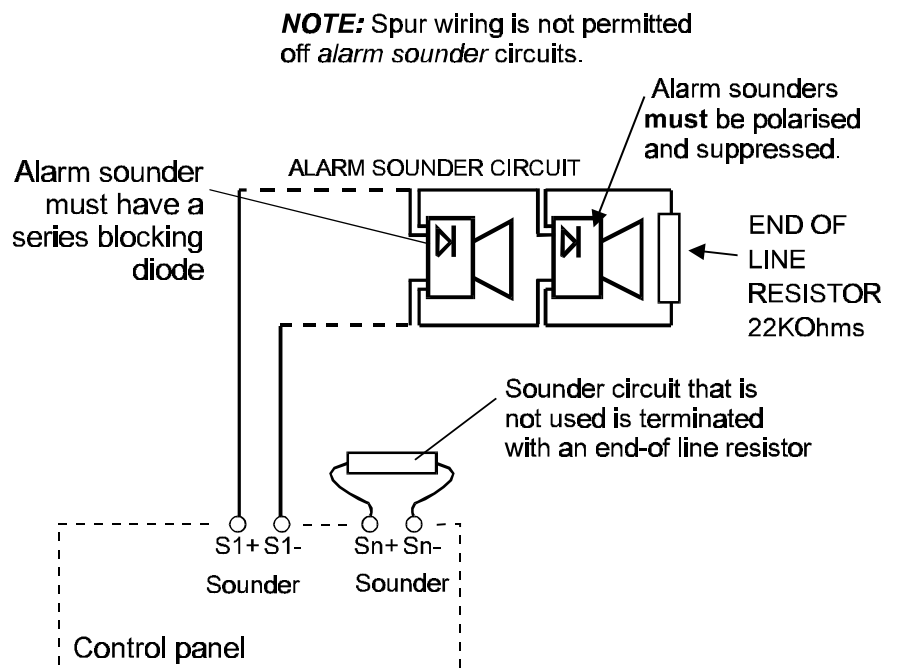

Figure 4 Alarm sounder connections

cdm67

Auxiliary Contacts

These are normally open (NO) and normally closed (NC) contacts that switch over when the panel goes into a fire condition.

The contacts are rated at 24V d.c. 1A for a resistive load and should not be used to switch voltages in excess of 50V.

The auxiliary circuits should be powered from an independent power supply.

Class Change

A pair of unmonitored terminals allow only the system alarm sounders to be actuated from a remote position. It is considered that the major use for these will be for class change functions in schools and colleges.

NOTE: *There is no indication at the panel of class change push button operation.*

Common Fire and fault

The **common fault** output is a normally closed electronic switch, which opens with a fault condition, this is for a fail safe operation.

The **common fire** output is normally open electronic switch that closes with a fire condition.

NOTE: *Each electronic switch has an in-line 1K ohms resistor.*

The +24V & 0V is a power supply for use with auxiliary contacts, common fire and common fault circuits, see specification.

Repeat Panel

There can be up to 6 repeat panels series connected from the control panel. A repeat panel duplicates fire and fault indications together with system controls.

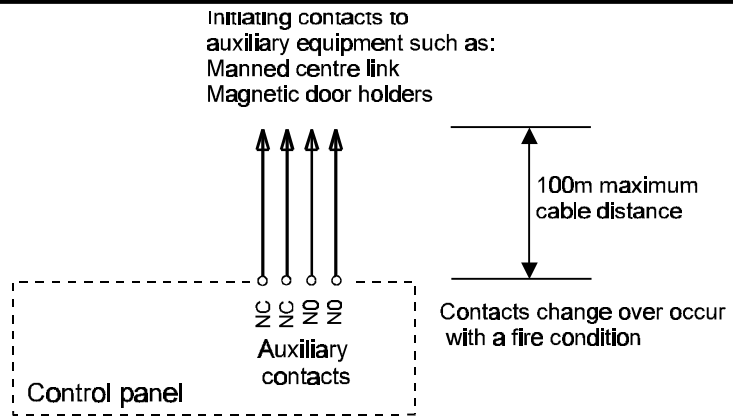

Figure 5 Auxiliary contact circuit
cdm72

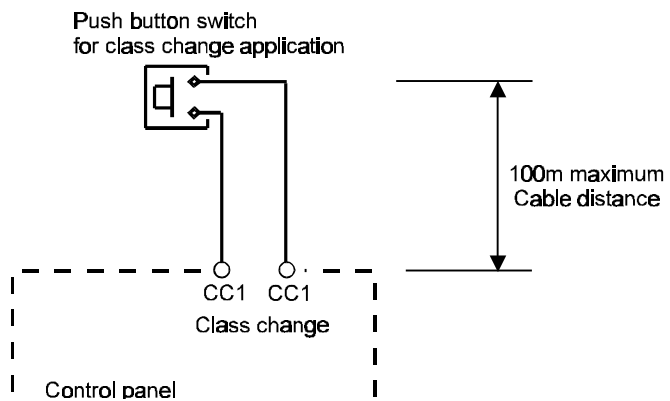

Figure 6 Class change circuit
cdm73

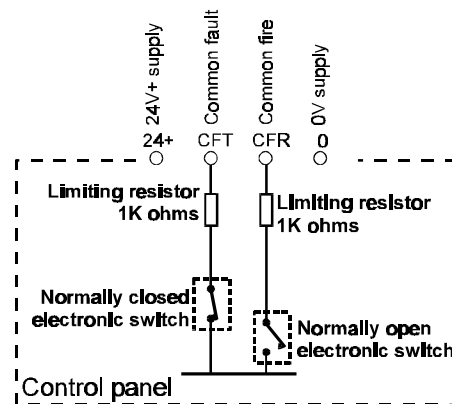

Figure 7 Fire fault & 24V outputs
cdm74

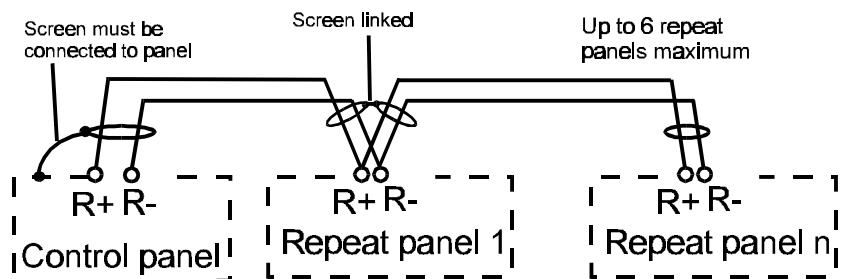

Figure 8 Control to repeat panel connections
cdm75

Cables

For the wiring of:

Length per circuit	Type of circuit	Recommended cables, also see BS5839:Part 1 guidance
2m	Mains power supply cord	see power supply cord
1Km	Zone circuit	See BS5839:Part 1 guidance
1Km	Sounders circuit	
100m	Auxiliary circuit	
100m	Common fire and fault circuit	
100m	Class change circuit	
500m	Repeat panel link	Belden type screened 2-core twisted pair

The guidance of BS5839 : Part 1: 1988 should be followed.

The use of cables, such as (MICC or Belden) are recommended.

Generally available electrical installation cable may be used, providing the cable is:

- to BS6387
- with no more than **2 - cores**
- each core having no less than **1.5mm²** cross section area
- with an inherent or through metal conduit screen for earth continuity in order to produce electrical protection and screening
- having protection from heat and mechanical damage

Power supply cord

This should be a 3-core cord having a rated current of:

- 5A with a nominal core cross sectional area of 0.75mm² provided the length of the cord does not exceed 2m.

Cable termination

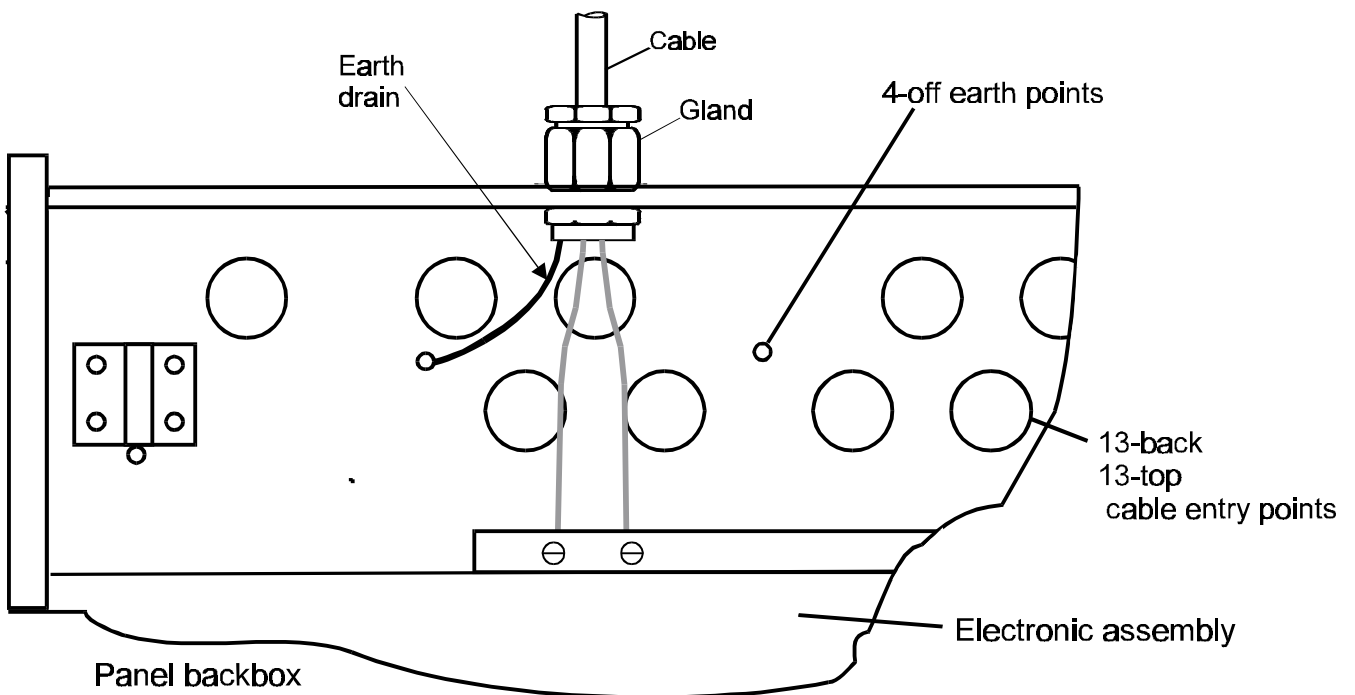

Figure 9 Panel cable entry and earth points

cdm158

Notes to the installer

Checks

- The power-up and commissioning is done by the servicing organisation.
- The wires between the termination point and terminals should be **short** and **straight** as possible.
- The cables of the fire detection and alarm system and other systems should usually be separated by at least **160mm**, unless dedicated conduit or ducting is used.
- Do not use any part of building structure for earthing.
- The cable length between the Repeat LED unit and respective fire detector where used , should not exceed **10m**
- Cable Glands should be used on the equipment for the mains supply cable.
- Unused knockouts on product enclosure that have been removed, should not be left open.

Requirements

It is recommended that the installer follow the general requirements of:

- *BS5839:Part 1:1988*, which is the *code of practice relating to the fire detection and alarm systems for buildings*.
- the relevant parts of the *BS 7671 Requirements for Electrical Installation Institute of Electrical Engineers Wiring Regulations 16th edition*.

Second fix installation

To prevent the possibility of damage or dirt degrading the performance or appearance of the System products:

the installation of second fix items should be delayed until all major building work in the area is complete.

Fixtures and fittings

It is the installers responsibility to provide:

- adequate fixtures and fittings for the type of construction surface onto which a product is to be installed.
- as an aid to this decision, the weight and overall size of each full assembly together with implications on cable entries and routing should be taken into consideration.

NOTE: All these procedures assume that the cable, gland, steel box (BESA box) and other related accessories are provided by the installer.

As fitted wiring drawings

The installer should acquire:

- site specific information from the interested parties, for details on the location of products for installation
- the acquired information together with this guide and the relevant standards should be used to assist the work.

Earth continuity

To maintain earth continuity, the cable screen must be continued through each system device, whether the earth is connected to a device or not.

Panel fixing

- a) Remove panel from its packing, but retain the carton for storage of spare parts and loose items.
- b) Remove the top and bottom inner plates, see Figure 10.
- c) Check the spares parts supplied with those listed in Table 1. If replacement parts are required at any time, only spares that are of the same specification should be used.
- d) Remove the transformer and earth connections from the *electronic assembly*, and then remove the electronic assembly from the panel, see Figure 11. Store the electronic assembly in a safe place until required.
- e) Remove the appropriate knock-in on the panel case for cable entry.
- f) Hold the panel on the wall in the desired mounting position and mark the positions of the fixing holes. See Figure 11 for case fixing details.
- g) Secure the panel to the wall using suitable fixing such that adequate support is provided to the control panel assembly. A top centre keyhole fixing is provided on the case to allow the panel to be hooked whilst the bottom two fixing points are located.
- h) Connect the mains supply cable to the panel. The cable:
 - must be through one of the dedicated cable entry into the panel
 - via an **unswitched fused spur** unit, rated **5A** for the 1&2 Zone Control and Repeat panels and **7A** for 4&8 Zone panels.

The fused spur isolator cover should be red and marked:
FIRE ALARM - DO NOT SWITCH OFF

The fused spur units must be fed from a dedicated switch or protective device at the local mains supply distribution board.

Description For fuses also see Figure 12	Quantity supplied with control panel				Repeat panel
	1 - zone	2 - zone	4 - zone	8 - zone	8 - zone only
22K end-of-line resistor	2	2	4	8	
Capacitor unit	1	2	4	8	
End-of-line label	3	4	8	16	
Fuse 5A 20mm x 5mm AS (mains terminal block)			1	1	
Fuse 3.15A 20mm x 5mm AS (mains terminal block and power 1 & 2 - F1 &F2)	2	2	2	2	2
Fuse 5A 20mm x 5mm QB (battery F3)	1	1	1	1	1
Fuse 0.5A 20mm x 5mm QB (sector)	2	2	2	2	
Fuse 0.16A 20mm x 5mm QB (sector)			2	6	
Battery link	1	1	1	1	1
Zone designation label	1	1	1	1	1

Table 1 Spare parts supplied with each panel

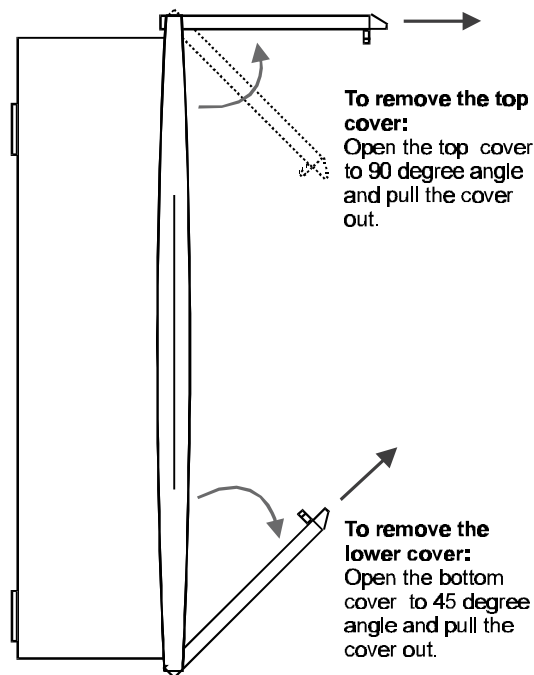

Figure 10 How to remove the outer covers

cdm77

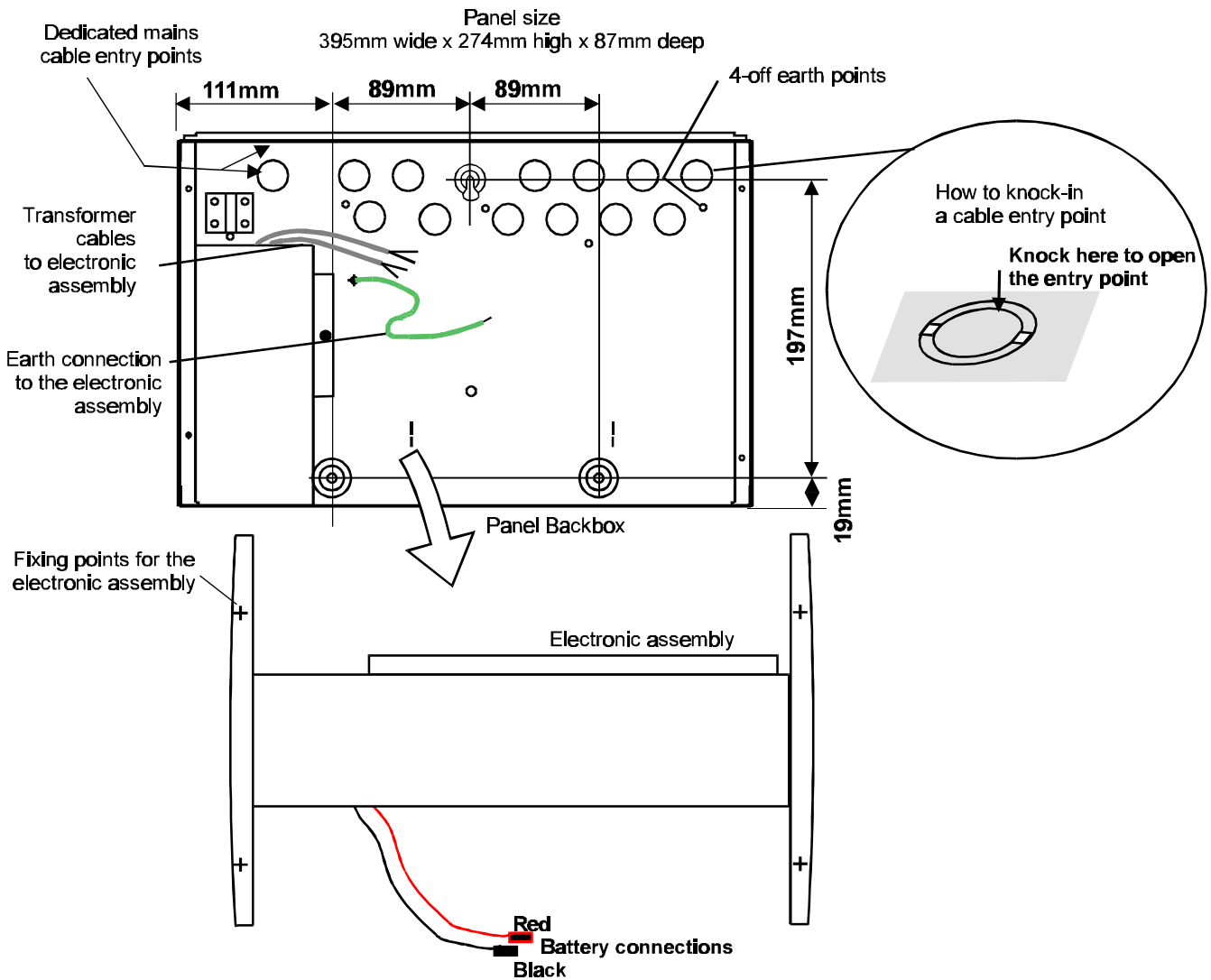

Figure 11 Panel fixings

cdm69

- i) Wire the system. With the exception of mains cable, all other cables should remain unconnected at the panel.
- j) Refit the *electronic assembly* into the panel and connect the transformer and earth cables previously removed, see Figure 11.

For the unconnected cable leave **300mm** tail wire length and mark each core identifying its final point of connection.

The system wiring can be tested whilst not connected to the respective terminals at each system equipment.

NOTE: Each terminal in a panel will accept a maximum conductor size of 2.5mm square.

NOTE: The installation of all outstanding parts are usually carried out during Commissioning of the System.

Store all spare parts and loose components including the batteries inside the panel carton and keep in a safe place until required.

CAUTION: DO NOT undertake high voltage insulation tests WITH THE CABLES CONNECTED to their terminals. Such a test may damage the electronic circuitry in the system equipment.

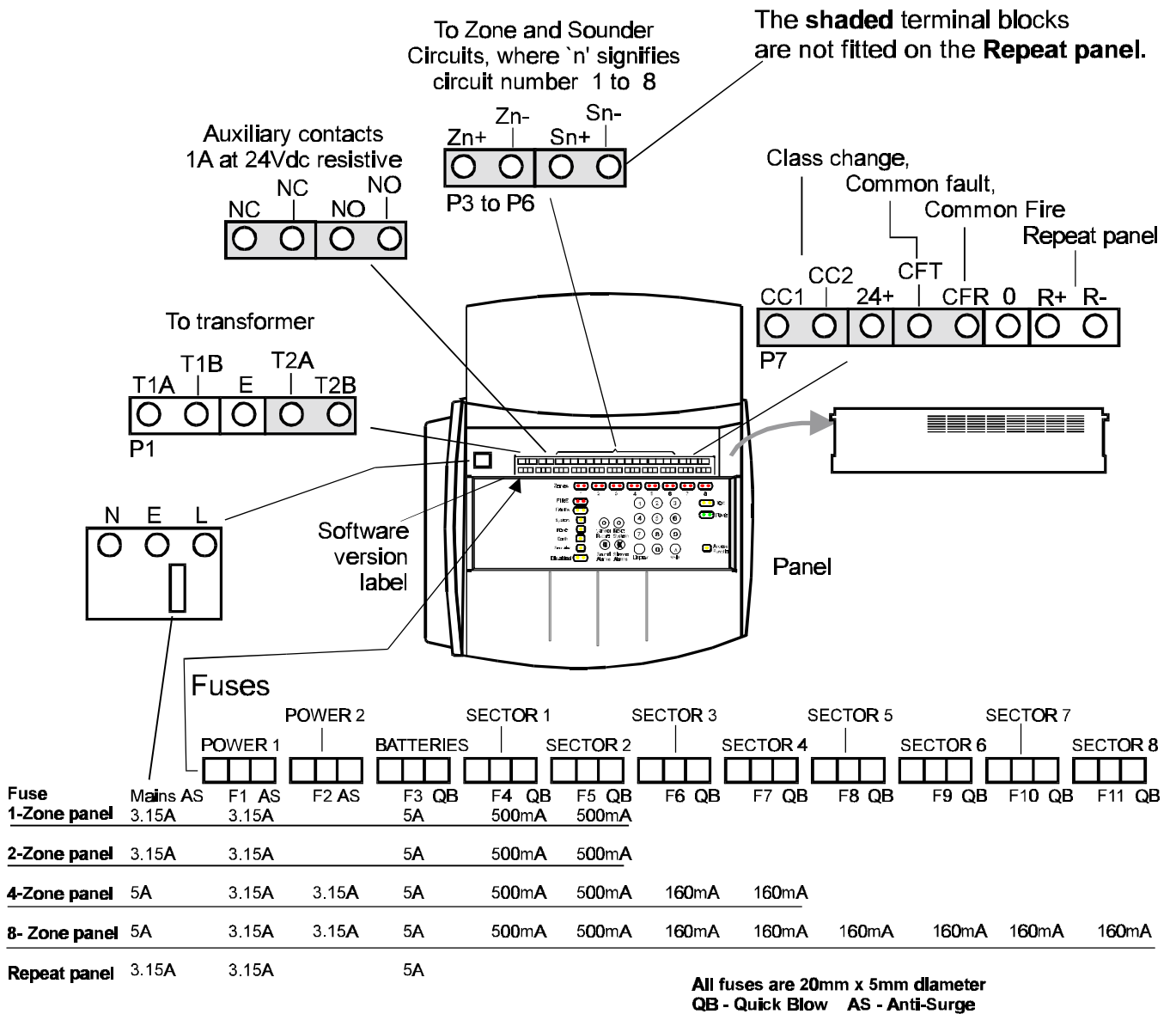

Figure 12 Panel terminals and fuses

cdm70

Commissioning

The total system should be tested in accordance with the commissioning requirements of BS5839:Part 1:1988 or other standard specified by the system purchaser.

NOTE: The commissioning procedures assume that the system has been installed as per instructions in this booklet.

System checks

- Acquire as fitted drawings
- check the system has been installed to the project requirements.
- if appropriate, action the installer to carry out changes to the system.

Initial power up

- a) Disconnect cables to terminals of zone, sounder, class change, auxiliary, common fire and fault circuits. Ensure each cable is marked for reconnection to respective terminals later.
- b) Connect end-of-line units to zones and sounder circuits for initial power up.
- c) Check mains connection and switch on the mains power to the control panel.
- d) Now connect the battery supply, see Figure 13.
- e) Check the panel provides a normal healthy indication, with the green light lit.

Zone circuit tests

- a) Transfer the end-of-line capacitor unit to the last device (detector or manual call point) on a zone circuit.
- b) Connect the zone cable to the zone circuit terminals.
- c) Carry out zone open circuit and short circuit tests and check appropriate indications are given.
- d) Repeat the above for other zone circuits.

Sounder circuit tests

- a) Transfer the end-of-line resistor unit to the last device on a sounder circuit.
- b) Connect the sounder circuit cable to the sounder circuit terminals.
- c) Carry out sounder open and short circuit tests and check appropriate indications are given.
- d) Repeat the above for other sounder circuits.

a) Open the lower outer cover

Control panel

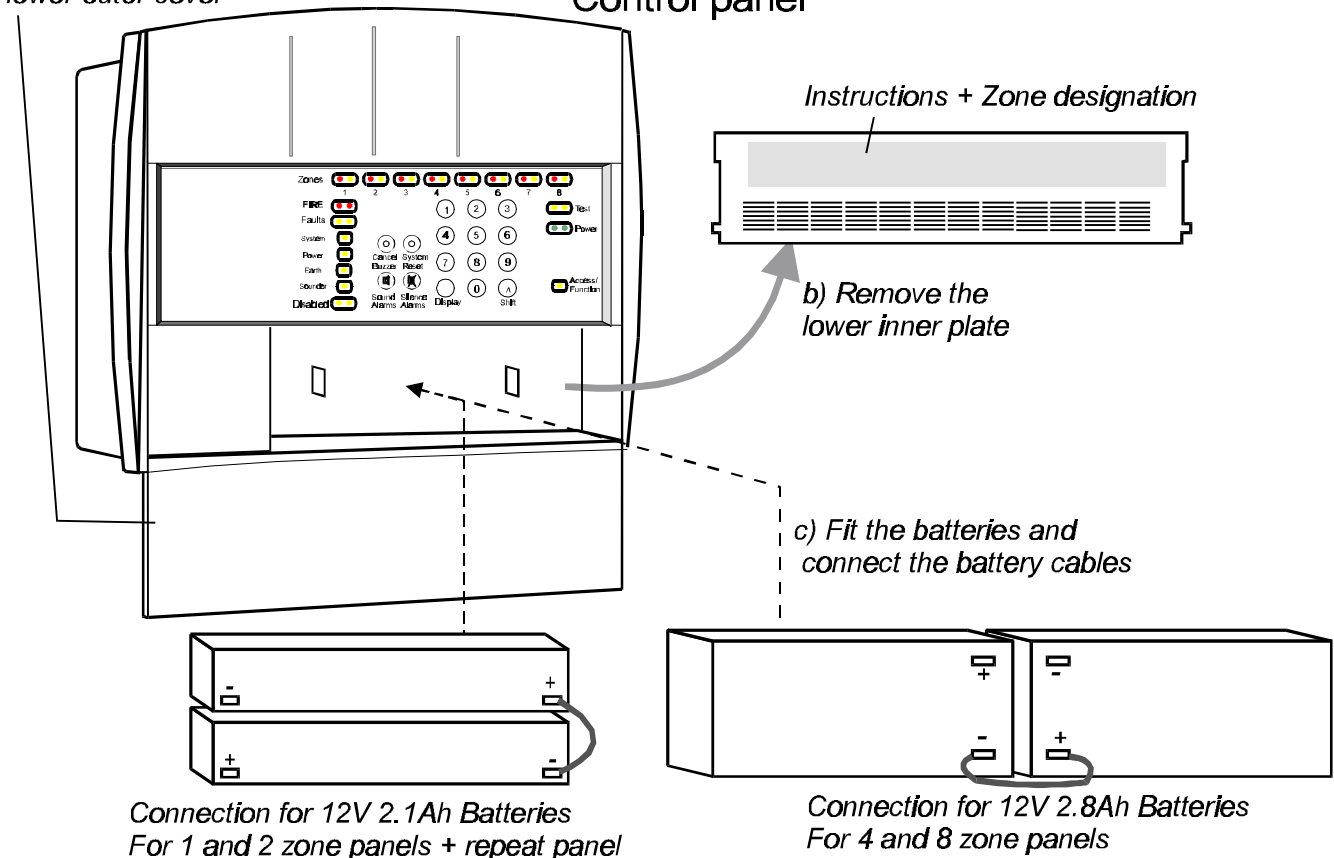

Figure 13 Battery installation

cdm71

Installed system tests

The fire detection and alarm system should be tested to ensure it operates to meet the standards and project requirements.

Configuration

The control and repeat panels are factory set to the requirements of EN54 Parts 2 and 4.

The operation of the control and repeat panels and the system may be re-configured to site specific needs, see system test functions and Panel configuration functions.

CAUTION: *Any special configurations may cause the system and equipment to operate outside the requirements of European standards.*

Test mode A or B operation

To facilitate tests on the fire detection and alarm system the control panel can be set to operate in a test mode, see System test functions.

With **Test mode A or B** active: a triggered manual call point or fire detector in the test zone will give:

Test A	Test B
<p>Fire indication for 10 seconds duration followed by a system reset</p>	<p>System alarm sounds for the first 2 seconds and at the same time a Fire indication is given for 10 seconds duration followed by a system reset</p>

Table 2 Test mode operation

NOTE: *A detector that is still full of smoke or heat will retrigger into a fire condition until the smoke or heat in the area is cleared.*

Repeat panel configuration

There can be up to 6 repeat panels connected in series to the the control panel.

Each repeat panel connected to the system is required to be given an address at both the **control and repeat panels**, see Panel configuration section.

Sound level test

Sound level tests should be conducted to standard requirements and to customer satisfaction.

Other equipment tests

Where external equipment is connected to the control panel using auxiliary, common fire and fault terminals, then these must be tested to project requirements.

Zone designation label

- a) Write on to the zone designation label the name that identifies the area protected by each zone circuit.
- b) Fix the label over the zone designation part of the lower inner plate, see figure 13.

Log book

Fill in system details on the first three pages of the log book.

On completion

Ensure the persons responsible for the system are made aware of

- system operation
- access codes to controls
- basic controls
- their responsibility
- and the need to log system events in the log book.

Access levels 2 and 3

The control and repeat panels provides system security by coded password entry to controls.

There are three coded access levels to user controls, also see Table 3.

- Access level 1 (AL1)** is for *authorised user*.
- Access level 2 (AL2)** is for *site security*.
- Access level 3 (AL3)** is for *site engineer*.

Access codes

The factory set codes for:

- AL1 - No code required
- AL2 - is 123 (default)
- AL3 - is 321 (default)

The AL2 and AL3 are 3-digit codes.

NOTE: The standard AL2 and AL3 access codes are factory set. These codes may be changed to user defined codes.

Access Levels->	AL1	AL2 Code: ☛123	AL3 Code: ☛321
What is accessible			
Cancel buzzer (fire and fault)	☛☛②	✓	✓
System Reset		✓	✓
Sound alarms		✓*	✓*
Silence alarms		✓	✓
Disable / Enable sounders		✓	✓
Disable / Enable zone(s)		✓	✓
Zone(s) only Test A		☛☛①	✓
Zone(s) with sounders Test B		☛☛①	✓
Cancel Test A / Test B		☛☛①	✓
Display test	☛☛②	✓	✓
All indications	✓	✓	✓
Zone designations (located behind lower cover)	✓	✓	✓
Instructions (located behind lower cover)	✓	✓	✓
Change to AL2 and AL3 user password			✓
Repeat panel address			✓
A Shaded option is not applicable to the repeat panel.			

- ① This option may be moved to AL3, see Panel configuration section
- ② This option may be moved to AL2, see Panel configuration section
- ☛ factory setting

Table 3 Controls accessible at various user levels

System test functions

To ease the testing of the system it is necessary to gain access to some of these functions.

NOTE: It is only necessary to enter the access code once, provided the 2 minute timeout is not exceeded between button presses.

Access code

AL2 Code : 123 may be used to gain access to the test functions. Depending on how the system is configured it may be necessary to use AL3 code 321 instead of AL2 code.

The factory set AL2 and AL3 codes are 123 and 321 respectively on first power-up. If the codes are changed at any time then the power-up codes are not applicable.

NOTE: It is important to leave the system in a normal operating condition on completion of commissioning.

How to	Controls	Result
How to do a Display test	Enter the 3 digit code (n) (n) (n) then: press shift (A) and display (E) buttons	All indicators are lit (flashing indication for zone fire/fault) and the buzzer sounds for 10 seconds duration
How to set the panel to operate Test mode A	Enter the 3 digit code (n) (n) (n) then: press (A) (3) and the respective zone (1) - (8)	This will allow the zone circuit(s) to be tested without an alarm of fire.
How to set the panel to operate Test mode B	Enter the 3 digit code (n) (n) (n) then: Press (A) (4) and the respective zone (1) - (8)	This will allow the zone circuit(s) to be tested with 2 second alarm of fire.
How to Cancel Test mode A/B	Enter the 3 digit code (n) (n) (n) then: Press (A) (5) and the respective zone (1) - (8)	This will cancel any active Test mode, either A or B.
How to Disable a zone	Enter the 3 digit code (n) (n) (n) then: Press (A) (1) and the respective zone (1) - (8)	A fired detector in disabled zone(s) will not cause the panel to go into a fire condition.
How to Enable a zone	Enter the 3 digit code (n) (n) (n) then: Press (A) (2) and the respective zone (1) - (8)	This will re-enable all previously disabled zone circuit(s).
How to Disable sounders	Enter the 3 digit code (n) (n) (n) then: Press (A) (1) and followed by (0)	This will disable the Sounder circuits operation.
How to Enable sounders	Enter the 3 digit code (n) (n) (n) then: Press (A) (2) and (0)	This will re-enable previously disabled sounder circuits.
How to change AL2 password	Enter the AL3 3-digit code (n) (n) (n) then: Press (A) (9) (0) (0) (1) followed by the new 3-digit code (n) (n) (n) and (A) (0)	This will allow a previous AL2 password to be changed to a new 3-digit code
How to change AL3 password	Enter the AL3 3-digit code (n) (n) (n) then press (A) (9) (0) (0) (2) followed by the new 3-digit code (n) (n) (n) and (A) (0)	This will allow a previous AL3 password to be changed to a new 3-digit code
How to exit from AL2, AL3 or AL4 to AL1	Press (A) (0)	This will exit the current access level and return to AL1

Panel configuration functions

To ease the commissioning of the system it is necessary to gain access to some of these functions.

NOTE: *It is only necessary to enter the access code once, provided the 2 minute timeout is not exceeded between button presses.*

Access code

AL3 Code : 321 may be used to gain access to these commissioning functions.

The AL3 code is: 321 on first power-up. If the code is changed at any time then the power-up code is not applicable.

NOTE: *It is important to leave the system in a normal operating condition on completion of commissioning.*

How to:	Controls	Result	Factory default
How to terminate the EEPROM programming mode	Press Shift (A) followed by (9)	This will terminate the programming mode at any stage, and return the EEPROM to a protected state.	
How to set a repeat panel address at the control panel There can be up to 6 repeat panels in a system.	Enter the AL3 3-digit code (n) (n) (n) then: Press (A) (9) (0) (0) (0) followed by location (0) (3) (8) and the repeat panel address (0) (0) (1) and then (A) (0) .	At the Control panel location 038 an entry is made of the first repeat panel address 001 Depending on the number of repeat panels used, similarly at locations 039, 040, 041, 042 and 043 entries are made of the 2nd, 3rd, 4th, 5th and 6th repeat panel addresses, which may be 002, 003, 004, 005 and 006 respectively.	Repeat panel address is 000
How to set a repeat panel address at the repeat panel There can be up to 6 repeat panels in a system.	Enter the AL3 3-digit code (n) (n) (n) then: Press (A) (9) (0) (0) (0) followed by location (0) (3) (8) and repeat panel address (0) (0) (1) and (A) (0) .	At the Repeat panel location 038 an entry is made of the repeat panel address, in this case it is 001. Other repeat panels can be given an address from the range 002 to 006, which must be entered in location 038 ..	Repeat panel address is 001
How to move 'Cancel buzzer' from access level AL1 to AL2	Enter the AL3 3-digit code (n) (n) (n) then: Press (A) (9) (0) (0) (0) followed by location (0) (3) (2) , and data (0) (0) (1) and (A) (0) .	This will move the Cancel buzzer button access to level 2.	
How to move 'Cancel buzzer' from access level AL2 to AL1	Enter the AL3 3-digit code (n) (n) (n) then: Press (A) (9) (0) (0) (0) followed by location (0) (3) (2) , and data (0) (0) (0) and (A) (0) .	This will move the 'Cancel buzzer' button access to level 1.	✓

How to:	Controls	Result	Factory default
How to move 'Test A&B' and Cancel Test from access level AL3 to AL2	Enter the AL3 3-digit code n n n then: Press A 9 0 0 0 followed by location 0 3 4 , and data 0 0 1 and A 0 .	This action will move the 'Test A&B and Cancel test' functions from AL3 to AL2.	✓
How to move 'Test A&B' and Cancel test from AL2 to AL3	Enter the AL3 3-digit code n n n then: Press A 9 0 0 0 followed by location 0 3 4 , and data 0 0 0 and A 0 .	This action will move the 'Test A&B and Cancel test' functions from AL2 to AL3.	
How to set the most recent fire as a steady indication.	Enter the AL3 3-digit code n n n then: Press A 9 0 0 0 followed by location 0 3 5 , data 0 0 0 1 and A 0 .	This will result in the most recent fire being displayed as a steady indication.	✓
How to set the most recent fire as a pulsing indication.	Enter the AL3 3-digit code n n n then: Press A 9 0 0 0 followed by location 0 3 5 , data 0 0 1 and A 0 .	This will result in the most recent fire being displayed as a pulsing indication.	
How to set the auxiliary relay to operate (energise) with sound alarms.	Enter the AL3 3-digit code n n n then: Press A 9 0 0 0 followed by location 0 3 7 data 0 0 1 and A 0 .	This will result in the auxiliary relay activation with sounders.	
How to set the auxiliary relay to operate (energise) with fire condition.	Enter the AL3 3-digit code n n n then: Press A 9 0 0 0 followed by location 0 3 7 data 0 0 0 and A 0 .	This will result in the auxiliary relay activation with a fire condition.	✓
How to move 'Display test' from access level AL2 to AL1.	Enter the AL3 3-digit code n n n then: Press A 9 0 0 0 followed by location 0 3 3 data 0 0 1 and A 0 .	This will move the 'Display test' button access to AL1.	✓
How to move 'Display test' from access level AL1 to AL2.	Enter the AL3 3-digit code n n n then: Press A 9 0 0 0 followed by location 0 3 3 data 0 0 0 and A 0 .	This will move the 'Display test' button access to AL2.	

Servicing organisation access codes

CAUTION: Under normal circumstances the factory settings must not be altered.

NOTE: The Access level 4 code, Servicing organisation's engineers code and the Reset codes are for servicing organisation use only.

Access Levels->	AL4 Code: 7426	Service Organisation's Engineers Code: 4083	Reset Code: ☛2623
What is accessible			
All access level 2 (AL2) and access level 3 (AL3) functions, see Access levels 2 & 3 section	✓	✓	
Reset AL2 and AL3 password to factory settings			✓
Factory settings	✓		

Access code 2623 will reset AL2 and AL3 passwords to their factory default setting.

* - Note the European practice is to Sound Alarms in fire condition only

☛ factory setting

The control and repeat panels provides system security by coded password entry to controls.

Other access levels

There are four coded access levels to controls.

- Access level 1 (AL1)** is for authorised user.
- Access level 2 (AL2)** is for site security.
- Access level 3 (AL3)** is for site engineer.
- Access level 4 (AL4)** is for servicing organisation.

Access codes

The factory set codes for:

- AL1 - No code required
- AL2 - is 123 (factory set)
- AL3 - is 321 (factory set)
- AL4 - is 7426
- Servicing organisation's engineers code - is 4083

Table 4 Servicing organisation access levels

The AL2 and AL3 are 3-digit codes that may be changed to user defined ones. Once redefined the factory codes are not applicable.

- Reset code - is 2623

The Reset code allows the user defined AL2 and AL3 codes to be reset to their default factory settings.

Factory functions

NOTE: It is only necessary to enter the access code once, provided the 2 minute timeout is not exceeded between button presses.

AL4 Code : 7426 may be used to gain access to change the factory settings.

CAUTION: On entering this mode to make changes the factory settings, the EEPROM remains unprotected, ensure the EEPROM protection is reinstated.

The system fault light will indicate when the EEPROM protection is removed.

Press Shift **(A)** followed by **(9)** to terminate the configuration mode at any stage, and return the EEPROM to a protected state.

How to change control panel zone and alarm circuit operation

Selections	Controls	Result	Factory default
Silence alarms + Reset to operate as BS5839:Part4	Enter the AL4 4-digit code (n)(n)(n)(n) then: Press (A)(9)(0)(0)(0) followed by location (1)(5)(8) and data XXX and (A)(0) . See How to work out the XXX number.	The Silence alarms button must be pressed before Reset button.	
Silence alarms + Reset to operate independently		The Silence alarms button and reset button operate independently.	✓
Reset system button operation also actions Silence alarms		The Reset button will also action the Silence alarm button.	
Sound alarms in fire only		The Sound alarms button will only operate in fire condition.	✓
Sound alarms at any time.		The Sound alarm button will operate at any time.	
Zone short circuit is a fault		A short circuit on a zone will cause a zone fault.	✓
Zone short circuit is a fire		A short circuit on a zone will cause a zone fire.	
Detection band A		See devices in parts list	✓
Detection band B		tba	
Detection band C		tba	

How to work out the XXX number

Bits		7	6	5	4	3	2	1	0
Detection Band	A							0	0
	B							0	1
	C							1	0
Silence alarms & Reset button operation	As BS5839:Part4						0	0	
	both independent						0	1	
	Reset actions Silence alarms						1	0	
Sound alarms	At any time				0				
	In fire condition				1				
Zone Short circuit	Fault			0					
	Fire			1					
Default byte required		0	0	0	1	0	1	0	0
Decimal number of each bit		128	64	32	16	8	4	2	1

The **default decimal number** is 20. Therefore the XXX number is **020**. Note the shaded cells are factory defaults.

Example: If we need: *Band A*
As BS 5839 Part 4
Sound alarm at any time
and zone short equals fire.

Then the Byte required will be:
 = 00100000
 which is decimal 32

therefore the XXX number required is 032.

Panel zone operation

How to:	Controls	Result	Factory default
How to set latching and non latching zones	Enter the AL4 4-digit code $\text{\textcircled{n}}\text{\textcircled{n}}\text{\textcircled{n}}\text{\textcircled{n}}$ then: Press $\text{\textcircled{A}}\text{\textcircled{9}}\text{\textcircled{0}}\text{\textcircled{0}}\text{\textcircled{0}}$ followed by location $\text{\textcircled{1}}\text{\textcircled{5}}\text{\textcircled{7}}$ and data YYY and $\text{\textcircled{A}}\text{\textcircled{0}}$. See How to work out the YYY number.	This will cause fired zone to clear automatically if the zone circuit returns to a normal operating condition	all zones are set for latched operation

How to work out the YYY number

Control panel zone number	8	7	6	5	4	3	2	1	The corresponding bit of the data byte that relates to a system zone is set to '0' for normal operation, which is the factory setting. Therefore the YYY number is 000 . To set a system zone for non-latching operating the respective zone bit must be set to '1' to give the required decimal number. For Example: If zones 1 and 4 are required to operate in a non-latching mode then the binary number will be 00001001, which is a decimal 9. Therefore the decimal number is 009 .
Bit number of the data byte	7	6	5	4	3	2	1	0	
Factory setting of the bits	0	0	0	0	0	0	0	0	
Decimal equivalent	128	64	32	16	8	4	2	1	

How to set the zone capacity of a control and repeat panel

How to:	Controls	Result	Factory defaults
How to set the zone capacity of the control and repeat panels.	Enter the AL4 4-digit code $\text{\textcircled{n}}\text{\textcircled{n}}\text{\textcircled{n}}\text{\textcircled{n}}$ then: Press $\text{\textcircled{A}}\text{\textcircled{9}}\text{\textcircled{0}}\text{\textcircled{0}}\text{\textcircled{0}}$ followed by location $\text{\textcircled{1}}\text{\textcircled{5}}\text{\textcircled{6}}$ and data ZZZ and $\text{\textcircled{A}}\text{\textcircled{0}}$. The zzz number can be selected from: 1 zone Control panel - 001 2 zone Control panel - 002 4 zone Control panel - 004 8 zone Control panel - 008 Repeat panel - 000	A 1,2,4 or 8 zone control panel data will be 001, 002, 004 or 008 respectively. The repeat panel data will always be 000	✓

User Responsibility

It is recommended that the **persons responsible** for the fire alarm system, should become familiar with the procedures on how to operate the controls and interpret indications given at the control and repeat panels. Adequate **training** should also have been given from appointed personnel.

Daily

The British Standard code of practice for *Fire detection and alarm systems for buildings, BS 5839:Part1:1988*, states that the system should be inspected daily to ensure that a normal indication is given at the control and indicating equipment and that any previously indicated **fault** condition has received appropriate attention.

- a) It recommends entry into the Log Book provided of all the system events for future reference.
- b) The person inspecting the protected premises can ensure that the use of the area(s) inspected has not changed such that the detection and alarm devices have become inappropriate.
- c) The area(s) can be inspected to check that no unsafe practices that could lead to fire are being undertaken.

Weekly

At Weekly intervals a different **Fire detector** or **Manual Call Point** of the system should be tested to ensure the system is capable of operating under alarm condition.

- a) The operation of the alarm sounders should be checked, which also provides a regular reminder to those occupying the premises that there is a fire alarm system with a particular characteristic sound.
- b) The test should be performed at a regular time to avoid confusion between a test and a genuine fire alarm.

Quarterly

At quarterly intervals the system should be inspected and any work necessary should be performed by trained maintenance engineer.

Battery Replacement

NOTE: Any servicing work on the System must be carried out by servicing organisation.

Under normal operating conditions the maintenance free **lead acid** batteries in the Control and Repeat panels can have a useful life of up to **5 years** from the date of manufacture.

NOTE: It is recommended that these batteries are replaced at 4 Yearly intervals from the date the System is first commissioned.

Testing a Manual Call Point

Push the test key through the hole in the underside of the call point to engage the test cam mechanism and push to operate the cam mechanism.

At this point the test key is retained in the call point and pulling it out will reset the glass.

NOTE: The alarm sounders in the system will be activated by this test. To **silence alarms and reset the system**, see **operating instructions**.

Replacing a broken Glass

WARNING: Take appropriate precautions when clearing broken glass to prevent injury.

NOTE: A weather resistant version of manual call points will have two gaskets, a Cover/glass gasket and a Spacer/cover gasket, which must be installed in their respective position.

These procedures assume the cover on the manual call point is open and any broken glass has been cleared.

- a) Feed the glass upward to push the cams down and fit under slider, locate bottom of glass into recess.
- b) Hold the bottom of glass in position and rotate the thumbwheel quadrant to raise the top of the glass.
- c) Fit the call point cover by hooking it into the top of the unit and making sure that the glass is properly seated (held down) tighten the cover fixing screw.

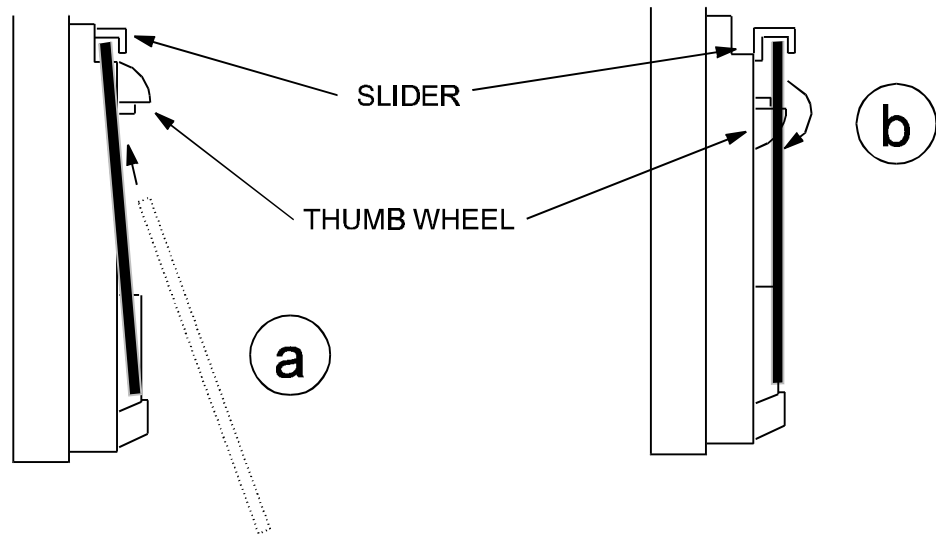
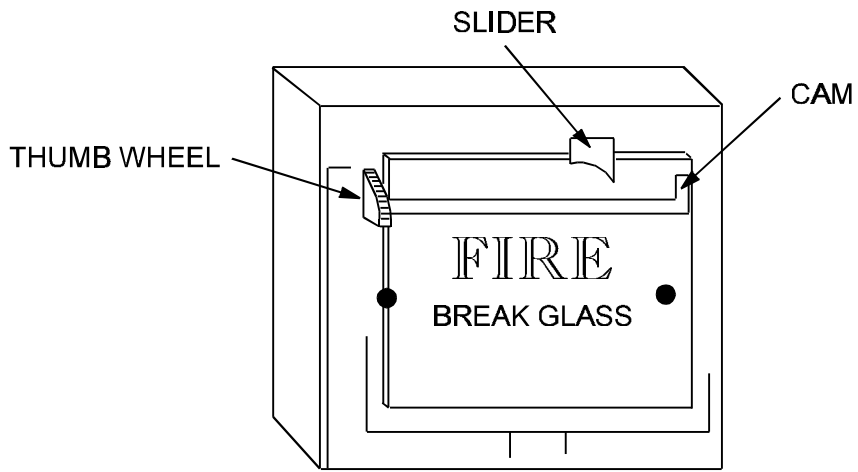



Figure 15 Replacing a broken MCP glass

emfl216

Fault indications

All fault repairs should be carried out by the servicing organisation.





In a fault condition:

- the common Fault  light is lit
- appropriate fault  light is also lit
- internal Fault Buzzer sounds intermittent tone
- Multiple faults are simultaneously annunciated when this does not cause confusion.

NOTE: Normally the fault lights will be automatically extinguished once the fault condition is rectified.

NOTE: If the system detects a fire during a fault condition the fault indicators may be extinguished.

How to silence the fault buzzer

Press the 3 digit code    if required and then press Cancel Buzzer .

Notice the buzzer is silenced but visual indications remain active.

NOTE: The sounder circuits are pulse monitored for failure. The monitoring signal is only applied to the circuits for a short duration at regular intervals.

Faults	Cause
What is a Zone fault?	A zone fault occurs when a zone circuit cable is open circuit or short circuit, or the end-of-line capacitor unit has been disconnected or a detector has been removed.
What is a Sounder fault?	A sounder fault occurs when a sounder circuit cable is open circuit or short circuit, or the end-of-line resistor unit has been disconnected.
What is a Mains power fault?	A mains failure occurs when the mains power supply to the panel is removed. This can occur on mains fuse failure or mains supply disconnection.
What is a Battery power fault?	A battery supply failure occurs when the battery supply to the panel has failed (due to aging process) or is disconnected or the battery fuse has failed.
What is an Earth fault?	An earth fault occurs when there is an electrical path for current flow from the system to earth connections.
What is a Repeat panel link fault?	A repeat panel link fault occurs when there is a communication failure between the control and repeat panels.
What is a System Fault?	A system fault occurs in the event the microprocessor failure.

Table 5 Types of faults

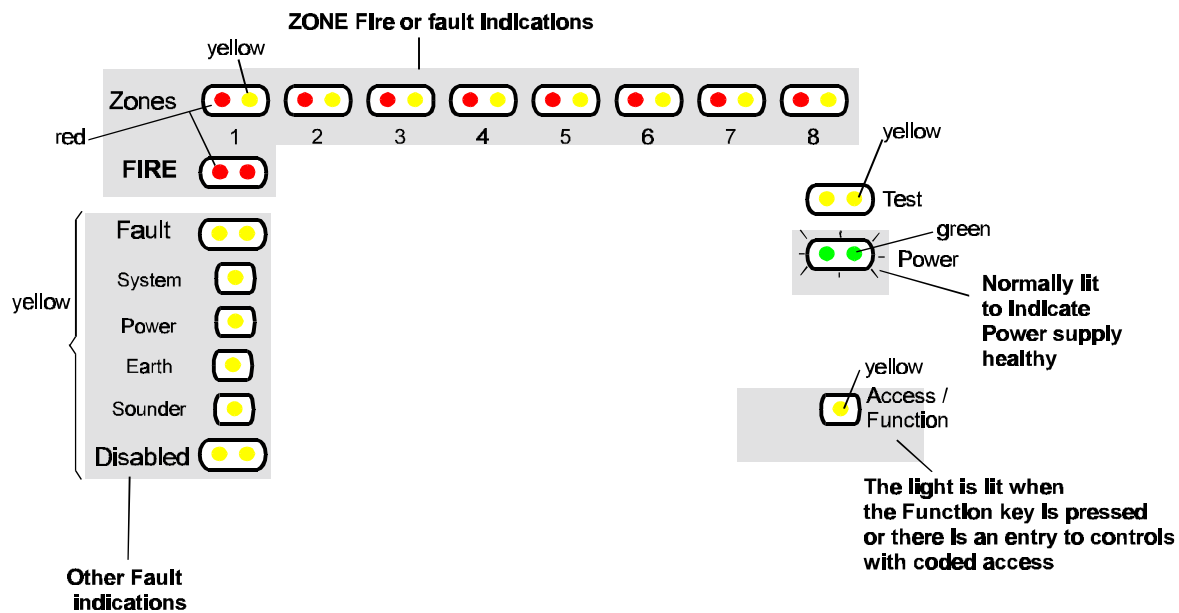

Figure 14 Fault indicators

cdm95

Indications	Visual										Audible		Signal out		Action to remove the indication		
	Zone Fire (1 to 8) - Red	FIRE (common) - Red	Zone Fault (1 to 8) - Yellow	Fault - Yellow	System - Yellow	Power - Yellow	Earth - Yellow	Sounder - Yellow	Disabled - Yellow	Test - Yellow	Power - Green①	Access / Function - Yellow	Buzzer	Sounder circuits		Auxiliary relay contacts Normally de-energised	Common Fault (normally active)
Conditions																	
Normal indication															norm	act	deact
Fire	On	On											On	On	C/O	act	act
New Fire (In another zone)	On*	On											On	On	C/O	act	act
Zone fault			Pul	Pul										Pul	norm	deact	deact
Sounder fault				Pul										Pul	norm	deact	deact
Mains power fault				Pul										Pul	norm	deact	deact
Battery power fault				Pul										Pul	norm	deact	deact
Earth fault				Pul										Pul	norm	deact	deact
Repeat panel link fault				Pul										Pul	norm	deact	deact
System fault (Software)				On	On~									Pul	norm	deact	deact
Disable Zone			On					On							norm	act	deact
Disable Sounder							On	On							norm	act	deact
Test A or B (Normal)			Pul+						On						norm	act	deact
Test A (fire)②	On		Pul						On						norm	act	deact
Test B (fire)③	On		Pul						On						norm	act	deact
Access level AL2,3 or 4															norm	act	deact
Function key press															norm	act	deact

On - Steady indication Pul - Slow pulsing indication Pul+ - Fast pulsing indication C/O - Contact change over
 norm - normal deact - deactivated act - activate ① Pulsing indication in the event of mains failure * - programmable to give a flashing indication
 ② Test A (fire) - automatic fire reset after 10 seconds ③ Test B (fire) - sound alarm for 2 seconds and system reset after 8 seconds ~ - pulsing at repeat panel

Operating instructions

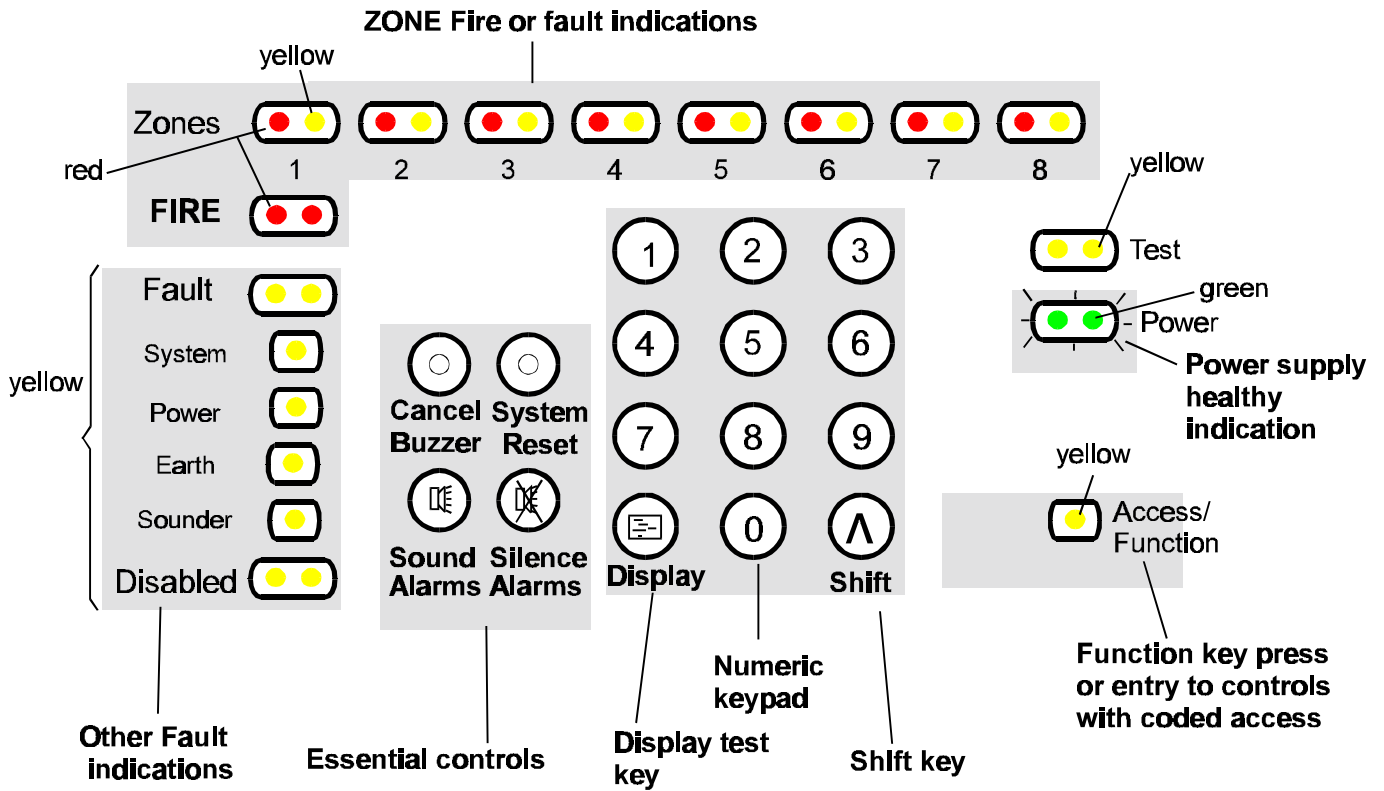

Figure 16 Controls and indications

cdm66

Normal indications



Under normal condition the panel should give a healthy indication,

with only the **green**  **Power light lit.**

The control panel provides system security by password entry to controls.



Fire Condition

In the event of an automatic fire detection the indications given are:

- FIRE  light is lit.
- Zones-fire  light is lit.
- buzzer sounds continuous tone.
- system alarm sounders are activated
- if applicable, auxiliary equipment is actuated
- if applicable, automatic link to the Fire Brigade is initiated.

After the emergency is over

After emergency is over silence the alarms and reset the system:





- a) Enter the **3 digit code**  to gain access to the controls.
- b) Press the **Silence Alarms**  button.

Notice the system alarm sounders are silenced and local buzzer sounds intermittent tone.

- b) After the cause of the alarm has been investigated, ensure smoke and excess heat have had time to clear from automatic detectors and broken manual call point glasses have been replaced where necessary. Press the **System Reset**  button. Notice the indications return to their pre fire status.





To Sound Alarms

To re-sound the alarm sounders during a fire condition:





- a) Enter the **3 digit code**    to gain access to the controls.
- b) Press the **Sound Alarms**  button.
Notice the system alarm Sounders are activated.

To Silence Alarms

To silence system alarm sounders after they have been actuated:

- a) Enter the **3 digit code**    to gain access to the controls.
- b) Press the **Silence Alarms**  button.
Notice the system alarm Sounders are silenced.

To carry out a lamp test





- a) Enter the **3 digit code**    to gain access to the controls.
- b) Press the 'shift'  button and then the **display**  button.
Notice the all indicators are lit and the buzzer sounds continuous for 12 seconds.

Fault Condition

In the event of an automatic fault detection the indications given are:

- Fault light is lit
- fault indicators are lit (except for system fault which is a continuous sound)
- buzzer sounds intermittent.

To Cancel fault buzzer

- a) Enter the **3 digit code**    to gain access to the controls.
- b) After investigating fault, press the **Buzzer**  button. Notice the buzzer is silenced but other indications remain active.

The fault indications are normally automatically extinguished once the fault condition has been rectified.

Action to rectify fault

Suggested action to rectify fault condition:

NOTE: All fault rectification work must be done by the servicing organisation.

The fault indicators may be extinguished during a fire condition.

See commissioning section. The mains failure condition overrides all other fault indications in order to preserve battery standby capacity.

Parts list

Xenex Panels

Part number	Description
XEN1	1 Zone control panel
XEN2	2 Zone control panel
XEN4	4 Zone control panel
XEN8	8 Zone control panel
XENRPT	Repeat panel

Fire Detectors

Part number	Description
17640-01	Optical smoke
17630-01	Ionisation smoke
17650-01	Fixed temperature heat
17660-01	Rate of rise heat
17670-01	High temperature heat
17601-01	Base (BS5839:Part1)
17615-01	Duct detector
07011-31	Beam detector

NOTE: *The beam detector should be powered from an independent power supply.*

Manual call points (MCP)

Part number	Description
14112-08	Manual call point (surface)Red 470R
14112-45	Manual call point (surface)Red 470R c/w cover
14112-08	Manual call point flush (red) 470R
14112-58	Manual call point flush (red) 470R c/w cover
14112-19	MCP Surface water resistant kit
14112-09	Pack of 10 glasses
14115-08	Keyswitch (red) surface 470R

14115-18 Keyswitch
(red) flush 470R

24Vdc Sound signals

Part number	Description
12511-37	Electronic sounder (red)
12511-52	Electronic sounder (grey)
12511-19	Water resistant kit for 2511 sounders
12143-04	Electronic bell (red) IP55
12141-54	Electronic bell (Grey)
02601-31	Sounder 6-28V
02300-01	Xenon flasher (red) - 125mA
02300-01	Xenon beacon (red) - 45mA

24Vdc Ancilliary

Part number	Description
04390-31	Magnetic Door holder - 22mA
04390-92	Door holder floor plate
04390-99	Door bracket

NOTE: *The door holders should be powered from an independent power supply.*

Accessories

Part number	Description
4015-502	12V 2.1Ah battery (2-off required for 1 & 2 zone panel plus repeat panel)
4015-509	12V 2.8Ah battery (2-off required for 4 & 8 zone panel)
2534-142	Spares pack for XEN1
2534-143	Spares pack for XEN2
2534-144	Spares pack for XEN4
2534-145	Spares pack for XEN8
2534-146	Spares pack - XENRPT

This page has been intentionally left blank.

Log Book

SITE ADDRESS

A Log of system events MUST be kept by the responsible persons on site and must be available at all times together with the system access codes.

GENT Contract No. _____

Site ID: _____

For Service

Normal Hours Mon-Fri _____

Tel. _____

Outside Normal Hours _____

Tel. _____

Manned Centre Telephone _____

Manned Centre Code No. _____

Responsible Persons on SITE: _____

To comply with the requirements of *BS5839 : Part 1 : 1988* and to allow those concerned with the fire detection and alarm systems to monitor the long term performance of the system, it is important that a log is kept which includes all the events relating to the performance of the system.

AL2 password	AL3 password

For each zone record the location description.

Zone number	Description of the zonal location
Zone 1	
Zone 2	
Zone 3	
Zone 4	
Zone 5	
Zone 6	
Zone 7	
Zone 8	

System configuration record

This information will assist the servicing organisation to keep a record of how the system is configured.

Mark in the table below any deviation(s) from the standard factory settings.

Detection and zone circuit configuration

Zone number	1	2	3	8	5	6	7	8
Normal zone operation (<i>factory setting</i>)								
Non latching zone operation								
First fire to be a pulsing indication (<i>factory setting</i>)						Detection band A (<i>factory setting</i>)		
First fire to be a steady indication						Detection Band B		
						Detection Band C		
Zone short circuit to give a fault (<i>factory setting</i>)								
Zone short circuit to give a fire								

Sounders and system reset configuration

Silence alarms and reset to operate independently (<i>factory setting</i>)		
Silence alarms and reset to operate as per BS5839: Part 4		
Reset to also action the silence alarms		
Sound alarms to operate in fire condition only (<i>factory setting</i>)		
Sound alarms to operate at any time		
Auxiliary relay to energise with fire (<i>factory setting</i>)		
Auxiliary relay to energise with sound alarms		

Access level

Access levels	AL1	AL2	AL3
Cancel buzzer (AL1 - factory setting)			N/A
Test A & B mode, Cancel Test (AL2 - factory setting)	N/A		
Display test (AL1 - factory setting)			N/A

Repeat panel information

Repeat panel	EEPROM location	EEPROM Data (address)	Name of the area where the panel is installed on site
1st Repeat panel			
2nd Repeat panel			
3rd Repeat panel			
4th Repeat panel			
5th Repeat panel			
6th Repeat panel			

GENT SALES & SERVICE CENTRES**Head Office**

Waterside Road
Hamilton Industrial Park
Leicester, LE5 1TN
Telex: 342367
Fax: 0116 246 2300
Tel: 0116 246 2000

International division

Waterside Road, Hamilton Ind.
Park, Leicester, LE5 1TN, UK
Telephone: (44) 116 246 2200
Fax: (44) 116 246 2018
Telex: 342367 GENT G

South East

Telephone: 0181 300 7784
Fax: 0181 302 7739

South West

Telephone: 0117 961 8340
Fax: 0117 961 8292

Midlands

Telephone: 0116 246 2400
Telex:342367 Fax: 0116 246 2017

North

Telephone: 01204 531155
Fax: 01204 531177

Scotland

Telephone: 0141 429 5446
Fax: 0141 420 1731

Northern Ireland

Taylor
The Mount
2 Woodstock Link
Belfast
BT6 8DD
Telephone: 01232 730 150
Fax: 01232 730 199

GENT 1,2,4 and 8 Zone Model 3260 Fire Alarm Control Panel

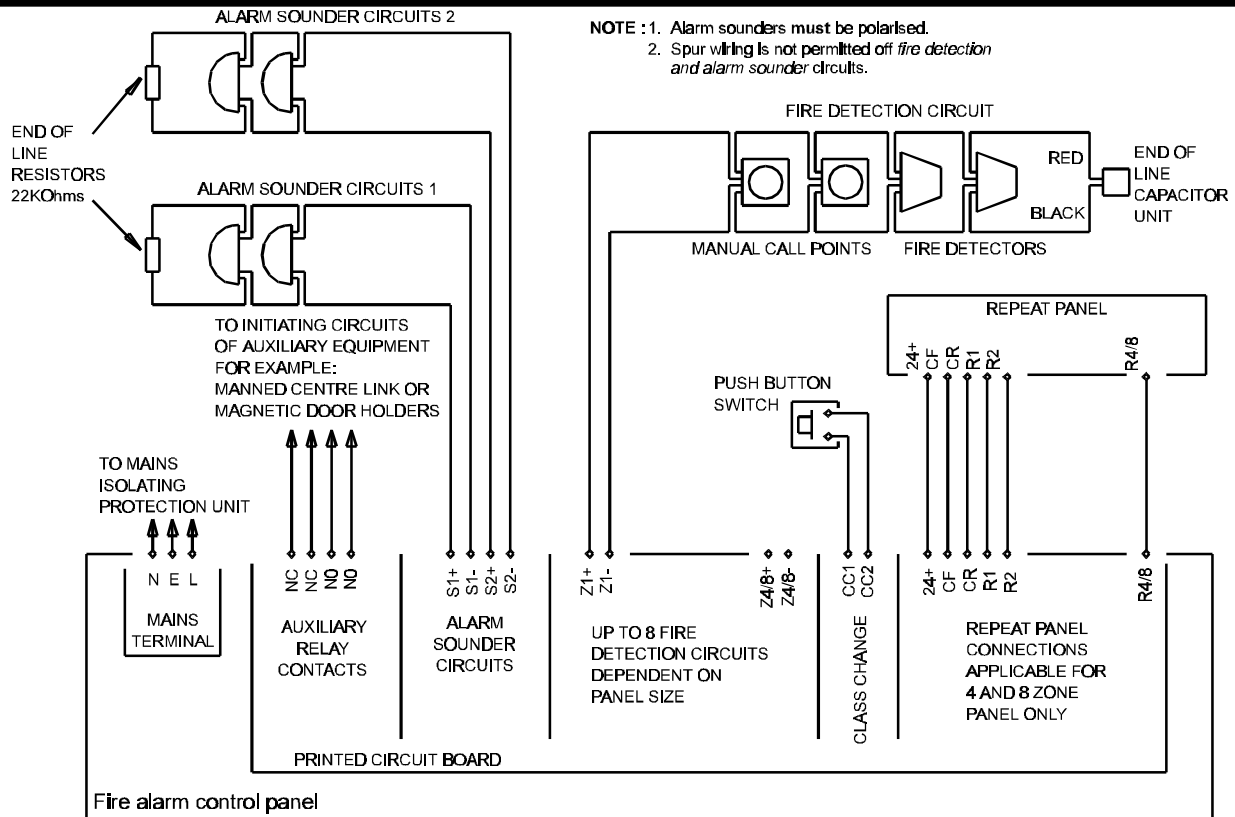

Figure 1 Typical Fire Detection & Alarm System Schematic

CDM26

Also refer to the Electromagnetic Compatibility (EMC) and Low voltage directive (LVD) leaflet.

1 Introduction

The fire alarm control panel has been designed to comply with the requirements of BS 5839:Part 4:1988 for use in systems complying with the requirements of BS 5839:Part 1:1988 which are the British Standards for fire detection and alarm systems in buildings. These instructions should provide sufficient information to install the product and then check the performance of the installed system. It is however important that those responsible for the design, installation and commissioning of the system should have a good working knowledge of the requirements of installed systems, particularly BS 5839:Part 1:1988 Code of Practice for system design installation and servicing.

2 Fire Detection and Alarm System Design

The following design information is intended to provide guidance on aspects of system design, specifically related to the use of the control panel. Before designing any fire alarm system, reference should be made to the BS 5839 Part 1:1988 which is the Code normally applicable in the U.K., but this may be supplemented by additional requirements to suit individual user needs.

2.1 Mains Supply Connection

The mains supply to the Control Panel should be a 230Vac +10% -6% 50Hz single phase. Its connection to the panel should be made via a 3A (5A for 8 Zone Panel) fused spur unit reserved solely to feed the Control Panel.

2.2 Standby Supply

The Control Panel will provide a standby supply, under mains failure conditions, for a period of 72 hours followed by 30 minutes of full alarm load, with an average detector load of 1mA per zone and a total sounder load of 1A.

2.3 Fire Detection Circuits (Zone Circuits)

The control panel include fire detection circuits, also referred to as zone circuits, for the connection of fire detectors and manual call points. It is important to ensure that the detectors and call points used are compatible with the control panel. Only the recommended devices should be used. **It is important that all call points are fitted with a 470 ohms series resistor.** Failure to follow this recommendation may lead to inferior performance of the system.

Note: The maximum line loop resistance of a fire detection circuit should not exceed 100 Ohms.

The recommended devices for fire detection circuit are:

- GENT 7630 Ionisation smoke detector
- GENT 7640 Optical smoke detector
- GENT 7650 Fixed temperature heat detector
- GENT 7660 Rate of rise heat detector
- GENT 7670 High temperature heat detector
- GENT 7610 Duct detector 24Vd.c.
- GENT 1195-OR Manual call point
- GENT 7011 Beam detector (only one per zone allowed. Plus a separate power supply is required).

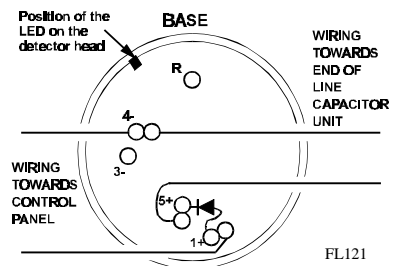

Figure 2

To permit the removal of a plug-in fire detector to be annunciated as an open-circuit fault but prevent subsequent detectors or call points from being disconnected, each fire detector base should be wired with a diode.

2.4 Monitoring Fire Detection Circuits

Effective monitoring of the fire detection circuits relies on the end-of-line capacitor unit being present. A capacitor unit must be fitted after the last detector or manual call point on a fire detection circuit, see Figure 1. As the end-of-line capacitor unit is connected to prevent a fault condition being annunciated any fire detection circuits not being used should be terminated in, or adjacent to, the control panel with an end-of-line capacitor unit.

Notice: A fire detection circuit wiring must be one continuous circuit with no spur circuits being permitted.

Notice: The use of capacitor(s) and an associated monitoring circuit is the subject of British Patent 2101784. Foreign filing has also been undertaken.

2.5 Alarm Sounder Circuits

To comply with the requirements of BS 5839: Part 1:1988, it is important that both alarm sounder circuits are used on all installations. Each alarm sounder circuit for the 1,2 and 4 zone control panel is rated at 24V 750mA, with a maximum alarm sounder current of 1 A distributed between the two alarm sounder circuits. The 8 zone control panel has each alarm sounder circuit rated at 24V 1.5A, with a maximum alarm sounder current of 2A distributed between the two alarm sounder circuits.

The recommended devices for use are:

- GENT 2511 Electronic Sounder 24Vdc.
- GENT 2141 Electronic Bell

2.6 Monitoring of Alarm Sounder Circuits

Each alarm sounder circuit is monitored for both short and open circuit wiring fault. This requires that the remote end of each alarm sounder circuit is fitted with a 22K Ohm end-of-line resistor. An alarm sounder circuit wiring must be one continuous circuit with no spur circuits being permitted. Also to allow the monitoring function to operate effectively, it is important that all sounders include a series blocking diode that will only allow current to flow through the sounders when the supply is polarised in accordance with the terminal markings on the control panel printed circuit board. For monitoring purposes, each alarm sounder circuit is fed with a reversed polarity supply which only permits current to flow through the end-of-line resistor.

2.7 Class Change Circuit

A pair of unmonitored terminals are provided to permit the system alarm sounders to be actuated from a remote position. It is considered that the major use for these will be for class change functions in schools and colleges. The wiring connecting these terminals to the normally open initiating contacts is not monitored for an open circuit fault. Cable length is 100m maximum.

2.8 Auxiliary Relay Contacts

A set of normally open contacts and an isolated set of normally closed contacts have been provided for triggering auxiliary circuits. These contacts are rated at 24V d.c. 1A for a resistive load. These contacts should not be used to switch voltages in excess of extra low voltage of 50V. Any auxiliary circuits should be powered from an independent power supply and should not use the power of the control panel as this may have a detrimental affect on battery standby capability of the control panel. **For the 1 and 2 zone control panel, these contacts operate with system alarm sounders , whereas for the 4 and 8 zone panel the contacts operate with only the fire condition.**

2.9 Repeat Panel Connections (Applicable for 4 & 8 Zone Control Panels Only)

The control panel include terminals for the connection of a repeat panel to permit duplicate common fire and fault, together with associated fire zone indications. The 24V positive supply connection to the repeat panel is protected by a 1A fuse on the printed circuit board in the control panel. The power supply is not intended to be a source of power for other ancillary devices.

3 Installation Instructions

It is recommended that the installation be delayed until all building work has been completed in the vicinity of the control panel position. This will prevent the possibility of dirt degrading the performance or appearance of the control panel.

a) Remove control panel from its packing but retain the carton for storage of spare parts and loose items.

b) Open control panel front cover using the key provided and if necessary remove door by extracting the hinge fixing.

c) Remove the inner cover of the control panel by removing its fasteners.

d) Check the spares parts supplied with those listed in Table 1. If replacement parts are required at any time, only spares that are of the same specification should be used.

e) Remove the appropriate knock-outs on the control panel case for cable entry. The 4 or 8 zone control panel case has knockouts provided to allow rear cable entry.

f) Hold the control panel on the wall in the desired mounting position and mark the positions of the fixing holes. See Figure 3 for case fixing details.

g) Secure the control panel to the wall using suitable fixing such that adequate support is provided to the control panel assembly. A top centre keyhole fixing is provided on the case to allow the panel to be hooked whilst the bottom two fixing points are located.

	Control Panel Sizes			
	1 Zone	2 Zone	4 Zone	8 Zone
Main Panel assembly	1	1	1	1
Batteries 12V	2	2	2	2
Instructions log book & Card	1	1	1	1
Keys(Pack of 2)	1	1	1	1
End-of-line Resistor 22k	2	2	2	2
End-of-line Capacitor Unit	1	2	4	8
End-of-line Label	3	4	6	10
Shorting Link	1	1	1	1
Fuse 800mA (Quick blow type)	1	1	1	-
Fuse 2A(Quick blow type)	-	-	-	1
Fuse 2.5A(Quick blow type)	1	1	-	-
Fuse 3.15A (Quick blow type)	1	1	1	1
Fuse 5A (Quick blow type)	-	-	1	1
Zone designation label	-	1	1	1
Battery wire link	1	1	1	1
Battery support bracket	1	1	2	2

Table 1 Part List

h) Terminate the cables into the appropriate terminal blocks on the printed circuit board.

Note: Each customer terminal on the printed circuit board would accept a maximum conductor size of 2.5mm square.

i) If it is not intended that the system be commissioned at this stage, the inner cover and the front cover should be refitted and the system left without power.

j) Store spare parts and loose components including the batteries inside the control panel carton and keep in a safe place until required.

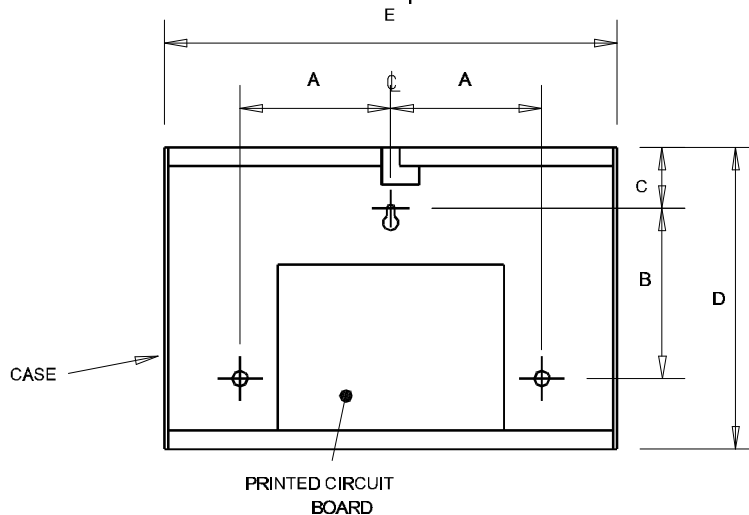

	A	B	C	D	E	DEPTH
1 & 2 ZONE PANEL	100	150	40	250	330	80
4 & 8 ZONE PANEL	150	100	55	250	500	80

DIMENSIONS IN mm

FL123

Figure 3 Case Fixing Details

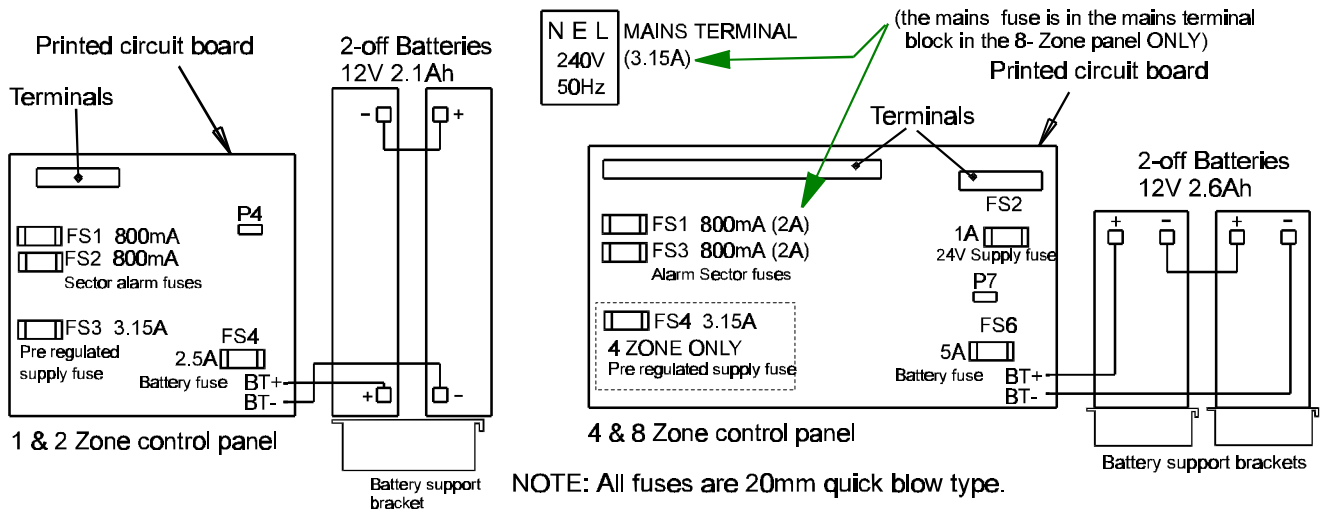

Figure 4 Fuses and Battery Connections

cdm27

4 One Man Commissioning and Test

The total system should be tested in accordance with the commissioning requirements of *BS5839:Part 1:1988* or other standard specified by the system purchaser.

a) When the system is to be commissioned, the batteries should be connected as shown in *Figure 4* and the mains power supply connected. Ensure the batteries are placed on the support(s) provided and securely fixed to the back of the case by using the sticky backed pads.

b) With the power supplied, the control panel should now be operational and the green power on lamp should be illuminated.

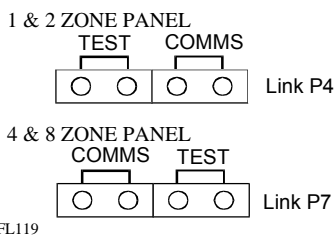

Figure 4 Commissioning and Test Mode Link Configurations

c) To facilitate commissioning and testing of this control panel, by one man servicing, a four way connector has been included on the printed circuit board designated P4 for the 1 and 2 zone control panels, and P7 for the 4 and 8 zone control panels. A small black shorting link is supplied to enable the control panel into either commissioning or test mode.

Test mode

To enable the control panel into the test mode, fit the shorting link across the two pins of connector P4 or P7 as shown in *Figure 5*. The fire detection circuit(s) will then appear disabled. However, in this mode any detector operated will be reset, automatically, after approximately seven seconds, without giving any indication on the control panel or starting the alarm sounders.

Commissioning mode

To enable the control panel into the Commissioning mode, fit the shorting link across the two pins of connector P4 or P7 as shown in *Figure 5*. The fire detection circuit(s) will then appear disabled. However, in this mode any detector or manual call point made active will cause system alarm sounders to signal for two seconds and subsequently a panel reset is performed automatically after approximately seven seconds.

d) After each zone circuit has been commissioned or tested it can be enabled separately to operate as normal, see section 5.5.

Important: The shorting link MUST BE REMOVED from connector P4 or P7 to restore the control panel to the normal mode.

e) Write zone identification name onto the zone designation label, if provided, such that the name is adjacent to the respective zone Fire and Fault lamps on the inner cover of the control panel.

f) The label backing should then be peeled off and label stuck onto the inner cover to allow appropriate zone indicator lamps to appear through cutout of the label.

g) Arrangements should now be made to the ongoing maintenance of the installation as required by *BS5839:Part 1:1988*. GENT will provide a quotation for this service upon request.

Note: The batteries supplied with this panel have a self-discharging characteristic during storage. If any panels are put into service after the Battery Storage Expiry Date and when powered up a "Battery Fault" condition is initiated, please contact the Stockist Representative or Internal Sales Engineer at your local GENT office.

Under normal operating conditions the batteries can have a useful life of up to 5 Years from the date of their manufacture. The REPLACE BY DATE shown on the battery label is calculated at 4 Years from manufacture and it is strongly recommended that the batteries are changed by this date.

5 Operating Instructions

The control panel provides system security by virtue of the lockable door and provides clear indication of the indicator lamps and easily readable instructions for the system operator.

The automatic functions of the control panel, includes the annunciation of fire and fault conditions of the fire detection and alarm system, without the need to operate any of the push buttons control. Silencing of alarm sounders and the fault buzzer, re-sounding of the alarm sounders and the operation of the test functions do require the operation of push buttons and these are protected against unauthorised actuation by the lockable hinged front cover of the control panel. Once this cover is lowered, all push buttons are exposed, as are the basic instructions required by the operator.

5.1 Fire Condition

- Common fire lamps are on
- Appropriate zone fire lamps are on, if applicable
- Internal fire buzzer is actuated
- System alarm sounders are actuated
- Any auxiliary equipment is actuated
- Any automatic link to the Fire Brigade is initiated

Suggested action to silence alarms and reset the system:

a) Press SILENCE ALARMS push after emergency is over. Notice the system alarm Sounders are silenced and internal fire buzzer changes to fault/supervisory buzzer output. All other fire condition status remain active.

b) Press RESET push after the cause of the alarm has been investigated, ensure smoke and excess heat have had time to clear

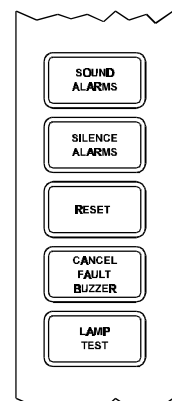

Figure 5 Push Button Controls

from automatic detectors and broken manual call point glasses have been replaced where necessary. All the control panel indications and outputs will return to their normal condition.

5.2 To Sound Alarms

If it is necessary to actuate the alarm sounders when there is no fire indicated, or to re-sound the alarm sounders after they have been cancelled during a fire condition, for this the SOUND ALARMS push should be pressed. The alarm sounders are then cancelled by pressing the SILENCE ALARMS push.

5.3 Fault Condition

- Common fault lamp is on
- Appropriate fault indicators are on
- Internal Fault/Supervisory Buzzer is actuated

Suggested action to rectify fault condition:

Press CANCEL FAULT BUZZER push after investigating fault. Notice the buzzer is silenced but other indications remain active.

The fault lamps will be automatically extinguished once the fault condition is rectified. If the system detects a fire during a fault condition the fault indicators may be extinguished. Details of the indications relating to specific fault conditions are shown in Table 2. Multiple faults are simultaneously annunciated when this does not cause confusion. However, a mains failure condition overrides all other fault indications in order to preserve battery standby capacity.

5.4 To Test Lamps and Buzzer

Press LAMP TEST push. All lamps should be illuminated and the Fault/Supervisory Buzzer should sound for a period of approximately 2 seconds.

5.5 To Disable or Enable a Fire Detection Zone (Available with 4 or 8 zone control panel only)

This function may be used for system maintenance purpose or for the prevention of inadvertent alarms while there is general maintenance or building work being undertaken in areas protected by automatic fire detectors.

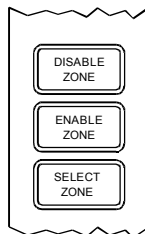

FL118

Figure 7 Zone Disable/Enable Controls

Zone Disable

a) Press SELECT ZONE push. This will cause one of the amber zone fault indicator lamps to be on steady. Repeatedly press the push until the new zone lamp associated with the zone to be disabled is on steady.

b) Press the DISABLE ZONE push until the steady indication disappears.

For any disabled zone(s) the indicator will pulse and the zone disabled warning lamp will be on. Also the fault/supervisory buzzer will be on and will not cancel until all zones are re-enabled.

Zone Enable

a) Press the RESET push.

b) Press the SELECT ZONE push until the appropriate zone indicator lamp is on steady.

c) Press the ENABLE ZONE push and the zone will be enabled. Repeatedly press the SELECT ZONE push until the steady indication disappears.

6 Routine Testing

Daily

The British Standard Code of Practice for Fire Detection and Alarm Systems for buildings, BS 5839:Part 1:1988, states that the system should be inspected daily to ensure that it is indicating a normal condition and that any previously indicated Fault and Warning condition has received appropriate attention. It recommends entry into the log book provided of all system events for future reference.

Weekly

At weekly intervals a different fire detector or manual call point of the system should be tested. The test should be performed at regular time to avoid confusion between a test and a genuine alarm. This would also provide a regular reminder to those occupying the premises that there is a fire alarm system with a particular characteristic sound.

Quarterly

At quarterly intervals the system should be inspected and any work necessary should be performed by a trained engineer responsible for the system.

6.1 Log Book

To comply with the requirements of BS 5839:Part 1:1988 and to allow those concerned with the fire detection and alarm systems to monitor the long term performance of the system, it is important that a log is kept which includes all the events relating to the performance of the system.

Com. Fire red	Com. Fault amber	Zone Fire red	Zone Fault amber	Visual Indications Sounder /Earth Fault amber	Processor Fault amber	Power ON green	Warning Zone Disabled amber	Audible Indication Buzzer sound	CONDITION ANNUNCIATED	PROBABLE CAUSES
-	-	-	-	-	-	ON	-	-	Normal Condition	System is operating correctly
ON	-	ON/PULSE	-	-	-	ON	-	ON	Fire Condition	An automatic fire detector or call point has operated
-	-	-	ON&PULSE	-	-	ON	ON	ON	Disabled Zone	Fire detection circuit has been disabled by Engineer to prevent inadvertent alarms.
-	ON	-	ON	-	-	ON	-	ON	Zone Circuit Fault	A fire detector has been removed or detection circuit wiring has open or short circuited.
-	ON	-	-	ON	-	ON	-	ON	Alarm Sounder Circuit Fault	An alarm sounder circuit wiring has open or short circuited or its protection fuse has ruptured.
-	ON	-	-	ON&PULSE	-	ON	-	ON	Earth Fault	A part of the system has an electrical leakage path to earth.
-	ON&PULSE	-	-	-	-	ON	-	ON&PULSE	Battery Disconnection	The battery or its wiring has failed, or its protection fuse has ruptured.
-	ON&PULSE	-	-	-	-	-	-	ON&PULSE	Mains Supply or Charger Fault	The Mains Supply to the panel is faulty or the Regulated Supply Fuse has ruptured or the Battery Charger has failed.
-	ON&PULSE	-	-	-	-	ON	-	ON&PULSE	High Supply Fault	Regulated Supply voltage is incorrect.
-	-	-	-	-	ON	ON	-	ON	Processor Failure	The panels micro-computer has malfunctioned.

(ON&PULSE)=ON AND PULSING (ON/PULSE)=ON OR PULSING-if it is a recently activated zone.

Note:The visual indications of zone fire and zone fault are not applicable to the 1 zone control panel.

The zone disable warning indications are only applicable to the 4 and 8 zone control panels .

Table 2 Fault chart

Fire/Fault Interface Unit (for 3260 4/8 Zone Control Panel)

1. INTRODUCTION

This leaflet provides sufficient information to install the 3260 Fire/Fault Interface Unit, code 13260-41, and connect it to a **3260 (4/8 Zone) Control Panel**. This Interface Unit is intended to allow a 3260 Control Panel to link with another fire detection system.

Function	4/8 Zone
24V Supply	24+
0V Supply	Z-(any)
Fire Signal	CR
Fault Signal	CF
Sounders	CC1
Sounders	CC2

Table 1 3260 Connection Points

2. INSTALLATION

Mount the Unit using the four holes located at each corner of the container.

Place the unit in the desired position and mark the four fixing holes onto the surface to which the unit is to be mounted.

Drill the four fixing holes and mount the unit on the surface with suitable fixings such that adequate support is provided.

Terminate the cable at entry points and connect the ends into the appropriate terminals on the printed circuit board, see Figure 1.

CAUTION: Failure to make the connections correctly can result in damage to the unit.

CAUTION: It is important NOT to undertake insulation tests of wiring with the wires connected into their intended terminals. **THE ELECTRONIC COMPONENTS MAY BE SERIOUSLY DAMAGED.**

PCB Connection details

The 4/8 Zone Panels have terminals provided for a repeat indicator and these are used for making connections to the Interface board, see Figure 1 and Table 1.

External connections can be altered by changing the links:

For signalling fire and fault to a zone of 3250,3260 or 3440 fit X1, X4 (EOL Cap unit is already fitted to Interface PCB).

For Signalling fire and fault to zone of 3228/3280 fit X2,X3,X4 (EOL 2K2 resistor is already fitted to Interface PCB).

For Separate SPCO contacts for fire and fault fit X3 only.

Note - The on board alarm relay for connection to a remote sounder circuit is polarised and suppressed. If it is used at the end of a monitored circuit a suitable monitoring component must be added across the AS+, AS- terminals.

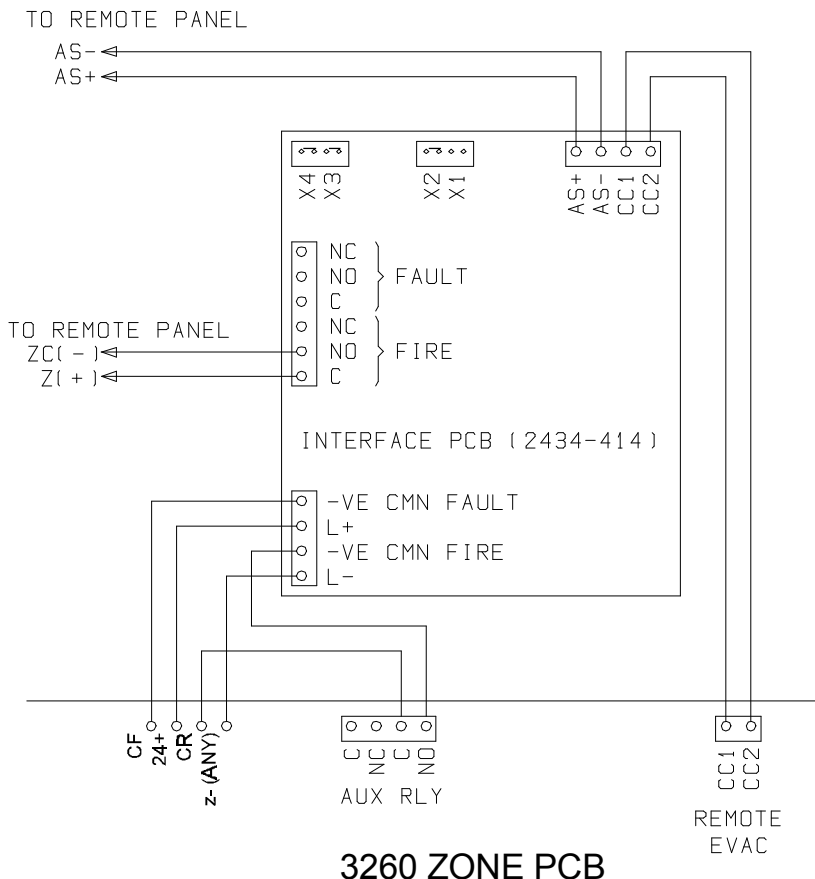

Figure 1 Wiring Diagram

Zonal Fire/Fault Interface Unit (for 3260 4/8 Zone Panel)

1. INTRODUCTION

This leaflet provides sufficient information to install the 3260 Interface Unit and connections to a 3260 (4/8 zone) Control Panel. These Interface Units are intended to allow 3260 (4/8 zone) Control Panel to provide zonal fire contacts and a common fault signal to other equipment such as multiplexers or data collection systems.

13260-38 - 8 way Fire/Fault Interface PCB.

2. INSTALLATION

Mount the Unit using the four holes located at each corner of the container.

Place the unit in the desired position and mark the four fixing holes onto the surface to which the unit is to be mounted.

Drill the four fixing holes and mount the unit on the surface with suitable fixings such that adequate support is provided.

Terminate the cable at entry points and connect the ends into the appropriate terminals on the printed circuit board. See Figure 1.

CAUTION: Failure to make the connections correctly can result in damage to the unit.

CAUTION: It is important NOT to undertake insulation tests of wiring with the wires connected into their intended terminals. THE ELECTRONIC COMPONENTS MAY BE SERIOUSLY DAMAGED.

4/8 Zone 3260 Panels

These panels have terminals provided for a repeat indicator and these are used for making connections to the Interface Unit, see Table 1 and Figure 1.

External Connections

The Interface Unit PCB has three links, for most applications all three are removed.

Fitting LK1 - Connects contact common with the positive supply.

Fitting LK2 - Connects contact common with the negative supply.

Fitting LK3 - Connects the sounder control relay coil to the common terminal. (Relay operated by supply between B and Common).

CAUTION: LK1 and LK2 should NEVER be fitted at the same time.

Function	4/8 Zone
24V+ Supply	24+
0V Supply	z-(any)
Common Fire	CR
Zone 1 Fire	R1
Zone 2 Fire	R2
Zone 3 Fire	R3
Zone 4 Fire	R4
Zone 5 Fire	R5
Zone 6 Fire	R6
Zone 7 Fire	R7
Zone 8 Fire	R8
Fault	CF
Sounders	CC1
Sounders	CC2

Table 1 3260 Connection Points

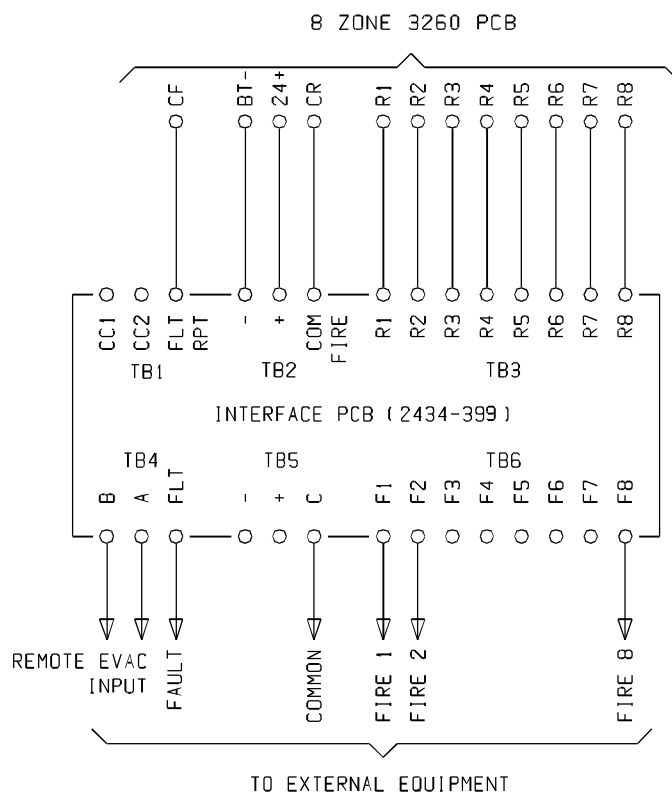

Figure 1 Connections for 8 Way Unit

f1158