

Metalliferous Mining - Processing

Crushing

Resource Book

Table of Contents

TABLE OF CONTENTS	2
INTRODUCTION TO CRUSHING.....	3
<i>What is this module about?</i>	3
<i>What will you learn in this module?</i>	3
<i>What do you have to do to complete this unit?</i>	3
<i>What resources can you use to help?</i>	3
INTRODUCTION TO COMMINUTION	4
CRUSHING THEORY	5
CRUSHING EQUIPMENT AND CRUSHING CIRCUITS	9
CRUSHING EQUIPMENT	9
CRUSHING CIRCUITS AND STAGING.....	23
SDGM CRUSHING CIRCUIT OVERVIEW	26
SDGM CRUSHING CIRCUIT MAJOR COMPONENTS	28
CONTROL & OPERATING PHILOSOPHY	38
APPENDIX 1 EQUIPMENT LIST & NUMBERING	ERROR! BOOKMARK NOT DEFINED.

Introduction to Crushing

What is this module about?

This unit is about how we manage crushing within the processing plant

What will you learn in this module?

- Demonstrate an understanding of crushing theory fundamentals.
- Define comminution
- Define Work Index
- Explain what Specific Energy input is.
- List the 3 mechanisms for fracturing rock
- Demonstrate an understanding of the equipment used
- Identify the main components of a jaw crusher
- Identify the main components of cone crusher

What do you have to do to complete this unit?

You will need to complete all the training tasks in your workbook, the review exercise and the assessment given to you by your supervisor.

Discuss the competency standards for this unit with the Training Coordinator or your supervisor.

What resources can you use to help?

If you need more information about topics in this unit, then you should approach:

- Your work mates and supervisor
- The training coordinator
- Metallurgists

Introduction to Comminution

Because most minerals are finely disseminated and intimately associated with the gangue, they must be initially "unlocked" or "liberated" before separation can be undertaken. This is achieved by comminution.

Comminution is the term applied to the process by which the particle size of an ore stream is progressively reduced progressively reduced. It is the first step in processing the ore from the mine. The purpose of comminution is to;

- Liberate the valuable mineral from the worthless 'gangue' material prior to concentration or separation.
- Increase the surface area of valuable mineral available for chemical reaction.

Blasting in the pit can be considered the first stage of comminution. Explosives are used in the mining operation to remove the ore from the ground and make it easier to be handled by the excavators, scrapers, trucks, loaders etc.

Comminution in the processing plant takes place as a sequence of crushing and grinding processes.

Crushing reduces the particle size of run-of-mine (ROM) ore to such a level that grinding can be carried out until the valuable mineral (gold and silver, and gold/silver bearing minerals) and gangue are substantially produced as separate particles.

Crushing is accomplished by compression of the ore against a rigid surface, whereas grinding involves abrasion and impact of the ore by the grinding media (steel mill balls).

Crushing Theory

The purpose of crushing is to prepare the ore for further processing. The ultimate aim is to produce a certain amount of material of a certain size per day so that the grinding circuit has sufficient feed.

Work Index

Crushing theory is concerned with the relationship between the amount of energy put into a rock or particle of a known size and the reduced particle size after the comminution process has taken place. The amount of energy required to do this work is referred to as the 'Work Index' and it is an expression of the resistance that a material has to crushing (or grinding). It is a measurement of how hard the ore is.

Therefore 'Work Index' can be defined as:

The amount of energy (work) required to break a rock from one size to another.

Each rock has a characteristic Work Index. For example, more energy is required to break quartz than sandstone so quartz will have a higher work index.

Numerically the work index is known as the kilowatt-hours per tonne or kWh/t. A kilowatt-hour is the number of kilowatts consumed in an hour. For example, if you ran a 20kW motor for an hour, you would expend 20kWh. If you used that motor to do work to 2 tonnes of rock you would have used $20\text{kWh} \div 2 \text{ tonne}$, 10kWh/t.

The higher the Work Index, the more work required to break the rock, hence the harder the rock.

Crushing or Impact Work Indices are measured in the laboratory using a special impact strength-testing machine. Some typical values for crushing work indices are listed below:

<u>Material</u>	<u>Crushing Work Index</u>
Basalt	22
Clay	8
Coal	13
Copper Ores	14
Gold Ores	16
Glass	3
Iron Ores	17
Limestone	13
Quartz	14

If the work index of the ore is known and the feed size and the desired product size of the ore are also known then the power required for crushing that ore can be calculated.

Specific Energy Input

Where Work Index refers to the size fraction when rocks are reduced in size, *Specific energy input* refers to the amount of energy required to treat a certain tonnage. In simple terms if you crush 100t of rock from your feed size to your product size and it takes 180kWh, your specific energy input is $180\text{kWh} \div 100\text{t} = 1.8\text{kWh/t}$.

Mechanisms of Particle Fracture

A size reduction process is analysed by looking at the entire size distribution of its feed and product material. However as each particle breaks as a result of the stresses applied to it and it alone, it is of value to look at single particle fracture.

For a particle to fracture, a stress high enough to exceed the fracture strength of the particle is required. The manner in which the particle fractures depends on the nature of the particle, and on the manner in which the force is applied. There are three main generalised mechanisms of single particle fracture and they are;

- Abrasion

Abrasion fracture occurs when insufficient energy is applied to cause significant fracture of the particle. Rather, localised stressing occurs and a small area is fractured to give a distribution of very fine particles. This type of breakage occurs predominantly in ball mills.

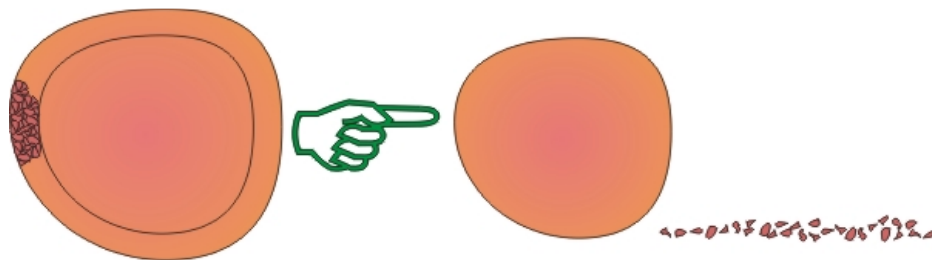

- Cleavage

Fracture by cleavage occurs when the energy applied is just sufficient to fracture the particle. Only a few particles result and their size is comparatively close to the original particle. Typically this situation occurs under conditions of slow compression where the fracture immediately relieves the loading on the particle. This is the main type of fracture found in jaw crushers.

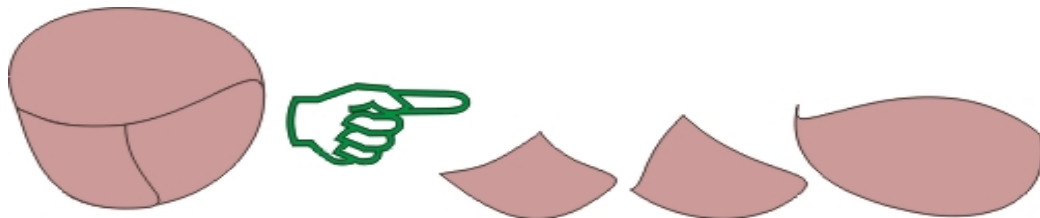

- Shatter

Fracture by shatter occurs when the applied energy is well in excess of that required for fracture; under these conditions many areas in the particle are overloaded and the result is a comparatively large number of particles with a wide size distribution.



In practice these events do not occur in isolation, rather breakages involve a combination of fracture mechanisms.

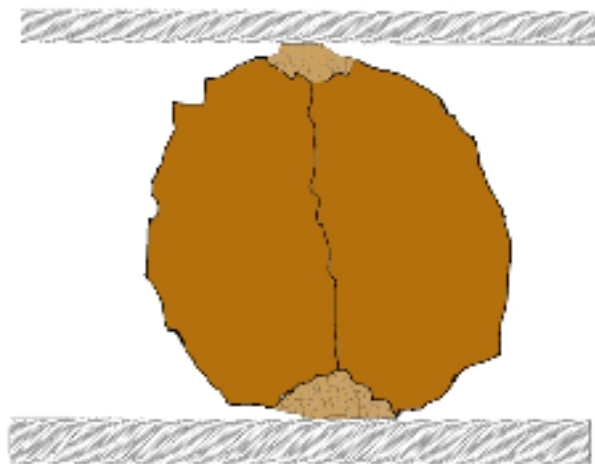

Energy and Size Reduction

The concepts of Work Index and Specific Energy make it clear that a certain (calculable) amount of energy is required to break a rock from one size to another. Experience has shown that to break a rock from coarse and medium size should require less energy per unit mass than to break a rock from coarse to fine, i.e. the smaller you want to break a rock, from a given starting size, the more energy you require.

Because we are talking about specific energy, i.e. energy per tonne of ore, it also follows that a given amount of energy spread out over a larger number of rocks will produce less breakage.

This can be demonstrated by looking at the numbers:

For example:

Say it takes 100kWh to break 50t of rock from 50mm to 10mm.

Then the Specific Energy Input from 50mm to 10mm is $100\text{kWh} \div 50\text{t} = 2\text{kWh/t}$.

If we then tried to use that same 100kWh to break 100t of rock we would only be putting in $100\text{kWh} \div 100\text{t}$ or 1kWh/t.

Now, we know that to break a rock finer we need to increase the energy input, so a Specific Energy Input of 1kWh/t will produce a much coarser product than a Specific Energy Input of 2kWh/t.

Crushing Equipment and Crushing Circuits

Crushing Equipment

The design requirements of size reduction machines change markedly as the particle size changes. In virtually all machines, the breakage forces are applied either by compression or impact. The products in each case are generally similar and the difference between machines is associated mainly with the mechanical aspects of applying the force to the various sizes of particles. When the particle is large, the energy required to fracture each particle is high, even though the energy per unit mass is low. As the particle size decreases, the energy per unit mass rises more rapidly. Consequently, crushers have to be massive and structurally strong.

Jaw Crushers

Jaw crushers cause fracture by compression, since this is the most practical method of applying a fracture force to very large particles. This in turn means that the machine must be constructed in such a way that the openings impose limitations on the feed and product size: capacity therefore becomes dependent on the size of the discharge opening and the machine speed.

Essentially a jaw crusher consists of two plates, set at an acute angle to each other, with one jaw pivoted (swing jaw), so that it swings relative to the other (fixed jaw). Material fed into the jaw is alternatively nipped (which hopefully causes it to fracture) and released to fall further into the crushing chamber.

Jaw crushers are normally classified by the method of pivoting the swing jaw. In the Blake type jaw crushers the jaw is pivoted at the top and thus has a fixed receiving area and a variable discharge opening.

In the Dodge type jaw crushers the jaw is pivoted at the bottom, giving a variable feed area but fixed discharge area.

Types of Jaw Crushers

There are various different types of jaw crushers used within the industry. The more commonly used types are depicted below;

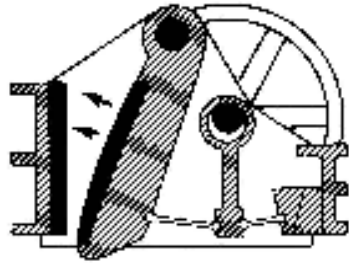

Blake (Double Toggle)

Originally the standard jaw crusher used for primary and secondary crushing of hard, tough abrasive rocks. Also for sticky feeds. Relatively coarse slabby product, with minimum fines.



Overhead Pivot (Double Toggle)

Similar applications to Blake. Overhead pivot; reduces rubbing on crusher faces, reduces choking, allows higher speeds and therefore higher capacities. Energy efficiency higher because jaw and charge not lifted during cycle.

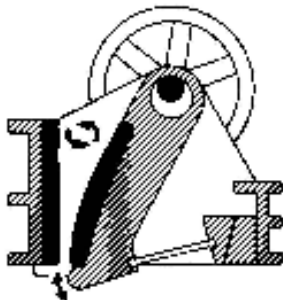

Overhead Eccentric (Single Toggle)

Originally restricted to sampler sizes by structural limitations. Now in same size of Blake which it has tended to supersede, because overhead eccentric encourages feed and discharge, allowing higher speeds and capacity, but with higher wear and more attrition brakeage and slightly lower energy efficiency. In addition as compared to an equivalent double toggle, they are cheaper and take up less floor space.

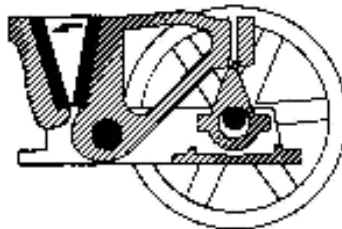

Dodge

Bottom pivot gives closer sized product than Blake, but Dodge is difficult to build in large sizes, and is prone to choking. Generally restricted to laboratory used.

Overhead Eccentric (Single Toggle) Crusher

Because the single toggle jaw crusher is more commonly used in today's crushing applications, a detailed description of its parts and workings is explained.

When the crusher is operational the swing jaw, which is suspended on an eccentric shaft, moves towards the fixed jaw under the action of the toggle plate, but it also moves vertically as the eccentric rotates.

The elliptical jaw motion assists in pushing rocks through the crushing chamber. The eccentric movement causes an increase in wear rate on the jaw plates as compared to the equivalent double toggle.

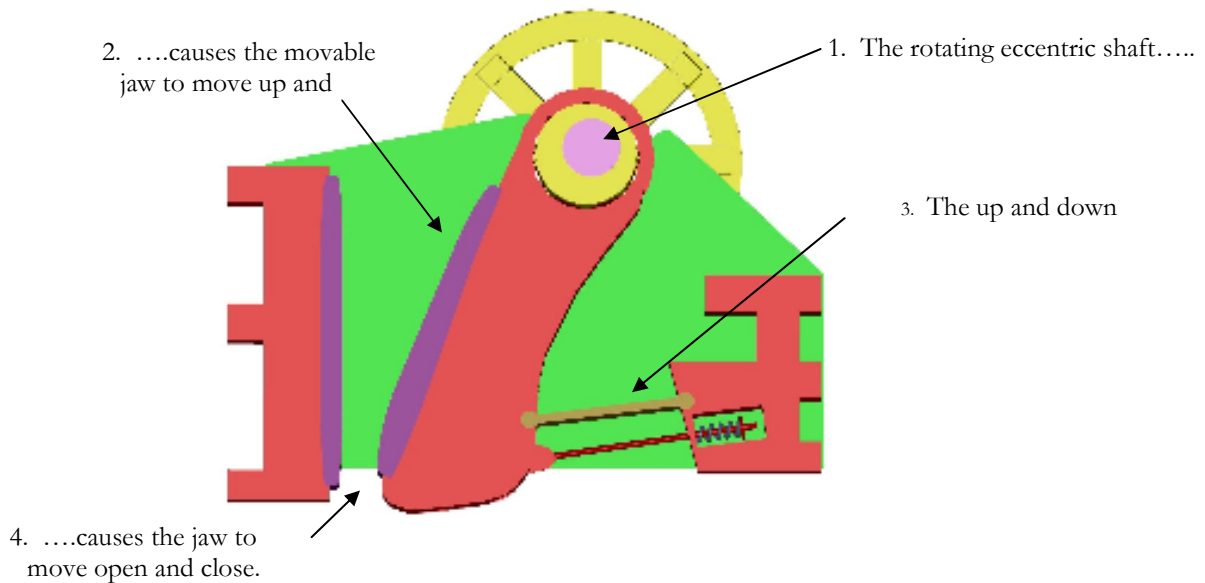

C-Series Jaw Crusher

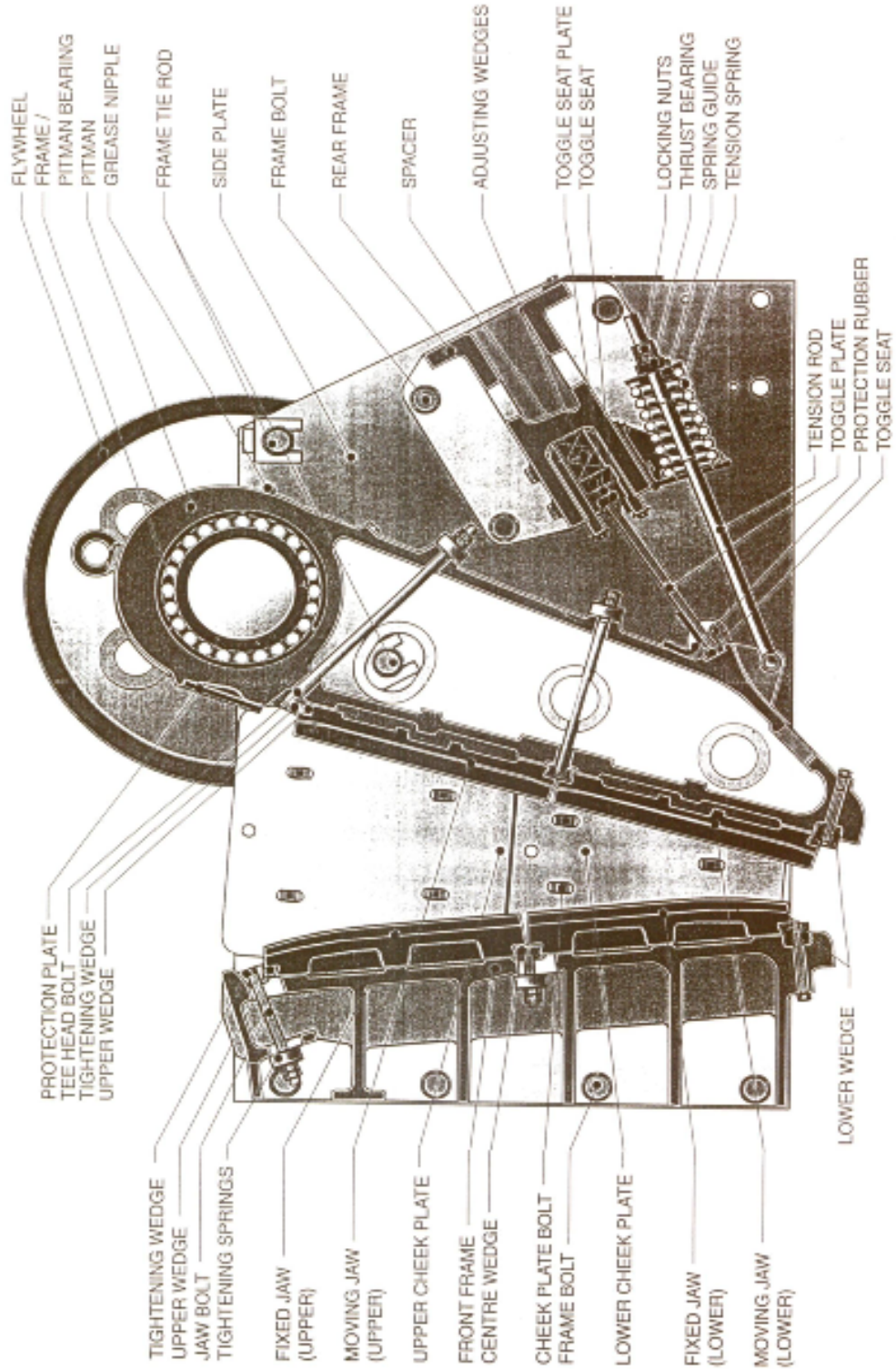

Cone Crusher – Sectional View and Parts Labels

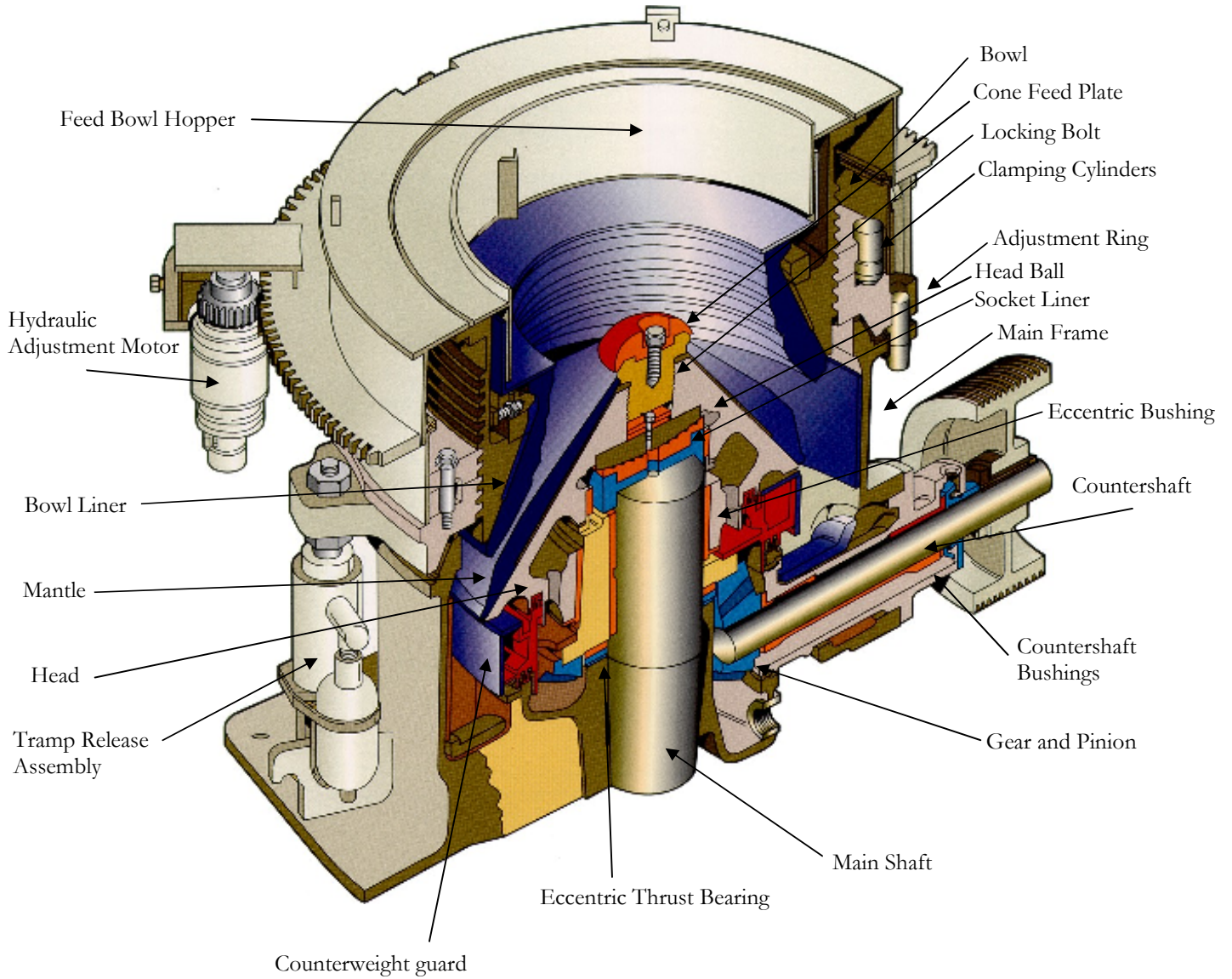

At the discharge end of the crusher is a parallel crushing section, where all material passing through must receive at least one impact. This ensures that all particles, which pass through the cone crusher, will have a maximum size, in at least one dimension, no larger than the 'set' of the crusher. For this reason, the set of a cone crusher can be specified as the minimum discharge opening, being commonly known as the "closed side setting" (CSS).

Cone crushers can have two types of 'heads', standard and short head types. The principle difference between the two is in the shape (size and volume) of the crushing cavities and feed plate arrangements.

Standard head cone crushers have cavities that are designed to take a primary crushed feed ranging up to 300mm generating product sizes around 20mm to 40mm.

For finer products short head cone crushers are normally used. They have a steeper angle of the head and a more parallel crushing cavity than the standard machines.

Due to the more compact chamber volume and shorter working crushing length, the much needed higher crushing forces/power can be imparted to the smaller sized material being fed to the crusher. Cavities for the short head machine are designed to produce a crushed product ranging from 5mm to 20mm in closed circuit.

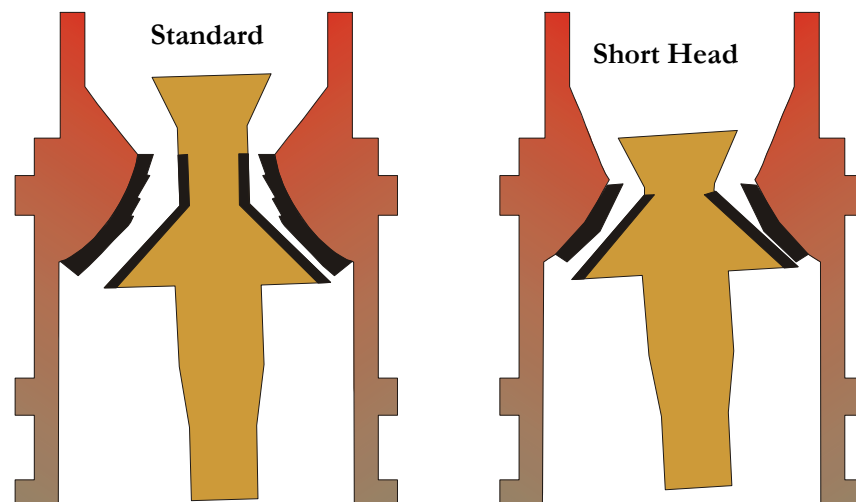

Gyratory Crushers

While the gyratory could be regarded as a variation of the cone crusher, its common use as a primary crusher within the mineral processing industry warrants a brief description of this particular crusher.

The gyratory is popular due to its high throughput capacity (up to ~10,000 tph possible) and the large sized opening. This means the crusher is well suited to handling direct feed from haul trucks, with minimal fuss. When required throughput's are around 700 tph or greater, essentially a gyratory must be used.

Feeding directly into the crushing chamber eliminates the need for bins and feeders before the gyratory. Oversize rocks can be broken with a rock breaker within the chamber itself. The total chamber width on the larger gyratory crusher can be up to 10m wide.

They are distinct to the more common cone crusher, with the top of the cone being supported and fixed by a bearing, with the bottom of the cone being the moving section creating the crushing action. This provides greater strength throughout the length of the cone. The "spider arm" across the top of the cone provides the strength needed for the crushing chamber in the top section.

Hydraulic pressure is normally used to apply upward pressure on the cone, which closes the gap, which is referred to as the "open side setting" on these types of crushers.

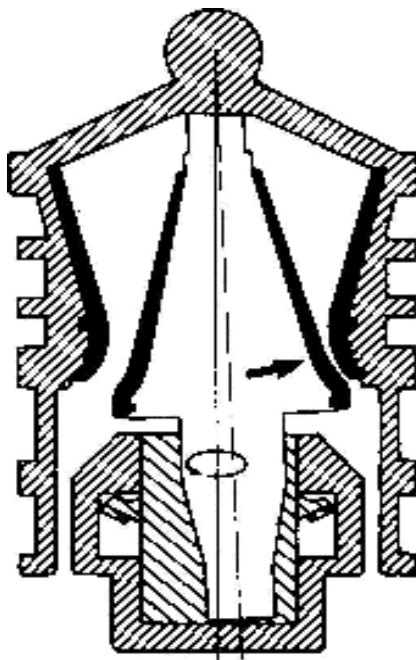

LEFT: Graphical representation of a Gyratory Crusher. Notice the similarity in shape of the crushing chamber to the Jaw Crusher. However, with its rotational action, the gyratory is always crushing, as compared to the jaw crusher, where it only crushes as the swing jaw moves towards the fixed jaw. Hence the gyratory can process a much greater throughput.

BELOW: Top view of 60x89" Svedala Gyratory Primary Crusher at Ernest Henry, QLD Australia. Ore is directly tipped into the crushing chamber by 200t trucks.



Impact Crushers

Impact crushers consist of a high speed rotating impeller or hammer, which accelerates the incoming new feed to high speed, to impact against a wear liner to cause rock breakage. Generally they are used on medium to soft ore types, with relatively low abrasion characteristics and low impact resistance (for example limestone or clay).

The products of these crushers are generally quite fine due to the large amount of power exerted on each particle as it passes through, causing shatter type fracturing. Thus impact crushers are capable of very high reduction ratios (ratio of the size of the incoming feed to the size of the crusher product). Their capacities are quite high for the relatively compact size and low complexity of the crusher.

Impact crushers are generally equipped with large drives (up to 600kW) due to the power required to achieve the high impeller tip speeds (from 500 rpm up to 2,500 rpm). Impactors in the secondary duty generally operate at slower tip speeds than those used for tertiary crushing duties.

The two general types of impact crushers are Vertical Shaft Impactors (eg. Svedala Barmac Duopactor, Jaques Canica) and Horizontal Shaft Impactors (eg. Hazi-mag or Nordberg Nordpactor).

The major issues associated with operating impact crushers are the high wear rates of the liners and hammers or impellers, particularly when handling abrasive feeds. Latest impact crusher designs incorporate hydraulic door access to the internals, and quick change lining systems. Significant research has also been carried out by the industry regarding liner material types to improve liner life.

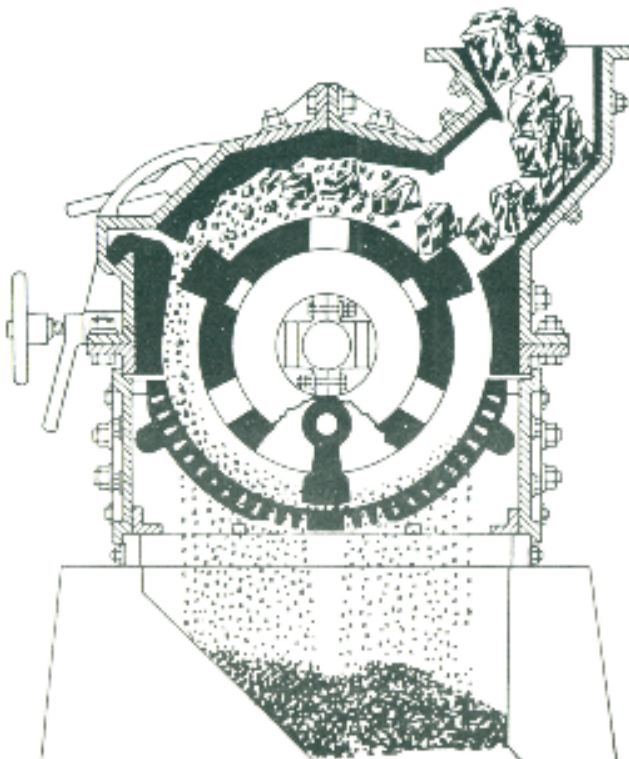

LEFT: Cross section of Hammer Mill type impact crusher (horizontal shaft type).

BELOW: Nordberg's Nordpactor Horizontal Shaft Impact Crusher

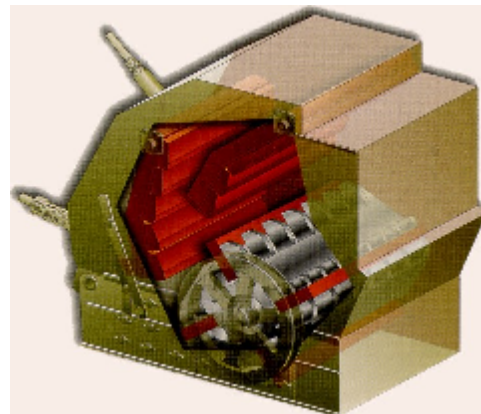

Rolls Crushers (High Pressure Grinding Rolls)

Rolls crushers are now emerging as the latest, most powerful and most efficient type of crusher, normally acting in the role of tertiary crusher. The current interest is due to the recent success of the studded roll design, which has overcome many of the roll wear problems that were severely hampering the success of this type of crusher. With the ability to operate a single crusher at +5MW (the most powerful cone crusher currently available is 1 MW), one single rolls crusher has the potential to replace many cone crushers operating in parallel to achieve the same duty.

Essentially a rolls or HPGR crusher consists of two parallel rotating rolls turning together (in opposite directions and turning in the direction of the downward material flow through the centre), with feed being directed through the moving gap between them. One roll is fixed, and the other moveable, using hydraulic pressure. As the ore moves through the gap, the hydraulic force behind the moveable roll acts to crush the particles as they are forced together into a crushed particle “bed”.

Each roll is equipped with its own motor, up to 2.5MW on each. One single rolls crusher can process up to 2,000 tph of ore being fed to it. Operating with high pressures normally results in a product that contains a significant amount of ultra-fines (crushed particles less than 1mm), which provides a favourable ore size distribution for ball mill feed.

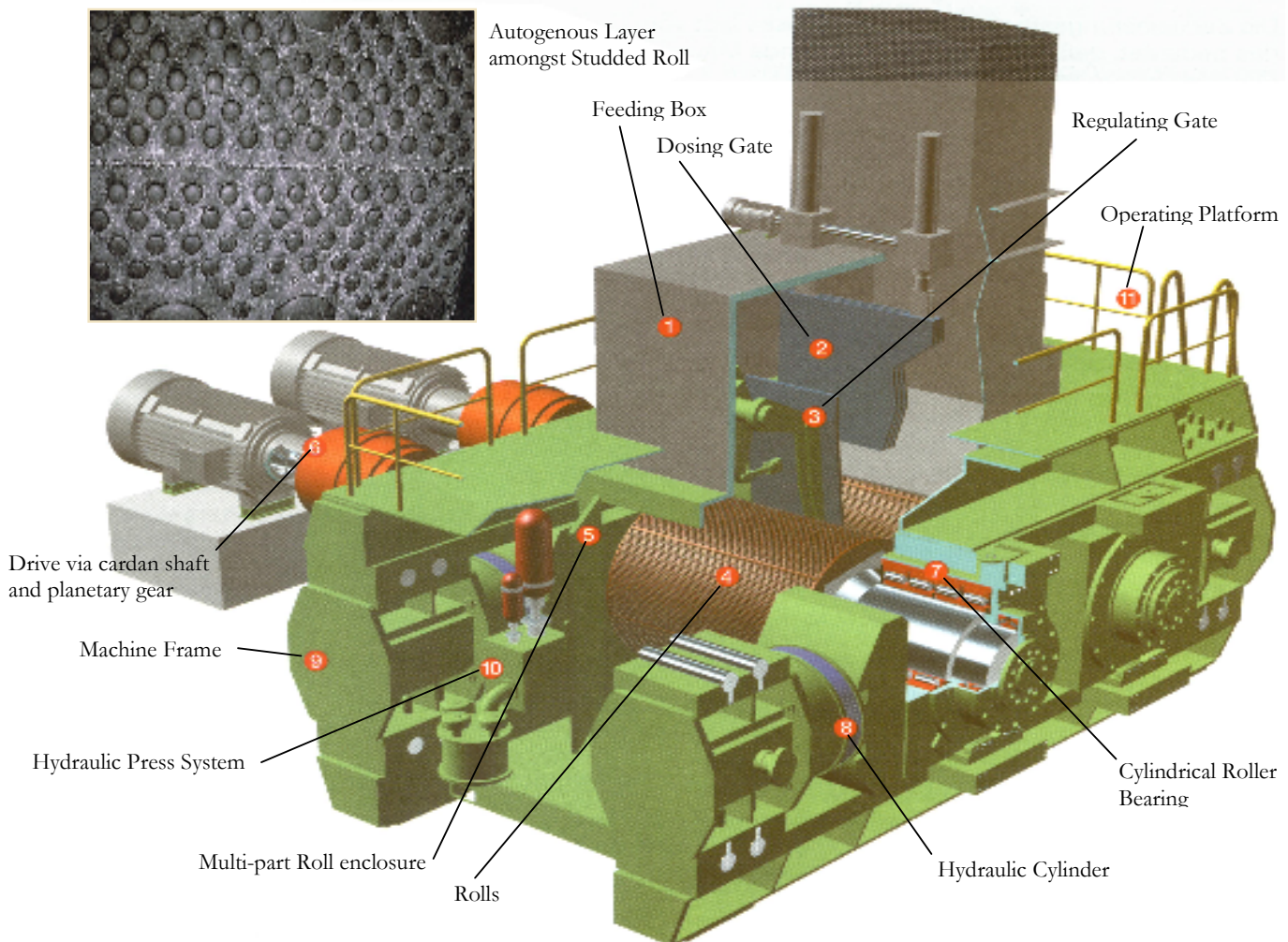

Bins and Feeders

Bins are used for surge capacity and can vary in size. Typically bins are located before the crushing equipment.

Feeders are used to deliver ore in a controlled manner to screening and crushing equipment, and therefore their speed can usually be controlled. Typically a crushing circuit will have a combination of apron feeders, vibrating feeders or reciprocating plate feeders. Vibrating feeders can have a grizzly incorporated into them.

Plate Feeders

Reciprocating Plate feeders are normally used on ROM bins, to discharge material into primary crushers. They essentially consist of a moving (backwards and forwards in one direction) or stroking platform, which acts to discharge material into a gap below, with the subsequent void at the back of the feeder being filled by new ROM ore.

Due to their simplicity and slow motion, they are normally quite reliable in such an arduous duty. They also have very few moving parts.

The disadvantages however, are the start/stop nature of the feed during the stroking cycle, and the tendency to promote build-up of the larger particle above the exit of the bin thus increasing the chance of rock bridging in cases when the dimensions of the ROM bin outlet are limited. Control over the feed rate is normally very poor. Further, direct impact of large rocks on the plate feeder can severely limit the life of the feeder itself.

Vibrating Feeders

Vibrating feeders consist of a gently inclined vibrating plate, operating with a motion to encourage forward movement of the material. They are normally used for lighter type duties, where control of feed rate is important, for example feed to a screen or secondary/tertiary crusher.

They are generally not suited for transport of materials that are sticky and fine in nature (eg. Clays), due to the tendency to encourage packing and build-up of these types of ores.

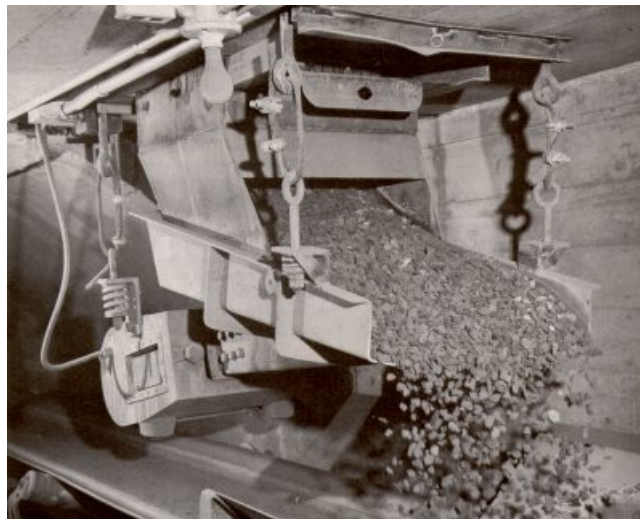

Apron or Belt Feeders

Apron or Belt Feeders consist of a slow moving continuous belt (either metal in the form of overlapping steel plates or rubber conveyor) normally positioned underneath a bin or stockpile slot.

They provide reasonable feed rate control, and in particular the Apron type (which uses metallic plates) is resistant to impact from large rocks. Thus are normally suited for heavy-duty applications, such as on a ROM bin or under a stockpile/bin of crushed ore.

The slot or bin opening above the feeder itself is shaped to promote flow in the direction of the feeder. That is, the slot opens up and increases in width towards the discharge point of the feeder. This reduces the chance for blockage, and encourages flow from the entire hopper.

With the positive movement of the feeder at the base, they are also reasonably suited for sticky materials. In addition, with the use of a belt, they can be used in applications for drawing material from large hoppers.

However, maintenance on these feeders is notoriously difficult to carry out, and they are relatively expensive to purchase compared to the equivalent vibrating or plate feed.



Apron Feeder operating under a Coarse Ore Stockpile to provide feed for a SAG Mill.

Vibrating Screens

In crushing plants screens are used for size separation of the ore being crushed. Generally ore that is undersized is sent onto the next stage of comminution and oversize ore is often returned to the circuit for further crushing (see closed circuit section). Screens can be designed in a single deck, double deck, or triple deck configuration, depending on the application required. The shape of the screen can be either conventional inclined (entire screen sits at one angle), or “banana” shaped being steep at the feed end, with the angle reducing towards the discharge end.

Conventional Screen

The conventional inclined vibrating screen is used widely within the mineral processing industry. They are characterised by the consistent incline angle.

High screening efficiencies are obtained with the use of a reasonably deep bed of ore moving down the screen, to promote sorting and flow through the screen deck.

Too thin a bed depth may result in the material “bouncing” leading to poor efficiency.

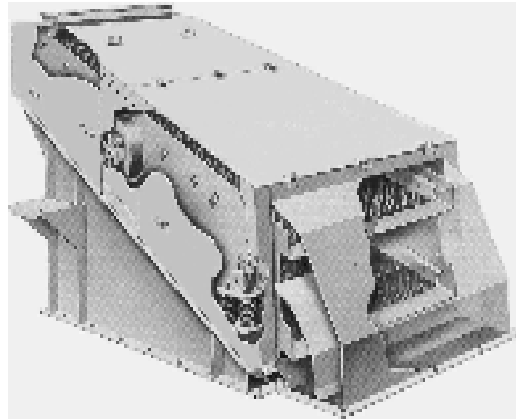

Banana Screen

The “Banana” screen is a more recent variation of the conventional inclined screen, becoming more common due to their high unit capacity and high efficiency.

The higher capacity is due to the steep initial screen angle (resulting in a fast moving bed, thus increasing overall screen capacity) and the high powered exciters usually installed on the screens. The rate of fines removal in this section of the screen is high.

The high efficiency is borne from the flatter bottom section, which provides an opportunity for good separation of the near-size material (particles of a dimension close to that of the screen aperture).

The upper practical limit for reliable high force banana screens is ~3.7m wide by ~8m long. Feeding such large screens normally requires a diverging vibrating feeder to ensure material is presented to the screen across the entire width, otherwise significant available screen area will be wasted.

Larger sized banana screens are normally supported on an Isolation Frame. This essentially consists of a heavy (usually by filling a steel structure with concrete) supporting frame, which is attached to the supporting structure through additional springs and shock absorbers. The Isolation Frame significantly reduces the transmission of the vibrating forces from the exciters through the supporting structure, meaning that concrete foundations are not required.

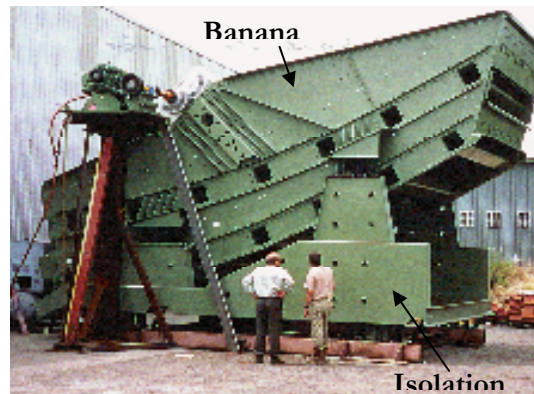

Transfer Chutes

Chutes are used to transfer material from one plant component to another, and are thus critical to the reliable and continuous operation of a mineral processing plant.

A good chute design achieves the following;

- Flow free from blockage by larger particles or sticky material build-up.
- Minimal damage to the receiving plant component.
- Minimal segregation of the particle sizes within the stream as it moves through the chute and onto the receiving component.
- Positioning of the material centrally or in the correct fashion onto the receiving component.
- Flow direction of the material preferentially in the direction of movement of the receiving conveyor or feeder.

Chutes handling non-abrasive and sticky material are normally very simple, and are generally designed to minimise points where materials can build-up eventually blocking the chute. Minimising contact points between the material and the chute components itself generally achieves this.

However, chutes designed for abrasive and hard ore are more complex and usually incorporate “rock-boxes” (chute sections designed to hold a static mass of rock to act as an impact bed) to facilitate rock-on-rock contact as the ore moves through the chute. The leading edges of the rock-boxes are prone to wear, and thus lined with replaceable wear billets.

To minimise damage to the receiving component, it is often desirable to create a more difficult path for the ore, to reduce its velocity. Minimising contact between the moving ore and structural plate-work is also required, to reduce liner wear rates.

BELOW: Rock-boxed product screen bottom-deck oversized chute at



LEFT: Modelling of SDGM Screen Top-deck Oversize Chute at 1/10th scale. Extensive rock-boxing is used to minimise contact of the sliding ore with the chute itself, and to slow the ore down prior to it impacting the conveyor below.

Conveyors

Conveyors as a means of moving material within crushing plants are preferred and common because they provide an even and continuous flow. Their mechanical efficiency is high as relatively little dead weight (ie. the conveyor itself) must be moved with the load. Further, frictional resistance is low (due to the numerous bearing supported rollers) and power consuming starts and stops are relatively rare.

Basically, a conveyor is an endless moving flat belt for transporting dry materials. The belt extends between a head pulley, and a tail or return pulley. It is supported by idler rollers, which are, in turn, supported by a frame. The drive pulley is often located at the head end or at an intermediate point along the return run. Tension in the belt is provided by either a "take up" or "gravity" pulley, located just behind the drive pulley, or an adjustable tail pulley (more common on smaller length conveyors).

Belts, which move loose material, are usually run through a trough in the upper belt, which centres the load to reduce spill off the sides. Short conveyors, such as the feed conveyors can carry larger loads by using a flat surface with fixed side skirts to reduce material spillage.

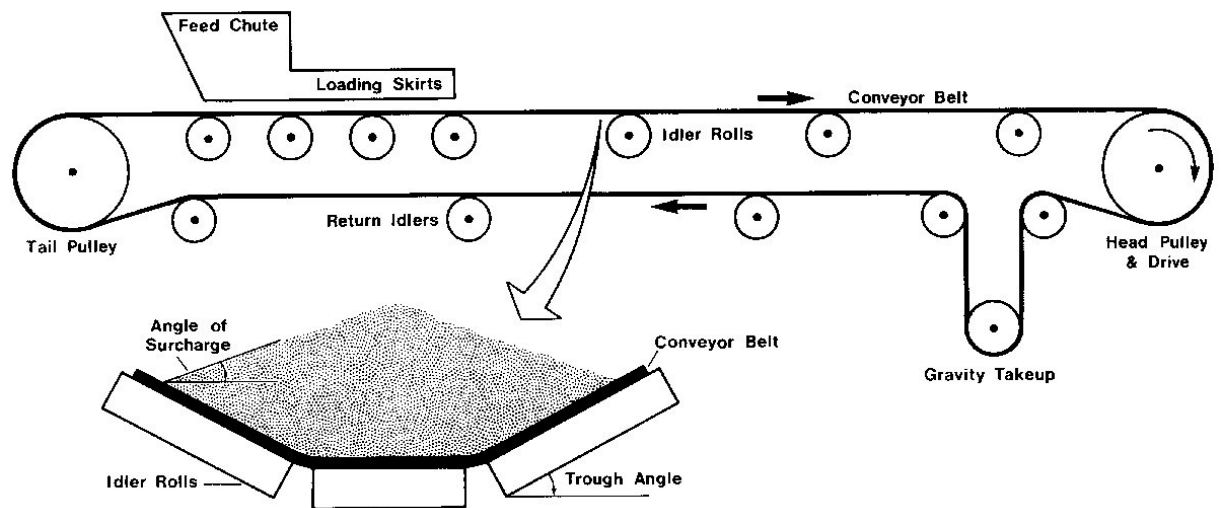

Dust control (a common issue associated with conveyors) from conveyors is controlled as much as possible with the incorporation of some or all of the following;

- Two-stage loading skirts (usually steel internal with rubber or polyurethane external skirt)
- Dust extraction system operating from the loading skirt area
- Belt-scrapers adjacent the head pulley
- Chute design minimising impact velocity of ore onto the belt
- Water sprays & Belts covers

Crushing Circuits and Staging

It requires more energy to keep breaking rocks down to a smaller size. Processing plants may use different strategies to achieve comminution largely depending on the ore types. The most common strategies include use of single-stage crushing followed by autogenous (AG) or semi-autogenous grinding mills (SAG), and multiple-stage crushing followed by ball mills and/or rod mills.

The first type (AG or SAG) is used for ores of medium to low competency (or hardness) where only low levels of impact energy are required to cause the rocks to fracture, and part of the feed includes some reasonably competent material, which can act as autogenous grinding media. In these types of circuits, the grinding area is generally where nearly all the power is consumed, as this is where the majority of the comminution process is taking place. Feed to SAG or AG mills is usually from a primary crushed product normally either a jaw or gyratory crusher. The performance of AG or SAG circuits can be enhanced with pebble crushing (to fracture the harder rocks building up within the mill), and/or the addition of a secondary crusher to reduce the feed size to the mill (eg. Placer Granny Smith).

The second strategy (employing multiple-staged crushing) is more suited for competent ores which demonstrate a resistance to SAG milling, or ores where there is no competent material at all to act as autogenous grinding media.

Single Stage Crushing

Single-stage crushing is generally employed where the final product size of the ore being crushed is generally between 90mm to 200mm.

Single-stage crushing circuits are generally configured in an open circuit arrangement, that is what goes into the crushing machine exits and goes onto its final destination. There is no recirculating load or screening involved.

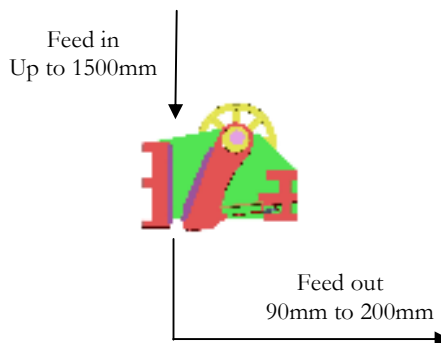

The size of the product leaving this stage is controlled by the size of the discharge opening or closed side setting of the crusher.

Primary jaw and gyratory crushers are generally configured in an open circuit arrangement. A scalping grizzly may be installed prior to the crusher to improve its performance and reliability by eliminating material being fed to the crusher already at the correct size.

Secondary Stage Crushing

Secondary stage crushing involves crushing the product to its required size, generally 15 to 35 mm, using two types of crushers, typically a Jaw and Cone crusher. Other combinations of crushers may be used also, for example gyratory as a primary or impact crusher as a secondary.

Secondary stage crushing employs a combination of both open and closed circuit crushing. The primary jaw crusher is usually configured in an open circuit arrangement and the secondary cone crusher is normally configured in a closed circuit arrangement.

In a closed circuit, the products from both crushers are screened, with the oversize from the screen being conveyed to the cone crusher again. The screen mesh size and not the crusher CSS governs the size of the material leaving the circuit. In this circumstance, the cone crusher can be run with a larger gap, thus making use of rock-on-rock crushing within the crushing chamber.

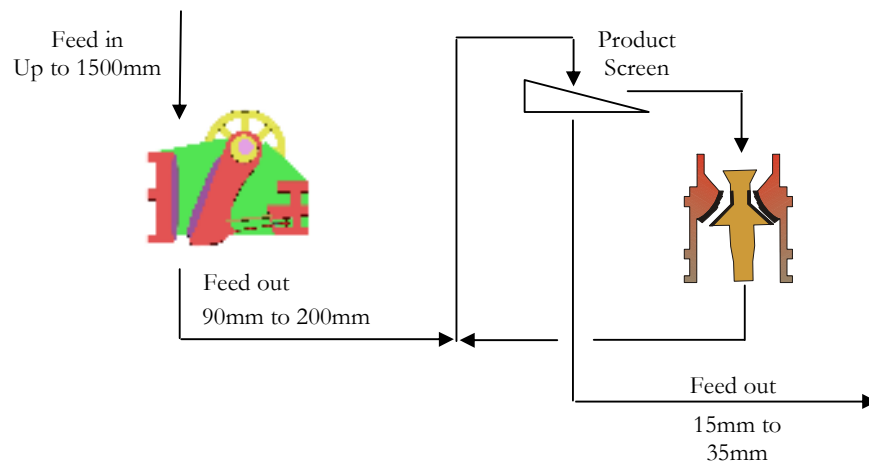

Two-stage crushing is more often employed in the mineral processing industry to improve performance and capacity of SAG mill circuits. For fine crushing (eg. Preparing feed to either a Rod or Ball Mill), two-stage crushing is not common, and is really only suited for very soft ores. This is due to the fact that to achieve such a fine product requires the secondary cone crusher to be operating well above the normal and design reduction ratios.

Tertiary Stage Crushing

Tertiary stage crushing involves crushing the product to its required size, generally 7 to 15 mm, using two or more types of crushers.

If using cone crushers for both the secondary and tertiary duties, it is common to install different head arrangements on each cone crusher. In this case, the standard head cone crusher becomes the secondary while the short head cone becomes the tertiary crusher. This will be discussed in more detail later.

As with secondary stage crushing, tertiary crushing circuits employ a combination of both open and closed circuit crushing. The primary crusher is normally configured in an open circuit arrangement; while the secondary and tertiary crushers are commonly configured in closed circuit arrangement.

In this closed circuit, the product from the crushers are screened using a double-deck screen with the top-deck oversize from the screen being returned to the secondary crusher and the intermediate size (bottom-deck oversize) being delivered to the tertiary crushers.

Again, the screen mesh size and not the crusher CSS's govern the size of the material leaving the circuit.

The CSS on the secondary crusher can be set higher than in a secondary crushing circuit as this product will undergo further reduction in size through the tertiary crushers.

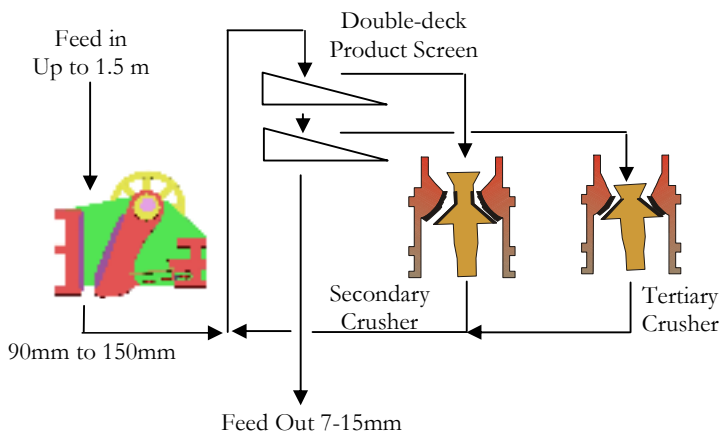

The three stages allow the practical achievement of fine product on competent rock, as each stage is operating at normal or equipment design reduction ratios.

Further size reduction can be achieved with the adoption of 4-stage crushing, however this is usually limited to ores of extreme hardness, where reduction ratios are low at each stage due to the competency of the rock, or if the product size required is unusually fine.

Crushing Circuit Overview

The crushing circuit at typically is a three-stage (tertiary) operation that utilises a primary jaw crusher, a secondary cone crusher and two tertiary cone crushers (operating in parallel). This circuit has been selected to match the competency of the ore, and the production rate requirements from the mine.

General Description

The Run of Mine (ROM) ore is fed to a 170 tonne capacity ROM bin by a front-end loader through a 800mm square aperture static grizzly. The oversize from the grizzly is broken with the rock breaker which is installed adjacent the ROM bin.

A plate feeder and vibrating grizzly transfer the ore from the ROM bin to a single-toggle jaw crusher. The jaw crusher operates with a closed side setting (CSS) of 130-140mm and is powered by a 200kW motor.

The jaw crusher product discharges onto a vibrating feeder together with the grizzly undersize. The vibrating feeder transfers the ore onto CVR01. These products combine with the discharge of the secondary cone crusher on CVR01 and then transfer to the screen feed conveyor CVR02. Product from the tertiary crushers' combines with the primary and secondary crushed products on CVR02.

The ore is then discharged from CVR02 onto a double-deck banana screen via a diverging feeder. This screen is fitted with 14mm and 45mm slotted aperture rubber/poly cloths in the lower and upper decks respectively. The oversize from the upper deck reports to the secondary crusher feed conveyor CVR03. The lower decks' oversize reports to the tertiary crusher feed conveyor CVR04 and the undersize fraction from the lower deck reports as final product to the fine ore bin via CVR05, CVR06 and CVR07.

Secondary crusher feed (+45mm) is discharged into the secondary crusher feed chamber via surge bin equipped with a variable-speed vibrating feeder. The secondary crusher is a standard head cone crusher which operates at a closed side setting of ~30-35mm and is powered by a 375kW motor.

Tertiary crusher feed (+14mm -45mm) is directed from CVR04 onto a splitter plate, which distributes feed into both surge bins. The surge bins are equipped with two variable-speed vibrating feeders which discharge material into the chambers of the tertiary cone crushers. The tertiary crushers are equipped with short heads which operate at a closed side setting of ~10-16mm and are powered by 375kW motors.

The crushing circuit produces a product of 80% passing ~9mm at a design rate of 515tph. A diagrammatical representation or flowsheet of the circuit is shown on the following page.

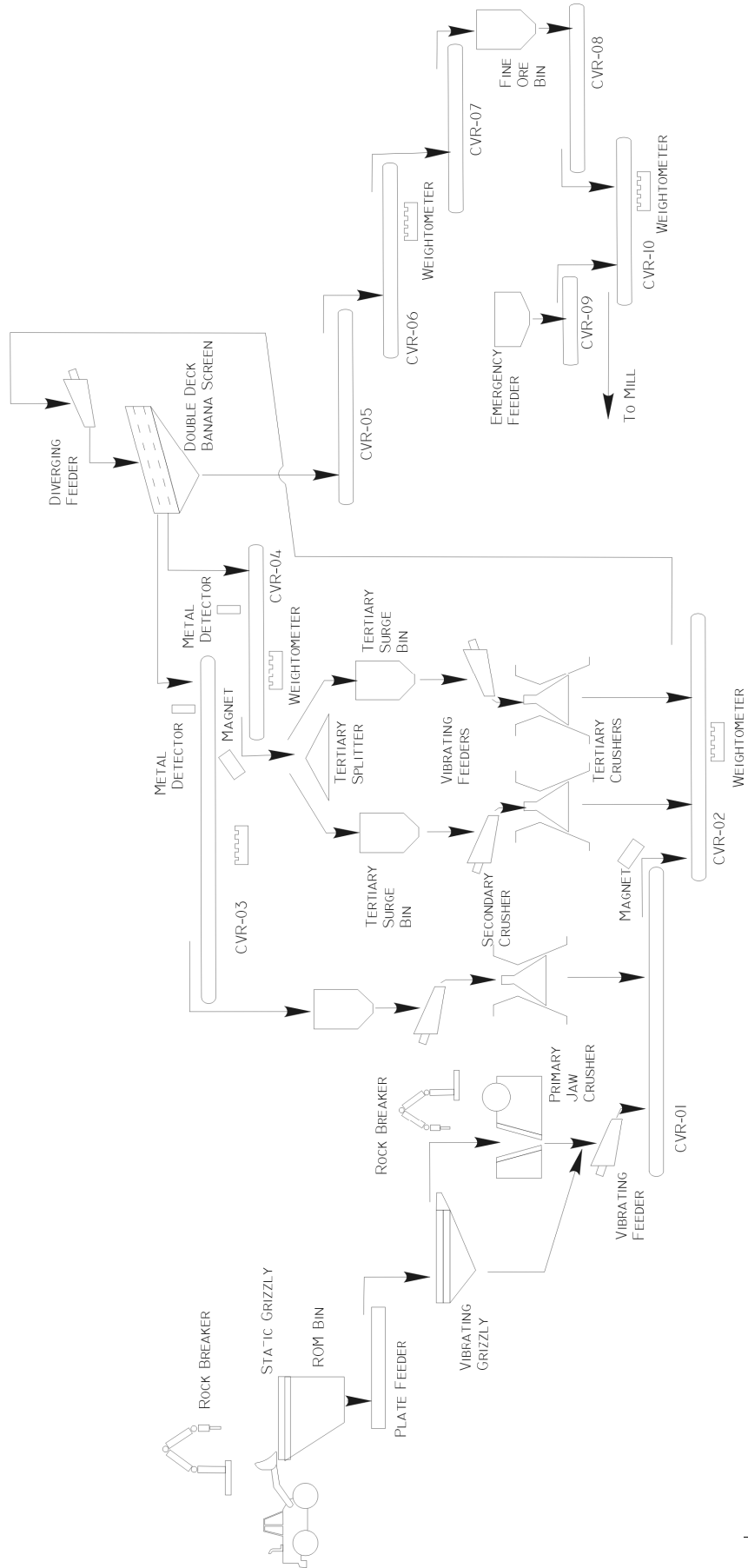

Crushing Circuit Major Components

ROM Bin

Ore is taken from the various stockpiles (or “fingers”) on the ROM pad and fed into the 170t capacity ROM bin by a contract CAT990 front-end loader. Dump lights (traffic lights) are installed at the ROM bin to provide direction for the loader operator.

Air cannons are installed on the walls of the ROM bin and are fired to dislodge ore hang-ups in the bin when required. Prior to the cannons firing an alarm is sounded.

A rock breaker is installed immediately adjacent to the ROM bin for the purposes of keeping the installed 800mm x 800mm aperture static grizzly clear of oversize rocks. The rock breaker is controlled by the crusher control room operator, in the control room via two cameras and CCT monitors. The rock breaker has been installed due to the expected increase in oversize material with the increase in proportion of primary rock being fed to the ROM bin. Its purpose is to eliminate or reduce significantly the need to clear rocks jammed at the exit of the ROM bin, which when done manually (eg. using explosives) is a risky task. While the loader operator is collecting his next bucket load, the crusher operator can clear the grizzly of any leftover oversize material. Twin orange flashing lights are automatically activated while the rock breaker is in use, to warn the loader operator. In the event that the rock breaker is out of service, the ROM mobile rock breaker will be required to maintain a clear grizzly.

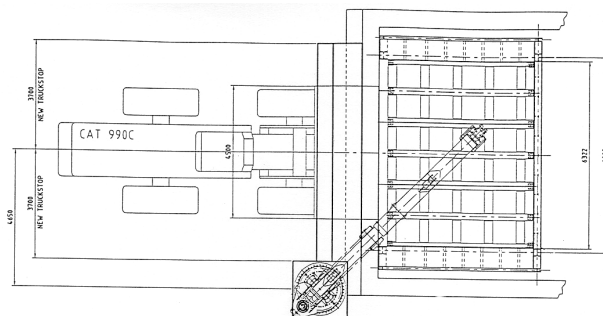
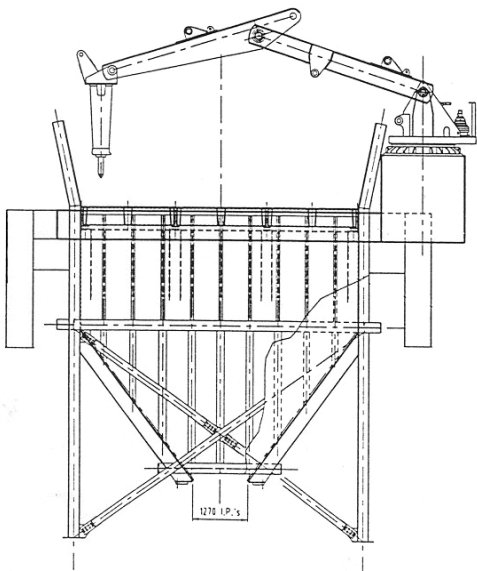
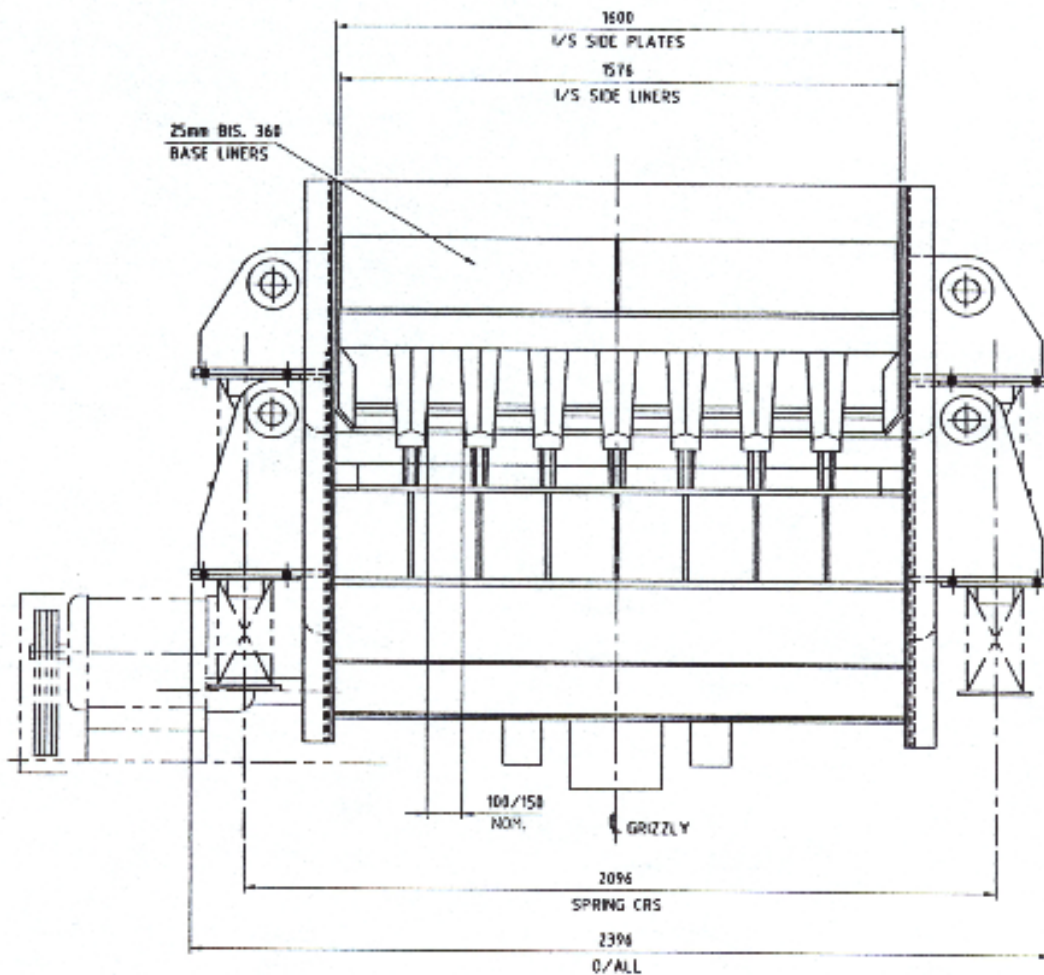

Plate Feeder and Vibrating Grizzly

A hydraulically driven reciprocating plate feeder (Nordberg 1.6m x 5.5m HRP Feeder) is installed at the base of the ROM bin. It is used to “push” ore onto the vibrating grizzly and into the jaw crusher.

The rate of the plate feeder oscillation stroke is variable to enable control of the feed rate.

The receiving vibrating grizzly/feeder (Nordberg 1.6m x 3.0m LM-GXHD Feeder) scalps the ROM ore, and passes the oversize to the primary jaw crusher. The scalping aperture is 90mm increasing to 120mm at the discharge end.



Front view with dimensions of the Nordberg Vibrating Grizzly Feeder.

Jaw Crusher

The jaw crusher used at SDGM is a single toggle 'Blake Overhead Eccentric' C140B crusher manufactured by Nordberg. The opening dimensions are 1400mm x 1070mm.

The C140B jaw crusher is powered by a 200kW motor and operates with a closed side setting of approximately 120mm to 140mm depending on the ore characteristics.

The crusher is fitted with hydraulic jaw adjustment and automatic grease lubrication system.

The drive motor is attached to the same frame as the crusher to ensure that correct vee-belt alignment can be achieved.

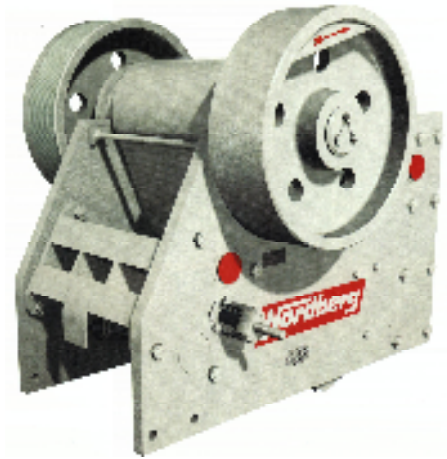

CVR01 Vibrating Feeder

A Schenck BFF0948 Vibrating Feeder (2x 4kW drives) of fixed speed receives ore from the jaw crusher and vibrating grizzly undersize chute.

The purpose of this feeder is to absorb the impact of larger sized material from the jaw crusher, and feed ore in controlled manner onto CVR01. This will reduce conveyor belt damage to CVR01, eliminating many of the issues associated with this conveyor due to its poor condition, for example dust carry-back.

Given enough fines are contained in the ROM feed, the material from the grizzly undersize chute should provide some impact protection from the material falling from the jaw crusher, due to it being fed onto the feeder first.

The feeder is to be lined with thick rubber. For maintenance access, the feeder can be unplugged from its power source, moved back on the rollers, and lowered to the floor area behind CVR01.

Secondary Cone Crusher



Material from the secondary surge bin is fed into a Nordberg HP500 standard head cone crusher, which is driven by a 375 kW motor. The crusher has a closed side setting of approximately 30-35mm.

Feed to the secondary crusher is via a Schenck BFF1242 variable speed (2x 4kW drives) vibrating feeder.

The surge bin has a capacity of 70 tonnes, so at full throughput of ~500 tph, will take 8 minutes to fill from empty. The bin is fitted with load cells to more accurately determine the bin fill volume.

The secondary HP500 is fitted with a hydraulic remote CSS adjustment system that allows a gap adjustment to be performed from a Citect command. Feed is temporarily stopped to the crusher while this procedure takes place.

The crusher is fitted also with a tramp release system, which prevents damage to the crusher if maximum crushing forces are exceeded through overfeeding or contamination with tramp metal. Repeated and frequent “tramping” of the crusher will result in long term structural damage. Vibration monitoring installed on the crusher to provide information to the operator concerning the level of tramping occurring.

A standard coarse bowl liner is installed, which permits a maximum feed lump size of 291mm, with a minimum or tightest possible CSS of 30mm.

Tertiary Cone Crushers

Material from the tertiary surge bins is fed into two Nordberg HP500 short head cone crushers. These are also driven by 375 kW motors and have a closed side setting of approximately 12-16mm. The short head medium bowl liner permits a maximum feed lump size of 58mm, and a minimum CSS of 10mm.

Feed to the tertiary crushers is via two Schenck BFF1242 variable speed (2x 4kW drives) vibrating feeders, identical to that installed on the secondary crusher.

The surge bins have a combined capacity of 100 tonnes, so at full throughput of ~550 tph, will take 12 minutes to fill both from empty. The bins are fitted with individual load cells to more accurately determine the fill volumes. A splitting plate is installed above the bins, to control direction of flow between the two bins. This is discussed in more detail in a later section.

Inspection hatches are fitted to the tertiary HP500 crushers (but not the secondary) to allow viewing access to the underside of the crushers while the plant is shut down.

The tertiary HP500's are fitted with hydraulic remote CSS adjustment systems, which allow a gap adjustment to be performed from a Citect command. Feed will be temporarily stopped while this procedure takes place. The crushers are fitted also with a tramp release system, which prevents damage to the crushers if maximum crushing forces are exceeded through overfeeding or contamination with tramp metal. Repeated and frequent "tramping" of the crusher will result in long term structural damage. Vibration monitoring installed on the crusher to provide information to the operator concerning the level of tramping occurring.

Diverging Feeder and Product Screen

The ore is discharged from CVR02 via a diverging vibrating feeder to a 3.6 x 7.6m Schenck Double-Deck Banana screen. This screen is fitted with 14mm and 45mm aperture cloths in the lower and upper decks respectively. The purpose of the diverging feeder is to present the material at full width to the product screen to maximise screen use and thus efficiency.

The oversize from the upper deck reports to the secondary crusher feed conveyor CVR03. The lower decks' oversize reports to the tertiary crusher feed conveyor CVR04, and the undersize fraction reports as final product to the fine ore bin feed conveyors CVR05, CVR06 and CVR07.

BELOW: Sunrise Dam Schenck Double-Deck Banana 3.6x7.6m product screen, showing positioned on the isolation frame.

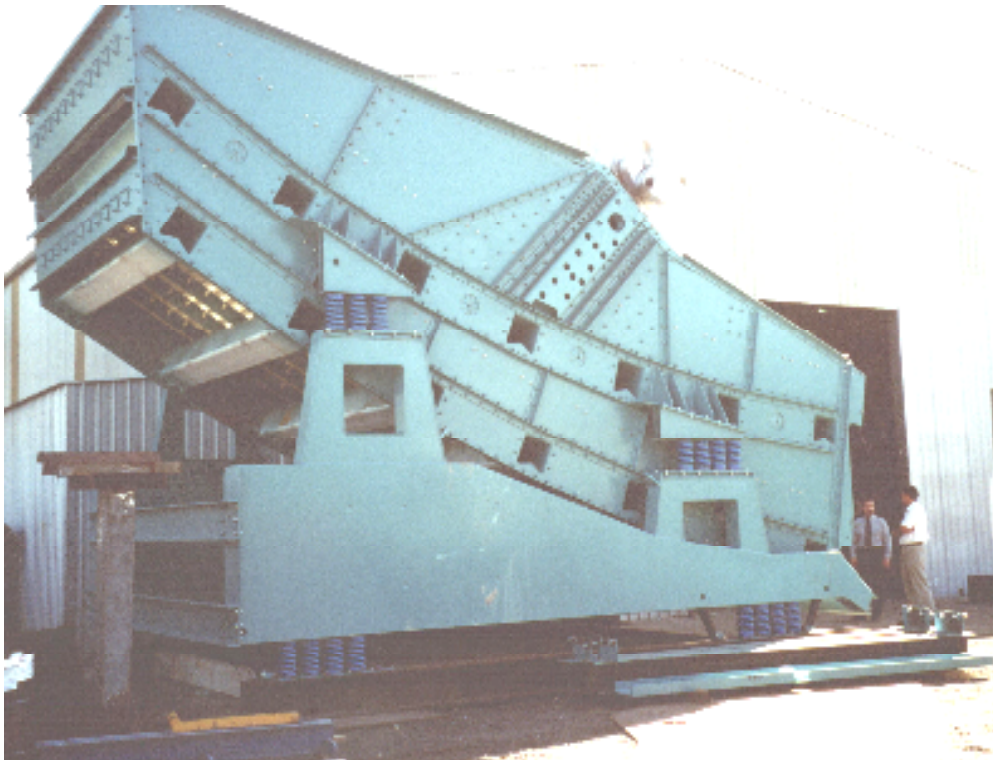

Conveyors

Various conveyors are used throughout the crushing circuit and they vary in length, width and capacity. Below is a summary of the conveyors used within the SDGM crushing circuit;

Conveyor	Length (m)	Width (mm)	Drive (kW)	Capacity (tph)
CVR-01	36	1800	45	976
CVR-02	100	1500	132	1506
CVR-03	100	1200	55	460
CVR-04	85	1200	55	530
CVR-05	25	1200	22	515
CVR-06	150	900	45	515
CVR-07	53	900	45	515

Conveyor counterweight towers include maintenance access walkways, and support system to allow safe suspension of the counterweight for maintenance purposes. All conveyors are fitted with overhead fall arrest systems for use when access to the conveyors is required.

The CVR02 drive is located at ground level due to the large size of the motor and gearbox to improve maintainability.

CVR03 is fitted with remote isolation switch at the head pulley, to be used when removing tramp metal from the conveyor after a metal detect.

Chutes

The following chutes have been modelled at 1/10th scale to optimise performance;

- CVR01 and CVR02 transfer chute
- CVR02 head chute/Screen feed chute incorporating diverging feeder
- Screen Top-deck Oversize Chute
- Screen Bottom-deck Oversize Chute
- CVR04 head chute/Tertiary Bin Splitter
- Secondary surge bin discharge chute/feeder.

The designs incorporate rock-boxing to reduce liners wear areas where possible. The designs also attempt to reduce size segregation and material velocity where possible. Care must be taken if altering any of the above mentioned chutes, as the flows will change unexpectedly as a result.

The CVR01 chute incorporates an angled rock ledge to move a portion of the flow back into the right-side (looking from the CIL tanks) of the chute. This flow reflects off this side of the head chute and then moves in the direction of the CVR02 conveyor, prior to discharging onto CVR02.

The CVR02 head chute incorporates many rock ledges, to reduce velocity and redirect flow into the correct manner for feed onto the diverging feeder. The complication with the chute is the need to turn the material 90°, as the conveyor and product screen are perpendicular to each other. Direct impact of rock onto the diverging feeder had to be eliminated.

The challenges with the screen oversize chutes were to ensure velocity is reduced prior to impact onto the conveyors below, to minimise the chance of blockage and reduce the anticipated high wear rates of the liners.

The CVR04 head chute required rock-boxes and ledges to ensure the material is presented homogeneously onto the splitter plate, to eliminate or reduce the segregation of material size between the two parallel tertiary crushers. This has been achieved with a circular hole positioned just above the splitter plate.

The secondary bin discharge chute design was aimed at minimising bridging of the exit with the +40mm primary crushed rocks, which tend to be quite slabby.

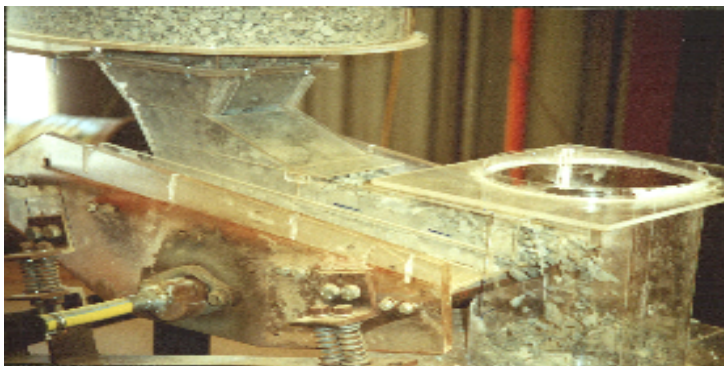

LEFT: Modeling of the secondary crusher surge bin discharge feeder. Note the modified angled hood at the base of the bin, which was required to eliminate rock bridging.

Tertiary Feed Splitter

A feed splitter is located above the tertiary surge bins. The splitter bar is made to pivot, by the action of a pneumatic ram (incorporating hydraulic locking mechanism), to allow the entire ore stream to be directed into either bin or both.

With the use of the isolation flop-gates above the splitter, the bins can be isolated completely for maintenance work.

The optimum for the pivot to direct all the feed to either bin is $\pm 35^\circ$ at each side so that minimal spillage or build up occurs. When the splitter is left in the horizontal position a 50/50 split to the surge bins will occur.

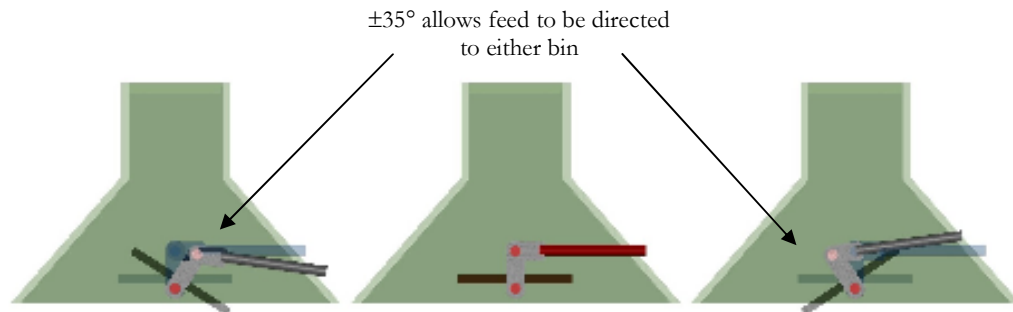

Tertiary Feed Splitter

The horizontal position allows for a 50/50 split to the tertiary surge bins

When at the 35° angle, material may still occasionally “bounce” from the splitter into the non-fed bin. Thus when isolating the bin for maintenance purposes, the isolating flop-gates positioned above the splitter plate must be used.

The splitter plate itself is a rock-box, which allows material to build-up on it to form a “cone”. As the splitter plate tilts towards a particular bin, feed is preferentially directed to that bin.

LEFT: CVR04 Head Chute with Splitter Plate – showing ore flow through the rock-boxing, and being directed via a circular hole onto the centre of the splitter plate. Ore is built up on the horizontal splitter plate to form a cone.

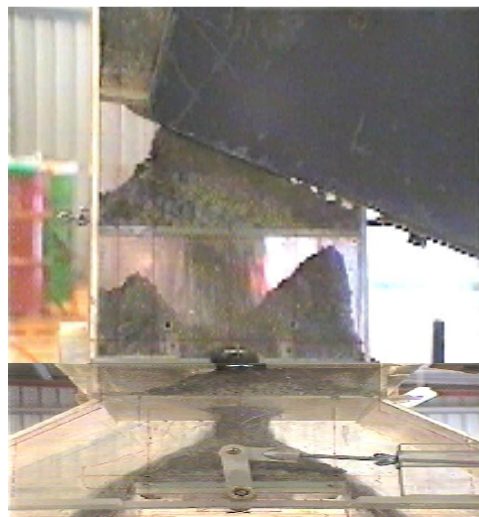

Weightometers

Schenck weightometers are used on CVR02, CVR03 and CVR04 to monitor the recirculating load back the secondary and tertiary crushers, and the feed rate to the product screen. A Ramsey weightometer is used on CVR06, being the crushing circuit's production totaliser.

The CVR02 weightometer is used as a control input for the operation of the PID loop controlling the diverging feeder speed. The CV04 and CVR04 weightometers are to provide information only for the operator.

Tramp Metal Detectors

CVR03 and CVR04 are both equipped with metal detectors, to protect the cone crushers from tramp steel. The Sanwest Scitronics 1088 model detector is designed specifically for applications where the ore is conductive, as the BIF material is at Sunrise Dam. These metal detectors are being successfully used at Placer Granny Smith, which is processing the same magnetic shale type ore as Sunrise Dam currently is, and will be.

The CVR03 metal detector when tripped, will cause the PLC system to run the CVR03 conveyor, until the location of the tramp detect is positioned near the head drum, and then trip the conveyor. This then allows for manual search and removal of the tramp from the belt.

The CVR04 metal detector however, when tripped will cause the CVR04 magnet at the head drum to ramp to full flux (or power), and then ramp back to normal low flux. This should cause the tramp material detected, to be removed from the conveyor by the magnet as the ore is discharged into the CVR04 head chute.



Tramp Metal Magnets

Two magnets are installed within the crushing circuit, being at the CVR01 head chute (operating at full flux at all times) and at the CVR04 head chute (operating at full flux only when the CVR04 metal detector trips).

A tramp metal discharge chute is incorporated into the structure to allow safe cleaning of the magnet and transport of the metal to the ground level. The lid on the metal bin below must be kept closed at all time, to ensure the metal is well contained when it enters the bin from the chute.

Dust Control

Two bag-house type dust collectors are available, with one positioned adjacent the screening building and the other adjacent the cone crushers. Extraction ducting extends from the transfer points on the conveyors and from the product screen and chutes.

The dust collected from both bag-houses is dumped into hoppers and pumped from a common hopper back to the secondary cyclone feed hopper in the milling circuit.

Insertable dust collectors are installed at the remote conveyor transfer points that were too far from the bag-house system, being CVR06 head end, CVR07 skirting, CVR09 head chute and CVR10 skirting. An insertable extraction system is installed on the Fine Ore Bin. Essentially the insertable dust extractors are self-contained extraction systems, which periodically dump the dust collected back onto the receiving belt.

Two-stage skirting is installed on the conveyors, which has shown in the industry to be effective in controlling dust at the conveyor loading areas. This skirting needs to be occasionally monitored (while the plant is running loaded with ore) and adjusted accordingly to be effective.

Water sprays are installed at the crusher feed chute areas, on the ROM bin, and on the emergency feeder.

Control & Operating Philosophy

Control & Operating Philosophy Aim

The overall aim for the commissioning control philosophy is to provide a crushing plant that should operate without a significant level of operator attention while the plant is operating at approximately the design throughput of 500-550 tph. This is important initially with the added responsibility of maintaining a clear static ROM bin grizzly using the remotely controlled and operated rock breaker.

This initial control strategy is not aimed at maximising plant throughput or maximising efficiency (though the power efficiency should still be reasonable). These optimisation control strategies will be added to the circuit in the medium term future, once the bottlenecks and behaviour of the circuit is understood, and staff become more confident with the plant.

This strategy should not hinder the overall site production rates, as it is likely that the grinding circuit will be the component dictating production levels. The crushing plant will merely supply the grinding circuit with sufficient feed that it requires.

Start/stopping of the cone crusher feeders will be minimised to attempt to generate a stable and consistent flow of material over screens and into surge bins. Further, the need to manage tertiary crusher bin levels using the tertiary splitter will not be required, and this should not form an essential part of the basic control philosophy. Again experience with the splitter plate's ore distribution behaviour is needed before trying to incorporate it within a control loop.

General Operating/Control Description

With the circuit empty, the operator will manually start all the equipment and conveyors. With the empty surge bins, the cone crusher feeders will be off.

Once the equipment is running, feed to the primary crusher can commence, by manually starting the plate feeder. This should be set to achieve around the desired plant throughput (500-550 tph).

As the primary crushed material moves through the circuit, the cone crusher surge bins will begin to fill. As they reach a minimum pre-set level, the feeders into the cone crushers will start at the minimum feed rate. If set to AUTO, the feeder rates will automatically change to maintain operating pre-set levels within the three surge bin levels.

Material at +45mm will report to the secondary crusher surge bin, and that within the range 12-45mm will report to the tertiary crusher surge bins.

The cone crusher gaps will be manually set and adjusted by the operator, with the aim to roughly balance the power on all three crushers. The gaps on the two tertiary crushers should normally be kept identical. Adjustments to the gap should be very infrequent, and required only to counteract liner wear.

CSS adjustments can be made in increments of 1mm from the Citect control screen. Gaps should not be too tight as to cause the crushers to ring-bounce or draw excessive power when the crushing chamber is full (choke fed). In turn, the maximum output level should not be set too high as to cause the crushing chamber to rapidly overfill.

Plate Feeder FDP-01

- Primary crusher plate feeder FDP-01 is operated in manual - the operator will manually target around the required design 500-550 tph based on the final conveyor CVR06 weightometer readout.
- The plate feeder is interlocked with FOB level at the Hi-Hi level. This shuts feed off to the crusher when the fine ore bin level gets too high.
- The plate feeder is interlocked with the jaw crusher blocked chute sensor with an auto-restart if the blocked chute sensor shows a clear signal within a set time period.
- The plate feeder is interlocked with all cone crusher surge bin levels at the Hi-Hi level.
- The plate feeder is interlocked with the screen, all feeders, crushers, conveyors, in the event of one of them tripping.

Jaw Crusher Discharge Vibrating Feeder FDV-01

- This operates at a fixed maximum speed, to ensure the chamber underneath the vibrating grizzly and primary crusher remains clear.
- If this feeder stops due to a trip, the plate feeder and grizzly feeder will stop.

Secondary Crusher Surge Bin BIN-02

- Secondary crusher surge bin level is controlled by PID control (Proportional, Integral and Derivative type of control) loop by adjusting the CRC-02 vibrating feeder FDV-03 speed. The bin is controlled to the nominated bin operating level or set point.
- Operators can adjust the maximum and minimum outputs for the feeder speed. The maximum output set point should be set roughly where the crusher cavity will slowly fill. The minimum output set point is roughly where the crusher will draw about 250kW which is the minimum load that Nordberg recommend while the crushers are being fed.
- The feeder will stop at Lo-Lo bin level to avoid the bin emptying completely, thus avoiding damage to FDV-03 when feed resumes into the bin. To run the bin out completely for maintenance, the feeder must be in manual.
- At the bin Lo level, if stopped (for example due to a lo-lo level trip), the feeder will restart automatically at the minimum feeder output set point.
- At the bin Hi level, an alarm will sound to warn the operator that the bin is being overfed.
- At the bin Hi-Hi level, another alarm will sound and the plate feeder will be stopped. This will need to be manually restarted.
- At the bin Hi-Hi-Hi level (which is just before the bin begins to overflow), CVR03 will trip which will cause the front-end of the plant to shutdown, including CVR01, CVR02 and all feeders. The plant will then have to be manually runout, with the knowledge that chutes, bins and conveyors may overflow causing risk to employees walking around the crushing plant at that time.
- The CRC-02 feeder FDV-03 will be interlocked as stop/start with the crushing chamber level for the case of extreme level circumstances. At Hi-Hi chamber level (chamber nearly overflowing), FDV-03 should automatically stop. Automatic restart is at a lower pre-set level if the auto-control loop is still selected.

Secondary Crusher CRC-02

- CRC-02 CSS or gap set point is manually set and adjusted by the operator with the aim to roughly balance the power of the secondary crusher with that of the tertiaries.
- The tightest gap possible with the coarse liner configuration is 30mm.
- The PLC processes the required steps to carry out this task, including disabling and re-enabling appropriate control loops.
- CRC-02 Power and vibration monitoring causes alarms if either is exceeds pre-determined levels for a set period of time. This is to protect the crusher from structural damage.
- The crusher gap should be re-calibrated on a daily basis, using the metal-to-metal calibration technique.

Tertiary Crusher Surge Bins BIN-10 & BIN-11

- The tertiary crusher surge bin levels are controlled by PID loops by adjusting independently the CRC-03 & CRC-04 vibrating feeder FDV-04 & FDV-05 speeds. The bins are controlled to the nominated bin operating levels or set points.
- Operators can adjust the maximum and minimum outputs for either feeder speeds. The maximum output set points should be set roughly where the crusher cavity will slowly fill. The minimum output set point is roughly where the crusher will draw about 250kW which is the minimum load that Nordberg recommend while the crushers are being fed with rock.
- The feeders will stop at Lo-Lo bin level to avoid the bin emptying completely, thus avoiding damage to FDV-04 & FDV-05 when feed resumes into the bin. To run the bin out completely for maintenance, the feeder(s) must be in manual.
- At the bin Lo level, if stopped (for example due to a lo-lo level trip), the feeder on the corresponding bin will restart automatically at the minimum feeder output set point.
- At the bin Hi level, an alarm will sound to warn the operator that the bin is being overfed.
- At the bin Hi-Hi level, another alarm will sound and the primary crusher plate feeder will be stopped. This will need to be manually restarted.
- At the bin Hi-Hi-Hi level (which is just before the bin begins to overflow), CVR04 will trip which will cause the front-end of the plant to shutdown, including CVR01, CVR02 and all feeders. The plant will then have to be manually runout, with the knowledge that chutes, bins and conveyors may overflow causing risk to employees walking around the crushing plant at that time.
- The CRC-03 and CRC-04 feeders will be interlocked as stop/start with the crushing chamber level for the case of extreme level circumstances. At Hi-Hi chamber level (chamber nearly overflowing), the relevant feeder should automatically stop. Automatic restart is at a lower pre-set level if the auto-control loop is still selected.
- The Tertiary Splitter location is controlled manually and should be operated in the horizontal position. However, during gap adjustments the splitter plate position should alter automatically to a pre-set level, to allow feed to be preferentially fed to the operating bin while the adjustment is taking place. Gap adjustments should not be carried out when the bin levels are high.

Tertiary Crushers, CRC-03 and CRC-04

- CSS or gap set points are manually set and adjusted by the operator with the aim to roughly balance the power of the secondary crusher with that of the tertiaries. The tertiaries should operate with identical gap sizes.
- The tightest gap possible with the short-head medium liner configuration is 10mm.
- The PLC processes the required steps to carry out the gap adjustment, including disabling and re-enabling appropriate control loops, and altering the splitter plate position.
- Tertiary crusher power and vibration monitoring causes alarms if either exceeds pre-determined levels for a set period of time. This is to protect the crusher from structural damage.
- The crusher gaps should be re-calibrated on a daily basis, using the metal-to-metal calibration technique.

Screen Diverging Feeder FDV-02

- This operates with a ratio-based control loop based on the CVR02 weightometer reading. The ratio value required is determined from operating experience.
- As there is no level indication within the chute above the feeder, it is required to set this ratio relatively high to ensure a build-up does not occur. The chute above is fitted with blocked chute detection, but activation of this detector leads to conveyor trips.

Other Process Control Points

- No pre-set plant start-up or shutdown automatic sequences are available. This must be conducted manually based on written instruction provided. Start-up and shutdown sequences will be added later.
- All trip shutdown sequences avoid leaving chutes or chambers full of material where possible, for example, CVR03 and CVR04 will run out into the surge bins, to avoid screen chute blockage where possible.
- Metal detects associated with CVR03 results in the belt being run to the top area of the conveyor to allow manual removal of the offending object.
- Metal detects associated with CVR04 results in the CVR04 magnet being ramped to full flux for a timed period, and then returned to low flux.
- A large number of interlocks are programmed into the PLC system, to protect the plant from a multitude of different problems. The operator can easily determine why a particular piece of equipment will not start, with the Citect system listing the interlocks and condition of those interlocks, with each piece of equipment.

CRUSHING
