



SHEERWATERGLASS

Slimline Windows & Doors



Contents

Contents of Brochure	p 2
Key Features	p 3
Tailor Your Windows	p 6
A Choice of Colour	p 7
Ultimate Resistance	p 8
Hardware Options	p 9
Decorative Glass	p 10
Security	p 11
Slimline System	p 12
About Us	p 13

Our Slimline system has been developed for maximum light intake with less uPVC frame and more glass, providing increased natural light.

Through our impressive design, we were able to create our exclusive Slimline range – which gifts you a thinner proportion of frame and glass for your windows and doors.

This sleek window and door style is ideal for both modern and traditional properties. Depending on the style and size, as much as 12% more light can be gained through our Slimline windows, compared to other typical uPVC systems.

Our engineered Slimline windows and doors are designed to fit with any typical British home. The aesthetic design ensures that your windows and doors will enhance the look of your property, rather than detract from its overall appearance.



Key Features

Energy Efficient

Our Slimline windows are **extremely energy efficient**, and have been awarded an energy index rating of 'A+'.

Its impressive energy rating guarantees that your home stays warm and dry all year round, and in the process, helps to cut the cost of your household bills.

Exceptionally Safe

We source and install the highest quality products and materials, giving you that peace of mind that your home and family are safe and secure. We never cut corners, and we do not compromise on safety when it comes to our exclusive Slimline window range.

Bespoke Design

As with every project we undertake, our team of glass and glazing experts are on hand to help you design a bespoke window to suit your property's style. We can tailor your new Slimline windows to create either a modern or established look. Our exclusive Slimline windows are also available in a whole range of colours to suit any property.







Tailor Your Windows

A key benefit to our Slimline windows is that we can tailor your new windows to suit your taste and your home's character.

Our team of experts will support you through the entire process; from the design to installing your custom windows and doors.

Design

Tailor your new Slimline windows to create a flawless and contemporary look. Our exclusive Slimline windows are available in a range of colours to suit any property, whether it's modern or traditional.

Glazing Options

You will have a selection of glazing options for your windows, including Georgian bars, lead patterns and coloured leads. For your added privacy, we also offer 18 textured glass designs.

Range of Styles

We offer a wide range of finishes for our Slimline windows range, assuring you get the perfect design and style to fit your home.



A Choice of Colours

 <p>Agate Grey</p>	 <p>An Teak</p>	 <p>Anthracite Grey</p>	 <p>Basalt Grey</p>	 <p>Brilliant Blue</p>	 <p>Chartwell Green</p>	 <p>Cream</p>
 <p>Dark Green</p>	 <p>Dark Oak</p>	 <p>Dark Red</p>	 <p>Golden Oak</p>	 <p>Haze Grey</p>	 <p>Irish Oak</p>	 <p>Mahogany</p>
 <p>Natural Oak</p>	 <p>Rosewood</p>	 <p>Rustic Oak</p>	 <p>Sienna</p>	 <p>Signal Grey</p>	 <p>Slate Grey</p>	 <p>Steel Blue</p>
 <p>Slate Grey Finesse</p>	 <p>Swamp Oak</p>	 <p>Walnut</p>	 <p>White</p>	 <p>Black Brown</p>	 <p>Light Oak</p>	 <p>White Woodgrain</p>

Weather Resistance

Your new Slimline windows or doors will be completely **draught proof** and **watertight**.

The Slimline profile is produced with all weather bubble gaskets (seals), fused to both the inner and outer frame section.

The bubble gaskets are hollow and offer greater compression and remain in-line with the profile for a neater appearance. They are fused to the profile, which means they can never shrink back, reducing the chance of leaks or unpleasant draughts in your home.

Integral Drainage

To enhance the weather resistance further, our Slimline system is installed with a purposely built drainage system. This directs any water penetration away and towards the external drainage route.

Quality Assurance

Naturally, you want to be assured that the quality of the installation will match the quality of the products. As a FENSA registered company, we work within an agreed code of practice, which includes a full understanding of the building regulations and the other FENSA requirements.

Prior to your installation, a full and accurate survey will be carried out. Our survey will ensure that your desired style of window or door will combine effectively with your home.

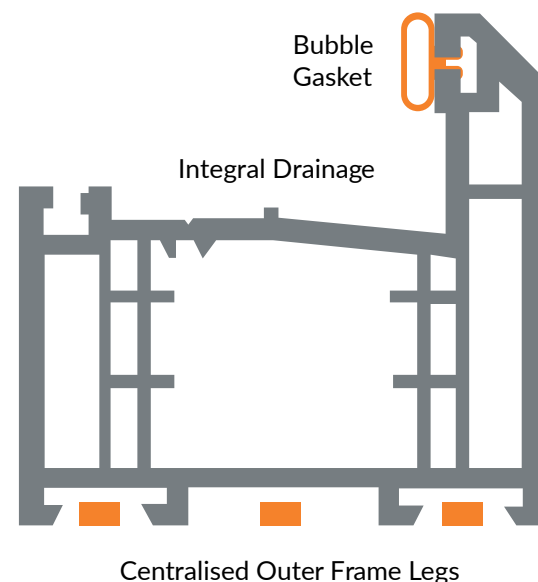
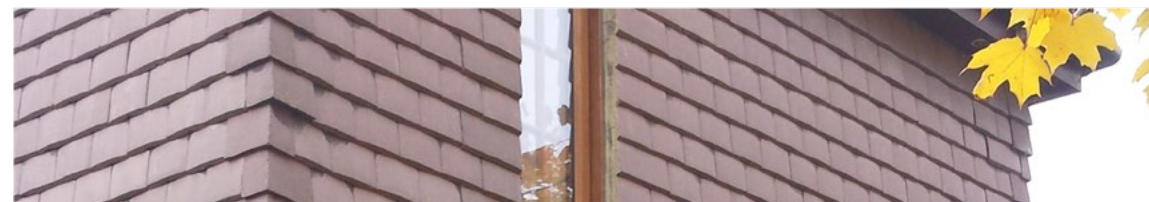
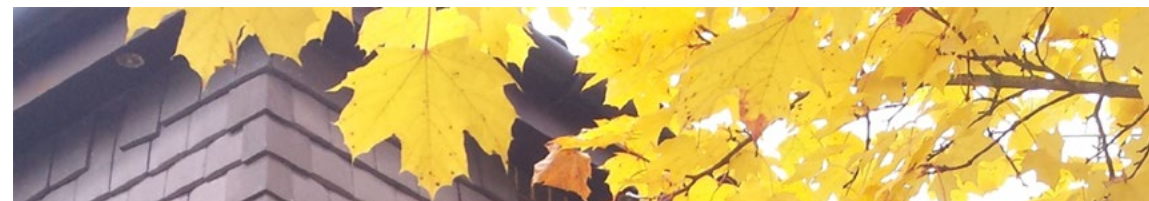

Hardware Options



Standard Handle

Connoisseur Inline Locking Window Handle

The Connoisseur Inline has a classic design in a variety of colours, with a contemporary twist to create an elegant and stylish window handle for an espagnolette window lock.



Monkey Tail



Monkey Tail Dummy Window Stay Bar



Monkey Tail Operating Window Stay Bar



Monkey Tail Window Handle

Tear Drop



Tear Drop Dummy Window Stay Bar



Tear Drop Operating Window Stay Bar



Tear Drop Window Handle

Leaded Bars & Astragal Bars

Whether you live in a traditional property or you appreciate the decorative features on an older style of window, you may be interested in our three decorative glass options.

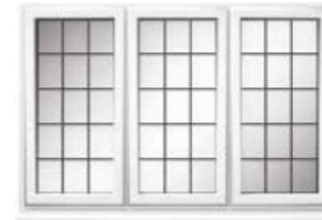

Square Leaded



Diamond Leaded



Internal Georgian Bars



External Georgian Bars



Equals Slightlines



Unequal Slightlines

DOORS

Min welded midrail width is 245mm
 Min welded midrail width, with letterbox, is 430
 Maximum door sash height is 2275 (Finished size)
 Minimum offset french door sash size is 375mm
 Sfs hinge clearance is 13mm
 Standard door knockers are 75mm wide
 Slim urn knockers are 55mm

WINDOWS

Maximum side hung sash height is 1475mm
 Minimum side hung sash width is 375mm
 Minimum transom drop for a top hung sash is 320mm
 Minimum width for top hung opener is 270 (requires offset handle)
 Maximum side hung sash size (with mega egress hinge) is 1000 x 1200mm
 Maximum width of a top hung fan light is 1200mm

Our Decorative Glass

Decorative Glass enables you to add style and elegance to your home incorporating a range of options.

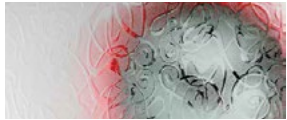

Everglade



Pelerine

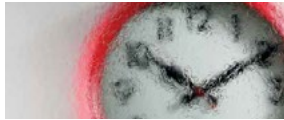

Oak

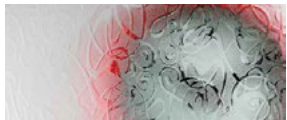

Charcoal Sticks



Contora



Taffeta



Chantilly



Warwick



Mayflower



Digital



Florielle



Reeded

Our Replacement Range

If you need replacement glass to match an existing design, don't worry, the following well-established designs are still available.



Cotswold



Arctic



Stippolyte



Autumn



Minster



Sycamore



Flemish

Privacy Levels

You can choose from a range of 19 designs from traditional to contemporary. The range offers 5 privacy levels to suit your needs.



Privacy Level 1



Privacy Level 2

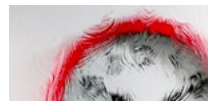

Privacy Level 3



Privacy Level 4



Privacy Level 5



Security Details

Optimised Security

Security is of great importance to you, your home and your family. You can be confident that our Slimline products provide maximum security.

Shootbolt Locking System

Our Slimline windows are fitted with a **Shootbolt Locking System**, which utilises a Shootbolt Espagnolette gearbox; this is manufactured from ferritic stainless steel. It's so secure that the locking mechanism has been rigorously tested and achieved a BS7950 status.

Security Glazing

It is essential that your unit remains in dry conditions. The Slimline system has a unique glazing packer that is sprung in place for the glazed unit to sit on; creating a bridge between the sealed unit and any water or dampness. This is what prevents condensation forming inside the unit.



Shootbolt Locking System



Our Slimline System

The Intelligent Window and Door System

Whilst all the profiles remain technically the same, the Slimline system offers a choice of **Bevelled** or **Ovolo** beading, depending on your preference.

Slender Design & Clean Lines

The windows were designed to be symmetrical - with respect to all flat surfaces being similar in width. This ensures that the window is much slimmer and is more aesthetically pleasing on your home.

Slimline Surpasses Energy Standards

The minimum Window Energy Rating (WER) required for all windows - in accordance with current legislation - at this time is a 'C'. Each WER rating (A, B & C) has varying degrees of standards, and our Slimline windows were awarded 'A+', making them extremely efficient.

These variances are highlighted by testing authorities, who provide tested windows with an Energy Index. The higher the Energy Index number, the more efficient the window is at retaining generated heat.

Top grade uPVC

The European committee standards state that uPVC must have the highest category (CAT A) outside wall thickness of 2.8mm - the Slimline system is 3mm. Together with 5 chambers, it offers superb frame strength and rigidity that will last for years.



Ovolo Bead
(Curved Profile)



Bevelled Bead
(Flat Profile)

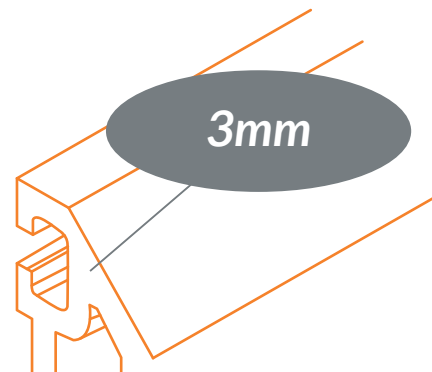

About Us



Areas we cover

Kingston Upon Thames, Farnham, Cranleigh, Godalming, Chertsey, Esher, Cobham, Byfleet, Weybridge, Camberley, Guildford, Woking

Time, Care & Attention

We take great time, care and attention in sourcing the latest product technology. This is to ensure that the windows we supply and install for our customers are the best on the market.

We're so confident that you'll be satisfied with your new window from Sheerwater Glass that we offer a full installation guarantee: **we're not happy until you are!**

Contact our team

Sheerwater Glass are professional window installers and suppliers in Surrey, offering an extensive range of high-quality windows throughout Woking and the surrounding areas. Over the past 40 years, we have built a firm reputation for our trustworthy and reliable window & door services.

Call Us: 01932 344 415

Email the Team: info@sheerwaterglass.co.uk

One of our friendly staff will be able to assist you.



SHEERWATERGLASS

Sheerwater Glass
23-27 Dartmouth Ave,
Woking,
Surrey,
GU21 5PE

July 2018 UK £3.99

