

# Allegro

## Rotary Screw Compressors

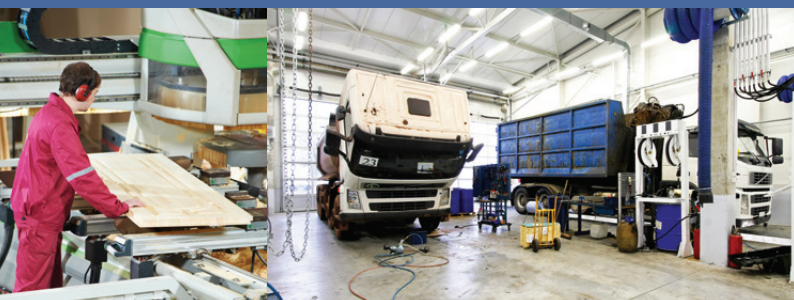
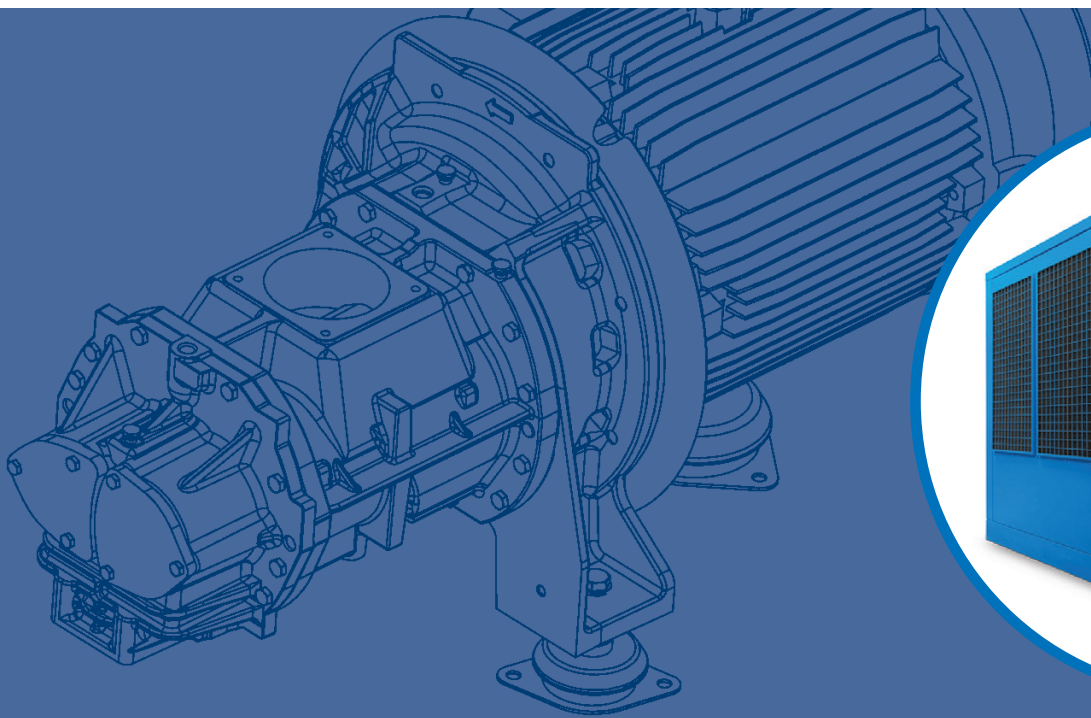

ALLEGRO 132-250 D

**ALUP**  
Kompressoren



## ALUP's heritage

Founded in Germany in 1923, the company derives its name of the automotive products that were manufactured in the Köngen' mechanical workshop where ALUP came into existence: Auto-LUft-Pumpen. Only two years later, the first range of piston compressors was being developed, whilst in 1980 rotary screw compressors were added to the product offer.

Over time, experience grew and innovation prospered, leading to today's high quality product portfolio. As such, the name ALUP Kompressoren has become synonymous with innovative technology blended with a strong sense of tradition. Today, ALUP Kompressoren is still operating out of its home town Köngen, where everything started in 1923.



## Driven by technology Designed by experience

Discover what happens when a passion for technology is fused with hands-on industrial experience. Designs evolve towards more practical installation and maintenance, giving you the freedom to focus on your job. Product ranges include the exact machine you need, with the right options for your performance needs. Return on investment is ensured, while your carbon footprint shrinks. And, because we stay close to our customers, we're one step ahead when your needs change.

**INNOVATION  
HANDS-ON  
EXPERIENCE  
PEACE OF MIND  
TOTAL COST  
OF OWNERSHIP  
PARTNERSHIP**

## The power of the Allegro range

*The Allegro 132-250 D screw compressors provide high-quality compressed air for a wide range of industrial applications.*

### Superior efficiency

- In-house design compression elements.
- Direct drive transmission.
- High-efficiency radial cooling fan.
- Premium efficiency motor.



### Intelligent control

- Air Control 5.1 full-colour 3.5 inch HD screen.
- Intelligent unload cycle control.
- Precise pressure control.
- Warning indications.
- Graphical indication service plan.
- Additional communication possibilities.



### Ultimate reliability and serviceability

- Extensive service support.
- Designed for harsh conditions and ambient temperatures up to 46°C.

# 10 reasons to choose Alup

Check out these innovative features and see how they provide you with a compressor that is highly efficient, quiet and easy to maintain.



## 1. Element and drive train

- Direct driven technology eliminating all transmission losses.

## 2. High efficiency motors

- Premium efficiency motor.
- IP55, insulation Class.

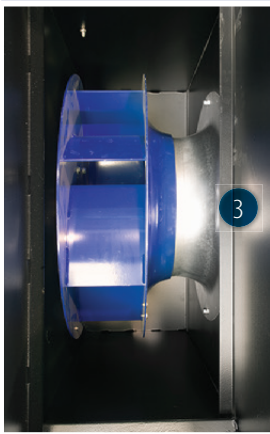

## 3. Radial fan

- Low power consumption & reduced noise levels.
- Optimal cooling flow.
- Increased lifetime of oil, consumables and compressor.

## 4. Standard enclosed intake filter

- Improved FAD due to air intake positioning.
- High-quality filtration to maximize oil quality and protect your compression element.
- Low noise levels thanks to design and position of filter.

## 5. Intelligent controller

- The full-colour graphic control of the Air Control 5.1 offers a user-friendly interface to access all the compressor parameters, service notifications and events.
- The various control modes and intelligent algorithms allow the compressor to automatically adapt to demand changes.



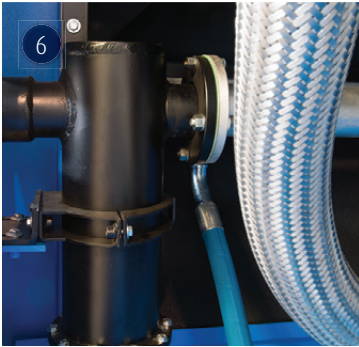

## 6. Water separator drain

Water separator drain as standard to remove excess water and improve air quality.



## 7. In-house designed oil separator vessel

- Integrated minimum pressure valve (MPV) eliminates risk of leakage.
- Long lifetime thanks to cast iron parts.
- Designed for optimal oil separation.

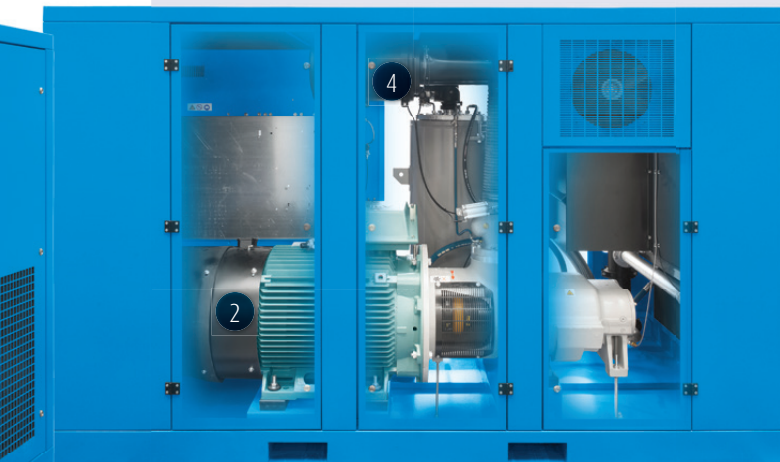

## 8. Separate inverter cubicle

- Optimal cooling ensures a longer lifetime.
- Easy access for maintenance and cleaning.

## 9. Separate coolers

- Separate oil and air cooler for high-quality cooling, high reliability and longer lifetime.
- Easy access for cleaning.

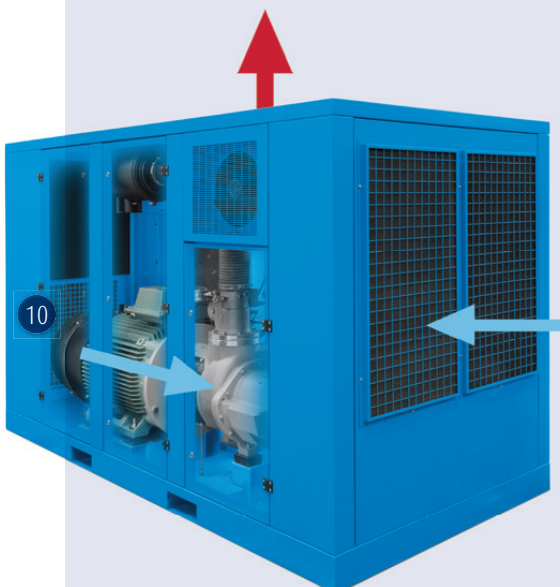

## 10. Improved motor cooling

- Separate cooling flow.
- Suitable for harsh conditions and temperatures up to 46°C.

# Optimize your energy consumption

*Did you know that energy costs represent about 70% of the total operating cost of your compressor over a 5-year period? That's why reducing the energy consumption of your compressed air installation should be a major focus.*

## Variable speed technology

For the right application, variable speed technology, such as on the Allegro variable frequency drive compressor, can cut the energy bill of your compressor by up to 35%. The Allegro reduces energy consumption in the following ways:

- The variable frequency drive compressor matches air supply with demand therefore reducing energy consumption when the demand is lower. If the demand is stable then the Air Control 5.1 guarantees a fixed set pressure.
- No unload cycles above 20% load.
- No peak current due to soft start.

## Energy recovery

*When air is compressed, heat is formed. The excess heat can be captured with an energy recovery option and channeled to other applications allowing you to save energy and cut costs. The energy recovery option integrates a heat exchanger on the oil circuit, which heats up the continuously pressurized water flow. The system is regulated automatically, and in case of limited water cooling capacity, the standard cooling system of the compressor will operate and back up the energy recovery device.*

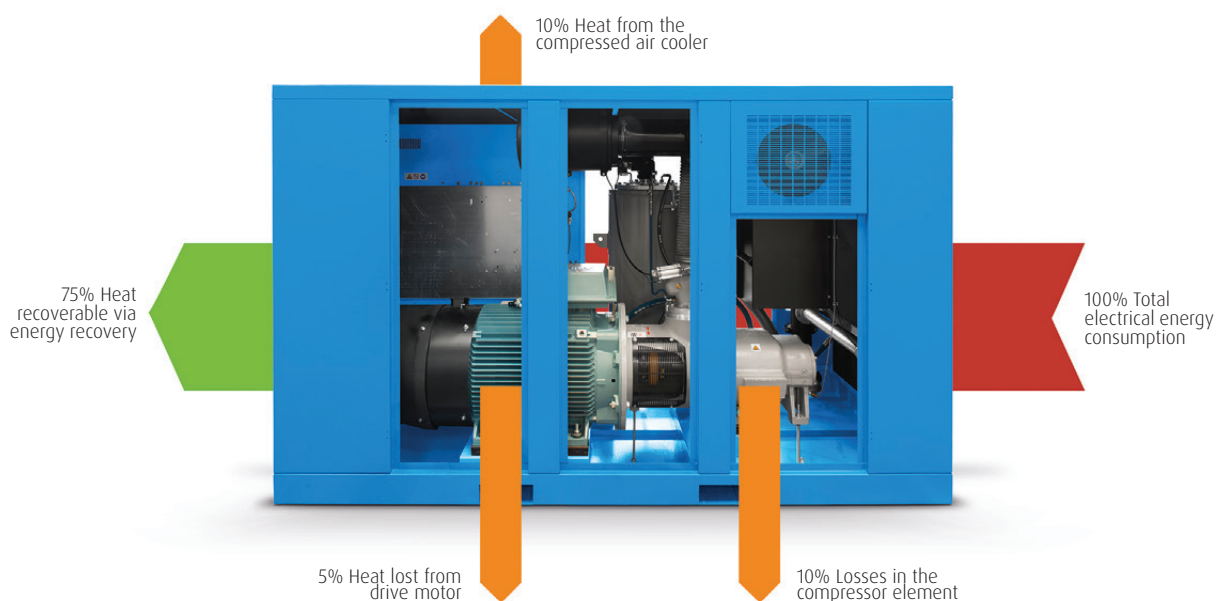

## Technical data

Inverter driven version	Working pressure	Min. Free air delivery (7 bar)*			Max. free air delivery											
		7	7	7	7	7	7	8	8	8	9.5	9.5	9.5	10	10	10
Model	bar	m <sup>3</sup> /h	l/s	cfm	m <sup>3</sup> /h	l/s	cfm	m <sup>3</sup> /h	l/s	cfm	m <sup>3</sup> /h	l/s	cfm	m <sup>3</sup> /h	l/s	cfm
<b>Allegro 132 D</b>	4-10	410	114	242	1476	410	870	1411	392	832	1318	366	777	1278	355	754
<b>Allegro 160 D</b>	4-10	443	123	261	1775	493	1047	1678	466	989	1530	425	902	1483	412	875
<b>Allegro 200 D</b>	4-8	580	161	342	2160	600	1274	2160	600	1274	NA	NA	NA	NA	NA	NA
<b>Allegro 200 D</b>	4-10	515	143	304	1915	532	1129	1915	532	1129	1915	532	1129	1858	516	1095
<b>Allegro 250 D</b>	4-8	698	194	412	2700	750	1592	2700	750	1592	NA	NA	NA	NA	NA	NA
<b>Allegro 250 D</b>	4-10	587	163	346	2347	652	1384	2347	652	1384	2347	652	1384	2279	633	1344

Model	Motor power		Noise level**	Cooling air volume	Weight	Compressed air output diameter
	kW	hp	dB(A)	m <sup>3</sup> /h	kg	"
<b>Allegro 132 D</b>	132	180	78	22000	3545	DN 65
<b>Allegro 160 D</b>	160	220	78	22000	3650	DN 65
<b>Allegro 200 D</b>	200	270	78	28000	5600	DN 65
<b>Allegro 250 D</b>	250	340	78	28000	6100	DN 65

\*Unit performance measured according to ISO 1217, Annex C, latest edition.

All technical data for air-cooled machines without integrated dryer. For technical data of water-cooled machines, please contact your local salesforce.



	Length	Width	Height
Model	mm	mm	mm
<b>Allegro 132 D</b>	3230	1650	2040
<b>Allegro 160 D</b>	3230	1650	2040
<b>Allegro 200 D</b>	4000	2100	2500
<b>Allegro 250 D</b>	4000	2100	2500



DRIVEN BY TECHNOLOGY DESIGNED BY EXPERIENCE



CONTACT YOUR LOCAL  
ALUP REPRESENTATIVE

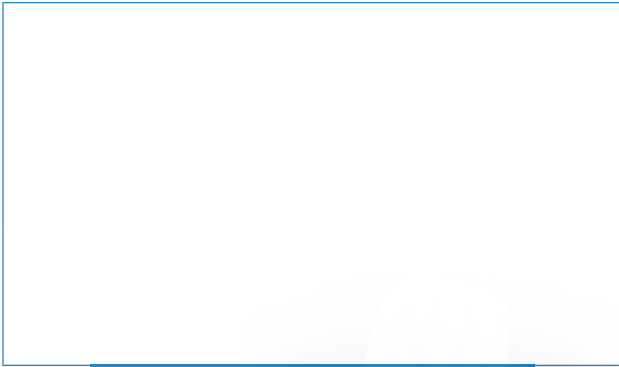

Care. Trust. Efficiency.

**Care.**

Care is what service is all about: professional service by knowledgeable people, using high-quality original parts.

**Trust.**

Trust is earned by delivering on our promises of reliable, uninterrupted performance and long equipment lifetime.

**Efficiency.**

Equipment efficiency is ensured by regular maintenance. Efficiency of the service organization is how Original Parts and Service make the difference.

