



Additional load resistance tests for Stonel brick surfaced external cladding panel system according to ETAG 034

Requested by: Stonel Oy

Requested by Stonel Oy
Ahlmaninkatu 2 E
40100 Jyväskylä

Order 22.11.2012 e-mail J. Katainen (VTT-O-138050-12)

Contact person **VTT Expert Services Ltd**
Pekka Sipari
Senior Expert
P.O. BOX , 1001, FI-02044 VTT Finland
Tel. +358 20 722 6931
Fax +358 20 722 7003
Email pekka.sipari(at)vtt.fi

Assignment **Additional load resistance tests for Stonel brick surfaced external cladding panel system according to ETAG 034**

Tests Stonel brick surfaced external cladding panel system belongs into categorised group G presented in ETAG 034. To enable the proper design of the structure and to verify the load capacity of the fixing parts of the Stonel Cladding Panel System mechanical tests according to ETAG 034 were carried out in addition to wind load resistance test (Test Report VTT-S-08072-12). The tests carried out were as follows:

- horizontal load capacity of vertical fixing rails
- vertical load capacity (down wards)
- horizontal load capacity of horizontal fixing rails
- load capacity for combined horizontal and downward loads
- bending strength of the brick cladding in both directions

The tests were carried out at research hall of VTT Expert Services Ltd in the address Tekniikantie 15 A, 02150 Espoo. The test dates were:

- 6.2. 2013 horizontal load tests of vertical rail
- 14 - 17.12. 2012 vertical load tests of system
- 27 - 28.2.2013 horizontal load tests of horizontal rail
- 25 - 26.2. 2013 combined load test (with angle 30° from horizontal)
- 12 - 13.12. 2012 bending strength tests

The tested fixing parts are presented in Appendix 6

Test arrangements Horizontal load tests of vertical rail
Six tests were carried out by loading the vertical rail from the fixing point used for screw fixing of the horizontal rails. The location of the loading point was 70 – 130 mm from the screws used to fix the vertical rail to substrate. Six tests were also carried out with loosen screws. The load was increased slowly directly

The test results relate only to the sample tested.

to the failure, and during the loading the failure behaviour of the rail was visually surveyed. The deflection was recorded, as well.

The test arrangements are shown in photos in Appendix 1.

Horizontal load tests of horizontal rail

Six tests were carried out by loading the horizontal rail with concentrating the load to the fixing point of the horizontal rails. The location of fixing points of horizontal rails was 110 mm from the screws used to fix the vertical rail to substrate. The load was first increased three times slowly to estimated service load of 1.4 kN and after that directly to the failure. During the loading the failure behaviour of the rail was visually surveyed. The deflections were recorded, as well.

The test arrangements are shown in photos in Appendix 2.

Load tests for combined horizontal and vertical load

The load tests for combined load were carried out on specimens, which were in principle similar to those used for horizontal loading of horizontal rails. Only three tests were done using loading angle 30°, since the loading case was not critical.

The load was first increased once slowly to estimated service load of about 1.4 kN and after that directly to the failure. During the loading the failure behaviour of the rail was visually surveyed. The downward and horizontal deflection/displacements were recorded during the test.

The test arrangements are shown in photos in Appendix 3.

Vertical load tests of system

Six tensile tests were carried out by loading the brick panel rail downwards from the upper edge of one brick panel (size 1200 mm x 600 mm). The brick panel was installed to one horizontal rail. The horizontal rail was fixed into two vertical rails spaced c 600 mm in the middle height of the fixing points of the vertical rails.

The load was increased slowly directly to failure, and during the loading the failure behaviour of the rail was visually surveyed. The downward deflection was recorded, as well.

The test arrangements are shown in photos in Appendix 4.

Bending test of cladding panel

Six bending tests were carried out in both main directions of the panel using specimens of size 300 mm x 600 mm. The specimens were loaded with so called four point loading (linear loads in third points of the span of 540 mm).

The test arrangements are shown in photos in Appendix 5.

Results

Horizontal load tests of vertical rail

With tightened screws the permanent deflection was noticed to begin at loads 1.5 to 1.7 kN. The final failure loads varied from 1.8 to 3.2 kN (depending on the

The test results relate only to the sample tested.

distance from the nearest fixing screw). The average of the failure load was 2.49 kN and standard deviation was 0.53 kN. Using material safety factor 0.9 for steel rail the design horizontal load capacity is $0.9 \cdot (2.49 - 2.18 \cdot 0.53) = 1.20$ kN /fixing point. That makes $1.2/0.36 = 3.3$ kN/m² (fixing points in 0.6 m x 0.6 m mesh). Failure mode was mainly buckling of the web of the rail.

With non-tightened screws the permanent deflection was noticed to begin at loads 0.8 to 1.2 kN. The final failure loads varied from about 1.5 to 2.6 kN (depending on the distance from the nearest fixing screw). The average of the failure load was 2.03 kN and standard deviation was 0.44 kN. Accordingly, this makes design capacity $0.96/0.36 = 2.7$ kN/m². Failure mode was mainly buckling of the web of the rail and breakage of the rail at nearest fixing screw.

The individual test results and some photos of the failures are presented in Appendix 1.

Horizontal load tests of horizontal rail

Final failure load varied from 1.85 to 2.15 kN. The average of the failure load was 1.97 kN and standard deviation was 0.10 kN. Using material safety factor 0.9 for steel rail the design horizontal load capacity is $0.9 \cdot (1.97 - 2.18 \cdot 0.10) = 1.58$ kN / two fixing point. Which makes $1.58/2/0.36 = 2.2$ kN/m² (fixing points in 0.6 m x 0.6 m mesh). Failure mode was the deflection of the horizontal rail and finally the tongue fixing of the panel was loosening from horizontal rail. The permanent horizontal deflection after three times up to 1.4 kN was about 2.5 mm

The individual test results, some typical load-deflection curves and some photos of the failures are presented in Appendix 2.

Tests for combined horizontal and vertical load

Final failure loads were 2.36 kN, 2.74 kN and 2.79 kN. The average of the failure load was 2.63 kN. Failure mode was the deflection of the horizontal rail and finally the tongue fixing of the panel was loosening from horizontal rail.

The individual test results, some typical load-displacement curves and some photos of the failures are presented in Appendix 3.

Vertical load tests of system

In the load test the horizontal rails behaved very elastically in the vertical direction and the vertical displacement increased linearly up to over 20 mm before failure. The final failure occurred in the horizontal rails, and near failure load the rails were buckling and the horizontal displacement increased rapidly as may be seen in the load-displacement curves in Appendix 4. The final failure loads as estimated from the curves were 3.5, 4.2, 4.0, 3.7, 4.0 and 4.0 kN:s. The average of the failure load was 3.90 kN and standard deviation was 0.25 kN. Using material safety factor 0.9 for the horizontal steel rail the design vertical load capacity can be approximated to be $0.9 \cdot (3.9 - 2.18 \cdot 0.25) = 3.0$ kN /two fixing point. This makes about 4.2 kN/m² (fixing points in 0.6 m x 0.6 m mesh). In practice, the vertical

The test results relate only to the sample tested.

load is depending of the forced strains caused by temperature and moisture changes which may lead to a different vertical load from that of the balanced case depending of the height of the façade and the performance of the horisontal movement joints. In balanced case, the even distribution of the own weight causes vertical load of about 0.4 kN/m^2 . However, it can be approximated that vertical load in practice is not near the vertical load capacity even in the case of forced strains.

The individual test results are presented in Appendix 4.

Bending tests of cladding panel

Bending strengths in both directions were calculated using the average thickness of the brick panel measured from the brick surface. The individual values are presented in Appendix 5.

In vertical direction the average bending strength was 1.1 N/mm^2 and the standard deviation was 0.2 N/mm^2 . Thus, for the characteristic bending strength we get $(1.13 - 2.18 * 0.2) = 0.7 \text{ N/mm}^2$. For characteristic bending moment we get 38 N/m .

In horisontal direction the average bending strength was 5.1 N/mm^2 and the standard deviation was 0.34 N/mm^2 . Thus, for the characteristic bending strength we get $(5.1 - 2.18 * 0.34) = 4.3 \text{ N/mm}^2$. For characteristic bending moment we get 240 N/m .

When using bending strength or bending moment in design an appropriate partial material safety factor shall be used taking into account that although, the panel is brittle in nature, a steel plate is connected to backside of the panel, causing “ductile” fracture in the case of failure.

Summary

If only the steel rails are considered the most critical is the horisontal load capacity of horisontal rails and the tongue connection between the brick panel. The displacement at representative service loads can be approximated to be in acceptable limits. These conclusions are of course valid for with fixings in $600 \text{ mm} \times 600 \text{ mm}$ mesh and if the horisontal rails are fixed near the fixing plate ($70 \dots 130 \text{ mm}$ apart from the fixing screws of vertical rail).

Espoo, April 4, 2013



Mikko Nyman
Team Leader



Pekka Sipari
Senior Expert

VTT Expert Services Ltd. is a Notified Body No. 0809

The test results relate only to the sample tested.

Reference	/1/ ETAG 034, Edition April 2012. Guideline for European technical Approval of Kits for external Wall Claddings, Part I: Ventilated Cladding Kits comprising Cladding Components and associated Fixings	
Appendices	Appendix 1. Test results of horisontal load tests of vertical rail	
	Appendix 2. Test results of horisontal load tests of horisontal rail	
	Appendix 3. Test results of combined horisontal and vertical load tests	
	Appendix 4. Test results of vertical load tests of system	
	Appendix 5. Test results of bending tests	
	Appendix 6. Tested fixing parts	
Distribution	Customer	Original
	Archive	Original

The test results relate only to the sample tested.

STONEL BRICK SURFACED EXTERNAL CLADDING PANEL SYSTEM:

Results of horizontal load tests of vertical rails

Load tests of vertical rails

	Specimen	Fmax kN	Distance* mm	Failure mode
Tightened screws	K1	2,86	90	Buckling of rail
	K2	1,76	131	Buckling of rail
	K3	2,07	111	Buckling of rail
	K4	2,92	71	Buckling and breakage**
	K5	3,21	71	Buckling of rail
	K6	2,11	110	Buckling of rail
	Average	2,49		
	St. Dev.	0,53		
	Charac.	1,33		
	Design	1,20		
Screw loosen	L1	1,54	131	Buckling and breakage**
	L2	2,38	91	Buckling and breakage**
	L3	2,64	71	Buckling and breakage**
	L4	1,74	110	Buckling and breakage**
	L5	1,53	130	Buckling and breakage**
	L6	2,36	91	Buckling and breakage**
	Average	2,03		
	St. Dev.	0,44		
	Charac.	1,07		
	Design	0,96		

Characteristic value= Average - 2,18*St.dev

Design value= characteristic value*0.9

* Distance from fixing screw of vertical rail/substrate fixing plate

** Buckling of web of rail and breakage beneath screw

The test results relate only to the sample tested.

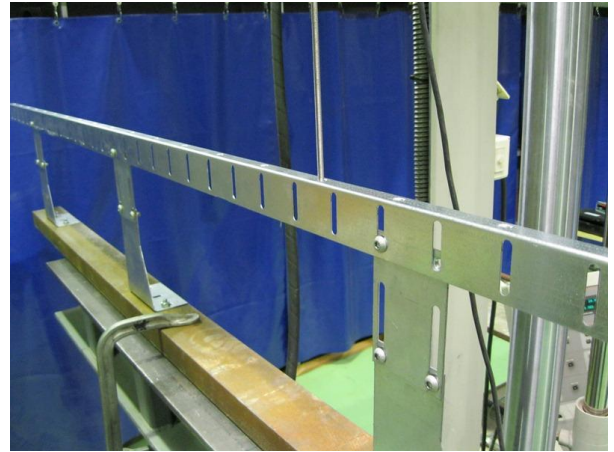

Photos 1 and 2. Test arrangements, loading point 70...130 mm from the fixing screw.

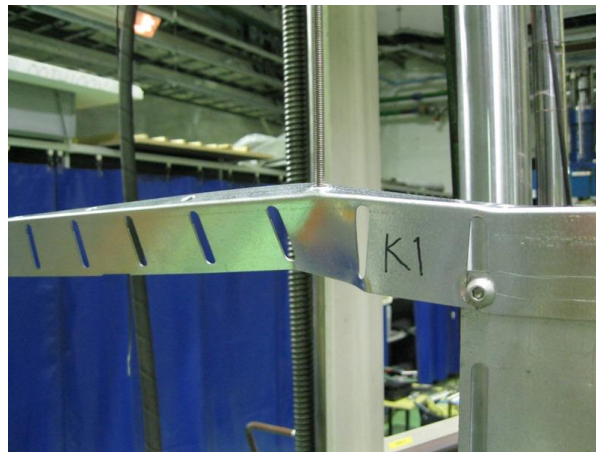

Photo3. Typical failure.

The test results relate only to the sample tested.

STONEL BRICK SURFACED EXTERNAL CLADDING PANEL SYSTEM:

Results of horizontal load tests of horizontal rails

Specimen	Failure load (kN)/two fixing points
1	1,85
2	2,15
3	2,04
4	1,88
5	1,99
6	1,95
Average	1,97
St.dev.	0,10
Characteristic	1,76
Design value	1,58
Design value (fixings 0.6 m x 0.6 mesh)	2,20

The test results relate only to the sample tested.

Results of horizontal load tests of horizontal rails / typical load-displacement curves

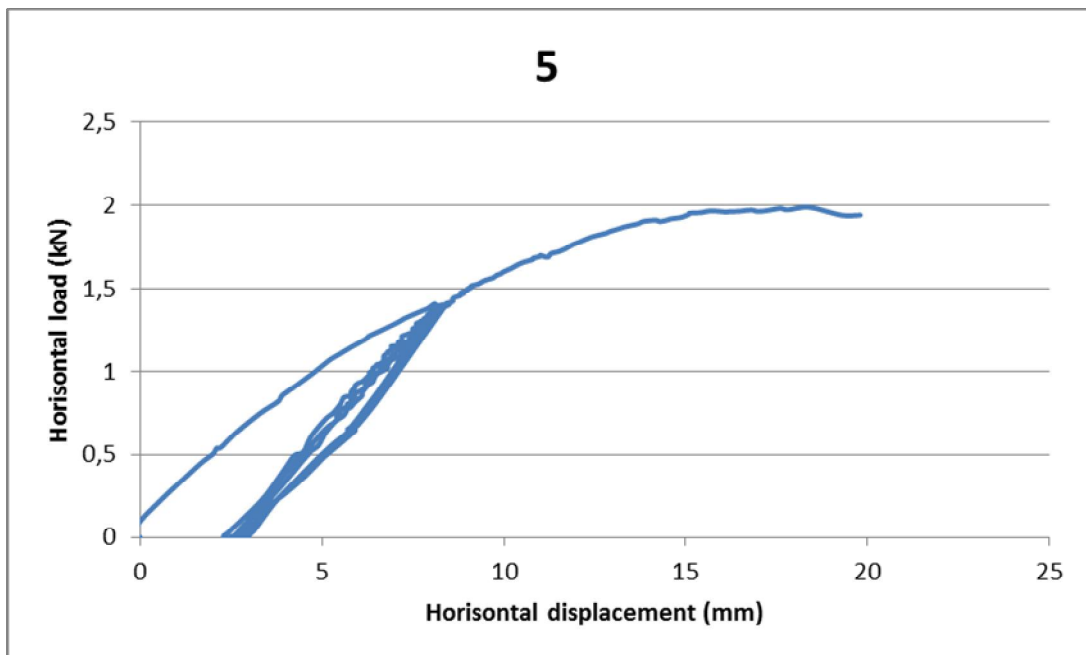
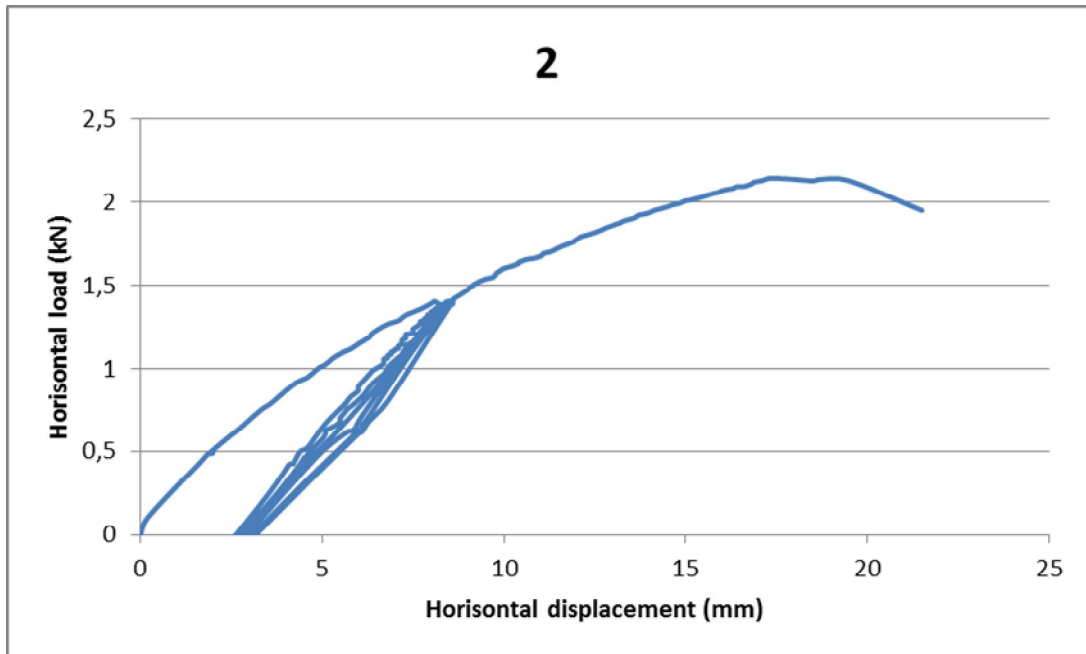

The test results relate only to the sample tested.

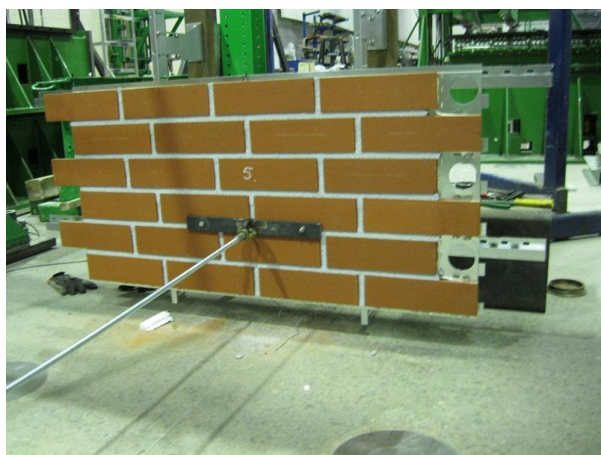
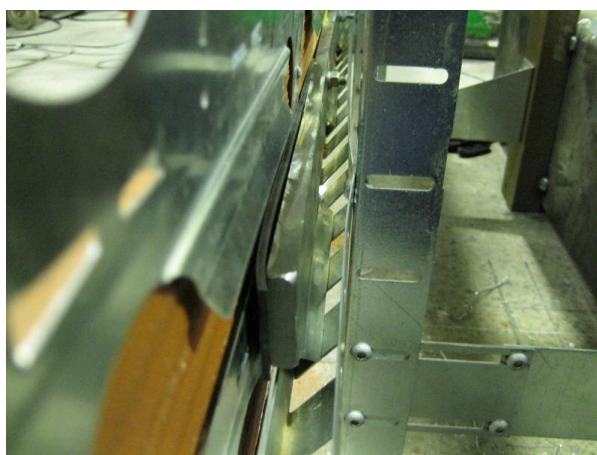

Photo 4. Test arrangements.



Photo 5. Test arrangements from backside of the specimen.



Photos 6 and 7. Load was concentrated on backside with the help of rubber strips (300 mm long) to fixing areas of horizontal rails.



Photo 8. Start of failure.

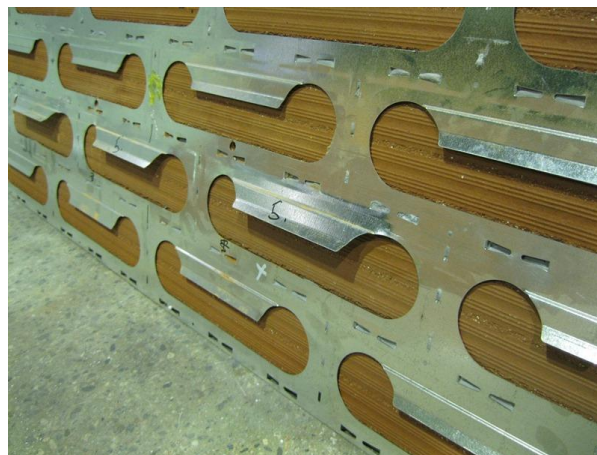

Photo 9. Tongues of the panel back side were finally loosened from deflected horizontal rails.

The test results relate only to the sample tested.

STONEL BRICK SURFACED EXTERNAL CLADDING PANEL SYSTEM:

Results of combined load tests of horizontal rails

typical load-displacement curves

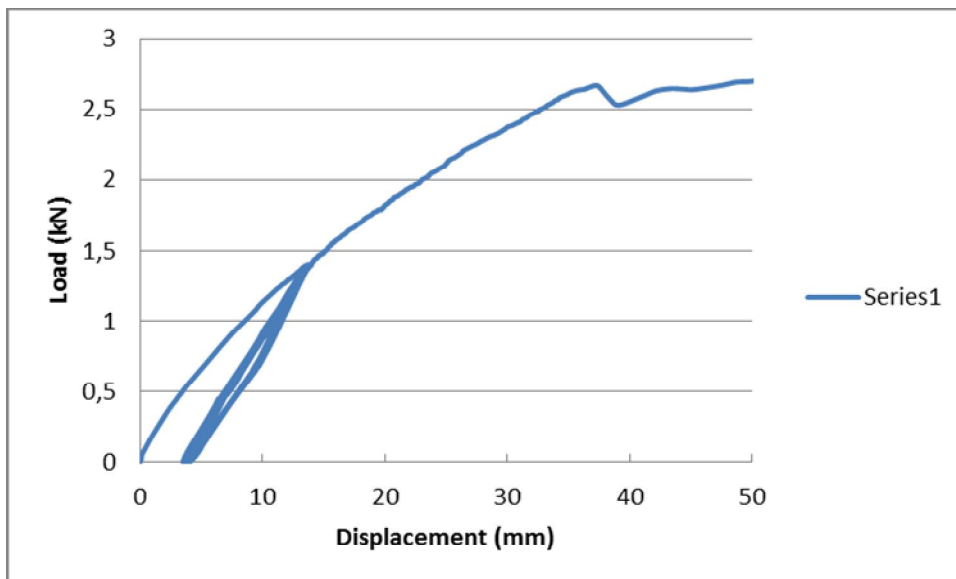
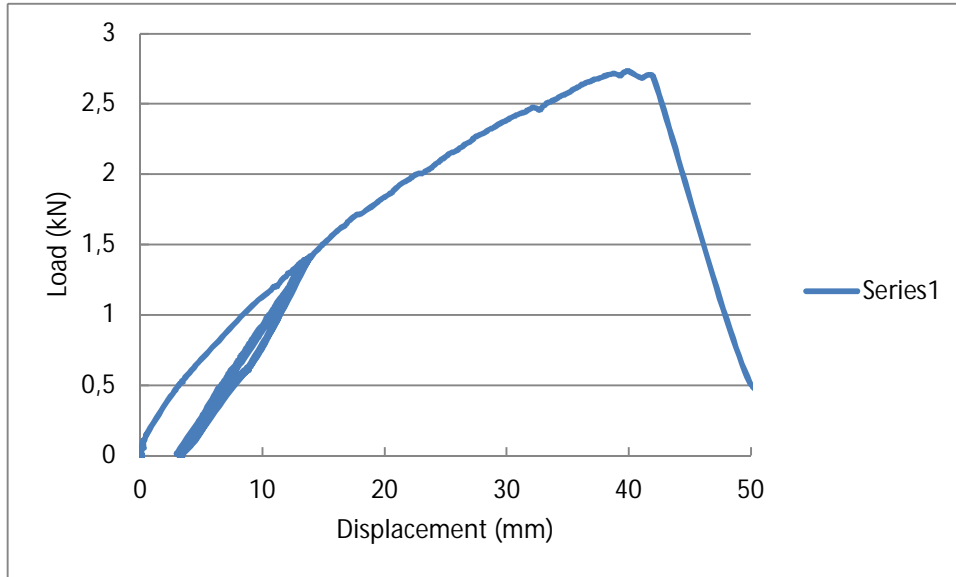

The test results relate only to the sample tested.



Photo 10. Test arrangements.



Photo 11. Test arrangements from back side.

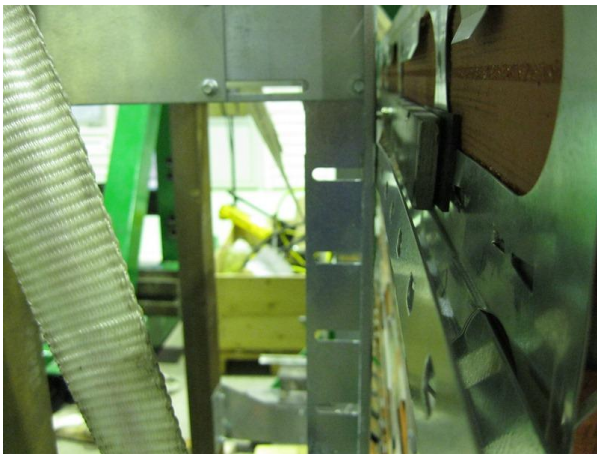

Photo 12. Starting of the failure.

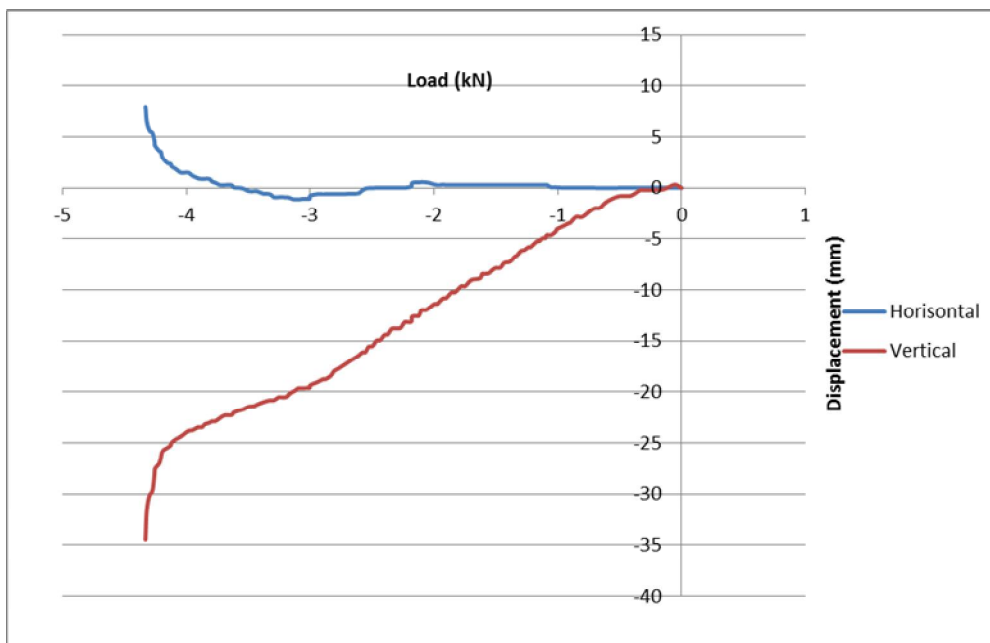
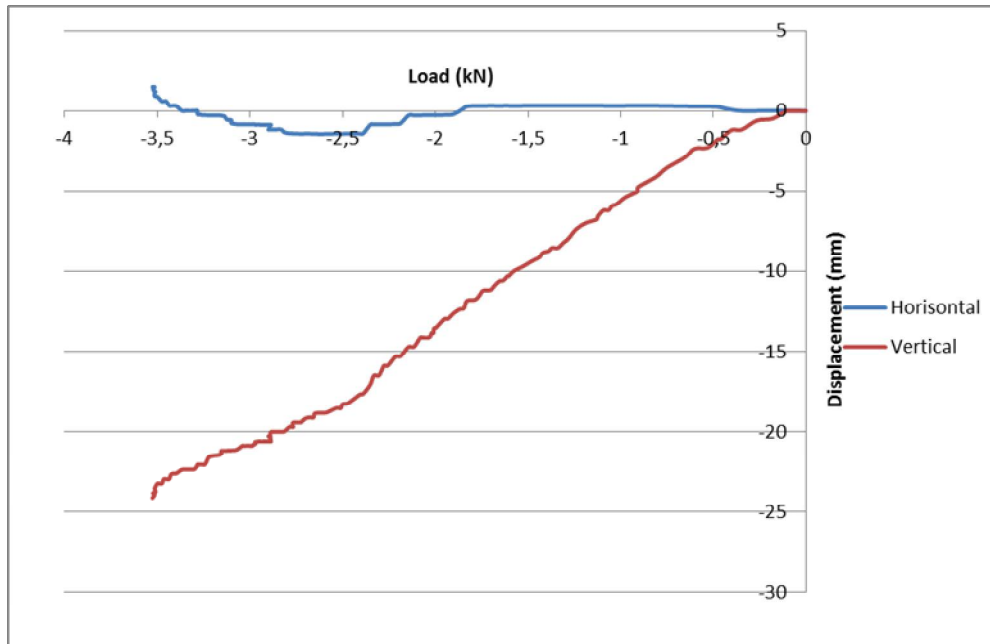

Photo 13. Horizontal rail after failure.

The test results relate only to the sample tested.

STONEL BRICK SURFACED EXTERNAL CLADDING PANEL SYSTEM:

Vertical load tests Load-displacement curves



The test results relate only to the sample tested.

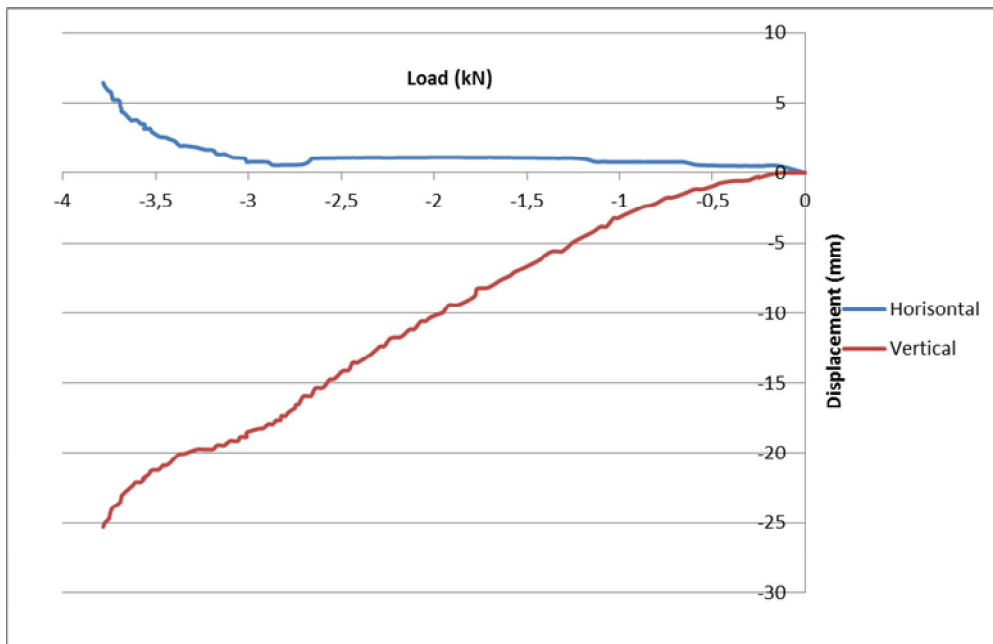
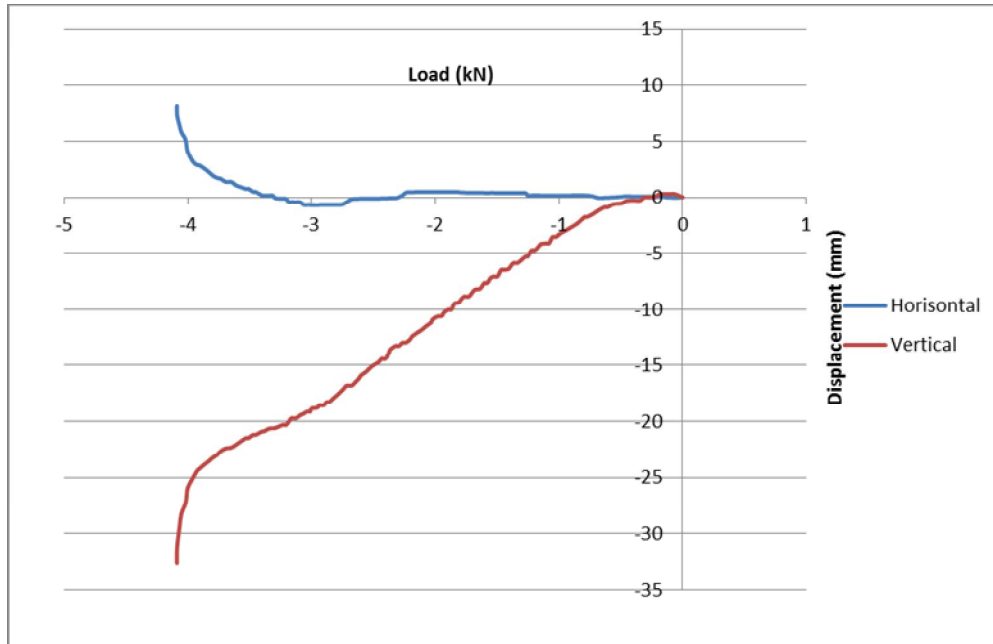

The test results relate only to the sample tested.

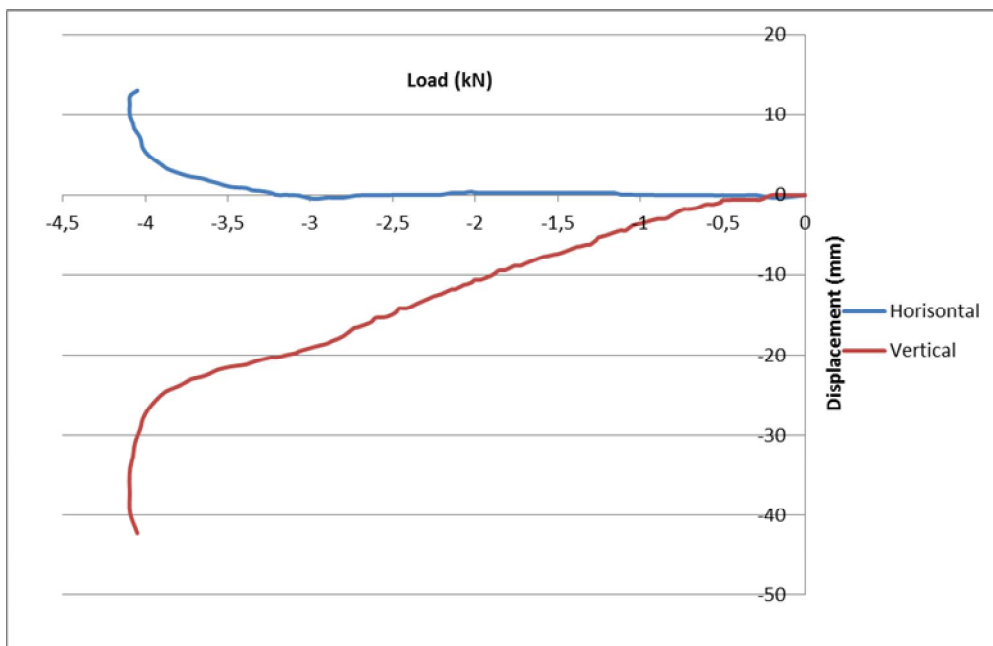
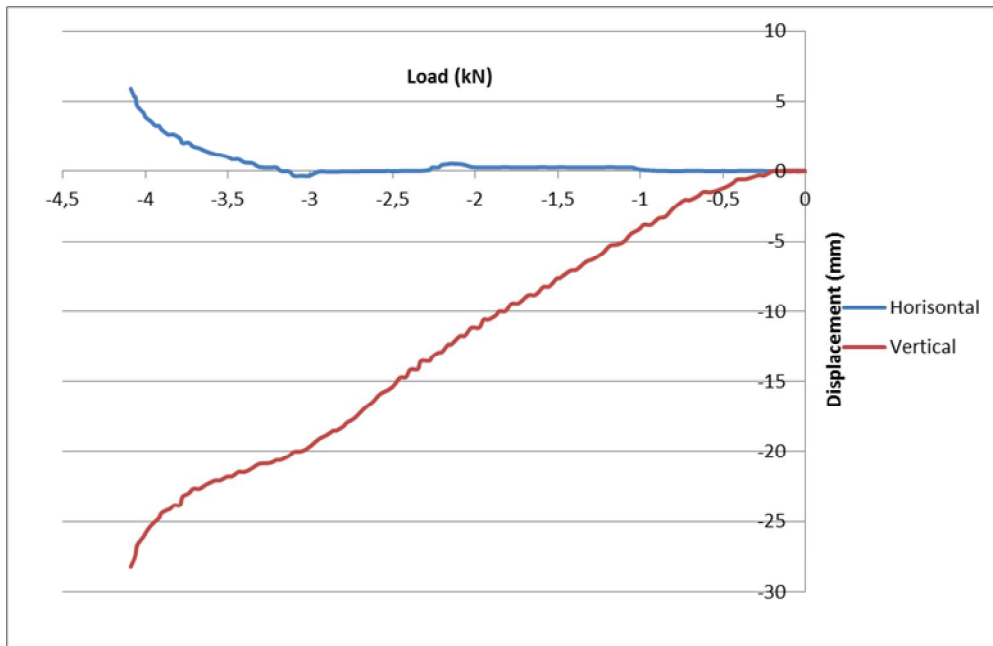

The test results relate only to the sample tested.

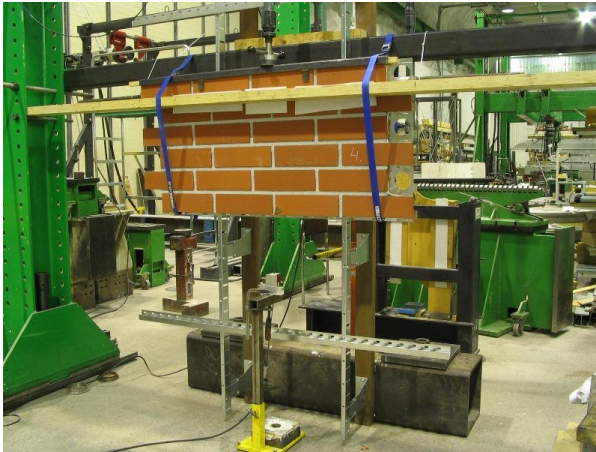

Photo 14. Test element in vertical load test.

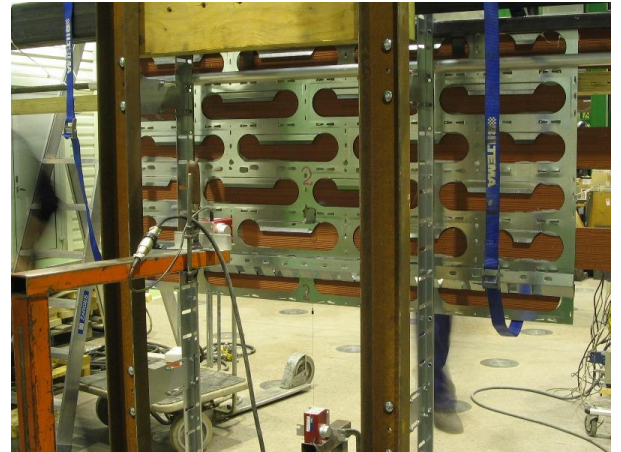

Photo 15. Test element from backside and measuring of displacements.



Photo 16. Failure mechanism.



Photo 17. Panel and rail after test.

The test results relate only to the sample tested.

STONEL BRICK SURFACED EXTERNAL CLADDING PANEL SYSTEM:

Results of bending tests of brick panel

Thickness of six measured panel

	18,0
	18,2
	18,5
	18,0
	18,4
	18,2
Average	18,2

In vertical direction/ failure of horizontal joints

	Load (kN)	Width	Thickness*	M (Nmm)	Bending strength (N/mm ²)	Moment capacity Nm/m
	0,19	301	18,215	17370	1,04	58
	0,20	300	18,215	18180	1,10	61
	0,24	300	18,215	21510	1,30	72
	0,26	299	18,215	23760	1,44	79
	0,16	300	18,215	14400	0,87	48
	0,20	300	18,215	17730	1,07	59
Average	0,21			18825	1,13	63
Stand.dev	0,04			3313	0,20	11
Charac.	0,13			11603	0,70	38

* Average thickness

In horizontal direction/ failure through bricks and vertical joints

	Load (kN)	Width	Thickness*	M (Nmm)	strength (N/mm ²)	Moment capacity Nm/m
	1,01	290	18,215	90900	5,67	313
	0,90	298	18,215	80640	4,89	271
	0,90	284	18,215	80730	5,14	284
	0,88	281	18,215	79290	5,10	282
	0,80	281	18,215	72360	4,66	258
	0,88	288	18,215	78930	4,96	274
Average	0,89			80475	5,07	280
Stand.dev	0,07			5974	0,34	19
Charac.	0,75			67453	4,33	239

* Average thickness

The test results relate only to the sample tested.

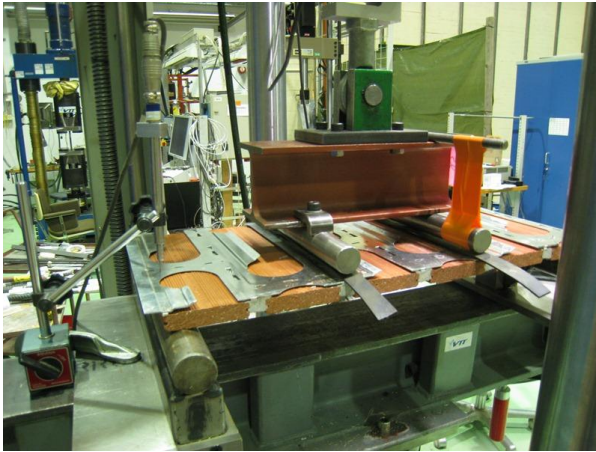

Photos 18 and 19. Test arrangements.



Photo 20. Failure at mortar joint.



Photo 21. Failure crack.

The test results relate only to the sample tested.

FIXING PARTS OF CLADDING SYSTEM (IN FINNISH)



Stonel -kiinnitysjärjestelmä

Stonel -julkisivuverhous kiinnitetään mittamodulisoidulla kiinnitys-järjestelmällä seinään. Järjestelmä koostuu seinäkiinnikkeistä, pystyyn tulevasta eristyskiskosta ja vaakaan asennettavasta asennuskiskosta. Elementtiverhous tulee ns. vapaasti roikkumaan asennuskiskon varaan. Seinäkiinnikkeet ja kiskot kiinnitetään toisiinsa kuusiokoloruuveilla valmiisiin tuotteissa oleviin kierrereikiin. Kiinnitysjärjestelmä kiinnitetään seinärakenteeseen seinäkiinnikkeiden rei'istä kohteeseen suunnittelijan määrittelemällä kiinnikkeellä, esim. kiila-ankkuri tmv. Kiinnikkeiden määrä ja materiaali varmistettava kohteen suunnittelijalta sekä pysyvyys varmistettava tarvittaessa vetotestein.

Stonel -julkisivuverhous painaa 40 kg/m² ja kiinnitysjärjestelmä 3 kg/m².

Materiaalit:

- Seinäkiinnikkeet
 - o vahvuus 2mm
 - o Teräslaatu DX51D+Z275-M-A EN 10346:2009
- Kiskot; eristyskisko ja asennuskisko
 - o vahvuus 1,25mm
 - o Teräslaatu DX51D+Z350-M-A EN 10346:2009
- Kiinnitysruuvi
 - o 6-kolo M8x12 8.8 ISO 7380



The test results relate only to the sample tested.

WALL FIXING PART

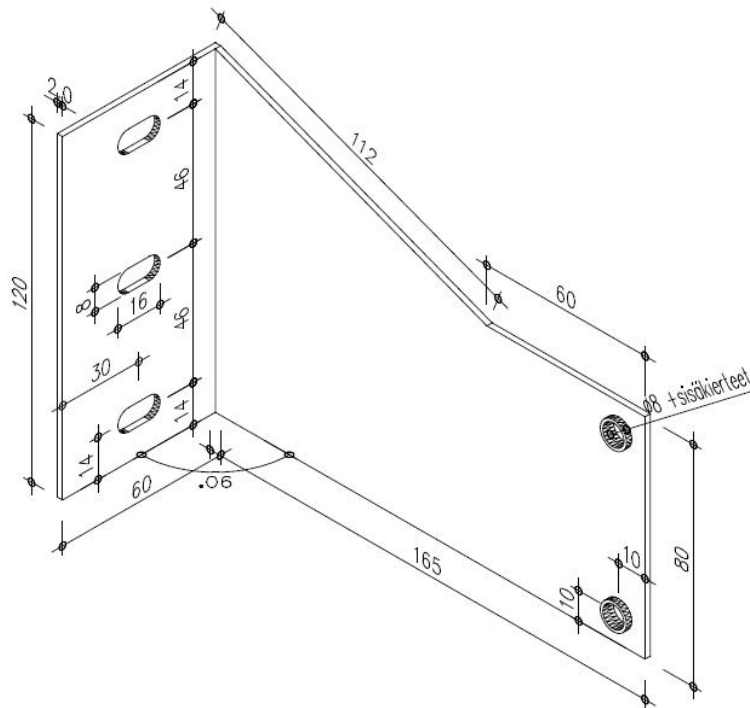

HORIZONTAL RAIL

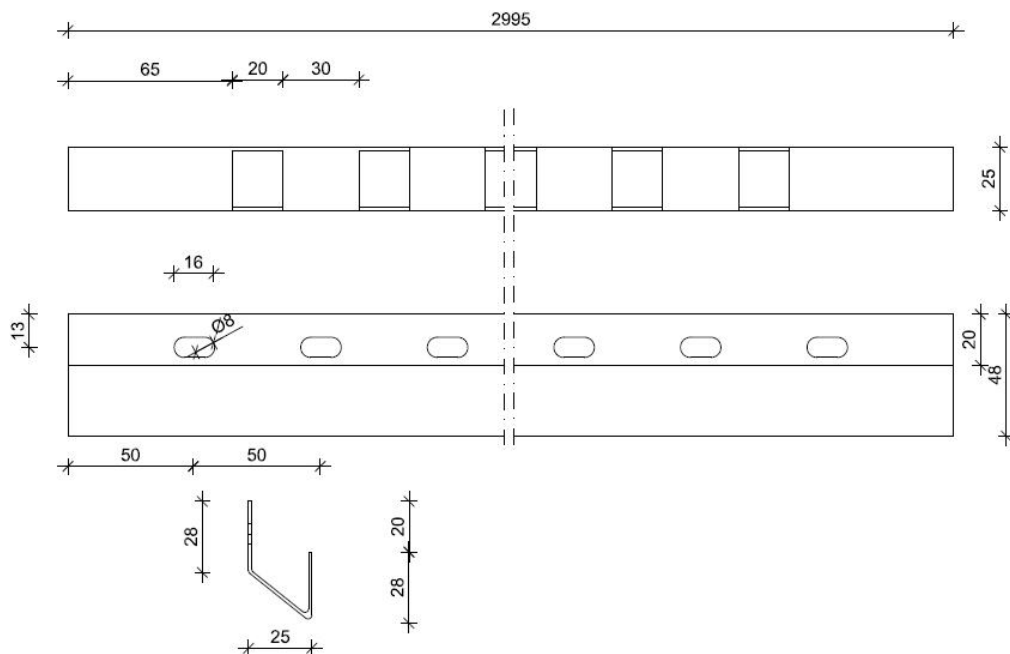

ASENNUSKISKO
vahvuus 1,25mm

STONEL
STONEL OY
Hallitie 22
51200 KANGASNIEMI
Jorma Katainen
puh. 0207 959 300
gsm. +358400 645 114

The test results relate only to the sample tested.

VERTICAL RAIL

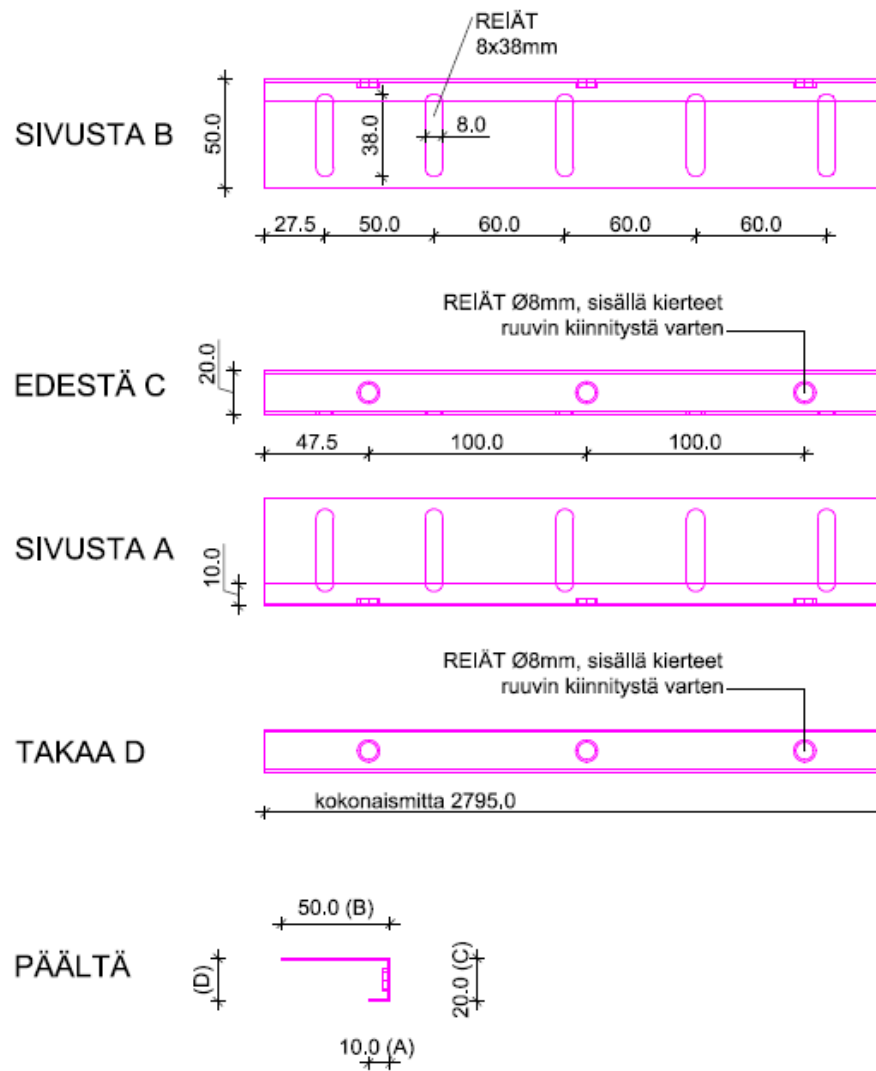

ERISTYSKISKO "J" (100mm reikäväli)
symmetrinen päistään

STONEL
STONEL OY
Helttie 22
51200 KANGASNEMI
www.stonel.fi
Jorma Katalinen
puh. 0207 959 300
gsm. +358400 645 114
jorma.katalinen@stonel.fi

The test results relate only to the sample tested.