



KITCHENWARE
CATALOGUE
2020 | 2021



KITCHENWARE CATALOGUE 2020 | 2021

COPYRIGHT DISCLAIMER

Sia Huat Private Limited intended not to use any copyrighted material for the publication. The copyright for any material created by Sia Huat Private Limited is reserved. Any duplication or use of objects such as images, diagrams, or texts in other electronic or printed publications is not permitted without Sia Huat Private Limited's agreement.

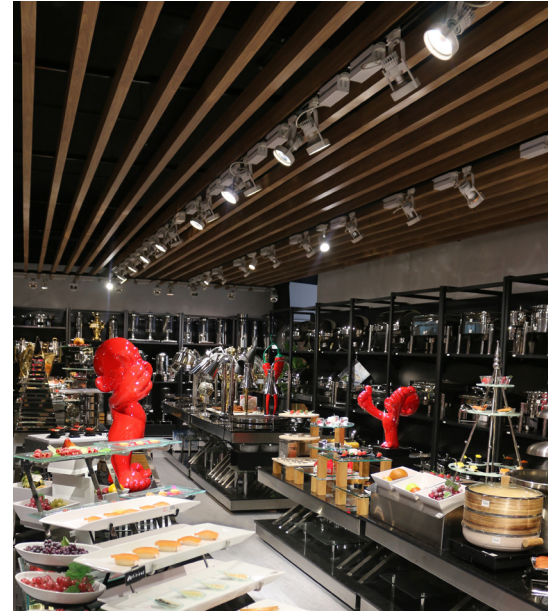

Asia's one-stop food service partner





COMPANY PROFILE

Asia's one-stop food service partner
Agent, Direct Distributor and Stockist



Sia Huat is Southeast Asia's leading agent and direct distributor for an extensive range of foodservice products and equipment. Together with our house brands of tableware and kitchenware, there is something to suit every budget and need.

Sia Huat achieves economies of scale by selling across regions and market segments. Our customer-centric approach is supported by a 40,000 square feet warehouse, 10,000 square feet showroom, large scale concept store and overseas office.



Our Philosophy

Creating win-win partnerships

In a vibrant and often demanding foodservice industry, we aim to deliver more than quality products, as well as provide real and distinctive value through affordable pricing, responsiveness, convenience, vast product choices, ready stock, expertise and reliability.

Sia Huat's philosophy is to always create win-win partnerships with our customers and suppliers. As an essential link, our mission is to ensure customers get the best-fit for their needs and supplier grow their brand.



Our Business Values



Expertise

Understand and anticipate customers' needs



Value

Competitive Prices and top quality



Collaboration

Create win-win partnerships with customers and suppliers



Customer Focus

Provide more than foodservice supplies



1982

Chop Sia Huat was incorporated as Sia Huat Private Limited with CB as the Managing Director and Katherine as the Executive Director. It was also the beginning of an era where Sia Huat obtained exclusive distribution rights to many established brands in Singapore, Indonesia and Malaysia. Our strong relationships with long-standing partners and renowned brands, such as Zebra and Nikko, have continued to this day.



2000

With the booming business, the Temple Street store soon expanded to a double storey outlet, now stretched over three shops units. The following year, the store underwent a revamp to enhance customers' shopping experience. The bigger retail space also allowed a wider range of products to be showcased. The overhaul proved to be an immense success, with sales growth reaching a new high.



1959

Founded in 1959, Mr Tan Chah Sia, Chop Sia Huat started out as a household goods retailer in Singapore's Chinatown district. Behind this modest shop front, a four-man team ran the business selling kitchenware and household products.



1995

In 1995, Sia Huat established her corporate office and warehouse in a building at 20 Pandan Road, housing over 200 employees and more than 100 brands in its stable.

SIA HUAT'S MILESTONES >>

A snapshot of the company's achievements since its establishment



1985

Under the sibling's leadership, the family business flourished. Following the incorporation of Chop Sia Huat as Sia Huat Pte Limited, the retail shop grew from a single leased unit to a privately owned outfit double in size.



1998

Sia Huat began participating in major trade shows around the world, such as the 1998 Food and Hotel Asia Exhibition, to connect with key prospects in the food and hospitality industries. In May 1998, a wholly-owned subsidiary, Hocatsu (M) Sdn Bhd, was set up to gain a foothold in the growing kitchenware market in Malaysia. With this increased exposure, Sia Huat quickly made a name for itself as Southeast Asia's leading agent, distributor and stockist in foodservice products and equipment.



1967

Mr C.B. Tan, the founder's son, was roped in to steer the company's future direction. Armed with a keen sense of business, C.B saw an opportunity to expand the business by supplying kitchenware to the hospitality industry. His younger sister, Katherine Tan, later joined him in executing his vision. Together, they successfully secured their first hotel deal with Shangri-La Singapore in the 1980s.



1990

Sia Huat successfully secured major contracts with various hotels, retailers and F&B establishments, including the newly built Singapore International Convention & Exhibition Centre.



2009

Sia Huat's Managing Director Mr C.B. Tan receiving the award from Ms Lim Hwee Hua (then Minister in the Prime Minister's Office) at the Singapore Prestige Brand Award held at Ritz Carlton Millenia Hotel on 10th December 2009. In recognition of outstanding achievement in branding, Sia Huat was presented with the Singapore Prestige Brand Award (Heritage Brands category, for brands established for more than 25 years).



2018

ToTT relocated its Sime Darby Center Store to Century Square. The new store is over 7000 Sq Ft. The new location facilitates to serve a new group of customers.



2013

At the 2012/2013 Global Innovation Award (GIA), TOTT was honoured with a prestigious National win, alongside 22 other winners each representing a different country, beating some of the industry's best in housewares retail and design. The GIA is organised by the International Housewares Association in Chicago and is the most recognised awards program for homegoods retailer around the world. Building upon its increasing presence in the region, Hocatsu (M) Sdn Bhd, a subsidiary of Sia Huat, introduced a brand new 10,000 square feet concept showroom, retail space and office in Jalan 225, Petaling Jaya, Kuala Lumpur.



2005

To further enhance Sia Huat's supply chain performance, the 40,000 square feet warehouse was extensively renovated to include technological innovations such as computerised shipping and tracking to optimise productivity and inventory management.

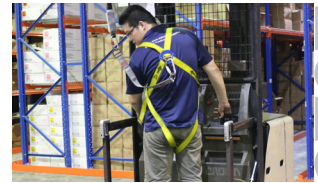

2020

The new consolidated warehouse is 55,000 sq ft and will support our regular distribution, E-commerce and export sales.



2003

A brand new 10,000 square feet Corporate Showroom was launched at the Pandan Road building, providing a one-stop shopping solution for all needs.



2015

TOTT Store opened its second store. Centrally located at Suntec City, TOTT@Suntec 4,800 square feet houses an open concept hands-on cooking studio for up to 24 participants.

2006

With tremendous support from partners, and a rising reputation for product excellence and strong logistic capabilities, Sia Huat clinched a lucrative contract with flag carrier, Singapore Airlines, to supply customised luxury chinaware for her Business Class cabins. With daily flights to several international destinations, this effectively brought visibility of the Sia Huat brand to a global scale.



2010

Tools of the Trade (TOTT) store was launched in 2010 in response to a rapidly growing pool of quality-conscious and discerning end consumers. It quickly became a culinary paradise offering over 11,000 kitchen selections, event hosting, and cooking classes for aspiring home chefs. It also houses a bistro serving up a delectable selection of Asian and Western cuisine.



2019

PT Sia Huat Indonesia opened in Jakarta to better serve our customers in Indonesia.

CONTENTS

Welcome to Sia Huat!

SIA HUAT 
Beyond Foodservice Supplies

Professional
Cookware

01



355

Apparel &
Protective
Wear



Bakeware &
Pastry Supplies

228



Catering, Buffet &
Food Transportation

372

Bar Supplies

383





Kitchen Tools & Utensils

50



Cutting Tools 127



Electricals & Food Prep Machines 163



Storage Organization & Shelving 283



Stewarding & Housekeeping 328



Furniture & Banquet Equipment 394

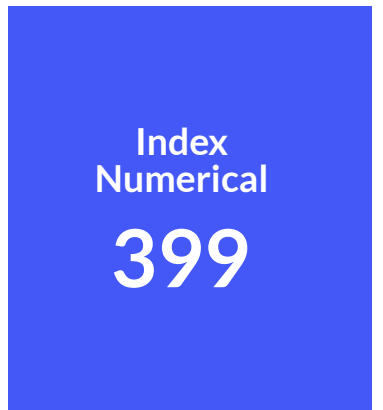

Index Numerical 399

CONTENTS

Chapter	Category	Page
01	Professional Cookware	001
02	Kitchen Tools & Utensils	050
03	Cutting Tools	127
04	Electricals & Food Prep Machines	163
05	Bakeware & Pastry Supplies	228
06	Storage Organization & Shelving	283
07	Stewarding & Housekeeping	328
08	Apparel & Protective Wear	355
09	Catering , Buffet & Food Transportation	372
10	Bar Supplies	383
11	Furniture & Banquet Equipment	394
12	Index	399

PROFESSIONAL
COOKWARE



CHAPTER

01

SIA HUAT 
Beyond Foodservice Supplies

www.siahuat.com

MAUVIEL - M'COOK RANGE

The Collection M'cook offers professionals the highest culinary technology. Five layers of materials provide perfect heat conduction and distribution. The bronze handles reinforce the pure and modern design of this range. The collection M'cook provides the most demanding cook with the greatest pleasure. Made in France.



MAUVIEL M'COOK Stainless Steel Sauce Pan with Bronze Handle

Product Code	Dimension	Capacity
01-001-00218	Ø14 x H8cm	1.1ℓ
01-001-00217	Ø16 x H9cm	1.8ℓ
01-001-00219	Ø18 x H10cm	2.5ℓ
01-001-00220	Ø20 x H11cm	3.4ℓ



MAUVIEL M'COOK Stainless Steel Sauteuse with Bronze Handle

Product Code	Dimension	Capacity
01-001-00377	Ø20 x H6cm	1.8ℓ
01-001-00375	Ø24 x H7.6cm	3.1ℓ
01-001-00376	Ø28 x H9cm	5.5ℓ



MAUVIEL M'COOK Stainless Steel Non-Stick Frying Pan

Product Code	Dimension	Handle
01-001-00556	Ø24 x H4.8cm	Silver



MAUVIEL M'COOK Stainless Steel Non-Stick Frying Pan with Bronze Handle

Product Code	Dimension
01-001-00469	Ø28 x H4.9cm



MAUVIEL M'COOK Stainless Steel Non-Stick Frying Pan with Bronze Handle

Product Code	Dimension	Handle
01-001-00436	Ø20 x H4cm	Bronze
01-001-00437	Ø24 x H4.8cm	Bronze
01-001-00435	Ø28 x H4.9cm	Bronze



MAUVIEL M'COOK Stainless Steel Rectangle Roasting Pan with Bronze Handles

Product Code	Dimension
01-001-00846	35 x 25 x 7cm
01-001-00847	40 x 30 x 8.5cm



MAUVIEL M'COOK Stainless Steel Lid with Bronze Handle

Product Code	Dimension
01-001-00308(XX)	Ø12cm
01-001-00309(XX)	Ø14cm
01-001-00310(XX)	Ø16cm
01-001-00311(XX)	Ø18cm

DE BUYER - AFFINITY RANGE

The Affinity range uses an innovative ultra conductive single-piece multi-layer material (5 layers) on side and bottom. For even heat distribution, the 3 central layers of the Affinity material are made of aluminium. It heats up quickly, thereby preserving vitamins, cooking evenly and providing a perfect heating circuit. This is essential for slow-cooked dishes and sauces. The cast stainless steel handles are firmly fastened with rivets. The products are solid and undeformable. Affinity products are suitable for any cook top, including induction.



DE BUYER AFFINITY *Stainless Steel Lid*

Product Code	Dimension
01-001-00333	Ø9cm
01-001-01188	Ø14cm
01-001-01189	Ø16cm
01-001-01190	Ø18cm
01-001-01252	Ø20cm
01-001-01253	Ø24cm



DE BUYER AFFINITY *Stainless Steel Oval Stewpan with Lid*

Product Code	Dimension
01-001-01187	Ø30 x H13cm



DE BUYER AFFINITY *Stainless Steel Mini Casserole with Lid*

Product Code	Dimension	Capacity
01-001-00795	Ø12 x H7cm	0.75ℓ
01-001-00796	Ø14 x H8cm	1.0ℓ



DE BUYER AFFINITY *Stainless Steel Low Casserole with Lid*

Product Code	Dimension
01-001-01203	Ø24 x H7.5cm



DE BUYER AFFINITY *Stainless Steel Casserole with Lid*

Product Code	Dimension
01-001-01204	Ø20 x H11cm
01-001-01205	Ø24 x H13cm
01-001-01206	Ø28 x H15cm



DE BUYER AFFINITY *Stainless Steel Sauce Pan*

Product Code	Dimension	Capacity
01-001-01184	Ø14 x H7.5cm	1.2ℓ
01-001-01185	Ø16 x H9cm	1.8ℓ
01-001-01186	Ø18 x H10cm	2.5ℓ



DE BUYER AFFINITY *Stainless Steel Sauteuse*

Product Code	Dimension	Capacity
01-001-01199	Ø20 x H6cm	1.8ℓ
01-001-01200	Ø24 x H7.5cm	3ℓ



DE BUYER AFFINITY *Stainless Steel Flaired Saute Pan*

Product Code	Dimension	Capacity
01-001-01201	Ø20 x H7cm	1.7ℓ
01-001-01202	Ø24 x H8cm	3ℓ



DE BUYER AFFINITY *Stainless Steel Mini Frying Pan*

Product Code	Dimension
01-001-00468	Ø10 x H4.3cm



DE BUYER AFFINITY *Stainless Steel Frying Pan*

Product Code	Dimension
01-001-01195	Ø20 x H4cm
01-001-01196	Ø24 x H4cm
01-001-01197	Ø28 x H4.5cm
01-001-01198	Ø32 x H4.5cm



DE BUYER AFFINITY *Stainless Steel Non-Stick Frying Pan*

Product Code	Dimension
01-001-01191	Ø20 x H4cm
01-001-01192	Ø24 x H4cm
01-001-01193	Ø28 x H4.5cm
01-001-01194	Ø32 x H4.5cm

DE BUYER - NOSTALGY RANGE

Resolutely vintage-looking and hinting at childhood memories, the patinated finish of the range NOSTALGY confers it refinement and elegance. Its resistant stainless steel composition facilitates the use and the maintenance. The wide magnetic bottom spreads the heat in a quite even way on the whole bottom of the item, and makes cooking easy on all heat sources, induction included. The flared edges provide an easy pouring of all food and liquids.



DE BUYER NOSTALGY *Stainless Steel Sauce Pan with Lid*

Product Code	Dimension	Capacity
01-001-01078	Ø16cm	1.6ℓ
01-001-01079	Ø20cm	3.0ℓ



DE BUYER NOSTALGY *Stainless Steel Frypan*

Product Code	Dimension
01-001-01080	Ø24cm
01-001-01081	Ø28cm



DE BUYER NOSTALGY *Stainless Steel Stew Pan with Lid & Side Handles*

Product Code	Dimension	Capacity
01-001-01082	Ø20cm	3.0ℓ
01-001-01083	Ø24cm	5.4ℓ

de Buyer

DEPUIS 1830



Chaque recette a son secret*



FRENCH MANUFACTURER OF COOKING AND PASTRY UTENSILS



www.debuyer.com



* Every recipe holds a secret

LACOR- CHEF-LUXE HEAVY DUTY RANGE

The Chef- Luxe range is made in 18/10 stainless steel (pot body, handles and grip) with a thickness of 1.5mm to 2mm. It comes with a heat diffuser bottom made from stainless steel with sandwiched aluminium. It is designed to be energy saving with high resistance and long durability.



LACOR CHEF LUXE Stainless Steel Stock Pot without Lid

Product Code	Dimension	Capacity
01-001-00024	Ø20 x H20cm	6.2ℓ
01-001-00025	Ø24 x H24cm	10.5ℓ
01-001-00026	Ø28 x H28cm	17.2ℓ
01-001-00027	Ø32 x H32cm	25.7ℓ
01-001-00028	Ø36 x H36cm	36.5ℓ
01-001-00030	Ø40 x H40cm	50.0ℓ
01-001-00031	Ø45 x H45cm	71.5ℓ
01-001-00032	Ø50 x H50cm	98ℓ

LACOR CHEF LUXE Stainless Steel Shallow Stock Pot without Lid

Product Code	Dimension	Capacity
01-001-00033	Ø20 x H15cm	4.7ℓ
01-001-00034	Ø24 x H20cm	9.0ℓ
01-001-00035	Ø28 x H22cm	13.5ℓ
01-001-00036	Ø32 x H26cm	20.0ℓ
01-001-00037	Ø36 x H29cm	29.5ℓ
01-001-00038	Ø40 x H32cm	40.0ℓ



LACOR CHEF LUXE Stainless Steel High Casserole without Lid

Product Code	Dimension	Capacity
01-001-00087	Ø20 x H13cm	4.0ℓ
01-001-00088	Ø24 x H14cm	6.7ℓ
01-001-00089	Ø28 x H17.5cm	10.7ℓ
01-001-00090	Ø32 x H18cm	14.6ℓ
01-001-00091	Ø36 x H21.5cm	21.8ℓ
01-001-00092	Ø40 x H24.5cm	30.0ℓ
01-001-00093	Ø45 x H27.5cm	43.7ℓ
01-001-00094	Ø50 x H30cm	58.8ℓ

LACOR CHEF LUXE Stainless Steel Low Casserole without Lid

Product Code	Dimension	Capacity
01-001-00095	Ø20 x H10cm	2.9ℓ
01-001-00096	Ø24 x H10cm	4.25ℓ
01-001-00097	Ø28 x H11cm	6.7ℓ
01-001-00098	Ø32 x H12.5cm	10.0ℓ
01-001-00099	Ø36 x H14cm	14.2ℓ
01-001-00100	Ø40 x H15.5cm	19.4ℓ
01-001-00101	Ø45 x H17cm	27.0ℓ
01-001-00102	Ø50 x H20cm	38.2ℓ



LACOR CHEF LUXE Stainless Steel High Sauce Pan without Lid

Product Code	Dimension	Capacity
01-001-00239	Ø16 x H11cm	2.2ℓ
01-001-00242	Ø18 x H12cm	3.0ℓ
01-001-00243	Ø20 x H13cm	4.0ℓ
01-001-00246	Ø24 x H14cm	6.7ℓ
01-001-00249	Ø28 x H17.5cm	10.7ℓ



LACOR CHEF LUXE Stainless Steel Sauce Pan without Lid

Product Code	Dimension	Capacity
01-001-00236	Ø12 x H7cm	0.75ℓ
01-001-00237	Ø14 x H7.5cm	1.1ℓ
01-001-00238	Ø16 x H8cm	1.6ℓ
01-001-00240	Ø18 x H9cm	2.25ℓ
01-001-00241	Ø20 x H10cm	2.9ℓ
01-001-00244	Ø24 x H10cm	4.25ℓ
01-001-00245	Ø24 x H12cm	5.4ℓ
01-001-00247	Ø28 x H11cm	6.7ℓ
01-001-00248	Ø28 x H14cm	8.6ℓ



LACOR CHEF LUXE Stainless Steel Conical Saute Pan

Product Code	Dimension	Capacity
01-001-00387	Ø16 x H6cm	1.0ℓ
01-001-00388	Ø20 x H6.5cm	1.6ℓ
01-001-00390	Ø24 x H7.5cm	2.7ℓ



LACOR CHEF LUXE Stainless Steel Saute Pan with 1 Handle

Product Code	Dimension	Capacity
01-001-00389	Ø20 x H6.5cm	1.8ℓ
01-001-00391	Ø24 x H6.5cm	2.7ℓ
01-001-00392	Ø28 x H7cm	4.0ℓ
01-001-00393	Ø32 x H8.5cm	4.7ℓ
01-001-00394	Ø36 x H10cm	7.0ℓ



LACOR CHEF LUXE Stainless Steel Frying Dish with 2 Handles without Lid

Product Code	Dimension	Capacity
01-001-00450	Ø36 x H7cm	7.0ℓ
01-001-00451	Ø40 x H8cm	10.0ℓ
01-001-00452	Ø45 x H8.5cm	12.0ℓ
01-001-00453	Ø50 x H9cm	17.0ℓ



LACOR CHEF LUXE Stainless Steel Pressure Cooker

Product Code	Dimension	Capacity
01-001-00344	Ø32 x H18cm	15.0ℓ
01-001-00345	Ø32 x H23cm	18.0ℓ
01-001-00346	Ø32 x H32cm	22.0ℓ



LACOR CHEF LUXE Stainless Steel Lid

Product Code	Dimension
01-001-00323(XX)	Ø16cm
01-001-00324(XX)	Ø20cm
01-001-00325(XX)	Ø24cm
01-001-00326(XX)	Ø28cm
01-001-00327(XX)	Ø32cm
01-001-00328(XX)	Ø36cm
01-001-00329(XX)	Ø40cm
01-001-00330(XX)	Ø45cm
01-001-00331(XX)	Ø50cm



LACOR CHEF LUXE Accessories Lid for Pressure Cooker

Product Code	Dimension
01-001-00332	Ø32cm

The Lacor logo features the brand name in a bold, italicized, white sans-serif font. A red, curved swoosh arches over the letters 'a' and 'c'.

“World’s Top Chefs choose Top Quality”



LACOR- CHEF CLASSIC RANGE

Seamless one piece 18-10 stainless steel construction with satin polish finishing. Handles are welded for heavy duty use. The sandwich bottom Allows usage on all sources of heat, from traditional to induction. Made in Spain.



LACOR CHEF CLASSIC Stainless Steel Stock Pot without Lid

Product Code	Dimension	Capacity
01-001-00011	Ø20 x H20cm	6.2ℓ
01-001-00012	Ø24 x H24cm	10.5ℓ
01-001-00013	Ø28 x H28cm	17.2ℓ
01-001-00014	Ø32 x H32cm	25.7ℓ
01-001-00015	Ø36 x H36cm	36.6ℓ
01-001-00016	Ø40 x H40cm	50.0ℓ
01-001-00017	Ø45 x H45cm	68.3ℓ
01-001-00018	Ø50 x H50cm	98.0ℓ
01-001-00019	Ø60 x H60cm	141.0ℓ



LACOR CHEF CLASSIC Stainless Steel Deep Casserole without Lid

Product Code	Dimension	Capacity
01-001-00078	Ø20 x H13cm	4.0ℓ
01-001-00079	Ø24 x H15cm	6.3ℓ
01-001-00080	Ø28 x H17.5cm	10.2ℓ
01-001-00081	Ø32 x H18cm	14.5ℓ
01-001-00082	Ø36 x H21.5cm	21.9ℓ
01-001-00083	Ø40 x H24.5cm	30.8ℓ
01-001-00084	Ø45 x H24.5cm	45.0ℓ
01-001-00085	Ø50 x H30cm	59.0ℓ
01-001-00086	Ø60 x H35cm	99.0ℓ



LACOR CHEF CLASSIC Stainless Steel Casserole without Lid

Product Code	Dimension	Capacity
01-001-00068	Ø16 x H7.5cm	1.5ℓ
01-001-00069	Ø20 x H8cm	2.5ℓ
01-001-00070	Ø24 x H9.5cm	4.3ℓ
01-001-00071	Ø28 x H11cm	6.7ℓ
01-001-00072	Ø32 x H12.5cm	10.0ℓ
01-001-00073	Ø36 x H14cm	14.2ℓ
01-001-00074	Ø40 x H15.5cm	19.5ℓ
01-001-00075	Ø45 x H17cm	27.0ℓ
01-001-00076	Ø50 x H20cm	39.0ℓ
01-001-00077	Ø60 x H25cm	70.0ℓ



LACOR CHEF CLASSIC Stainless Steel Deep Sauce Pan

Product Code	Dimension	Capacity
01-001-00231	Ø16 x H11cm	2.1ℓ
01-001-00232	Ø18 x H12cm	3.0ℓ
01-001-00233	Ø20 x H13cm	4.0ℓ
01-001-00234	Ø24 x H14cm	6.3ℓ
01-001-00235	Ø28 x H17.5cm	10.2ℓ



LACOR CHEF CLASSIC Stainless Steel Flaired Saute Pan

Product Code	Dimension	Capacity
01-001-00378	Ø16 x H6cm	1.0ℓ
01-001-00379	Ø18 x H6cm	1.2ℓ
01-001-00380	Ø20 x H6.5cm	1.6ℓ
01-001-00381	Ø22 x H7cm	2.1ℓ
01-001-00382	Ø24 x H7.5cm	2.7ℓ



LACOR CHEF CLASSIC Stainless Steel Sauce Pan

Product Code	Dimension	Capacity
01-001-00224	Ø12 x H7cm	0.8ℓ
01-001-00225	Ø14 x H7.5cm	1.1ℓ
01-001-00226	Ø16 x H7.5cm	1.5ℓ
01-001-00227	Ø18 x H7.7cm	2.0ℓ
01-001-00228	Ø20 x H8cm	2.5ℓ
01-001-00229	Ø24 x H9.5cm	4.3ℓ
01-001-00230	Ø28 x H11cm	6.7ℓ

LACOR CHEF CLASSIC Stainless Steel Sauteuse

Product Code	Dimension	Capacity
01-001-00383	Ø24 x H6cm	2.7ℓ
01-001-00384	Ø28 x H6cm	3.7ℓ
01-001-00385	Ø32 x H6cm	4.7ℓ
01-001-00386	Ø36 x H7cm	7.0ℓ

LACOR CHEF CLASSIC Stainless Steel Frying Dish without Lid

Product Code	Dimension	Capacity
01-001-00438(XX)	Ø24 x H5cm	2.7ℓ
01-001-00439(XX)	Ø28 x H6cm	3.7ℓ
01-001-00440(XX)	Ø32 x H6cm	4.7ℓ
01-001-00449	Ø36 x H7cm	7.0ℓ
01-001-00441(XX)	Ø40 x H8cm	10.0ℓ
01-001-00442	Ø45 x H8.5cm	12.0ℓ

LACOR CHEF CLASSIC Stainless Steel Lid

Product Code	Dimension
01-001-00322	Ø16cm
01-001-00312	Ø18cm
01-001-00313	Ø20cm
01-001-00314	Ø24cm
01-001-00315	Ø28cm
01-001-00316	Ø32cm
01-001-00317	Ø36cm
01-001-00320	Ø40cm
01-001-00318	Ø45cm
01-001-00321	Ø50cm
01-001-00319	Ø60cm

LACOR CHEF CLASSIC Stainless Steel Steamer Insert

Product Code	Dimension
01-001-00924	Ø28 x H11cm
01-001-00925	Ø32 x H12.5cm

LACOR CHEF CLASSIC Stainless Steel Colander Set of 4 Pcs

Product Code	Dimension
02-003-00372	Ø36 x H23cm
02-003-00373	Ø40 x H26cm



SAFICO PROFESSIONAL COOKWARE

Professional quality at incredible value. Seamless on piece 18-10 stainless steel construction with satin polish finishing and mirror band. The sandwich bottom allows usage on all resources of heat, from traditional to induction.



SAFICO Stainless Steel Stock Pot without Lid

Product Code	Dimension	Capacity
01-001-00054	Ø20 x H19cm	5.4ℓ
01-001-00049	Ø24 x H24cm	10.9ℓ
01-001-00050	Ø28 x H28cm	17.2ℓ
01-001-00051	Ø32 x H32cm	25.7ℓ
01-001-00047(XX)	Ø32 x H32cm	25.7ℓ (with Faucet)
01-001-00048	Ø36 x H36cm	36.6ℓ
01-001-00052	Ø40 x H40cm	50.2ℓ
01-001-00053	Ø45 x H45cm	71.5ℓ
01-001-00055*	Ø50 x H50cm	88.4ℓ
01-001-00056*	Ø60 x H55cm	140.0ℓ

*Products come with cutting bottom



SAFICO Stainless Steel High Casserole without Lid

Product Code	Dimension	Capacity
01-001-00114	Ø16 x H11cm	2.2ℓ
01-001-00111	Ø20 x H13cm	4.1ℓ
01-001-00115	Ø24 x H16cm	6.8ℓ
01-001-00112	Ø28 x H17cm	11.1ℓ
01-001-00113	Ø32 x H19cm	16.1ℓ
01-001-00116	Ø36 x H22cm	22.4ℓ
01-001-00117	Ø40 x H25cm	31.4ℓ
01-001-00118	Ø45 x H28cm	44.5ℓ
01-001-00144*	Ø50 x H30cm	53.0ℓ
01-001-00145*	Ø60 x H35cm	89.1ℓ

*Products come with cutting bottom



SAFICO Stainless Steel Shallow Casserole without Lid

Product Code	Dimension	Capacity
01-001-00147	Ø16 x H8cm	1.4ℓ
01-001-00146	Ø20 x H9cm	2.5ℓ
01-001-00130	Ø24 x H10cm	4.5ℓ
01-001-00131	Ø28 x H11cm	6.8ℓ
01-001-00132	Ø32 x H13cm	10.4ℓ
01-001-00133	Ø36 x H17cm	15.3ℓ
01-001-00134	Ø40 x H18cm	22.6ℓ
01-001-00128	Ø45 x H20cm	31.8ℓ
01-001-00148*	Ø50 x H23cm	40.6ℓ
01-001-00149*	Ø60 x H25cm	63.6ℓ

*Products come with cutting bottom



SAFICO Stainless Steel High Sauce Pan without Lid

Product Code	Dimension	Capacity
01-001-00258	Ø16 x H11cm	2.2ℓ
01-001-00259	Ø20 x H12cm	3.8ℓ
01-001-00260	Ø24 x H13cm	5.9ℓ
01-001-00261	Ø28 x H17cm	8.6ℓ



SAFICO Stainless Steel Shallow Sauce Pan without Lid

Product Code	Dimension	Capacity
01-001-00273	Ø16 x H7cm	1.5ℓ
01-001-00274	Ø20 x H9cm	2.5ℓ
01-001-00275	Ø24 x H10cm	3.8ℓ
01-001-00276	Ø28 x H9cm	5.5ℓ



SAFICO Stainless Steel Pasta Insert

Product Code	Dimension
02-003-00403	Ø20 x H14cm
02-003-00404	Ø24 x H20.5cm



SAFICO Stainless Steel Steamer Insert

Product Code	Dimension
01-001-00155	24 x 12cm



SAFICO CAPSULE BOTTOM *Stainless Steel Conical Saute Pan*

Product Code	Dimension	Capacity
01-001-00369	Ø16 x H6cm	1.1ℓ
01-001-00400	Ø18 x H6cm	1.4ℓ
01-001-00370	Ø20 x H6.5cm	1.6ℓ
01-001-00371	Ø24 x H7.5cm	2.7ℓ



SAFICO *Stainless Steel Lid*

Product Code	Dimension
01-001-00334	Ø16cm
01-001-00335	Ø20cm
01-001-00336	Ø24cm
01-001-00337	Ø28cm
01-001-00338	Ø32cm
01-001-00339	Ø36cm
01-001-00340	Ø40cm
01-001-00341	Ø45cm
01-001-00342	Ø50cm
01-001-00343	Ø60cm

SAFICO
HANDPICKED QUALITY

Premium Quality for the
Professional Kitchen

SAFICO 16/8 S.S.

DE BUYER - INOCUIVRE (INDUCTION-USABLE) RANGE

The union of copper and stainless steel on induction hobs. Copper exterior ensures excellent heat diffusion. Stainless steel interior translates to ease of use and maintenance. Ergonomic cast stainless steel riveted handles.



DE BUYER PRIMA MATERA Copper Casserole with Stainless Steel Lid Induction-Usable

Product Code	Dimension	Capacity
01-001-00359(XX)	Ø20 x H10.3cm	3.3ℓ
01-001-00360(XX)	Ø24 x H12.3cm	5.4ℓ
01-001-00358	Ø28 x H13.5cm	8.0ℓ

DE BUYER PRIMA MATERA Copper Shallow Casserole with Stainless Steel Lid Induction-Usable

Product Code	Dimension	Capacity
01-001-00365	Ø24 x H7.4cm	3.1ℓ



DE BUYER PRIMA MATERA Copper Saucepan Induction-Usable

Product Code	Dimension	Capacity
01-001-00208	Ø14 x H7.8cm	1.2ℓ
01-001-00211(XX)	Ø16 x H9cm	1.8ℓ
01-001-00209	Ø18 x H10cm	2.5ℓ
01-001-00210	Ø20 x H11cm	3.3ℓ
01-001-00212(XX)	Ø24 x H13cm	6.0ℓ

DE BUYER PRIMA MATERA Copper Conical Sauteuse Pan Induction-Usable

Product Code	Dimension	Capacity
01-001-00366(XX)	Ø24 x H8.2cm	3.1ℓ



DE BUYER PRIMA MATERA Copper Frying Pan Induction-Usable

Product Code	Dimension
01-001-00432	Ø24 x H4cm
01-001-00433(XX)	Ø28 x H3.9cm

DE BUYER PRIMA MATERA Copper Sauteuse Induction-Usable

Product Code	Dimension	Capacity
01-001-00363	Ø16 x H5.8cm	1ℓ
01-001-00362(XX)	Ø20 x H6cm	1.8ℓ
01-001-00364	Ø24 x H7.5cm	3ℓ

MAUVIEL COPPERWARE

Enjoy a combination of two powerful and traditional materials - copper and stainless steel. This blend of materials energizes the pleasure of cooking. The copper allows for unsurpassed heat conductivity and control. The stainless steel interior is ideal for all daily cooking needs and allows for easy maintenance. The riveted bronze handles give a thick, solid grip. Go from stove to table-top with the pleasing aesthetics of copperware. Used by professionals throughout the world.



MAUVIEL M' HERITAGE Copper Stewpan with Lid & Bronze Handle
Stainless Steel Interior

Product Code	Dimension	Capacity
01-001-00062	Ø12 x H7cm	0.8ℓ
01-001-00063	Ø16 x H9cm	1.8ℓ
01-001-00064	Ø20 x H10.5cm	3.3ℓ
01-001-00353	Ø24 x H11.5cm	5.2ℓ



MAUVIEL Copper Saucepan with Lid & Induction Base

Product Code	Dimension	Capacity
01-001-00215(XX)	Ø10 x H4.5cm	1.1ℓ



MAUVIEL M' HERITAGE Copper Oval Stewpan with Lid & Bronze Handle
Stainless Steel Interior

Product Code	Dimension	Capacity
01-001-00061	Ø30 x H12.5cm	6.6ℓ



MAUVIEL Copper Saucepan with Induction Base

Product Code	Dimension	Capacity
01-001-00214(XX)	Ø16 x H6cm	0.32ℓ



MAUVIEL M' HERITAGE Copper Saucepan with Bronze Handle
Stainless Steel Interior

Product Code	Dimension	Capacity
01-001-00199	Ø12 x H6.5cm	0.8ℓ
01-001-00200	Ø14 x H7cm	1.1ℓ
01-001-01161	Ø16 x H8.5cm	1.7ℓ
01-001-00201	Ø18 x H9cm	2.3ℓ
01-001-00202	Ø20 x H10cm	3.2ℓ



MAUVIEL M' HERITAGE Copper Sauteuse with Bronze Handle with
Stainless Steel Interior

Product Code	Dimension	Capacity
01-001-00354	Ø16 x H5cm	1.0ℓ
01-001-00355	Ø20 x H6cm	1.8ℓ
01-001-00356	Ø24 x H7cm	3.0ℓ



MAUVIEL M' HERITAGE Copper Lid with Bronze Handle

Product Code	Dimension
01-001-00293	Ø16cm
01-001-00294	Ø20cm



MAUVIEL M' PASSION Copper Sugar Saucepan

Product Code	Dimension	Capacity
01-001-00206	Ø14 x H8cm	1.2ℓ
01-001-00204	Ø16 x H9cm	1.8ℓ
01-001-00205	Ø18 x H10cm	2.5ℓ
01-001-00207	Ø20 x H11cm	3.5ℓ



MAUVIEL M' PASSION Copper Syrup Pan

Product Code	Dimension	Capacity
01-001-00840(XX)	Ø26 x H3cm	4.6ℓ



MAUVIEL M' PASSION Copper Zabagliones Pan

Product Code	Dimension	Capacity
01-001-00841(XX)	Ø16 x H12cm	1.8ℓ
01-001-00842(XX)	Ø20 x H14.5cm	3.5ℓ



MAUVIEL M' HERITAGE Copper Small Saucepan with Long Bronze
Handle Stainless Steel Interior

Product Code	Dimension	Capacity
01-001-00203(XX)	Ø9 x H4.5cm	0.3ℓ



MAUVIEL M' MINIS Copper Mini Saucepan with Lid and Bronze Handle
Stainless Steel Interior

Product Code	Dimension	Capacity
01-001-00213(XX)	Ø9 x H4.5cm	0.3ℓ



MAUVIEL M' MINIS Copper Mini Saute Pan with Bronze Handle
Stainless Steel Interior

Product Code	Dimension	Capacity
01-001-00347	Ø7cm	0.1ℓ



MAUVIEL M' MINIS Copper Splayed Saute Pan without Lid

Product Code	Dimension	Capacity
01-001-00357	Ø9cm	0.1ℓ



MAUVIEL M' MINIS Copper Mini Frying Pan with Bronze Handle
Stainless Steel Interior

Product Code	Dimension
01-001-00425	Ø12 x H2.5cm



MAUVIEL M' HERITAGE Copper Round Frying Pan with Bronze Handle
Stainless Steel Interior

Product Code	Dimension
01-001-00429	Ø20 x H3cm
01-001-00430	Ø26 x H4cm
01-001-00431	Ø30 x H4cm



MAUVIEL M' HERITAGE Copper Oval Frying Pan with Bronze Handle
Stainless Steel Interior

Product Code	Dimension
01-001-00426	35 x 23 x 4.5cm
01-001-00434(XX)	Ø35 x H4.2cm



MAUVIEL M' HERITAGE Copper Round Paella Pan with Bronze
Handles Stainless Steel Interior

Product Code	Dimension
01-001-00593	Ø32 x H4.8cm



MAUVIEL M' HERITAGE Copper Oval Pan with 2 Bronze Handles
Stainless Steel Interior

Product Code	Dimension
01-001-00349(XX)	30 x 20 x 4cm
01-001-00348	35 x 23 x 4.5cm



MAUVIEL M' PASSION Copper Eggwhite Beating Bowl with Handle

Product Code	Dimension	Capacity
02-002-00042(XX)	Ø26 x H13cm	4.6ℓ
02-002-00043	Ø30 x H15cm	7.0ℓ
02-002-00044(XX)	Ø35 x H18cm	12.0ℓ
02-002-00045	Ø40 x H20cm	16.7ℓ



MAUVIEL M' PASSION Copper Eggwhite Beating Bowl with Ring

Product Code	Dimension	Capacity
02-002-00046	Ø26 x H13cm	4.6ℓ
02-002-00047	Ø30 x H15cm	7.0ℓ
02-002-00048	Ø35 x H18cm	12.0ℓ
02-002-00049	Ø40 x H20cm	16.7ℓ



MAUVIEL M' TRADITION Copper Hammered Fish Kettle with Grid and
Lid

Product Code	Dimension	Capacity
01-001-00839(XX)	60 x 15 x 13cm	10.0ℓ



MAUVIEL Copper Polish "Copperbrill"

Product Code	Capacity
07-004-00012	0.15ℓ

LAVA

Every product from LAVA is unique and handmade by skilled craftsmen who have generations of experience with cast iron. Because LAVA products are handmade, there are slight variations that give that wonderful, authentic feel.



LAVA TRENDY Cast Iron Round Mini Casserole

Dimension	Capacity	Black	Blue	Green	Light Purple	Orange	Red	Grey
Ø10 x 7cm	0.35ℓ	01-001-01171	01-001-01170	01-001-01172	01-001-01174	01-001-01175	01-001-01176	01-001-01173



LAVA FOLK Cast Iron Round Mini Casserole

Dimension	Capacity	Black	Blue	Green	Light Purple	Orange	Red
Ø10 x 7cm	0.35ℓ	01-001-00749	01-001-00748	01-001-00750	01-001-00745	01-001-00746	01-001-00747

ACCESSORIES

- 3 Holes Wooden Stand for Mini Casserole (55 x 19 x 7cm): 01-001-00794



LAVA TRENDY Cast Iron Oval Mini Casserole

Dimension	Capacity	Black	Blue	Green	Orange	Red	Yellow
Ø9 x 6cm	0.42ℓ	01-001-01208	01-001-01207	01-001-01209	01-001-01210	01-001-01211	01-001-01212



LAVA TRENDY Cast Iron Round Casserole

Dimension	Capacity	Black	Blue	Orange	Red
Ø14cm	0.8ℓ	01-001-01214	01-001-01213	01-001-01215	01-001-01216
Ø18cm	1.7ℓ	01-001-01218	01-001-01217		01-001-01219
Ø20cm	2.6ℓ	01-001-01220		01-001-01221	01-001-01222
Ø24cm	4.5ℓ	01-001-01223		01-001-01224	01-001-01225
Ø28cm	6.7ℓ	01-001-01226		01-001-01227	01-001-01228
Ø32cm	10.0ℓ	01-001-01229		01-001-01230	01-001-01231



LAVA FOLK Cast Iron Round Casserole

Dimension	Capacity	Black	Blue	Green	Light Purple	Orange	Red
Ø20cm	2.6ℓ	01-001-00707	01-001-00706	01-001-00708	01-001-00709	01-001-00710	01-001-00711
Ø24cm	4.5ℓ	01-001-00713	01-001-00712	01-001-00714	01-001-00715	01-001-00716	01-001-00717
Ø28cm	6.7ℓ	01-001-00719	01-001-00718	01-001-00720	01-001-00721	01-001-00722	01-001-00723



LAVA TRENDY Cast Iron Round Low Casserole

Dimension	Capacity	Black	Red
Ø24cm	2.4ℓ	01-001-01245	01-001-01246
Ø28cm	3.5ℓ	01-001-01247	01-001-01248
Ø32cm	5.7ℓ	01-001-01249	01-001-01250



LAVA FOLK Cast Iron Round Low Casserole

Dimension	Capacity	Range	Black	Blue	Green	Light Purple	Orange	Red
Ø24cm	2.4ℓ	Folk	01-001-00758	01-001-00757	01-001-00759	01-001-00760	01-001-00761	01-001-00762
Ø28cm	3.4ℓ	Folk	01-001-00752	01-001-00751	01-001-00753	01-001-00754	01-001-00755	01-001-00756



LAVA TRENDY Cast Iron Oval Casserole

Dimension	Capacity	Black	Orange	Red
21 x 32 x 11cm	3.2ℓ	01-001-01232	01-001-01233	01-001-01234
21 x 34 x 12cm	4.0ℓ	01-001-01235	01-001-01236	01-001-01237
23 x 36 x 12cm	4.7ℓ	01-001-01238	01-001-01239	01-001-01240
25.5 x 38.5 x 15cm	7.0ℓ	01-001-01242		01-001-01241
26.5 x 40 x 12cm	6.4ℓ	01-001-01243		01-001-01244



LAVA FOLK Cast Iron Oval Casserole

Dimension	Capacity	Black	Blue	Green	Light Purple	Orange	Red
Ø25cm	3.3ℓ	01-001-00668	01-001-00667	01-001-00669	01-001-00670	01-001-00671	01-001-00672
Ø27cm	4.0ℓ	01-001-00674	01-001-00673	01-001-00675	01-001-00676	01-001-00677	01-001-00678
Ø29cm	4.8ℓ	01-001-00680	01-001-00679	01-001-00681	01-001-00682	01-001-00683	01-001-00684



LAVA Cast Iron Multi-Purpose Casseroles with Dome Lid

Dimension	Capacity	Blue	Orange	Green	Red
Ø29.5 x 8cm	3.5ℓ	01-001-01047	01-001-01048	01-001-01049	01-001-01046



LAVA Cast Iron Round Casserole

Product Code	Dimension	Capacity
01-001-01045	Ø26 x 13cm	4.7ℓ

LAVA ECO Cast Iron Turkish Wok with Glass Lid & Metal Handle

Product Code	Dimension	Capacity	Colour
01-001-00775	Ø28cm	1.6ℓ	Black



LAVA Cast Iron Sauce Pan with Metal Handle

Dimension	Capacity	Black	Green	Red
Ø16cm	1.35ℓ	01-001-01180	01-001-01179	01-001-01178



LAVA Cast Iron Round Pan with Metal Handle

Dimension	Black	Blue	Green	Light Purple	Orange	Red
Ø16cm	01-001-00805(XX)	01-001-00804(XX)	01-001-00806(XX)	01-001-00807(XX)	01-001-00808(XX)	01-001-00809(XX)
Ø20cm	01-001-00811(XX)	01-001-00810	01-001-00812(XX)	01-001-00813(XX)	01-001-00814	01-001-00815



LAVA Cast Iron Round Pan with Wooden Handle

Dimension	Black	Blue	Green	Light Purple	Orange	Red
Ø24cm	01-001-00817(XX)	01-001-00816(XX)	01-001-00818(XX)	01-001-00819(XX)	01-001-00820(XX)	01-001-00821(XX)
Ø28cm	01-001-00823(XX)	01-001-00822(XX)	01-001-00824(XX)	01-001-00825(XX)	01-001-00826(XX)	01-001-00827(XX)



LAVA Cast Iron Rectangle Roasting Dish

Dimension	Capacity	Black	Blue	Green	Light Purple	Orange	Red
22 x 30cm	2.65ℓ	01-001-00867	01-001-00866				01-001-00868
26 x 40cm	5.0ℓ	01-001-00870	01-001-00869	01-001-00872(XX)	01-001-00873(XX)	01-001-00874(XX)	01-001-00871



LAVA Cast Iron Griddle Grill with Integral Metal Handle

Dimension	Blue	Red	Black
26 x 45cm	01-001-01051	01-001-01050	01-001-01164(XX)



LAVA ECO Cast Iron Round Pan with Wooden Underliner

Product Code	Dimension
01-001-00743	Ø12cm
01-001-00741	Ø16cm
01-001-00742	Ø20cm



LAVA Cast Iron Cookware Set (Deep Skillet & Frying Pan)

Product Code	Dimension
01-001-01044	Deep Skillet: Ø26cm Frying Pan: Ø26cm



LAVA Cast Iron Enamelled Round Dish

Dimension	Blue	Red
Ø30cm	13-002-00008	13-002-00009



LAVA Cast Iron Rectangle Terrine Pot

Dimension	Black	Blue	Green	Light Purple	Orange	Red
26.5 x 8.5 x 7cm	01-001-00704	01-001-00703	01-001-00801(XX)	01-001-00802(XX)	01-001-00803	01-001-00705



LAVA Cast Iron Grill Pan with Metal Handle

Dimension	Type	Black	Blue	Red
26 x 32cm	Rectangle	01-001-00563	01-001-00562	01-001-00564
26 x 26cm	Square	01-001-00573	01-001-00572	01-001-00574



LAVA ECO Cast Iron Grill Pan

Dimension	Type	Metal Handle	With Wooden Stand
21 x 30cm	Rectangle	01-001-00566	-
26 x 32cm	Rectangle	01-001-00700	01-001-00701
26 x 26cm	Square	01-001-00771	01-001-00770



LAVA ECO Cast Iron Round Grill Pan

Product Code	Dimension	
01-001-00570	Ø30cm	with Metal Handle
01-001-01162(XX)	Ø25cm	with Wire Handle
01-001-01163(XX)	Ø25cm	with Wire Handle & Wooden Platter



LAVA ECO Cast Iron Square Mini Grill Skillet

Product Code	Dimension	
01-001-00774	16cm	with Wooden Underliner
01-001-00773	16cm	with Wooden Serving Tray
01-001-00772	12cm	with Wooden Underliner



LAVA Wooden Platter with Magnetic Feature

Product Code	Dimension
01-001-00834(XX)	Ø16cm
01-001-00835(XX)	Ø20cm
01-001-00836(XX)	Ø24cm
01-001-00837(XX)	Ø28cm



Grill Pans



LODGE Cast Iron Skillet with Spout

Product Code	Dimension
01-001-01169	25.87 x 16.98 x 3.49cm
01-001-00419	32 x 21.9 x 5cm
01-001-00420	34.9 x 24.4 x 5cm
01-001-00421	40.97 x 26 x 5.7cm
01-001-00417	45.72 x 30.48 x 5.71cm
01-001-00418	51.43 x 33.65 x 6.35cm



LODGE Round Cast Iron Grill Pan with Handle

Product Code	Dimension
01-001-01088	10.25"



LODGE Square Cast Iron Grill Pan with Handle

Product Code	Dimension
01-001-01089	10.5"

STAUB CAST IRON COOKWARE

The Staub range, a superior quality enameled cast iron cookware, is perfect for all cooks. Novices or experienced chefs will be able to recreate traditional recipes. Or use their imagination to create new ones.



STAUB Cast Iron Round Cocotte

Dimension	Capacity	Cherry	Black
Ø10cm	0.25ℓ	01-001-00633	01-001-00632
Ø12cm	0.4ℓ	01-001-00726(XX)	
Ø14cm	0.8ℓ	01-001-00635	01-001-00728(XX)
Ø16cm	1.4ℓ	01-001-00729(XX)	
Ø18cm	1.7ℓ	01-001-00637	01-001-00636
Ø20cm	2.2ℓ	01-001-00639	01-001-00638
Ø22cm	2.6ℓ	01-001-00732	01-001-00731
Ø24cm	3.8ℓ	01-001-00641	01-001-00640
Ø26cm	5.25ℓ	01-001-00735	Available
Ø28cm	6.7ℓ	01-001-00644	01-001-00643
Ø30cm	8.35ℓ	01-001-00737(XX)	01-001-00736(XX)
Ø34cm	12.6ℓ	01-001-00739(XX)	



STAUB Bamboo Stand for 3 Round Mini Cocottes

Product Code	Dimension
01-001-00664(XX)	42 x 16 x 5cm



STAUB Cast Iron Oval Cocotte

Dimension	Capacity	Cherry	Black
Ø11cm	0.25ℓ	01-001-00607	01-001-00620
Ø15cm	0.6ℓ		01-001-00685(XX)
Ø17cm	1.0ℓ		01-001-00694(XX)
Ø23cm	2.35ℓ	01-001-00621(XX)	01-001-00615(XX)
Ø27cm	3.2ℓ	01-001-00609	01-001-00610
Ø29cm	4.2ℓ	01-001-00686	01-001-00688
Ø31cm	5.5ℓ	01-001-00617(XX)	01-001-00618(XX)
Ø33cm	6.7ℓ	01-001-00612	01-001-00613
Ø37cm	8.0ℓ	01-001-00691(XX)	01-001-00692(XX)
Ø41cm	12.0ℓ		01-001-00693(XX)



STAUB Cast Iron Round Shallow Cocotte

Dimension	Capacity	Cherry	Black
Ø10cm	0.25ℓ	01-001-00763(XX)	01-001-00764(XX)



STAUB Wooden Stand for 3 Round Mini Cocottes

Product Code	Dimension
01-001-00793(XX)	42 x 16 x 5cm



STAUB Cast Iron Saute Pan with Christera Structure

Dimension	Cherry	Black
Ø28cm	01-001-00782(XX)	01-001-00784(XX)



STAUB Cast Iron Saute Pan with Lid

Dimension	Cherry	Black
Ø24 x H14cm	01-001-00659(XX)	01-001-00660(XX)
Ø28 x H13.2cm	01-001-00661(XX)	01-001-00662(XX)



STAUB Cast Iron Round Pure Grill

Dimension	Black
Ø26cm	01-001-00569(XX)

*Please enquire for other colours Stocks are available subject to availability.

STAUB Cast Iron Round Grill with Silicone Handle

Dimension	Black
Ø27cm	01-001-00571(XX)

STAUB Cast Iron Rectangle Grill Pan with Silicone Handle

Dimension	Black
34 x 21cm	01-001-00565(XX)

STAUB Cast Iron American Square Grill Pan

Dimension	Cherry	Black
26 x 26cm	01-001-00558	01-001-00557

STAUB Cast Iron Round Hot Plate with Lid

Dimension	Black
Ø20cm	01-001-00781(XX)

STAUB Cast Iron Round Stackable Dish

Dimension	Cherry	Black
Ø12 x H4.2cm		01-001-00657(XX)
Ø16 x H5cm	01-001-00654	01-001-00655
Ø20 x H5.6cm	01-001-00658(XX)	01-001-00656

STAUB Cast Iron Oval Stackable Dish

Dimension	Cherry	Black
15 x 10.7 x 5.2cm		01-001-00625(XX)
21 x 15.2 x 6cm	01-001-00626(XX)	01-001-00623
24 x 17.8 x 6.6cm	01-001-00628(XX)	01-001-00629(XX)
28 x 20 x 7cm		01-001-00624
32 x 23.3 x 7cm		01-001-00627(XX)

STAUB Cast Iron Mini Pot without Lid

Dimension	Black
Ø11.5 x H5.7cm	01-001-00604(XX)

STAUB Cast Iron Mini Rectangle Dish

Dimension	Black
15 x 11cm	01-001-00605(XX)

STAUB Cast Iron Rectangle Roasting Dish

Dimension	Black
33 x 26.8 x 3.5cm	01-001-00630(XX)

STAUB Cast Iron Rectangle Serving Dish with Wooden Base Board

Dimension	Black
33 x 23cm	01-001-00780(XX)



STAUB Ceramic Rectangular Gratin Dish

Dimension	■ Cherry	□ White
20 x 16cm	01-001-00799(XX)	01-001-00800(XX)



STAUB Cast Iron Base and Ceramic Top Tajine

Dimension	■ Cherry	■ Cream
Ø28 x H20.3cm	01-001-00600(XX)	01-001-00602(XX)



STAUB Cast Iron Rectangle Terrine

Dimension	Capacity	■ Black
15 x 11cm	0.7ℓ	01-001-00663(XX)
30 x 11cm	1.45ℓ	01-001-00631



STAUB Cast Iron Round Small Sauce Pan

Dimension	■ Graphite	■ Black
Ø10 x H7.2cm	01-001-00649(XX)	01-001-00650(XX)
Ø14 x H15.3cm	01-001-00651(XX)	01-001-00652(XX)



STAUB Cast Iron Round Sauce Pan

Dimension	■ Graphite	■ Black
Ø18 x H19.4cm	01-001-00646(XX)	01-001-00647(XX)



STAUB Cast Iron Saute Pan with Glass Lid

Dimension	■ Black
Ø24cm	01-001-00788(XX)



STAUB Cast Iron Baby Wok with Glass Lid

Dimension	■ Black
Ø16 x H10.2cm	01-001-00907(XX)



STAUB Cast Iron Mini Frying Pan with Handle

Dimension	■ Black
Ø12cm	01-001-00666(XX)



STAUB Cast Iron Round Pan with Handle

Dimension	■ Black
Ø28cm	01-001-00416(XX)
Ø24cm	01-001-00422(XX)



STAUB Cast Iron Pancake Pan with Wooden Handle

Dimension	■ Black
Ø28cm	01-001-00575(XX)

*Please enquire for other colours Stocks are available subject to availability.



STAUB Cast Iron Round Small Sauce Pan

Dimension	Capacity	Cherry	Black
Ø16.5cm	1.15ℓ	01-001-00923(XX)	01-001-00922(XX)

DE BUYER CHOC EXTREME

The Choc Extreme range is composed of cast aluminium cookware covered with a high end scratch-resistant non-stick coating, of professional and superior quality. Choc Extreme cookware has a high inertia capacity and is perfect for simmering and stewing. Range suitable for induction cooking,



DE BUYER CHOC EXTREME Cast Aluminium Non-Stick Casserole with Glass Lid

Product Code	Dimension	Capacity
01-001-00150	Ø24 x H9.5cm	4.7ℓ
01-001-00151	Ø28 x H12cm	7.0ℓ



DE BUYER CHOC EXTREME Cast Aluminium Non-Stick Low Casserole

Product Code	Dimension	Capacity
01-001-00152	Ø20 x H7.5cm	1.78ℓ
01-001-00153	Ø24 x H7.5cm	2.68ℓ
01-001-00154	Ø28 x H7.5cm	3.78ℓ



DE BUYER CHOC EXTREME Cast Aluminium Non-Stick Frying Pan with Stainless Steel Handle

Product Code	Dimension
01-001-00543	Ø20 x H4.5cm
01-001-00544	Ø24 x H4.5cm
01-001-00542	Ø28 x H4.5cm
01-001-00545	Ø32 x H4.5cm
01-001-00546	Ø36 x H4.5cm



DE BUYER CHOC EXTREME Cast Aluminium Non-Stick Frying Pan with Cast Stainless Steel Handle

Product Code	Dimension
01-001-00539	Ø20 x H3.7cm
01-001-00538	Ø24 x H4.5cm
01-001-00540	Ø28 x H4cm
01-001-00541	Ø32 x H3.7cm

LACOR CAST ALUMINIUM



LACOR Cast Aluminium Round Casserole

Product Code	Dimension	Capacity
01-001-01150	Ø16 x H7cm	1.3ℓ
01-001-01151	Ø20 x H8cm	2.4ℓ
01-001-01152	Ø24 x H10cm	4.2ℓ
01-001-01154	Ø28 x H11.5cm	6.7ℓ



LACOR Cast Aluminium Oval Casserole

Product Code	Dimension	Capacity
01-001-01153	26 x 20 x 9cm	3.5ℓ
01-001-01155	31 x 25 x 11cm	6.3ℓ



LACOR Aluminium Stock Pot with Lid

Product Code	Dimension	Capacity
01-001-01156	Ø50 x H50cm	100.0ℓ
01-001-01157	Ø55 x H55cm	130.0ℓ
01-001-01158	Ø60 x H60cm	170.0ℓ



LACOR ROBUST Aluminium Heavy-Duty Pressure Cooker

Product Code	Dimension	Capacity
01-001-00926	Ø42 x H31cm	30.0ℓ
01-001-01159	Ø42 x H46cm	50.0ℓ



ALEGACY OPTIMA III Aluminium Stock Pot

Product Code	Dimension	Capacity
01-001-00003	Ø9.1/2 x H8.1/4"	9.5ℓ
01-001-00001	Ø10 x H9.1/4"	11.4ℓ
01-001-00002	Ø11 x H10"	15.1ℓ
01-001-00004	Ø12 x H11"	18.9ℓ
01-001-00005	Ø12.1/2 x H11.3/8"	22.7ℓ
01-001-00006	Ø14 x H13"	30.3ℓ
01-001-00007	Ø14.1/2 x H14.1/4"	37.9ℓ
01-001-00008	Ø17.1/4 x H16"	56.8ℓ
01-001-00009	Ø19 x H16.3/4"	75.7ℓ



ALEGACY OPTIMA III Aluminium Lid

Product Code	Dimension	For
01-001-00283	Ø9.1/2"	01-001-00003
01-001-00284	Ø10"	01-001-00001
01-001-00285	Ø11"	01-001-00002
01-001-00286	Ø12"	01-001-00004
01-001-00287	Ø12.1/2"	01-001-00005
01-001-00288	Ø14"	01-001-00006
01-001-00289	Ø14.1/2"	01-001-00007
01-001-00290	Ø17.1/4"	01-001-00008
01-001-00291	Ø19"	01-001-00009



ALEGACY OPTIMA III Aluminium Sauce Pan

Product Code	Dimension	Capacity
01-001-00194	Ø6 x H3.1/2"	1.4ℓ
01-001-00195	Ø7.5/8 x H4"	2.6ℓ
01-001-00192	Ø9 x H4"	3.5ℓ
01-001-00193	Ø9 x H5"	4.2ℓ
01-001-00196	Ø9.3/4 x H5"	5.2ℓ
01-001-00197	Ø10.1/2 x H5.1/4"	6.6ℓ



ALEGACY OPTIMA III Aluminium Lid

Product Code	Dimension	For
01-001-00277	Ø6"	01-001-00194
01-001-00278	Ø7.5/8"	01-001-00195
01-001-00279	Ø9"	01-001-00192
01-001-00280	Ø9"	01-001-00193
01-001-00281	Ø9.3/4"	01-001-00196
01-001-00282	Ø10.1/2"	01-001-00197



Stainless Steel Bain Marie (Square)

Product Code	Dimension	Capacity
01-001-00163	15.5 x 15.5 x 7.5cm	1.5ℓ
01-001-00166	15.5 x 15.5 x 16cm	3.8ℓ
01-001-00167	15.5 x 15.5 x 23.5cm	5.0ℓ
01-001-00164	24 x 24 x 7.5cm	4.0ℓ
01-001-00165	24 x 24 x 16cm	9.0ℓ
01-001-00162	24 x 24 x 23.5cm	13.0ℓ



Stainless Steel Lid for Bain Marie (Square)

Product Code	Dimension	For
01-001-00158	15.5 x 15.5cm (Square)	01-001-00163 01-001-00166 01-001-00167
01-001-00157	24 x 24cm (Square)	01-001-00164 01-001-00165 01-001-00162



Stainless Steel Bain Marie (Rectangle)

Product Code	Dimension	Capacity
01-001-00161	15.5 x 10.5 x 5.5cm	0.5ℓ
01-001-00159	15.5 x 10.5 x 7.5cm	1.0ℓ
01-001-00160	15.5 x 10.5 x 16cm	2.5ℓ



Stainless Steel Lid for Bain Marie (Rectangle)

Product Code	Dimension	For
01-001-00156	15.5 x 10.5cm (Rectangle)	01-001-00161 01-001-00159 01-001-00160



Stainless Steel Bain Marie Pot

Product Code	Dimension	Capacity
01-001-00188	Ø17.5 x H21cm	3.8ℓ
01-001-00189	Ø22.5 x H22cm	6.6ℓ
01-001-00190	Ø27 x H21.5cm	10.4ℓ



Stainless Steel Cover for Brain Marie Pot

Product Code	Type	For
01-001-00169	Cover	01-001-00188
01-001-00170	Cover	01-001-00189
01-001-00168	Cover	01-001-00190
01-001-00186	Flexible Cover	01-001-00189
01-001-00187	Flexible Cover	01-001-00190



Stainless Steel Bain Marie Pot

Product Code	Dimension	Capacity
01-001-00171	Ø10.5 x H14cm	1.2ℓ
01-001-00172	Ø12.8 x H17cm	1.9ℓ
01-001-00173	Ø15.5 x H18cm	3.3ℓ
01-001-00174	Ø16.5 x H19cm	4.0ℓ
01-001-00175	Ø18 x H21.5cm	5.7ℓ
01-001-00176	Ø20 x H24.5cm	7.8ℓ
01-001-00177	Ø23 x H26.5cm	11.4ℓ



Stainless Steel Cover for Brain Marie Pot

Product Code	For
01-001-00179	01-001-00171
01-001-00180	01-001-00172
01-001-00181	01-001-00173
01-001-00182	01-001-00174
01-001-00183	01-001-00175
01-001-00184	01-001-00176
01-001-00185	01-001-00177



LACOR Stainless Steel Fish Kettle with Grill and Lid

Product Code	Dimension	Capacity
01-001-00975(XX)	40 x 17 x 9.5cm	10.0ℓ
01-001-00976(XX)	50 x 17.5 x 11cm	13.8ℓ
01-001-00973	60 x 19.5 x 12cm	20.8ℓ



LACOR Aluminium Fish Kettle with Grill and Lid

Product Code	Dimension	Capacity
01-001-00974(XX)	70 x 22 x 20.8cm	14.5ℓ

FRYING PANS



LACOR CHEF CLASSIC Stainless Steel Frying Pan

Product Code	Dimension
01-001-00443	Ø20 x H4cm
01-001-00444	Ø24 x H4.5cm
01-001-00445	Ø28 x H5.5cm
01-001-00446	Ø32 x H6cm
01-001-00447	Ø36 x H6.5cm
01-001-00448	Ø40 x H6.5cm



SAFICO Stainless Steel Frying Pan

Product Code	Dimension
01-001-00455	Ø20 x H4.5cm
01-001-00456	Ø24 x H5cm
01-001-00457	Ø28 x H5cm
01-001-00458	Ø32 x H5.5cm
01-001-00459	Ø36 x H6.5cm
01-001-00460	Ø40 x H7cm



EAGLEWARE Aluminium Frying Pan with Insulating Grip

Product Code	Dimension
01-001-00406	Ø7" / 18cm
01-001-00407	Ø8" / 20cm
01-001-00408	Ø10" / 25cm
01-001-00409	Ø12" / 30cm
01-001-00410	Ø14" / 35cm



ALEGACY OPTIMA III Aluminium Frying Pan with Insulating Handle

Product Code	Dimension
01-001-00411	Ø7" / 17.5cm
01-001-00412	Ø8" / 20cm
01-001-00413	Ø10" / 25cm
01-001-00414	Ø12" / 30cm
01-001-00415	Ø14" / 35cm



DE BUYER Blue Steel Lyonnaise Frying Pan

Product Code	Dimension
01-001-00477	Ø18 x H4cm
01-001-00478	Ø20 x H4.2cm
01-001-00480	Ø24 x H8cm
01-001-00481	Ø26 x H5cm
01-001-00482	Ø28 x H5.1cm
01-001-00483	Ø30 x H5.5cm
01-001-00476	Ø32 x H5.8cm
01-001-00484	Ø36 x H6.2cm
01-001-00485	Ø40 x H7cm
01-001-00486	Ø45 x H7.5cm



DE BUYER CARBONE PLUS Black Steel Heavy Duty Lyonnaise Frying Pan

Product Code	Dimension
01-001-00471	Ø20 x H3.3cm
01-001-00470	Ø24 x H3.9cm
01-001-00472	Ø28 x H4cm



LACOR Black Steel Frying Pan

Product Code	Dimension
01-001-00938	Ø20 x H3.5cm
01-001-00934	Ø24 x H4.5cm
01-001-00935	Ø28 x H5cm
01-001-00936	Ø32 x H5.3cm
01-001-00937	Ø36 x H5.5cm
01-001-00939	Ø40 x H5.8cm



LACOR CHEF CLASSIC Stainless Steel Non-Stick Frying Pan

Product Code	Dimension
01-001-00547	Ø20 x H4cm
01-001-00548	Ø24 x H4.5cm
01-001-00549	Ø28 x H5.5cm
01-001-00550	Ø32 x H6cm
01-001-00551	Ø36 x H6.5cm
01-001-00454	Ø40 x H6.5cm



SAFICO Stainless Steel Non-Stick Frying Pan

Product Code	Dimension
01-001-00552	Ø20 x H4.5cm
01-001-00553	Ø24 x H4.5cm
01-001-00554	Ø28 x H5cm
01-001-00555	Ø32 x H5.5cm



DE BUYER CHOC Aluminium Non-Stick Fry-Pan

Dimension	Induction	Black	Blue	Yellow	Green	Red
Ø20 x H3cm	Induction	01-001-01068	01-001-01060	01-001-01056	01-001-01064	01-001-01052
	Non-Induction	01-001-00523	01-001-00507	01-001-00520	01-001-00511	01-001-00515
Ø24 x H3.5cm	Induction	01-001-01069	01-001-01061	01-001-01057	01-001-01065	01-001-01053
	Non-Induction	01-001-00524	01-001-00508	01-001-00521	01-001-00513	01-001-00516
Ø28 x H4cm	Induction	01-001-01070	01-001-01062	01-001-01058	01-001-01066	01-001-01054
	Non-Induction	01-001-00525	01-001-00509	01-001-00519	01-001-00512	01-001-00517
Ø32 x H4.5cm	Induction	01-001-01071	01-001-01063	01-001-01059	01-001-01067	01-001-01055
	Non-Induction	01-001-00526	01-001-00510	01-001-00522	01-001-00514	01-001-00518
Ø36 x H4.8cm	Induction	01-001-01072				
	Non-Induction	01-001-00527				
Ø40 x H5.4cm	Induction					
	Non-Induction	01-001-00528				



DE BUYER CHOC Aluminium Non-Stick Fry Pan with Special Handle for Oven Cooking at High Temperature

Product Code	Dimension
01-001-01075	Ø20 x H3cm
01-001-01076	Ø24 x H3.5cm
01-001-01077	Ø28 x H3.8cm



DE BUYER CHOC Non-Stick Conical Saute Pan

Product Code	Dimension
01-001-00404	Ø24cm
01-001-00405	Ø28cm



ALEGACY EAGLEWARE Aluminium Non-Stick Frying Pan

Product Code	Dimension
01-001-00498	Ø7" / 18cm
01-001-00499	Ø8" / 20cm
01-001-00500	Ø10" / 25cm
01-001-00501	Ø12" / 30cm
01-001-00502	Ø14" / 35cm



ZEBRA GEMINI Aluminium Non-Stick Deep Frying Pan

Product Code	Dimension
01-001-00503	Ø26 x H8cm
01-001-00505	Ø30 x H8.5cm



ZEBRA GEMINI Aluminium Non-Stick Frying Pan

Product Code	Dimension
01-001-00496	Ø24 x H5.5cm
01-001-00497	Ø28 x H6cm



LACOR Aluminium Non-Stick Paella Pan

Product Code	Dimension
01-001-00957	Ø24 x H4cm
01-001-00958	Ø28 x H4.5cm
01-001-00959	Ø32 x H5cm
01-001-00960	Ø36 x H5.5cm
01-001-00961	Ø40 x H6cm



LACOR Alum Non-Stick Frying Pan

Product Code	Dimension
01-001-00947	Ø20 x H4cm
01-001-00927	Ø24 x H4.5cm
01-001-00928	Ø26 x H4.5cm
01-001-00948	Ø28 x H4.5cm
01-001-00929	Ø32 x H5cm
01-001-00930	Ø36 x H5.5cm
01-001-00941	Ø40 x H6cm
01-001-00942	Ø16 x H3.5cm
01-001-00943	Ø20 x H4cm
01-001-00944	Ø24 x H4.5cm
01-001-00945	Ø28 x H4.5cm
01-001-00946	Ø32 x H4.7cm
01-001-00940	Ø36 x H5.5cm
01-001-00932	Ø40 x H5.5cm



ALEGACY OPTIMA III Aluminium Non-Stick Frying Pan with Insulating Handle

Product Code	Dimension
01-001-00533	Ø7" / 17.5cm
01-001-00535	Ø8" / 20cm
01-001-00536	Ø10" / 25cm
01-001-00537	Ø12" / 30cm
01-001-00534	Ø14" / 35cm



DE BUYER Aluminium Non-Stick Paella Pan

Product Code	Dimension
01-001-00598	Ø36 x H4.8cm
01-001-00599	Ø40 x H5.4cm



LACOR S/S Paella Pan

Product Code	Dimension
01-001-00966	Ø30 x H4.5cm
01-001-00965	Ø34 x H5cm
01-001-00963	Ø38 x H5.5cm
01-001-00962	Ø42 x H6cm



LACOR Black Steel Paella Pan

Product Code	Dimension
01-001-00970	Ø20 x H4cm
01-001-00967	Ø24 x H4.5cm
01-001-00971	Ø28 x H4.5cm
01-001-00968	Ø32 x H5cm
01-001-00964	Ø36 x H5.5cm
01-001-00969	Ø40 x H6cm



LACOR Aluminium Non-Stick Crepe Pan

Product Code	Dimension
01-001-00949	Ø22cm
01-001-00951	Ø26cm
01-001-00953	Ø30cm



LACOR Aluminium Non-Stick Blinis Pan

Product Code	Dimension
01-001-00956	Ø12cm
01-001-00954	Ø14cm



DE BUYER Black Steel Heavy-Duty Blinis Pan

Product Code	Dimension
01-001-00589	Ø12 x H2cm



DE BUYER AFFINITY Stainless Steel Mini Frying Pan

Product Code	Dimension
01-001-00468	Ø10 x H4.3cm



DE BUYER CHOC Aluminium Non-Stick Crepe Pan

Dimension	Induction	Product Code
Ø22cm	Induction	
	Non-Induction	01-001-00582
Ø26cm	Induction	01-001-01073
	Non-Induction	01-001-00583
Ø30cm	Induction	01-001-01074
	Non-Induction	01-001-00584



DE BUYER Aluminium Non-Stick Blinis Pan

Product Code	Dimension
01-001-00590	Ø12cm
01-001-00591	Ø14cm



LACOR Black Steel Non-Stick Blinis Pan

Product Code	Dimension
01-001-00955	Ø12 x H2.5cm



LACOR Black Steel Non-Stick Crepe Pan

Product Code	Dimension
01-001-00950	Ø22 x H1.8cm
01-001-00952	Ø26 x H2cm



DE BUYER CARBONE PLUS Black Steel Heavy-Duty Oval Frying Pan

Product Code	Dimension
01-001-00473(XX)	32 x 23.5 x 4.6cm
01-001-00474(XX)	36 x 26.5 x 4.8cm



DE BUYER CARBONE PLUS Black Steel Rectangle Frying Pan

Product Code	Dimension
01-001-00475(XX)	38 x 26 x 4.5cm



LACOR ROBUST Alum Non-Stick Oval Frying Pan

Product Code	Dimension
01-001-00931	36 x 26 x 5.2cm
01-001-00933	40 x 29 x 5.7cm



DE BUYER CHOC Aluminium Non-Stick Frying Pan

Product Code	Dimension	Shape
01-001-00529(XX)	36 x 26 x 4.3cm	Oval
01-001-00530(XX)	40 x 28 x 4.5cm	Oval
01-001-00532	38 x 26 x 4.2cm	Rectangle



Non-Stick Frying Pan

Product Code	Dimension
01-001-01030	Ø18cm
01-001-01031	Ø20cm
01-001-01032	Ø22cm
01-001-01033	Ø24cm
01-001-01034	Ø26cm
01-001-01035	Ø28cm
01-001-01036	Ø30cm
01-001-01037	Ø32cm



Non-Stick Alum Standard Grill Pan

Product Code	Dimension	
01-001-01025	53 x 32.5 x 2cm	GN 1/1
01-001-01026	35.4 x 32.5 x 2cm	GN 2/3



Non-Stick Alum Premium Multi-Functional Grill Tray

Product Code	Dimension	
01-001-01027	53 x 32.5 x 8cm	GN 1/1
01-001-01028	35.4 x 32.5 x 8cm	GN 2/3

ASIAN COOKWARE

**DE BUYER INOX** Stainless Steel Wok with 1 Handle (Induction-Usable)

Product Code	Dimension
01-002-00033	Ø36 x 63.5 x 9.5cm

**DE BUYER CARBONE PLUS** Steel Wok (Induction-Usable)

Product Code	Dimension
01-002-00034(XX)	Ø35.5 x H9cm

**LACOR ROBUST** Alum Non-Stick Wok

Product Code	Dimension
01-001-00972	Ø30cm

**DE CHOC** Aluminium Non-Stick Wok

Product Code	Dimension	Capacity
01-001-00914(XX)	Ø32 x H9cm	3.5l

**STAUB** Cast Iron Wok with Glass Lid

Product Code	Dimension	Colour
01-001-00909	Ø37 x H18cm	Black
01-001-00910	Ø37 x H21.3cm	Cherry
01-001-00911(XX)	Ø37 x H18cm	Graphite

**CCK** One Handle Stainless Steel Wok with Wooden Handle

Product Code	Dimension
01-002-00092	Ø13"
01-002-00093	Ø14"
01-002-00094	Ø15"
01-002-00095	Ø16"

**CCK** One Handle Iron Wok with Wooden Handle

Product Code	Dimension
01-002-00087	Ø13"
01-002-00088	Ø14"
01-002-00089	Ø15"
01-002-00090	Ø16"
01-002-00091	Ø18"

**Heavy Duty** Iron Wok with 1 Handle

Product Code	Dimension
01-002-00096	Ø13"
01-002-00097	Ø14"
01-002-00098	Ø15"
01-002-00099	Ø16"



Heavy Duty Iron Wok with 1 Handle

Product Code	Dimension
01-002-00100	Ø12"
01-002-00101	Ø13"
01-002-00102	Ø14"
01-002-00103	Ø15"
01-002-00104	Ø16"



Heavy Duty Iron Wok Deep

Product Code	Dimension
01-002-00075	Ø14"
01-002-00076	Ø15"
01-002-00077	Ø16"
01-002-00078	Ø17"
01-002-00079	Ø18"



Light Duty Iron Wok

Product Code	Dimension
01-002-00023	Ø15" Deep
01-002-00024	Ø15" Shallow
01-002-00025	Ø16" Deep
01-002-00026	Ø17" Deep
01-002-00027	Ø18" Deep
01-002-00028	Ø20" Deep
01-002-00029	Ø22" Deep
01-002-00030	Ø24" Deep
01-002-00031	Ø26" Deep
01-002-00032	Ø28" Deep



CCK Heavy Duty Stainless Steel Wok

Product Code	Dimension
01-002-00046	Ø14" (Depth 5" x 1.2mm)
01-002-00047	Ø15" (Depth 5.25" x 1.2mm)
01-002-00048	Ø16" (Depth 5.5" x 1.2mm)



CCK Light Duty Stainless Wok

Product Code	Dimension
01-002-00049	Ø14" (Depth 4" x 1mm)
01-002-00050	Ø15" (Depth 4.25" x 1mm)
01-002-00051	Ø16" (Depth 4.5" x 1.2mm)



CCK Heavy Duty Iron Wok

Product Code	Dimension
01-002-00013	Ø14" (Depth 5" x 1.2mm)
01-002-00014	Ø15" (Depth 5.25" x 1.2mm)
01-002-00015	Ø16" (Depth 5.5" x 1.2mm)
01-002-00016	Ø17" (Depth 5.75" x 1.2mm)
01-002-00017	Ø18" (Depth 6" x 1.2mm)
01-002-00018	Ø20" (Depth 6.9" x 1.3mm)
01-002-00019	Ø22" (Depth 7" x 1.6mm)
01-002-00020	Ø24" (Depth 7.5" x 1.6mm)
01-002-00021	Ø26" (Depth 8.5" x 2mm)
01-002-00022	Ø28" (Depth 10.5" x 2mm)



Iron Frying Wok Heavy Duty

Product Code	Dimension
01-002-00067	Ø16"
01-002-00068	Ø18"
01-002-00069	Ø19"
01-002-00070	Ø20"



Iron Wok

Product Code	Dimension
01-002-00062	Ø15"
01-002-00063	Ø16"
01-002-00064	Ø17"
01-002-00065	Ø18"
01-002-00066	Ø20"



Iron Frying Wok Heavy Duty

Product Code	Dimension
01-002-00037	Ø16"
01-002-00038	Ø18"
01-002-00039	Ø19"
01-002-00040	Ø20"
01-002-00041	Ø22"
01-002-00042	Ø24"
01-002-00043	Ø26"
01-002-00044	Ø28"
01-002-00045	Ø30"



CCK Iron Frying Wok Heavy Duty

Product Code	Dimension
01-002-00002	Ø16"
01-002-00003	Ø18"
01-002-00004	Ø19"
01-002-00005	Ø20"
01-002-00006	Ø22"
01-002-00007	Ø24"
01-002-00008	Ø26"
01-002-00009	Ø28"
01-002-00010	Ø30"
01-002-00011	Ø33"
01-002-00012	Ø36"



Black Enamel Wok

Product Code	Dimension
01-002-00080	Ø30cm
01-002-00081	Ø34cm
01-002-00082	Ø36cm
01-002-00083	Ø38cm
01-002-00084	Ø40cm
01-002-00085	Ø43cm
01-002-00086	Ø46cm



Iron Frying Wok

Product Code	Dimension
01-002-00053	Ø15"
01-002-00054	Ø16"
01-002-00055	Ø17"
01-002-00056	Ø18"
01-002-00057	Ø19"
01-002-00058	Ø20"
01-002-00059	Ø22"
01-002-00060	Ø24"
01-002-00061	Ø26"



CCK 18-8 Stainless Steel Wok Cover

Product Code	Dimension
01-002-00112	Ø14"
01-002-00113	Ø15"
01-002-00114	Ø16"



EAGLE Stainless Steel Wok Cover

Product Code	Dimension
01-002-00107	Ø30cm
01-002-00108	Ø33cm
01-002-00109	Ø35cm
01-002-00110	Ø38cm
01-002-00111	Ø40cm



Stainless Steel Wok Stand

Product Code	Dimension
01-002-00001	Ø30cm



AG Stainless Steel Round Kitchen Pot with Graduated Marking (With Handles)

Product Code	Dimension	Capacity
01-002-00533	Ø20 x H20cm	6.2ℓ
01-002-00534	Ø22 x H22cm	8.3ℓ
01-002-00535	Ø24 x H24cm	11.0ℓ
01-002-00536	Ø26 x H26cm	13.0ℓ
01-002-00537	Ø28 x H28cm	17.0
01-002-00538	Ø30 x H30cm	21.0ℓ



AG Stainless Steel Round Kitchen Pot with Handles

Product Code	Dimension	Capacity
01-002-00539	Ø33 x H33cm	26.0ℓ
01-002-00540	Ø36 x H36cm	36.0ℓ



ZEBRA Stainless Steel Stock Pot

Product Code	Dimension	Capacity
01-002-00182	Ø28 x H28cm	17.0ℓ
01-002-00183	Ø32 x H32cm	25.0ℓ
01-002-00184	Ø36 x H36cm	36.0ℓ
01-002-00185	Ø40 x H40cm	50.0ℓ



CCK Stainless Steel Stock Pot with Lid

Product Code	Dimension	Capacity
01-002-00134	Ø12 x 13"	220ℓ
01-002-00135	Ø13 x 14"	29.0ℓ
01-002-00136	Ø14 x 16"	38.0ℓ
01-002-00137	Ø16 x 18"	56.0ℓ
01-002-00138	Ø18 x 20"	80.0ℓ
01-002-00139	Ø18 x 22"	87.0ℓ
01-002-00140	Ø19 x 24"	106.0ℓ
01-002-00141	Ø20 x 22"	108.0ℓ
01-002-00142	Ø20 x 26"	127.0ℓ
01-002-00143	Ø20 x 30"	147.0ℓ
01-002-00144	Ø20 x 36"	176.0ℓ
01-002-00145	Ø22 x 24"	142.0ℓ



Stainless Steel Stock Pot with Recessed Handle

Product Code	Dimension
01-002-00163	Ø20 x H20cm
01-002-00164	Ø25 x H25cm
01-002-00165	Ø30 x H30cm
01-002-00166	Ø35 x H35cm
01-002-00167	Ø40 x H40cm
01-002-00168	Ø45 x H45cm
01-002-00169	Ø50 x H50cm



Stainless Steel Stock Pot with Lid

Product Code	Dimension	Capacity
01-002-00170	Ø20 x H20cm	6.0ℓ
01-002-00171	Ø25 x H25cm	12.0ℓ
01-002-00172	Ø30 x H30cm	21.0ℓ
01-002-00174	Ø35 x H35cm	33.0ℓ
01-002-00175	Ø40 x H40cm	50.0ℓ
01-002-00176	Ø45 x H45cm	71.0ℓ
01-002-00118	Ø50 x H50cm	98.0ℓ
01-002-00119	Ø50 x H60cm	117.0ℓ
01-002-00120	Ø55 x H55cm	130.0ℓ
01-002-00121	Ø60 x H60cm	170.0ℓ
01-002-00122	Ø60 x H70cm	200.0ℓ
01-002-00123	Ø60 x H80cm	230.0ℓ
01-002-00124	Ø70 x H70cm	260.0ℓ



Stainless Steel Loop Handle Pot with Recessed Handle

Product Code	Dimension
01-002-00189	Ø25 x H25cm
01-002-00190	Ø28 x H28cm
01-002-00191	Ø30 x H30cm
01-002-00192	Ø35 x H35cm



Stainless Steel Footed Loop Handle Pot with Recessed Handle

Product Code	Dimension
01-002-00186	Ø25 x H25cm
01-002-00187	Ø30 x H30cm
01-002-00188	Ø35 x H35cm



CCK Stainless Steel Noodle Soup Pot

Product Code	Dimension
02-002-00229	Ø15 x 13"



CCK Stainless Steel Soup Container / Basin

Product Code	Dimension
01-002-00210	Ø13"
01-002-00211	Ø14"
01-002-00212	Ø15"
01-002-00213	Ø16"
01-002-00215	Ø17"



Stainless Steel Low Casserole with Recessed Handle

Product Code	Dimension	Capacity
01-002-00195	Ø30 x H13cm	9.0ℓ
01-002-00177	Ø30 x H20cm	14.0ℓ
01-002-00178	Ø35 x H22cm	21.0ℓ
01-002-00179	Ø40 x H24cm	30.0ℓ



CCK Stainless Steel Shark's Fin Pot with Tap, Plate and Lid

Product Code	Dimension	Capacity
01-002-00132(XX)	Ø18 x 22"	87.0ℓ
01-002-00125	Ø18 x 26"	103.0ℓ
01-002-00126	Ø18 x 28"	111.0ℓ
01-002-00127	Ø20 x 26"	127.0ℓ
01-002-00128	Ø20 x 30"	147.0ℓ
01-002-00129	Ø20 x 36"	176.0ℓ
01-002-00133(XX)	Ø22 x 30"	147.0ℓ
01-002-00130	Ø22 x 32"	190.0ℓ
01-002-00131	Ø22 x 36"	214.0ℓ



CCK Stainless Steel Noodle Soup Pot with Compartments

Product Code	Dimension	Compartments
01-002-00218(XX)	Ø15 x 13"	2
01-002-00217	Ø15 x 13"	3



CCK Stainless Steel Soup Container Rack

Product Code	Dimension
01-002-00214	16"



Stainless Steel High Casserole with Recessed Handle

Product Code	Dimension	Capacity
01-002-00180	Ø45 x H26cm	41.0ℓ
01-002-00181	Ø50 x H28cm	55.0ℓ



ZEBRA Stainless Steel Casserole

Product Code	Dimension	Capacity
01-002-00193	Ø28 x H20cm	12.0ℓ
01-002-00194	Ø32 x H23cm	18.5ℓ



CAM Aluminium Loop Handle Pot

Product Code	Dimension	Capacity
01-002-00206	Ø32 x H25cm	30.0pt
01-002-00207	Ø34 x H27cm	36.0pt
01-002-00208	Ø38 x H29cm	40.0pt



AG Stainless Steel Square Kitchen Pot with Graduated Marking

Product Code	Dimension	Capacity	
01-002-00548	8 x 8 x 8cm	460mℓ	Without Handles
01-002-00549	10.5 x 10.5 x 10.5cm	1.1ℓ	
01-002-00550	12 x 12 x 12cm	1.6ℓ	
01-002-00551	13.5 x 13.5 x 13.5cm	2.3ℓ	
01-002-00552	16.5 x 16.5 x 16.5cm	4.2ℓ	
01-002-00553	18 x 18 x 18cm	5.3ℓ	With Handles
01-002-00543	19 x 19 x 19cm	6.4ℓ	
01-002-00544	21 x 21 x 21cm	8.6ℓ	
01-002-00545	24 x 24 x 24cm	12.6ℓ	
01-002-00546	27 x 27 x 27cm	18.0ℓ	
01-002-00547	30 x 30 x 30cm	25.0ℓ	



ZEBRA Stainless Steel Indian Pan

Product Code	Dimension	Capacity
01-002-00196	Ø14 x H8cm	1.2ℓ
01-002-00197	Ø16 x H9cm	1.8ℓ
01-002-00198	Ø18 x H10cm	2.6ℓ
01-002-00199	Ø20 x H11cm	3.5ℓ
01-002-00200	Ø22 x H12cm	4.6ℓ
01-002-00201	Ø24 x H13cm	5.9ℓ
01-002-00202	Ø26 x H14cm	7.4ℓ
01-002-00203	Ø28 x H15cm	9.2ℓ
01-002-00204	Ø30 x H16cm	11.2ℓ
01-002-00205	Ø32 x H17cm	13.7ℓ



AG Stainless Steel Round Kitchen Pot with Graduated Marking (Without Handles)

Product Code	Dimension	Capacity
01-002-00555	Ø10 x H10cm	700mℓ
01-002-00556	Ø12 x H12cm	1.4ℓ
01-002-00557	Ø14 x H14cm	2.1ℓ
01-002-00558	Ø16 x H16cm	3.3ℓ
01-002-00559	Ø18 x H18cm	4.5ℓ



EAGLE Aluminium S.Thick Indian Pan without Handle

Product Code	Dimension
01-002-00740	Ø30cm
01-002-00741	Ø32cm
01-002-00742	Ø34cm
01-002-00743	Ø36cm
01-002-00744	Ø38cm
01-002-00745	Ø40cm
01-002-00746	Ø42cm
01-002-00747	Ø44cm
01-002-00748	Ø46cm
01-002-00749	Ø48cm
01-002-00750	Ø50cm



EAGLE Aluminium S. Thick Big Indian Pan with 2 Handles

Product Code	Dimension
01-002-00751	Ø50cm
01-002-00752	Ø55cm
01-002-00753	Ø60cm
01-002-00754	Ø65cm
01-002-00755	Ø70cm



CCK Aluminium 3-Rings Stew Pan with Cover and Handle

Product Code	Dimension
01-002-00223	Ø16cm
01-002-00224	Ø18cm
01-002-00225	Ø20cm
01-002-00226	Ø16cm
01-002-00227	Ø18cm
01-002-00228	Ø20cm



AKAO Yukihira Pot

Product Code	Dimension
01-002-00725	Ø15cm
01-002-00726	Ø17cm
01-002-00727	Ø18cm
01-002-00728	Ø20cm
01-002-00729	Ø21cm
01-002-00730	Ø23cm
01-002-00731	Ø24cm
01-002-00732	Ø26cm
01-002-00733	Ø27cm
01-002-00734	Ø30cm



Aluminium Yukihira Pan

Product Code	Dimension
01-002-00628	Ø16cm
01-002-00629	Ø18cm
01-002-00630	Ø20cm
01-002-00631	Ø22cm
01-002-00632	Ø24cm



AKAO Aluminium Cooking Pot

Product Code	Dimension
01-002-00722	Ø30cm
01-002-00723	Ø33cm
01-002-00724	Ø36cm



Aluminium Egg Pan with Handle and Lid

Product Code	Dimension
01-002-00623	Ø16cm



Copper Tempura Pan

Product Code	Dimension
01-002-00735	Ø39cm
01-002-00736	Ø42cm
01-002-00737	Ø45cm



Rectangle Non-Stick Tamago Pan with Bakelite Handle

Product Code	Dimension
01-002-00621	13 x 18cm



Copper Rectangle Tamago Pan with Wooden Handle

Product Code	Dimension
01-002-00622	19 x 14cm



ZEBRA Stainless Steel Steaming Set 4pcs

Product Code	Dimension
01-002-00329	Ø28 x 44cm
01-002-00330	Ø32 x 47cm
01-002-00331	Ø36 x 52cm
01-002-00332	Ø40 x 56cm
01-002-00333	Ø50 x 62cm



Stainless Steel Fun Cheong Steamer

Product Code	Dimension	
01-002-00305(XX)	55 x 55 x 34cm	4-Tier
01-002-00306(XX)	55 x 55 x 37cm	5-Tier
01-002-00307(XX)	58 x 55.5 x 16cm	Single Tier



CCK Stainless Steel Steamer Case with Fixed Base

Product Code	Dimension
01-002-00339	Ø16 x H4.5"
01-002-00335	Ø18 x H5"
01-002-00299	Ø20 x H5"
01-002-00300	Ø20 x H10"
01-002-00302	Ø22 x H6"
01-002-00301	Ø22 x H10"



Stainless Steel Square Steamer

Product Code	Dimension	
01-002-00310(XX)	33 x 33cm x 4.5cm	Cover
01-002-00341(XX)	33 x 33 x 14cm	Plate
01-002-00342(XX)	33 x 33 x 14cm	Body
01-002-00343(XX)	33 x 33 x 12cm	Water Base

Available in other sizes:

28 x 28cm
30 x 30cm
39 x 39cm
60 x 60cm



CCK Stainless Steel Steamer Case with Movable Base

Product Code	Dimension
01-002-00295	Ø20 x H5"
01-002-00296	Ø20.5 x H10"
01-002-00297	Ø22 x H6"
01-002-00298	Ø22 x H10"



CCK Stainless Steel Steamer Cover

Product Code	Dimension
01-002-00340	Ø16 x H5.5"
01-002-00334	Ø18 x H7"
01-002-00303	Ø20.5 x H4"
01-002-00304	Ø22 x H4"



CCK Stainless Steel Steamer Case Ring

Product Code	Dimension
01-002-00319	Ø21"
01-002-00320	Ø22"



CCK Stainless Steel Round Base with Handle for Steam Case

Product Code	Dimension
01-002-00326	Ø15.5"
01-002-00327	Ø17.5"
01-002-00328	Ø19.5"



CCK Stainless Steel Steaming Plate

Product Code	Dimension
01-002-00279	Ø4"
01-002-00280	Ø4.5"
01-002-00281	Ø5"
01-002-00282	Ø6"
01-002-00283	Ø7"
01-002-00284	Ø8"
01-002-00285	Ø10"
01-002-00286	Ø12" (Folded Rim)
01-002-00287	Ø14" (Folded Rim)
01-002-00288	Ø16" (Folded Rim)
01-002-00289	Ø17" (Folded Rim)
01-002-00290	Ø18" (Folded Rim)
01-002-00291	Ø19" (Folded Rim)
01-002-00292	Ø20" (Folded Rim)
01-002-00293	Ø21" (Folded Rim)
01-002-00294	Ø22" (Folded Rim)



CCK Stainless Steel Steaming Plate

Product Code	Dimension	Type
01-002-00278	Ø23"	3-Holes
01-002-00276	Ø23"	7-Holes
01-002-00277	Ø25"	7-Holes



CCK Stainless Steel 1-Tier Steamer Stand, 3 Legged (Triangular)

Product Code	Dimension
01-002-00318	21.2 x 12.4"



Stainless Steel Triangle 8-Tier Steamer Stand

Product Code	Dimension
01-002-00275	L56 x H175cm



CCK Stainless Steel Rice Steaming Pan / Basin

Product Code	Dimension	Type
01-002-00337	Ø17" x H7cm	
01-002-00338	Ø17" x H7cm	Perforated
01-002-00321	Ø17" / Ø43 x 7cm	
01-002-00322	Ø18" / Ø46 x 8cm	



CCK Stainless Steel Stand for Frying Stove

Product Code	Dimension
01-002-00116	Ø19" x H14"
01-002-00117	Ø15" x H29"



EAGLE Aluminium Rice Steaming Pan

Product Code	Dimension
01-002-00324	Ø46 x H8cm
01-002-00325	Ø50 x H8cm



Bamboo Shark's Fin Mat

Product Code	Dimension
01-002-00344	9 Holes
01-002-00345	10 Holes
01-002-00346	12 Holes



Wooden Round Tall Steamer Lid for Dim Sum Holder

Product Code	Dimension
01-002-00375	Ø16.8 x H10cm



Bamboo Dim Sum Holder for "Xiao Long Bao"

Product Code	Dimension
01-002-00689	Ø5.7 x H8cm



Bamboo Steamer Case/Lid

Dimension	Case/Lid	Product Code
Ø5"	Case	01-002-00448
	Lid	01-002-00411
Ø6"	Case	01-002-00449
	Lid	01-002-00413
Ø6.5"	Case	01-002-00450
	Lid	01-002-00412
Ø8"	Case	01-002-00451
	Lid	01-002-00418
Ø10"	Case	01-002-00452
	Lid	01-002-00414
Ø12"	Case	01-002-00453
	Lid	01-002-00415
Ø15"	Case	01-002-00454
	Lid	01-002-00416
Ø21"	Case	01-002-00455
	Lid	01-002-00417



Wooden Round Steamer Case/Lid

Dimension	Case/Lid	Product Code
Ø3"	Case	01-002-00380
	Lid	01-002-00351
Ø4"	Case	01-002-00381
	Lid	01-002-00352
Ø5"	Case	01-002-00382
	Lid	01-002-00353
Ø6"	Case	01-002-00383
	Lid	01-002-00354
Ø6.5"	Case	01-002-00384
	Lid	01-002-00355
Ø8"	Case	01-002-00385
	Lid	01-002-00356
Ø10"	Case	01-002-00386
	Lid	01-002-00357
Ø12"	Case	01-002-00387
	Lid	01-002-00358



Deluxe Wooden Round Steamer Case/Lid

Dimension	Case/Lid	Product Code
Ø5"	Case	01-002-00427
	Lid	01-002-00404
Ø6"	Case	01-002-00428
	Lid	01-002-00405
Ø7"	Case	01-002-00429
	Lid	01-002-00406
Ø8"	Case	01-002-00430
	Lid	01-002-00407
Ø10"	Case	01-002-00431
	Lid	01-002-00408
Ø12"	Case	01-002-00432
	Lid	01-002-00409
Ø14"	Case	01-002-00433
	Lid	01-002-00410
Ø6.5"	Case (Shallow High Rise Base)	01-002-00435
	Lid (High Rise)	01-002-00419
Ø7"	Case (Shallow High Rise Base)	01-002-00436
	Lid (High Rise)	01-002-00420
Ø12"	Case (Shallow High Rise Base)	01-002-00434
	Lid (Hokkien)	01-002-00667



Bamboo Steamer Shallow High Rise Base/Lid

Dimension	Base/Lid	Product Code
Ø5"	Base	01-002-00439
	Lid	01-002-00421
Ø6"	Base	01-002-00441
	Lid	01-002-00423
Ø6.5"	Base	01-002-00440
	Lid	01-002-00422



Har Kow Bamboo Steamer Case/Lid

Dimension	Case/Lid	Product Code
Ø4"	Case	01-002-00438
	Lid	01-002-00424



Bamboo Steamer Case with Steel Wire/Lid

Dimension	Case/Lid	Product Code
Ø21"	Case	01-002-00447
	Lid	01-002-00417



Bamboo Steamer Case with Aluminium Edge

Product Code	Dimension
01-002-00443	Ø6"
01-002-00442	Ø6.5"



Bamboo Steamer Case/Lid with Stainless Steel Ring Edge

Dimension	Case/Lid	Product Code
Ø5.1"	Case	01-002-00444(XX)
	Lid	01-002-00437(XX)



Bamboo Steamer Case/Lid with Stainless Steel Ring Edge

Dimension	Case/Lid	Product Code
Ø6.5"	Case	01-002-00445
	Lid	01-002-00425



Wooden Square Steamer Case/Lid

Dimension	Case/Lid	Product Code
4 x 4"	Case	01-002-00394
	Lid	01-002-00365
5 x 5"	Case	01-002-00395
	Lid	01-002-00366
6 x 6"	Case	01-002-00396
	Lid	01-002-00367
6.5 x 6.5"	Case	01-002-00397
	Lid	01-002-00368
8 x 8"	Case	01-002-00398
	Lid	01-002-00369
10 x 10"	Case	01-002-00399
	Lid	01-002-00370
12 x 12"	Case	01-002-00400
	Lid	01-002-00371



Wooden Oval Steamer Case/Lid

Dimension	Case/Lid	Product Code
5 x 4"	Case	01-002-00388
	Lid	01-002-00359
6 x 5"	Case	01-002-00389
	Lid	01-002-00360
6.5 x 5.3"	Case	01-002-00390
	Lid	01-002-00361
8.5 x 6.8"	Case	01-002-00391
	Lid	01-002-00362
10 x 8"	Case	01-002-00392
	Lid	01-002-00363
12 x 9.6"	Case	01-002-00393
	Lid	01-002-00364



Wooden Square Steamer Case/Lid

Dimension	Case/Lid	Product Code
15 x 15 x 5cm	Case	01-002-00403
	Lid	01-002-00374
20 x 20 x 5.5cm	Case	01-002-00402
	Lid	01-002-00373
25 x 25 x 6cm	Case	01-002-00401
	Lid	01-002-00372



Wooden Square Steamer Case/Lid

Dimension	Case/Lid	Product Code
26 x 16 x 5cm (GN1/4)	Case	01-002-00379
	Lid	01-002-00350
32 x 17 x 6cm (GN 1/3)	Case	01-002-00378
	Lid	01-002-00349
32 x 26 x 6cm (GN 1/2)	Case	01-002-00377
	Lid	01-002-00348
52 x 32.5 x 6.5cm (GN 1/1)	Case	01-002-00376
	Lid	01-002-00347



Bamboo Round Steamer Case/Lid with Plastic Rim

Dimension	Case/Lid	Product Code
Ø5" x H7cm	Case	01-002-00768
	Lid	01-002-00769
Ø6" x H7cm	Case	01-002-00770
	Lid	01-002-00771
Ø6.5" x H7cm	Case	01-002-00772
	Lid	01-002-00773
Ø7" x H7cm	Case	01-002-00774
	Lid	01-002-00775
Ø10" x H7cm	Case	01-002-00776
	Lid	01-002-00777



Bamboo Square Steamer Case/Lid with Plastic Rim

Dimension	Case/Lid	Product Code
Ø5" x H7cm	Case	01-002-00778
	Lid	01-002-00779
Ø6" x H7cm	Case	01-002-00780
	Lid	01-002-00781
Ø6.5" x H7cm	Case	01-002-00782
	Lid	01-002-00783
Ø7" x H7cm	Case	01-002-00784
	Lid	01-002-00785



AELB Japanese Shallow Casserole

Product Code	Dimension	Capacity	
01-002-00688	Ø11.5 x H4.6cm	0.2ℓ	With Cover
01-002-00686	Ø12.7 x H5cm	0.35ℓ	With Cover
01-002-00682	Ø14.5 x H5.7cm	0.6ℓ	With Cover
01-002-00684	Ø14.5 x H5.7cm	0.6ℓ	Body Only
01-002-00676	Ø17.4 x H6.5cm	0.9ℓ	With Cover
01-002-00677	Ø17.4 x H6.5cm	0.9ℓ	Body Only
01-002-00681	Ø19.7 x H7.5cm	1.3ℓ	With Cover
01-002-00673	Ø19.7 x H7.5cm	1.3ℓ	Body Only
01-002-00672	Ø23 x H8.2cm	1.7ℓ	With Cover
01-002-00671	Ø24 x H8.6cm	2.2ℓ	With Cover



AELB Japanese Deep Casserole

Product Code	Dimension	Capacity	
01-002-00683	Ø14.7 x H8cm	0.9ℓ	With Cover
01-002-00679	Ø16.5 x H9cm	1.3ℓ	With Cover
01-002-00675	Ø16.5 x H9cm	1.3ℓ	With Cover
01-002-00678	Ø19 x H10cm	1.9ℓ	Body Only
01-002-00674	Ø20.5 x H11cm	2.6ℓ	With Cover
01-002-00670	Ø23.5 x H12cm	3.5ℓ	Body Only
01-002-00669	Ø26.7 x H13cm	5.0ℓ	With Cover



Black Alum Non-Stick Hot Pot with Cover

Product Code	Dimension
01-002-00717	Ø16cm
01-002-00718	Ø20cm
01-002-00719	Ø22cm
01-002-00720	Ø24cm



CCK Double Ear Rattan Basket for Casserole

Product Code	Dimension
01-002-00233	Ø6.5"
01-002-00234	Ø7.5"
01-002-00235	Ø8.5"
01-002-00236	Ø9.5"
01-002-00237	Ø11"
01-002-00238	Ø12"



AELB Thai Style Claypot with Cover

Product Code	Dimension
01-002-00687	Ø15 x H5cm
01-002-00685	Ø18 x H6cm
01-002-00680	Ø21 x H7cm



JUMBO Earthen Claypot

Dimension	Black
Ø23.3 x H10.7cm	01-002-00464
Ø25.3 x H10.7cm	01-002-00465



JUMBO Earthen Jumbo Claypot

Dimension	Capacity	Black
Ø17.3 x H14.7cm	3.25ℓ	01-002-00702
Ø19.3 x H6.7cm	4.25ℓ	01-002-00767
Ø22.3 x H18.7cm	5.5ℓ	01-002-00714
Ø23.3 x H19.7cm	7.5ℓ	01-002-00715
Ø25.3 x H21.7cm	10.0ℓ	01-002-00716



JUMBO Earthen Jumbo Claypot

Dimension	Yellow
Ø21.3 x H15.7cm	01-002-00456
Ø23.3 x H17.7cm	01-002-00457
Ø26.3 x H21.7cm	01-002-00458



Stainless Steel Claypot Stand with Handles

Product Code	Dimension
01-002-00738	15.5 x 13 x 9cm



Wooden Square Stand, Open Base

Product Code	Dimension
01-002-00758	Ø14cm
01-002-00759	Ø16cm
01-002-00760	Ø18.5cm
01-002-00761	Ø21cm
01-002-00762	Ø23.5cm
01-002-00763	Ø26cm



Stainless Steel Claypot Stand with Handles

Product Code	Dimension
01-002-00527	11.5 x 8.5 x 8cm
01-002-00528	14 x 11.5 x 8.5cm
01-002-00529	18.5 x 15 x 9.5cm



Wooden Square Stand, Closed Base

Product Code	Dimension
01-002-00530	S - Ø14.5 x 18.5 x 5cm
01-002-00531	M - Ø18 x 22.5 x 5.5cm
01-002-00532	L - Ø20 x 24.2 x 5.8cm



TOKIWA Cast Iron Round Hot Plate

Product Code	Dimension	
01-002-00580	Ø22cm	Without Handle
01-002-00581	Ø15cm	With Handle
01-002-00582	Ø20cm	With Handles



Round Cast Iron Hot Plate with Wooden Underliner

Product Code	Dimension
01-002-00617	Ø15cm
01-002-00616	Ø18cm
01-002-00602	Ø20cm
01-002-00615	Ø21cm
01-002-00603	Ø22cm
01-002-00604	Ø24cm
01-002-00605	Ø26cm



Round Cast Iron Hot Plate with 2 Sides and Wooden Underliner

Product Code	Dimension
01-002-00618	Ø15cm



Oval Ribbed Edge Cast Iron Hot Plate with Wooden Underliner

Product Code	Dimension	Platter
01-002-00610	23 x 14cm	27 x 17cm



Round Cast Iron Grill Plate with 2 Handles and Wooden Underliner

Product Code	Dimension
01-002-00606	Ø24cm



TOKIWA Cast Iron Oval Hot Plate with Wooden Underliner

Product Code	Dimension
01-002-00591	30cm



Cast Iron Cow-Head Hot Plate

Product Code	Dimension	
01-002-00583	30cm	
01-002-00584	23.5cm	With Wooden Base



01-002-00588/589



01-002-00587



Rectangle Cast Iron Hot Plate with Wooden Underliner

Product Code	Dimension
01-002-00595	22 x 16cm

Cast Iron Oval Hot Plate

Product Code	Dimension	
01-002-00588	10.5"	
01-002-00589	11"	
01-002-00587	12"	Floral Design



Cast Iron Octopus Ball Plate

Product Code	Dimension	Colour
01-002-00592	18-Compartment	Black



Rectangle Hot Plate with Wooden Stand

Product Code	Dimension
01-002-00593	38 x 20 x 11.5cm (L Size)
01-002-00594	29.5 x 15.5 x 11.5cm (S Size)



Cast Iron Wok with Wooden Cover

Product Code	Dimension
01-002-00263	Ø22.5cm / 9"
01-002-00264	Ø25cm / 10"
01-002-00265	Ø30cm / 12"



Black Aluminium Hot Pot with Loop Holes and Wooden Lid

Product Code	Dimension
01-002-00571	Ø17cm
01-002-00572	Ø19cm



TOKIWA Cast Iron Round Sukiyaki Nabe

Product Code	Dimension
01-002-00579	Ø26cm



Cast Iron Round Sukiyaki Nabe

Product Code	Dimension
01-002-00576	Ø24cm
01-002-00577	Ø26cm
01-002-00578	Ø28cm
01-002-00575	Ø30cm



TOKIWA Cast Iron Hot Plate with Handle

Product Code	Dimension
01-002-00585	17cm
01-002-00586	20cm



Stainless Steel Teppanyaki Cover

Product Code	Dimension
01-002-00624	Ø28cm



STONE LEE Stone Bowl

Product Code	Dimension
01-002-00268	Ø16 x H7cm
01-002-00269	Ø18 x H8cm
01-002-00270	Ø20 x H8cm
01-002-00271	Ø21 x H8cm



STONE LEE Stone Bowl with Stainless Steel Band

Product Code	Dimension
01-002-00267(XX)	Ø17 x H7cm
01-002-00266	Ø18 x H8cm



STONE LEE Stone Pot

Product Code	Dimension
01-002-00229	Ø15 x H7.5cm
01-002-00230	Ø20 x H10cm
01-002-00231	Ø22 x H11cm
01-002-00232	Ø24 x H12cm



STONE LEE Wooden Oval Underliner for Stone Bowl / Pot

Product Code	For
01-002-00272	01-002-00268 / 01-002-00229
01-002-00273	01-002-00269 / 01-002-00270
01-002-00274	01-002-00230 / 01-002-00271



STONE LEE Chowder Pan

Product Code	Dimension
01-002-00219	Ø26 x H8cm
01-002-00220	Ø28 x H8cm
01-002-00221	Ø30 x H8cm
01-002-00222	Ø32 x H8cm



STONE LEE Round Steak Pan with Wooden Underliner

Product Code	Dimension
01-002-00596	Ø22 x H2.5cm
01-002-00597	Ø24 x H2.5cm
01-002-00598	Ø26 x H2.5cm



STONE LEE Rectangle Steak Pan with Wooden Underliner

Product Code	Dimension
01-002-00599	24 x 15 x 2.3cm
01-002-00600	28 x 16 x 2.5cm
01-002-00619(XX)	Steak Pan for 01-002-00599
01-002-00620(XX)	Wooden Pan for 01-002-00599



STONE LEE Fan Shaped Footed Plate

Product Code	Dimension
01-002-00601	26.5 x 13.5cm



01-002-00613(XX)

01-002-00614(XX)



01-002-00611(XX)

01-002-00612(XX)

STONE LEE Stone Warmer

Product Code	Dimension	
01-002-00613(XX)	11 x 11 x 6cm	Square
01-002-00614(XX)	16 x 7 x 6cm	Rectangle

STONE LEE Stone Plate for Warmer

Product Code	Dimension	
01-002-00611(XX)	17 x 17 x 2cm	Square
01-002-00612(XX)	22 x 14 x 2cm	Rectangle



Stainless Steel Shabu Shabu / Hot Plate with Glass Lid

Product Code	Dimension	Details
01-002-00257	Ø28cm	"S" Divided
01-002-00255	Ø26cm	With Capsule Bottom (Induction-Usable)
01-002-00256	Ø28cm	With Capsule Bottom (Induction-Usable)



Stainless Steel Mini Steamboat with Chimney (Non-detachable)

Product Code	Dimension	
01-002-00250	20cm	0.85ℓ



YI TOH LOO Aluminium Charcoal Steamboat (Fixed)

Product Code	Dimension
01-002-00253	Ø9"
01-002-00251	Ø10"
01-002-00252	Ø11"

| KITCHEN TOOLS
& UTENSILS



SIA HUAT 
Beyond Foodservice Supplies

www.siahuat.com

CHAPTER
02

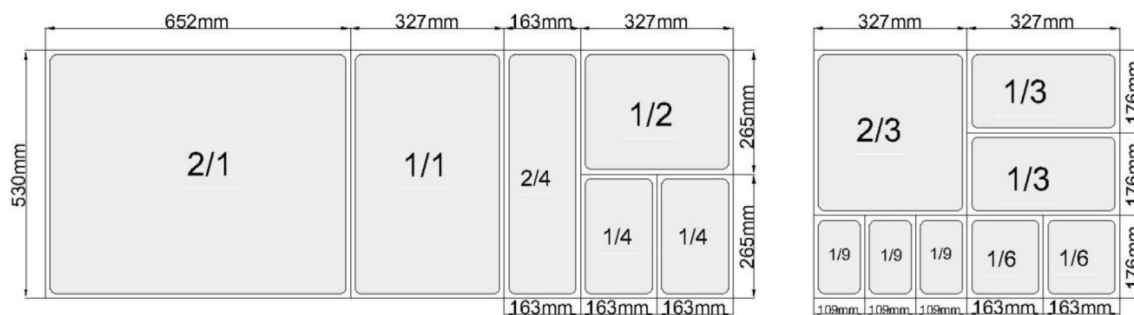

STAINLESS STEEL GASTRONORM PANS - EUROPEAN STYLE

SAFICO Gastronorm Pans are constructed with 18/8 stainless steel to EN 361 Standard and meets all professional needs. Double-reinforced corners and edges reduce distortion and prevent the pans from jamming together during storage. Sits firmly over steam table wells to minimise heat loss. NSF Listed.



SAFICO Stainless Steel GN Pan

Size / Depth	2cm / 0.07cm	4cm / 0.07cm	6.5cm / 0.07cm	10cm / 0.07cm	15cm / 0.07cm	20cm / 0.07cm
GN 1/1	02-001-00235	02-001-00236	02-001-00237	02-001-00238	02-001-00239	02-001-00240
GN 1/2	02-001-00241	02-001-00242	02-001-00243	02-001-00244	02-001-00245	02-001-00246
GN 1/3	02-001-00247	02-001-00248	02-001-00249	02-001-00250	02-001-00251	02-001-00252
GN 1/4			02-001-00253	02-001-00254	02-001-00255	02-001-00256
GN 1/6			02-001-00257	02-001-00258	02-001-00259	02-001-00260
GN 1/9			02-001-00261	02-001-00262		
GN 2/1	02-001-00263	02-001-00264	02-001-00265	02-001-00266	02-001-00267	02-001-00563
GN 2/3	02-001-00279	02-001-00280	02-001-00281	02-001-00282	02-001-00283	02-001-00284
GN 2/4	02-001-00285		02-001-00286	02-001-00287	02-001-00288	



SAFICO PERFORATED Stainless Steel GN Pan

Size / Depth	2cm / 0.07cm	4cm / 0.07cm	6.5cm / 0.07cm	10cm / 0.07cm	15cm / 0.07cm	20cm / 0.07cm
GN 1/1	02-001-00268	02-001-00269	02-001-00270	02-001-00271	02-001-00272	
GN 1/2		02-001-00274	02-001-00275	02-001-00276	02-001-00277	02-001-00273
GN 2/1			02-001-00278			



SAFICO Stainless Steel Non-Stick GN Pan

Size / Depth	2cm	4cm	6.5cm
GN 1/1	02-001-00289	02-001-00290	02-001-00291
GN 1/2	02-001-00292	02-001-00293	02-001-00294
GN 1/3			02-001-00295
GN 2/3			02-001-00296

SAFICO Stainless Steel False Bottom / Drain Shelf

Product Code	Size
02-001-00312	For Size 1/1
02-001-00313	For Size 1/2
02-001-00314	For Size 1/3



SAFICO Stainless Steel Slotted Lid

Product Code	For GN Pan	Thickness
02-001-00297	1/1	0.07cm
02-001-00298	1/2	0.07cm
02-001-00299	1/3	0.07cm
02-001-00300	1/4	0.07cm
02-001-00301	1/6	0.07cm
02-001-00302	1/9	0.07cm
02-001-00303	2/3	0.07cm

SAFICO Stainless Steel Solid Lid

Product Code	For GN Pan	Thickness
02-001-00304	1/1	0.07cm
02-001-00305	1/2	0.07cm
02-001-00306	1/3	0.07cm
02-001-00307	1/4	0.07cm
02-001-00308	1/6	0.07cm
02-001-00309	1/9	0.07cm
02-001-00310	2/3	0.07cm
02-001-00311	2/4	0.07cm



STEELCRAFT BY SAFICO Stainless Steel GN Pan

Size / Depth	2cm / 0.06cm	4cm / 0.06cm	6.5cm / 0.06cm	10cm / 0.06cm	15cm / 0.07cm	20cm / 0.07cm
GN 1/1	02-001-00315	02-001-00316	02-001-00317	02-001-00318	02-001-00319	02-001-00320
GN 1/2	02-001-00327	02-001-00328	02-001-00329	02-001-00330	02-001-00331	02-001-00332
GN 1/3	02-001-00339	02-001-00340	02-001-00341	02-001-00342	02-001-00343	02-001-00344
GN 1/4	02-001-00345		02-001-00346	02-001-00347	02-001-00348	02-001-00349
GN 1/6			02-001-00350	02-001-00351	02-001-00352	02-001-00353
GN 1/9			02-001-00354	02-001-00355	02-001-00356	
GN 2/1	02-001-00357					
GN 2/3	02-001-00358	02-001-00359	02-001-00360	02-001-00361	02-001-00362	02-001-00363
GN 2/4				02-001-00364	02-001-00365	



STEELCRAFT BY SAFICO PERFORATED Stainless Steel GN Pan

Size / Depth	2cm / 0.06cm	4cm / 0.06cm	6.5cm / 0.06cm	10cm / 0.06cm	15cm / 0.07cm	20cm / 0.07cm
GN 1/1	02-001-00321	02-001-00322	02-001-00323	02-001-00324	02-001-00325	02-001-00326
GN 1/2	02-001-00333	02-001-00334	02-001-00335	02-001-00336	02-001-00337	02-001-00338



STEELCRAFT BY SAFICO Stainless Steel Food Pan

Size / Depth	6.5cm / 0.06cm	10cm / 0.06cm	15cm / 0.06cm	20cm / 0.06cm
GN 1/1	02-001-00416	02-001-00417	02-001-00418	02-001-00419
GN 1/2	02-001-00420	02-001-00421	02-001-00422	
GN 1/3	02-001-00423	02-001-00424	02-001-00425	
GN 1/4	02-001-00426	02-001-00427	02-001-00428	
GN 1/6	02-001-00429	02-001-00430	02-001-00431	
GN 1/9	02-001-00433	02-001-00432		

STEELCRAFT BY SAFICO Stainless Steel Solid Cover for Food Pan

Product Code	For GN Pan	Thickness
02-001-00434	Size 1/1	0.06cm
02-001-00435	Size 1/2	0.06cm
02-001-00436	Size 1/3	0.06cm
02-001-00437	Size 1/4	0.06cm
02-001-00438	Size 1/6	0.06cm
02-001-00439	Size 1/9	0.06cm

STEELCRAFT BY SAFICO Stainless Steel Solid Cover*

Product Code	For GN Pan	Thickness
02-001-00366	Size 1/1	0.07cm
02-001-00367	Size 1/2	0.07cm
02-001-00368	Size 1/3	0.07cm
02-001-00369	Size 1/4	0.07cm
02-001-00370	Size 1/6	0.07cm
02-001-00371	Size 1/9	0.07cm
02-001-00372	Size 2/3	0.07cm
02-001-00373	Size 2/1	0.09cm
02-001-00374	Size 2/4	0.07cm

*This series may be used on SAFICO and STEELCRAFT by SAFICO pans

Stainless Steel 3-Compartment Pan Organizer for GN 1/6 Pans

Product Code	Height
02-001-00452	15cm

STEELCRAFT BY SAFICO Stainless Steel Divided Food Pan

Product Code	Size	Height
02-001-00415	For Size 1/1	6.5cm

CCK Stainless Steel Holder for 1/6 Size Pan

Height	4"	6"
1/6	02-001-00445	02-001-00444
2 x 1/6	02-001-00447	02-001-00446
3 x 1/6	02-001-00449	02-001-00448

CAMBRO AMBER H-Pan (Temperature tolerance -40°C to 190°C)

Size / Depth	2.5"	4"	6"
GN 1/1	02-001-00008	02-001-00009	02-001-00010
GN 1/2	02-001-00011	02-001-00012	02-001-00013
GN 1/3	02-001-00014	02-001-00015	02-001-00016
GN 1/6	02-001-00020	02-001-00021	02-001-00022
GN 1/9	02-001-00023	02-001-00024	

SAFICO Stainless Steel Adaptor Bar

Product Code	Dimension	Size
02-001-00450	20.5"	For Size 1/1
02-001-00451	12.75"	For Size 1/2

CAMBRO AMBER Heat-Resistant Plastic GN H-Pan Lid

Size	Flat Lid	Flip Lid	Flat Lid w/ Handle	Notched Lid w/ Handle	Notched Flip Lid
GN 1/1	02-001-00460		02-001-00467(XX)	02-001-00472(XX)	
GN 1/2	02-001-00461	02-001-00034(XX)	02-001-00468	02-001-00473(XX)	02-001-00048(XX)
GN 1/3	02-001-00463(XX)	02-001-00035(XX)	02-001-00469	02-001-00474	02-001-00047(XX)
GN 1/4	02-001-00464(XX)		02-001-00470	02-001-00475(XX)	
GN 1/6	02-001-00465	02-001-00036(XX)	02-001-00471	02-001-00476	02-001-00049(XX)
GN 1/9	02-001-00466(XX)				

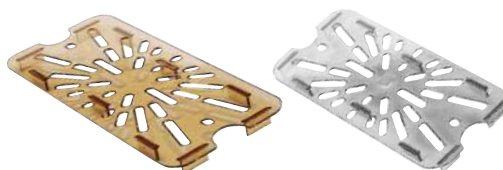
**CAMBRO Drain Shelf for GN Pan**

Size	Amber	Clear (Plastic)	Translucent (Polypropylene)
GN 1/1	02-001-00001(XX)	02-001-00069	02-001-00489
GN 1/2	02-001-00002(XX)	02-001-00070	02-001-00490
GN 1/3	02-001-00003	02-001-00071	02-001-00491
GN 1/4	02-001-00004(XX)	02-001-00072	02-001-00492(XX)
GN 1/6	02-001-00005	02-001-00073	02-001-00493
GN 1/9	02-001-00006(XX)	02-001-00074	

Camwear Drain Shelves ensure that food and condiments stay fresh longer by keeping liquids separate from food. The finger notch allows you to place it in the bottom of your existing Camwear Food Pan to keep food product elevated and out of juices preserving freshness and food quality. CW Drain Shelves withstand temperatures from -40°C to 99°C.

Polypropylene Drain Shelves ensure that food and condiments stay fresh longer by keeping liquids separate from food. The finger notch allows you to place it in the bottom of your existing Translucent Food Pan to keep food product elevated and out of juices preserving freshness and food quality. Polypropylene Drain Shelves withstand temperatures from -40°C to 70°C.

**CAMBRO BLACK Polycarbonate GN Pan**

Size / Depth	6.5cm	10cm	15cm	20cm
GN 1/1	02-001-00050	02-001-00051	02-001-00052	
GN 1/2	02-001-00053	02-001-00054	02-001-00055	
GN 1/3	02-001-00056	02-001-00057	02-001-00058	02-001-00059
GN 1/4	02-001-00060	02-001-00061	02-001-00062	
GN 1/6	02-001-00063	02-001-00064	02-001-00065	
GN 1/9	02-001-00066	02-001-00067		

**CAMBRO WHITE Polycarbonate GN Pan**

Size / Depth	6.5cm	10cm	15cm
GN 1/1	02-001-00166	02-001-00164	02-001-00165
GN 1/2	02-001-00167	02-001-00168	02-001-00169(XX)
GN 1/3	02-001-00170	02-001-00171	02-001-00172
GN 1/4		02-001-00173(XX)	
GN 1/6	02-001-00174		02-001-00175
GN 1/9	02-001-00176(XX)		

PADERNO Plastic GN Pan / Grid / Lid

Size	Plastic GN Pan (Height: 20cm)	Grid	Lid
GN 2/1	02-001-00413(XX)	02-001-00441(XX)	02-001-00414(XX)

CAMBRO TRANSLUCENT Polypropylene Food Pan / GN Lids

Size / Depth	Food Pan Height: 10cm	Food Pan Height: 15cm	Flat Lid w/ Handle	Notched Lid w/ Handle	Flat Lid
GN 1/1	02-001-00477	02-001-00478(XX)	02-001-00507		
GN 1/2	02-001-00479	02-001-00480	02-001-00508		
GN 1/3	02-001-00481	02-001-00482	02-001-00509	02-001-00512(XX)	
GN 1/4	02-001-00483	02-001-00484	02-001-00510		
GN 1/6	02-001-00485	02-001-00486	02-001-00511	02-001-00513(XX)	
GN 1/9	02-001-00487				02-001-00506(XX)

CAMBRO CLEAR Polycarbonate Food Pan

Size / Depth	6.5cm	10cm	15cm	20cm
GN 1/1	02-001-00669	02-001-00670	02-001-00671	02-001-00672
GN 1/2	02-001-00673	02-001-00674	02-001-00675	02-001-00668
GN 1/3	02-001-00676	02-001-00677	02-001-00678	02-001-00679
GN 1/4		02-001-00680	02-001-00681	
GN 1/6	02-001-00682	02-001-00683	02-001-00684	
GN 1/9	02-001-00685	02-001-00686		
GN 2/4	02-001-00516			

CAMBRO CLEAR Polycarbonate Plastic GN Lid

Size / Depth	Flat Lid	Flat Lid w/ Handle	Notched Lid w/ Handle	Notched Flip Lid	Flip Lid	Grip Lid
GN 1/1	02-001-00077	02-001-00084	02-001-00092			02-001-00127
GN 1/2	02-001-00078	02-001-00085	02-001-00093	02-001-00089	02-001-00124	02-001-00128
GN 1/3	02-001-00079	02-001-00086	02-001-00094	02-001-00090	02-001-00125	02-001-00129
GN 1/4	02-001-00080	02-001-00087	02-001-00095			
GN 1/6	02-001-00081	02-001-00088	02-001-00096	02-001-00091	02-001-00126	02-001-00130
GN 1/9	02-001-00082		02-001-00097(XX)			
GN 2/4	02-001-00488(XX)					

CAMBRO CLEAR Polycarbonate Food Pan Colander

Size / Depth	Height 3" (7.6cm)	Height 5" (12.7cm)
GN 1/2	02-001-00118	
GN 1/3	02-001-00121	02-001-00120(XX)
GN 1/6	02-001-00123	02-001-00122



02-001-00185/186/187

02-001-00131/132/133

CAMBRO CLEAR Coldfest Insulated Pan / Plastic Flat Cover

Size / Depth	ABS GN Pan w/ Gel Core Height: 15cm	Flat Cover
GN 1/2	02-001-00185	02-001-00131(XX)
GN 1/3	02-001-00186	02-001-00132(XX)
GN 1/6	02-001-00187	02-001-00133(XX)

UNICA TRANSLUCENT Polypropylene GN Pan

Size / Depth	6.5cm	10cm	15cm	20cm
GN 1/1	02-001-00392	02-001-00393	02-001-00394	02-001-00395
GN 1/2	02-001-00396	02-001-00397	02-001-00398	02-001-00399
GN 1/3	02-001-00400	02-001-00401	02-001-00402	02-001-00403
GN 1/4	02-001-00404	02-001-00405	02-001-00406	
GN 1/6	02-001-00407	02-001-00408	02-001-00409	
GN 1/9	02-001-00410	02-001-00411		

UNICA TRANSLUCENT Polypropylene Drain Shelf / Lid

Size	Drain Shelf	Lid
GN 1/1	02-001-00381	02-001-00386
GN 1/2	02-001-00382	02-001-00387
GN 1/3	02-001-00383	02-001-00388
GN 1/4	02-001-00384	02-001-00389
GN 1/6	02-001-00385	02-001-00390
GN 1/9		02-001-00391

UNICA Colour Clip for GN Pans & Lids

Product Code	Colour
02-001-00518	Blue
02-001-00519	Green
02-001-00520	Gray
02-001-00521	Red
02-001-00522	White
02-001-00523	Yellow



JIWINS CLEAR Polycarbonate Food Pan

Size / Depth	6.5cm	10cm	15cm	20cm
GN 1/1	02-001-00193	02-001-00194	02-001-00195	02-001-00196
GN 1/2	02-001-00197	02-001-00198	02-001-00199	02-001-00200
GN 1/3	02-001-00201	02-001-00202	02-001-00203	02-001-00204
GN 1/4	02-001-00205	02-001-00206	02-001-00207	
GN 1/6	02-001-00208	02-001-00209	02-001-00210	
GN 1/9	02-001-00211	02-001-00212		
GN 2/1			02-001-00583	02-001-00584



JIWINS Polycarbonate Drain Shelf / Lids

Size / Depth	Plastic Drain Shelf for Food Pan	PE Seal Lid	Lid without Handle	Lid with Handle	Notched Lid with Handle
GN 1/1	02-001-00188	02-001-00229	02-001-00213	02-001-00219	02-001-00224
GN 1/2	02-001-00189	02-001-00230	02-001-00214	02-001-00220	02-001-00225
GN 1/3	02-001-00190	02-001-00231	02-001-00215	02-001-00221	02-001-00226
GN 1/4	02-001-00191	02-001-00232	02-001-00216	02-001-00222	02-001-00227
GN 1/6	02-001-00192	02-001-00233	02-001-00217	02-001-00223	02-001-00228
GN 1/9		02-001-00234	02-001-00218		
GN 2/1			02-001-00585		



Stainless Steel Perforated Pail / Bucket

Product Code	Dimension
02-002-00146	Ø27 x H25cm
02-002-00147	Ø32 x H30cm
02-002-00148	Ø37 x H35cm



CCK TAPED BODY Stainless Steel Water Pail / Bucket

Product Code	Dimension	Capacity
02-002-00149	Ø12 x H11"	14.0ℓ
02-002-00150	Ø13 x H11.2"	17.0ℓ
02-002-00151	Ø14 x H12"	23.0ℓ



CAMBRO PE Pail w/ Capacity Markings & Lid

Product Code	Capacity	Colour
02-002-00145	21ℓ - 22qt	<input type="checkbox"/> White



PIAZZA Stainless Steel Graduated Bucket with Bottom Ring / Lid

Dimension	Bucket/Lid	Capacity	Product Code
Ø27 x H24cm	Bucket	10.0ℓ	02-002-00153(XX)
	Lid		02-002-00155(XX)
Ø28 x H25.8cm	Bucket	12.0ℓ	02-002-00154
	Lid		02-002-00156(XX)



Stainless Steel Japanese Style Bucket / Pail with Base

Product Code	Dimension	Capacity
02-002-00157	Ø26.5 x H25.5cm	10.0ℓ
02-002-00158	Ø29.5 x H30cm	15.0ℓ



Stainless Steel Pail with Graduation

Product Code	Dimension	Capacity
02-002-00159(XX)	Ø30 x H12.6cm	13.0ℓ
02-002-00161(XX)	Ø22.5 x H20.5cm	5.5ℓ
02-002-00162(XX)	Ø29.5 x H25cm	12.0ℓ



Stainless Steel Fryer Container with Grill Net

Product Code	Dimension
02-002-00389	33 x 24cm



ZEBRA Stainless Steel Wash Basin

Product Code	Dimension	Capacity
02-002-00084	Ø36 x H11cm	7.0ℓ
02-002-00085	Ø40 x H12.5cm	10.0ℓ
02-002-00086	Ø50 x H14cm	16.0ℓ
02-002-00087	Ø55 x H15.5cm	24.0ℓ
02-002-00088	Ø60 x H17.5cm	32.0ℓ
02-002-00089	Ø70 x H19.5cm	48.0ℓ



Stainless Steel Wash Basin

Product Code	Dimension
02-002-00133	Ø12 x H5cm
02-002-00134	Ø14 x H5.5cm
02-002-00135	Ø16 x H6cm
02-002-00136	Ø18 x H6.5cm



Stainless Steel Oil Pot (Basin)

Product Code	Dimension
02-002-00256	9"
02-002-00257	10"
02-002-00258	11"

FOUR BRIGHT Aluminium Utility Basin

Product Code	Dimension
02-002-00015	Ø20 x H10.5cm
02-002-00016	Ø22 x H12cm
02-002-00017	Ø24 x H13cm
02-002-00018	Ø26 x H14cm
02-002-00019	Ø28 x H14.5cm
02-002-00020	Ø30 x H15.2cm
02-002-00021	Ø32 x H16cm



Stainless Steel Oil Pot Local Style

Product Code	Dimension
02-002-00259	22cm
02-002-00260	24cm
02-002-00261	26cm



02-002-00223



02-002-00226

CCK Stainless Steel Oil Pot

Product Code	Dimension	Capacity	Type
02-002-00223	Ø8 x H7.8"	5.7ℓ	Local
02-002-00224	Ø8.6 x H6.5"	6.0ℓ	Local
02-002-00225	Ø8 x H5.8"	5.0ℓ	Basin
02-002-00226	Ø9 x H5.8"	6.0ℓ	Basin
02-002-00227	Ø10 x H16"	7.5ℓ	Basin
02-002-00228	Ø11 x H6.5"	9.5ℓ	Basin



LACOR Stainless Steel Semi-Spherical Mixing Bowl

Product Code	Dimension	Capacity
02-002-00034(XX)	Ø22 x H11cm	2.7ℓ
02-002-00035(XX)	Ø26 x H13cm	4.0ℓ



CCK Stainless Steel Mixing Bowl

Product Code	Dimension	Capacity
02-002-00001	Ø20 x H8cm	1.75ℓ
02-002-00002	Ø26 x H11cm	3.9ℓ
02-002-00003	Ø28 x H11cm	4.8ℓ
02-002-00004	Ø30 x H12cm	5.6ℓ
02-002-00005	Ø32 x H13cm	7.0ℓ
02-002-00006	Ø34 x H14cm	8.0ℓ
02-002-00007	Ø36 x H15cm	10.5ℓ
02-002-00008	Ø43 x H14cm	14.0ℓ
02-002-00009	Ø45 x H15cm	18.0ℓ
02-002-00010	Ø52 x H16cm	22.0ℓ
02-002-00011	Ø58 x H17cm	30.0ℓ
02-002-00012	Ø61 x H18cm	38.0ℓ
02-002-00013	Ø65 x H19cm	44.5ℓ
02-002-00014	Ø70 x H20cm	54.0ℓ



Stainless Steel Mixing Bowl, Economy

Product Code	Dimension	Capacity
02-002-00109	Ø14 x H6.8cm	0.52ℓ
02-002-00110	Ø17.2 x H7.2cm	1.1ℓ
02-002-00111	Ø19.2 x H8.3cm	1.45ℓ
02-002-00112	Ø21.5 x H8.4cm	1.7ℓ
02-002-00113	Ø23.5 x H8.6cm	2.15ℓ
02-002-00114	Ø16.5 x H6cm	0.7ℓ
02-002-00115	Ø20 x H6.5cm	1.4ℓ
02-002-00116	Ø23 x H7cm	1.9ℓ
02-002-00117	Ø25.5 x H8cm	2.85ℓ
02-002-00118	Ø27 x H8.5cm	3.8ℓ
02-002-00119	Ø29.5 x H9.5cm	4.75ℓ
02-002-00120	Ø33.5 x H10cm	7.6ℓ
02-002-00121	Ø36 x H11.5cm	9.5ℓ
02-002-00122	Ø41 x H12cm	12.5ℓ
02-002-00123	Ø45 x H14cm	15.5ℓ
02-002-00124	Ø48 x H15cm	19.0ℓ
02-002-00125	Ø26 x H9.5cm	2.65ℓ
02-002-00126	Ø28 x H10cm	3.6ℓ
02-002-00127	Ø30 x H11cm	4.5ℓ
02-002-00128	Ø32 x H11cm	5.5ℓ
02-002-00129	Ø34 x H11cm	7.0ℓ
02-002-00130	Ø36 x H12cm	8.3ℓ



Stainless Steel Tapered Mixing Bowl (Beaded Edge)

Product Code	Dimension
02-002-00137	Ø16 x H8cm
02-002-00138	Ø20 x H9.5cm
02-002-00139	Ø24 x H10.5cm
02-002-00140	Ø28 x H12.5cm
02-002-00141	Ø32 x H13.5cm
02-002-00142	Ø36 x H15.5cm
02-002-00143	Ø40 x H18cm



ZEBRA Stainless Steel Mixing Bowl

Product Code	Dimension	Capacity
02-002-00071	Ø15 x H6.5cm	0.7ℓ
02-002-00072	Ø18 x H7.5cm	1.2ℓ
02-002-00073	Ø21 x H8.5cm	2.0ℓ
02-002-00074	Ø24 x H9.5cm	3.2ℓ
02-002-00075	Ø27 x H11cm	4.2ℓ
02-002-00076	Ø30 x H12cm	5.8ℓ
02-002-00077	Ø33 x H13cm	7.7ℓ
02-002-00078	Ø36 x H14cm	10.3ℓ
02-002-00079	Ø40 x H16cm	14.5ℓ
02-002-00080	Ø45 x H17.5cm	19.6ℓ
02-002-00081	Ø50 x H19.5cm	24.0ℓ



Stainless Steel Mixing Bowl, Japan

Product Code	Dimension	Capacity
02-002-00091	Ø15 x H6.5cm	0.85ℓ
02-002-00092	Ø18 x H7.5cm	1.83ℓ
02-002-00093	Ø21 x H8.5cm	2.2ℓ
02-002-00094	Ø24 x H9.5cm	3.2ℓ
02-002-00095	Ø27 x H10.5cm	4.55ℓ
02-002-00096	Ø30 x H11.5cm	6.3ℓ
02-002-00097	Ø33 x H12.5cm	8.2ℓ
02-002-00098	Ø36 x H13.5cm	10.5ℓ
02-002-00099	Ø39 x H14.5cm	12.6ℓ
02-002-00100	Ø42 x H15.5cm	16.2ℓ
02-002-00101	Ø45 x H16.5cm	20.5ℓ
02-002-00102	Ø50 x H18.5cm	25.0ℓ
02-002-00103	Ø55 x H20.5cm	35.0ℓ
02-002-00104	Ø60 x H22.5cm	45.0ℓ



LACOR 18-10 Stainless Steel Spherical Mixing Bowl with Handles

Product Code	Dimension	Capacity
02-002-00023	Ø22 x H11cm	2.7ℓ
02-002-00024	Ø26 x H13cm	4.0ℓ
02-002-00025	Ø32 x H17cm	9.5ℓ
02-002-00026	Ø36 x H18cm	12.0ℓ
02-002-00027	Ø40 x H21cm	14.5ℓ



LACOR 18-10 Stainless Steel Conical Mixing Bowl with Handles

Product Code	Dimension	Capacity
02-002-00028	Ø28 x H13.2cm	5.0ℓ
02-002-00029	Ø32 x H14.5cm	7.0ℓ
02-002-00030	Ø36 x H16cm	11.0ℓ
02-002-00031	Ø40 x H18cm	15.0ℓ
02-002-00032	Ø45 x H20cm	22.0ℓ
02-002-00033	Ø50 x H22cm	30.0ℓ



LACOR 18/10 Stainless Steel Mixing Bowl Stand

Product Code	Dimension
02-002-00022	Ø20cm



SCHNEIDER Plastic Microwaveable Mixing Bowl

Product Code	Dimension	Capacity
02-002-00063	Ø19 x 7.9cm	1.0ℓ
02-002-00064	Ø24 x 11.5cm	2.5ℓ
02-002-00065	Ø28 x 13.5cm	4.5ℓ
02-002-00066	Ø32.5 x 14.7cm	6.0ℓ
02-002-00067	Ø36 x 16.5cm	9.0ℓ
02-002-00068	Ø40 x 18.5cm	13.0ℓ



SAFICO 18/10 Stainless Steel Conical Mixing Bowl

Product Code	Dimension
02-002-00051	Ø20 x H10cm
02-002-00052	Ø24 x H11.2cm
02-002-00053	Ø28 x H11.9cm
02-002-00054	Ø32 x H14cm
02-002-00055	Ø36 x H15cm
02-002-00056	Ø40 x H17cm



MARINEX Glass Bowl without Lid

Product Code	Dimension	Capacity
02-002-00039	Ø21 x H9cm	1.5ℓ
02-002-00040	Ø27 x H10.3cm	3.0ℓ
02-002-00041	Ø29 x H10.5cm	4.0ℓ



MAUVIEL M'PASSION Copper Eggwhite Beating Bowl with Handle

Product Code	Dimension	Capacity
02-002-00042(XX)	Ø26 x H13cm	4.6ℓ
02-002-00043	Ø30 x H15cm	7.0ℓ
02-002-00044(XX)	Ø35 x H18cm	12.0ℓ
02-002-00045	Ø40 x H20cm	16.7ℓ



MAUVIEL M'PASSION Copper Eggwhite Beating Bowl with Ring

Product Code	Dimension	Capacity
02-002-00046	Ø26 x H13cm	4.6ℓ
02-002-00047	Ø30 x H15cm	7.0ℓ
02-002-00048	Ø35 x H18cm	12.0ℓ
02-002-00049	Ø40 x H20cm	16.7ℓ



MAUVIEL M'PASSION Stainless Steel Support for Beating Bowl

Product Code	Dimension
02-002-00050(XX)	48 x 35.5 x 17.5cm



Stainless Steel Utility Bowl

Product Code	Dimension
02-002-00131	Ø12 x H6.5cm
02-002-00132	Ø14 x H7.5cm



ZEBRA Stainless Steel Bowl

Product Code	Dimension	Capacity
02-002-00234	9cm	9.5ℓ
02-002-00235	10cm	12.0ℓ
02-002-00236	11cm	14.5ℓ



Stainless Steel Footed Bowl

Product Code	Dimension
02-002-00105	Ø14 x H8cm
02-002-00106	Ø16 x H8.5cm
02-002-00107	Ø18 x H10.5cm
02-002-00108	Ø20 x H11cm



CCK Stainless Steel Sauce / Condiment Bowl

Product Code	Dimension	Capacity
02-002-00218	Ø14 x H8cm	1.0ℓ
02-002-00219	Ø16 x H10.5cm	1.65ℓ
02-002-00220	Ø18 x H11cm	2.4ℓ
02-002-00221	Ø20 x H12.5cm	3.5ℓ



Stainless Steel Sauce / Condiment Bowl

Product Code	Dimension
02-002-00252	12cm
02-002-00253	14cm
02-002-00254	16cm
02-002-00255	18cm



ZEBRA Stainless Steel Water Bowl

Product Code	Dimension
02-002-00248	12cm
02-002-00249	14cm
02-002-00250	16cm
02-002-00251	18cm



Stainless Steel Steaming Bowl

Product Code	Dimension
02-002-00280	Ø11 x H7.5cm



CCK Stainless Steel Chicken Steaming Bowl

Product Code	Dimension	Capacity
02-002-00222	Ø12.5 x H10cm	0.6ℓ



ZEBRA Stainless Steel Colour Bowl

Dimension	Blue	Green	Pink	Yellow
Ø11cm	02-002-00237	02-002-00238	02-002-00239	02-002-00240
Ø15cm	02-002-00241	02-002-00242	02-002-00243	02-002-00244



Stainless Steel Mar Bowl with Holes

Product Code	Dimension
02-002-00263	16cm
02-002-00264	18cm
02-002-00265	20cm



Stainless Steel Round Mar Bowl

Product Code	Dimension
02-002-01098	Ø10cm
02-002-00272	Ø12cm
02-002-00273	Ø14cm
02-002-00274	Ø16cm
02-002-00275	Ø18cm
02-002-00276	Ø20cm
02-002-00277	Ø22cm
02-002-00278	Ø24cm
02-002-00279	Ø26cm



LACOR 18-10 Stainless Steel Spherical Footer Colander with Handles

Product Code	Dimension	Capacity
02-002-00343	Ø32 x H18cm	9.5ℓ
02-002-00344	Ø36 x H19cm	12.0ℓ
02-002-00345	Ø40 x H21cm	14.5ℓ



Stainless Steel Colander

Product Code	Dimension
02-002-00398	Ø8 x H4cm
02-002-00399	Ø11 x H5cm
02-002-00400	Ø14 x H5.5cm
02-002-00401	Ø17 x H6.5cm
02-002-00402	Ø20 x H7.5cm
02-002-00403	Ø23 x H8.5cm
02-002-00404	Ø26 x H9.5cm
02-002-00405	Ø29 x H11cm



Stainless Steel Mar Bowl

Product Code	Dimension
02-002-00266	Ø12cm
02-002-00267	Ø14cm
02-002-00268	Ø16cm
02-002-00269	Ø18cm
02-002-00270	Ø20cm
02-002-00271	Ø22cm



CCK Stainless Steel Ingredient Dish Footed

Product Code	Dimension
02-002-00215	Ø12"
02-002-00216	Ø13"
02-002-00217	Ø14"



Aluminium Colander with Handle & Base

Product Code	Dimension	Capacity
02-002-00380	Ø39 x H19cm	11qt
02-002-00381	Ø42 x H24cm	16qt



LACOR Stainless Steel Rectangle French Fry Colander

Product Code	Dimension
02-002-00352(XX)	50 x 39 x 8cm



LACOR 18-10 Stainless Steel Conical Colander with Stand

Product Code	Dimension	Capacity
02-002-00346	Ø28 x H17cm	13.2ℓ
02-002-00347	Ø32 x H20cm	14.5ℓ
02-002-00348	Ø36 x H23cm	16.0ℓ
02-002-00349	Ø40 x H26cm	18.0ℓ
02-002-00350	Ø45 x H29cm	20.0ℓ
02-002-00351	Ø50 x H33cm	22.0ℓ



Stainless Steel Colander

Product Code	Dimension
02-002-01063	Ø18cm
02-002-01064	Ø20cm
02-002-01065	Ø22.5cm
02-002-01066	Ø25cm
02-002-01067	Ø27.5cm
02-002-01068	Ø30cm
02-002-01069	Ø33cm
02-002-00367	Ø36cm



Plastic Rectangle Deep Colander

Product Code	Dimension
02-002-00382	48 x 35.5 x 17.5cm



Plastic Round Colander

Product Code	Dimension
02-002-00383	Ø16.5 x H6cm
02-002-00384	Ø20 x H7.5cm
02-002-00385	Ø25 x H9cm



Plastic Round Colander

Product Code	Dimension
02-002-00325	Ø17.8 x H7cm
02-002-00326	Ø21.4 x H8.5cm
02-002-00323	Ø24.5 x H8.4cm
02-002-00327	Ø27 x H9.7cm
02-002-00324	Ø28.5 x H9cm
02-002-00328	Ø29.4 x H11.4cm
02-002-00330	Ø31 x H11.5cm
02-002-00329	Ø39 x H14.6cm
02-002-00331	Ø45 x H15cm
02-002-00332	Ø49.5 x H15cm



Plastic Round Colander

Product Code	Dimension
02-002-00386	Ø34 x H13.5cm
02-002-00387	Ø38 x H14.5cm



Plastic Round Colander

Product Code	Dimension
02-002-00388	Ø58 x H21.5cm

Plastic Rectangle Colander

Product Code	Dimension
02-002-00333	13.8 x 9.3 x 5cm
02-002-00334	15.2 x 15.2 x 5.8cm
02-002-00335	27.4 x 20.7 x 7.4cm
02-002-00336	29 x 23.8 x 7cm
02-002-00337	36 x 26.2 x 9.5cm
02-002-00338	40.2 x 31.3 x 11.2cm
02-002-00339	41.5 x 30 x 10.2cm
02-002-00340	46.9 x 33 x 10.7cm
02-002-00341	50 x 40 x 18.5cm



Plastic Rectangle Colander

Product Code	Dimension
02-002-00370	20 x 15 x 6cm
02-002-00371	22 x 17 x 7cm
02-002-00372	26 x 20 x 10cm
02-002-00373	28 x 23 x 7cm
02-002-00374	28 x 23 x 10cm
02-002-00375	30 x 26 x 13cm
02-002-00376	32 x 26 x 9cm
02-002-00377	33 x 28 x 13cm
02-002-00378	40 x 32 x 10cm
02-002-00379	45 x 36 x 13cm
02-002-00354	50 x 40 x 18cm



Bamboo Round Flat Colander

Product Code	Dimension
02-002-00368	Ø23cm



Bamboo Square Flat Colander

Product Code	Dimension
02-002-00369	22 x 22cm



Bamboo Round Bottom Colander

Product Code	Dimension
02-002-00390	Ø17"
02-002-00391	Ø19"
02-002-00392	Ø21"
02-002-00393	Ø24"



Stainless Steel Flavouring / Condiment Bowl with Lid

Product Code	Dimension
02-002-00296	Ø12cm
02-002-00297	Ø14cm
02-002-00298	Ø16cm
02-002-00299	Ø18cm
02-002-00300	Ø20cm



SAFICO Stainless Steel Round Food Storage Canister without Lid

Product Code	Dimension	Capacity
02-002-00230	Ø16 x H13.5cm	2.5ℓ
02-002-00231	Ø20 x H17cm	5.0ℓ
02-002-00232	Ø28 x H23.5cm	14.0ℓ
02-002-00233	Ø24 x H20cm	8.0ℓ



MAUVIEL M'COOK Stainless Steel Roasting Pan w/ Bronze Handles

Product Code	Dimension
01-001-00846	35 x 25 x 7cm
01-001-00847	40 x 30 x 8.5cm



PADERNO Stainless Steel Heavy-Duty Roast Pan with Lid

Product Code	Dimension
01-001-00906(XX)	61 x 43 x 15cm



LACOR 18-10 Stainless Steel Heavy Duty Roast Pan with Movable Handles

Product Code	Dimension
01-001-00977	40 x 30 x 8cm
01-001-00978	50 x 40 x 8cm
01-001-00979	60 x 45 x 8cm
01-001-00980	70 x 45 x 9.5cm



LACOR Stainless Steel Roast Pan with Movable Handles

Product Code	Dimension
01-001-00981	30 x 22 x 5cm
01-001-00983	35 x 26 x 5.3cm
01-001-00985	40 x 20 x 5.6cm
01-001-00987	45 x 32 x 7.5cm



LACOR Stainless Steel Roast Pan with Movable Handles

Product Code	Dimension
01-001-00982	30 x 22 x 7.5cm
01-001-00984	35 x 26 x 7.8cm
01-001-00986	40 x 28 x 8.5cm
01-001-00988	45 x 32 x 9cm



LACOR Aluminium Heavy Duty Roast Pan

Product Code	Dimension	Capacity
01-001-00989	40 x 30 x 6cm	7.45ℓ
01-001-00990	45 x 32 x 7cm	10.4ℓ
01-001-00991	50 x 35 x 8cm	12.6ℓ
01-001-00992	55 x 37 x 9cm	16.3ℓ
01-001-00993	60 x 40 x 9cm	19.0ℓ
01-001-00994	65 x 43 x 10cm	24.3ℓ
01-001-00995	70 x 45 x 10cm	28.7ℓ



SUNNEX Aluminium Bakewell Pan

Product Code	Dimension (L x B x H)	Capacity
01-001-00851	31.8 x 21.6 x 3.8cm	2.2ℓ
01-001-00852	36.8 x 26.7 x 3.8cm	3.1ℓ
01-001-00853	41.9 x 30.5 x 3.8cm	4.1ℓ
01-001-00854	47 x 35.6 x 3.8cm	5.0ℓ
01-001-00855	52.1 x 41.9 x 3.8cm	7.3ℓ
01-001-00856	61 x 45.7 x 3.8cm	8.6ℓ



SUNNEX Aluminium Roasting Deep Dish with Integrated Handles

Product Code	Dimension (L x B x H)
01-001-00858	47 x 35.6 x 10.2cm
01-001-00859	52.1 x 41.9 x 10.2cm
01-001-00860	61 x 45.7 x 10.2cm
01-001-00861	36.8 x 26.7 x 7cm
01-001-00862	41.9 x 30.5 x 7cm
01-001-00863	47 x 35.6 x 7cm
01-001-00864	52.1 x 41.9 x 7cm
01-001-00865	61 x 45.7 x 7cm



AG Stainless Steel (18/8) Wire Grid

Product Code	Dimension	No.
02-002-01088	42.8 x 27.7cm	No. 6
02-002-01089	36 x 24.2cm	No. 8
02-002-01090	30.7 x 22.1cm	No. 10
02-002-01091	28.5 x 21.5cm	No. 12



AG Stainless Steel (18/8) Rectangle Pan

Product Code	Dimension (L x B x H)	Size
02-002-01023	47.5 x 33.3 x 8.2cm	No. 6
02-002-01024	40.6 x 29.3 x 6.4cm	No. 8
02-002-01025	35.3 x 26.4 x 6.1cm	No. 10
02-002-01026	32.2 x 25.2 x 5.3cm	No. 12
02-002-01027	28.6 x 23.1 x 4.9cm	No. 15
02-002-01028	24.8 x 20.2 x 3.7cm	No. 21
02-002-01029	21 x 17 x 3.1cm	No. 30
02-002-01030	18.7 x 14.2 x 3cm	No. 36
02-002-01031	15.5 x 12.6 x 2.7cm	No. 40



AG Stainless Steel (18/8) Cake Tray

Product Code	Dimension (L x B x H)
02-002-01032	21.6 x 15.3 x 1.9cm
02-002-01033	28.4 x 20.2 x 1.9cm
02-002-01034	31.7 x 22.8 x 2cm
02-002-01035	34.8 x 25 x 2.1cm
02-002-01036	38.4 x 28.5 x 2.3cm
02-002-01037	41.5 x 30.6 x 2.3cm



Stainless Steel Rectangular Deep Tray

Product Code	Dimension (L x B x H)
02-002-01136	25 x 19.1 x 4.3cm
02-002-01137	28 x 21.9 x 5cm
02-002-01138	30.5 x 23.6 x 5.3cm
02-002-01139	33.5 x 25.3 x 6.1cm
02-002-01140	39.5 x 27.5 x 6.4cm
02-002-01141	46 x 32 x 8.4cm
02-002-01142	56 x 35 x 9cm



Stainless Steel Deep Roasting Pan

Product Code	Dimension (L x B x H)
01-001-00876	13 x 10 x 5cm
01-001-00878	16 x 12 x 6.5cm
01-001-00879	18 x 12.5 x 7cm
01-001-00880	20 x 14 x 7.5cm
01-001-00877	22 x 16.4 x 7.5cm
01-001-00881	25.3 x 17.5 x 8cm



Stainless Steel Rectangle Pan

Product Code	Dimension (L x B x H)
02-002-01143	24 x 19 x 5cm
02-002-01144	30 x 23.5 x 5cm
02-002-01145	35 x 27.5 x 5cm
02-002-01146	40 x 30 x 6cm



FISCHER Stainless Steel Butchery Tray

Product Code	Dimension (L x B x H)
02-002-00180(XX)	32.5 x 23 x 4cm
02-002-00181	51 x 36 x 4cm
02-002-00182(XX)	42 x 32 x 4cm



ZEBRA Stainless Steel Rectangular Tray

Product Code	Dimension
02-002-00201	25 x 21cm
02-002-00202	30 x 25cm
02-002-00203	36 x 29cm
02-002-00204	41 x 32.7cm
02-002-00205	46 x 36.7cm



ZEBRA Stainless Steel Round Dish

Product Code	Dimension
02-002-00245	9"
02-002-00246	10"



Stainless Steel Rectangle Tray

Product Code	Dimension (L x B x H)
02-002-01128	25 x 19.1 x 2cm
02-002-01129	28 x 21.9 x 2cm
02-002-01130	30.5 x 23.6 x 2cm
02-002-01131	33.5 x 25 x 2cm
02-002-01132	39.5 x 27 x 2cm
02-002-01133	45.5 x 32 x 2cm
02-002-01134	56 x 35 x 2cm
02-002-01135	56 x 40 x 2cm



FISCHER Stainless Steel Grid for Butchery Tray

Product Code	Dimension
02-002-00183(XX)	27 x 17.5cm
02-002-00184(XX)	36 x 26cm
02-002-00185	45 x 29cm



FOUR BRIGHT Aluminium Rectangle Tray

Product Code	Dimension
02-002-00191	28 x 20cm
02-002-00190	33 x 24cm
02-002-00210	35 x 26 x 3cm
02-002-00189	38 x 28cm
02-002-00211	40 x 29 x 3cm
02-002-00212	44 x 32 x 3cm
02-002-00213	49 x 37 x 3cm
02-002-00214	54 x 40 x 3cm



FOUR BRIGHT Aluminium Rectangle Deep Pan

Product Code	Dimension (L x B x H)	Size
02-002-00188	33 x 22.5 x 5cm	3
02-002-00187	36 x 27 x 6cm	2
02-002-00186	40 x 30 x 6.5cm	1



Stainless Steel 2-Compartment Condiment Box with Lid

Product Code	Dimension (L x B x H)
02-002-00287	22 x 15 x 6cm



Stainless Steel 3-Compartment Condiment Box with Lid

Product Code	Dimension (L x B x H)
02-002-00288	33 x 15 x 6cm



Stainless Steel 4-Compartment Condiment Box with Lid

Product Code	Dimension (L x B x H)
02-002-00289	30 x 22 x 6.5cm



Stainless Steel 6-Compartment Condiment Box with Lid

Product Code	Dimension (L x B x H)
02-002-00290	32 x 30 x 6.5cm



Stainless Steel Condiment Dispenser

Product Code	Dimension (L x B x H)	Capacity
02-002-00291	23 x 16 x 10cm	3x1 pint / 473ml
02-002-00292	30 x 16 x 10cm	4x1 pint / 473ml
02-002-00293	38 x 16 x 10cm	5x1 pint / 473ml
02-002-00294	38 x 16 x 10cm	6x1 pint / 473ml



SAN JAMAR Stainless Steel Condiment Dispenser

Product Code	Dimension (L x B x H)	Capacity
02-002-00315	8.9 x 23.2 x 14.6cm	3x1 pint / 473ml
02-002-00316	8.9 x 30.8 x 14.6cm	4x1 pint / 473ml
02-002-00317	8.9 x 38.1 x 14.6cm	5x1 pint / 473ml
02-002-00318	8.9 x 45.7 x 14.6cm	6x1 pint / 473ml



SAN JAMAR Stainless Steel Condiment Dispenser with Individual Notched Lid

Product Code	Dimension (L x B x H)	Capacity
02-002-00319	8.9 x 15.2 x 14.6cm	1x1 qt / 946ml
02-002-00320	8.9 x 30.5 x 14.6cm	2x1 qt / 946ml



JIWINS Plastic Condiment Dispenser

Product Code	Dimension (L x B x H)	Capacity
02-002-00281	50 x 16 x 9cm	4x1 pint / 473ml
02-002-00282	50 x 16 x 9cm	6x1 pint / 473ml



SAN JAMAR Dome Condiment Dispenser

Product Code	Capacity	Capacity
02-002-00304	3x2 qt / 946ml	Dome center, 2 x handles
02-002-00305	4x3 qt / 946ml	Dome center, 2 x handles
02-002-00306	1x2 qt, 4x1qt / 946ml	Garnish center 2 snap-on caddies, handles
02-002-00307	6x1 qt / 946ml	Garnish center 2 snap-on caddies, handles



SAN JAMAR Dome Stacker Condiment Dispenser

Product Code	Capacity
02-002-00308	3x2 qt / 946ml 6x1qt / 946ml (chillable)



SAN JAMAR Mini Dome Condiment Dispenser

Product Code	Capacity	
02-002-00310	2x1 pt / 473mℓ	Garnish Center



SAN JAMAR Mini Dome Condiment Dispenser with Notched Lids

Product Code	Capacity	
02-002-00311	4x1.5qt / 473mℓ 4x1 pt / 473mℓ	Dome stacker 2 notched lids, 2 standaround lids



SAN JAMAR Mini Dome Stacker Condiment Dispenser

Product Code	Capacity	
02-002-00312	2x2 qt / 473mℓ 1x1 qt / 473mℓ	



SAN JAMAR Plastic Condiment Tray Insert

Product Code	Dimension (L x B x H)	Capacity
02-002-00313	6.4 x 12.7 x 7.3cm	1 pint / 473mℓ



SAN JAMAR Plastic Condiment Tray Insert

Product Code	Dimension (L x B x H)	Capacity
02-002-00314	14.9 x 7 x 14cm	1qt / 946mℓ



SAN JAMAR Deep Tray Insert

Product Code	Capacity	
02-002-00302	2qt / 1.8ℓ	



SAN JAMAR Deep Tray Insert for Dome Condiment Dispenser

Product Code	Capacity	
02-002-00303	3 pint / 1.4ℓ	



SAN JAMAR Chillable Standaround Tray Insert

Product Code	Capacity	
02-002-00301	1 pint / 473mℓ	



SAN JAMAR EZ-Chill Refreezable Ice Pack

Product Code	Capacity	
02-002-00309	6pcs/pack	



SAN JAMAR Stainless Steel Garnish Tray with Ice Packs

Product Code	Dimension (L x B x H)	Capacity
02-002-00321	147 x 457 x 137mm	3x1 qt / 946mℓ, 3 x Ice packs



TABLECRAFT *Stainless Steel Expandable Countertop Squeeze Bottle*

Product Code	Dimension (L x B x H)	
02-002-00917	10.5" x 3.75" x 2"	Holds up to 6 bottles



TABLECRAFT *Stainless Steel Four Hole Squeeze Bottle Holder*

Product Code	Dimension	
02-002-00918	6.25" x 7"	Holds 12oz and 16oz bottles. For 1/6 pan size. Pan not included.



TABLECRAFT *Stainless Steel Six Hole Squeeze Bottle Holder*

Product Code	Dimension	
02-002-00919	12.75" x 7"	Holds 12oz, 16oz and 24oz bottles. For 1/3 pan size. Pan not included.



TABLECRAFT *Stainless Steel Eight Hole Squeeze Bottle Holder*

Product Code	Dimension	
02-002-00920	12.75" x 7"	Holds 12oz and 16oz bottles. For 1/3 pan size. Pan not included.



TABLECRAFT *PE Dual Way Squeeze Bottle with InveraTop™*

Product Code	Dimension	Capacity
02-002-00902	5.3cm opening	16oz / 473mℓ



TABLECRAFT *NATURAL Squeeze Bottle One Tip*

Product Code	Dimension	Capacity
02-002-00903	6.3cm opening	20oz / 591mℓ



TABLECRAFT *NATURAL Squeeze Bottle Triple Tip*

Product Code	Dimension	Capacity
02-002-00904	6.3cm opening	16oz / 473mℓ
02-002-00905	6.3cm opening	24oz / 710mℓ
02-002-00914	6.3cm opening	32oz / 946mℓ



TABLECRAFT *NATURAL Dual Way Squeeze Bottle*

Product Code	Dimension	Capacity
02-002-00907	6.3cm opening	24oz / 710mℓ



TABLECRAFT *NATURAL Squeeze Bottle with Natural Cane Tiptop, Dual Way*

Product Code	Capacity
02-002-00908	16oz / 473mℓ
02-002-00909	24oz / 710mℓ



Metal Stand Adjustable T-Stand for 02-002-00928

Product Code	Dimension
02-002-00926	36 x 30 x 89cm

TABLECRAFT PE Dual Way Squeeze Bottle with InverTop™

Product Code	Dimension	Capacity	
02-002-00910	5.3cm opening	12oz / 355ml	Works with slow-flowing condiments such as barbecue and mayonnaise
02-002-00913	5.3cm opening	24oz / 710ml	Works with slow-flowing condiments such as barbecue and mayonnaise

JIWINS PE Squeeze Bottle

Dimension	Capacity	Clear	Red	Yellow
Ø5 x 17.5cm	8oz / 236ml	02-002-00884	02-002-00973	02-002-00886
Ø5.5 x 20.6cm	12oz / 355ml	02-002-00878	02-002-00971	02-002-00880
Ø7 x 24cm	24oz / 710ml	02-002-00881	02-002-00972	02-002-00883

A-STAR Plastic Multi Purpose Squeeze Bottle with Cover

Dimension	Capacity	Green	Red	White	Yellow
7 x 18cm	12oz / 350ml	02-002-00889	02-002-00974	02-002-00891	02-002-00892
7.5 x 26.8cm	25oz / 750ml	02-002-00893	02-002-00894	02-002-00895	02-002-00896

Plastic Refillable Container with Squeeze Pump

Product Code	Dimension	Capacity	Plastic Refillable Container	Plastic Squeeze Dispenser	Accessory Stand
02-002-00928	18.5cm Thread: Ø4cm	6l	02-002-00927 Dimension: 18.5cm Thread: Ø4cm	02-002-00925 Dimension: 17 x 17 x 22.5cm	02-002-00926 Dimension: 36 x 30 x 89cm

WESTMARK Stainless Steel Garnishing / Cocoa Castor

Product Code	Dimension	Capacity
02-002-00942	Ø7.5 x H10cm	9oz (4 Shaker Plates)

Stainless Steel Condiment Can with Mesh

Product Code	Dimension
02-002-00949	Ø6 x H8cm



Stainless Steel Sugar Dredger with Mesh Cover

Product Code	Dimension	Capacity
02-002-00950	Ø7 x H9cm	10oz



Stainless Steel Sugar / Icing Shaker

Product Code	Dimension	Capacity
02-002-00943	Ø7 x H9cm	10oz



Stainless Steel Sugar / Icing Shaker with Handle

Product Code	Dimension	Capacity
02-002-00944	Ø7 x H9cm	10oz



Stainless Steel Sesame Can

Product Code	Dimension	
02-002-00951	Ø6.5 x H10cm	3.5mm hole



Stainless Steel Salt / Sesame Can

Product Code	Dimension
02-002-00941	Ø7.2 x H9cm



Stainless Steel Pepper Shaker w/ Handle & 'P' Cover

Product Code	Dimension	Capacity
02-002-00945	Ø7 x H9cm	10oz



Stainless Steel Pepper Shaker w/ 'P' Cover

Product Code	Dimension	Capacity
02-002-00946	Ø7 x H9cm	10oz



Stainless Steel Pepper Can

Product Code	Dimension
02-002-00940	Ø7.2 x H9cm



Stainless Steel Salt / Pepper Can

Product Code	Dimension
02-002-00939	Ø6.5 x H11cm



Stainless Steel Salt Shaker w/ Handle & 'S' Cover

Product Code	Dimension	Capacity
02-002-00947	Ø7 x H9cm	10oz



Stainless Steel Salt Shaker w/ 'S' Cover

Product Code	Dimension	Capacity
02-002-00948	Ø7 x H9cm	10oz



Stainless Steel Multi Purpose Shaker

Product Code	Dimension
02-002-00952	Ø6.5 x H9.5cm



Stainless Steel Shaker for Salt or Pepper

Product Code	Dimension	Capacity
02-002-00953	Ø5 x H7cm	8oz
02-002-00954	Ø7 x H8.5cm	9.5oz
02-002-00955	Ø7 x H11.5cm	12oz



TABLECRAFT Swirled Cheese Shaker w/ Chrome Perforated Top

Product Code	Capacity
02-002-01107	6oz



CAMBRO Plastic Shaker with Salt & Pepper Lid

Product Code
02-002-00975



CAMBRO Plastic Shaker with Cheese Lid

Product Code
02-002-00933



CAMBRO Salt and Pepper Lid Only

Product Code	Colour
02-002-00936(XX)	Beige



CAMBRO Plastic Shaker with Medium Ground Lid

Product Code
02-002-00935



WESTMARK Stainless Steel Strainer

Product Code	Dimension
02-002-00423	Ø20 x L42cm



LACOR Stainless Steel Food Mill with 2 Discs

Product Code	Dimension	Capacity	
02-002-00422	Ø20 x H9cm	1.5l	Light-duty
02-002-00420	Ø26 x H13cm	5.0l	Heavy-duty
02-002-00421	Ø32 x H15cm	8.0l	Heavy-duty



LACOR Stainless Steel Food Mill with 2 Discs

Product Code	Dimension	Capacity
02-002-00419	Ø30 x H12.5cm	3.5l



L. TELLIER Stainless Steel Food Mill w/ 3 Stainless Steel Discs

Product Code	Dimension	
02-002-00417	Ø31 x H25cm	Sieves 1.5mm, 2.5mm, 4.0mm



Accessories Sieve

L. TELLIER Food Mill C/W 1 Disc, Stainless Steel Sieve

Product Code	Dimension	
02-002-00411	Ø37 x H32cm	Comes with 1 Sieve Ø3.0mm
02-002-00412	Ø1.0mm	Accessories Sieve
02-002-00413	Ø1.5mm	
02-002-00414	Ø2.0mm	
02-002-00416	Ø3.0mm	
02-002-00415	Ø4.0mm	



Stainless Steel Flour Sieve w/ Hand Press

Product Code	Dimension
02-002-00711	Ø12 x H13cm



CCK Stainless Steel Flour Sieve Heavy Duty

Product Code	Dimension
02-002-00688	Ø10"
02-002-00689	Ø12"
02-002-00690	Ø14"
02-002-00691	Ø16"



Stainless Steel Flour Sieve with 4 Interchangeable Mesh

Product Code	Dimension	
02-002-01093	Ø26cm	Mesh 1: 0.075 x Ø0.016cm, Mesh 2: 0.1 x Ø0.024cm, Mesh 3: 0.2 x Ø0.028cm, Mesh 4: 0.3 x Ø0.038cm



Accessories Sieve

L. TELLIER Stainless Steel Food Mill on Stand with 1 Sieve (P10)

Product Code	Dimension	
02-002-00406(XX)	Ø39 x H80cm	Comes with 1 Sieve Ø3.0mm
02-002-00407(XX)	Ø1.0mm	Accessories Sieve
02-002-00408(XX)	Ø1.5mm	
02-002-00409(XX)	Ø2.0mm	
02-002-00410(XX)	Ø4.0mm	



LACOR Stainless Steel Flour Sieve P50

Product Code	Dimension
02-002-00692(XX)	Ø30cm



LACOR Stainless Steel Sieve P25

Product Code	Dimension
02-002-00693(XX)	Ø30cm



Stainless Steel Flour Sieve

Product Code	Dimension
02-002-00699	Ø16cm
02-002-00700	Ø18cm
02-002-00701	Ø21cm
02-002-00702	Ø23cm
02-002-00703	Ø26cm
02-002-00704	Ø29cm
02-002-00705	Ø35cm
02-002-00706	Ø40cm
02-002-00707	Ø45cm



Stainless Steel Potato Ricer / Press

Product Code	Dimension
02-002-00427	30.5 x 9.5cm



Stainless Steel Potato Masher

Product Code	Dimension
02-002-00428	28 x 7cm
02-002-00429	Ø12 x H60cm
02-002-00430	Ø15 x H80cm



MICROPLANE GOURMET Stainless Steel Grater

Product Code	Dimension	Type	
02-002-00447	30 x 7.5cm	Fine	Use to zest citrus, grate hard round cheeses,spices, chillies and ginger.
02-002-00446	30 x 7.5cm	Medium Ribbon	Use to grate chocolate, coconut,soft cheeses, zucchini and onion.
02-002-00445	30 x 7.5cm	Coarse	Use to grate hard round cheeses, coconut,carrots, garlic and chocolate.
02-002-00449	30 x 7.5cm	Extra Coarse	Use to grate zucchini, potatoes,soft cheeses, carrots and cabbage.
02-002-00451	30 x 7.5cm	Ultra Coarse	For use with cabbage, soft cheeses, zucchini,carrots, potatoes, apples and other foods that require larger grating surface



MICROPLANE PROFESSIONAL Stainless Steel Grater

Product Code	Dimension	Type	
02-002-00457	33 x 7.6cm	Fine / Spice	Use to zest citrus, grate hard round cheeses,spices, chillies and ginger.
02-002-00456	33 x 7.6cm	Medium Ribbon	Use to grate chocolate, coconut,soft cheeses, zucchini and onion.
02-002-00455	33 x 7.6cm	Coarse	Use to grate hard round cheeses, coconut,carrots, garlic and chocolate.
02-002-00459	33 x 7.6cm	Extra Coarse	Use to grate zucchini, potatoes,soft cheeses, carrots and cabbage.



MICROPLANE SPECIALTY 4-Sided Box Grater (Dishwasher safe)

Product Code	Dimension	Type
02-002-00461	13 x 8 x 26cm	Ultra coarse; Fine/zester; Medium ribbon; Slicer



LACOR Stainless Steel Potato Grater

Product Code	Dimension	Type
02-002-00436	25.5 x 11cm	Flat Fine
02-002-00437	25.5 x 11cm	Flat Slice / Fine / Coarse
02-002-00435	25.5 x 11cm	Flat Coarse



LACOR Stainless Steel Grater

Product Code	Dimension	Type
02-002-00439	22 x 3.5cm	Long Fine
02-002-00440	22 x 3.5cm	Long Medium
02-002-00438	22 x 3.5cm	Long Coarse



LACOR Stainless Steel 4-Sided Box Grater

Product Code	Dimension
02-002-00434	11 x 9 x 23cm



LACOR Stainless Steel Nutmeg Grater

Product Code	Dimension
02-002-00441	Ø4 x L14cm



LACOR Stainless Steel Rotary Cheese Grater with 2 Blades

Product Code	Dimension
02-002-00442	20 x 13.5 x 10cm



BOSKA ROMANO Hand Grater

Product Code	Dimension
02-002-00432	No sharp edges. 1 press function.



MICROPLANE GOURMET Stainless Steel Star Parmesan Grater

Product Code	Dimension
02-002-00450	30 x 7.5cm

Star blade creates pillow soft mounds out of hard round cheeses, chocolate, garlic, spices and ginger.



MICROPLANE GOURMET Plastic Slider Attachment for Graters

Product Code	Dimension
02-002-00452	Use to grate small items such as garlic and nutmeg.



Stainless Steel Triangle 3-Sided Grater

Product Code	Dimension
02-002-00466	21 x 15 x 4cm



Stainless Steel Cheese Grater

Product Code	Dimension
02-002-00465	15.5 x 5.7cm



L. TELLIER Stainless Steel Cheese Grater

Product Code	Dimension
02-002-00433(XX)	19.4 x 11 x 11.5cm



MICROPLANE GOURMET Stainless Steel Large Shaver

Product Code	Dimension
02-002-00448	30 x 7.5cm



MICROPLANE PROFESSIONAL Stainless Steel Large Shaver

Product Code	Dimension
02-002-00458	33 x 7.6cm



Cast Aluminium Heavy Duty Ginger Grater

Product Code
02-002-00463



MICROPLANE PREMIUM Stainless Steel Spice Grater

Product Code	Dimension
02-002-00453	12.3 x 1.1cm



MICROPLANE PREMIUM Stainless Steel Zester

Product Code	Dimension	
02-002-00454	30 x 3.3cm	PREMIUM range. Use to zest citrus, grate hard round cheeses and ginger.



ATLANTIC CHEF Lemon Zester

Product Code	
02-002-00431	5 Holes



LACOR Stainless Steel Manual Onion Chopper

Product Code	Dimension	Capacity
02-002-00468	Ø9.5 x H22cm	200ml



WESTMARK Aluminium Coated Garlic Press

Product Code	Dimension
02-002-00471	16 x 5.2 x 3.3cm



MICROPLANE Garlic Cutter

Red	Black
02-002-00470	02-002-00469



WESTMARK KERNEX Aluminium Coated Cherry Stoner

Product Code	Dimension
02-002-00490	14 x 4 x 2.5cm



WESTMARK OLIVUS Aluminium Coated Olive Stoner

Product Code	Dimension
02-002-00491	17 x 5 x 1cm



LACOR Stainless Steel Egg Slicer

Product Code	Dimension
02-002-00496	Ø10cm



LACOR Stainless Steel 2-Way Egg Slicer

Product Code	Dimension
02-002-00497	15 x 10 x 3.7cm



IMPERIA STENDIPASTA Wd Square Pasta Drying Rack

Product Code	Dimension
02-002-00505	27 x 10cm



IMPERIA Raviolamp 24-24 Squares

Product Code	Dimension	
02-002-00498	28.5 x 11cm	Ravioli Classici



IMPERIA Raviolamp 36-36 Squares

Product Code	Dimension	
02-002-00499	32 x 14cm	Ravioli Classici



IMPERIA Raviolamp 12-12 Circles

Product Code	Dimension	
02-002-00500	33.5 x 11.5cm	Ravioli Chef



IMPERIA Raviolamp 10-10 Stars

Product Code	Dimension	
02-002-00501	32 x 14cm	Stelline Little Star



IMPERIA Raviolamp 12-12 Hearts

Product Code	Dimension	
02-002-00502	33.5 x 11.5cm	Cuoricini Little Hearts



IMPERIA Raviolamp 18-18 Triangles

Product Code	Dimension	
02-002-00503	33.5 x 11.5cm	Triangular Tortelli Classici



IMPERIA Raviolamp 6-6 Semi Circles

Product Code	Dimension	
02-002-00504	33.5 x 11.5cm	Sorrisi Giant Smiles



Stainless Steel Citrus Juice Press

Product Code	Dimension
02-002-00485	16 x 11 x 8.5cm



WESTMARK Stainless Steel Lemon Pourer

Product Code	Dimension	Colour
02-002-00487	Ø3.5 x 7.5cm	Clear



WESTMARK LIMONA Aluminium Citrus Fruit Press

Product Code	Dimension
02-002-00483	Ø12 x L23.8cm



Stainless Steel Citrus Juice Press

Product Code	Dimension
02-002-00486	Ø9x L28cm



Stainless Steel Lime / Citrus Squeezer

Product Code	Dimension
02-002-00488	8.35 x 7.3cm



Aluminium Standing Fruit Press

Product Code	Dimension
02-002-00484	31 x 11 x 23cm



Mortar & Pestle

Product Code	Dimension	Colour
02-002-00474	Ø12 x 9.5cm	Marble (White)
02-002-00476	Ø10 x H9cm	Smooth Black w/ Flower
02-002-00477	Ø12 x H10cm	Smooth Black w/ Flower



JAMIE OLIVER Large Pestle & Mortar

Product Code	Dimension
02-002-01112	20cm



Stainless Steel French Fry Scoop

Product Code	Dimension	
02-002-00506	19 x 23cm	With Right Handle
02-002-00507	19 x 23cm	With 2 Handles



TRAEX French Fry Scoop

Product Code	Dimension	
02-002-00508	22.9 x 20.5 x 5cm	For Right-Handers
02-002-00509	22.9 x 20.5 x 5cm	With 2 Handles

Ice Cream Scoop Size Chart (for Stockel items)

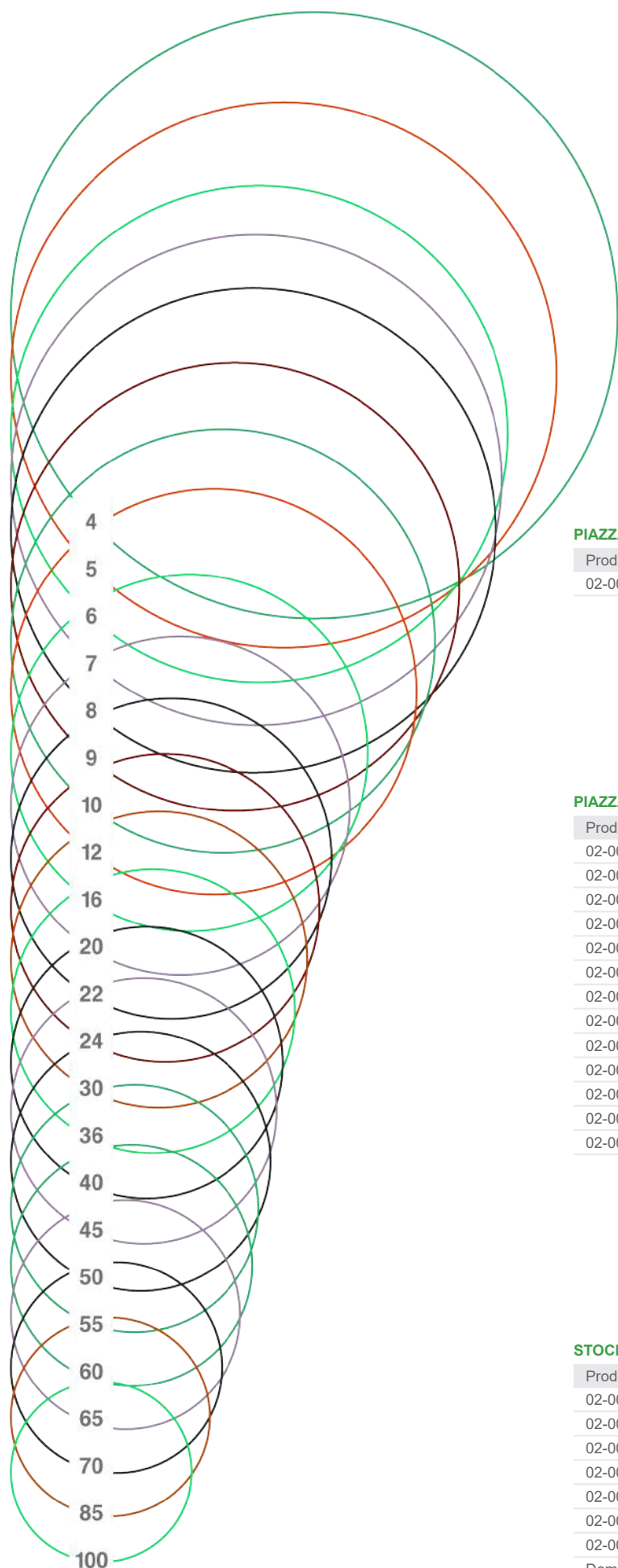

PIAZZA Stainless Steel Oval Ice Cream Scoop

Product Code	Dimension	Capacity
02-002-00537	6 x 4.5cm	1/30ℓ



PIAZZA Stainless Steel Ice Cream Scoop

Product Code	Dimension	Capacity
02-002-00520	Ø3.2cm	1/100ℓ
02-002-00521	Ø3.7cm	1/70ℓ
02-002-00522	Ø4.0cm	1/60ℓ
02-002-00523	Ø4.3cm	1/50ℓ
02-002-00524	Ø4.6cm	1/40ℓ
02-002-00525	Ø4.9cm	1/36ℓ
02-002-00526	Ø5.2cm	1/30ℓ
02-002-00527	Ø5.5cm	1/24ℓ
02-002-00528	Ø6.0cm	1/20ℓ
02-002-00529	Ø6.3cm	1/16ℓ
02-002-00530	Ø6.9cm	1/12ℓ
02-002-00531	Ø7.4cm	1/10ℓ
02-002-00532	Ø7.8cm	1/8ℓ



STOCKEL Stainless Steel Ice Cream Scoop with Colour Plastic Handle

Product Code	Dimension	Capacity	No.
02-002-00577	Ø3.0cm	10ml	100
02-002-00578	Ø3.5cm	14ml	70
02-002-00579	Ø4.3cm	20ml	50
02-002-00580	Ø4.9cm	33ml	30
02-002-00581	Ø5.1cm	42ml	24
02-002-00582	Ø5.6cm	50ml	20
02-002-00583	Ø5.9cm	63ml	16

Domestic. Stainless steel 18/10, Light blue short plastic handle









STOCKEL Stainless Steel Ice Cream Scoop / Portioner

Product Code	Dimension	Capacity	No.
02-002-00563	Ø3.0cm	10mℓ	100
02-002-00564	Ø3.5cm	14mℓ	70
02-002-00565	Ø4.0cm	16mℓ	60
02-002-00566	Ø4.3cm	20mℓ	50
02-002-00567	Ø4.5cm	25mℓ	40
02-002-00568	Ø4.9cm	33mℓ	30
02-002-00569	Ø5.1cm	42mℓ	24
02-002-00570	Ø5.6cm	50mℓ	20
02-002-00571	Ø5.9cm	63mℓ	16
02-002-00572	Ø6.7cm	83mℓ	12
02-002-00573	Ø7.0cm	100mℓ	10
02-002-00574	Ø8.0cm	125mℓ	8
02-002-00575	Ø9.0cm	200mℓ	5

Stainless Steel 18/10. Handle solid brass chrome-plated



ZEROLL Ice Cream Scoop

Product Code	Capacity	Capacity
02-002-00550	1.0oz	 #30 Red
02-002-00551	1.5oz	 #24 Silver
02-002-00552	2.0oz	 #20 Gold
02-002-00553	2.5oz	 #16 Green
02-002-00554	3.0oz	 #12 Blue
02-002-00555	4.0oz	 #10 Brown



SAN JAMAR SAF-T Ice Scoop & Guardian System

Product Code	Dimension	Capacity
02-002-00597	24.8 x 11 x 16.4cm	6-10oz / 177-295mℓ
02-002-00598	24.8 x 12.2 x 17.1cm	12-16oz / 354-473mℓ
02-002-00599	28.3 x 14 x 18.8cm	20-24oz / 591-709mℓ
02-002-00600	35.6 x 18.1 x 20.9cm	64-86oz / 1.8-2.5ℓ



STOCKEL Ice Cream Scoop with Creamic Coated

Product Code	Dimension	Capacity	No.
02-002-00562	Ø4.9 x L12.5cm	33mℓ	30
02-002-00561	Ø5.1 x L12.5cm	42mℓ	24
02-002-00560	Ø5.6 x L12.5cm	50mℓ	20
02-002-00559	Ø5.9 x L12.5cm	63mℓ	16

Heat conductive fluid in handle, blue ceramic non-stick coating



Stainless Steel Ice Cream Spade

Product Code	Dimension
02-002-00558	9" x 8"



ZEROLL Aluminium Tubmate Ice Cream Spade

Product Code	Dimension
02-002-00556	10"



SAN JAMAR Banquet / Beverage SAF-T Scoop

Product Code	Dimension	Capacity
02-002-00601	10 x 7.5 x 4cm	4-6oz / 118-177mℓ
02-002-00602	13.5 x 7.5 x 5cm	6-10oz / 177-295mℓ
02-002-00603	13.5 x 8.5 x 6cm	12-16oz / 354-473mℓ
02-002-00604	17 x 10.7 x 7cm	20-24oz / 591-709mℓ
02-002-00605	23.6 x 15.8 x 8cm	64-86oz / 1.8-2.5ℓ

Accessory: 02-002-00596



SAN JAMAR SAF-T Ice Scoop Caddy

Product Code	Dimension	Colour
02-002-00596	28.7 x 23.1 x 20.4cm	 Blue



TABLECRAFT Aluminium Ice Scoop

Product Code	Dimension	Capacity
02-002-01103	7.25 x 2.75 x 1.75cm	5oz / 147ml
02-002-01100	8.75 x 3.125 x 2.25cm	12oz / 354ml
02-002-01101	10.5 x 4 x 2.5cm	24oz / 709ml
02-002-01102	12 x 4.6 x 3.86cm	38oz / 1.1l
02-002-01104	14.25 x 5.25 x 3.5cm	58oz / 1.7l
02-002-01105	16 x 6.5 x 3.75cm	85oz / 2.5l



Aluminium Ice Scoop, Round Mouth

Product Code	Dimension	Capacity
02-002-00610	12 x 6.1 x 4cm	6oz / 177ml
02-002-00611	13.5 x 8 x 5cm	12oz / 354ml
02-002-00612	18 x 10 x 7cm	24oz / 709ml
02-002-00613	21 x 12 x 9cm	38oz / 1.1l



JIWINS CLEAR Plastic Ice Scoop

Product Code	Dimension	Capacity
02-002-00592	25 x 8 x 7cm	177ml
02-002-00591	28 x 12 x 12cm	946ml
02-002-00590	33 x 15 x 14cm	1.8l



Stainless Steel Flat Base Ice Scoop

Product Code	Dimension	Capacity
02-002-00615	12 x 6.5 x 3.5cm	177ml
02-002-00616	16 x 8.8 x 4cm	345ml
02-002-00617	20.5 x 11.5 x 5.5cm	709ml
02-002-00618	24 x 12 x 8cm	1l



ZEBRA Stainless Steel Measuring Mug

Product Code	Capacity
02-002-00652	800ml



Aluminium Flat Ice Scoop

Product Code	Dimension	Capacity
02-002-00606	L13 x 7 x 4cm (excluding handle) Full Length: 21cm	6oz / 177ml
02-002-00607	L15.5 x 9 x 4.5cm (excluding handle) Full Length: 25cm	12oz / 354ml
02-002-00608	L20 x 11 x 5.5cm (excluding handle) Full Length: 31cm	24oz / 709ml
02-002-00609	L23.5 x 12 x 7cm (excluding handle) Full Length: 35cm	36oz / 1l



LACOR Stainless Steel Ice Scoop

Product Code	Dimension	Capacity
02-002-00593	19 x 5 x 3cm	60ml
02-002-00594	21.5 x 6 x 4cm	110ml
02-002-00595	23.5 x 7.5 x 5cm	200ml



LACOR Stainless Steel Ice Scoop

Product Code	Dimension	Capacity
02-002-00614	24 x 8.5 x 3cm	4oz / 118ml



Stainless Steel All Round Flour Scoop

Product Code	Dimension
02-002-00619	Ø7.1 x L26.7cm
02-002-00620	Ø12 x L36.5cm



Stainless Steel Conical Measuring Jug / Cup

Product Code	Capacity	Colour
02-002-00659	0.25l	Speckled Gray
02-002-00660	1.0l	Speckled Gray
02-002-00661	2.0l	Speckled Gray



AG Stainless Steel 18-8 Measuring Cup

Product Code	Capacity
02-002-01070	0.5ℓ
02-002-01071	1.0ℓ
02-002-01072	3.0ℓ
02-002-01073	5.0ℓ
02-002-01092	2.0ℓ



CAMBRO CLEAR Polycarbonate Measuring Cup

Product Code	Capacity
02-002-00623	225mℓ
02-002-00625	500mℓ
02-002-00621	1.0ℓ
02-002-00622	2.0ℓ
02-002-00624	4.0ℓ



JIWINS CLEAR Polycarbonate Measuring Cup

Product Code	Capacity
02-002-00630	250mℓ
02-002-00631	500mℓ
02-002-00632	1.0ℓ
02-002-00633	2.0ℓ
02-002-00634	3.0ℓ



MARINEX Glass Round Measuring Jug

Product Code	Capacity
02-002-00644	0.25ℓ
02-002-00645	0.5ℓ
02-002-00646	1.0ℓ



CAMBRO CLEAR Polycarbonate Measuring Scoop

Product Code	Capacity
02-002-00629	6oz / 177mℓ
02-002-00626	12oz / 354mℓ
02-002-00627	24oz / 709mℓ
02-002-00628	64oz / 1.8ℓ



A-STAR Plastic Measuring Scoop

Product Code	Capacity
02-002-00640	10oz / 295mℓ
02-002-00641	16oz / 473mℓ
02-002-00642	24oz / 709mℓ



Plastic Measuring Cup (Microwave-Safe)

Product Code	Capacity
02-002-00653	0.5ℓ
02-002-00654	1.0ℓ
02-002-00655	2.0ℓ
02-002-00656	3.0ℓ
02-002-00657	5.0ℓ



SCHNEIDER Plastic Measuring Jug

Product Code	Capacity	Matching Lid
02-002-00647	1.0ℓ	02-002-00649
02-002-00648	2.0ℓ	02-002-00650



Stainless Steel Measuring Spoon (5pcs)

Product Code	Capacity
02-002-00662	1/8 tsp (0.6ml), 1/4 tsp (1.2ml), 1/2 tsp (2.5ml), 1 tsp (5ml), 1 tbsp (15ml)



Plastic Measuring Spoon (5pcs)

Product Code	Capacity
02-002-00663	1ml, 5ml, 15ml, 50ml, 100ml



Plastic Measuring Cup and Spoon Set (11pcs)

Product Code	Capacity
02-002-00664	1/8 tsp (0.6ml), 1/4 tsp (1.2ml), 1/2 tsp (2.5ml), 1 tsp (5ml), 1/2 tbsp (7.5ml), 1 tbsp (15ml), 1/8 cup (31ml), 1/4 cup (62ml), 1/3 cup (83ml), 1/2 cup (125ml), 1 cup (250ml)



CARLISLE Measuring Spoon with Short Handle

Product Code	Capacity	Colour
02-002-00993	1oz / 29ml	Yellow
02-002-00992	1.5oz / 44ml	Brown
02-002-00995	2oz / 59ml	Red
02-002-00994	2.5oz / 74ml	Orange
02-002-00996	3oz / 88ml	White
02-002-00997	4oz / 118ml	Green
02-002-00998	6oz / 177ml	Black
02-002-00999	8oz / 236ml	Blue



CARLISLE Measuring Perforated Spoon with Short Handle

Product Code	Capacity	Colour
02-002-01000	2oz / 59ml	Red
02-002-01001	4oz / 118ml	Green



Stainless Steel Measuring Spoon (4pcs)

Product Code	Capacity
02-002-00658	59ml, 79ml, 118ml, 237ml



LACOR Stainless Steel Footed Measuring Cup

Product Code	Capacity
02-002-00643	1.0l



WESTMARK Plastic Mixing Jug with Lid & Scale

Product Code	Dimension	Capacity
02-002-00651	Ø15 x H20cm	1.4l



CCK Stainless Steel Sausage Funnel

Product Code	Dimension
02-002-00679	Ø4.5 x H8.75cm



LACOR Stainless Steel Funnel

Product Code	Dimension
02-002-00672	Ø12cm
02-002-00673	Ø16cm
02-002-00674	Ø20cm
02-002-00675	Ø24cm



LACOR Stainless Steel Funnel with Removable Filter

Product Code	Dimension
02-002-00678	Ø10cm
02-002-00676	Ø12cm
02-002-00677	Ø14cm



SCHNEIDER Plastic Funnel

Product Code	Dimension
02-002-00665	Ø5cm
02-002-00666	Ø6cm
02-002-00667	Ø8cm
02-002-00668	Ø10cm
02-002-00669	Ø12cm
02-002-00670	Ø14cm
02-002-00671	Ø16.4cm



WESTMARK Stainless Steel Preserve Funnel

Product Code	Dimension
02-002-00687	Ø13cm



Plastic Funnel

Product Code	Dimension
02-002-00682	Ø8cm
02-002-00683	Ø10cm
02-002-00684	Ø12.5cm
02-002-00685	Ø15cm



LACOR Stainless Steel Nut / Lobster Cracker

Product Code	Dimension
02-002-00713	17cm



Aluminium Lobster Cracker

Product Code	Dimension
02-002-00716	15cm



Stainless Steel Nut / Crab Cracker with Pick

Product Code	Dimension
02-002-00715	Cracker: 16cm / Pick: 19.7cm



LACOR Stainless Steel Lobster Cracker / Plier

Product Code	Dimension
02-002-00712	18.5cm



EDLUND Stainless Steel Manual Can Opener (SG-2 Series)

NSF Certified and Dishwasher safe. Opens: 4 to 6 cans/minute
Recommended Daily Use: Up to 15 cans per day.

Product Code	Model	Bar Length	Add. Info.
02-002-00727	13100	16"	With standard bar & stainless steel base. For up to 11" tall cans with stainless steel base
02-002-00728	13300	22"	With long bar & stainless steel base. For up to 17" tall cans with stainless steel base



EDLUND Stainless Steel Manual Can Opener (#2 Series)

Opens: 4 cans/minute Recommended Daily Use: Up to 15 cans per day.

Product Code	Model	Bar Length	Add. Info.
02-002-00726	12100	7"	Table Style Can Opener with new plated steel base (for cans up to 7" tall) "Old Reliable"



EDLUND Stainless Steel Manual Can Opener (S-11 Series)

NSF Certified and Dishwasher safe. Opens: 4 to 6 cans/minute
Recommended Daily Use: Up to 50 cans per day.

Product Code	Model	Bar Length	Add. Info.
02-002-00732	15000	23"	For up to 11" tall cans with cast stainless steel base
02-002-00733	15320	16"	For up to 17" tall cans with stainless steel clamp base and long bar
02-002-00734	15420	75"	For up to 11" tall cans with stainless steel clamp base and long bar. Complete with spare knife, gear and cleaning tool
02-002-00741(XX)	15020	23"	For up to 11" tall cans with stainless steel clamp base. Available with clamp instead of screws/ secures the underside of the table)



EDLUND Stainless Steel Manual Can Opener (#1 Series)

NSF Certified and Dishwasher safe. Opens: 4 to 6 cans/minute
Recommended Daily Use: Up to 50 cans per day.

Product Code	Model	Bar Length	Add. Info.
02-002-00724	11000	19.5"	Can Opener with new plated steel base (for cans up to 11" tall) "Old Reliable"
02-002-00725	11300	19.5"	With new stainless steel base.



EDLUND Stainless Steel Manual Can Opener (G-2 Series)

NSF Certified. Opens: 4 cans/minute Recommended Daily Use: Up to 15 cans per day.

Product Code	Model	Bar Length	Add. Info.
02-002-00736	16700	29.5"	For up to 17" tall cans with cast stainless steel base
02-002-00735	16200	22.5"	For up to 17" tall cans with stainless steel base
02-002-00742(XX)	16100	23"	For up to 17" tall cans with plated steel base
02-002-00743(XX)	16500	29.5"	For up to 17" tall cans with plated steel base



EDLUND Stainless Steel Manual Can Opener (#U-12 Series)

NSF Certified. Opens: 4 to 6 cans/minute Recommended Daily Use: Up to 50 cans per day.

Product Code	Model	Bar Length	Add. Info.
02-002-00729	14100	23"	For up to 11" tall cans with plated steel base
02-002-00730	14200	23"	For up to 11" tall cans with stainless steel base
02-002-00731	14600	29.5"	For up to 17" tall cans with stainless steel base
02-002-00739	14010	22"	For up to 11" tall cans with stainless steel clamp base
02-002-00740(XX)	14500	29.5"	For up to 17" tall cans with plated steel base



EDLUND CROWN PUNCH Manual Crown Punch Can Opener

Product Code	Model	Dimension	Add. Info.
02-002-00737(XX)	70100	20 x 14 x 20cm	Suitable for cans up to Ø6.5xH10.5". Recommended for up to 200 cans per day. Standard 10" blade. Check with our sales consultants for blade options for different can sizes.



EDLUND Accessories Clamp Base for S-11 / U-12 / G-2

Product Code	For
02-002-00744	For S-11 / U-12 / G-2 series



02-002-00745



02-002-00746



02-002-00747



02-002-00748



02-002-00749



02-002-00750

EDLUND Replacement Parts Knife and Gear

Product Code	For
02-002-00745	02-002-00724
02-002-00746	02-002-00726
02-002-00747	02-002-00735 / 742(XX) / 743(XX)
02-002-00748	02-002-00730 / 731 / 741(XX) / 739

*Other additional replacement parts may be available upon request



BONZER Spare Wheel Kit for Can Opener

Product Code	Dimension
02-002-00723	2.5cm
02-002-00721	4cm



BONZER Spare Blade for Bonzer Can Openers

Product Code	Dimension	Capacity
02-002-00722	Ø20 x 30 x 38cm	3.3t



UENO Can Opener

Product Code	Dimension
02-002-00753	7.3cm



BONZER Table Mount Can Opener with Stainless Steel Stem & Base

Product Code	Dimension	For up to
02-002-00718	28" x 5" x 4"	14" cans



BONZER Can Opener with Yellow Collar

Product Code	Dimension	For up to
02-002-00719	30" x 5" x 4"	16" cans. EZ20



BONZER Can Opener with Green Collar

Product Code	Dimension	For up to
02-002-00720	38" x 5" x 4"	25" cans. EZ40



SUNNEX Stainless Steel Can Opener

Product Code	Dimension
02-002-00751	17cm



Can Opener

Product Code
02-002-00766



CULINARE Lift Off Can Opener

Product Code	Dimension
02-002-00759	15.5cm



ZYLISS 5-Way Opener

Product Code	Colour
02-002-00754	Green



Aluminium Meat Tenderizer

Product Code	Type
02-002-00767	2-Face



Aluminium Square Meat Tenderizer

Product Code	Dimension
02-002-00768	60 x 5 x 5cm



FISCHER Butcher String

Product Code	Dimension	Capacity
02-002-00770	Ø10.5 x L14.5cm	1kg/2500mtr



Cooking String Roll in Blister Card with Cutter

Product Code	Dimension
02-002-00773	60m



FISCHER Stainless Steel Larding Needles with Plastic Handle

Product Code	Dimension
02-002-00777	25cm



FISCHER Stainless Steel Standaround String Holder

Product Code	Dimension
02-002-00771	17.5 x 14 x 21.5cm



FISCHER Stainless Steel String Holder on Stand

Product Code	Dimension
02-002-00772	19 x 12 x 16cm



FISCHER Stainless Steel Curved Trussing Needles

Product Code	Dimension
02-002-00774(XX)	Ø0.3 x L15cm
02-002-00775	Ø0.3 x L20cm
02-002-00776(XX)	Ø0.3 x L25cm



FISCHER Stainless Steel Straight Trussing Needles

Product Code	Dimension
02-002-00778(XX)	Ø0.3 x L15cm
02-002-00779(XX)	Ø0.3 x L25cm



CCK Stainless Steel Chicken Hanging Hook

Product Code	Type
02-002-00780	3-Star
02-002-00781	4-Star



CCK Stainless Steel S-Hook

Product Code	Length	Thickness
02-002-00791	4"	Thick
02-002-00792	5"	Thick
02-002-00793	6"	Thick
02-002-00794	7"	Thick
02-002-00795	8"	Thick
02-002-00796	9"	Thick
02-002-00797	12"	Thick
02-002-00798	4"	Thin
02-002-00799	5"	Thin
02-002-00800	6"	Thin
02-002-00801	7"	Thin
02-002-00802	8"	Thin
02-002-00803	9"	Thin



CCK Stainless Steel Chicken Hook

Product Code	Length	
02-002-00804	4"	Straight
02-002-00805	5"	Straight
02-002-00806	6"	Straight
02-002-00807	7"	Straight



CCK S'PORE STYLE Stainless Steel BBQ Charsiew Skewer (1.5mm Thick)

Product Code	Dimension
02-002-00814	8"
02-002-00815	10"
02-002-00817	12"
02-002-00819	14"
02-002-00821	16"
02-002-00823	18"
02-002-00825	20"



CCK Stainless Steel Chicken Hook with Wooden Handle

Product Code	Length
02-002-00782	14"
02-002-00783	16"
02-002-00784	18"
02-002-00785	20"
02-002-00786	22"
02-002-00787	24"
02-002-00788	30"
02-002-00789	42"



CCK STOVE Stainless Steel BBQ Hand Hook Long Handle

Product Code	Dimension
02-002-00808(XX)	143cm



CCK Stainless Steel 'J' Hook

Product Code	Dimension
02-002-00809	17cm



CCK HK Stainless Steel BBQ Charsiew Skewer

Product Code	Dimension
02-002-00810	14"
02-002-00811	16"
02-002-00812	18"
02-002-00813	20"



CCK S'PORE STYLE Stainless Steel BBQ Charsiew Skewer (1mm Thin)

Product Code	Dimension
02-002-00816	10"
02-002-00818	12"
02-002-00820	14"
02-002-00822	16"
02-002-00824	18"
02-002-00826	20"



CCK Stainless Steel BBQ Needle with Ring Handle

Product Code	Dimension
02-002-00832	24"



CCK Gold-Coin Chicken Needle / Skewer

Product Code	Dimension
02-002-00833	



CCK Stainless Steel Roast Pigeon Skewer 3-Prong

Product Code	Dimension
02-002-00851	16.5"



CCK S'PORE STYLE Roast Piglet Skewer 3-Prong

Product Code	Dimension
02-002-00834	22"
02-002-00835	26"



CCK Roast Piglet Skewer 2-Prong

Product Code	Dimension
02-002-00836	22"
02-002-00838	26"



CCK Stainless Steel Roast Piglet Skewer 2-Prong

Product Code	Dimension
02-002-00837	24"



CCK HANGING TYPE Stainless Steel Roast Piglet Skewer

Product Code	Dimension
02-002-00840	22"
02-002-00841	24"



CCK Stainless Steel Pig Fork

Product Code	Dimension
02-002-00842	22"
02-002-00843	24"
02-002-00844	26"



CCK Stainless Steel Attachable Handle for Pig Fork

Product Code	Dimension
02-002-00845	31.5"



CCK Accessory Wooden Handle for Roast Piglet Skewer

Product Code	Dimension
02-002-00839	



CCK Round Roast Pork Spike / Docket with Wooden Handle

Product Code	Dimension
02-002-00864	16cm



CCK Stainless Steel Rectangle Roast Pork Spike / Docket Heavy Duty

Product Code	Dimension
02-002-00865	16cm



CCK HK *Stainless Steel Char Siew Hanger Inverted Y*

Product Code	Dimension
02-002-00827	16"



CCK *Stainless Steel BBQ Chicken, Char Siew Meat Ring with 2 Hooks*

Product Code	Dimension
02-002-00846	12"



CCK *Stainless Steel Roast Piglet Ring with 2 Hooks*

Product Code	Dimension
02-002-00848	13"



CCK *Stainless Steel Roast Duck Tail Needle*

Product Code	Dimension
02-002-00981	6"



Aluminium Order Rack (Tab Grabber)

Product Code	Dimension
02-002-00963	18"
02-002-00964	24"
02-002-00965	36"
02-002-00966	48"



Stainless Steel Food Sign

Product Code	Dimension	
02-002-00967	11 x 11cm	"Uncooked"
02-002-00968	11 x 11cm	"Cooked"



CCK S'PORE STYLE *Stainless Steel Char Siew 'T' Hanger*

Product Code	Dimension
02-002-00828	14"
02-002-00829	16"
02-002-00830	18"
02-002-00831	20"



CCK *Stainless Steel Roast Duck Ring with 2 Hooks*

Product Code	Dimension
02-002-00980	12"



CCK *Stainless Steel BBQ Meat Ring with 2 Short Hooks*

Product Code	Dimension
02-002-00849	7"



CCK BBQ Aluminium Rod with 2 Short Rods

Product Code	Dimension
02-002-00867	Long 18" / Short 6.5"
02-002-00866	Long 18" / Short 7"



SAN JAMAR *Anodized Aluminium Slide Rack (Tab Grabber)*

Product Code	Dimension
02-002-00956	12"
02-002-00957	18"
02-002-00958	24"
02-002-00959	36"
02-002-00960	44"



TOKAI Plastic BBQ Mini Refillable Gas Torch

Product Code
02-002-00868



TOKAI Plastic BBQ Gas Lighter

Product Code
02-002-00869



Spark-L Gas Igniter

Product Code	Dimension
02-002-00871	21"



Battery Operated Ignition Gun

Product Code	Dimension
02-002-00874	23"
02-002-00875	13.5"



Stainless Steel One-Pc Soup Ladle

Product Code	Dimension
02-003-00062	Ø7cm
02-003-00063	Ø8cm
02-003-00064	Ø9cm



Stainless Steel Frying One-Pc Ladle with Long Handle, Economy

Product Code	Dimension
02-003-00047	50cm
02-003-00048	60cm
02-003-00049	80cm



Stainless Steel Frying Ladle

Product Code	Dimension	Capacity
02-003-00038	Size 1	12 Tahils
02-003-00039	Size 2	10 Tahils
02-003-00040	Size 3	8 Tahils
02-003-00041	Size 4	6 Tahils
02-003-00042	Size 5	4 Tahils



Stainless Steel Frying Ladle

Product Code	Dimension	Capacity
02-003-00864	Size 1	12 Tahils
02-003-00865	Size 2	10 Tahils
02-003-00866	Size 3	8 Tahils



ALEGACY Stainless Steel One-Pc Perforated Food Portioner

Product Code	Capacity	Colour
02-002-00510	2oz	Red
02-002-00511	3oz	Beige
02-002-00512	4oz	Green
02-002-00513	6oz	Black
02-002-00514	8oz	Blue



ALEGACY Stainless Steel One-Pc Solid Food Portioner

Product Code	Capacity	Colour
02-002-00515	2oz	Red
02-002-00516	3oz	Beige
02-002-00517	4oz	Green
02-002-00518	6oz	Black
02-002-00519	8oz	Blue

**STEELCRAFT Stainless Steel One-Pc Ladle**

Product Code	Dimension	Capacity
02-003-00230	Ø6.5 x L33.5cm	0.07ℓ
02-003-00231	Ø8 x L33.5cm	0.13ℓ
02-003-00232	Ø9 x L43cm	0.2ℓ
02-003-00233	Ø10 x L47cm	0.25ℓ
02-003-00234	Ø12 x L49cm	0.5ℓ
02-003-00235	Ø14 x L55cm	0.75ℓ
02-003-00236	Ø16 x L56.5cm	1.0ℓ
02-003-00237	Ø20 x L5	2.0ℓ
02-003-00239	Ø5 x L30cm	0.5oz
02-003-00240	Ø5.5 x L31cm	1oz
02-003-00241	Ø7 x L31cm	2oz
02-003-00242	Ø8 x L36.5cm	3oz
02-003-00243	Ø8.3 x L37cm	4oz
02-003-00244	Ø9.7 x L38cm	6oz
02-003-00245	Ø10.5 x L38cm	8oz
02-003-00246	Ø12.3 x L38.5cm	12oz
02-003-00247	Ø13 x L340cm	16oz
02-003-00248	Ø11 x L44.5cm	0.34ℓ
02-003-00249	Ø18 x L55.5cm	1.5ℓ

**AG Stainless Steel 18-8 Horizontal Gravy Ladle**

Product Code	Capacity
02-003-00841	30cc
02-003-00842	70cc

**AG Stainless Steel 18-8 Horizontal Perforated Ladle**

Product Code	Capacity
02-003-00843	70cc

**Stainless Steel Short Ladle**

Product Code	Dimension	Capacity
02-003-00250	Ø5.5 x L16.5cm	1oz
02-003-00251	Ø6 x L17cm	1.5oz
02-003-00252	Ø7 x L19cm	2oz

**ALEGACY 18-8 Stainless Steel One-Pc Ladle**

Product Code	Dimension	Capacity
02-003-00204	9" Handle	0.5oz
02-003-00205	9.25" Handle	1oz
02-003-00206	9.25" Handle	2oz
02-003-00207	10" Handle	3oz
02-003-00208	13" Handle	4oz
02-003-00209	13" Handle	6oz
02-003-00210	13.5" Handle	8oz
02-003-00211	15" Handle	12oz

**AG Stainless Steel 18-8 Ladle**

Product Code	Capacity
02-003-00830	10cc
02-003-00831	20cc
02-003-00832	36cc
02-003-00833	90cc
02-003-00834	144cc
02-003-00835	180cc
02-003-00836	270cc
02-003-00837	360cc
02-003-00838	540cc
02-003-00839	1000cc
02-003-00840	1800cc

**LACOR Stainless Steel Perforated Ladle**

Product Code	Dimension	Capacity
02-003-00227	Ø8 x L30cm	0.12ℓ
02-003-00228	Ø10 x L38cm	0.25ℓ
02-003-00229	Ø12 x L38cm	0.5ℓ

**Stainless Steel Ladle with Round Handle**

Product Code	Dimension
02-003-00253	37cm



ZEBRA Stainless Steel Ladle with Bakelite Handle

Product Code	Dimension
02-003-00643	35 x 7cm



ZEBRA Stainless Steel Slotted Ladle with Bakelite Handle

Product Code	Dimension
02-003-00645	35 x 7.2cm



EPICUREAN GOURMET Nylon Ladle with Wood Fibre Handle with Measurement

Product Code	Dimension	Capacity
02-003-00216	32.5 x 8.4cm	1/8, 1/4, 1/2 cup
Heat resistant up to 204°C		



Non-Stick Rice Scoop

Product Code	Dimension
02-003-00752	7.5"



Stainless Steel Rice Ladle with Round Handle

Product Code	Dimension
02-003-00754	26cm



Stainless Steel Rice Scoop

Product Code	Dimension	Material
02-003-00755	L-Size	Wooden Handle



Stainless Steel Rice Scoop Ladle

Product Code	Capacity
02-003-00756	6 Tahils



Worldcraft Teflon Rice Scoop

Product Code
02-003-00751



Wooden Rice Scoop / Paddle

Product Code	Dimension
02-003-00762	50.2cm



Wooden Rice Scoop

Product Code	Dimension
02-003-00759	22.5cm
02-003-00760	23cm
02-003-00761	27cm



Stainless Steel Frying Turner with Long Handle, ET

Product Code	Dimension
02-003-00065	45 x 16cm
02-003-00066	60 x 16cm
02-003-00067	80 x 16cm



Stainless Steel Slotted Frying Turner with Long Handle, ET

Product Code	Dimension
02-003-00070	12 x 55cm
02-003-00071	16 x 78cm



Stainless Steel Frying One-Pc Turner with Long Handle, Economy

Product Code	Dimension
02-003-00043	50cm
02-003-00044	60cm
02-003-00045	80cm
02-003-00046	120cm



CCK Stainless Steel Frying Turner

Product Code	Dimension	Capacity
02-003-00008	45.5 x 12.2cm	0.2ℓ
02-003-00009	48.5 x 12.2cm	0.25ℓ



Stainless Steel Frying Ladle, Standard

Product Code	Dimension	Size
02-003-00050	54 x 12cm	Size 1
02-003-00051	45 x 11cm	Size 2
02-003-00052	44 x 10cm	Size 3



Stainless Steel Frying Turner

Product Code	Dimension
02-003-00867	43cm Size 2
02-003-00868	40cm Size 3



Stainless Steel Frying Ladle, Economy

Product Code	Dimension	Size
02-003-00053	49.5 x 13.5cm	Size 1
02-003-00054	47 x 12.7cm	Size 2
02-003-00055	45 x 11.8cm	Size 3
02-003-00056	44 x 11cm	Size 4
02-003-00057	41 x 10.4cm	Size 5



CCK Stainless Steel Turner with Long Handle

Product Code	Dimension
02-003-00010	36" x 6"
02-003-00011	48" x 6"
02-003-00012	60" x 6"



ATLANTIC CHEF Spatula

Product Code	Dimension
02-003-00073	9cm



ATLANTIC CHEF Serrated Spatula

Product Code	Dimension
02-003-00074	9cm



ATLANTIC CHEF Mini Square Spatula with Plastic Handle

Product Code	Dimension
02-003-00075	6.3 x 6.3cm



ATLANTIC CHEF Turner

Product Code	Dimension
02-003-00794	19 x 7.6cm
02-003-00793	20 x 10cm

ATLANTIC CHEF Heavy Duty Stainless Steel Turner

Product Code	Dimension
02-003-00097	15.2 x 12.7cm
02-003-00096	12.7 x 10.2cm

ATLANTIC CHEF Teppanyaki Turner

Product Code	Dimension
02-003-00095	10 x 12cm

ATLANTIC CHEF Large Fish Turner

Product Code	Dimension
02-003-00098	22.5 x 9.5cm

ATLANTIC CHEF Slotted Fish Turner

Product Code	Dimension
02-003-00082	16 x 7.2cm

ATLANTIC CHEF Pie Turner

Product Code	Dimension
02-003-00076	12.7 x 5cm
02-003-00077	12.7 x 7.6cm

ATLANTIC CHEF Perforated Offset Turner / Spatula

Product Code	Dimension
02-003-00081	20 x 7.6cm

ATLANTIC CHEF Offset Turner / Spatula

Product Code	Dimension
02-003-00083	10 x 6.3cm
02-003-00078	12.7 x 7.6cm
02-003-00079	15 x 7.6cm
02-003-00080	20 x 7.6cm

ATLANTIC CHEF Baker's Spatula

Product Code	Dimension
02-003-00084	15cm
02-003-00085	20cm
02-003-00086	25cm
02-003-00087	30cm

ATLANTIC CHEF Offset Baker's Spatula

Product Code	Dimension
02-003-00091	11.5cm
02-003-00092	15cm
02-003-00088	20cm
02-003-00089	25cm
02-003-00090	30cm

GIESSER Confectoiner's Spatula Straight Plastic Handle

Product Code	Dimension
02-003-00108	10cm
02-003-00117	31cm



GIESSER Angular Broad Spatula with Plastic Handle

Product Code	Dimension	Colour
02-003-00119	16.5 x 11.5cm	Black
02-003-00120	16 x 11cm	Black



GIESSER Spatula Angular Resilient Plastic Handle

Product Code	Dimension	Handle Colour
02-003-00121	16 x 10cm	Black
02-003-00122	21 x 15cm	Black
02-003-00123	26 x 20cm	Black
02-003-00124	26 x 20cm	White
02-003-00125	31 x 25cm	Black



ZEBRA Stainless Steel Turner with Bakelite Handle

Product Code	Dimension
02-003-00031	M
02-003-00032	L



Stainless Steel Perforated Turner

Product Code	Dimension
02-003-00190	46cm



LACOR Stainless Steel One-Pc Fish Turner

Product Code	Dimension
02-003-00141	20.5 x 8cm



GIESSER Spatula Blunt Resilient Plastic Handle

Product Code	Dimension	Handle Colour
02-003-00109	16cm	Black
02-003-00110	16cm	White
02-003-00111	21cm	Black
02-003-00112	21cm	Blue
02-003-00113	21cm	Green
02-003-00114	21cm	Red
02-003-00115	21cm	White
02-003-00116	26cm	Black
02-003-00118	36cm	Black



ZEBRA Nylon Turner with Bakelite Handle

Product Code	Dimension	Type
02-003-00024	38 x 9.8cm	Slotted
02-003-00025	38 x 9.8cm	



Stainless Steel Turner

Product Code	Dimension
02-003-00189	46cm



SAFICO 18/8 Stainless Steel Slotted Turner with Hollow Handle

Product Code	Dimension
02-003-00145	34.5cm



Steak Turner, Small with Black Handle

Product Code	Dimension	Handle
02-003-00177	16 x 7.6cm	12.5cm



Perforated Hamburger Turner with Black Handle

Product Code	Dimension	Handle
02-003-00178	24 x 7.6cm	13cm



Hamburger Turner with Black Handle

Product Code	Dimension	Handle
02-003-00179	24 x 7.6cm	13cm



EPIPUREAN GOURMET Turner with Wooden Fibre Handle (Heat resistant up to 260°C)

Product Code	Dimension
02-003-00103	32.5 x 7.8cm



EPIPUREAN Wooden Fibre Slotted Saute Turner (Heat resistant up to 260°C)

Product Code	Dimension	Handle
02-003-00104	30 x 6.9cm	Natural
02-003-00105	30 x 6.9cm	Slate



EPIPUREAN Wooden Fibre Angled Turner (Heat resistant up to 176°C)

Product Code	Dimension	Handle
02-003-00106	30 x 5.3cm	Natural
02-003-00107	30 x 5.3cm	Slate



MYE Wooden Curved Turner (Acacia-Oiled)

Product Code	Dimension
02-003-00144	30 x 9cm



Bamboo Pan Turner

Product Code	Dimension
02-003-00195	12" Rounded Edge Turner



TABLECRAFT Plastic Spatula with Rubber Blade

Product Code	Dimension
02-003-00149	10" / 25.4cm
02-003-00150	14" / 35.5cm
02-003-00151	16" / 40.6cm



Silicon Spatula with Wooden Handle

Product Code	Dimension
02-003-00174	9.5 x 30.5cm
02-003-00072	12 x 33.5cm



CARLISLE Plastic Nylon Paddle Scraper with Nylon Handle

Product Code	Dimension	Colour
02-003-00102(XX)	40" / 101cm	<input type="checkbox"/> White



L' TELLIER Beechwood Crepe Spatula

Product Code	Dimension
02-003-00132	40cm

TABLECRAFT Plastic Icing Spatula with Rubber Blade

Product Code	Dimension
02-003-00158	9.5" / 24.1cm



TABLECRAFT High Heat Spatula

Product Code	Dimension	
02-003-00152	10 $\frac{1}{2}$ " / 26cm	Resistant to 260°C
02-003-00153	14" / 35.5cm	Resistant to 260°C
02-003-00154	16 $\frac{1}{2}$ " / 41.1cm	Resistant to 260°C



MATFER Pelton Spatula (6pcs/pkt)

Product Code	Dimension	
02-003-00143	30cm	Withstands up to 220°C



TABLECRAFT High Heat Spoon-Shaped Spatula

Product Code	Dimension	
02-003-00155	10 $\frac{1}{2}$ " / 26cm	Resistant to 260°C
02-003-00156	14" / 35.5cm	Resistant to 260°C
02-003-00157	16 $\frac{1}{2}$ " / 41.1cm	Resistant to 260°C



Stainless Steel Stirring Spatula

Product Code	Dimension
02-003-00180	24" / 64 x 12cm
02-003-00181	30" / 75.6 x 12cm
02-003-00182	36" / 90.5 x 12cm
02-003-00183	42" / 100.7 x 12cm
02-003-00184	48" / 124 x 12cm
02-003-00185	54" / 135.6 x 12cm
02-003-00186	60" / 150 x 12cm



Stainless Steel Heavy Solid Spatula

Product Code	Dimension
02-003-00191	52cm



L'TELLIER Beechwood Spatula

Product Code	Dimension
02-003-00133	25cm
02-003-00134	30cm
02-003-00135	35cm
02-003-00136	40cm
02-003-00137	50cm
02-003-00138	60cm



Dim Sum Bamboo Spatula (Haom-Tiew)

Product Code	Dimension
02-003-00175	21cm



MATFER Beechwood Spatula

Product Code	Dimension
02-003-00140(XX)	80cm
02-003-00139	100cm



Stainless Steel Heavy Perforated Spatula

Product Code	Dimension
02-003-00192	52cm



Stainless Steel Perforated Stirring Spatula

Product Code	Dimension
02-003-00187	42" / 100.7 x 12cm



LACOR Silicon Spatula with Thermometer Probe

Product Code	Dimension	Range
02-003-00020	29cm	-50°C to 300°C



Stainless Steel Slotted Spatula with Round Handle

Product Code	Dimension
02-003-00194	37cm



Stainless Steel Scraper with Black Handle

Product Code	Dimension
02-003-00176	25 x 10cm



L'TELLIER Beechwood Round Crepe Spreader

Product Code	Dimension
02-003-00130	18cm



L'TELLIER Beechwood Crepe Spreader

Product Code	Dimension
02-003-00131	24cm



Aluminium Pizza Peel with Wooden Handle

Product Code	Dimension
02-003-00163	30cm with Handle 50cm
02-003-00164	35cm with Handle 50cm



CARLISLE Plastic Nylon Paddle Scraper

Product Code	Dimension
02-003-00100(XX)	48"
02-003-00099(XX)	72"



SAN JAMAR Rapi-Kool Cold Paddles

Product Code	Capacity
02-003-00147	64oz
02-003-00146	128oz



Aluminium Pizza Shovel with Stainless Steel Pipe Handle

Product Code	Dimension
02-003-00165	Ø32 x L100cm



Stainless Steel One-Pc Perforated Basting Spoon

Product Code	Dimension
02-003-00188	46cm



Wooden Paddle

Product Code	Dimension
02-003-00203	18"
02-003-00198	24"
02-003-00199	30"
02-003-00200	36"
02-003-00201	48"
02-003-00202	60"



CCK Stainless Steel Wok Stand

Product Code	Dimension
02-003-00017	Ø11.4" 2 Ring



Bamboo Wok Brush

Product Code	Dimension
02-003-00059	Ø3" x 11.5" - Ø4.5 x 29cm



CCK Wooden Wok Hammer

Product Code	Dimension
02-003-00018	32cm



SPARTA Potato Brush with Medium Firm Polyester Bristle

Product Code	Dimension	Colour
02-002-00494	6cm	<input type="checkbox"/> White



CCK HK Bamboo Wok Brush Heavy Duty

Product Code	Dimension
02-003-00016	10.5"



Stainless Steel Chinese Strainer with Stainless Steel Handle

Product Code	Capacity
02-003-00294	10.5"
02-003-00295	12"



Stainless Steel Chinese Strainer with Coarse Wire Net & Bamboo Handle

Product Code	Dimension
02-003-00306	Ø5"
02-003-00307	Ø6"
02-003-00308	Ø7"
02-003-00309	Ø8"
02-003-00310	Ø9"
02-003-00311	Ø10"
02-003-00312	Ø11"
02-003-00313	Ø12"



Stainless Steel Chinese Strainer with Bamboo Handle

Product Code	Dimension
02-003-00314	Ø6"
02-003-00315	Ø7"
02-003-00316	Ø8"
02-003-00317	Ø9"
02-003-00318	Ø10"
02-003-00319	Ø11"
02-003-00320	Ø12"



CCK Stainless Steel Chinese Strainer with Stainless Steel Handle

Product Code	Dimension
02-003-00355	Ø7"
02-003-00356	Ø8"
02-003-00357	Ø9"
02-003-00358	Ø10"



CCK Stainless Steel Chinese Strainer with Bamboo Handle

Product Code	Dimension
02-003-00337	Ø7"
02-003-00338	Ø8"
02-003-00339	Ø9"
02-003-00340	Ø10"
02-003-00341	Ø11"
02-003-00342	Ø12"



LACOR 18-10 Stainless Steel Meshed Chinese Strainer / Chinois

Product Code	Dimension
02-003-00381	Ø20cm
02-003-00382	Ø22cm
02-003-00383	Ø24cm



LACOR 18-10 Stainless Steel Chinese Strainer / Chinois

Product Code	Dimension
02-003-00374	Ø14cm
02-003-00375	Ø16cm
02-003-00376	Ø18cm
02-003-00377	Ø20cm
02-003-00378	Ø22cm
02-003-00379	Ø24cm
02-003-00380	Ø26cm



CCK Steel Iron Chinese Strainer (Fine)

Product Code	Dimension
02-003-00346	Ø10"
02-003-00347	Ø11"
02-003-00348	Ø12"



Steel Iron Chinese Strainer with Coarse Wire Net

Product Code	Dimension
02-003-00301	Ø10"
02-003-00302	Ø11"
02-003-00303	Ø12"
02-003-00304	Ø13"
02-003-00305	Ø14"



DE BUYER Stainless Steel Strainer

Product Code	Dimension
02-003-00366(XX)	Ø10cm
02-003-00367(XX)	Ø16cm
02-003-00368(XX)	Ø18cm



LACOR 18-10 Stainless Steel Strainer

Product Code	Dimension	Capacity
02-003-00369	Ø20cm x H12cm	3.6ℓ
02-003-00370	Ø24cm x H14cm	6.5ℓ
02-003-00371	Ø28cm x H15cm	9.3ℓ



LACOR Stainless Steel Mesh Conical Strainer

Product Code	Dimension
02-003-00390	Ø8cm
02-003-00391	Ø10cm
02-003-00392	Ø12cm
02-003-00393	Ø14cm
02-003-00394	Ø16cm
02-003-00395	Ø18cm



Stainless Steel Strainer Fine Mesh with Stainless Steel Handle

Product Code	Dimension
02-003-00296	10.5"
02-003-00297	12"



CCK Stainless Steel X'tra Long Handle Fine Mesh Strainer

Product Code	Dimension
02-003-00359	Ø14"
02-003-00360(XX)	Ø16"



LACOR Stainless Steel Mesh Bowl Strainer

Product Code	Dimension
02-003-00396	Ø8cm
02-003-00384	Ø10cm
02-003-00385	Ø12cm
02-003-00386	Ø14cm
02-003-00387	Ø16cm
02-003-00388	Ø18cm
02-003-00389	Ø20cm
02-003-00397	Ø23cm



Stainless Steel Fine Mesh Bowl Strainer with Black Handle

Product Code	Dimension
02-003-00286	8"
02-003-00287	10"



Stainless Steel Tea Strainer with Red Handle

Product Code	Dimension
02-003-00406	Ø7cm
02-003-00407	Ø8cm
02-003-00408	Ø10cm



MATFER Holder for Bouillon Strainer

Product Code	Dimension
02-003-00402(XX)	Ø14/20 x H21.5cm



CCK Stainless Steel Noodle Strainer Square Holes with Bamboo Handle

Product Code	Dimension
02-003-00343	Ø10"
02-003-00344	Ø11"
02-003-00345	Ø12"



Stainless Steel Bowl Strainer with Black Handle

Product Code	Dimension
02-003-00282	6"
02-003-00283	7"
02-003-00284	8"
02-003-00285	10"



Stainless Steel Double Mesh Bowl Strainer with Rosewood Handle

Product Code	Dimension
02-003-00288	16cm
02-003-00289	20cm
02-003-00290	25cm



MATFER Exoglass Bouillon Strainer

Product Code	Dimension
02-003-00401	Ø20cm x H22cm



Stainless Steel Bouillon Strainer with Reinforced Bar

Product Code	Dimension
02-003-00409	Ø20 x 14cm
02-003-00410	Ø22 x 23cm



Stainless Steel Noodle Strainer Square Holes with Bamboo Handle

Product Code	Dimension
02-003-00330	Ø6"
02-003-00331	Ø7"
02-003-00332	Ø8"
02-003-00333	Ø9"
02-003-00334	Ø10"
02-003-00335	Ø11"
02-003-00336	Ø12"



CCK Stainless Steel Deep Noodle Strainer with Bamboo Handle

Product Code	Dimension
02-003-00364	Ø6"
02-003-00365	Ø6.5"



Stainless Steel Deep Noodle Strainer with Bamboo Handle

Product Code	Dimension
02-003-00321	Ø6"
02-003-00322	Ø6.5"



CCK Stainless Steel Deep Noodle Strainer with Stainless Steel Handle

Product Code	Dimension
02-003-00349	Ø5.5"
02-003-00350	Ø6"
02-003-00351	Ø6.5"



CCK CHINA Stainless Steel Deep Noodle Strainer with Stainless Steel & Bamboo Handle

Product Code	Dimension
02-003-00352	Ø5"
02-003-00353	Ø6"
02-003-00354	Ø6.5"



02-003-00444



02-003-00445



02-003-00281



02-003-00291



02-003-00298



02-003-00405



02-003-00411

Stainless Steel Noodle Strainer Square Holes with Bamboo Handle

Product Code	Dimension	Height of Basket	Full Product Length
02-003-00444	Ø11.5cm	14cm	36cm
02-003-00445	Ø13cm	15cm	37cm
02-003-00281	Ø13.5cm	16.5cm	36cm
02-003-00291	Ø14cm	15cm	36cm
02-003-00298	Ø14cm	14cm	37cm
02-003-00405	Ø14cm	15cm	37cm
02-003-00411	Ø14cm	11.5cm	36cm



Stainless Steel Fine Mesh Oil Strainer with Bamboo Handle

Product Code	Dimension
02-003-00323	Ø6"
02-003-00324	Ø7"
02-003-00325	Ø8"
02-003-00326	Ø9"
02-003-00327	Ø10"
02-003-00328	Ø11"
02-003-00329	Ø12"



Stainless Steel Meshed Conical Soup Strainer

Product Code	Dimension
02-003-00438	Ø15cm
02-003-00439	Ø17.5cm
02-003-00440	Ø20cm
02-003-00441	Ø22.5cm
02-003-00442	Ø25cm



Stainless Steel Herbal Basket Strainer

Product Code	Dimension
02-003-00446	Ø15 x H15cm
02-003-00447	Ø17.5 x H17.5cm
02-003-00448	Ø20 x H20cm
02-003-00449	Ø22.5 x H22.5cm
02-003-00451	Ø30 x H30cm



Stainless Steel Egg / Oil Strainer

Product Code	Dimension
02-003-00542	Ø14.6 x 4.6cm
02-003-00543	Ø18.2 x 5.8cm
02-003-00544	Ø21.5 x 6.6cm
02-003-00545	Ø23.5 x 7.5cm
02-003-00546	Ø27.5 x 8.7cm



CCK Stainless Steel Fine Soup Strainer with 2 Handles

Product Code	Dimension
02-003-00550	Ø12 x H4.75cm
02-003-00551	Ø13 x H5.5cm
02-003-00552	Ø14 x H5cm
02-003-00553	Ø15 x H5cm
02-003-00554	Ø16 x H5cm
02-003-00555	Ø18 x H5cm
02-003-00556	Ø20 x H5.5cm



Stainless Steel One-Pc Skimmer

Product Code	Dimension
02-003-00507	Ø8 x L36.5cm
02-003-00501	Ø10 x L42cm
02-003-00502	Ø12 x L48cm
02-003-00503	Ø14 x L53cm
02-003-00504	Ø16 x L58cm
02-003-00505	Ø18 x L63cm
02-003-00506	Ø20 x L67cm



Stainless Steel Ball Strainer

Product Code	Dimension
02-003-00452	Ø8.3cm
02-003-00453	Ø10cm
02-003-00454	Ø13cm
02-003-00455	Ø14.5cm



CCK Stainless Steel Egg Strainer with 2 Handles

Product Code	Dimension
02-003-00547	Ø8"
02-003-00548	Ø9"
02-003-00549	Ø10"



Stainless Steel Skimmer with Round Handle

Product Code	Dimension
02-003-00514	34.5cm



Stainless Steel Skimmer

Product Code	Dimension
02-003-00499	Ø4.3/4" x 14"
02-003-00500	Ø6" x 14"



Stainless Steel Square Shape Japanese Style Skimmer

Product Code	Dimension
02-003-00456	17.5 x 42.5cm

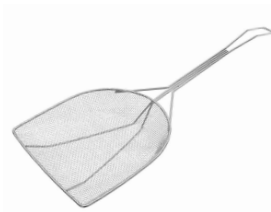

Stainless Steel Half-Moon Shape Japanese Style Skimmer

Product Code	Dimension
02-003-00458	15.5 x 14.6cm



Stainless Steel Round Shape Japanese Style Skimmer

Product Code	Dimension
02-003-00457	20cm



ALEGACY Round Reinforced Fine Mesh Skimmer

Product Code	Dimension
02-003-00497	Ø6.1/2" - 16.5cm



LACOR Wire Mesh Skimmer

Product Code	Dimension
02-003-00481	Ø24cm
02-003-00482	Ø28cm



ALEGACY Square Reinforced Fine Mesh Skimmer

Product Code	Dimension
02-003-00498	L6.1/2" - 16.5cm



LACOR Stainless Steel One-Pc Wire Skimmer

Product Code	Dimension
02-003-00475	Ø14 x L51cm
02-003-00477	Ø16 x L53cm
02-003-00479	Ø18 x L62cm
02-003-00480	Ø20 x L62cm



Stainless Steel Fine Mesh Skimmer

Product Code	Dimension
02-003-00459	Ø15cm
02-003-00460	Ø16.5cm
02-003-00461	Ø19cm
02-003-00462	Ø21.5cm
02-003-00463	Ø24cm



Stainless Steel Oil Skimmer

Product Code	Dimension
02-003-00464	Ø22cm
02-003-00465	Ø24cm
02-003-00466	Ø26cm
02-003-00467	Ø28cm
02-003-00468	Ø30cm



Stainless Steel Wire Skimmer

Product Code	Dimension
02-003-00795	Ø13cm
02-003-00796	Ø15cm
02-003-00797	Ø18cm
02-003-00798	Ø20cm
02-003-00799	Ø24cm



CCK Stainless Steel Fine Mesh Oil Skimmer with Stainless Steel Handle

Product Code	Dimension
02-003-00495	Ø10"
02-003-00496	Ø12"



CCK Stainless Steel Sor-Hock / Oil Skimmer (Perforated)

Product Code	Dimension
02-003-00487	Ø9"
02-003-00488	Ø10"
02-003-00489	Ø11"
02-003-00490	Ø12"



CCK Stainless Steel Oil Skimmer (Big Hole)

Product Code	Dimension
02-003-00483	Ø9"
02-003-00484	Ø10"
02-003-00485	Ø11"
02-003-00486	Ø12"



CCK Stainless Steel Oil Skimmer / Sor-Hock Stand

Product Code	Dimension
02-003-00491	Ø7"
02-003-00492	Ø8"
02-003-00494	Ø10"



Wooden Handle for Skimmer / Wok

Product Code	Dimension	Thick
02-003-00522	8"	Thick



Stainless Steel Bird Nest Fryer

Product Code	Dimension
02-003-00523	Ø9cm
02-003-00524	Ø13cm
02-003-00525	Ø17cm



CCK Stainless Steel Deep Fry Wire Basket with 2 Baskets

Product Code	Dimension
02-003-00534	Ø20"
02-003-00535	Ø22"
02-003-00536	Ø24"



CCK TRIPOT Stainless Steel Wire Mesh Yam Cake Fryer

Product Code	Dimension
02-003-00526	Ø12"
02-003-00527	Ø14"
02-003-00528	Ø16"
02-003-00529	Ø18"



CCK TRIPOT Stainless Steel Yam Cake Flat Fryer

Product Code	Dimension
02-003-00530	Ø12"
02-003-00531	Ø14"
02-003-00532	Ø16"
02-003-00533	Ø18"





Stainless Steel Rectangle Deep Frying Basket

Product Code	Dimension
02-003-00541	22 x 20 x 13cm
02-003-00540	31 x 17 x 13cm



Rectangle Fry Basket

Product Code	Dimension
02-003-00537	13" x 6.1/2" x 5.1/4"
02-003-00538	13.3/8" x 5.1/2" x 5.1/4"



TABLECRAFT Taco Fry Basket

Product Code	Capacity
02-003-00539(XX)	Holds Eight 6" Taco Shells



Stainless Steel 1/1 GN Grid Fry Basket Premium

Product Code	Dimension
02-003-00809	53 x 32.5 x 3.7cm



Stainless Steel Water Scoop with Handle

Product Code	Dimension
02-003-00273	20cm



Stainless Steel Water Scoop Light Duty

Product Code	Dimension
02-003-00255	16 x 7cm
02-003-00256	18 x 7.5cm
02-003-00257	20 x 8.5cm



CCK S'PORE STYLE Stainless Steel Long Handle Scoop

Product Code	Dimension
02-003-00261	Ø3 x L16.2cm
02-003-00266	Ø3.5 x L16.8cm
02-003-00262	Ø4 x L17cm
02-003-00267	Ø4.5 x L17.6cm
02-003-00263	Ø5 x L18cm
02-003-00268	Ø5.5 x L18.6cm
02-003-00264	Ø6 x L19cm
02-003-00269	Ø6.5 x L19.6cm
02-003-00265	Ø7 x L20cm



CCK Stainless Steel Water Scoop

Product Code	Dimension	Capacity
02-003-00270	Ø18 x H8.5cm	3 Katis
02-003-00271	Ø19 x H9.5cm	4 Katis
02-003-00272	Ø20 x H10cm	5 Katis



Stainless Steel Water Scoop with Spout

Product Code	Dimension
02-003-00274	Ø16 x H8cm
02-003-00275	Ø18 x H9cm
02-003-00276	Ø20 x H8.8cm



Stainless Steel Water Scoop with Long Handle

Product Code	Dimension
02-003-00277	Ø18 x L45cm
02-003-00278	Ø18 x L60cm



Stainless Steel Star Shape Egg Ring

Product Code
02-003-00783



Stainless Steel Heart Shape Egg Ring

Product Code
02-003-00784



Stainless Steel Round Egg Ring

Product Code	Dimension
02-003-00779	Ø3"
02-003-00780	Ø3.5"
02-003-00781	Ø4"
02-003-00782	Ø4.5"



CCK Nylon Fish Net Aluminium Handle

Product Code	Dimension	
02-003-00791	Ø10"	#3
02-003-00790	Ø12"	#2
02-003-00789	Ø14"	#1



LAVA ECO Cast Iron Square Grill Steak Press / Weight

Product Code	Dimension
02-003-00741	21 x 21cm

*Please refer to Chapter 4 for Hamburger Press



SAN JAMAR Disposable T-Stick (+71°C)

Product Code	Capacity	Colour
02-003-00748	250pcs/pkt	Black

Disposable thermometer sticks for verifying minimum internal temperature



CCK Paper for Steaming Malay Cake

Product Code	Dimension	
02-003-00764	40 x 44cm	By packet



CCK Paper for Char Siew Bun

Product Code	Dimension	
02-003-00765	6.5 x 6.5cm	Approx. 3,800 pcs



CCK Paper for Steaming Sausage Roll

Product Code	Dimension
02-003-00766	2.5 x 4cm



CCK Paper for Steaming Big Bun

Product Code	Dimension
02-003-00767	9 x 9cm



CCK Herbal / Fish Bag

Product Code	Dimension
02-003-00768	11" x 13"
02-003-00769	12" x 12"
02-003-00770	15" x 15"
02-003-00771	10" x 12"



CCK Steaming Rice Bag

Product Code	Dimension
02-003-00773	Size 2



CCK Deep Frying Paper Bag

Product Code	Dimension	
02-003-00774	11.4 x 10cm	200pcs/pkt



CCK Fun Cheong Cloth

Product Code	Dimension
02-003-00772	22" x 16.8"



SAN JAMAR Cheese Cloth

Product Code	Dimension	
02-003-00776	7315 x 91cm	1 Roll
02-003-00777	183 x 183cm	1 Pack



Coconut Squeezer Bag

Product Code
02-003-00778



Wooden Cloth Peg

Product Code	
02-003-00775	Set of 36

**CCK** *Stainless Steel 4-Prong Rice Fork*

Product Code	Dimension
02-003-00610	11"

**LACOR** *Stainless Steel 2-Prong Fork*

Product Code	Dimension
02-003-00628	50 x 7cm

**LACOR** *Stainless Steel 3-Prong Fork*

Product Code	Dimension
02-003-00629(XX)	50 x 7cm

*Stainless Steel Cooling Fork*

Product Code	Dimension
02-003-00651	33 x 3.5cm

*Wooden Rice Fork*

Product Code	Dimension
02-003-00757	17" x 2"
02-003-00758	20" x 3"

**CLIFTON** *Double Ended Tasting Spoon*

Product Code	Dimension
02-003-00611	15cm
02-003-00612	18cm
02-003-00613	21cm

**DAUDIGNAC** *Stainless Steel Deco Spoon*

Product Code	
02-003-00614	2 Pcs Stainless Steelet with Wooden Handle
02-003-00615	2 Pcs Stainless Steelet with Stainless Steel Handle

**MATFER** *Exoglass Spoon*

Product Code	Dimension
02-003-00634	30cm
02-003-00635	38cm
02-003-00636	45cm Handle 20cm

**LACOR** *Silicone Spoon with Thermometer Probe*

Product Code	Dimension	Range
02-003-00632	29cm	-50° to 300°C

**MYE ACACIA-OILED** *Wooden Spoon*

Product Code	Dimension
02-003-00637	35 x 7cm



Stainless Steel One-Pc Basting Spoon

Product Code	Dimension
02-003-00652	46cm



ZEBRA Stainless Steel Basting Spoon

Product Code	Dimension
02-003-00646	Ø7 x L29cm



Stainless Steel One-Pc Basting Spoon

Product Code	Dimension
02-003-00647	13"
02-003-00648	15"



Stainless Steel Basting Spoon with Bakelite Handle

Product Code	Dimension
02-003-00649	13"
02-003-00650	15"



Stainless Steel Perforated Basting Spoon

Product Code	Dimension
02-003-00653	13"
02-003-00654	15"



Stainless Steel Perforated Basting Spoon with Bakelite Handle

Product Code	Dimension
02-003-00655	13"
02-003-00656	15"



Stainless Steel Slotted Basting Spoon

Product Code	Dimension
02-003-00657	13"
02-003-00658	15"



Stainless Steel Slotted Basting Spoon with Bakelite Handle

Product Code	Dimension
02-003-00659	13"
02-003-00660	15"



LACOR Stainless Steel One-Pc Perforated Basting Spoon

Product Code	Dimension
02-003-00631	Ø7.5 x L47cm



LACOR Stainless Steel One-Pc Horizontal Basting Spoon

Product Code	Dimension
02-003-00633(XX)	Ø7.5 x L34cm



LACOR *Stainless Steel One-Pc Solid Basting Spoon*

Product Code	Dimension
02-003-00630	Ø7.5 x L47cm



LACOR *Stainless Steel Baster with Syringe & Cleaning Brush*

Product Code	Dimension
02-003-00749	30cm



LACOR *Stainless Steel Burger Tong*

Product Code	Dimension
02-003-00702	24cm



EDLUND *Stainless Steel Heavy Duty Grip Tong*

Product Code	Dimension
02-003-00689	10"
02-003-00691	12"
02-003-00693	16"



EDLUND *Stainless Steel Heavy Duty Grip Tong with Lock*

Product Code	Dimension
02-003-00690	10"
02-003-00692	12"
02-003-00694	16"



EDLUND *Stainless Steel Heavy Duty Scallop Tong*

Product Code	Dimension
02-003-00697	9"
02-003-00695	12"
02-003-00696	16"



EDLUND *Stainless Steel Heavy Duty Scallop Tong with Lock*

Product Code	Dimension
02-003-00700	9"
02-003-00698	12"
02-003-00699	16"



WESTMARK *High Heat Double Turner & Kitchen Tongs*

Product Code	Dimension	
02-003-00705	29.5cm	Heat resistant up to 210°C/ 410°F



Stainless Steel Oven Tray Grip Tong with Rubber

Product Code	Dimension
02-003-00710	19cm



Multi Purpose Grips

Product Code	Dimension
02-003-00708	18.5cm



Stainless Steel Scallop Tong with Plastic Handle

Product Code	Black	Yellow	Red	Green	Blue
9.5"	02-003-00667	02-003-00668	02-003-00669	02-003-00670	02-003-00671
12"	02-003-00672	02-003-00673	02-003-00674	02-003-00675	02-003-00676
16"	02-003-00677		02-003-00678	02-003-00679	02-003-00680



Stainless Steel Scallop Tong with Plastic Handle

Product Code	Black	Blue	Green	Red	Yellow	Brown
23cm	02-003-00711	02-003-00712	02-003-00713	02-003-00714	02-003-00715	02-003-00716
30.5cm	02-003-00717	02-003-00718	02-003-00719	02-003-00720	02-003-00721	02-003-00722
40.6cm	02-003-00723	02-003-00724	02-003-00725	02-003-00726	02-003-00727	



Stainless Steel Steak Tong

Product Code	Dimension
02-003-00728	15"
02-003-00729	46.5cm



Stainless Steel Utility Tong with Locking Ring

Product Code	Dimension
02-003-00734	9"
02-003-00735	12"
02-003-00736	16"



MASTRAD Stainless Steel Silicone Express Tongs

Product Code	Dimension	Colour
02-003-00817	28cm	Black
02-003-00819	28cm	Green
02-003-00820	28cm	Red



Stainless Steel Utility Tong

Product Code	Dimension
02-003-00731	9"
02-003-00732	12"
02-003-00733	16"



MASTRAD Stainless Steel Silicone Quick Tongs

Product Code	Dimension	Colour
02-003-00816	38cm	Black



MASTRAD Stainless Steel Silicone Multi-Purpose Tongs

Product Code	Dimension	Colour
02-003-00812	26cm	Black
02-003-00814	26cm	Green
02-003-00815	26cm	Red



CLIFTON *Stainless Steel Fine Tip Micro Tweezers*

Product Code	Dimension
02-003-00683	13cm
02-003-00682	16cm



CLIFTON *Stainless Steel Sushi Tweezer*

Product Code	Dimension
02-003-00688	14.5cm
02-003-00687	20cm



CLIFTON *Stainless Steel Round Tip Micro Tweezers*

Product Code	Dimension
02-003-00684	13cm
02-003-00685	16cm
02-003-00686	30cm



WESTMARK *Stainless Steel Pincer Tong*

Product Code	Dimension
02-003-00704	29cm



GIESSER *Fish Pincer*

Product Code	Dimension
02-003-00701	16.2cm



Stainless Steel Tweezer Flat

Product Code	Dimension
02-003-00730	10.5cm



CCK *Stainless Steel Duck Feather Tweezer*

Product Code	Dimension
02-003-00681	15.5cm



Long Bamboo Chopstick

Product Code	Dimension
02-003-00737	18"



Wooden Long Chopstick

Product Code	Dimension
02-003-00738	43cm



CCK Wooden Chopstick

Product Code	Dimension
02-003-00739	20"



Bamboo Chopsticks

Product Code	Dimension	
02-003-00740	10"	10 pairs/pkt



LACOR Stainless Steel Extra 8 Whisk

Product Code	Dimension
02-003-00558	25cm
02-003-00559	30cm
02-003-00560	35cm
02-003-00561	40cm
02-003-00562	45cm
02-003-00563	50cm
02-003-00564	55cm
02-003-00565	60cm



LACOR Stainless Steel Super 12 Whisk

Product Code	Dimension
02-003-00569	25cm
02-003-00570	30cm
02-003-00571	35cm
02-003-00572	40cm
02-003-00573	45cm
02-003-00574	50cm



LACOR Stainless Steel Whisk with Fibreglass Handle

Product Code	Dimension
02-003-00575	25cm
02-003-00576	30cm
02-003-00577	35cm
02-003-00578	40cm
02-003-00579	45cm
02-003-00580	50cm



DE BUYER Stainless Steel 8-Wire Whisk with Non-Slip Handle

Product Code	Dimension
02-003-00581	25cm
02-003-00582	30cm
02-003-00583	35cm
02-003-00584	40cm
02-003-00585	45cm
02-003-00586	50cm



MATFER Exoglass Piano Whisk

Product Code	Dimension	Handle
02-003-00590	25cm	10cm
02-003-00591	30cm	11cm
02-003-00592	35cm	13cm
02-003-00593	40cm	16cm
02-003-00594	45cm	20cm
02-003-00595	50cm	26cm



LACOR Stainless Steel Kettle Whisk

Product Code	Dimension
02-003-00566	100cm
02-003-00567	120cm



SUNNEX Stainless Steel 12-Wire Egg Whisk with U-Hook

Product Code	Dimension
02-003-00598	25cm
02-003-00599	30cm
02-003-00600	35cm
02-003-00601	40cm
02-003-00602	45cm



SUNNEX Stainless Steel 8-Wire French Whisk with U-Hook

Product Code	Dimension
02-003-00603	25cm
02-003-00604	30cm
02-003-00605	35cm
02-003-00606	40cm
02-003-00607	45cm



MATFER Exoglass Rigid Wires Whisk

Product Code	Dimension	Handle
02-003-00596	40cm	16cm
02-003-00597	45cm	20cm

Special for mayonnaise and other stiff creams



LACOR Stainless Steel Mini Whisk

Product Code	Dimension
02-003-00568	20cm



IBILI Stainless Steel Mini Whisk

Product Code	Dimension
02-003-00589	15cm



Chrome-Plated Mini Whisks with Ring

Product Code	Dimension
02-003-00609	4pcs/set



Stainless Steel Pastry Blender / Masher with Plastic Handle

Product Code	Dimension
02-003-00608	11.7 x 11.5cm



LACOR Stainless Steel Wall Hanger for Utensils with Hooks

Product Code	Dimension	
02-003-00785	100cm	For 12 Hooks
02-003-00786	60cm	For 8 Hooks



Stainless Steel Cutlery Holder

Product Code	Dimension
02-003-00788	Ø10 x 17cm



Stainless Steel Bean Curd Pail / Bucket with Lid

Product Code	Dimension	Capacity
02-004-00008	Ø26 x H26cm	10ℓ
02-004-00009	Ø29 x H29cm	15ℓ
02-004-00010	Ø32 x H32cm	20ℓ
02-004-00020(XX)	Ø35 x H35cm	28ℓ



Wooden Round Bean Curd Bucket with Lid (Excludes Stainless Steel Insert)

Product Code	Dimension
02-004-00011	Ø14 x H14.5cm
02-004-00012	Ø16 x H15cm
02-004-00013	Ø18 x H15.5cm
02-004-00014	Ø20 x H18cm



CCK Stainless Steel Bean Curd Scoop with Wooden Handle

Product Code	Dimension
02-004-00016	19 x 8cm



CCK Stainless Steel Bean Curd Scoop with Stainless Steel Handle

Product Code	Dimension	Handle
02-004-00015	10.1 x 9.9cm	4"



CCK Stainless Steel Bean Curd Scoop without Handle

Product Code	Dimension
02-004-00017	14 x 11cm



Stainless Steel Square Bean Curd Box

Product Code	Dimension
02-004-00018	24 x 24 x 5cm
02-004-00019	27 x 27 x 5cm



CCK Stainless Steel Stool

Product Code	Dimension
02-004-00021	14" x 12" x 10"



CCK Stainless Steel Maltose Box with Cover

Product Code	Dimension
02-004-00022	48 x 32 x 28cm
02-004-00024(XX)	53 x 35 x 31cm



CCK Stainless Steel Maltose Box Stand for 02-004-00022

Product Code	Dimension
02-004-00023	54.5 x 3 x 112.5cm



CCK Stainless Steel Maltose Box Stand for 02-004-00024

Product Code	Dimension
02-004-00025(XX)	60 x 35 x 112cm



CCK Stainless Steel Maltose Box Stand with Wheel

Product Code	Dimension
02-004-00026(XX)	54.5 x 32 x 112cm



Tempura Chopstick, Rose Wood Handle

Product Code	Dimension
02-004-00033	35cm
02-004-00034	42cm



Bamboo Sushi Mat 5-Thread

Product Code	Dimension
02-004-00035	27 x 18cm



Bamboo Sushi Mat

Product Code	Dimension
02-004-00036	24 x 24cm



Round Wooden Sushi Rice Basin

Product Code	Dimension
02-004-00028	Ø45cm
02-004-00029	Ø48cm
02-004-00030	Ø52cm
02-004-00031	Ø60cm
02-004-00032	Ø72cm



L'TELLIER Stainless Steel Cream Whipper Gastro

Product Code	Dimension	Capacity
02-004-00001	28cm / 550g	0.5ℓ
02-004-00002	35cm / 800g	1.0ℓ



MOSA Stainless Steel Cream Whipper

Product Code	Capacity
02-004-00004	0.5ℓ
02-004-00005	1.0ℓ



MOSA N2O Cream Charger

Product Code	Quantity
02-004-00006	10pcs/pkt



MOSA Aluminium Soda Siphon with Plastic Head Set

Product Code	Capacity	Colour
02-004-00041	1.0ℓ	Black
02-004-00042	1.0ℓ	Silver
02-004-00043	1.0ℓ	White



MOSA CO2 Soda Charger

Product Code	Quantity
02-004-00003	10pcs/pkt



L'TELLIER Stainless Steel Egg Cracker

Product Code	Dimension
02-004-00038	Ø6.5 x L10cm



WESTMARK Stainless Steel Egg Shell Cutter

Product Code	Dimension
02-004-00039	9 x 8 x 1cm



L'TELLIER Stainless Steel Egg Knocker

Product Code	Dimension
02-004-00037	11cm

METTLER TOLEDO Digital Platform Scales

Product Code	Platform Size	Maximum Load	Increment
02-005-00015(XX)	30.5 x 35.5cm	30kg	10g
02-005-00016(XX)	30.5 x 35.5cm	60kg	20g
02-005-00017(XX)	42 x 55cm	150kg	50g
02-005-00018(XX)	42 x 55cm	300kg	50g
02-005-00019(XX)	42 x 55cm	60kg	10g
02-005-00020(XX)	60 x 80cm	600kg	100g



Digi 2-Sided Digital Weighing Scale

Product Code	Maximum Load	Increment
02-005-00005	3kg	0.5g
02-005-00006	6kg	1g
02-005-00007	15kg	2g
02-005-00008	30kg	5g



EDLUND Digital Portion Control Scale

Product Code	Dimension	Max. Load	Increment
02-005-00009	25 x 18 x 6cm	5kg	1g

Plastic body with stainless steel platform

TANITA Digital Weighing Scale

Product Code	Dimension	Max. Load	Increment
02-005-00024	18.3 x 25.5 x 6.8cm Platform: 18.3 x 18.3cm	1kg	1g
02-005-00025	18.3 x 25.5 x 6.8cm Platform: 18.3 x 18.3cm	2kg	2g
02-005-00026	18.3 x 25.5 x 6.8cm Platform: 18.3 x 18.3cm	5kg	5g

4 x AA batteries (Not included)



ADE GERMANY KYLIE Digital Kitchen Scale

Product Code	Dimension	Max. Load	Increment
02-005-00001(XX)	14 x 23.5 x 1.3cm	5kg	1g

Kylie Silver-Grey / Black Range



ADE GERMANY ANJA Digital Kitchen Scale

Product Code	Dimension	Max. Load	Increment
02-005-00002	Ø16.5 x 2.2cm	5kg	1g

Anja Silver-Grey / Black Range





ADE GERMANY SLIM Digital Kitchen Scale

Product Code	Dimension	Max. Load	Increment
02-005-00004	23 x 15 x 1.2cm	5kg	1g

Slim White Range



TANITA Digital Weighing Scale with Plastic Bowl

Product Code	Dimension	Max. Load	Increment
02-005-00022	20 x 15 x 4cm Bowl: Ø6.2 x 18cm	2kg	1g



MIKI Electric Pocket Digital Scale

Product Code	Dimension	Max. Load	Increment
02-005-00021	62.2 x 53.7mm	500g	0.01g

Battery and pouch included.



ORCHID FLAT TOP Weighing Scale

Product Code	Dimension	Max. Load	Increment
02-005-00078	23.5 x 19 x 22cm	2kg	25g
02-005-00079	23.5 x 19 x 22cm	2kg	10g
02-005-00080	30 x 20 x 26.5cm	5kg	20g
02-005-00081	30 x 20 x 26.5cm	5kg	25g
02-005-00082	30 x 28 x 26cm	10kg	50g
02-005-00083	30 x 28 x 26cm	12kg	50g
02-005-00084	30 x 28 x 26cm	12kg	50g
02-005-00085	30 x 28 x 26cm	12kg	50g
02-005-00086	30 x 28 x 26cm	12kg	50g
02-005-00087	31 x 25 x 26.5cm	20kg	100g
02-005-00088	31 x 25 x 26.5cm	20kg	100g
02-005-00089	31 x 25 x 26.5cm	30kg	100g
02-005-00090	31 x 25 x 26.5cm	30kg	100g



Plastic Electronic Digital Scale with Bowl

Product Code	Dimension	Max. Load	Increment
02-005-00027	Ø20.5 x H11cm	3kg	1g

Using AAA Battery. Not included.



Electronic Digital Scale with Glass Plate

Product Code	Maximum Load	Increment
02-005-00028	5kg	1g

Battery not included.



ORCHID FLAT TOP Weighing Scale

Product Code	Dimension	Max. Load	Increment
02-005-00067	23.5 x 19 x 22cm	2kg	25g
02-005-00068	30 x 20 x 26.5cm	5kg	20g
02-005-00069	30 x 20 x 26.5cm	5kg	25g
02-005-00070	30 x 28 x 26cm	10kg	50g
02-005-00071	30 x 28 x 26cm	15kg	50g
02-005-00072	31 x 25 x 26.5cm	20kg	100g
02-005-00073	31 x 25 x 26.5cm	20kg	100g
02-005-00074	31 x 25 x 26.5cm	30kg	100g
02-005-00075	31 x 25 x 26.5cm	30kg	100g
02-005-00076	37 x 30 x 36cm	50kg	100g
02-005-00077	35 x 25 x 38cm	100kg	200g



CCK Stainless Steel Kitchen Scale Round Plate

Product Code	Maximum Load	Increment
02-005-00041	15kg	50g



CCK Weighing Scale

Product Code	Maximum Load	Increment
02-005-00038	20lbs	15kt
02-005-00039	26lbs	20kt



LACOR Chrome Weighing Scale with Plastic Bowl

Product Code	Maximum Load	Increment
02-005-00032	1kg	5g



LACOR Stainless Steel Weighing Scale with Bowl

Product Code	Dimension	Max. Load	Increment
02-005-00033	Ø20 x H13.5cm	3kg	25g



Plastic Weighing Scale

Product Code	Maximum Load	Increment
02-005-00091	1kg	5g
02-005-00092	2kg	10g
02-005-00093	5kg	100g
02-005-00037	5lbs	3.75 katis



CCK Chinese Dim Sum Scale

Product Code
02-005-00036



COOPER ATKINS 2 Mini Loggers with Mount

Product Code	Dimension	Range
02-005-00096	5 x 6.7cm	-40°C to 85°C

Records at specific intervals from 1 min. to 4hrs.
Water resistant. 2pcs/pkt



COOPER ATKINS Digital Thermometer Hygrometer

Product Code	Dimension	Range
02-005-00099	10.5 x 6.4 x 1.5cm	-10°C to 50°C, 10 to 99% RH



COOPER ATKINS Digital Hygrometer Wall / Desk Mount

Product Code	Range
02-005-00100(XX)	Temp. 0°C to 50°C Humidity 25% - 90% RH



BLUE GIZMO Big Display Thermo-Hygrometer

Product Code	Dimension	Range
02-005-00097	11 x 10cm	-10°C to +60°C / Accuracy: +-1°C Humidity: 10% - 99% R.H. +-5% R.H.



BLUE GIZMO Analog Thermo-Hygrometer

Product Code	Dimension	Range
02-005-00098	16cm	0°C to +120°C Humidity 0% to 100% Accuracy Temp: +-1°Cm Humidity: +-5%rH



COOPER ATKINS Infrared & Probe Thermometer

Product Code	Dimension	Range
02-005-00107	4.5 x 2.5 x 15.7cm	Infra -33°C to 220°C / -27°F to 428°F Probe -55°C to 330°C / -67°F to 626°F

BLUE GIZMO 2-in-1 Non-Contact Infrared Thermometer with Probe

Product Code	Dimension	Range
02-005-00103	16.4 x 4.5 x 2cm	-33°C to +220°C / Accuracy below -5°C +1°C, -5°C - 65°C +0.5°C, above 65°C +1% of reading

COOPER ATKINS Infrared Thermometer with Laser Sighting

Product Code	Dimension	Range
02-005-00105	5.5 x 3.5 x 18.5cm	-40°C to 280°C / -40°F to 536°F

COOPER ATKINS Infrared Gun-Style Thermometer w/ Thermocouple Jack

Product Code	Range
02-005-00108(XX)	-60°C to 500°C

WESTMARK Digital Wireless Roasting Thermometer

Product Code	Dimension	Range
02-005-00130	7.5 x 5.5 x 1.3cm Wire 10.5cm	0°C to 250°C

Mobile receiver range up to 30m

COOPER ATKINS Needle Probe with Stainless Steel Braided Cable Type K Thermocouple

Product Code	Range
02-005-00162	-40°C to 260°C 1 Year Warranty

BLUE GIZMO Noncontact Infrared Thermometer

Product Code	Dimension	Range
02-005-00102		-35°C to +630°C / Accuracy +2.5°C from -35°C to 0°C, +1.5°C from 0°C - 100°C, +2°C from 100°C - 630°C
02-005-00104	18 x 13 x 4cm	-32°C to +535°C / Accuracy +3°C for -32°C - 20°C, +2°C for 20°C - 100°C, +2% above 100°C

COOPER ATKINS Mini Infrared Pocket Thermometer

Product Code	Dimension	Range
02-005-00106	4 x 1.5 x 7cm	-33°C to 220°C

CLIFTON Sous Vide Thermometer & Probe Kit

Product Code	Dimension	Range
02-005-00112	12.7cm	-99°C to 299.9°C

COOPER ATKINS Aquatuff Waterproof Thermocouple

Product Code	Dimension	Range
02-005-00094(XX)	16.5 x 5.7 x 3.2cm	-73°C to 537°C

COOPER ATKINS Waterproof Digital Pocket Test Thermometer

Product Code	Dimension	Range
02-005-00116	12.7cm	-40°C to 232°C

COOPER ATKINS *Electronic Stem Thermometer*

Product Code	Dimension	Range
02-005-00117	12.7cm	-40°C to 150°C

COOPER ATKINS *Digital Waterproof Pocket Probe Test Thermometer*

Product Code	Dimension	Range
02-005-00118(XX)	7cm	-40°C to 200°C

BLUE GIZMO *Digital Pocket Thermometer*

Product Code	Dimension	Range
02-005-00109	9cm	-40°C to +200°C / Accuracy +/- 1°C
02-005-00111	17cm	-10°C to +200°C / Accuracy +/- 1°C

Digital Pocket Test Thermometer

Product Code	Range	Battery included
02-005-00120	-50°C to 300°C	Battery included

COOPER ATKINS *Needle Probe Type K Thermometer*

Product Code	Dimension	Range
02-005-00095(XX)	Shaft: 10cm Cable: 61cm	-40°C to 205°C . Response time: 4s

COOPER ATKINS *Test Thermometer*

Product Code	Dimension	Range
02-005-00115	20.3cm	-10°C to 100°C

COOPER ATKINS *Espresso Thermometer with Clip*

Product Code	Dimension	Range
02-005-00142	17.8cm	-10°C to 104°C

COOPER ATKINS *Pocket Test Thermometer*

Product Code	Dimension	Range
02-005-00113	12.7cm	-20°C to 100°C
02-005-00114	12.7cm	10°C to 285°C

COOPER ATKINS *Digital Refrigerator / Freezer Thermometer*

Product Code	Dimension	Range
02-005-00132	9 x 1.3 x 8.6cm	-30°C to 50°C

BLUE GIZMO *Digital Freezer Fridge Thermometer with Frame*

Product Code	Range
02-005-00131	-30°C to +50°C / Accuracy: +/-0.8°C for -20°C - +10°C, +/-1°C otherwise

COOPER ATKINS *Refrigerator / Freezer Thermometer*

Product Code	Dimension	Range
02-005-00133	Ø5.1cm	-29°C to 27°C/ Accuracy: +/-1°C

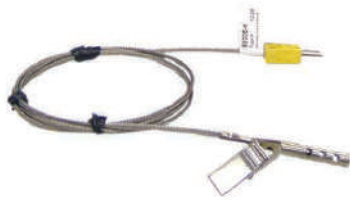

COOPER ATKINS Air Probe for Oven or Cooler / Freezer with Clip

Product Code	Range	
02-005-00161	-74°C to 315°C	1 Year Warranty



COOPER ATKINS Refrigerator / Freezer Thermometer Horizontal Glass Tube

Product Code	Dimension	Range
02-005-00136	12.7cm	-40°C to 25°C



COOPER ATKINS Cooler Thermometer

Product Code	Dimension	Range
02-005-00139	Ø3.8cm	-30°C to 50°C



COOPER ATKINS Coolit-Rite Digital Waterproof Cooling Validator

Product Code	Dimension	Range
02-005-00140	46.6cm	-20°C to 150°C Timer range 6hrs59mins



COOPER ATKINS Oven Thermometer

Product Code	Dimension	Range
02-005-00126	5cm	50°C to 300°C



COOPER ATKINS Refrigerator / Freezer Thermometer

Product Code	Dimension	Range
02-005-00135	7.6cm	-40°C to 50°C



COOPER ATKINS Refrigerator / Freezer Thermometer (2pcs/pkt)

Product Code	Dimension	Range
02-005-00134	Ø5.1cm	-29°C to 27°C/ Accuracy: +1°C



COOPER ATKINS Professional Stainless Steel Cooling Thermometer

Product Code	Dimension	Range
02-005-00138	46.6cm	30°F to 165°F / Accuracy +2°F



COOPER ATKINS Vessel Clip for Monitoring Thermometers

Product Code	
02-005-00123	



COOPER ATKINS Oven Thermometer (2pcs/pkt)

Product Code	Dimension	Range
02-005-00127	5cm	50°C to 300°C



COOPER ATKINS Cast Aluminium Grill Thermometer

Product Code	Dimension	Range
02-005-00129	Ø6.35cm	50°C to 300°C



COOPER ATKINS Hot Holding Thermometer

Product Code	Dimension	Range
02-005-00143	Ø5.1cm	40°C to 80°C



COOPER ATKINS Hot Holding Cabinet Thermometer (2pcs/pkt)

Product Code	Dimension	Range
02-005-00144	Ø5.1cm	40°C to 80°C



COOPER ATKINS Candy / Jelly / Deep Fry Thermometer

Product Code	Dimension	Range
02-005-00121	15.2cm	90°C to 200°C



L'TELLIER Candy Thermometer

Product Code	Range	
02-005-00124	+80°C +200°C / 1°C graduation	Plastic Housing



L'TELLIER Candy Thermometer

Product Code	Range	
02-005-00125	+80°C +200°C / 1°C graduation	Stainless Steel Housing



COOPER ATKINS Tank / Kettle / Deep Fry Thermometer

Product Code	Dimension	Range
02-005-00122	38.1cm	10°C to 285°C



COOPER ATKINS Meat Thermometer

Product Code	Dimension	Range
02-005-00141	15.2cm	54°C to 88°C



WESTMARK Tin-Plated Canning Thermometer

Product Code	Dimension	Range
02-005-00147	42 x 4 x 4cm	60°C to 110°C



L'TELLIER Baker Thermometer (Plastic Holding)

Product Code	Dimension	Range
02-005-00145	35.5cm	-10°C to 60°C / 1°C graduation



MATFER Baker Thermometer

Product Code	Dimension	Range
02-005-00146	17cm	0°C to 60°C



MATFER Stainless Steel Test Tube for Density Meter

Product Code	Dimension	Range
02-005-00149(XX)	Ø3.6 x 17.5cm	17.5cl



ATAGO Digital Hand-Held Refractometer

Product Code	Dimension	Range
02-005-00152	3.1 x 5.5 x 10.9cm	(BRIX 0.0-53%) Accuracy +/-0.2%
02-005-00154(XX)	3.1 x 5.5 x 10.9cm	(BRIX 0.0-25%)



COOPER ATKINS 24 Hours Large Timer with Memory

Product Code	Dimension
02-005-00155	17.8 x 10.2 x 14.1cm



COOPER ATKINS Digital Solar Panel Thermometer

Product Code	Dimension	Range
02-005-00137	11.5cm	-50°C to 70°C



ATAGO Water-Resistant Refractometer

Product Code	Dimension	Range
02-005-00150	3.2 x 3.4 x 16.8cm	(BRIX 0.0-53%) Accuracy +/-0.5%

x1pc Small size 19cm, x1pc Large size 23cm



COOPER ATKINS Electric Timer / Stopwatch with Lanyard Rope

Product Code	Dimension	Range
02-005-00156	Ø6cm	Up to 99mins59s



COOPER ATKINS Waterproof Digital Timer with Large LCD

Product Code	Dimension	Range
02-005-00157	8.3 x 7.6 x 2.5cm	Up to 99mins59s



Digital Timer

Product Code	Range
02-005-00160	Up to 99mins

CUTTING
TOOLS



CHAPTER

03

SIA HUAT 
Beyond Foodservice Supplies

www.siahuat.com

HACCP SAFETY AND HYGIENE.



WHITE



YELLOW



RED



BLUE



GREEN



BROWN

PROFESSIONAL KNIVES SINCE 1776.

As one of the world's leading manufacturers of quality knives and accessories for professional use, GIESSER produces more than 8,000 knives daily at its plant in Winnenden, Germany. The broad product range includes 2,500 different forged and stamped knives, as well as accessories for the food service and food processing industries. GIESSER products feature outstanding materials and first-class workmanship. You'll find just the right tool for your demands.



GIESSER

MADE IN GERMANY

www.giesser.de



GIESSER Curved Paring Knife (Bird's Beak) with Plastic Handle

Product Code	Dimension*	Colour
03-001-00253	6cm	Blue
03-001-00255	6cm	Green
03-001-00256	6cm	Red
03-001-00257	6cm	White
03-001-00254	6cm	Yellow
03-001-00252	6cm	Black



GIESSER FORGED Curved Paring Knife (Bird's Beak) Forged Blade with PAG Handle

Product Code	Dimension*	Colour
03-001-00220	9cm	Black
03-001-00221	9cm	Green



GIESSER Paring Knife Forged Blade with Pom Handle

Product Code	Dimension*	Colour
03-001-00212	10cm	Black
03-001-00213	10cm	Blue
03-001-00214	10cm	Yellow
03-001-00215	10cm	Green
03-001-00216	10cm	Red
03-001-00217	12cm	Black



GIESSER BEST CUT Paring Knife Forged Blade with Plastic Handle

Product Code	Dimension*	Colour
03-001-00207	8cm	Black
03-001-00208	10cm	Black



GIESSER BEST CUT Paring Knife Wavy Edge with Plastic Handle

Product Code	Dimension*	Colour
03-001-00209	10cm	Black



GIESSER PRIME LINE Vegetable Knife with Plastic Handle

Product Code	Dimension*	Colour
03-001-00227	8cm	Black
03-001-00228	10cm	Black
03-001-00229	10cm	Green
03-001-00230	10cm	Red



GIESSER FORGED Vegetable Knife Forged Blade with Pom Handle

Product Code	Dimension*	Colour
03-001-00218	8cm	Black
03-001-00219	8cm	Green



GIESSER Vegetable Knife with Plastic Handle

Product Code	Dimension*	Colour
03-001-00231	8cm	Black
03-001-00232	8cm	Green
03-001-00233	8cm	Red
03-001-00234 (with Wavy Edge)	8cm	Black



GIESSER POM Vegetable Knife with Pom Handle

Product Code	Dimension*	Colour
03-001-00226	8.5cm	Black



GIESSER Vegetable Knife with Plastic Handle

Blade	Dimension*	Black	Blue	Brown	Yellow	Green	Violet	Red	White
Normal	8cm	03-001-00235	03-001-00236		03-001-00237	03-001-00238		03-001-00239	03-001-00240
	10cm	03-001-00241	03-001-00242	03-001-00243	03-001-00244	03-001-00245	03-001-00660	03-001-00246	03-001-00247
	12cm	03-001-00248							
Wavy Edge	8cm	03-001-00249							
	10cm	03-001-00250				03-001-00251			

*Dimension refer to the blade length only



GIESSER Universal Knife with Serrated Edge and Plastic Handle

Product Code	Dimension*	Colour
03-001-00395	11cm	Blue
03-001-00396	11cm	Yellow
03-001-00397	11cm	Green
03-001-00398	11cm	Red
03-001-00399	11cm	White
03-001-00400	11cm	Black



GIESSER Universal Knife with Serrated Edge with Wooden Handle

Product Code	Dimension*
03-001-00388	11cm



GIESSER PRIME LINE Universal Knife with Wavy Edge and Plastic Handle

Product Code	Dimension*	Colour
03-001-00390	11cm	Black
03-001-00389	25cm	Black



GIESSER Universal Knife with Plastic Handle

Product Code	Dimension*	Colour
03-001-00394	11cm	Black



GIESSER BEST CUT Universal Knife with Wavy Edge

Product Code	Dimension*	Colour
03-001-00652	25cm	Black



GIESSER Universal Knife with Plastic Handle

Product Code	Dimension*	Colour
03-001-00393 (with Wavy Edge)	25cm	White
03-001-00392 (with Wavy Edge)	25cm	Black
03-001-00391	25cm	Black



GIESSER Universal Knife with Wooden Handle

Product Code	Dimension*
03-001-00387	25cm



GIESSER Kitchen Knife Thin Blade with Plastic Handle

Product Code	Dimension*	Colour
03-001-00197	13cm	Black
03-001-00198	13cm	Yellow
03-001-00199	13cm	Green
03-001-00200	15cm	Black
03-001-00201	15cm	White



GIESSER PRIME LINE Kitchen Knife with Plastic Handle

Product Code	Dimension*	Colour
03-001-00173	13cm	Black



GIESSER PRIME LINE Chef's Knife Wide Blade with Plastic Handle

Product Code	Dimension*	Colour
03-001-00070	20cm	Black
03-001-00071	20cm	Green
03-001-00072	20cm	Red
03-001-00073	23cm	Black



GIESSER FORGED Chef's Knife Forged Wide Blade & Wavy Edge with Pom Handle

Product Code	Dimension*	Colour
03-001-00026	25cm	Black

BEST CUT

Extremely sharp knives with ergonomic handles and extraordinary cutting-edge retention.

PRIME LINE

Perfect for any work in the meat processing and catering industries.

*Dimension refer to the blade length only

GIESSER FORGED *Chef's Knife Forged Wide Blade with Pom Handle*

Dimension*	Black	Blue	Yellow	Green	Red
15cm	03-001-00008				
18cm	03-001-00009				
20cm	03-001-00010	03-001-00011	03-001-00012	03-001-00013	03-001-00014
23cm	03-001-00015	03-001-00016	03-001-00017	03-001-00018	03-001-00019
25cm	03-001-00020	03-001-00021	03-001-00022	03-001-00023	03-001-00024
30cm	03-001-00025				

GIESSER *Chef's Knife with Wide Blade*

Dimension*	20cm	26cm	31cm
Wooden Handle	03-001-00067	03-001-00068	03-001-00069
Pom Handle	03-001-00062	03-001-00063	03-001-00064

GIESSER *Chef's Knife with Wide Blade and Plastic Handle*

Dimension*	Black	Blue	Brown	Yellow	Green	Red	White	Violet
16cm	03-001-00078	03-001-00079	03-001-00080	03-001-00081	03-001-00082	03-001-00083	03-001-00084	
20cm	03-001-00085	03-001-00086	03-001-00087	03-001-00088	03-001-00089	03-001-00090	03-001-00091	03-001-00661
23cm	03-001-00092	03-001-00093	03-001-00094	03-001-00095	03-001-00096	03-001-00097	03-001-00098	
26cm	03-001-00099	03-001-00100	03-001-00101	03-001-00102	03-001-00103	03-001-00104	03-001-00105	03-001-00662
31cm	03-001-00106	03-001-00107	03-001-00108	03-001-00109	03-001-00110	03-001-00111	03-001-00112	
31cm (wavy edge)	03-001-00113	03-001-00114		03-001-00115	03-001-00116	03-001-00117	03-001-00118	

GIESSER BEST CUT *Chef's Knife with Black Plastic Handle*

Product Code	Dimension*	Blade
03-001-00001	20cm	Forged
03-001-00002	23cm	Forged
03-001-00003	25cm	Forged
03-001-00004	20cm	Wavy Edge
03-001-00005	25cm	Wavy Edge

GIESSER BEST CUT *Chef's Knife with Plastic Narrow Handle*

Product Code	Dimension*
03-001-00006	18cm
03-001-00007	20cm

GIESSER PRIME LINE *Cook's Knife Narrow with Plastic Handle*

Product Code	Dimension*
03-001-00074	16cm
03-001-00075	18cm

*Dimension refer to the blade length only



Narrow Forged Blade



Serrated Forged Blade

GIESSER FORGED *Cook's Knife with Pom Handle*

Blade	Dimension*	Black	Blue	Yellow	Green	Red
Narrow Forged Blade	15cm	03-001-00027				
	18cm	03-001-00028	03-001-00029	03-001-00030	03-001-00031	03-001-00032
	20cm	03-001-00033	03-001-00034	03-001-00035	03-001-00036	03-001-00037
	23cm	03-001-00038				
	25cm	03-001-00039	03-001-00040		03-001-00041	03-001-00042
Serrated Forged Blade	25cm	03-001-00043				

**GIESSER** *Cook's Knife with Narrow Blade and Plastic Handle*

Dimension*	Black	Blue	Green	Red	Brown	White	Violet
16cm	03-001-00119	03-001-00120	03-001-00121	03-001-00122	03-001-00664	03-001-00665	03-001-00663
18cm	03-001-00123	03-001-00124	03-001-00125	03-001-00126			
20cm	03-001-00127	03-001-00129	03-001-00129	03-001-00130			
23cm	03-001-00131						

**GIESSER** *Steak Knife with Narrow Blade and Plastic Handle*

Dimension*	Black	Blue	Yellow	Green	Red
21cm	03-001-00174	03-001-00175	03-001-00176		03-001-00177
24cm	03-001-00178	03-001-00179	03-001-00180	03-001-00181	03-001-00182
27cm	03-001-00183	03-001-00184	03-001-00185	03-001-00186	03-001-00187
30cm	03-001-00188	03-001-00189	03-001-00190	03-001-00191	03-001-00192

**GIESSER** *Steak Knife with Scalloped Blade*

Product Code	Dimension*
03-001-00668	11cm

**GIESSER** *Steak Knife with Scalloped Blade and Wavy Edge*

Product Code	Dimension*
03-001-00669	11cm Wavy Edge

**GIESSER** *Steak Knife with Scalloped Blade and Plastic Handle*

Product Code	Dimension*
03-001-00193	21cm
03-001-00194	24cm

*Dimension refer to the blade length only



Classic Blade



Wide Blade



Wide & Curved Blade

GIESSER Boning Knife with Plastic Handle

Blade	Dimension*	Black	Blue	Yellow	Green	Red	White
Classic Blade	13cm	03-001-00410	03-001-00411	03-001-00412	03-001-00413	03-001-00414	03-001-00415
	16cm	03-001-00416	03-001-00417	03-001-00418	03-001-00419	03-001-00420	03-001-00421
	18cm	03-001-00422					
	21cm	03-001-00423					
Wide Blade	14cm	03-001-00437	03-001-00438	03-001-00439		03-001-00440	
	16cm	03-001-00441	03-001-00442	03-001-00443	03-001-00444	03-001-00445	
	18cm	03-001-00446		03-001-00447	03-001-00655		
Wide & Curved Blade	15cm	03-001-00434	03-001-00435			03-001-00436	

**GIESSER Boning Knife with Stiff Blade and Plastic Handle**

Dimension*	Black	Green	Red	Yellow
13cm	03-001-00426	03-001-00428	03-001-00429	03-001-00427
15cm	03-001-00430	03-001-00431	03-001-00433	03-001-00432

**GIESSER PRIME LINE Boning Knife with Stiff Blade and Plastic Handle**

Product Code	Dimension*
03-001-00409	15cm

**GIESSER Boning Knife with Pom Handle**

Product Code	Dimension*
03-001-00408	13cm

**GIESSER BEST CUT Boning Knife**

Product Code	Dimension*
03-001-00653	15cm

**GIESSER Boning Knife with Medium Blade and Plastic Handle**

Product Code	Dimension*	Colour
03-001-00425	15cm	Red
03-001-00424	15cm	Yellow



Classic Blade



Pointed Tip



Prime Line

GIESSER Sticking Knife with Plastic Handle

Blade	Dimension*	Black	Blue	Yellow	Green	Red	White
Classic Blade	13cm	03-001-00487	03-001-00488	03-001-00489		03-001-00490	03-001-00491
	16cm	03-001-00492	03-001-00493	03-001-00494	03-001-00495	03-001-00496	03-001-00497
	18cm	03-001-00498	03-001-00499	03-001-00500	03-001-00501	03-001-00502	03-001-00503
	21cm	03-001-00504					03-001-00505
	24cm	03-001-00506			03-001-00510		
	30cm	03-001-00507					
Pointed Tip	22cm				03-001-00508	03-001-00509	
Prime Line	18cm	03-001-00486					

*Dimension refer to the blade length only



Classic Blade



Scalloped Blade

GIESSER Butcher Knife Narrow Shape with Plastic Handle

Blade	Dimension*	Black	Blue	Yellow	Green	Red	White
Classic Blade	18cm	03-001-00451	03-001-00452	03-001-00453	03-001-00454	03-001-00455	03-001-00456
	21cm	03-001-00457	03-001-00458	03-001-00459	03-001-00460	03-001-00461	03-001-00462
	24cm	03-001-00463	03-001-00468	03-001-00464	03-001-00465	03-001-00466	03-001-00467
	27cm	03-001-00469	03-001-00470	03-001-00471		03-001-00472	
	30cm	03-001-00473		03-001-00474			
	32cm	03-001-00475					
Scalloped Blade	21cm	03-001-00477					
	24cm	03-001-00478					



GIESSER Bone Splitter with Wide Heavy Forged Blade and Pom Handle

Product Code	Dimension*
03-001-00450	25cm



GIESSER Filleting Knife with Forged Blade and Pom Handle

Product Code	Dimension*	Colour
03-001-00513	18cm	Blue
03-001-00514	18cm	Green
03-001-00515	18cm	Red
03-001-00512	18cm	Black



GIESSER PRIME LINE Filleting Knife with Plastic Handle

Product Code	Dimension*
03-001-00517	16cm



GIESSER Filleting Knife with Narrow and Flexible Blade and Plastic Handle

Dimension*	Black	Blue	Red	Yellow
18cm	03-001-00518	03-001-00519	03-001-00521	03-001-00520
20cm	03-001-00522	03-001-00523	03-001-00525	03-001-00524
22cm	03-001-00526			03-001-00527



GIESSER BEST CUT Filleting Knife with Plastic Handle

Product Code	Dimension*
03-001-00511	18cm



GIESSER Salmon Knife with Plastic Handle

Product Code	Dimension*	Colour
03-001-00536 (scalloped blade)	31cm	Blue
03-001-00535 (scalloped blade)	31cm	Black
03-001-00534	31cm	Black



GIESSER Salmon Knife with Scalloped Blade and Pom Handle

Product Code	Dimension*
03-001-00532	31cm



GIESSER POM Salmon Slicer with Pom Handle

Product Code	Dimension*
03-001-00533	31cm

*Dimension refer to the blade length only



02-003-00701

03-003-00022



GIESSER Fish Fin Shears

Product Code	Dimension
03-002-00330	26cm

GIESSER Fish Pincer

Product Code	Dimension
02-003-00701	18cm
03-003-00022	13cm

GIESSER Fish Scaler

Product Code	Dimension
03-002-00334	28cm



GIESSER PRIME LINE Ham Slicer with Wavy Edge and Plastic Handle

Product Code	Dimension*
03-001-00300	25cm
03-001-00301	31cm

GIESSER Ham Knife with Wavy Edge and Plastic Handle

Product Code	Dimension*
03-001-00376	28cm

GIESSER Ham Knife with Plastic Handle

Product Code	Dimension*
03-001-00375	28cm



GIESSER Ham Knife

Product Code	Dimension*	Type
03-001-00295	25cm	Wooden Handle
03-001-00296	31cm	Wooden Handle
03-001-00291	25cm	Pom Handle
03-001-00292	20cm	Serrated Edge, Pom Handle

GIESSER Ham Slicer

Product Code	Dimension*	Type
03-001-00297	25cm	Wooden Handle
03-001-00298	31cm	Wooden Handle
03-001-00299	36cm	Wooden Handle
03-001-00293	28cm	Pom Handle
03-001-00294	28cm	Wavy Edge, Pom Hdle

GIESSER Salami Slicer with Plastic Handle

Product Code	Dimension*	Colour
03-001-00402	28cm	Yellow
03-001-00403	30cm	Black
03-001-00404	28cm	Yellow
03-001-00405 (Wavy Edge)	28cm	Black



Serrated Edge & Pointed Tip



Pointed Tip

GIESSER Ham Knife with Plastic Handle

Blade	Dimension*	Black	Blue	Yellow	Red
Serrated Edge & Pointed Tip	21cm	03-001-00317			
	25cm	03-001-00318		03-001-00319	
	28cm	03-001-00320		03-001-00321	
	31cm	03-001-00322		03-001-00323	
Pointed Tip	21cm	03-001-00302	03-001-00303	03-001-00304	03-001-00305
	25cm	03-001-00306	03-001-00307	03-001-00308	03-001-00309
	28cm	03-001-00310	03-001-00311	03-001-00312	03-001-00313
	31cm	03-001-00314		03-001-00315	03-001-00316

*Dimension refer to the blade length only



Classic Blade



Partly Serrated Edge



Serrated Edge

GIESSER Ham Slicer with Plastic Handle

Blade	Dimension*	Black	Blue	Brown	Yellow	Green	Red	White	Violet
Classic Blade	25cm	03-001-00324	03-001-00325		03-001-00326	03-001-00327	03-001-00328		
	28cm	03-001-00329	03-001-00330		03-001-00331	03-001-00332	03-001-00333	03-001-00334	
	31cm	03-001-00335	03-001-00336		03-001-00337	03-001-00338	03-001-00339	03-001-00340	
	36cm	03-001-00341							
Partly Serrated Edge	25cm	03-001-00342	03-001-00343		03-001-00344		03-001-00345		
	28cm	03-001-00346	03-001-00347		03-001-00348		03-001-00349		
	31cm	03-001-00350	03-001-00351		03-001-00352		03-001-00287	03-001-00288	
Serrated Edge	25cm	03-001-00353	03-001-00354	03-001-00355	03-001-00356	03-001-00284	03-001-00357	03-001-00285	
	28cm	03-001-00358	03-001-00359		03-001-00360	03-001-00361	03-001-00362	03-001-00363	
	31cm	03-001-00364	03-001-00365	03-001-00366	03-001-00367	03-001-00368	03-001-00369	03-001-00289	03-001-00656
	36cm	03-001-00370							

**GIESSER Ham Slicer with Scalloped Blade**

Product Code	Dimension*
03-001-00371	25cm
03-001-00372	28cm
03-001-00373	31cm
03-001-00374	36cm

**GIESSER Carving Slicer with Plastic Handle**

Product Code	Dimension*	Colour
03-001-00670	21cm	Black
03-001-00672	21cm	Yellow
03-001-00673	21cm	Blue
03-001-00671	25cm	Black

**GIESSER BEST CUT Ham Slicer with Forged Blade and Plastic Handle**

Product Code	Dimension*
03-001-00279	15cm
03-001-00280	20cm
03-001-00281	25cm



Classic Blade



Serrated Edge



Wavy Edge

GIESSER Bread Knife with Plastic Handle

Blade	Dimension*	Black	Blue	Yellow	Red	White
Classic Blade	18cm	03-001-00549				
	21cm	03-001-00550				
	24cm	03-001-00551				
Serrated Edge	18cm	03-001-00552				
	21cm	03-001-00553	03-001-00554	03-001-00555	03-001-00556	03-001-00557
	24cm	03-001-00558				
Wavy Edge	24cm					03-001-00559

**GIESSER Bread Knife with Pom Handle**

Product Code	Dimension*	
03-001-00545	18cm	
03-001-00546	21cm	
03-001-00547	24cm	
03-001-00542	18cm	Wavy Edge
03-001-00543	21cm	Wavy Edge
03-001-00544	24cm	Wavy Edge

**GIESSER Bread Knife with Distance Device Wavy Edge**

Product Code	Dimension*
03-001-00658	21cm
03-001-00659	25cm

**GIESSER PRIME LINE Bread Knife with Wavy Edge and Plastic Handle**

Product Code	Dimension*
03-001-00548	21cm

*Dimension refer to the blade length only



GIESSER Bread Knife with Serrated Edge and PAG Handle

Product Code	Dimension*
03-001-00537	20cm



GIESSER Bread Knife with Serrated Edge and Plastic Handle

Product Code	Dimension*	Colour
03-001-00657	21cm	Violet



GIESSER Offset Bread Knife with Wavy Edge and Plastic Handle

Product Code	Dimension*
03-001-00560	18cm



Wavy Edge



Serrated Edge



Plain & Wavy Edge



Double Edge



Wavy & Serrated Edge



Plain & Serrated Edge

GIESSER Baker's Knife with Plastic Handle

Dimension*	Wavy Edge	Serrated Edge	Double Edge	Plain & Wavy Edge	Wavy & Serrated Edge	Plain & Serrated Edge
26cm			03-001-00569	03-001-00572	03-001-00578	03-001-00575
30cm	03-001-00567	03-001-00568	03-001-00570	03-001-00573	03-001-00579	03-001-00577
36cm			03-001-00571	03-001-00574	03-001-00580	03-001-00576



GIESSER Baker's Knife with Single Edge & Plastic Handle

Product Code	Dimension*	Colour
03-001-00565	30cm	Black
03-001-00566	30cm	White



GIESSER Cheese Knife with Plastic Handle

Product Code	Dimension*
03-001-00606	15cm



GIESSER Cheese Knife with Scalloped Blade and 2 Plastic Handles

Product Code	Dimension*
03-001-00597	26cm
03-001-00598	30cm



GIESSER Parmesan Knife with Nylon Handle

Product Code	Dimension*
03-001-00605	11cm



GIESSER Soft Cheese Knife with Plastic Handle

Product Code	Dimension*
03-001-00594	15cm



GIESSER Cheese Shovel with Plastic Handle

Product Code	Dimension*
03-001-00599	15cm

*Dimension refer to the blade length only



GIESSER *Parmesan Knife with Nylon Handle*

Product Code	Dimension
03-001-00602	23cm
03-001-00603	23cm; Wire for Cheese Cutter. Set of 5pcs.



GIESSER *Cheese Wire*

Product Code	Dimension
03-001-00604	65cm



GIESSER *Stainless Steel Bone Saw with Plastic Handle*

Product Code	Dimension
03-001-00621	50cm
03-001-00622	50cm; Accessory Saw Blade for S/S Bone Saw



GIESSER *Bone / Dust Remover*

Product Code	Dimension
03-001-00205	20cm



GIESSER *Tomato Peeler*

Product Code	Dimension
03-002-00199	19cm



GIESSER *Grapefruit Knife with Plastic Handle*

Product Code	Dimension*
03-002-00201	6cm

You can find all the high quality knives and tools you need from Atlantic Chef.



**Atlantic[®]
Chef**



www.atlanticchef.com

SANTOPRENE® RANGE

Santoprene® is a registered trademark of Advanced Elastomer, L.P. The Atlantic Chef made handles of Santoprene® offer nonslip ergonomic grip, maximum control and unsurpassed degree of comfort.

POM RANGE

Atlantic Chef POM Handles are over moulded for tough use and hygienic purpose (by Derlin® at DuPont®) feature high stiffness and high heat deflection temperature to ensure the quality of food process.

SANTOPRENE® & POLYPROPYLENE RANGE

The Atlantic Chef made revolutionary handles with the combination of Santoprene® and polypropylene that offer a non-slip comfortable grip and tough use.



Pom



Santoprene

ATLANTIC CHEF Forged Curved Paring Knife

Handle	Product Code	Dimension*
Pom	03-001-00223	8cm
Santoprene	03-001-00225	8cm



Pom



Santoprene

ATLANTIC CHEF Forged Paring Knife

Handle	Product Code	Dimension*
Pom	03-001-00222	8cm
Santoprene	03-001-00224	8cm



ATLANTIC CHEF Paring Knife with Serrated Edge

Handle	Product Code	Dimension*
Santoprene & Pom	03-001-00265	8cm



ATLANTIC CHEF Tomato Knife

Handle	Product Code	Dimension*
Pom	03-003-00023	14cm



Pom



Santoprene



Santoprene & Pom

ATLANTIC CHEF Forged Utility / Kitchen Knife

Handle	Product Code	Dimension*
Pom	03-001-00171	14cm
Santoprene	03-001-00172	13cm
Santoprene & Pom	03-001-00202	15cm



Pom



Santoprene

ATLANTIC CHEF Forged Chef Knife

Handle	Product Code	Dimension*
Pom	03-001-00044	15cm
	03-001-00045	21cm
	03-001-00046	23cm
	03-001-00047	25cm
Santoprene	03-001-00048	15cm
	03-001-00049	21cm
	03-001-00050	23cm
	03-001-00051	25cm

*Dimension refer to the blade length only



ATLANTIC CHEF Chef Knife with Plastic Handle

Blade	Dimension*	Black	Blue	Brown	Yellow	Green	Red	White
Santoprene & Pom	15cm	03-001-00132	03-001-00133	03-001-00134	03-001-00138	03-001-00135	03-001-00136	03-001-00137
	21cm	03-001-00139	03-001-00140		03-001-00143	03-001-00141	03-001-00142	03-001-00675
	23cm	03-001-00149	03-001-00150	03-001-00151	03-001-00155	03-001-00152	03-001-00153	03-001-00154
	25cm	03-001-00156	03-001-00157		03-001-00160	03-001-00158	03-001-00159	03-001-00666
	30cm	03-001-00161	03-001-00162		03-001-00165	03-001-00163	03-001-00164	03-001-00667



ATLANTIC CHEF PREMIUM Forged Boning Knife

Handle	Product Code	Dimension*
Pom	03-001-00407	15cm



ATLANTIC CHEF Curved Boning Knife

Handle	Product Code	Dimension*
Santoprene & Pom	03-001-00449	15cm



ATLANTIC CHEF Stiff Boning Knife

Handle	Product Code	Dimension*	Colour
Santoprene & Pom	03-001-00448	15cm	Black
	03-001-00680	15cm	Red



ATLANTIC CHEF Forged Fillet Knife

Handle	Product Code	Dimension*
Pom	03-001-00516	18cm



ATLANTIC CHEF Flexible Fillet Knife with Plastic Handle

Handle	Product Code	Dimension*
Santoprene & Pom	03-001-00530	18cm
	03-001-00531	21cm



ATLANTIC CHEF Ham Slicer (Plain Edge and without Kullen)

Handle	Product Code	Dimension*
Pom	03-001-00679	28cm



ATLANTIC CHEF Serrated Ham Slicer with Plastic Handle

Handle	Product Code	Dimension*	Colour
Santoprene & Pom	03-001-00378	28cm	Black
	03-001-00379	28cm	White
	03-001-00380	36cm	Black



ATLANTIC CHEF Scalloped Ham Slicer with Plastic Handle

Handle	Product Code	Dimension*
Santoprene & Pom	03-001-00377	28cm



*Dimension refer to the blade length only



ATLANTIC CHEF Slicing Knife with Serrated Edge

Handle	Product Code	Dimension*
Santoprene & Pom	03-001-00381	30cm



Pom



Santoprene

ATLANTIC CHEF Forged Carving Knife

Handle	Product Code	Dimension*
Pom	03-001-00677	21cm
	03-001-00678	25cm
Santoprene	03-001-00675	21cm
	03-001-00676	25cm



Pom



Santoprene

ATLANTIC CHEF Forged Bread Knife

Handle	Product Code	Dimension*	
Pom	03-001-00538	21cm	Serrated
	03-001-00539	23cm	Serrated
Santoprene	03-001-00541	25cm	



ATLANTIC CHEF Serrated Bread Knife with Plastic Handle

Handle	Product Code	Dimension*	Colour
Santoprene & Pom	03-001-00561	21cm	Black
	03-001-00562	21cm	White
	03-001-00563	25cm	Black



ATLANTIC CHEF Offset Bread Knife

Handle	Product Code	Dimension*
Pom	03-001-00564	21cm



Pom



Santoprene



Santoprene & Pom

ATLANTIC CHEF Forged Usaba Knife

Handle	Product Code	Dimension*
Santoprene	03-002-00007	18cm



ATLANTIC CHEF Forged Santoku Knife

Handle	Product Code	Dimension*
Pom	03-002-00001	18cm
Santoprene	03-002-00004	18cm
Santoprene & Pom	03-002-00706	18cm



ATLANTIC CHEF Usaba Knife with Plastic Handle

Handle	Product Code	Dimension*
Santoprene & Pom	03-002-00009	18cm

*Dimension refer to the blade length only



GIESSER Cleaver with Plastic Handle

Product Code	Dimension*	Weight
03-001-00651	15 x 29cm	400g
03-001-00610	18 x 38cm	550g
03-001-00611	20 x 31cm	650g



GIESSER Cleaver with Pom Handle

Product Code	Dimension*	Weight
03-001-00650	15x29cm	500g



ATLANTIC CHEF Stainless Steel Bone Knife with Plastic Handle

Product Code	Dimension*	Colour
03-002-00036	22 x 10.3cm	Yellow
03-002-00037	22 x 10.3cm	Red
03-002-00038	22 x 10.3cm	Black



ATLANTIC CHEF Stainless Steel Dim Sum Knife with Plastic Handle

Product Code	Dimension*
03-002-00154	20 x 8.5cm



ATLANTIC CHEF Stainless Steel Kow Kong Knife with Plastic Handle

Product Code	Dimension*	Colour
03-002-00103	18 x 11.5cm	Black
03-002-00104	18 x 11.5cm	Brown
03-002-00105	18 x 11.5cm	Red
03-002-00106	18 x 11.5cm	Yellow



ATLANTIC CHEF Stainless Steel Mun Mo Knife with Plastic Handle

Product Code	Dimension*
03-002-00068	22 x 10.7cm



ATLANTIC CHEF Stainless Steel Mun Mo / Kitchen Knife with Plastic Handle

Dimension*	Black	Blue	Red	Yellow
20 x 8.5cm	03-002-00064	03-002-00065	03-002-00066	03-002-00067
21.5 x 11.4cm	03-002-00060	03-002-00061	03-002-00062	03-002-00063



ATLANTIC CHEF Stainless Steel Shanghai Slicing Knife

Product Code	Dimension*
03-002-00133	22 x 10.7cm



ATLANTIC CHEF Stainless Steel Slicing Knife with Plastic Handle

Dimension*	Black	Blue	Green	Red	Yellow
20 x 8.5cm	03-002-00117	03-002-00118	03-002-00119	03-002-00120	03-002-00121
21.5 x 11.4cm	03-002-00116				



CCK Iron Bone Knife with Wooden Handle

Product Code	Dimension*
03-002-00028	Blade 23.5cm Size 1
03-002-00029	Blade 22.5cm Size 2



CCK Stainless Steel Bone Knife with Wooden Handle

Product Code	Dimension*
03-002-00030	Blade 22.5cm Size 2



CCK Stainless Steel Bone Knife with Stainless Steel Handle

Product Code	Dimension*	Size
03-002-00031	Blade 23.5cm	Size 1
03-002-00032	Blade 22.5cm	Size 2

*Dimension refer to the blade length only



CCK Stainless Steel Bone Knife with Plastic Handle

Product Code	Dimension*	Colour
03-002-00033	Blade 23.5cm Size 1	Black
03-002-00034	Blade 22.5cm Size 2	Black
03-002-00035	Blade 32.5cm Size 3	Red



CCK Stainless Steel Small Bone Chopper with Wooden Handle

Product Code	Dimension*	Size
03-002-00039	Blade 20cm	Size 1
03-002-00040	Blade 18.5cm	Size 2
03-002-00041	Blade 17cm	Size 3



CCK Stainless Steel Small Bone Chopper with Stainless Steel Handle

Product Code	Dimension*	Size
03-002-00042	Blade 20cm	Size 1
03-002-00043	Blade 18.5cm	Size 2
03-002-00044	Blade 17cm	Size 3



CCK Stainless Steel Bone Chopper with Plastic Handle

Product Code	Dimension*	Colour
03-002-00045	Blade 20cm Size 1	Black
03-002-00046	Blade 19cm Size 2	Black
03-002-00047	Blade 17cm Size 3	Black



CCK Iron Mun Mo (Wen Wu) Knife with Wooden Handle

Product Code	Dimension*	Size
03-002-00048	Blade 24cm	Size 1
03-002-00049	Blade 23cm	Size 2
03-002-00050(XX)	Size 3	Size 3



CCK Stainless Steel Mun Mo (Wen Wu) Knife with Wooden Handle

Product Code	Dimension*	Size
03-002-00051	Blade 23cm	Size 2
03-002-00052	Blade 22cm	Size 3



CCK Stainless Steel Mun Mo (Wen Wu) Knife with Plastic Handle

Dimension*	Size	Black	Blue	Green	Red	Yellow	White
Blade 23cm	Size 2	03-002-00054	03-002-00053	03-002-00055	03-002-00056	03-002-00058	03-002-00057



CCK Stainless Steel Siew Lap Knife with Wooden Handle

Product Code	Dimension*	Size
03-002-00069	Blade 24cm	Size 2
03-002-00070	Blade 23.5cm	Size 3



CCK Stainless Steel Siew Lap Knife with Plastic Handle

Product Code	Dimension*	Colour
03-002-00071	Blade 24cm Size 2	Black



CCK Iron Kow Kong Knife with Wooden Handle

Product Code	Dimension*	Size
03-002-00072	Blade 20cm	Size XL
03-002-00073	Blade 18.5cm	Size 1
03-002-00074	Blade 17.5cm	Size 2



Iron Kow Kong Knife with Wooden Handle

Product Code	Dimension*	Size
03-002-00109	Blade 18.7cm	Size 1
03-002-00110	Blade 17.6cm	Size 3



CCK Stainless Steel Kow Kong Knife with Wooden Handle

Product Code	Dimension*	Size
03-002-00077	Blade 20cm	Size XL
03-002-00078	Blade 18.5cm	Size 1
03-002-00079	Blade 17.5cm	Size 2



Stainless Steel Kow Kong Knife with Wooden Handle

Product Code	Dimension*	Size
03-002-00111	Blade 18.9cm	Size 1
03-002-00112	Blade 17.6cm	Size 2
03-002-00113	Blade 17cm	Size 3

*Dimension refer to the blade length only

CCK Stainless Steel Kow Kong Knife with Plastic Handle

Dimension*	Size	Black	Blue	Green	Red	Yellow	White
Blade 20cm	Size XL	03-002-00089	03-002-00088		03-002-00090		03-002-00091
Blade 18.5cm	Size 1	03-002-00093	03-002-00092	03-002-00094	03-002-00095		03-002-00096
Blade 17.5cm	Size 2	03-002-00098	03-002-00097	03-002-00099	03-002-00100	03-002-00102	03-002-0101

CCK Stainless Steel Kow Kong Knife with Stainless Steel Handle

Product Code	Dimension*	Size
03-002-00083	Blade 20cm	Size XL
03-002-00084	Blade 18.5cm	Size 1
03-002-00085	Blade 17.5cm	Size 2

Stainless Steel Kow Kong Knife with Stainless Steel Handle

Product Code	Dimension*	Size
03-002-00086	Blade 18.9cm	Size 1
03-002-00087	Blade 17.6cm	Size 2

CCK Iron Slicing Knife with Wooden Handle

Product Code	Dimension*	Size
03-002-00162	Blade 21.5cm	Size 2

CCK Stainless Steel Slicing Knife with Plastic Handle

Product Code	Dimension*	Colour
03-002-00114	Blade 23.7cm Size 2	White
03-002-00115	Blade 23cm Size 3	Green

CCK Stainless Steel Slicing Knife with Wooden Handle

Product Code	Dimension*	Size
03-002-00163	Blade 21.5cm	Size 2
03-002-00164	Blade 22.5cm	Size 3

SHI BA ZI Stainless Steel Cleaver

Product Code	Dimension*
03-002-00122	Blade 19.5cm
03-002-00123	Blade 18.5cm

CCK Stainless Steel Small Slicing Knife with Wooden Handle

Product Code	Dimension*	Size
03-002-00165	Blade 20.5cm	Size 1
03-002-00166	Blade 20cm	Size 2

CCK Stainless Steel Slicing Knife with Stainless Steel Handle

Product Code	Dimension*	Size
03-002-00167	Blade 21cm	Size XL
03-002-00168	Blade 20.1cm	Size 1
03-002-00169	Blade 20cm	Size 2

Stainless Steel Small Slicing Knife with Wooden Handle

Product Code	Dimension*	Size
03-002-00131	Blade 20.8cm	Size 2
03-002-00132	Blade 20.5cm	Size 3

CCK Stainless Steel Small Slicing Knife with Plastic Handle

Dimension*	Size	Black	Blue	Green	Red	Brown	White	Yellow
Blade 20cm	Size 2	03-002-00125	03-002-00124	03-002-00127	03-002-00128	03-002-00126	03-002-00129	03-002-00130

*Dimension refer to the blade length only



CCK Stainless Steel Vegetable Knife with Wooden Handle

Product Code	Dimension*	Size
03-002-00170	Blade 21cm	Size 1
03-002-00171	Blade 20.5cm	Size 2



CCK Stainless Steel Vegetable Knife with Stainless Steel Handle

Product Code	Dimension*	Size
03-002-00172	Blade 21cm	Size 1
03-002-00173	Blade 20.5cm	Size 2
03-002-00174	Blade 20cm	Size 3



Stainless Steel Vegetable Knife with Stainless Steel Handle

Product Code	Dimension*	Size
03-002-00138	Blade 19.8cm	Size 2
03-002-00139	Blade 19cm	Size 3



CCK Stainless Steel Vegetable Knife with Plastic Handle

Dimension*	Size	Black	Green	Red	White
Blade 21cm	Size 2	03-002-00134	03-002-00135	03-002-00136	03-002-00137



HAKKOH Stainless Steel Vegetable Chopper

Product Code	Dimension*
03-002-00141	L19.8cm
03-002-00140	L21.5cm



CCK Stainless Steel Duck Slicing Knife with Stainless Steel Handle

Product Code	Dimension*
03-002-00142	Blade 17cm
03-002-00143	Blade 21cm



CCK Stainless Steel Duck Slicing Knife with Stainless Steel Handle

Dimension*	Black	Green
Blade 17.7cm	03-002-00144	03-002-00145
Blade 20.3cm	03-002-00146	03-002-00147



CCK Stainless Steel Duck Slicing Knife with Wooden Handle

Product Code	Dimension*
03-002-00149	Blade 17cm
03-002-00150	Blade 21cm



CCK Stainless Steel Har Kow / Dim Sum Skin Knife with Wooden Handle

Product Code	Dimension*
03-002-00151	Blade 19.5cm Size 1



CCK Stainless Steel Har-Kow / Dim Sum Skin Knife with Plastic Handle

Product Code	Dimension*	Colour
03-002-00152	Blade 20cm Size 1	Brown



Stainless Steel Har-Kow / Dim Sum Skin Knife with Wooden Handle

Product Code	Dimension*	Size
03-002-00153	Blade 20cm	Size 1



CCK Iron Fish Chopper with Metal Handle

Product Code	Dimension*
03-002-00155	Blade 17cm Size 1



CCK Stainless Steel Fish Chopper with Stainless Steel Handle (1KT + 13 Tales)

Product Code	Dimension*
03-002-00156	Blade 29.5cm Size 1



CCK Iron Song Knife

Product Code	Dimension*
03-002-00159	Blade 20cm Size 3
03-002-00158	Blade 21cm Size 2
03-002-00157	Blade 23.5cm Size 1

*Dimension refer to the blade length only



CCK Iron Mao Knife with Wooden Handle

Product Code	Dimension*
03-002-00160	Blade 18.5cm Size 1



SHI BA ZI Stainless Steel Cleaver Knife

Product Code	Dimension*
03-002-00176	Blade 18 x 9cm



GIESSER Watermelon Knife with 2 Handles

Product Code	Dimension*	Colour
03-002-00219	35cm	Green



SHI BA ZI Stainless Steel Paring Knife

Product Code	Dimension*
03-001-00623	Blade 10cm



SHI BA ZI Stainless Steel Cleaver Knife

Product Code	Dimension	Size
03-002-00177	34 x 10cm	Size 1
03-002-00178	33 x 9.2cm	Size 2



SHI BA ZI Stainless Steel Slicer Knife

Product Code	Dimension	Size
03-002-00179	31.1 x 9cm	Size 3
03-002-00180	31 x 8cm	Size 4



GLOBAL Meat Chopper 440GR

Product Code	Dimension*
03-002-00699	16cm



GLOBAL Vegetable Knife

Product Code	Dimension*
03-001-00636	18cm
03-001-00646	14cm



GLOBAL Cook Knife

Product Code	Dimension*
03-001-00645	13cm
03-001-00633	20cm



GLOBAL Oriental Cook Knife

Product Code	Dimension*
03-001-00635	18cm



GLOBAL Kitchen Knife

Product Code	Dimension*
03-001-00644	16cm
03-001-00643	20cm



GLOBAL Utility Flexible Knife

Product Code	Dimension*
03-001-00647	15cm



GLOBAL Swedish Fillet Flexible

Product Code	Dimension*
03-001-00642	21cm



GLOBAL Meat / Fish Knife

Product Code	Dimension*
03-001-00641	18cm



GLOBAL Carving Knife

Product Code	Dimension*
03-001-00634	21cm

*Dimension refer to the blade length only

**GLOBAL Slicer**

Product Code	Dimension*
03-001-00637	18cm
03-001-00632	21cm

**GLOBAL Bread Knife**

Product Code	Dimension*
03-001-00640	22cm

**GLOBAL Yanagi Sashimi**

Product Code	Dimension*
03-002-00700	30cm

**GLOBAL Tako Sashimi**

Product Code	Dimension*
03-002-00701	30cm

**GLOBAL Santoku Knife**

Product Code	Dimension*
03-002-00702	18cm

**KIWI Stainless Steel Vegetable Knife**

Product Code	Dimension*
03-001-00270	4"
03-001-00271	5"
03-001-00272	6"

**HAKKOH Stainless Steel Vegetable Knife**

Product Code	Dimension*
03-001-00273	5"
03-001-00274	6"
03-001-00275	7"
03-001-00276	8"

**ATLANTIC CHEF Jap Garnishing Knife with Pom Handle**

Product Code	Dimension*
03-002-00025	9cm
03-002-00026	10cm
03-002-00027	12cm

**ATLANTIC CHEF Sashimi Knife with Wooden Handle**

Product Code	Dimension*
03-002-00012	24cm
03-002-00013	27cm
03-002-00014	30cm

**ATLANTIC CHEF Deba Knife with Wooden Handle**

Product Code	Dimension*
03-002-00020	10cm
03-002-00021	15cm

**GIESSER PRIME LINE Chef Santoku Knife with Antimicrobial Handle and Perforated Blade**

Product Code	Dimension*
03-001-00076	19cm

**GIESSER PRIME LINE Chef Santoku Knife with Antimicrobial Handle and Scalloped Blade**

Product Code	Dimension*
03-001-00077	18cm

**Teppanyaki Knife and Fork Set (2pcs/set)**

Product Code	Dimension*
03-002-00181	34.3 x 2.2cm 30 x 2.5cm

**GLOBAL Bent Carving Fork**

Product Code	Dimension*
14-001-00015	

**GIESSER Meat Fork with Curved Tines and Pom Handle**

Product Code	Dimension*
03-002-00707	15cm
03-002-00708	20cm

*Dimension refer to the blade length only



GIESSER Meat Fork

Product Code	Dimension
03-002-00709	18cm
03-002-00710	21cm



GIESSER Meat (Carving) Fork

Product Code	Dimension
03-002-00711	15cm



LACOR Stainless Steel 2-Way Egg Cutter

Product Code	Dimension
02-002-00497	15 x 10 x 3.7cm



LACOR Stainless Steel Egg Slicer

Product Code	Dimension
02-002-00496	Ø10cm



WESTMARK Aluminium Coated Egg Slicer

Product Code	Dimension
03-002-00205	14.6 x 8cm



WESTMARK Aluminium Coated Egg Cutter

Product Code	Dimension
03-002-00206	18.8cm 6 segments



L.TELLIER Stainless Steel Mini Guitare

Product Code	Dimension
03-002-00208(XX)	45 x 23 x 14cm



Stainless Steel Egg Slicer

Product Code
03-002-00210



GIESSER Vegetable Peeler with Plastic Handle

Product Code
03-002-00183



GIESSER Swivel Peeler with Plastic Handle

Product Code
03-002-00212



Plastic Vegetable Swivel Peeler

Product Code
03-002-00184



MICROPLANE Spiral Cutter

Product Code	Colour
03-002-00213	Black
03-002-00214	Green



CCK Stainless Steel Peeler with Wooden Handle

Product Code	Dimension
03-002-00185	Handle 6"



CULINARE Y-Shape Safety Peeler

Product Code
03-002-00186



ZYLISS Swivel Peeler

Product Code
03-002-00189



ZYLISS Tomato Peeler

Product Code	Remarks
03-002-00190	Serrated Blade



KISAG Stainless Steel U-Shape Peeler

Product Code	Remarks
03-002-00195	Stainless Steel
03-002-00196	Plastic



KIWI Stainless Steel Peeler with Orange Handle

Product Code	Dimension
03-002-00193	Small



KIWI Stainless Steel Peeler with Knife and Orange Handle

Product Code	Dimension
03-002-00194	18.2cm



ECONOMY U-Shape Plastic Peeler

Product Code	Dimension
03-002-00198	12.1cm



GIESSER Tomato Peeler

Product Code	Dimension
03-002-00199	19cm



GIESSER Julienne Slicer

Product Code	Dimension
03-002-00211	Cut 3mm



L.TELLIER Stainless Steel Scallop Blade Truffles Slicer

Product Code	Dimension
03-003-00015	18.5cm



WESTMARK Spiral Cutter / Deco Grater

Product Code	Dimension
03-002-00215	14.5cm



GIESSER Potato Spiral

Product Code	Dimension
03-002-00216	24cm



L.TELLIER Turn Up

Product Code	Dimension	Model
03-002-00270	5cm	TU01
03-002-00271	4cm	TU02



L.TELLIER Garland Pin

Product Code	Dimension
03-002-00217	15.2 x 11.1cm



GIESSER Grapefruit Knife with Plastic Handle

Product Code	Dimension*
03-002-00201	20cm



GIESSER V-Cut Decorator with Plastic Handle

Product Code	Dimension*
03-002-00222	20.5cm



GIESSER Decorating Knife Forged Blade with PAG Handle

Product Code	Dimension*
03-002-00223	11cm

*Dimension refer to the blade length only



WESTMARK *Stainless Steel Crinkle Cutter*

Product Code	Dimension	Colour
03-002-00224	21cm	Black



WESTMARK *Gherkin Decorator (7 Blades)*

Product Code	Dimension	Colour
03-002-00225	16cm	Red



ATLANTIC CHEF *Potato Peeler*

Product Code
03-002-00202



ATLANTIC CHEF *Orange Peeler*

Product Code
03-002-00203



ATLANTIC CHEF *Lemon Decorator*

Product Code
03-002-00227



ATLANTIC CHEF *Butter Curler*

Product Code
03-002-00228



ATLANTIC CHEF *Apple Corer*

Product Code	Dimension
03-002-00273	Ø1.6cm



GIESSER *Apple Corer with Plastic Handle*

Product Code	Dimension
03-002-00272	Ø1.6cm



L.TELLIER *Pineapple Coring Tool*

Product Code	Dimension
03-002-00277	Ø2.8cm



WESTMARK *Stainless Steel Pineapple Slicer*

Product Code	Dimension
03-002-00221	25cm



DE BUYER *Stainless Steel Universal Corer*

Product Code	Dimension	Colour
03-002-00274	Ø1.3cm	Orange
03-002-00275	Ø2cm	Green
03-002-00276	Ø3cm	Red



WESTMARK *Apple Divider*

Cuts into 10pieces, and coring of the apple.

Product Code	Dimension
03-002-00281	17 x 11cm; Ø9cm



ATLANTIC CHEF *Twin Melon Baller*

Product Code	Dimension
03-002-00287	Ø2.2/2.5cm



ATLANTIC CHEF *Oval Melon Baller*

Product Code	Dimension
03-002-00289	2.8 x 1.7cm



ATLANTIC CHEF *Melon Baller*

Product Code	Dimension
03-002-00282	Ø1.2cm
03-002-00283	Ø1.5cm
03-002-00284	Ø2.2cm
03-002-00285	Ø2.5cm
03-002-00286	Ø3.0cm



GIESSER Oval Melon Baller with Plastic Handle

Product Code
03-002-00288



GIESSER Oval Melon Baller Wavy Edge with Plastic Handle

Product Code
03-002-00290



Stainless Steel Tomato Wiz / Corer

Product Code	Dimension
03-002-00278	4.1/2"



GIESSER Decorating Set

Product Code	
03-002-00232	7 pcs/set
03-002-00684	Empty Bag for Decorating Set



L. TELLIER Vegetable Carving Tool with Case

Product Code	
03-002-00229(XX)	Case pack 28pcs/set



L. TELLIER Vegetable Carving Tools & Whetstone Set

Product Code	
03-002-00230	Case pack 18pcs/set



GIESSER Shaping Knives

Product Code	
03-002-00231	Set of 8pcs



CCK Vegetable Carving / Decoration Knife

Product Code	
03-002-00233	Case pack 6pcs/set
03-002-00234	Case pack 6pcs/set
03-002-00235	Case pack 17pcs/set



GIESSER Oyster Opener / Knife with Pom Handle

Product Code
03-002-00291



ATLANTIC CHEF Oyster Opener / Knife

Product Code
03-002-00292



FISCHER Oyster Knife

Product Code
03-002-00294



Oyster Opener with Brown Bakelite Handle

Product Code
03-002-00295



Pizza Cutter

Product Code	Dimension
03-002-00297	Ø2"
03-002-00298	Ø4"
03-002-00299	Ø4" Wooden Handle



GIESSER Pizza Cutter with Plastic Handle

Product Code	Dimension
03-002-00296	Ø12cm



Stainless Steel Double Pastry Wheel with Plastic Handle

Product Code	Dimension
03-002-00301	Ø5.5cm



GIESSER Mincing Knife with Plastic Handle

Product Code	Dimension	
03-002-00306	15cm	Single
03-002-00304	15cm	Double
03-002-00307	22cm	Single
03-002-00305	22cm	Double
03-002-00308	36cm	Single



WESTMARK Spiral Cutter / Deco Grater

Scissors, shears, pliers & bone tweezers

Product Code	Dimension	Colour
03-002-00310	20cm	Green



GIESSER Universal Schere Scissor

Product Code	Dimension
03-002-00311	22cm



Stainless Steel Multi-Use Kitchen Scissors, Jpn

Product Code	Dimension
03-002-00312	20.5cm



SHI BA ZI Stainless Steel Kitchen Scissors

Product Code	Dimension
03-002-00313	19cm



ZHANG XIAO QUAN Powerful Stainless Steel Scissors with Black Handle

Product Code	Dimension
03-002-00314	20cm



EXCEL PARTNER Stainless Steel Kitchen Scissors, Jpn

Product Code	Dimension
03-002-00315	23cm



Stainless Steel Kitchen Scissors with Black Handle, Jpn

Product Code	Dimension
03-002-00316	23cm



Stainless Steel Kitchen Scissors, Jpn

Product Code	Dimension
03-002-00317	19.5cm



ATLANTIC CHEF Detachable Kitchen Scissors

Product Code	Dimension
03-002-00318	21cm



Stainless Steel Scissors with Plastic Handle

Product Code	Dimension
03-002-00320	21.5cm



GIESSER Stainless Steel Poultry Shear

Product Code	Dimension
03-002-00324	25.5cm



LACOR Stainless Steel Poultry Shears

Product Code	Dimension
03-002-00325	24cm



GLOBAL Kitchen Shears

Product Code	Dimension
03-003-00010	21cm



Universal Crab Scissors with Stick

Product Code	Dimension
03-002-00326	17cm



Crab Scissors with Purple Handle

Product Code	Dimension
03-002-00327	20.5cm



SILKY Crab Scissor

Product Code	Dimension
03-002-00328	21cm



IBILI Prawn Peeling Scissors

Product Code	Dimension
03-002-00329	18cm



GIESSER Fish Fin Shears

Product Code	Dimension
03-002-00330	26cm



CCK Iron Fish Plier

Product Code	Colour
03-002-00331(XX)	Black



WESTMARK Fish Bone Tweezer / Pincers

Product Code	Dimension
03-002-00332	14cm



Stainless Steel Heavy Duty Bone Tweezer Flat

Product Code	Dimension
03-002-00333	12 x 1.5cm



GIESSER Fish Scaler

Product Code	Dimension
03-002-00334	28cm



WESTMARK SCALEX Aluminium Coated Fish Scaler with Stainless Steel Blade

Product Code	Dimension
03-002-00335	20.5cm



Stainless Steel Heavy Duty Fish Scaler, Jpn

Product Code	Dimension
03-002-00336	20cm



Stainless Steel Fish Scaler

Product Code	Handle
03-002-00337	Stainless Steel Handle
03-002-00338	Wooden Handle



Copper Fish Scaler with Plastic Handle

Product Code	Dimension
03-002-00339	20cm



Plastic Fish Scaler

Product Code	Dimension
03-002-00340	Small
03-002-00341	Large

SHARPENING TOOLS



GIESSER *Sharpening Steel Round Standard Cut with Nylon Handle*

Dimension	Black	Blue	Brown	Yellow	Green	Red	White
25cm	03-002-00589	03-002-00590	03-002-00591	03-002-00592	03-002-00593	03-002-00594	03-002-00595
31cm	03-002-00596	03-002-00597		03-002-00598	03-002-00599	03-002-00600	03-002-00601



ATLANTIC CHEF *Sharpening Steel Round Standard Cut*

Dimension	Black	Blue	Brown	Yellow	Green	Red	White
25cm	03-002-00602						
31cm	03-002-00603	03-002-00604	03-002-00605	03-002-00609	03-002-00606	03-002-00607	03-002-00608



GIESSER *Sharpening Steel Oval Standard Cut with Nylon Handle*

Dimension	Black	Blue	Green	Red
31cm	03-002-00611	03-002-00612	03-002-00613	03-002-00614

GIESSER *Sharpening Steel Round Fine Cut with Nylon Handle*

Product Code	Dimension	Colour
03-002-00610	25cm	Black



GIESSER *Sharpening Steel Oval Fine Cut with Nylon Handle*

Product Code	Dimension	Colour
03-002-00615	31cm	Black

GIESSER *Sharpening Steel Oval Extra-Fine Cut with Nylon Handle*

Product Code	Dimension	Colour
03-002-00616	31cm	Black

GLOBAL *Diamond Steel Plastic Guard*

Product Code	Dimension
03-005-00005	30cm



GIESSER *Diamond Sharpening Machine*

Product Code	Dimension
03-002-00627(XX)	20.5 x 55.9 x 19.7cm

Elec. Specs. : 230V / 50Hz / 1.3A / 0.18kW
2500rpm. 2 Grinding Stations, 2 Polishing Stations

EDLUND *Electric Knife Sharpener*

Product Code	Model
03-002-00648	395 230V

CHEF'S CHOICE *Electric / Manual 3-Stage Diamond Knife Sharpener*

Product Code	Elec. Spec.
03-002-00632	230V / 50Hz / 44W

For Straight & Serrated Knives



CHEF'S CHOICE Electric Diamond Hone Sharpener 3 Stage with Stainless Steel Cover

3-stage commercial sharpener designed to sharpen both straight-edge and serrated knives. Stages 1 and 2 use 100% diamond abrasive disks and Stage 3 uses ultra-fine, proprietary stropping disks to create razor sharp, arch-shaped edges that stay sharp longer. Precision angle guides eliminate all guesswork and the detachable sharpening module is commercial dishwasher safe and replaceable. NSF certified.

Product Code	Elec. Spec.
03-002-00628	230V / 60Hz / 175W



CHEF'S CHOICE Electric Diamond Hone Sharpener Angle Select with White Cover 3 Stage

Designed to sharpen Asian, European and American style knives, you can restore and recreate both a 15 degree angle on your Asian style knives and a 20 degree angle on your European and American style cutlery. It will quickly and easily sharpen virtually all quality cutlery including American, European or Asian style household knives; fine edge or serrated blades; Santoku and traditional Japanese style single bevel edges, including the thicker Deba style blades; sports knives and pocket knives.

Product Code	Elec. Spec.
03-002-00629	230V / 50Hz / 75W



CHEF'S CHOICE Commercial Electric 2-Stage Diamond Knife Sharpener

This compact professional electric 2-stage knife sharpener sharpens both straight edge and serrated knives to better than factory edges, in just minutes. 2-stage sharpening provides "Gothic Arch" shaped edges which are stronger and longer lasting than hollow ground or conventional 'V' edges.

Product Code	Elec. Spec.
03-002-00630	230V / 50Hz / 75W



CHEF'S CHOICE Hybrid Sharpener (Manual / Electric) Sharpener 2 Stage

Effectively combines electric and manual advanced sharpening technology for an extremely sharp, burr-free edge with lots of bite. Using Chef's Choice signature 100% diamond abrasives in both stages, Stage 1 is electric for sharpening and Stage 2 is manual for honing and resharpening.

Product Code	Elec. Spec.
03-002-00631	230V / 50Hz / 40W



CHEF'S CHOICE Diamond Hone Knife Sharpener, 3 Stage

A perfect manual sharpener for those who own Asian and European/American style knives and want to quickly and easily apply a superior, shaving sharp edge! Sharpens all quality knives including straight edge household and kitchen knives, Santoku, sports and pocket knives, as well as serrated knives.

Product Code
03-002-00633



CHEF'S CHOICE Pronto Manual Diamond Hone Sharpener

Suitable for both straight and serrated edge knives. Uses 100% diamond abrasive wheels that sharpen simultaneously "into" and "out of" the knife edge for a superior burr-free edge with lots of bite.

Product Code
03-002-00634



CHEF'S CHOICE Manual Diamond Hone Knife Sharpener 3 Stage, Angle Select®, Pronto

Product Code
03-002-00635



CHEF'S CHOICE Manual Knife Sharpener, 2 Stage, Diamond Hone

Product Code
03-002-00637



LACOR Manual Knife Sharpener

Product Code
03-002-00639



GLOBAL Minisharp Plus 3 Water Sharpener

Product Code
03-005-00002



GLOBAL 2-in-1 Ceramic Whetstone with Holder

Product Code
03-005-00003



Japanese Red Sharpening Stone #110

Product Code	Dimension
03-002-00617	25 x 9 x 3.4cm



CCK Sharpening Stone

Product Code	Dimension
03-002-00619	20 x 7.5 x 5cm



CCK Sharpening Stone

Product Code	Type
03-002-00620	Extra Smooth



NANIWA Sharpening Stone GC#220 Coarse

Product Code
03-005-00006



NANIWA Sharpening Stone MicronDX #1000 Med

Product Code
03-005-00007



NANIWA Sharpening Stone #4000 Finishing

Product Code
03-005-00008



CARBORUNDUM Combination Sharpening Stone

Product Code	Dimension
03-002-00622	8 x 2 x 1"
03-002-00623	8 x 3 x 2"



SPIT FIRE Combination Sharpening Stone

Product Code	Dimension
03-002-00624	8 x 2 x 1"
03-002-00625	8 x 3 x 2"



CCK Wooden Stand for Sharpening Stone

Product Code	Dimension
03-002-00626	8 x 2 x 1"



Electric UV Knife Sterilizer

Product Code	Elec. Spec.
03-002-00642	220V



LACOR UV Knife Sterilizer

Product Code	Elec. Spec.
03-002-00640	11W 220-230V (For 10 Knives)
03-002-00641	15W 220-230V (For 20 Knives)



EDLUND Stainless Steel Knife Sanitizing System

Product Code	Type
03-002-00643(XX)	with Red Insert
03-002-00644(XX)	with Drain Tube



EDLUND Knife Rack with Skirt

Product Code	Dimension
03-002-00649	14" KR-700 S/S Back Plate
03-002-00650	12" KR-699 Open Back Plate



EDLUND Stainless Steel Knife Sanitizing Rack

Product Code	Dimension
03-002-00645	KSR-5000



EDLUND Locking Knife Cabinet with Keyed Locking Handle

Product Code	Dimension
03-002-00651	KLC994



ALEGACY Stainless Steel Knife Rack

Product Code	Dimension
03-002-00646	30 x 6.25 x 32cm



SAN JAMAR PC Knife Rack

Product Code	Dimension
03-002-00667	38 x 10.8 x 38cm



EDLUND Knife Rack with Skirt and Stainless Steel Insert for Model KR-50

Product Code	Dimension	Colour
03-002-00652	12"	Black
03-002-00653	12"	Red
03-002-00654	12"	Yellow
03-002-00655	12"	Green
03-002-00656	12"	Blue
03-002-00657	12"	Tan
03-002-00658	12"	White
03-002-00659(XX)		No Insert



EDLUND Knife Rack Molded Insert for Model KR-50 (6pcs/pkt)

Product Code	Colour
03-002-00660(XX)	Set of 6 colours
03-002-00661(XX)	Black
03-002-00662(XX)	Red
03-002-00663(XX)	Yellow
03-002-00664(XX)	Green
03-002-00665(XX)	Blue
03-002-00666(XX)	White



EDLUND Stainless Steel Knife Block KBS-2002

Product Code	Dimension
03-002-00668	12"



SAN JAMAR PC Knife Rack

Product Code	Dimension
03-002-00647	14.5 x 18.3 x 4"



GLOBAL 8-pc Knife Block

Product Code	Dimension
03-005-00004	H30.5cm



GIESSER PLC Knife Hygiene Boxes (For 4 Knives and 1 Steel Rod)

Dimension	Black	Blue	Yellow	Green	Red	White
50 x 26.5 x 10cm	03-002-00669	03-002-00670	03-002-00671	03-002-00672	03-002-00673	03-002-00674



CCK Stainless Steel Knife Box

Product Code	Dimension
03-002-00676	27 x 14.3 x 14cm 3 Slots
03-002-00677	31.5 x 18 x 14cm 4 Slots



Stainless Steel Knife Box

Product Code	Dimension
03-002-00678	Thickness 0.6mm 3 Slots
03-002-00679	Thickness 0.6mm 4 Slots



GIESSER Magnet Boarder

Product Code	Dimension
03-002-00680	35cm
03-002-00681	50cm



ATLANTIC CHEF Magnet Boarder

Product Code	Dimension
03-002-00682	35cm
03-002-00683	50cm



SAN JAMAR ALLERGEN SAF-T Zone System

Cutting Board, Knife, Tong, Turner in 1 Case Set

Product Code	Colour
03-002-00675	Purple



GIESSER Empty Knife Bag Roll

Product Code	Colour
03-002-00685	Red
03-002-00686	Blue



ATLANTIC CHEF Knife Bag

Product Code	Dimension	
03-002-00687	52 x 15 x 4cm	7 Slots
03-002-00688	47 x 16 x 4cm	8 Slots
03-002-00689	52 x 19 x 6cm	14 Slots
03-002-00690	50 x 23 x 10cm	Triple Zip



GIESSER Magnetic Knife Guard

Product Code	Dimension	
03-002-00691	26 x 5.6cm	1pcs/pkt
03-002-00692	23 x 3.3cm	1pcs/pkt
03-002-00693	15 x 2.3cm	1pcs/pkt



ATLANTIC CHEF Knife Guard

Product Code	Dimension
03-002-00694	1 x 4.5"
03-002-00695	2 x 11"
03-002-00696	2 x 8.5"
03-002-00697	1.5 x 10.5"
03-002-00698	1.5 x 6.5"



SAN JAMAR SAF-T-Grip Cutting Board

Dimension	Black	Blue	Brown	Yellow	Green	Red	White	Purple
6 x 9 x 3/8"	03-002-00361			03-002-00365	03-002-00362	03-002-00363	03-002-00364	03-002-00366
12 x 18 x 1/2"		03-002-00367	03-002-00368	03-002-00372	03-002-00369	03-002-00370	03-002-00371	03-002-00373



SAN JAMAR Cut-N-Carry Cutting Board with S-Hook

Dimension	Blue	Brown	Green	Red	White	Yellow
12 x 18 x 1/2"	03-002-00380	03-002-00381	03-002-00382	03-002-00383	03-002-00384	03-002-00385
15 x 20 x 1/2"	03-002-00386		03-002-00387	03-002-00388	03-002-00389	03-002-00390
18 x 24 x 3/4"		03-002-00391(XX)				

SAN JAMAR KATCHALL *Cut-N-Carry World Gourmet Cutting Board with S-Hook*

Dimension	Blue	Brown	Green	Red	White	Yellow
26.5 x 32.5 x 1.5cm	03-002-00398	03-002-00399	03-002-00400	03-002-00401	03-002-00402	03-002-00403
32.5 x 53 x 1.5cm	03-002-00392	03-002-00393	03-002-00394	03-002-00395	03-002-00396	03-002-00397

SAFICO *High Density PLC Cutting Board*

Dimension	Blue	Beige	Green	Red	White	Yellow
10 x 6 x ½"					03-002-00470	
13 x 10 x ½"	03-002-00465	03-002-00468	03-002-00466	03-002-00467	03-002-00464	03-002-00469
18 x 12 x ½"	03-002-00417	03-002-00420	03-002-00418	03-002-00419	03-002-00416	03-002-00421
18 x 12 x ¾"	03-002-00411	03-002-00414	03-002-00412	03-002-00413	03-002-00410	03-002-00415
18 x 12 x 1"	03-002-00405	03-002-00408	03-002-00406	03-002-00407	03-002-00404	03-002-00409
20 x 15 x ½"	03-002-00435	03-002-00438	03-002-00436	03-002-00437	03-002-00434	03-002-00439
20 x 15 x ¾"	03-002-00429	03-002-00432	03-002-00430	03-002-00431	03-002-00428	03-002-00433
20 x 15 x 1"	03-002-00423	03-002-00426	03-002-00424	03-002-00425	03-002-00422	03-002-00427
24 x 18 x ½"	03-002-00453	03-002-00456	03-002-00454	03-002-00455	03-002-00452	03-002-00457
24 x 18 x ¾"	03-002-00447	03-002-00450	03-002-00448	03-002-00449	03-002-00446	03-002-00451
24 x 18 x 1"	03-002-00441	03-002-00444	03-002-00442	03-002-00443	03-002-00440	03-002-00445
32.5 x 53 x 2cm	03-002-00459	03-002-00462	03-002-00460	03-002-00461	03-002-00458	03-002-00463

A-STAR *Plastic Rectangle Chopping Board*

Dimension	White	Blue	Green	Red	Yellow
24.7 x 15 x 0.9cm	03-002-00471				
30 x 20.7 x 1cm	03-002-00472				
35.4 x 25.2 x 1.2cm	03-002-00473	03-002-00474	03-002-00475	03-002-00476	03-002-00477
44 x 29 x 1.2cm	03-002-00478	03-002-00479	03-002-00480	03-002-00481	03-002-00482
50.5 x 34 x 1.4cm	03-002-00483	03-002-00484	03-002-00485	03-002-00486	03-002-00487

EPICUREAN GOURMET *Wooden Fibre Cutting Board (Heat resistant up to 176°C)*

Dimension	Natural	Slate
14.5 x 11.25 x ¾"	03-002-00493	03-002-00494
17.5 x 13 x ¾"	03-002-00495	03-002-00496
19.5 x 15 x ¾"	03-002-00497	03-002-00498

EPICUREAN KITCHEN *Wooden Fibre Cutting Board (Heat resistant up to 176°C)*

Dimension	Natural	Slate
8 x 6 x ¼"	03-002-00500	03-002-00501
12 x 9 x ¼"	03-002-00502	03-002-00503
15 x 11 x ¼"	03-002-00504	03-002-00505
18 x 13 x ¼"	03-002-00506	03-002-00507



ALEGACY High Density Poly Slab / Cutting Board

Product Code	Dimension	Colour
03-002-00488	96 x 48 x 1"	White
03-002-00489	96 x 48 x 1"	Blue
03-002-00490	96 x 48 x 1"	Red
03-002-00491	96 x 48 x ¾"	White
03-002-00492	96 x 48 x ½"	White



EPICUREAN HANDY Wooden Fibre Cutting Board with Handle (Heat resistant up to 176°C)

Product Code	Dimension	Colour
03-002-00509	14 x 7 x ¾"	Natural



EPICUREAN BIG BLOCK Wooden Fibre Cutting Board

Product Code	Dimension	Colour
03-002-00510	21 x 16 x 1"	Natural
03-002-00511	24 x 18 x 1"	Natural



High Density Round Plastic Chopping Board

Product Code	Dimension
03-002-00535	40 x 10cm
03-002-00536	45 x 10cm
03-002-00537	50 x 10cm
03-002-00538	50 x 15cm



Wooden Rectangle Chopping Board

Product Code	Dimension
03-002-00512	6 x 10 x 1"
03-002-00513	8 x 12 x 1"
03-002-00514	10 x 14 x 1"
03-002-00515	12 x 17 x 1"
03-002-00519(XX)	12 x 18 x 1"
03-002-00520(XX)	12 x 20 x 1"
03-002-00521(XX)	12 x 24 x 1"
03-002-00522(XX)	17 x 19 x 2"
03-002-00516	18 x 24 x 1"
03-002-00517	18 x 24 x 2"
03-002-00518	24 x 12 x 2"



Wooden Round Chopping Board

Product Code	Dimension
03-002-00523	Ø10"
03-002-00524	Ø11"
03-002-00525	Ø12"
03-002-00526	Ø13"
03-002-00527	Ø14"
03-002-00528	Ø15"
03-002-00534(XX)	Ø15"
03-002-00529	Ø16"
03-002-00530	Ø18"
03-002-00533(XX)	Ø18 x 6"



Medium Density PLC Round Chopping Board

Dimension	White	Blue	Green	Red	Yellow
Ø12 x 2"	03-002-00541	03-002-00542(XX)	03-002-00539	03-002-00540	03-002-00543(XX)
Ø14 x 3"	03-002-00547	03-002-00544	03-002-00545	03-002-00546	
Ø15 x 3"	03-002-00550		03-002-00548	03-002-00549	
Ø16 x 1"					03-002-00551(XX)
Ø16 x 4"	03-002-00555	03-002-00552	03-002-00553	03-002-00554	03-002-00556
Ø16 x 6"	03-002-00559		03-002-00557	03-002-00558	
Ø18 x 4"	03-002-00562	03-002-00563(XX)	03-002-00560	03-002-00561	
Ø18 x 6"	03-002-00568	03-002-00565	03-002-00566	03-002-00567	03-002-00569
Ø20 x 6"	03-002-00570				



Low Density PLC Cutting Board Slab

Product Code	Dimension	Colour
03-002-00573	96 x 48 x 1"	<input type="checkbox"/> White

*Customized size upon request available.



Stainless Steel Chopping Board Stand

Product Code	Dimension	
03-002-00575	Ø42 x 75cm	For 16" Board
03-002-00576	Ø47 x 75cm	For 18" Board
03-002-00577	Ø52 x 75cm	For 20" Board



Stainless Steel Chopping Board Skirting

Product Code	Dimension
03-002-00578	80 x 40 x 0.04cm
03-002-00579	Thickness 0.06cm



SAN JAMAR Cutting Board Mate

Product Code	Dimension
03-002-00582	10 x 16"
03-002-00583	13 x 18"
03-002-00584	16 x 22"



CCK Stainless Steel Crescent Shape Chopping Board Container

Product Code	Dimension
03-002-00580	8 x 4.5"
03-002-00581	10 x 5"



Stainless Steel Drying Rack for 6 Cutting Boards

Product Code	Dimension
03-002-00585	27 x 30.7 x 30.2cm



SAFICO PLC Drying Rack for 6 Chopping Boards

Product Code	Dimension
03-002-00586	40 x 30cm



SPARTA Cutting Board Scraper / Refinisher

Product Code	Colour
03-002-00587	<input type="checkbox"/> White
03-002-00588	Replacement Blade for Cutting Board. Case pack 2pcs/pkt

ELECTRICALS & FOOD PREP MACHINES



CHAPTER

04

SIA HUAT 
Beyond Foodservice Supplies

www.siahuat.com



VITAMIX Heavy Duty Food Blender Vita Prep 3

Mechanical controls add versatility with 3 speeds and pulse. Stainless steel container with 2 handles and rubberized stainless steel lid. New dishwasher-safe one-piece jar pad for easy cleaning.

Product Code	04-001-00001
Dimension	20.3 x 22.9 x 51cm
Capacity	2ℓ Variable Speed 3700rpm 3hp
Elec. Spec.	230V / 50Hz / 1200-1400W

ACCESSORIES

- Replacement Container Jug: 04-001-00002(XX)



VITAMIX Heavy Duty Blender Blending Station Advance

The Blending Station Advance has been engineered for perfection including a noise reducing cover for an improved customer experience.

Product Code	04-001-00013(XX)
Dimension	45.7 x 21.6 x 27.2cm
Capacity	1.4ℓ 3700rpm
Elec. Spec.	230V / 50Hz / 1300W



SANTOS Brushless Blender 62

Fits everywhere. Can be used in its standard version or in-counter version for space saving. Touchscreen panel with 5 programmable functions. R&D feature available using a software and a usb port for flashdrive. Brushless motor (permanent magnet rotor) which gives it a long lifespan, an excellent energy efficiency and a low noise level. BPA-free jar. Pulse function. 2500/15000rpm.

Product Code	04-001-00010
Dimension	20 x 24.7 x 44cm
Capacity	1.4ℓ
Elec. Spec.	230V / 50Hz / 1000W



VITAMIX Heavy Duty Bar Blender 2 Speed Drink Machine

The exceptional power of the Vita-Mix Drink Machine gives you extra creamy, extra smooth, frozen (not iced) coffee drinks, cocktails, fruit smoothies, frappes, granitas, shakes, ice cream specialty drinks and more. Crush almost two litres of cubed ice in three seconds.

Product Code	04-001-00011
Dimension	20.3 x 22.9 x 44cm
Capacity	1.4ℓ 2 Speed 2hp
Elec. Spec.	230V / 50Hz / 750-850W

ACCESSORIES

- Replacement Container Jug: 04-001-00002(XX)



VITAMIX Heavy Duty Bar Blender Drink Machine Advance

The Vitamix Touch and Go™ Blending Station is programmed to mix the most popular drinks consistently every time. Even heavy duty smoothie mixtures, containing high percentages of ice and frozen fruit, and notoriously hard-to-mix ice cream drinks turn out smooth and creamy. Comes with one touch operation and sound reduction chamber.

Product Code	04-001-00025(XX)
Dimension	22.5 x 20.3 x 45cm
Capacity	0.9ℓ 2hp
Elec. Spec.	230V / 50Hz / 750-850W



WARING Electronic Blender w/ Timer & Sound Enclosure MX1500XTXSEE

Replaceable blending assembly. 4 Re-programmable, 2 step program settings. LCD display screen for variable speed control.

Product Code	04-001-00005
Dimension	23 x 28 x 54cm
Capacity	2ℓ 4500rpm 3.5hp
Elec. Spec.	230V / 50Hz / 1500W

ACCESSORIES

- PC Jar w/ Blending Assy w/o Lid for MX1100/ MX1500: 04-001-00007
- Sound Enclosure for Xtreme Series Blender: 04-001-00008(XX)





WARING Electronic Blender w/ Timer & Sound Enclosure MX1100XTXSEE

Great for smoothies, bar drinks, soups, salsas, sauces, desserts, dressings and more. Easy to clean electronic membrane keypad with simple On/Off, High, Low, Stop and Pulse controls. 30 seconds electronic countdown timer. Comes with sound enclosure for minimal noise. Replaceable blending assembly.

Product Code	04-001-00003	04-001-00004
Type	With Enclosure	Without Enclosure
Dimension	23 x 28 x 54cm	
Capacity	1.4ℓ	
Elec. Spec.	230V / 50Hz / 1500W	



WARING Bar Blender BB300K / BB300SK

The Waring BB300K Blade Series 1 HP Blender has you covered when your bar is busiest. Make three 16 oz. margaritas in 12 seconds or less! Its 2-speed, powerful 1 HP motor features easy-to-use toggle switch controls. A removable, rubberized jar pad dampens sound and makes wipe-down clean up easy.

Product Code	04-001-00065 BB300K	04-001-00068 BB300SK
Type	Copolyester Container	Stainless Steel Container
Dimension	39 x 26 x 26cm	
Capacity	1.4ℓ	
Elec. Spec.	230V / 50Hz	



WARING Commercial Blender with BPA-Free Container, UK Plug MX1000TXEE

This heavy-duty, powerful 3.5 HP blender teams up with The Raptor® jar/blade assembly for maximum power and efficiency. Clearly marked paddle switch controls feature HIGH, LOW, OFF and PULSE. Blend up to 75 drinks per day.

Product Code	04-001-00070
Dimension	23 x 22 x 47cm
Capacity	2ℓ 3.5hp
Elec. Spec.	230V / 50Hz / 1500W / 6.25Amps
Add. Info	Paddle switch controls / copolyester container



WARING Commercial Blender with BPA-Free Stackable Container, UK Plug MX1200TXEE

This heavy-duty, 3.5 HP blender teams up with The Raptor® blade and jar assembly for maximum power and efficiency. Rev it up with variable speed controls from 1,500 to 20,000 RPM and a max pulse of 30,000 RPM.

Product Code	04-001-00072
Dimension	20 x 21.5 x 45cm
Capacity	2ℓ Variable Speed 3.5hp
Elec. Spec.	230V / 50Hz / 1500W / 6.25Amps
Add. Info	Paddle switch controls / copolyester container



WARING Commercial Electronic Blender with BPA-Free Container, UK Plug MX1100TXEE

This heavy-duty, 3.5 HP blender teams up with The Raptor® jar and blade assembly for maximum power and efficiency. Features an easy-to-clean, electronic-membrane keypad with HIGH, LOW, OFF and PULSE functions and a 30-second electronic countdown timer.

Product Code	04-001-00071
Dimension	23 x 22 x 47cm
Capacity	2ℓ 3.5hp
Elec. Spec.	240V / 60Hz / 1500W
Add. Info	Membrane keyboard / copolyester container



WARING Commercial Blender with 2 Handles Stainless Steel Container CB15K

Chop, mix and shred large loads that need long blending times with a powerful 3.75 HP motor and electronic keypad controls. The durable, 1-gallon stainless steel container means business with two handles for carrying and pouring, and lid clamps for security.

Product Code	04-002-00082
Dimension	25 x 25 x 66cm
Capacity	4ℓ 3.75hp 16800-21500rpm
Elec. Spec.	230V / 50Hz / 1800W
Add. Info	Electronic keypad controls / 2 handles stainless steel container



WARING Heavy Duty Single Spindle Drink Mixer WDM120E

Single spindle for increased efficiency. Includes 1 malt cup, butterfly agitator, and propeller agitator for hard ice cream.

Product Code	04-001-00027
Dimension	18 x 28 x 50cm
Capacity	1hp 16000-25000rpm 3 speed
Elec. Spec.	230V / 50Hz



MIKA ECONOMY Bar Blender with PC Container

Double safety protection design to protect motor - Thermal protector & overload protector. Non-slip rubber feet.

Product Code	04-001-00009
Dimension	18 x 24.5 x 40cm
Capacity	2l 22000rpm
Elec. Spec.	230V / 50Hz / 1500W



SANTOS Electric Drink Mixer 54BK

Heavy duty variable speed drink mixer with automatic motor activation via bowl detection. Comes with one butterfly agitator, one solid agitator and one malt cup.

Product Code	04-001-00028
Dimension	18.6 x 18.2 x 53cm
Capacity	Cup 0.56l
Elec. Spec.	230V / 50Hz / 120W



SANTOS Cold Press Juicer

New way of juicing, pressing very slowly all kind of fruits, veggies, leafy greens, and preserving the vitamins, nutrients, enzymes, and minerals..

Product Code	04-001-00059
Capacity	50-80rpm
Elec. Spec.	220-240V / 50Hz



ROBOT COUPE Automatic Centrifugal Juice Extractor J100 Ultra

Has a powerful, resilient commercial grade motor which operates at a speed of 3,000 rpm, this means that the juice oxidizes less quickly. Producing a particularly smooth juice which is bursting with flavour.

Product Code	04-001-00030
Dimension	59.6 x 23.5 x 53.8cm
Capacity	7.2l
Elec. Spec.	230V / 50Hz



ROBOT COUPE Automatic Centrifugal Juice Extractor J80 Ultra

Pulp ejection juicer designed for making freshly-squeezed juice and vegetable juices. Patented automatic feed system for continuous throughput of fruit and vegetables with a diameter of up to 79mm.

Product Code	04-001-00036
Dimension	50.5 x 23.5 x 42cm
Capacity	6.5l
Elec. Spec.	230V / 50Hz



SANTOS Centrifugal Juice Extractor Ezy-Clean System II 68

The Miracle edition offers a high efficiency and is adapted to intensive use. Perfect filtration for a high quality juice : large basket with very fine sieve (0.5 mm / 0.02"). Full stainless steel food-zone (no aluminum). Wide feeding chute (79,5 mm diameter): no need to cut fruits and vegetables.

Product Code	04-001-00031
Dimension	48 x 32 x 58cm
Capacity	140L/h
Elec. Spec.	220-240V / 50-60Hz



SANTOS Juice Extractor High Output Centrifugal 28

Produces more than one litre of juice per minute. Very quiet and powerful motor with automatic pulp ejection. Stainless steel bowl and base.

Product Code	04-001-00034
Dimension	33 x 46.5 x 51cm / Jug(H): 22.2cm
Capacity	100L/H Container: 7.5l 3000/6000rpm
Elec. Spec.	230V / 50Hz / 1300W



SANTOS Centrifugal Juice Extractor 50

Extra-wide feeding chute for ease of use. Very quiet and powerful motor with automatic pulp ejection. Stainless steel bowl and base.

Product Code	04-001-00032	04-001-00033
Type	Standard Base	Chrome Base
Dimension	47 x 26 x 45cm / Jug(H): 20cm	
Capacity	100L/H	
Elec. Spec.	220-240V / 50Hz / 800W	



SANTOS Citrus Juicer w/ Chrome Base 38C

Comes with 2 extracting cones for lemons/oranges and grapefruits. Polycarbonate bowl with chrome base and waterproof motor block.

Product Code	04-001-00035
Dimension	30 x 20 x 35cm
Elec. Spec.	240V / 50Hz / 130W



SANTOS Lever Automatic Citrus Juicer

Polycarbonate bowl with waterproof motor block. Comes with universal squeezer for all citrus fruits. Aluminium casting and stainless steel construction.

Product Code	04-001-00038	04-001-00039
Type	Grey Base	Chrome Top / Base
Dimension	30 x 20 x 38cm / Jug(H): 13.5cm	
Capacity	30L/H 1450rpm	
Elec. Spec.	230V / 50Hz / 230W	



SANTOS Mefra Citrus Juicer with Chrome Base 71C

Comes with universal squeezer for all citrus fruits.

Product Code	04-001-00037
Dimension	17 x 23.6 x 31cm / Jug(H): 13.5cm
Capacity	15L/H
Elec. Spec.	230V / 50Hz / 40W



SANTOS Classic Citrus Juicer

Comes with 3 extracting cones for limes, lemons, oranges and grapefruits. Polycarbonate bowl with waterproof motor block.

Product Code	04-001-00040	04-001-00041
Type	Color Base & Lid	Chrome Base 11C
Dimension	30 x 20 x 35cm / Jug(H): 12.5cm	
Capacity	30ℓ/H	
Elec. Spec.	230V / 50Hz / 1300W	



SANTOS Santosafe Blender with Stainless Steel Container 374LI

Santosafe kitchen blender #37 (4Liters Capacity). The Santosafe #37 kitchen blender from Santos features a silent and reliable commercial motor. High-resistance blades are capable of crushing hard ingredients such as ice while its variable speed up to 15,000 rpm creates a vortex that can mix liquid and solid ingredients. The blender also has a pulse function of 18,000 rpm. The patented Santosafe locking system allows hand-free use while protecting the user.

Product Code	04-002-00077
Dimension	21.5 x 23 x 61.5cm
Capacity	4ℓ 0-18000rpm



Sugar Cane Juice Extractor

Product Code	04-001-00058(XX)
Dimension	43 x 50 x 102cm
Capacity	1/2hp
Elec. Spec.	230V / 50Hz / 373W



WARING Commercial Juice Extractor with Stainless Steel Container 6001X

The Waring® 6001C Heavy-Duty Bar Juice Extractor offers a compact design and a powerful 3600 RPM induction motor to rapidly and effortlessly extract large quantities of healthy, pulp-free juice from vegetables, fruits and herbs.

Product Code	04-001-00045
Dimension	26 x 47 x 45cm / Chute Size: 5 x 3.5cm
Elec. Spec.	230V / 50Hz / 600W



04-002-00078



04-002-00079

WARING Kitchen Blender 800G/800S

Single speed blender with durable, epoxy powder-coated zinc die-cast housing. Choice of stainless steel or glass blending jug.

Product Code	04-002-00078	04-002-00079
Type	Glass Container	Stainless Steel Container
Dimension	16 x 16 x 38cm	16 x 16 x 38cm
Capacity	1.2ℓ 0.5hp 18000-20000rpm	1ℓ 0.5hp 18000-20000rpm
Elec. Spec.	230V / 50Hz / 330W	230V / 50Hz / 330W



04-002-00080



04-002-00081

WARING Kitchen Blender 8011G/8011S

2-speed blender with durable, epoxy powder-coated zinc die-cast housing. Choice of stainless steel or glass blending jug.

Product Code	04-002-00080	04-002-00081
Type	Glass Container	Stainless Steel Container
Dimension	16 x 16 x 38cm	16 x 16 x 38cm
Capacity	1.2ℓ 0.5hp 18000-20000rpm	1ℓ 0.5hp 18000-20000rpm
Elec. Spec.	230V / 50Hz / 330W	230V / 50Hz / 330W



Snow Ice Slicer PDOM-PKD

Shaves snow ice blocks into extremely thin and smooth layered ice. Available in white with black spots.

Product Code	04-001-00047
Dimension	42 x 32 x 69cm
Capacity	Max ice block size: 17 x 17cm 0.25 hp Output: 0.12 kg/min
Elec. Spec.	230V / 50Hz



HATSUYUKI Block Ice Shaver

User-friendly model with ice-lift up device and wide ice-receiving space and CE mark. Low noise, Energy saving machine. Wide and open space below the shaving table. Light net weight.

Product Code	04-001-00060
Dimension	35.5 x 40.2 x 56.5cm
Elec. Spec.	230V / 1Ph / 50-60Hz



HATSUYUKI Ice Cube Shaver Machine

Easy operation-front switch selection for crushing or shaving ice. The shaved ice texture is available with the blade adjustment knob near the ice chute.

Product Code	04-001-00062
Dimension	30.6 x 40.2 x 42.9cm
Capacity	1.4-1.7kg/min
Elec. Spec.	220V / 50-60Hz / 1Ph



Block Ice Shaver White

Can be used for ice blocks. Ideal for cold ice shaving desserts.

Product Code	04-001-00069
Dimension	42 x 39 x 89cm
Capacity	19kg
Elec. Spec.	230V / 50Hz / 1



Cube Ice Shaver PD-25

Produces soft, fluffy shaved ice. Bigger capacity. The shaver uses ice cubes, which is easily obtained.

Product Code	04-001-00049
Dimension	28 x 40 x 65cm
Capacity	5kg 0.3hp 2.2-14kg/min
Elec. Spec.	230V / 50Hz / 250W



Cube Ice Shaver PD-22

Produces soft, fluffy shaved ice. The shaver uses ice cubes, which is easily obtained. Automatic cut off when lid is open, providing energy efficiency and safety. Includes drainage hose, a catch tray.

Product Code	04-001-00050
Dimension	40 x 28 x 46cm
Capacity	1kg 0.25hp 2.2-14kg/min
Elec. Spec.	230V / 50Hz / 185W



SANTOS Ice Crusher 53G

Crushes ice. Hands free use, with blue lighting. Perfect for cocktails. Available in Grey.

Product Code	04-001-00051
Dimension	35.3 x 23.6 x 47.4cm
Capacity	Tank: 1.2kg
Elec. Spec.	230V / 50Hz / 130W



SANTOS Ice Shaver 09

Powerful and sturdy, delivered with an adjustable disc to make flaked ice or crushed ice. Design allows for easy cleaning and maintenance.

Product Code	04-001-00052
Dimension	42 x 25 x 36cm
Capacity	Drawer Capacity: 1ℓ
Elec. Spec.	230V / 50Hz / 600W



LACOR Stainless Steel Glass Cooler Machine

The freeze is perfect for any local adapts to all types of surfaces, taking up a minimum of space. Perfect for use in home, kitchen, hotel or restaurant.

Product Code	04-001-00053(XX)
Dimension	50 x 22.8 x 30.5cm
Elec. Spec.	230V / 50Hz / 25W



LACOR Stainless Steel Dry Ice Maker Machine

Allows manufacturing dry ice pellets of 100 g at the time and the amount which is required for safe and controlled manner.

Product Code	04-001-00055(XX)
Dimension	26 x 26.5 x 20.5cm
Capacity	100g
Elec. Spec.	230V / 50Hz / 25W



WARING Compact Ice Crusher IC20

Choose coarse or fine ice, crushed in just one touch of button. All removable parts can be put in a dishwasher or easily cleaned with hot soapy water.

Product Code	04-001-00054
Dimension	23.6 x 35.3 x 47.4cm
Capacity	1kg Output: 1.5kg/min
Elec. Spec.	230V / 50Hz / 130W

ROBOT COUPE POWER MIXERS

The performance in terms of hygiene, ease of use, multiple functions, longer life, and profitability. The design of the machines and the materials used in their construction guarantee a sturdy machine. Powerful motor for fast processing and an optimum quality end-product. Space saving and easy to use. All stainless steel removable tube, bell, knife and whisk.

robot coupe®

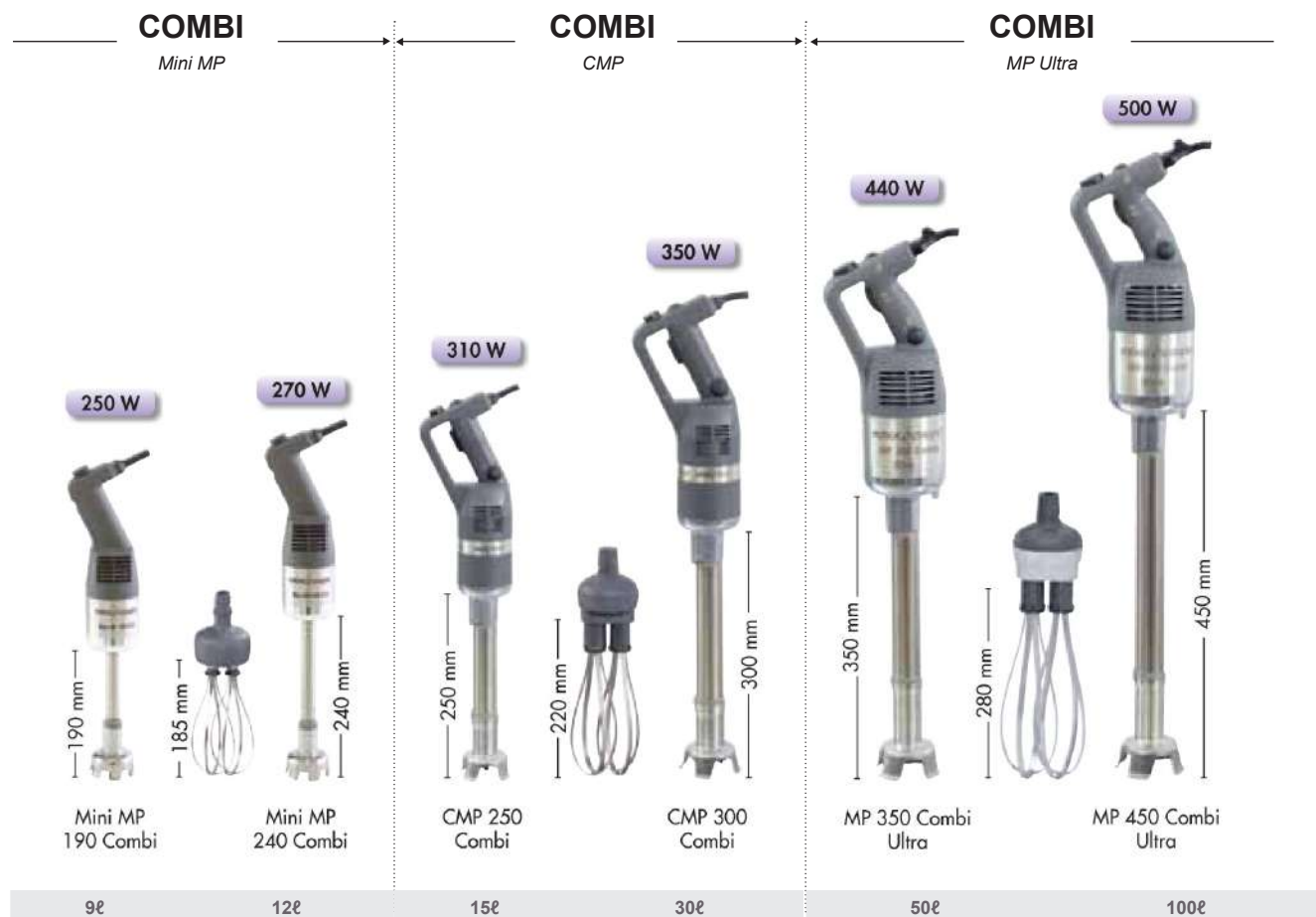

ROBOT COUPE

Product Code	Description	Dimension	Mixer Tool Length	Whisk Tool Length	Capacity	Electric. Specs
04-002-00033	Power Mixer Mini MP190 Combi	Ø7.8 x H47cm	19cm	34.5cm	Variable speed 2000-12500rpm Whisk 350-1500rpm	230V / 50Hz / 250W
04-002-00032	Power Mixer Mini MP240 Combi	Ø7.8cm x H53.5cm	24cm	24cm	Variable speed 2000-12500rpm Whisk 350-1500rpm	230V / 50Hz / 270W
04-002-00024	Compact Power Mixer CMP300 Combi	Ø12.5cm x H70cm	30cm	43cm	Up to 30L Variable speed Mixer 2300-9600rpm Whisk 500-1800rpm	230V / 50Hz / 350W
04-002-00017	Power Mixer MP350 Combi Ultra	Ø12.5cm x H80.5cm	35cm	43cm	Up to 50L Variable speed Mixer 1500-9000rpm Whisk 250-1500rpm	230V / 50Hz / 440W
04-002-00013	Power Mixer MP450 Combi Ultra	Ø12.5 x H89cm	45cm	36.5cm	Up to 100L Variable speed Mixer 1500-9000rpm Whisk 250-1500rpm	230V / 50Hz / 500W

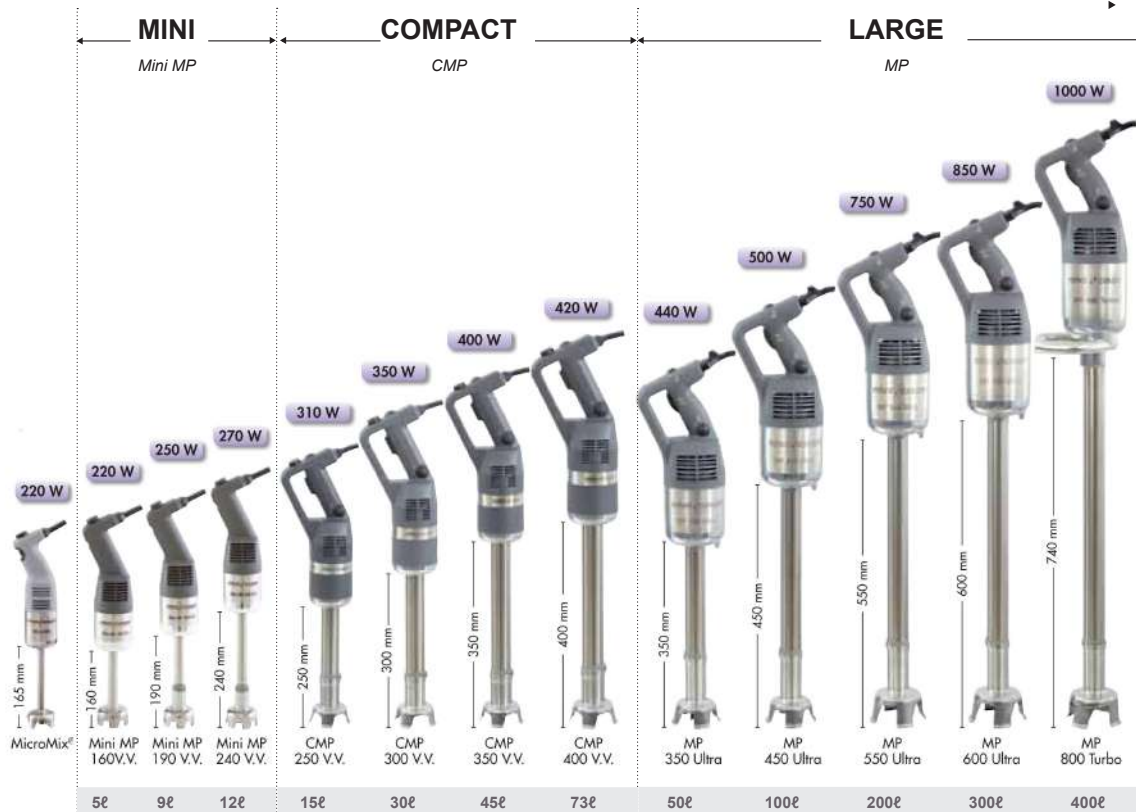

ROBOT COUPE

Product Code	Description	Dimension	Mixer Tool Length	Capacity	Electric. Specs
04-002-00039	Power Mixer Micromix Blender	Ø6.1 x H43cm	16.5cm	Variable speed 1500-14000rpm	230V / 50Hz / 220W
04-002-00034	Power Mixer Mini MP240 V.V.	Ø7.8cm x H52cm	24cm	Variable speed 2000-12500rpm	230V / 50Hz / 270W
04-002-00026(XX)	Power Mixer CMP250 V.V.	Ø9.4 x H61cm	25cm	Up to 15L Variable speed 2300-9600rpm	230V / 50Hz / 310W
04-002-00025(XX)	Power Mixer CMP350 V.V.	Ø9.4 x H71.8cm	35cm	Up to 45L Variable speed 2300-9600rpm	230V / 50Hz / 400W
04-002-00015	Power Mixer MP350 Ultra	Ø12.5 x H72.5cm	36cm	Up to 50L 1 Speed 9500rpm	230V / 50Hz / 440W
04-002-00016	Power Mixer MP350 V.V Ultra	Ø12.5 x H72.5cm	36cm	Up to 50L Variable speed 1500-9000rpm	230V / 50Hz / 440W
04-002-00012	Power Mixer MP450 V.V. Ultra	Ø12.5 x H82.5cm	46cm	Up to 100L Variable speed 1500-9000rpm	230V / 50Hz / 500W
04-002-00005	Power Mixer MP550 Ultra	Ø12.5 x H92.5cm	55cm	Up to 200L 1 Speed 9000rpm	230V / 50Hz / 750W
04-002-00002	Power Mixer MP600 Ultra	Ø12.5 x H97cm	58cm	Up to 300L 1 Speed 9000rpm	230V / 50Hz / 850W
04-002-00001	Power Mixer MP800 Turbo	Ø12.5 x H113cm	74cm	Up to 400L 1 Speed 9000rpm	230V / 50Hz / 1000W

DYNAMIC COMMERCIAL HAND MIXERS AND WHISKS

Stick Blender leader and specialist, DYNAMIC offers the largest and widest range on the market. 5 ranges (DYNAMIX, JUNIOR, SENIOR, MASTER and SMX ranges) with a capacity from 1 to 300 litres to adapt to each use.



DYNAMIC Master Combi Mixer (Detachable)
MFAP 2000

Product Code	04-002-00007
Dimension	Ø12.2 x H75.3cm Whisk (L): 25cm Mixer (L): 41cm Ricer (L): 43cm
Capacity	Mixer: 0-9500rpm Whisk: 0-900rpm Ricer: 0-600rpm
Elec. Spec.	230V / 50Hz / 460W



DYNAMIC Master Combi Mixer (Detachable)
MF 2000

Product Code	04-002-00010
Dimension	Ø12.2 x H75.3cm Whisk (L): 25cm Mixer (L): 43cm
Capacity	Mixer: 0-9500rpm Whisk: 0-900rpm
Elec. Spec.	230V / 50Hz / 460W



DYNAMIC Master Combi Mixer (Detachable)
MDH 2000 Plus

Product Code	04-002-00011
Dimension	Ø12.2 x H72cm Whisk (L): 41cm
Capacity	Mixer: 0-9500rpm
Elec. Spec.	230V / 50Hz / 460W

ACCESSORIES

- Whisk Attachment: 04-001-00008(XX)
- Ricer Attachment: 04-001-00009(XX)



DYNAMIC Master Whisk Mixer (Non-Detachable)
FT 97

Product Code	04-002-00018
Dimension	Ø11 x H65cm Whisk (L): 24.5cm
Capacity	900rpm
Elec. Spec.	230V / 50Hz / 460W



DYNAMIC Junior Combi Mixer (Detachable)
MX 022

Product Code	04-002-00023
Dimension	Ø9.4 x H53cm Whisk (L): 18.5cm Mixer (L): 22.5cm
Capacity	Mixer: 5-25l Whisk: 1-5l 0-9500rpm / 0-2000rpm
Elec. Spec.	230V / 50Hz / 250W



DYNAMIC Senior Combi Mixer (Detachable)
PMF 250

Product Code	04-002-00019
Dimension	Ø9.7 x H64cm Whisk (L): 20.5cm Mixer (L): 30cm
Capacity	Mixer: 0-9500rpm Whisk: 0-900rpm
Elec. Spec.	230V / 50Hz / 300W

ACCESSORIES

- Whisk Tool: 04-002-00020(XX)



DYNAMIC Senior Mixer (Detachable)
PMDH 250

Product Code	04-002-00021
Dimension	Ø9.7 x H64cm Mixer (L): 30cm
Capacity	Mixer: 0-9500rpm
Elec. Spec.	230V / 50Hz / 300W



DYNAMIC Senior Mixer (Non-Detachable)
PMX 98

Product Code	04-002-00022
Dimension	Ø9.7 x H64cm Mixer (L): 30cm
Capacity	Mixer: 0-9500rpm
Elec. Spec.	230V / 50Hz / 300W



DYNAMIC Junior Plus Mixer (Detachable)
MX 021V

Product Code	04-002-00027
Dimension	Ø9.4 x H50.5cm Mixer (L): 22.5cm
Capacity	5-25l 0-9500rpm
Elec. Spec.	230V / 50Hz / 250W



DYNAMIC Super Mixer Turbo (Detachable)
SMX 600

Product Code	04-002-00332
Dimension	L53cm
Capacity	75-300l
Elec. Spec.	220-240V / 50-60Hz / 850W



DYNAMIC Super Mixer Turbo (Detachable)
SMX 800

Product Code	04-002-00330
Dimension	L68cm
Capacity	75-300l
Elec. Spec.	220-240V / 50-60Hz / 1000W



DYNAMIC Super Mixer Turbo (Detachable)
SMX 700

Product Code	04-002-00331
Dimension	L60cm
Capacity	75-300l
Elec. Spec.	220-240V / 50-60Hz / 925W



DYNAMIC Junior Mixer Standard (Non-Detachable) MX 020

Product Code	04-002-00028
Dimension	Ø9.4 x H50.5cm Mixer (L): 22.5cm
Capacity	5-25l 9500rpm
Elec. Spec.	230V / 50Hz / 250W



DYNAMIC Mini Hand Mixer with Emulsifying Blade MD 95E

Product Code	04-002-00029
Dimension	Ø7.2 x H44.5cm Mixer (L): 16cm
Capacity	1-10l 0-9500rpm
Elec. Spec.	230V / 50Hz / 180W



DYNAMIC Mini Hand Mixer with Standard Blade MX 010

Product Code	04-002-00030
Dimension	Ø7.2 x H44.5cm Mixer (L): 18cm
Capacity	1-10l 0-9500rpm
Elec. Spec.	230V / 50Hz / 180W



DYNAMIC Dynamix Standard with Emulsifying Knife

Product Code	04-002-00037
Dimension	Ø7 x H39.5cm Mixer (L): 16cm
Capacity	1-4l 0-13000rpm
Elec. Spec.	230V / 50Hz / 220W



DYNAMIC Dynashake with Emulsifying Knife

Product Code	04-002-00038
Dimension	Ø9.5 x H42.5cm Mixer (L): 19cm
Capacity	1-8l 0-13000rpm
Elec. Spec.	230V / 50Hz / 250W



BAMIX Electric Immersion Blender

Handbuilt in Switzerland with 4 stainless steel interchangeable blades: Aerating blade, Blending blade, Chopping blade and Slicing blade to handle every kitchen project.

Powerful 200 watt AC motor keeps constant, precise speed under heavy loads. It is energy efficient supplying more power with less watts. Balanced to reduce vibration and ensure quiet operation.

Product Code	04-002-00040	04-002-00041
Dimension	Ø8.5 x H39.5cm Mixer (L): 25cm	Ø7 x H49.5cm Mixer (L): 35cm
Capacity	Up to 20ℓ Up to 14000-18000rpm	Up to 30ℓ Up to 18000-22000rpm
Elec. Spec.	230V / 50Hz / 200W	230V / 50Hz / 350W



WARING Mini Mixer (Non-Detachable) WSB33E

The Waring® WSB33X immersion blender is perfect for quick, light-duty applications, such as pureeing fruit or whipping up eggs in a shallow bowl or pan.

Its 7-inch fixed shaft and aggressive stainless steel blade design works quickly, while the lightweight, ergonomic construction is easy and comfortable to use.

Product Code	04-002-00043
Dimension	Ø7.2 x H38cm Mixer (L): 17.5cm
Capacity	Up to 13.5ℓ 2 Speed
Elec. Spec.	230V / 50Hz / 100W

ROBOT COUPE TABLE-TOP CUTTER MIXER

Designed to process all types of food and will mix, grind, chop, knead and puree with speed and efficiency, giving consistent high quality end-products in a few minutes for the longest preparation. The 3000 rpm speed is recommended for mousses and smooth-textured mousses.

Pulse control allows you to maintain the precise cut that you require. Industrial induction motor designed for heavy duty guarantees durability and reliability.



04-002-00074



04-002-00065



04-002-00059



04-002-00072

ROBOT COUPE

Product Code	Description	Dimension	Capacity	Speed	Electric. Specs
04-002-00074(XX)	Tabletop Cutter Mixer R2	20 x 28 x 35cm	2.9ℓ	1 Speed 1500rpm	230V / 50Hz / 550W
04-002-00072	Tabletop Cutter Mixer R3	21 x 32 x 40cm	3.7ℓ	1 Speed 1500rpm	230V / 50Hz / 650W
04-002-00061(XX)	Tabletop Cutter Mixer R6	28 x 35 x 52cm	7ℓ	2 Speed 1500 / 3000rpm 3 Phase	400V / 50Hz / 1300W
04-002-00057	Tabletop Cutter Mixer R10	34.5 x 56 x 66cm	11.5ℓ	Variable Speed 300-3500rpm	230V / 50Hz / 2600W
04-002-00065(XX)	Tabletop Cutter Mixer R5 V.V.	22.6 x 30.4 x 46cm	5.5ℓ	Variable Speed 300-3500rpm	230V / 50Hz / 1300W
04-002-00059	Tabletop Cutter Mixer R10 V.V.	34.5 x 56 x 66cm	11.5ℓ	Variable Speed 300-3500rpm	230V / 50Hz / 2600W
04-002-00064(XX)	Tabletop Cutter Mixer R5A Plus	28 x 35 x 49cm	5.5ℓ	2 Speed 1500 / 3000rpm 3 Phase	400V / 50Hz / 1200W
04-002-00058(XX)	Tabletop Cutter Mixer R10E	34.5 x 56 x 66cm	11.5ℓ	2 Speed 1500 / 3000rpm 3 Phase	400V / 50Hz / 2600W

ROBOT COUPE BLENDER & MIXER BLIXER

The Blixers® will easily realise your pureed, raw or cooked, semi-liquid, liquid or pasty meals. With their large capacity and leak proof lid, with built in scraper, these models make it simple to prepare all types of mixed and liquidized food, even for tube feeding.

A safety device fitted to the lid prevents access to moving blades and an integral motor braking device ensures operator safety. Any parts which come into contact with food can be easily removed and cleaned, in compliance with the strictest hygiene standards (NSF).



04-002-00071

04-002-00060

04-002-00066

04-002-00051

ROBOT COUPE

Product Code	Description	Dimension	Capacity	Speed	Electric. Specs
04-002-00071	Table Blender & Mixer Blixer 4	24.2 x 30.4 x 44.4cm	4.5ℓ	1 Speed 3000rpm	230V / 50Hz / 900W
04-002-00056(XX)	Table Blender & Mixer Blixer 15	37 x 61.5 x 68cm	15ℓ	2 Speed 1500 / 3000rpm 3 Phase	400V / 50Hz / 3000W
04-002-00054(XX)	Table Blender & Mixer Blixer 20	38 x 63 x 78cm	20ℓ	2 Speed 1500 / 3000rpm 3 Phase	400V / 50Hz / 4400W
04-002-00068	Table Blender & Mixer Blixer 5 V.V.	28 x 35 x 50cm	5.5ℓ	Variable Speed 300-3500rpm	230V / 50Hz / 1400W
04-002-00063	Table Blender & Mixer Blixer 6 V.V.	28 x 35 x 53.5cm	7ℓ	Variable Speed 300-3500rpm	230V / 50Hz / 1500W
04-002-00062(XX)	Table Blender & Mixer Blixer 8 V.V.	31.5 x 54.5 x 60.5cm	8ℓ	Variable Speed 300-3500rpm	230V / 50Hz / 2200W
04-002-00060	Table Blender & Mixer Blixer 10 V.V.	31.5 x 54.5 x 68cm	11.5ℓ	Variable Speed 300-3500rpm	230V / 50Hz / 2600W
04-002-00055(XX)	Table Blender & Mixer Blixer 20 V.V.	38 x 63 x 78cm	20ℓ	Variable Speed 300-3500rpm	380V / 50Hz / 4400W
04-002-00073	Table Blender & Mixer Blixer 3D	24.2 x 30.4 x 44.4cm	3.7ℓ	1 Speed 3000rpm	230V / 50Hz / 750W
04-002-00066	Table Blender & Mixer Blixer 5A Plus	28 x 35 x 50cm	5.5ℓ	2 Speed 1500 / 3000rpm	230V / 50Hz / 1300W
04-002-00067	Table Blender & Mixer Blixer 5A Plus	28 x 35 x 50cm	5.5ℓ	2 Speed 1500 / 3000rpm 3 Phase	400V / 50Hz / 1300W
04-002-00051(XX)	Vertical Blender & Mixer Blixer 30	72 x 60 x 125cm	28ℓ	2 Speed 1500 / 3000rpm 3 Phase	400V / 50Hz / 5400W
04-002-00048(XX)	Vertical Blender & Mixer Blixer 45A	76 x 60 x 140cm	45ℓ	2 Speed 1500 / 3000rpm 3 Phase	400V / 50Hz / 9000W
04-002-00045(XX)	Vertical Blender & Mixer Blixer 60A	81 x 60 x 140cm	60ℓ	2 Speed 1500 / 3000rpm 3 Phase	400V / 50Hz / 11000W

ROBOT COUPE VERTICAL CUTTER MIXER

The cutter allows the processing of meat, vegetables and smooth textured mousses, as well as for grinding and kneading foodstuffs in a minimum of time. Less than 5 minutes are needed to realise even the longest preparation such as smooth-textured mousses. All stainless steel machine for space saving, built with a removable bowl and tilting seal for easier cleaning and to empty the bowl easily. Control panel designed for a simple and reliable use and equipped with a timer for a better preparation control.



04-002-00052 / 04-002-00053

04-002-00046

ROBOT COUPE

Product Code	Description	Dimension	Capacity	Speed	Electric. Specs
04-002-00052(XX)	Vertical Cutter Mixer R20	38 x 63 x 76cm	20ℓ	2 Speed 1500 / 3000rpm 3 Phase	400V / 50Hz / 4400W
04-002-00053(XX)	Vertical Cutter Mixer R20E	38 x 63 x 76cm	20ℓ	2 Speed 1500 / 3000rpm 3 Phase	230V / 50Hz / 4400W
04-002-00046(XX)	Vertical Cutter Mixer R45A	76 x 60 x 140cm	45ℓ	2 Speed 1500 / 3000rpm 3 Phase	400V / 50Hz / 10000W

ROBOT COUPE FOOD PROCESSORS

Efficient, robust and fast, the range of Robot-Coupe Food processors will satisfy all the Professionals requirements for establishments serving from 10 to 400 covers.

It will be a reliable and time saving investment. They easily chop, grind, knead, mix and thanks to their complete selection of discs, grate, slice, julienne and for R402 and bigger models, dice and make French fries to perfection. They can perform any number of tasks, which you will gradually discover as you use them.

Less than 2 minutes are needed to make a bowl of mayonnaise, a steak tartare, a carrot puree or a fruit compote. Industrial induction motor for heavy duty use guarantees durability and reliability.



ROBOT COUPE Tabletop Food Processor V.V.

Product Code	04-002-00091
Dimension	42.6 x 48.1 x 88cm
Capacity	7ℓ
Elec. Spec.	230V / 50Hz / 1500W



04-002-00092



04-002-00093

ROBOT COUPE Cutter & Veg Slicer R201XL / R201XL Ultra

Product Code	04-002-00092(XX)	04-002-00093(XX)
Type	R201XL PLC Housing	R201XL Ultra Stainless Steel Housing
Dimension	22 x 28 x 49.5cm	
Capacity	2.9ℓ 1500rpm Single Phase	
Elec. Spec.	230V / 50Hz / 550W	



ROBOT COUPE Food Processor with Vegetable Slicer Attachment & Stainless Steel Container R301UD / R301UD Ultra

Product Code	04-002-00095	04-002-00096(XX)
Type	R301UD	R301UD Ultra PLC Housing
Dimension	32 x 30 x 55cm	32.5 x 30 x 55cm
Capacity	3.7ℓ 1500rpm Single Phase	
Elec. Spec.	230V / 50Hz / 650W	



ROBOT COUPE Tabletop Food Processor R211XL Ultra

Product Code	04-002-00094
Dimension	22 x 36 x 44.5cm
Capacity	2.9ℓ
Elec. Spec.	230V / 50Hz / 550W



ROBOT COUPE Food Processor Stainless Steel Cutter Bowl R401

Product Code	04-002-00097(XX)
Dimension	32 x 30.4 x 57cm
Capacity	4.5ℓ 1500rpm Single Phase
Elec. Spec.	230V / 50Hz / 700W



ROBOT COUPE Tabletop Food Processor R402A

Product Code	04-002-00098
Dimension	32 x 30.4 x 59cm
Capacity	4.5ℓ 500/1500rpm
Elec. Spec.	230V / 50Hz / 750W



ROBOT COUPE Tabletop Food Processor R502 V. V.

Product Code	04-002-00099
Dimension	38 x 35 x 66.5cm
Capacity	5.5ℓ 300-3500rpm Slicer: 300-1000rpm R-mix Reverse Speed 60-500rpm
Elec. Spec.	230V / 50Hz / 1300W
Add. Info.	With R mix function. To Mix ingredients gently.



ROBOT COUPE Vegetable Processor R502E

Product Code	04-002-00100
Dimension	38 x 35 x 66.5cm
Capacity	5.5ℓ 1000rpm
Elec. Spec.	400V / 50Hz / 1000W



WARING Commercial Food Processor WFP14SE

A light duty commercial food processor which is capable of chopping, grinding, mixing and pureeing a large range of foods in excellent time. It features an extra large feed chute for the reduction of prep and manual chopping time whilst the scratch and break-resistant bowl demonstrates high quality and a long user life. Its components are dishwasher-safe whilst the pulse function allows excellent processing control. It has powerful and efficient motor, innovative design and robust construction.

Product Code	04-002-00101
Dimension	25.5 x 29 x 40cm
Capacity	3.35ℓ 1hp 1800rpm
Elec. Spec.	230V / 50Hz / 600W

ACCESSORIES

- **Adjustable Slicing Disc: 04-002-00102**
- **Sealed Whipping Disc: 04-002-00103**
- **Reversible Shredding Disc: 04-002-00104**
- **Continuous Feed Attachment Kit: 04-002-00105**



CUISINART 14-Cup Food Processor

The Cuisinart Elite Collection® 2.0 14 Cup Food Processor boasts a 1300 watt peak power motor to power through your favorite recipes with ease. With innovative design solutions including a 4½ cup work bowl nested inside the 14 cup bowl, adjustable slicing disc, and a reversible shredding disc, Cuisinart gives you multiple food processors in one! The SealTight™ Advantage System keeps your kitchen counters clean from spills whether mixing, processing, or pouring, and the removable parts are all dishwasher safe for your convenience.

Product Code	04-002-00357
Dimension	22 x 26 x 45cm
Capacity	3.3ℓ
Elec. Spec.	220-240V / 50-60Hz / 1400W



THERMOMIX 20-in-1 Functions Food Processor

For weighing, mixing, chopping, milling, kneading, blending, steaming, cooking, whisking, precise heating, stirring and emulsifying.

Product Code	04-002-00365
Dimension	32.6 x 32.6 x 34.1cm
Capacity	2.2ℓ
Elec. Spec.	220-240V / 50-60Hz / 1500W



BRAUN Food Processor White / Green

Easy to store, easy to use – compact design for convenient handling and space saving storage. Less noise, more convenience – makes cooking easy, instead of noisy. Environmentally friendly and cost saving thanks to a high efficiency motor with low power consumption. Whether for kneading, whipping, grating, slicing, shredding and even more – it comes with 7 different accessories to satisfy any food preparation desire.

Product Code	04-002-00088
Dimension	31.5 x 21 x 35.5cm
Capacity	2.0ℓ
Elec. Spec.	220-240V / 5800W



HOTMIXPRO Gastro

It has a powerful motor (1500W), capable of very high speeds (up to 12'500 rpm), and it can cook up to 190°C (374°F) with degree-by-degree temperature control (1°C increments).

Product Code	04-003-00002
Dimension	25.8 x 31.2 x 29.6cm
Capacity	2ℓ 26 speeds 60-12500rpm 25°-190°C
Elec. Spec.	230V / 50Hz / 2300W



04-002-00110



04-002-00111



04-002-00112



04-002-00116



04-002-00117

ROBOT COUPE Vegetable Preparation Machine

Immensely strong, durable, and easy to clean. Comprehensive range of 48 discs for slicing, ripplecutting, grating and cutting into sticks, strips or dice (from 5x5x5 mm to 25x25x25 mm) with optimum quality and precision every time. 375 rpm single-speed appliance ideal for processing delicate foodstuffs, dicing or making french fries, as well as guaranteeing a wide variety of slicing, grating and julienne cuts. All parts which come into contact with foodstuffs can easily be removed for cleaning, thus maintaining the highest standards of hygiene.

Product Code	Description	Dimension	Capacity	Electric. Specs
04-002-00110	Vegetable Preparation Machine CL52E	36 x 34 x 69cm	Up to 750kg/h 375rpm	230V / 50Hz / 750W
04-002-00111	Vegetable Preparation Machine CL50E	38 x 30.5 x 59.5cm	Up to 500kg/h 375rpm	230V / 50Hz / 550W
04-002-00112	Vegetable Preparation Machine CL50 Gourmet	39 x 31 x 61cm	Up to 500kg/h 375rpm	230V / 50Hz / 550W
04-002-00113(XX)	Vegetable Preparation Machine CL50 Ultra Pizza	38 x 30.5 x 61cm	Up to 500kg/h 375rpm	230V / 50Hz / 550W
04-002-00114(XX)	Vegetable Preparation Machine CL50E Ultra	38 x 30 x 61cm	Up to 500kg/h 375rpm	230V / 50Hz / 550W
04-002-00115(XX)	Vegetable Preparation Machine CL50 Ultra	35 x 32 x 59cm	Up to 500kg/h 2 Speed 375rpm	400V / 50Hz / 600W
04-002-00116	Vegetable Preparation Machine CL40	32 x 30.4 x 59cm	Up to 200kg/h 500rpm	230V / 50Hz / 500W
04-002-00117	Vegetable Preparation Machine CL20D	32.5 x 30.4 x 57cm	Up to 50kg/h 1500rpm	230V / 50Hz / 400W



ROBOT COUPE Vegetable Preparation Pusher Feed Head with Stand CL55E

Machine CL55 equipped with a mobile stand. No disc included. The shape of the pusher has been conceived for a better use comfort and for fast processing.

Product Code	04-002-00107(XX)
Dimension	Machine Only: 38 x 32 x 92cm
Capacity	Up to 1200kg/h Hooper Capacity: 4.2l
Elec. Spec.	400V / 50Hz / 1100W



ROBOT COUPE Stainless Steel Mobile Stand

Movable stands for models CL52 and CL55. Fits Gastronomes 1/1 pans.

Product Code	04-002-00109(XX)
--------------	------------------



SANTOS Cheese Grater with 1 Disc 04-002-00119

A wide range of discs is available to grate hard and soft cheese, chocolate, peanuts and dried fruits. Its new design facilitates cleaning and maintenance (removable housing and disc).

Safety switch: the machine stops when opening the drawer or lever.

Product Code	04-002-00118
Dimension	42 x 25 x 36cm
Capacity	Drawer Capacity: 1l 1500/1800rpm
Elec. Spec.	230V / 50Hz / 600W
Add. Info.	Standard disc: Grater Ø3mm Beige

GRATING DISC:

- Grating Disc #02 (2mm): 04-002-00119(XX)
- Grating Disc #03 (3mm): 04-002-00120(XX)
- Grating Disc #04 (4mm): 04-002-00121(XX)
- Grating Disc #05 (6mm): 04-002-00122(XX)
- Grating Disc #06 (8mm): 04-002-00123(XX)
- Grating Disc Parmesan for #02: 04-002-00124(XX)
- Grating Disc Fondue for #02: 04-002-00125(XX)



SANTOS Coffee Grinder w/ Drawer 01

Traditional sturdy and powerful shop coffee grinder for coffee and dry spices. Ideal for shops, supermarkets, coffee roasters and bakeries. Easy to use and efficient, this coffee grinder will give a high quality grinding.

Product Code	04-001-00056(XX)
Dimension	25 x 32 x 55cm
Capacity	Drawer Capacity: 0.8kg Hooper Capacity: 1kg
Elec. Spec.	230V / 50Hz / 600W



SANTOS Coffee Grinder

The automatic coffee grinder # 55 dispenses the precise dose of coffee for 1 or 2 espressos, directly into the filter holder. Ideal appliance for bars, hotels, restaurants, and coffee shops, it stands beside the traditional 1, 2, or 3 groups espresso machine. The automatic coffee grinder # 55 guarantees a fresh ground coffee with all its flavours.

Product Code	04-001-00057(XX)
Dimension	39.7 x 19.8 x 57.7cm
Capacity	Hooper Capacity: 2.2kg
Elec. Spec.	220-240V / 50Hz / 1100W



LACOR Milk Frother

Product Code	04-001-00061
Capacity	240ml
Elec. Spec.	500W



SANTOS Pepper Grinder with Drawer #01P

Traditional sturdy and powerful shop coffee grinder for coffee and dry spices. Easy to use and efficient, the coffee grinder #01 will give you a high quality grinding. Ideal for shops, supermarkets, coffee roasters, bakeries.

Product Code	04-002-00126(XX)
Dimension	25 x 32 x 55cm
Capacity	Drawer capacity: 0.8kg Hooper capacity: 1kg
Elec. Spec.	230V / 50Hz / 650W



TINSO Grinding Machine TS-08

The machine is suitable for grinding small amount material into 150 to 200 mesh.

Product Code	04-002-00127
Dimension	22 x 19.5 x 39cm Grinding chamber Ø17.4cm x 12.4cm
Capacity	2500rpm
Elec. Spec.	230V / 50Hz / 1800W



TINSO Soya Bean Grinder

Applies to beancurd, spiced & dried bean curd, soybean milk, etc.

Product Code	04-002-00128(XX)
Dimension	40 x 40 x 63cm Grinding stone: Ø9.2cm
Capacity	1hp Output 10-25kg/h 2800/3600rpm
Elec. Spec.	230V / 50Hz / 746W



WARING Chopper Grinder WCG75E

The Waring® WCG75 Pro Prep® Chopper Grinder is engineered for the professional kitchen to give you the right tools for specific tasks with no tainting of flavors. It is perfect for prep jobs and finishing touches. Grind spices and hard foods such as Parmesan and Romano cheeses, hard chocolate, nuts, coffee beans, peppercorns, allspice, celery seed, mustard seed and more.

Product Code	04-002-00129
Dimension	14 x 20 x 22cm
Capacity	0.75l 0.75hp
Elec. Spec.	230V / 50Hz / 150W



WARING Commercial Spice Grinder WSG60E

The 3-cup capacity Waring® WSG60 Wet/Dry Power Grinder is perfect for peppercorns, cinnamon, nuts, garlic, herbs, and other dry and wet blends. Includes two fully removable and dishwasher-safe, stainless steel grinding bowls with convenient storage lids. Sealed clear-view operating lid allows for liquid processing up to 1.5 cups to make pastes, dressings, sauces, creams and more.

Product Code	04-002-00130
Dimension	Ø8.5 x W6.5 x H11.5"
Capacity	3 Cup
Elec. Spec.	230V / 750W



EDLUND Fruit and Vegetable Slicer Arc

The unique Pusher/Hopper allows safe and perfect positioning of the product to be sliced, as well as for loading smaller soft products like strawberries for faster bulk slicing. The quick change blade cartridge with wash guard ensures safe handling and the all stainless steel construction of the ARC.

Product Code	04-002-00131	04-002-00132	04-002-00133
Slicer	5mm	6.5mm	10mm
Dimension	24 x 51 x 66cm		
Add. Info.	Choose from 1/4", 3/8" or 1/2" dice or fries		



EDLUND Tomato Laser Slicer

Exclusive staggered blade cartridge ensures a perfectly sliced tomato every time, and the heavy duty suction feet keep the slicer in place everytime. Dishwasher safe.

Product Code	04-002-00134	04-002-00135	04-002-00136
Slicer	5mm	6.5mm	10mm
Dimension	47.7 x 30.5 x 29.2cm		



L' TELLIER Turning Vegetable Slicer Le Rouet

Create tagliatelle, spaghetti, and julienne-cut fruit and vegetables with just a few turns of the handles. Easily made coleslaw, rösti, and grated potatoes. Tailored to a wide variety of fruit and vegetables, including firm-fleshed ones, like carrots, celery, onions, courgettes, and apples.

Product Code	04-002-00152
Dimension	37 x 14 x 25cm Slice Thickness 2/3/6mm

ACCESSORIES:

- **Motor Kit for #N7001 Vegetable Slicer Le Rouet: 04-002-00153(XX)**



EDLUND Dicer Titan Max-Cut FDW-038

Able to move quickly and easily from wall to table mounting with the available quick connect bases. Dishwasher safe.

Product Code	04-002-00137
Dimension	24 x 61 x 76cm 10mm dicing
Elec. Spec.	230V / 50Hz / 550W

ACCESSORIES

- **Table Portable Base w/ Suction Cup Feet for Titan: 04-002-00138**
- **Other Spares & Accessories available upon request.**



NEMCO Chip Twister Fry Cutter 55150B

Simply load the potato, apply steady pressure, and the fry cutter will make quick work of an entire potato up to 60 count in size to minimize waste.

Product Code	04-002-00154(XX)
Dimension	43.8 x 25.4 x 22cm
Elec. Spec.	230V / 50Hz



ROBOT COUPE Automatic Sieve Juicer C120

The machine produces juice, fruit purees, vegetable mousses, sauce bases, bisques and fish soups. All parts are made of stainless steel to ensure easy cleaning and durability. Continuous feed hopper for ease of use and time saving. All parts in contact with food are easily removed and are dishwasher safe.

Product Code	04-002-00156(XX)
Dimension	89 x 49 x 87cm
Capacity	1500rpm
Elec. Spec.	230V / 50Hz / 900W

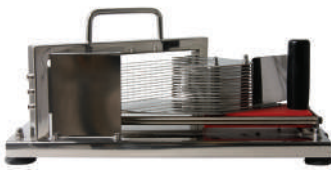

Manual Tomato Slicer

Product Code	04-002-00159	04-002-00160
Slicing Thickness	4mm	5.5mm
Dimension	42 x 20 x 21cm	



MATFER Stainless Steel Truffle Mandoline Slicer

For truffles and mushrooms. Tempered stainless steel blade for thinner and perfect slices. Cut thickness from 0.1 to 4 mm. Stainless steel.

Product Code	04-002-00174(XX)
Slicing Thickness	0.1 to 4mm



Spring Onion Cutter

Product Code	04-002-00163(XX)
Type	Belt Type
Dimension	41 x 35 x 51cm
Capacity	1/4hp
Elec. Spec.	230V / 50Hz / 186W



ROBOT COUPE Automatic Sieve Juicer C80

Strain soups, bisques or sauces, extract fruit pulp or separate fibres from vegetables.

Product Code	04-002-00155(XX)
Dimension	62 x 36 x 52cm
Capacity	1500rpm
Elec. Spec.	230V / 50Hz / 650W



WESTMARK Vegetable Slicer

Cut vegetable- and fruit spirals, spaghettis and rings. Ideal for carrots, apples, cucumbers, potatoes, cabbages, salad etc., with 3 interchangeable slicing units and non-slip feet.

Product Code	04-002-00157
Dimension	27 x 14 x 22cm



WESTMARK Stainless Steel Potato & Vegetable Chipper with 3 Blades

Strong suction cup foot ensures a safe grip. Easy to change attachments 3 serrated blades and slicer attachments for different cutting widths.

Product Code	04-002-00158
Dimension	25 x 10 x 13cm
Blade Grids	12x12 / 10x10 / 9x9mm





L. TELLIER Stainless Steel Classic Mandoline

Adjustable slices thickness and waffle cuts. Smooth or embossed slices, French fries and julienne. Table edge support, 2 cutting blade units, smooth blade and corrugated blade.

Product Code	04-002-00166
Dimension	41 x 13 x 4.5cm
Add. Info.	60 Blades N2460

ACCESSORIES:

- **Stainless Steel Guard with Plastic Handle:** 04-002-00342



L. TELLIER Stainless Steel Mandoline with Table Stand without Protective Carriage

Ideal for: Variable-thickness slices of fruit and vegetables, Waffled slices, Wafers and crisps, Julienne-cut items, Angel hair, Thin-cut chips, matchstick potatoes, and chips.

Product Code	04-002-00356	04-002-00335
Dimension	41 x 13.5 x 4.5cm	
Add. Info.	44 Blades	38 Blades without Guard



EDLUND Electric Food Slicer

The new 350XL Series of slicers are designed to handle larger items and more of them. The opening, blade assembly, and pusher are 11/2" larger which makes them perfect for slicing cooked chicken breasts for fajitas, caesar salads, or larger beefsteak tomatoes. The new pusher design allows operators to adjust the start cycle for product thickness, while maintaining complete safety.

Product Code	04-002-00186(XX)	04-002-00184(XX)	04-002-00177(XX)
Slicing Thickness	5mm with Slice Blade #356	6.5mm with Slice Blade #354	Without Blade and Insert
Dimension	29.2 x 31.8 x 43.2cm		
Elec. Spec.	230V / 50Hz		

ACCESSORIES:

- **Replacement Blade Assembly and Pusher Insert available upon request**



MATFER Mandoline 2000 with 3 Blades and Pusher

Frame and safety guard/pusher are made of heat resistant, nonporous composite fiberglass. Blades are crafted from high carbon stainless steel. The mandoline's slicing blade has both a straight edge and serrated edge. The safety guard or pusher protects hands from the blade. The straight edge of the slicing blade is ideal for slicing a variety of foods from carrots and cabbage to lemons and potatoes. The serrated edge creates crinkle and waffle cuts. The three julienne blades create classic julienne strips in three different thicknesses 1/8", 3/16" or 3/8".

Product Code	04-002-00168
--------------	--------------

ACCESSORIES:

- **Cutting Block (3mm):** 04-002-00169(XX)
- **Cutting Block (5mm):** 04-002-00170(XX)
- **Cutting Block (10mm):** 04-002-00171(XX)
- **Reversible Blade:** 04-002-00172(XX)
- **Pads (Set of 4pc):** 04-002-00173(XX)



L. TELLIER Stainless Steel Tomato Slicer CTX55

Provides quick and easy access to regular 5.5 mm tomato slices. Ideal to garnish salads, hamburgers, sandwiches. Works also very well for cutting citrus (lemons, oranges, kiwis, etc.) The horizontal cut avoids a large loss of juice. It has all the features for an efficient and safe work daily.

Product Code	04-002-00191
Slicing Thickness	5.5mm
Dimension	48 x 20 x 32cm

ACCESSORIES:

- **Set of 11 Blades:** 04-002-00192



L. TELLIER Tomato Wedger CAX106

The tomato and citrus cutter in Tellier sections allows cutting of tomatoes and citrus fruit automatically and quickly in regular quarters. Mounted on foot, it allows to easily recover the freshly cut quarters in a tray to be placed underneath (not supplied). Its stainless steel design guarantees all the guarantees of NF food standards and reliability.

Product Code	04-002-00193(XX)
Dimension	32.5 x 38.5 x 58cm
Add. Info.	Cuts 6 Wedges



L. TELLIER Professional Apple Peeler

Peel, cut and remove the core of the apples. Speed: about 40 kg/hr.

Product Code	04-002-00197
Dimension	39 x 12.5 x 21cm
Slicing Thickness	4mm



SEVERIN Electric Knife EM3965

Slides effortlessly through food which is conventionally cut or chopped cuts cleanly and precisely, with no residue dishwasher-safe blades guarantee easy cleaning safety on-off switch finger protection.

Product Code	04-002-00194
Elec. Spec.	230V / 50-60Hz / 100W
Colour	<input type="checkbox"/> White



WESTMARK Apple Dream with Screw Clamp

The peeler peels, cuts into spiral discs and also removes the core. The suction cup offers stability.

Product Code	03-001-00687
Elec. Spec.	110V / 240



WARING Cordless Lithium Electric Knife

The peeler peels, cuts into spiral discs and also removes the core. The suction cup offers stability.

Product Code	04-002-00201
Dimension	45 x 26 x 14cm



04-002-00199



04-002-00341

S.A.P Stainless Steel Potato Peeler

The machines are endowed with speed reduction unit with belt drive, and the multigrip belt is quiet, safe and easily adjustable. The cover made in transparent glass or transparent polycarbonate allows the processing. The automatic outlet device and water inled is of Ø 50 mm for potato peeler. The turning plate of potato peeler is made in silicon carbon or aluminium.

Product Code	04-002-00199	04-002-00200	04-002-00341
Dimension	32 x 42 x 80cm	40 x 50 x 90cm	45 x 55 x 95cm
Capacity	Tank: 8kg 250kg/h 1400rpm 1.0hp	Tank: 15kg 500kg/h 1400rpm 1.5hp	Tank: 20kg 600kg/h 1400rpm 1.5hp
Elec. Spec.	230V / 50Hz / 550W	230V / 50Hz / 900W	230V / 50Hz / 900W



DYNAMIC Manual Salad Spinner with Sealed Cover SD92

Sealed cover giving the added benefit of a water-tight lid to prevent splashing, removing the risk of contamination or damage caused by salad leaves getting caught in the gears.

Product Code	04-002-00207
Dimension	Ø43 x 50cm
Capacity	20ℓ Max: Up to 8 Heads of Lettuce



DYNAMIC Electric Salad Spinner EM98

Rotating 500 times per minute, the Dynamic EM98 electric salad spinner can dry eight heads of lettuce in less than 60 seconds. Its interior can accommodate 5 gallons of product, and it runs at a single speed with the flip of a switch. The interior, outside, and top are all made of durable polypropylene plastic, and its parts have undergone an antibacterial treatment to hinder mold growth.

Product Code	04-002-00206
Dimension	Ø43 x 60cm
Capacity	20ℓ Max: Up to 8 Heads of Lettuce
Elec. Spec.	230V / 50Hz / 200W



ZYLISS Easy Spin Salad Spinner

Retractable cord and brake system removes excess water with ease. Lid separates for easy cleaning and drying. Spinner can also be used to store a pre-made salad and keep it fresh for days.

Product Code	04-002-00358	04-002-00359
Dimension	Large	Small
Capacity	5ℓ	2.5ℓ



DYNAMIC Manual Salad Spinner SD99 / SD92

Fast and efficient, it respects the product's fragility. Heavy duty construction for an intensive daily use. Outside container, top and inner basket in Polypropylene (Food-safe plastic). Aluminum handle.

Product Code	04-002-00204 (SD99)	04-002-00205 (SD92)
Dimension	Ø33 x 42cm	Ø43 x 50cm
Capacity	10ℓ Max: Up to 4 Heads of Lettuce	20ℓ Max: Up to 8 Heads of Lettuce



JIWINS PP Salad Spinner

Crankshaft handle. Patent design, innovative brakes effectively improve the service life of gear Sealed rotating system to ensure food safety. Meets hygiene standards of FDA.

Product Code	04-002-00337	04-002-00338
Dimension	Ø46.5 x 56.5cm	Ø39.5 x 47cm
Capacity	18.9ℓ	9.5ℓ



LACOR Stainless Steel Salad Spinner

Made of stainless steel. Dishwasher safe.

Product Code	04-002-00208
Dimension	Ø24cm
Capacity	4.5ℓ



A-STAR PLC Salad Spinner

Product Code	04-002-00202	04-002-00203
Colour	<input checked="" type="checkbox"/> Green	<input type="checkbox"/> White
Dimension	Ø26 x 17.2cm	
Capacity	6.2ℓ	



ESSEDUE Meat Slicer Machine with Safety Ring and Silver Table Bolt

Essedue slicers are produced to support all kinds of duty in slicing and the construction material used is always of the highest quality. specifically designed to simplify use, maintenance and cleaning. All material and protections used in slicers are designed to reflect food safety and absolute security during work preventing all possible risk.

Product Code	04-002-00211	04-002-00212(XX)	04-002-00213	04-002-00214	04-002-00215	04-002-00216
Dimension	70 x 46 x 60cm	71 x 57 x 47cm	60 x 33 x 50cm	55 x 36 x 45cm	43 x 29 x 43cm	42 x 24 x 30cm
Blade	Ø35cm	Ø35cm	Ø30cm	Ø25cm	Ø22cm	Ø19.5cm
Elec. Spec.	230V / 50Hz / 300W	230V / 50Hz / 300W	230V / 50Hz / 300W	230V / 50Hz / 245W	230V / 50Hz / 150W	230V / 50Hz / 132W
Model Ref.	#350	#350	#300	#250	#220	#195 w/ coil switch



04-002-00217



04-002-00218



ESSEDUE Black Anodized Meat Slicer Machine

Produced to support all kinds of duty in slicing and the construction material used is always of the highest quality. specifically designed to simplify use, maintenance and cleaning.

Product Code	04-002-00217	04-002-00218
Dimension	38 x 25 x 31cm	40 x 28 x 36cm
Blade	Ø19.5cm	Ø22cm
Elec. Spec.	230V / 50Hz / 110W	230V / 50Hz / 110W
Model Ref.	Vera Galaxy #195VG	Sirio Galaxy #220SR



FAC Manual Meat Slicer with Blade

Produced to support all kinds of duty in slicing and the construction material used is always of the highest quality. specifically designed to simplify use, maintenance and cleaning.

Product Code	04-002-00219(XX)
Blade	Ø30mm
Colour	Red

ACCESSORIES

- Accessories available upon request

S.A.P Meat Slicer with 1 Knife & 1 Plate

Hygienic, robust, easy to clean and use. Cast alloy structure, covered entirely with stainless steel. Self-ventilated motors. Gear motor consisting of 4 hardened steel gears enclosed in a leak-proof oil bath gearbox. Stainless steel hopper and meat collection tray. The mincing unit can be disengaged by simply turning a lever. All machine parts can be easily cleaned using a damp cloth.

Product Code	04-002-00229
Dimension	45 x 28 x 46cm Standard Mouth Ø5.2cm
Capacity	600kg/h 2.2hp
Elec. Spec.	230V / 50Hz / 1850W

ACCESSORIES

- Accessories available upon request



Meat Slicer Machine

Product Code	04-002-00225
Dimension	68 x 47 x 76cm
Blade	Ø32cm
Elec. Spec.	2 x 230V / 50Hz / 370W



Meat Slicer Machine

Product Code	04-002-00226
Dimension	54 x 35 x 47cm Blade Ø27.5cm
Elec. Spec.	230V / 50Hz / 400W



S.A.P Aluminium Tenderizer INTM

Cuts the meat fibres to tenderize the meat without ruining it. It can be used for tenderizing slices of raw or cooked meat, but is not suitable for use with meat containing bones or frozen meat. The machine, which is equipped with a gear transmission and easily removable stainless steel blades, complies with the strictest EC safety standards.

Product Code	04-002-00227
Dimension	44 x 17 x 48cm Surface Dimension: 16 x 38.5cm
Capacity	Cutting Capacity: 15 x 2cm Max Thickness 2cm
Elec. Spec.	230V / 50Hz / 150W



S.A.P Meat Slicer with 1 Knife & 1 Plate

Meat mincer made entirely of stainless steel, with a large capacity hopper complete with safety microswitch and large capacity mincing unit. The hopper can be removed to make cleaning easier and faster. When the machine's safety system detects that the hopper has been removed for cleaning, it disables all the machine functions. The cutting system consists of a feed screw, blade, plate and handwheel.

Product Code	04-002-00228(XX)
Dimension	40 x 73 x 93cm Neck: Ø11.5cm with safety net
Capacity	Output 1200kg/h 3.0hp
Elec. Spec.	230V / 50Hz / 2200W



04-002-00221



04-002-00222

S.A.P Aluminium Bone Saw

TYPE OF USE: Butchers shops, fishmongers, restaurants, canteens, frozen fish and meat industries. Cast metal machine body finished in nitro painted or anodized. Work table in stainless steel, adjustable blade tensioner, portion setter for cuts incorporated.

Product Code	04-002-00221	04-002-00222(XX)
Dimension	53 x 42 x 91cm Working Table: 41 x 41cm Usable Cut Height: 22.5cm Max Cut Height: 32cm	44 x 37 x 81cm Working Table: 33 x 33cm Usable Cut Height: 15cm Max Cut Height: 25cm
Capacity	1.0hp	1.0hp
Elec. Spec.	230V / 50Hz / 750W	230V / 50Hz / 750W
Model Ref.	Anodised Bone Saw SM183AEX	SM155VECO

ACCESSORIES

- **Accessories available upon request**



S.A.P Meat Mincer with 1 Knife & 1 Plate TC22PMCE

Manufactured with stainless steel case AISI 304, mincing unit, tray and hopper. The ideal device for meat mincing in general. Optional tools: Filling Funnels.

Product Code	04-002-00232
Capacity	250kg/h Plate hole 4.5mm 1.5hp
Elec. Spec.	230V / 50Hz / 1100W

ACCESSORIES:

- **Filling Set w/ 3 Funnels & 1 Propeller Stop for TC22PM:**
04-002-00233
- **Sausage Funnels for TC22MCE: 04-002-00234(XX)**
- **Plate for TC22PMCE:**
04-002-00235(XX)
04-002-00236(XX)
04-002-00237(XX)
04-002-00238(XX)
04-002-00239(XX)
04-002-00240(XX)
04-002-00241(XX)
- **Stainless Steel Knife for TC22PMCE: 04-002-00242(XX)**



S.A.P Meat Mincer with 1 Knife & 1 Plate TC12PMCE

Manufactured with stainless steel case AISI 304, mincing unit, tray and hopper. The ideal device for meat mincing in general. Optional tools: Filling Funnels.

Product Code	04-002-00243
Dimension	42 x 26 x 48cm Inox Mouth Ø70mm Standard Mouth Ø52mm
Capacity	100kg/h Plate hole 4.5mm 1.0hp
Elec. Spec.	230V / 50Hz / 750W

ACCESSORIES:

- **Filling Set w/ 2 Funnels & 1 Propeller Stop for TC12PM:**
04-002-00244
- *Accessories available upon request*



Electric Meat Mincer

Product Code	04-002-00340
Elec. Spec.	230V / 50Hz / 850W



WESTMARK Stainless Steel Meat Mincer

Mince meat coarsely, finely, or somewhere in the middle, make sausages, and bake with this Stainless Steel meat mincer. It has three interchangeable mincing plates (hole sizes 4 mm, 5 mm, and 8 mm), A funnel for making sausages, and a baking attachment for shaping dough. Its strong suction base ensures a secure hold on the worktop for safe use.

Product Code	04-002-00255
Dimension	27 x 12 x 16cm Plate Ø4/5/8mm



S.A.P Meat Mincer Grater with 1 Knife & 1 Plate TG12PMCE

Manufactured with stainless steel case AISI 304, mincing unit, tray and hopper. The ideal device for meat mincing in general. Optional tools: Filling Funnels.

Product Code	04-002-00249
Dimension	63 x 30 x 46cm Grater Mouth 14 x 7.5cm
Capacity	Mincer output: 160kg/h Grater output: 40kg/h 1.0hp
Elec. Spec.	230V / 50Hz / 750W

ACCESSORIES:

- **Plate for Meat Mincer Grater TC12PMCE (Ø4.5mm):**
04-002-00250(XX)
- *Accessories available upon request*



S.A.P Stainless Steel Sausage Filler

This SAP sausage filler machine has a unitized bearing structure with stainless steel movement and gears to reduce and overgear the stroke of the piston. The manual sausage filling machine is made of metal to ease the bag filling and piston extraction operations respectively. The sausage filling pipe is made of food grade stainless steel AISI 304/S.

Product Code	04-002-00258
Dimension	59 x 23 x 24cm
Capacity	5l 2 Speed



S.A.P Stainless Steel Vertical Sausage Filler INV7

Extremely robust, easy to handle and use. The sausage fillers have two speeds and interchangeable funnels for different types of sausage.

Product Code	04-002-00259
Dimension	30 x 30 x 71cm
Capacity	7l 2 Speed



S.A.P Stainless Steel Hydraulic Vertical Sausage Filler INV/ID22M

The vertical hydraulic sausage fillers are made in stainless steel and used for the processing of pork and beef. The knee control and the speed regulator of the piston allow the operator to work fluidly and in freedom during filling operation. Loaded from above by rotating and locking the cylinder in a vertical position through a mechanical safety device. The cylinder is removable and adjustable, making cleaning easier. Equipped with 4 wheels for easy handling and 3 stainless steel funnels: 12, 20, 28mm.

Product Code	04-002-00256(XX)
Dimension	52 x 57 x 119cm
Capacity	22kg 0.5hp Min. Emptying time 64min Piston reversal time 22min
Elec. Spec.	230V / 50Hz / 370W



FISCHER Round Steak Former

Ideal for shaping burgers.

Product Code	04-002-00261
Dimension	Ø10 x 9cm



ALEGACY Aluminium Round Hamburger Press

Makes uniform hamburger patties every time. Die-cast, polished finish of non-rusting aluminum alloy.

Product Code	04-002-00262
Dimension	Ø10 x 5cm



S.A.P Stainless Steel Vertical Sausage Filler INV14

Exceptionally strong, very easy to be handled and operated, the four models by-hand sausage fillers, size 7 - 14 liters vertical or horizontal, equipped with three funnels, are really the best for stuffing any kind of sausage. The 18/8 AISI 304 stainless steel cylinder, the food approved aluminium piston with special finishing, the solid rack, the precision gears and the accurate manufacturing of all mechanical details ensure a perfect working, the maximum efficiency and long life. The sausage fillers have two gears and they are equipped with three changeable funnels for different kinds of sausages.

Product Code	04-002-00257(XX)
Dimension	35 x 35 x 87.5cm
Capacity	27kg 14l 2 Speed



FISCHER Round Hamburger Press for Steak

Chopped meat pressing machines for hamburgers suction base ensures a secure hold on the worktop for safe use.

Product Code	04-002-00260
Dimension	Ø10 x 13.5cm



Manual Hamburger Press

Product Code	04-002-00263
Dimension	Ø10 x 26cm



IMPERIA Manual Commercial Noodle Machine

Rolls different pasta to varying thickness – chromed steel structure – stainless steel rollers – manual operations.

Product Code	04-002-00265
Dimension	32.5 x 22 x 27.5cm Roller 22cm



IMPERIA Simplex Cutter for 04-002-00265

Product Code	Dimension	Type
04-002-00266	Thickness 1.5mm	Capelli d' Angelo
04-002-00267	Thickness 2mm	Tagliatelle
04-002-00268	Thickness 4mm	Trenette
04-002-00269	Thickness 6.5mm	Fettuccine
04-002-00270	Thickness 12mm	Lasagnette
04-002-00271	Thickness 2mm	Spaghetti



IMPERIA Manual Noodle Machine

The Imperia Titania chromium-plated steel pasta machine is precision engineered in Italy, sturdy and built to last. Producing a 150mm leaf in 6 thicknesses which is then cut to 2mm (tagliatelle) or 6,5mm (fettuccine).

Product Code	04-002-00273
Dimension	18 x 13 x 20.5cm 150mm
Add. Info.	Non-Detachable



IMPERIA Manual Noodle Machine

The Imperia "iPasta" chromium-plated steel pasta machine is precision engineered in Italy, sturdy and built to last. With the Imperia and its "Duplex" cutter, you can make pasta dough in 6 different thicknesses and two types of pasta: tagliatelle and fettuccine.

Product Code	04-002-00272
Dimension	19 x 18.5 x 16cm
Add. Info.	Detachable



IMPERIA Simplex Cutter for 04-002-00272

Product Code	Dimension	Type
04-002-00274	Thickness 1.5mm	Capelli d' Angelo
04-002-00275	Thickness 4mm	Trenette
04-002-00276	Thickness 12mm	Lasagnette
04-002-00277	Thickness 32mm	Pappardelle
04-002-00278	Thickness 0.8mm	Capelli d' Angelo
04-002-00279	Thickness 2mm	Spaghetti
04-002-00280	Thickness 12mm	Reginette Lasagnette
04-002-00281	Thickness 44mm	Reginette



IMPERIA Motor for Imperia & Titania

The Electric Motor has two speed buttons, one speed for kneading the pasta and one speed for cutting the sheet of pasta. This attachment makes pasta making easier as two hands can be used to handle the dough. Overall preparation time is also significantly reduced.

Product Code	04-002-00282
Dimension	Ø10 x 13.5cm
Elec. Spec.	230V / 50Hz

*Can be used with 04-002-00272 and 04-002-00273



TINSO Dough Sheeter

Various thickness adjustment and final thickness can be fixed. For Pastries, Croissant, Pies, Biscuit, Pita, Tortillas and etc.

Product Code	04-002-00285(XX)
Dimension	300 x 96 x 110cm Conveyor: 63 x 290cm Roller: 88 x 63.5cm
Capacity	1hp
Elec. Spec.	415V / 50Hz



TINSO Dough Press

Dough Press Machine discharges air of the dough and makes the bread fine. Strong and durable. Low maintenance rate. Adjustable space.

Product Code	04-002-00286(XX)
Dimension	38 x 48 x 36cm Roller 30cm
Capacity	3/4hp



TINSO Planetary Dough Mixer Table Top

Thermal overload protection. Lasting and high pressure resistant grease. Heat-treated gear and alloy. Professional motor. Clutch gear technique.

Product Code	04-002-00291	04-002-00292
Dimension	30 x 40 x 55cm	36 x 47 x 61cm
Capacity	8l/1kg 150-630rpm 1/3hp	10l/1.5kg 150-630rpm 1/3hp
Elec. Spec.	230V / 50Hz / 210W	230V / 50Hz / 250W
Add. Info.	With Safety Guard	With 1 Bowl, 3 Fittings & Safety Guard



TINSO Planetary Dough Mixer

Heat treated gear and alloy. Powerful High Efficiency industrial motor. Thermal overload protection. Combined with 3 fittings (whisk, stirring hook, flat beater) to ensure all mixing requirements can be met.

Product Code	04-002-00287	04-002-00288	04-002-00289
Dimension	60 x 46 x 101cm	60 x 46 x 101cm	40 x 38 x 73cm
Capacity	30l/6kg 80/168/310rpm 3 Speed 1hp	20l/3kg 110/225/475rpm 3 Speed 1/2hp	10l/1.5kg 130/278/430rpm 3 Speed 1/3hp
Elec. Spec.	230V / 50Hz / 750W	230V / 50Hz / 370W	230V / 50Hz / 250W



TINSO Electric Dough Mixer without Safety Guard

Thermal overload protection. Lasting and high pressure resistant grease. Heat-treated gear and alloy. Professional motor.

Product Code	04-002-00290(XX)
Dimension	30 x 40 x 55cm
Capacity	8l/1kg 150-630rpm 1/3hp
Elec. Spec.	230V / 50Hz / 210W



TINSO Bread Slicer Machine



With safety guard. Safety loaf pusher.

Product Code	04-002-00304	04-002-00305(XX)
Dimension	68 x 63 x 73cm	62 x 63 x 61cm
Capacity	Standard 12mm 1/4hp 31 knives	Standard 12mm 1/4hp 27 knives
Elec. Spec.	230V / 50Hz / 186W	230V / 50Hz / 186W



KITCHENAID Planetary Dough Mixer KM7990X Professional

Wire guard and stop switch. For increased safety in a commercial environment. Full metal body construction, high precision metal gears and metal control knobs. Stable, quiet and durable.

Product Code	04-002-00293	04-002-00294	04-002-00295
Colour	 Empire Red	 Silver Metallic	 White
Dimension	41.9 x 28.7 x 3.1cm		
Capacity	6.9ℓ		
Elec. Spec.	230V / 50Hz / 325W		



KITCHENAID Planetary Dough Mixer KPM50 Professional

10 Speeds Control. Powerful enough for nearly any task or recipes, stirring wet and dry ingredients together, kneading bread dough or whipping cream. Delivers thorough ingredient incorporation. The beater, dough hook or wire whip rotates around the bowl, giving incredible bowl coverage for fast and complete mixing.

Product Code	04-002-00296	04-002-00297
Colour	 White	 Grey
Dimension	37 x 28 x 41cm	
Capacity	4.8ℓ	



KITCHENAID Stainless Steel Seaweed (Nori) Dryer

Product Code	04-002-00316	04-002-00317
Dimension	23.5 x 14.5 x 14cm	23.5 x 23.5 x 13cm
Elec. Spec.	230V / 50Hz	230V / 50Hz



EDLUND Electric Can Opener

These countertop electric can openers are especially suited for schools and hospitals or operations that need to open more than one size of cans. The slower second speed for smaller cans prevents spilling of liquids.

Product Code	04-002-00306	04-002-00307
Dimension	13 x 18 x 30.5cm	
Capacity	2 Speeds opens up to 75 cans per day	1 Speed opens up to 75 cans per day
Elec. Spec.	230V / 50Hz	
Model Ref.	#203	#266



EDLUND Electric Can Opener

The only NSF Certified electric can opener for heavy volume operators. This model is equipped with 2 speed motor and featuring knife and gear assemblies that can be removed without tools for easy cleaning. The slower second speed helps prevent spillage while opening smaller cans.

Product Code	04-002-00308	04-002-00309(XX)
Dimension	27 x 35 x 29cm	28 x 28 x 67cm
Capacity	2 Speeds opens up to 200 cans per day	2 Speeds opens up to 200 cans per day with Gas Shock Slide Bar
Elec. Spec.	230V / 50Hz	
Model Ref.	#270	#270C



EDLUND Air Powered Crown Punch with Magnetic Lid #610M

Each machine is complete with knife and guard ring locator for one standard size #10 round can. Comes with Magnetic Lid remover system. Opens 8 to 12 cans/ minute and up to 400 cans per day.

Product Code	04-002-00310(XX)
Capacity	Opens up to 400 cans per day
Model Ref.	#610M



EDLUND Heavy Duty Can Opener w/ Magnetic Lid Removal System #625M

Heavy Duty air powered crown punch for food processors and heavy usage operations. Opens 8 to 12 cans/ minute and up to 2000 cans per day. Requires 85 P.S.I at 1.5 to 2 C.F.M.

Product Code	04-002-00311(XX)
Capacity	Opens up to 2000 cans per day
Model Ref.	#625M



EDLUND Heavy Duty Air Powered Crown Punch Can Opener

Heavy Duty air powered crown punch for food processors and heavy usage operations. Requires 85 P.S.I at 1.5 to 2 C.F.M. Opens 8 to 12 cans/ minute.

Product Code	04-002-00312(XX)	04-002-00313(XX)
Capacity	Opens up to 2000 cans per day	Opens up to 3000 cans per day
Elec. Spec.	230V / 50Hz	
Model Ref.	#625	#625A



EDLUND Electric Hydraulic Can Crusher

This powerful unit will crush up to 10 cans per minute to a thickness of 1.25" and automatically drop the can into a receptacle. The cylinder recycles automatically. The cabinet and crusher box can be thoroughly cleaned.

Product Code	04-002-00315(XX)
Elec. Spec.	230V / 50Hz / 1900W
Model Ref.	CH5000



THE SOUS VIDE EXPERTS



BESSER VACUUM: MADE IN ITALY VACUUM

Besser Vacuum is a second generation Italian company, specialized in the production of **vacuum machines** for professional and domestic use, **smooth** and **embossed vacuum bags** for cooking and preservation, **sous vide cooking machines**, **traysealers** and **machines for polishing and sterilizing cutlery and glasses**. With several partners in 85 countries and three head offices: one near Udine (Italy), one near Barcelona (Spain) and one in Querétaro (Mexico), Besser Vacuum company has created a strong specialized network which is able to follow its customers at the very best way.



www.besservacuum.com



BESSER VACUUM

All Besser Vacuum products are manufactured by highly qualified staff in the company production floors, using material which has been thoroughly tested and of best quality, in accordance with all applicable national and international regulations. Besser Vacuum is certified ISO 9001:2008. Besser Vacuum offers more than 10 models of vacuum packaging machines. Choose from our selection of the following models to find the perfect size, dimension and power of your most suitable vacuum packaging machine for your valued business. Appealing Italian design and first-class technical components will grant you reliability, life-long resistance and a 100% safe product, wholly manufactured in respect of green economy and in compliance with social responsibility.



BESSER VACUUM Chamber Vacuum

Product Code	04-002-00348
Pump	6m ³ /h DVP
Welding Bar (Piston Seal Bar)	26cm
Chamber Dimensions	27 x 35 x 19cm
Display Type	Digital Display
Model Ref.	BREEZE



BESSER VACUUM Table Chamber Vacuum Machine w/ Gas Implant

Product Code	04-002-00324
Pump	6m ³ /h DVP
Welding Bar (Piston Seal Bar)	26cm
Chamber Dimensions	27 x 35 x 19cm
Display Type	LCD Display
Model Ref.	AUSTER



BESSER VACUUM Table Chamber Vacuum Machine w/ Gas Implant

Product Code	04-002-00323
Pump	8m ³ /h Busch
Welding Bar (Piston Seal Bar)	32cm
Chamber Dimensions	33 x 33 x 21.5cm
Display Type	LCD Display
Model Ref.	EOS



BESSER VACUUM Table Chamber Vacuum Machine w/ Gas Implant

Product Code	04-002-00321
Pump	21 / 25m ³ /h Busch
Welding Bar (Piston Seal Bar)	52cm
Chamber Dimensions	53 x 53 x 23.5cm
Display Type	LCD Display
Model Ref.	GHIBLI



BESSER VACUUM Table Chamber Vacuum Machine w/ Gas Implant Mistral

Product Code	04-002-00322
Pump	16 / 21m ³ /h Busch
Welding Bar (Piston Seal Bar)	42cm
Chamber Dimensions	43 x 43 x 22cm
Display Type	LCD Display
Model Ref.	MISTRAL



BESSER VACUUM Table Chamber Vacuum Machine with Special Options (Customised Model)

Comes with marinating Sensor, USB Printer, GN pans Suction Pipe and Inclined Shelf

Product Code	04-002-00350
Pump	16m ³ /h Busch
Welding Bar (Piston Seal Bar)	42cm
Chamber Dimensions	43 x 43 x 20cm
Display Type	LCD Display
Model Ref.	CUSTOMISED MODEL - MISTRAL



BESSER VACUUM Stainless Steel External Suction Vacuum Machine

Designed to meet the needs of small and medium businesses in the food industry, these external suction packaging machines are characterized by compactness, ease of use and professional vacuum. Made in stainless steel, display in 5 languages, double sealing and sector vacuum gauge, they are particularly suitable for sliced meats, cheese and vegetables. With the Inox Top machines it is also possible to seal cooking bags and vacuum liquid products in jars.

Product Code	04-002-00349
Dimension	Internal Dimension: 42 x 30 x 18cm Seal Bar: 33cm
Elec. Spec.	230V / 50Hz / 380W
Model Ref.	MINI



BESSER VACUUM External Suction Vacuum Machine Diva

Designed to meet the needs of domestic market, our external suction packaging machines are characterized by compactness, ease of use and professional vacuum. The ABS line is particularly suitable for sliced meats, cheese and solid vegetables. Do not use it to vacuum pack liquid products. We recommend the exclusive use of embossed bags to guarantee the correct operation of the machine and the effective sealing of the vacuum bag.

Product Code	04-002-00325
Dimension	38 x 18 x 11cm Seal Bar 33cm
Elec. Spec.	220V / 240V 50Hz / 60Hz
Model Ref.	DIVA



BESSER VACUUM Containers with Adaptor (Set of 2)

These transparent and dishwasher-safe vacuum containers for food are particularly suitable for liquid and indicated for preservation of fresh and/or precooked food. They have a lid with a valve and a suction pipe that, connected to the machine on one side and to the jars on the other, allows the air to be perfectly extracted from the container. The containers are suitable for external suction machines which have a nozzle to extract air from the jar.

Product Code	04-002-00326
Capacity	0.6l and 2.5l



BESSER VACUUM Stainless Steel External Suction Vacuum Machine Fresh

Designed to meet the needs of small and medium businesses in the food industry, these external suction packaging machines are characterized by compactness, ease of use and professional vacuum. Made in stainless steel with multilevel welding and high-performance vacuum pump, they are particularly suitable for sliced meats, cheese and vegetables. We recommend the exclusive use of embossed bags to guarantee the correct operation of the machine and the effective sealing of the vacuum bag.

Product Code	04-002-00320
Dimension	49 x 29.5 x 18cm Seal Bar 43cm
Elec. Spec.	230V / 50Hz / 450W
Model Ref.	FRESH



LACOR Economy External Suction Vacuum Machine

Improve the conservation of perishable products to significantly extend its life. So all the air vessel containing cooked food or natural is extracted and isolated those food sealing container to prevent air from entering.

Product Code	04-002-00327
Dimension	36 x 15 x 8.5cm
Elec. Spec.	230V / 50Hz / 1100W



CLIFTON Freeze Dryer

This cutting edge benchtop freeze dryer, known as the Cliftonfreeze dryer, offers sophistication and simplicity of use. It allows innovation in texture, flavour and appearance. Through experimentation and creativity you have the opportunity to be unique in the industry. Create your own flaked or powdered mushrooms, bananas, tomatoes, strawberries etc, giving full flavour and unusual mouthfeel and use as components to compliment your own culinary creativity.

Product Code	04-002-00328(XX)
Dimension	50 x 40 x 52cm

CLIFTON SOUS VIDE BATH

For consistent controlled cooking, Clifton water baths allows chefs to cook in a precise temperature controlled environment, to produce consistently perfect results. Ideal for sous vide and other low temperature cooking, these baths are an indispensable piece of equipment for all leading chefs worldwide.



CLIFTON Digital Unstirred Sous Vide Bath with Drain Tap

Product Code	04-003-00009
Dimension	33.2 x 53.8 x 29cm
Capacity	28ℓ
Elec. Spec.	230V / 50Hz / 1500W

ACCESSORIES:

- Immersion Grid 28ℓ for Unstirred Baths: 04-003-00010(XX)
- Bi Fold Lid for 04-003-00009: 04-003-00011(XX)



CLIFTON Digital Unstirred Sous Vide Bath with Drain Tap

Product Code	04-003-00015
Dimension	33.2 x 27 x 29cm
Capacity	8ℓ
Elec. Spec.	230V / 50Hz / 800W

ACCESSORIES:

- Immersion Grid 8ℓ for Unstirred Baths: 04-003-00016(XX)



CLIFTON Digital Unstirred Sous Vide Bath with Drain Tap

Product Code	04-003-00008(XX)
Dimension	53.7 x 33.2 x 36.5cm
Capacity	28ℓ
Elec. Spec.	230V / 50Hz / 1250W



CLIFTON Digital Unstirred Sous Vide Bath with Drain Tap

Product Code	04-003-00012(XX)
Dimension	53.7 x 33.2 x 24cm
Capacity	14ℓ
Elec. Spec.	230V / 50Hz / 1250W



CLIFTON Digital Unstirred Sous Vide Bath with Drain Tap

Product Code	04-003-00013
Dimension	36.1 x 33.2 x 29cm
Capacity	14ℓ
Elec. Spec.	230V / 50Hz / 1000W



CLIFTON Digital Unstirred Duobath with Drain Tap

Product Code	04-003-00014
Dimension	60 x 32 x 29cm
Capacity	2 x 8ℓ
Elec. Spec.	230V / 50Hz / 1600W



CLIFTON Accessory Partition Divider

This short stainless steel divider allows the working area of the bath to be divided for portion control. They separate the food into different sections for easy identification when cooking.

Product Code	04-003-00017(XX)	04-003-00018
Dimension	47cm	27cm



CLIFTON Foam Gun Holder

Used to attach the clips for the spray bottles to be firmly placed in the bath to ensure a constant temperature inside the bottles.

Product Code	04-003-00021
Capacity	For 8l Water Baths



CLIFTON Portable Clip-On Digital Immersion Circulator

Space saving clip on stirrer unit for chefs who travel and want portability or have limited space kitchens. Designed to clip onto a tank up to 56 litres. For consistent controlled cooking, Clifton stirrers allow chefs to cook in a precise temperature controlled environment, to produce consistently perfect results.

Product Code	04-003-00022
Dimension	Stirrer Case: 12.2 x 15.3 x 20cm Guard: 12.2 x 13.2 x 14.8cm
Elec. Spec.	230V / 50Hz / 1250W
Add. Info.	Display / Resolution: Digital LED/ 0.1°C / Temp. Range: Ambient + 5°C - 95°C Timer Duration: 1 minute - 99 hours

ACCESSORIES:

- Carrying Case for 04-003-00022: 04-003-00023(XX)



LACOR Sous Vide Water Bath (Semi Professional)

This cooker is made of stainless steel. Its design is compact and ergonomic, and has a user-friendly and intuitive control panel (includes the reset option).

Product Code	04-003-00294
Elec. Spec.	220-240V / 50-60Hz / 620W



CLIFTON Stainless Steel Flask Clip

The clip is used to attach spray bottles to a water bath.

Product Code	04-003-00019	04-003-00020
Capacity	For 500ml	For 1000ml



BESSER VACUUM Thermo-Circulator Vacook

Professional thermal circulator for sous vide cooking made in stainless steel (Aisi 304), metal touch screen, LCD display for cooking time display, offset for water temperature control and precision core probe, integrated App that allows remote Wi-Fi control up to a maximum of 10 machines at the same time, program that allows you to work with several cooking phases and delayed start to optimize time and costs.

Product Code	04-003-00024
Dimension	13 x 26 x 34cm
Elec. Spec.	230V / 50Hz / 2000W Temp Range: 20°C - 95°C Temp Precision: ±0.1°C



BESSER VACUUM Thermo-Circulator without Probe

Professional thermal circulator for sous vide cooking made in stainless steel (Aisi 304), metal touch screen, LCD display for cooking time display, offset for water temperature control and precision core probe, integrated App that allows remote Wi-Fi control up to a maximum of 10 machines at the same time, program that allows you to work with several cooking phases and delayed start to optimize time and costs.

Product Code	04-002-00351
Dimension	15 x 24 x 38cm
Capacity	50l
Elec. Spec.	230V / 50Hz / 1650-2100W Temp Range: 0.1°C - 95°C Temp Precision: ±0.1°C



BESSER VACUUM Thermo-Circulator

New immersion thermal circulator for sous vide cooking entirely made in stainless steel (Aisi 304), designed for those who are beginners with sous vide cooking, equipped with an LCD touch screen and a Bluetooth system that allows you to control the cooking process remotely by using an interactive App. Suitable for all heat-resistant containers able to contain up to 25l.

Product Code	04-002-00352
Dimension	11.5 x 9 x 35.5cm
Capacity	20l
Elec. Spec.	230V / 50Hz / 1100W Temp Range: 0.1°C - 95°C Temp Precision: ±0.1°C



LACOR Sous Vide Stick (Semi Professional)

Professional thermal circulator for sous vide cooking made in stainless steel (Aisi 304), metal touch screen, LCD display for cooking time display, offset for water temperature control and precision core probe, integrated App that allows remote Wi-Fi control up to a maximum of 10 machines at the same time, program that allows you to work with several cooking phases and delayed start to optimize time and costs.

Product Code	04-003-00293	04-003-00288
Colour	<input type="checkbox"/> White	<input checked="" type="checkbox"/> Black
Elec. Spec.	220-240V / 50Hz / 800W	



EXCALIBUR 9 Tray Dehydrator with 26 Hr Timer

Dehydrate fruits, vegetables, nuts, meat for jerky, fruit puree for fruit roll-ups, raise bread or make homemade yogurt.

Product Code	04-003-00030
Dimension	43.2 x 48.3 x 31.8cm
Capacity	10 Trays
Elec. Spec.	230V / 50Hz / 600W



SEDONA 9 Tray Dehydrator P9000

built with technologically advanced systems to elegantly and easily dehydrate raw, whole-living foods. The quiet dual fan technology provides energy efficiency allowing you the option to dehydrate with all 9 trays or just half the trays for smaller batches. The digital thermostat maintains the ideal temperature for optimum dehydration, while the digital time provides worry-free operation.

Product Code	04-003-00031
Dimension	43 x 37 x 50cm
Elec. Spec.	230V / 50Hz / 650W



NEMOX Table Top Gelato Ice Cream Storage & Display Case 4 Magic Pro 100

Store your fresh ice cream, gelato, and sorbets at the ideal temperature for quick dispensing and serving. The Nemox Pro 100 is the only countertop ventilated gelato-ice cream storage and display case specifically designed for restaurants, caterers, coffee shops, and gourmet shops.

Product Code	04-003-00044
Dimension	98 x 50.5 x 36cm
Capacity	4 x 2.5l 4 Magic Pro 100
Elec. Spec.	230V / 50Hz / 270W





NEMOX Gelato Cart Equipped with Automatic Storage, Stainless Steel Case and Mixing Paddle 10K Crea

The machine is equipped with sophisticated software that manages its functions. In addition to the normal manual function, the operator has at his disposal:

- 4 Specific production programs (Gelato Classico – Semi-Soft Ice Cream – Granita – Shock freezing).
- 4 Specific storage programs selectable depending on the different needs and characteristics of the product.

These automatic programs, as well as ensuring the best results, make the machine completely autonomous, leaving the operator free to focus on other tasks.

Product Code	04-003-00034(XX)
Dimension	45 x 59.5 x 105cm
Max Production/Hr Weight & Volume	10kg / 14ℓ
Reduction Speed	60-130rpm
Elec. Spec.	230V / 50Hz / 1100W
Model Ref.	10K



NEMOX Gelato Cart with Storage Case 5 Magic Pro 125

The refrigerated cart is equipped with temperature control and holds 5 pans of 3,0 L (3.3 qt) each. It is an ideal display for your production of gelato, ice-cream and sorbet, and is protected by a transparent oval cover. A long electrical wire allows to move the cart. When disconnected from the outlet, gelato can be maintained for 15-30 min. depending from the room temperature.

Product Code	04-003-00043(XX)
Dimension	82 x 114 x 106cm
Capacity	5 x 2.5ℓ
Elec. Spec.	230V / 50Hz / 300W



NEMOX Table Top Gelato Ice Cream Maker with Gravity Drain

Functional, powerful, fast and convenient, it grants the highest quality in gelato/ice cream and sorbet preparation. Equipped with drain system for easy cleaning.

Product Code	04-003-00035(XX)	04-003-00036
Dimension	58 x 53 x 45cm	46.5 x 48 x 39.5cm
Max Production/Hr Weight & Volume	7kg / 10ℓ	5kg / 7ℓ
Reduction Speed	55-115rpm	70rpm
Elec. Spec.	230V / 50Hz / 800W	230V / 50Hz / 650W
Model Ref.	6K	5K



NEMOX Table Top Professional Multifunction Machine Frix Air

FRIXAIR is easy and fun to use; it enhances the capabilities and fantasies of the professional user. With FRIXAIR you can offer an imaginative and diverse menu to tease your customer's palate every day, and with a minimal effort. FRIXAIR speeds preparation of appetizers, entrées, main courses, and desserts. FRIXAIR is ideal for making mousse, sorbets, ice cream, sauces and soups, cocktails and hors d'oeuvres.

Product Code	04-003-00046
Dimension	20.5 x 33 x 49.5cm
Capacity	Cup Vol: 300mℓ / Ingredient Vol: 150mℓ
Elec. Spec.	230V / 50Hz / 600W

ROLLER GRILL DEEP FRYER

The cold zone enables you to fry successively in the same oil for French fries, fish, donuts, etc. The temperature of the oil at the bottom of the tank and above the resistance has a differential of 100°C. This cold zone at the bottom of the fryer consists of an automatic filtering of the oil by settling and decanting. This electric fryer range is equipped with a precise bulb-thermostat for the regulation of temperature (0-180°C) and with a double safety thermostat with positive cutoff. Both thermostats are in stainless steel. In the event of overheating or insufficient oil, the safety thermostat automatically stops the stainless steel fryer. After identifying the cause of the automatic shutdown, the safety thermostat must be reset by simply pressing a push button behind the stainless steel housing.



ROLLER GRILL Single Deep Fryer FD50

Product Code	04-003-00073
Dimension	21.5 x 42.5 x 32cm Basket: 14 x 26 x 10cm
Capacity	5ℓ 10kg/h
Elec. Spec.	230V / 50Hz / 3200W

ACCESSORIES:

- 4ℓ Basket for RF3S, FD50 & FD50D: 04-003-00074



ROLLER GRILL Single Deep Fryer FD80

Product Code	04-003-00069
Dimension	28 x 42.5 x 32cm Basket: 22 x 26 x 10cm
Capacity	8ℓ 15kg/h
Elec. Spec.	230V / 50Hz / 3600W



ROLLER GRILL Single Deep Fryer with Tap FD80R

Product Code	04-003-00070
Dimension	30.5 x 45 x 36cm Basket: 22 x 26 x 10cm
Capacity	8ℓ 15kg/h
Elec. Spec.	230V / 50Hz / 3600W

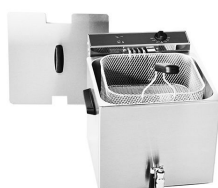

ROLLER GRILL Single Deep Fryer with Stainless Steel Tap MF120R

Product Code	04-003-00284
Dimension	35 x 47 x 35cm
Capacity	12ℓ
Elec. Spec.	380V / 3 / 6400W



ROLLER GRILL Double Deep Fryer FD50D

Product Code	04-003-00064
Dimension	39 x 42.5 x 32cm Basket: 2 x (14 x 26 x 10cm)
Capacity	2 x 5ℓ 20kg/h
Elec. Spec.	2 x (230V / 50Hz / 3200W)

ACCESSORIES:

- 4ℓ Basket for RF3S, FD50 & FD50D: 04-003-00074



ROLLER GRILL Double Deep Fryer FD80D

Product Code	04-003-00062
Dimension	54 x 42.5 x 32cm Basket: 2 x (22 x 26 x 10cm)
Capacity	2 x 8ℓ 30kg/h
Elec. Spec.	2 x (230V / 50Hz / 3600W)



ROLLER GRILL Modular Double Deep Fryer with Tap RFE8D

Product Code	04-003-00057
Dimension	40 x 60 x 46.5cm Basket: 12.8 x 32 x 14.5cm
Capacity	2 x 8ℓ
Elec. Spec.	2 x (230V / 50Hz / 3000W)



ROLLER GRILL Double Deep Fryer with Stainless Steel Tap MF120DR

Product Code	04-003-00283
Dimension	72 x 47 x 35cm
Capacity	2 x 12ℓ
Elec. Spec.	380V / 3 / 2 x 6400W



04-003-00049



04-003-00050



04-003-00051/00048

CROWN Stainless Steel Deep Fryer

Built with full stainless steel body and thermal pipe, these deep fryers can give you perfect and fast fried food. They come with adjustable temperature control. Safe and easy to maintain.

Product Code	04-003-00050	04-003-00049	04-003-00051	04-003-00048
Dimension	19.5 x 34.5 x 35cm	28.5 x 44.5 x 32cm	28 x 52 x 35cm	30 x 56.6 x 36.3cm
Capacity	Up to 3ℓ	Up to 5ℓ	Up to 6ℓ	Up to 7ℓ
Elec. Spec.	220-240V / 50Hz / 3000W	220-240V / 50Hz / 3000W	220-240V / 50Hz / 3000W	220-240V / 50Hz / 3000W



PRO EQUIP Single Deep Fryer

Product Code	04-003-00072
Dimension	44.5 x 28 x 37cm
Capacity	8ℓ
Elec. Spec.	230 / 50Hz / 2800W



PRO EQUIP Double Deep Fryer

Product Code	04-003-00063
Dimension	44.5 x 56 x 37cm
Capacity	2 x 8ℓ
Elec. Spec.	2 x (230 / 50Hz / 2800W)



PRO EQUIP Single Deep Fryer

Product Code	04-003-00067
Dimension	55.5 x 29 x 37cm
Capacity	12ℓ
Elec. Spec.	230V / 50Hz / 2800W



PRO EQUIP Double Deep Fryer

Product Code	04-003-00061
Dimension	56 x 59 x 37cm
Capacity	2 x 12ℓ
Elec. Spec.	2 x (230 / 50Hz / 2800W)

ACCESSORIES:

- Fry Basket for 04-003-00067: 04-003-00068



PRO EQUIP Single Deep Fryer

Product Code	04-003-00075
Dimension	44.5 x 27.5 x 37cm
Capacity	5ℓ
Elec. Spec.	230 / 50Hz / 2800W





ROLLER GRILL *Electric Egg Boiler C060*

Essential for your breakfast buffets, this Gastronorm eggs boiler GN 1/3 allows your customers to boil their own eggs for breakfast according to their cooking preference. Comes with 6 egg baskets.

Product Code	04-003-00076
Dimension	43 x 21.5 x 25.5cm



ROLLER GRILL *Double Pizza Oven PZ430D*

Independent cooking chambers for Ø41cm pizzas. Infrared quartz tubes (1050°C). Double insulation of the door with tempered-glass window.

Product Code	04-003-00077
Dimension	67 x 58 x 50cm Internal Dimension: 2 x (43 x 11 x 43cm)
Elec. Spec.	380V / 50Hz / 6000W Single Phase



WARING *Heavy-Duty Commercial Conveyor Toaster CTS1000E*

Ultra fast 4 minute heat up. Conveyor speed control. Standby function for energy conservation during low volume periods.

Product Code	04-003-00124
Dimension	43 x 47 x 41.5cm
Capacity	1000toasts/h 5cm opening
Elec. Spec.	230V / 50Hz / 2700W



PRO EQUIP *Conveyor Toaster*

Product Code	04-003-00126
Dimension	53 x 36.5 x 41cm
Capacity	500 slices/hr
Elec. Spec.	230V / 50Hz / 2300W



ROLLER GRILL *Single Pizza Oven PZ430S*

Independent cooking chambers for Ø41cm pizzas. Infrared quartz tubes (1050°C). Double insulation of the door with tempered-glass window.

Product Code	04-003-00079
Dimension	67 x 58 x 27cm Internal Dimension: 43 x 11 x 43cm
Elec. Spec.	230V / 50Hz / 3000W



ROLLER GRILL *Electric Conveyor Toaster CT3000*

Non-stop toasts from breads and buns to waffles, bagels and muffins with no pre-heating required. Heating power (half or full). 8 infrared quartz tubes (1550W top, 1450W bottom) with protection grid. Comes with a deputed control box with a 1m cord for installation flexibility.

Product Code	04-003-00083
Dimension	72 x 47 x 38.5cm Cooking Area: 37 x 30cm Height: 7.9 / 11cm
Time	1min 30s
Elec. Spec.	230V / 50Hz / 3000W



ROLLER GRILL *Electric Conveyor Toaster CT540B*

Ideal for breakfast buffet, this heavy duty versatile conveyor toaster toasts everything, waffles, bagels to muffins and even from bread to buns with no preheating. 8 quartz tubes (1200W top, 1450W bottom).

Product Code	04-003-00125
Dimension	68 x 50 x 34.5cm Cooking Area: 33 x 33.5cm Height: 8.5cm
Capacity	300-540 toasts/h
Elec. Spec.	230V / 50Hz / 2650W



ROLLER GRILL *Electric Glass Ceramic Movable Salamander with Plate Detection System SEM600PDS*

As soon as the PDS (Plate Detection System) function is selected the vitro-ceramic plate automatically heats up when the plate is in contact with the bar above the grid, and goes off when the tray is removed. Automatic switch on, instantaneous cooking and energy saving. Power control system: The most precise regulation today for vitro-ceramic version. Precise and various cooking. Flexibility and energy control.

Product Code	04-003-00106
Dimension	60 x 64 x 59cm Cooking Area: 49.5 x 37.5cm
Elec. Spec.	230V / 50Hz / 3000W



ROLLER GRILL *Electric Quartz Movable Salamanders SEM600Q*

Infrared quartz tubes (1050°C) to grill and glaze plates very quickly. 2 areas with 4 lamps each.

Product Code	04-003-00107
Dimension	60 x 59 x 59cm Cooking Area: 49.5 x 37.5cm
Elec. Spec.	230V / 50Hz / 3000W



ROLLER GRILL *Electric Toaster / Salamander*

Basic equipment for cafes, pubs and snack bars, the infrared quartz toaster with 1 or 2 levels cooks or reheats all kinds of cheese sandwiches, croque-monsieur, pizzas, quiches, cheese/meat puffs, croissants. It even browns onion soups, toasts baguettes and bread etc. Instantly cooking at core with no smoke or odour thanks to the rays of the infrared quartz tubes (1050°C) Fast temperature rise in less than 30s. Removable back panel for an easy cleaning.

Product Code	04-003-00101	04-003-00102
Dimension	45 x 28.5 x 30.5cm Grill: 35 x 24cm	45 x 28.5 x 42cm Grill: 35 x 24cm
Capacity	150 toasts/h 1 level	300 toasts/h 2 levels
Elec. Spec.	230V / 50Hz / 3000W	230V / 50Hz / 2000W



ROLLER GRILL *Electric Glass Ceramic Movable Salamander with Plate Detection System SEM800PDS*

The SEM800-PDS puts versatile powerful performance at the heart of your kitchen. Ideal for grilling and finishing, precise height adjustment system allows right heat to food giving quality results on time every time.

Product Code	04-003-00103
Dimension	80 x 64 x 59cm Cooking Area: 70 x 37.5cm
Elec. Spec.	380V / 50Hz / 4500W



ROLLER GRILL *Electric Quartz Movable Salamanders SEM800Q*

Clean efficient quartz tubes with infrared elements which minimise smoke and odours, the speed of cooking and the rapid heat up time saves on energy consumption without compromising on performance.

Product Code	04-003-00105(XX)
Dimension	80 x 64 x 59cm Cooking Area: 74 x 37.5cm
Elec. Spec.	380V / 50Hz / 4500W



04-003-00130



04-003-00131

ROLLER GRILL *Electric Quartz Toaster*

GN 1/1 size salamander toasters. To defrost, brown, glaze, grill, or toast in quantity your quiche, sandwiches with cheese, pizza, toasts with no preheating, smoke or odours thanks to the rays of infrared quartz tubes (1050°C). Tray is fitted with handles for fast service.

Product Code	04-003-00130 TS1270	04-003-00131 TS3270
Dimension	64 x 38 x 33cm Grill: 52 x 32cm	64 x 38 x 47.5cm Grill: 2 x (52 x 32cm)
Capacity	1 level	2 levels
Elec. Spec.	230V / 50Hz / 2700W	380V / 50Hz / 4000W



WARING Heavy-Duty 4-Slots Combination Toaster WCT850K

The powerful, versatile Waring WCT850 heavy duty 4 slot commercial toaster quickly and easily toasts breads, bagels, Texas toast, and even frozen waffles! At the flip of a switch, you can select the "bagel" setting to toast just one side while warming the other, or the "bread" setting to toast on both sides, for perfect results every time.

Product Code	04-003-00127
Dimension	22.8 x 30 x 33cm
Capacity	Slot Width: 5 x 1.2cm
Elec. Spec.	230V / 50-60Hz / 2800W



WARING 4-Slots Toaster WCT708E

Toast up to 225 slices per hour with the Waring® WCT708 Medium-Duty 4-Slot Toaster. Electronic browning controls let you set separate browning levels for each set of slices. Four extra-wide slots and self-centering bread racks are perfect for bagels, sliced bread and more

Product Code	04-003-00128
Dimension	60 x 46 x 10cm
Capacity	Slot Width: 4.3cm 225 toasts/h
Elec. Spec.	230V / 50Hz / 1800W



Stainless Steel 4-Slots Toaster

Product Code	04-002-00354
Dimension	34 x 23 x 25cm
Elec. Spec.	230V / 50Hz / 2300W



Stainless Steel 6-Slots Toaster

Product Code	04-002-00355
Dimension	46 x 29 x 25cm
Elec. Spec.	230V / 50Hz / 3000W



SHARP Stainless Steel Touch Control Microwave Oven

Express Defrost Key with 3 Menus. Wide 272 mm Turntable. Compact and Space-saving Design. 3 Auto Menu Keys. 2 Reheat Menu Keys. Instant Cook. Easy Defrost. More/Less Setting. Slow Cook Key. Child Lock.

Product Code	04-003-00100
Dimension	46 x 38 x 27.5cm
Capacity	22ℓ
Elec. Spec.	230-240V / 50Hz / 800W



SHARP Stainless Steel Touch Control Microwave Oven

Express Defrost Key with 3 Menus. 6 Microwave Power Levels. 2 Reheat Menu Keys. Easy Defrost. Slow Cook Key. Child Lock. Alarm Function.

Product Code	04-003-00099
Dimension	52 x 44.7 x 31cm
Capacity	33ℓ
Elec. Spec.	230-240V / 50Hz / 1100W



SAMSUNG Solo Microwave Oven

Quick Defrost for fast thawing of meat. Auto Cook programme for easy cooking. Ceramic Inside™ protects from scratches and discolouration.

Product Code	04-003-00098
Dimension	48.9 x 37.4 x 27.5cm
Capacity	23ℓ
Elec. Spec.	230V / 50Hz / 800W
Colour	Black



SAMSUNG Stainless Steel Wide Grill Microwave Oven

SLIM FRY™ technique for Healthier Crispy cooking. Smart Moisture Sensor maintains optimal humidity. Wide Grill enhanced grilling and browning effects.

Product Code	04-003-00097
Dimension	52.3 x 30.9 x 50.6cm
Capacity	32ℓ
Elec. Spec.	900W



MENUMASTER Commercial Microwave Oven

Faster cooking, steaming and re-therming. Excellent food quality, with more throughput. No vent hood required. No costly hood. Economical installation, saves money.

Product Code	04-003-00093 DEC14E2	04-003-00094 DEC18E2
Dimension	34.3 x 41.9 x 54.9cm	34.3 x 41.9 x 54.9cm
Capacity	17ℓ	17ℓ
Elec. Spec.	230V / 50Hz / 1400W	230V / 50Hz / 1800W
Add. Info.	#203	#266



MENUMASTER Commercial Microwave Oven MRC22S2

Unique top and bottom energy distribution. Fast even cooking. Consistent results and excellent food quality. Sealed in place ceramic cooking shelf. No spills leak under the oven floor. Easy to clean.

Product Code	04-003-00095(XX) MRC22S2
Dimension	46 x 48.9 x 64.8cm
Capacity	28ℓ
Elec. Spec.	230V / 50Hz / 2200W



MENUMASTER Commercial Microwave Oven RCS511TS

Quick heating. Consistent results. Stainless steel construction inside and out. Durable, professional finish. Withstands the foodservice environment.

Product Code	04-003-00096(XX) RCS511TS
Dimension	35.2 x 55.9 x 48.3cm
Capacity	34ℓ
Elec. Spec.	230V / 50Hz / 1100W



ROLLER GRILL Turbo Quartz Baking Oven with Steam FC110EG

Perfect Baking through Controlled Technology. The Roller Grill FC110EG features a heavy duty turbine with auto reverse function. The integral Quartz/infrared grill is perfect for browning gratinating and grilling of meats etc whilst still benefiting from the circulated air. Push button stream injection(requires water supply) applies a pre-set quantity of water at high temperature enhancing the baking experience.

Product Code	04-003-00114
Dimension	79.5 x 72 x 60cm



ROLLER GRILL Multifunction Turbo Quartz Convection Oven

Unique in catering, the multifunction oven FC60TQ associates :
 - Ventilated air : for homogeneous cooking of different meals at the same time
 - Ventilated pastry oven. The lower armoured heating element is running at full power.
 - Turbo Quartz : traditional oven associating top quartz and bottom armoured heating element to the ventilation system. Cooking time is reduced
 - Quartz grill : ventilated salamander essential to brown, broil or glaze.

Product Code	04-003-00115
Dimension	59.5 x 61 x 59cm Internal: 47 x 37 x 35cm
Capacity	60ℓ / 4 levels
Elec. Spec.	230V / 50Hz / 3000W



ROLLER GRILL Stainless Steel Electric Convection Oven FC380TQ

Supplied with 3 cooking grids, 1 pastry tray. Homogenous cooking ensuring a perfect circulation of air. Reinforced insulation. Associates convection, Turbo Quartz, top quartz grill salamander, ventilated bakery oven and defrosting.

Product Code	04-003-00116
Dimension	55 x 55 x 35.5cm Internal: 41.5 x 35 x 26.5cm
Capacity	38ℓ / 4 levels
Elec. Spec.	230V / 50Hz / 2400W



CUISINART Convection Oven

Stainless steel and industrial style design with 1500 watts capability, and 260 °C temperature range. Precise toast shade dial, tinted glass oven door, 0.6 cu. ft. Nonstick coating covers the interior to make cleaning easy and quick.

Product Code	04-003-00303
Dimension	44 x 29 x 25cm
Capacity	17ℓ
Elec. Spec.	220-240V / 50Hz / 1500W



ROLLER GRILL Stainless Steel Electric Convection Oven FC280

Supplied with 2 cooking grids, 1 pastry tray. Homogenous cooking ensuring a perfect circulation of air. Reinforced insulation.

Product Code	04-003-00118
Dimension	46 x 55 x 35cm Internal: 32 x 32.5 x 26.5cm
Capacity	28ℓ / 2 levels
Elec. Spec.	230V / 50Hz / 1500W



Roast Pig Furnace

Product Code	04-003-00092(XX)
Dimension	110 x 60 x 60cm



LACOR Electric Convection Halogen Glass Oven

Allows you to save time and energy, because the heated volume is much less of a conventional oven and its high efficiency in the movement of hot air inside; compared with conventional ovens energy consumption is reduced by 20% .

Product Code	04-003-00119(XX)
Dimension	41 x 33 x 31cm
Capacity	12ℓ
Elec. Spec.	230V / 50Hz / 1400W



Roast Duck Oven (Gas)

Product Code	04-003-00091(XX)
Dimension	Ø60 x 125cm



ROLLER GRILL Smoking Oven FM2

Smoking is carried out at low temperature to eliminate excess water, without drying out the product or turning it crispy. Smoke is produced by the slow burning of oak sawdust and then gets cooled in the smoke oven to provide even cooking.

Product Code	04-003-00087
Dimension	71.5 x 41.5 x 23cm Cooking Grid: 40 x 60cm
Elec. Spec.	230V / 50Hz / 250W



CCK Metal Stove (Apollo Stove) without Base

Product Code	04-003-00264
Dimension	26.5 x 21.5cm
Add. Info.	Can be used with 04-003-00091(XX)



ROLLER GRILL *Electric Crepe Machine with Enamelled Cast Iron Plate CSE350*

Enamelled cast iron plate produces moist pancakes, buckwheat cakes and more. Also popular in Asian cuisine for preparing Peking duck skins. Drawer for keeping dishes or pre-cooked crepes warm. Spiral heating elements distribute heat evenly, essential when it comes to making the perfect pancake. Includes wooden crepe spreader.

Product Code	04-003-00138
Dimension	50 x 45 x 24cm Crepe Surface: Ø35cm
Elec. Spec.	230V / 50Hz / 3000W



ROLLER GRILL *Electric Crepe Machine with Enamelled Cast Iron Plate CSE400*

Enamelled cast iron plate produces moist pancakes, buckwheat cakes and more. Also popular in Asian cuisine for preparing Peking duck skins. Drawer for keeping dishes or pre-cooked crepes warm. Spiral heating elements distribute heat evenly, essential when it comes to making the perfect pancake. Includes wooden crepe spreader.

Product Code	04-003-00142
Dimension	50 x 45 x 24cm Crepe Surface: Ø40cm
Elec. Spec.	230V / 50Hz / 3600W



ROLLER GRILL *Gas Crepe Machine with Enamelled Cast Iron Plate CSG400*

The key to the great performance of the 400CSG is the specially designed 8 point star shaped burner positioned directly under the plate to distribute the heat evenly, essential when making the perfect crepe.

Product Code	04-003-00145(XX)
Dimension	45 x 50 x 24cm Crepe Surface: Ø40cm
Elec. Spec.	3200W



PRO EQUIP *Mobile Single Crepe Machine*

Product Code	04-003-00141
Dimension	42 x 40 x 13.5cm Crepe Surface: Ø40cm
Elec. Spec.	230V / 50Hz / 2700W



ROLLER GRILL *Mobile Electric Crepe Machine with Enamelled Cast Iron Plate CFE400*

High capacity crepe machines. High power output for outdoor use. Enamelled cast-iron plate 400 mm. Delivered with speler. spiral heating element integrated under the cast iron plate, thermostat 0 to 300°C, pilot light.

Product Code	04-003-00139
Dimension	Ø40 x 20cm
Elec. Spec.	230V / 50Hz / 3600W



ROLLER GRILL *Electric Double Crepe Machine Enamelled Plates*

The sturdy clean design gives the perfect front of house platform for crepes, pancakes, chapatti, blini etc. but also for other menu items, griddled eggs for example. The hard enamelled cast iron plates give good heat retention and provide a smooth, hard wearing cooking surface requiring minimal oil and no pre-seasoning.

Product Code	04-003-00143(XX) CDE400	04-003-00144(XX) CDG400
Type	Electric	Gas
Elec. Spec.	380V / 50Hz / 7200W	6400W
Dimension	86 x 50 x 24cm Crepe Surface: Ø40cm	



ROLLER GRILL *Mobile Gas Single Crepe Machine with Enamelled Cast Iron Plate CFG400*

The simple design of the 400CFG gives you greater mobility without sacrificing performance. Specially designed with 8 point star shaped burners to distribute heat evenly, essential when making the perfect crepe. The hard enamelled cast iron plates make delicious, moist, golden pancakes but also chapatti, blini etc.

Product Code	04-003-00146(XX)
Dimension	86 x 50 x 24cm Crepe Surface: Ø40cm
Elec. Spec.	3600W

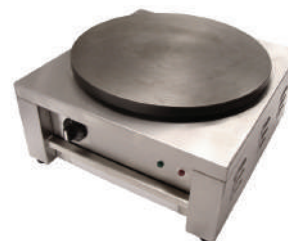

PRO EQUIP *Single Crepe Machine*

Product Code	04-003-00140
Dimension	43 x 44.5 x 23cm Crepe Surface: Ø40cm
Elec. Spec.	230V / 50Hz / 2700W



ROLLER GRILL *Crepe Kit*

A must toolkit for all RollerGrill crepe models. Contains 2 spatulas, 2 wooden T spreader, 1 greasing pad.

Product Code	04-003-00154(XX)
--------------	------------------



ROLLER GRILL *Electric Hot Dog Machine CS3E*

Store up to 40 sausages in the 2-section basket keeping the cooked sausages separate from the uncooked. 3 pads toast the baguette or bun on the inside.

Product Code	04-003-00132	04-003-00133
Dimension	44 x 30 x 40cm Glass Cylinder: Ø20 x 24cm	Basket for CS3E
Elec. Spec.	230V / 50Hz / 650W	



ROLLER GRILL *Electric Sausage Roller RG9*

These roller grills keep up to 20 pre-cooked sausages warm, i.e. 96 hot dogs per hour! Optimal output thanks to 125 W power per roll. Chrome-plated rolls ensure easy cleaning and durability. Length of the rolls: 40 cm.

Product Code	04-003-00136
Dimension	54.5 x 46 x 24cm
Capacity	9 Rolls
Elec. Spec.	230V / 50Hz / 1100W



ROLLER GRILL *Double Waffle Iron*

Highly conductive iron plates spread heat evenly and give golden, crispy waffles in 2.5 minutes. Suitable for cooking fresh or frozen waffles. A removable drip tray surrounding the bottom plate will collect any excess batter. 2 McCain version Liège moulds, featuring 4 x 6 squares (15 x 18 mm) Roller Grill waffle irons accept deep-frozen, frozen precooked waffles or home-made batter. Delivered with fork.

Product Code	04-003-00148(XX)	04-003-00149
Dimension	55 x 44 x 23cm Waffle Size: 10 x 17 x 2.2cm	55 x 44 x 23cm Waffle Size: 10 x 18 x 2.6cm
Elec. Spec.	230V / 50Hz / 3200W	230V / 50Hz / 3200W



ROLLER GRILL *Electric Sausage Bun Warmer CB20*

Keeps buns warm to make hot and soft hot dogs. The drawer can be removed and the GN 2/3 size inner container can be washed in a dishwasher. Place below sausage roller grill to save space.

Product Code	04-003-00134
Dimension	54.5 x 46 x 22cm
Elec. Spec.	230V / 50Hz / 700W



ROLLER GRILL *Electric Sausage Roller RG7*

These roller grills keep up to 20 pre-cooked sausages warm, i.e. 96 hot dogs per hour! Optimal output thanks to 125 W power per roll. Chrome-plated rolls ensure easy cleaning and durability. Length of the rolls: 40 cm.

Product Code	04-003-00135
Dimension	54.5 x 32 x 24cm
Capacity	7 Rolls
Elec. Spec.	230V / 50Hz / 900W



ROLLER GRILL *Single Waffle Iron GES10*

Brussels moulds featuring 3 x 5 squares (20 x 25 mm) Roller Grill waffle irons accept deep-frozen, frozen precooked waffles or home-made batter. Delivered with fork.

Product Code	04-003-00147
Dimension	30.5 x 44 x 23cm Waffle Size: 10 x 17 x 2.2cm
Elec. Spec.	230V / 50Hz / 1600W



ROLLER GRILL *Single Waffle Iron GES20*

McCain version Liège moulds, featuring 4 x 6 squares (15 x 18 mm) Roller Grill waffle irons accept deep-frozen, frozen precooked waffles or home-made batter. Delivered with fork.

Product Code	04-003-00150
Dimension	30.5 x 44 x 23cm Waffle Size: 10 x 18 x 2.6cm
Elec. Spec.	230V / 50Hz / 1600W



ROLLER GRILL Single Waffle Iron Grooved Mould GES40

Grooved mould comes with a wooden cone for making ice-cream cones (squares 8 x 8 mm).

Product Code	04-003-00152
Dimension	30.5 x 44 x 23cm Waffle Size: 25 x 25 x 0.4cm
Elec. Spec.	230V / 50Hz / 1600W



ROLLER GRILL Single Waffle Iron Round Mould GES75

The GES75 Waffle Iron produces circular waffles as an attractive alternative to the traditional rectangle. The cast iron plate features 4 grids each a quarter of a circle 180mm dia, 25mm thick, made up of 10mm squares. The GES75 will produce up to 4 great tasting waffles in just a couple of minutes. The elements are seated beneath both cooking plates giving rapid and even heat across the whole cooking area.

Product Code	04-003-00153
Dimension	30.5 x 44 x 23cm Waffle Size: Ø18.5cm x 2.6cm
Elec. Spec.	230V / 50Hz / 1600W



WARING Heavy-Duty Single Belgian Waffle Maker WW180E

Rotary feature for even baking and browning. Audio beep signals when waffle is ready. Triple-coated non-stick plates allow for easy removal of waffle and quick clean up. Small footprint of double waffle model saves counter space! Makes 17.5cm Belgian-style waffles.

Product Code	04-003-00156
Capacity	25 waffles/h
Elec. Spec.	230V / 50Hz / 1200W



WARING Heavy-Duty Double Belgian Waffle Maker WW200E

Make your breakfast service an experience to remember with the Waring® WW200 Double Belgian Waffle Maker. Its space-saving vertical design cooks two waffles at a time, so you can make up to 50 thick, delicious waffles per hour. Triple-coated nonstick surfaces, heavy-duty, die-cast housing, embedded heating elements and a rotary feature ensure even results and quick cleanup.

Product Code	04-003-00157
Capacity	50 waffles/h
Elec. Spec.	230V / 50Hz / 1400W



ROLLER GRILL Crepe Wheeled Cupboard

This wheeled and stainless steel concept cart can accommodate every kind of appliances to be placed on the work surface. A holed space is meant for the Roller Grill built-in sauce or chocolate warmer WI/DP. Stainless Steel Cabinet base offers a large storage space for all the equipment needs. Lockable through a key lock and sliding doors with integrated handles. Glass sneeze guard. Illuminated display (85x60cm). Includes 2 sockets for connecting device. Cabinet mounted on 4 wheels, 2 with brake system.

Product Code	04-003-00161(XX)
Dimension	100 x 60 x 82.5cm
Elec. Spec.	230V / 50Hz / 40W



ROLLER GRILL Waffle Wheeled Cupboard

Wheeled and stainless steel carts for take-away concepts. The cabinet base has large storage areas with a stainless steel adjustable shelf and it can be locked through a key lock on the sliding doors. Stainless steel cabinet, intermediate shelf, glass sneeze guard, a stainless steel plate, an illuminated display sign is customizable upon request. Switch, 2 sockets for connecting devices, 2 sliding doors with integrated handles and key lock. Cabinet mounted on 4 wheels, 2 with brake system. Delivered with no appliance.

Product Code	04-003-00162(XX)
Dimension	100 x 60 x 82.5cm
Elec. Spec.	230V / 50Hz / 40W



ROLLER GRILL Contact Grill for Sandwich with Grooved Top & Base, Enamel-Coated Cast Iron Heating Plate with Full Stainless Steel Handle PANINI-PREM

The latest innovation in our contact grill range, Le Premium is unique to Roller Grill. Fully equipped through design and technology for outstanding cooking performance, flexible operation and ease of cleaning.

Product Code	04-003-00285
Dimension	40 x 47.5 x 22cm
Elec. Spec.	230V / 3400W
Model Ref.	PANINI-PREM



ROLLER GRILL Electric Contact Grill PANINI-R

Specially designed to cook PANINI. Featuring 5 branch arms covering the wall plate. Fitted with cast iron plates for perfectly high conductive cast-iron plates for perfectly even cooking. The upper plate is self-balanced and the pressure spring is adjustable so you can adapt the cooking to the food. Available with grooved or flat bottom plate for omelettes, fried eggs, savoury pancakes, artich bread, blinis, wrap. Delivered with a scraper.

Product Code	04-003-00169
Dimension	43 x 38.5 x 22cm Cooking surface: 36 x 24cm
Elec. Spec.	230V / 50Hz / 3000W
Model Ref.	PANINI-R



ROLLER GRILL Contact Grill with Grooved On Top Only

Particularly designed for fast-food chains, franchises and all places with high output, the contact-grills enable you to seize in big quantity every kind of sandwiches, hamburgers, steaks etc. and to alternate cooking types between the plates. 2 thermostats 0-300°C. Delivered with a scraper for easy cleaning.

Product Code	04-003-00163	04-003-00165	04-003-00166
Dimension	83.5 x 38.5 x 22cm Cooking Surface: 2 x (36 x 24cm)	41 x 62 x 34cm Cooking Surface: 36 x 36cm	
Size	Double	Single	Single
Elec. Spec.	2 x (230V / 50Hz / 3200W)	230V / 50Hz / 3600W	
Model Ref.	DOUBLE PANINI-L	PANINI-XLR	PANINI-XLL
Type	Grooved on Top Only	Grooved on Top & Base	Grooved on Top Only



ROLLER GRILL Single Contact Grill

The fully adjustable spring and counter balanced top plate will help prevent food being crushed by the weight of the top plate and is fitted with armoured heating elements for perfect heat distribution. The cast iron plates provide a constant even heat making the SAVOYE ideal for cooking steaks, burgers, fish, paninis etc.

Product Code	04-003-00167	04-003-00168
Type	w/ Grooved Top & Base	w/ Grooved Top only
Dimension	38.5 x 33 x 22cm Cooking Surface: 26 x 24cm	
Elec. Spec.	230V / 50Hz / 2000W	
Model Ref.	SAYORE-R	SAYORE-L



ROLLER GRILL Glass Ceramic Single Multi-Grill

The vitroceramic contact-grill was designed for comfort of use and security. The lever system allows a daily use without forcing the top plate of the grill contact. The front of the upper plates avoids the shock between the glass-ceramic plates, once the vitroceramic contact-grill is closed. Both upper-plates are counter-balanced to adapt the professional contract-grill to the thickness of the sandwich to be cooked.

Product Code	04-003-00295	04-003-00296
Dimension	39 x 60 x 26cm	78 x 60 x 26cm
Elec. Spec.	230V / 2500W / 13Amps	230V / 2 x 2500W / 2 x 13Amps
Model Ref.	GVS335	GVD335



Panini Grill with Groove Top Only

Product Code	04-003-00172	04-003-00173
Type	Large	Small
Dimension	38 x 41 x 23cm Cooking Surface: 30 x 38cm	29.5 x 33 x 23cm Cooking Surface: 27 x 25cm
Elec. Spec.	230V / 50Hz / 2400W	230V / 50Hz / 2000W



ROLLER GRILL Electric Steel Enamelled Griddle Plate

The PED700 is a high-performance dual zone electric griddle. Built around a 10mm thick steel cooking plate, it provides a solid cooking platform for your griddle menu; burgers, sausages, eggs etc. Unique 2 Zone heating.

Product Code	04-003-00297
Dimension	40 x 70 x 25cm Cooking Surface: 36.5 x 54.5cm
Elec. Spec.	230-240V / 3500W / 15Amp



ROLLER GRILL Electric Enamelled Steel Griddle Plate

Steel enamelled griddle plate (10mm) to cook meat, bacon, fish, hamburgers, sausages, onions... and also for fried eggs and omelettes. Healthy and quick cooking with the mirror smooth plate for a direct temperature transfer. Built with a Incoloy heating element, for a homogenous temperature on the whole cooking surface. Removable drip tray.

Product Code	04-003-00175	04-003-00180
Dimension	60 x 47.5 x 23cm Cooking Surface: 60 x 40cm	40 x 47.5 x 23cm Cooking Surface: 40 x 40cm
Size	Double	Single
Elec. Spec.	380V / 50Hz / 6000W	230V / 50Hz / 3000W
Model Ref.	PSR600EE	PSR400EE



ROLLER GRILL Electric Griddle Plate

Specific steel griddle plate (10mm) to cook meat, bacon, fish, hamburgers, sausages, onions... and also for fried eggs and omelettes. Healthy and quick cooking with the mirror smooth plate for a direct temperature transfer. Built with a Incoloy heating element, for a homogenous temperature on the whole cooking surface. Removable drip tray.

Product Code	04-003-00176	04-003-00182	04-003-00183(XX)
Add. Info.	With Cast Iron Plate	With Decarbonised Plate	
Dimension	60 x 47.5 x 23cm Cooking surface: 60 x 40cm	40 x 47.5 x 23cm Cooking Surface: 40 x 40cm	
Size	Double	Single	Single
Elec. Spec.	380V / 50Hz / 6000W	230V / 50Hz / 3000W	230V / 50Hz / 3200W
Model Ref.	PSR600E	PSR400E	PSR400G Gas Model



ROLLER GRILL *Single Glass Ceramic Griddle*

Built around our vitro ceramic infrared heating system to bring energy efficient cooking to your kitchen. By cutting the heat up times (230°C in 90 seconds) and halving the overall power this griddle can bring real savings.

Product Code	04-003-00184	04-003-00185
Type	with Flat Plate PS400VCL	with Grooved Plate PS400VCR
Dimension	42 x 42 x 15cm Cooking Surface: 33 x 28cm	
Elec. Spec.	230V / 50Hz / 1500W	



ROLLER GRILL *Electric Grill with Lava Rock*

10 temperature control settings. Electric lava rock grill for natural, healthy, tasty and easy-to-digest grills. Lava rock reacts in the same way as wood embers, spreading the heat evenly across the cooking surface and absorbing the fats. Alternate fish, meat, sausages, etc. without transmission of taste or smell. Easy to clean: Lava rocks can be washed in dishwasher, control-box is removable and lava tray is enamelled. 1pkt of lava rock included.

Product Code	04-003-00187(XX)	04-003-00188
Dimension	59 x 50 x 30.5cm	30 x 54.5 x 16cm
Size	Double	Single
Elec. Spec.	2 x (230V / 50Hz / 2500W)	230V / 50Hz / 2500W
Model Ref.	140D	140



RINNAI *Stainless Steel Single Infrared Grill*

High Temperature Resistant Stainless Steel. Rapid And Efficient Grilling With Powerful Infra-Red Burners.

Product Code	04-003-00197(XX)	04-003-00196(XX)
Type	LPG	Town Gas
Dimension	60.7 x 21 x 21.6cm	
Elec. Spec.	2500W	



PRO EQUIP *Electric Griddle with Flat Steel Top*

Product Code	04-003-00179
Dimension	60.5 x 52 x 26.5cm Cooking Surface: 60 x 40cm
Elec. Spec.	380V / 50Hz / 2800W



PRO EQUIP *Electric Grill with Flat Cast Iron Top*

Product Code	04-003-00186
Dimension	45 x 44.5 x 22cm Cooking Surface: 38 x 38cm
Temp.	Max temp 300°C
Elec. Spec.	230V / 50Hz / 2800W



CROWN *Stainless Steel BBQ Stove / Griller SW680*

Full stainless steel body. Adjustable temperature control. Removable & washable oil tray.

Product Code	04-003-00191
Dimension	70 x 36 x 14cm Cooking Surface: 55 x 31cm
Elec. Spec.	230V / 50Hz / 2 x 1500W



CROWN *Stainless Steel BBQ Stove / Griller SW200*

Full stainless steel body. Adjustable temperature control. Removable & washable oil tray.

Product Code	04-003-00192
Dimension	70 x 20 x 14cm Cooking Surface: 55 x 15cm
Elec. Spec.	230V / 50Hz / 2500W



ROLLER GRILL *Gas Gyros (Kebab) Grill*

Gas models are fitted with 2 till 4 infrared burners with safety thermocouple and independent controls with slow setting. LPG type.

Product Code	04-003-00203(XX)
Dimension	58 x 66 x 64.5cm Spit Ht. 40cm
Capacity	For 15kg Meat

ACCESSORIES

- *Accessories available upon request*



ROLLER GRILL *Electric Gyros (Kebab) Grill*

Electric models are equipped with 3, 4 or 5 Incoloy heating elements with independent regulation, half or full power and fire stones to accumulate the heat. The bottom plate is fully hermetic: the motor is protected from any infiltration of fat or juice of meat.

Product Code	04-003-00200(XX)	04-003-00201	04-003-00202
Dimension	58 x 66 x 104.5cm Spit Ht. 80cm	58 x 66 x 87cm Spit Ht. 60cm	58 x 66 x 69.5cm Spit Ht. 40cm
Capacity	For 40kg Meat	For 25kg Meat	For 15kg Meat
Elec. Spec.	380V / 50Hz / 7200W	380V / 50Hz / 5800W	380V / 50Hz / 3600W
Model Ref.	GR80E	GR60E	GR40E

ACCESSORIES

- *Accessories available upon request*



CROWN Stainless Steel Electric Water Urn

Brilliant polished stainless steel finishing. All-welded construction. Rolled edges for added strength. Non-drip heavy duty tap. U.K. thermostat control switch. High quality insulated handles. With Indicator light.

Product Code	04-003-00217	04-003-00218	04-003-00219	04-003-00220
Dimension	Ø32 x 49.5cm	Ø30 x 49.5cm	Ø30 x 43cm	Ø25.5 x 34.5cm
Capacity	40ℓ	30ℓ	20ℓ	10ℓ
Elec. Spec.	230V / 50Hz / 2500W	230V / 50Hz / 2500W	230V / 50Hz / 2500W	230V / 50Hz / 2500W
Add. Info	Max. heat setting 110°C	Max. heat setting 110°C	Max. heat setting 110°C	Max. heat setting 110°C



MISTRAL Electric Thermal Airpot

Auto re-boil and keep warm. Removable top cover for easy cleaning. Dry boil protection. Stainless steel inner pot. Stainless steel body. 360° swivel base.

Product Code	04-003-00222	04-003-00223
Capacity	5ℓ	3.8ℓ
Elec. Spec.	230V / 50Hz / 750W	
Model Ref.	MAP520	MAP380



LACOR Electric Airpot

Newly designed electric drinks dispenser with tap Airpot Lacor with dimensions ideal for coupling in restaurants with buffet, in meeting rooms, events or in any corner of your office. It is the best option to enjoy coffee, water or tea always at the desired temperature by having the possibility to adjust the temperature of the drinks.

Product Code	04-003-00286	04-003-00287
Capacity	6ℓ	10ℓ
Elec. Spec.	220-240V / 50-60Hz / 1500W	



CCK Stainless Steel Wall Mount Electric Water Boiler

Product Code	04-003-00215	04-003-00216
Dimension	38 x 24 x 73cm	34 x 21 x 55.5cm
Capacity	37.8ℓ	22.7ℓ
Elec. Spec.	230V / 50Hz / 3000W	



RINNAI Gas Automatic Rice Cooker (3-Deck)

Various Modes For Rice Cooking (Normal, Cereals, Porridge). Various Settings For Individual Tier. Digitalized Function. Self Diagnosis Function. Flame Failure Safety Device.

Product Code	04-003-00237(XX)
Dimension	70 x 72.7 x 125cm
Elec. Spec.	33700W



CROWN Non-Stick Electric Rice Cooker

Full bottom contact heating element. Full thermostatic control. Overheat safety control. Easy push-button operation. Durable insulated handles. Rice pot is washable & easy to clean. Available in different capacities to suit your cooking needs.

Product Code	04-003-00228	04-003-00229	04-003-00230	04-003-00231	04-003-00232
Dimension	Ø50 x 29cm	Ø60 x 35cm	Ø45 x 38cm	Ø45 x 32cm	Ø37 x 32cm
Capacity	12l	10l	8l	6l	4l
Serving Size	70pax	50pax 55cups	40pax 45cups	30pax 30 cups	25pax 23cups
Elec. Spec.	230V / 50Hz / 3000W	230V / 50Hz / 2600W	230V / 50Hz / 2300W	230V / 50Hz / 1950W	230V / 50Hz / 1550W
Model Ref.	ER70A	ER50A	ER40A	ER30A	ER25A



CROWN Gas Rice Cooker RR50A

Rice pot is washable and easy to clean. Available for LP and Town gas. Heat-resistance glass for burner protection.

Product Code	04-003-00226	04-003-00227
Type	LPG	Town Gas
Dimension	52.4 x 48 x 42cm	
Capacity	9l	
Elec. Spec.	230V / 50Hz / 2300W	

CROWN Stainless Steel Electric Rice Cooker / Warmer

2-in-1 rice cooker and rice warmer. Non-stick inner pot. Automatic keep-warm function.

Product Code	04-003-00234	04-003-00233
Dimension	Ø39 x 35cm	Ø42 x 35cm
Capacity	6l	8l
Elec. Spec.	230V / 50Hz / 1950W	230V / 50Hz / 2300W
Model Ref.	SW6800-S	SW8800-S



CROWN Wooden Design Rice Warmer S-8000

Automatic keep-warm function. Available in wooden brown or stainless steel finishing.

Product Code	04-004-00018
Dimension	Ø35 x 46cm
Capacity	8l
Elec. Spec.	220V / 50-60Hz / 92W

CROWN Stainless Steel Rice Warmer

Automatic keep-warm function. Available in wooden brown or stainless steel finishing.

Product Code	04-004-00019	04-003-00236
Dimension	Ø35 x 46cm	Ø46 x 42cm
Capacity	8l	9l
Elec. Spec.	220V / 50Hz / 100W	230V / 50Hz / 100W
Model Ref.	S8000-S	SW9800-S



PANASONIC Rice Cooker

5 hours keep warm. Stainless steel lid with aluminium. Built-in thermal safety fuse.

Product Code	04-003-00301
Dimension	Int Ø32 x Ext Ø38 x Ht 33 cm
Capacity	3.6ℓ
Elec. Spec.	450W



PANASONIC Rice Cooker

5 hours keep warm. Stainless steel lid with aluminium. Built-in thermal safety fuse. Auto shut-off function.

Product Code	04-003-00299
Dimension	Int Ø36 x Ext Ø45 x Ht 33cm
Capacity	4.2ℓ
Elec. Spec.	1400W



PANASONIC Rice Cooker

5 hours keep warm. Stainless steel lid with aluminium. Built-in thermal safety fuse. Auto shut-off function.

Product Code	04-003-00300
Dimension	Int Ø47 x Ext Ø60 x Ht 36cm
Capacity	7.2ℓ
Elec. Spec.	220-240V / 50Hz / 2500W



CORNELL Slow Cooker CSC150

Suitable for slow cooking, soup, porridge, dessert & stewing. Comes with auto cooking function, removable pot for easy cleaning, tempered glass lid.

Product Code	04-003-00246
Dimension	23 x 24cm
Capacity	1.5ℓ
Elec. Spec.	230V / 50Hz / 200W



ROLLER GRILL Double Induction Cooker

Two independently controlled induction zones; 20 pre-set digital control; digital timer; 4mm thick vitro ceramic glass plate.

Product Code	04-003-00298
Dimension	40 x 70 x 19.5cm
Elec. Spec.	230-240V / 2 x 3000W / 2 x 13Amps



ROLLER GRILL Digital Chocolate Induction Cooker

At 4mm thick the glass plate will support up to 20Kg and is protected with a steel bar along it's front. 20 pre-set digital control; digital timer; 4mm thick vitro ceramic glass plate.

Product Code	04-003-00278
Dimension	31.5 x 38 x 10.2cm
Elec. Spec.	230-240V / 2500W

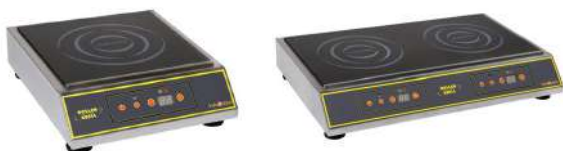

ROLLER GRILL Digital Induction Cooker

Rated to run at full power for up to 8 hours without cutting out. 20 pre-set digital control; digital timer; 4 mm thick vitro ceramic glass plate.

Product Code	04-003-00279	04-003-00280
Dimension	31.5 x 38 x 10.2cm	59 x 38 x 10.2cm
Elec. Spec.	230-240V / 3000W	230-240V / 2 x 3000W
Size	Single	Double



ROLLER GRILL Digital Induction Wok with Pan

Fitted with a steel rim to both support the pan and protect the glass. 20 pre-set digital control; digital timer; 4mm thick vitro ceramic glass bowl.

Product Code	04-003-00281
Dimension	39 x 43 x 16.5cm Wok Diameter: Ø30cm
Elec. Spec.	230-240V / 3000W



SAFICO PRO Drop-In Single Hob Digital Induction Stove

Suitable for built in buffet display or cooking. 9 heating power levels available or selection with power settings.

Product Code	04-003-00250
Dimension	32 x 32 x 5.3cm Cooking Surface: 32 x 32cm
Temp.	70-220°C
Elec. Spec.	230V / 50Hz / 1800W



SAFICO PRO Drop-In Single Hob Induction Stove

Rotary power control. 16 level power setting. 20 level temperature holding.

Product Code	04-003-00252
Dimension	38.5 x 85.5 x 17.8 cm
Elec. Spec.	230V / 50Hz / 2800W



SAFICO PRO Counter-Top Single Hob Induction Wok Stove

Rotary power control. 16 level power setting.

Product Code	04-003-00253
Elec. Spec.	230V / 50Hz / 2800W

ACCESSORIES:

- Wok for Induction Work #CW-28A: 01-001-01160



SAFICO PRO Counter-Top Single Hob Digital Induction Stove

Glass touch control. 11 level power setting. Temperature holding from 40 - 220 c (5c / level). Timer. Safety lock. External RF sensor (optional).

Product Code	04-003-00254
Dimension	32.8 x 45 x 11cm
Elec. Spec.	230V / 50Hz / 2800W



SAFICO PRO Counter-Top Single Hob Induction Stove

Rotary power control. 9 level power setting. 5 level temperature holding.

Product Code	04-003-00255
Dimension	32.8 x 42.2 x 10.5 cm
Elec. Spec.	230V / 50Hz / 2800W



Induction Stove

Product Code	04-003-00289
Dimension	39.5 x 33.8 x 11.7cm
Elec. Spec.	220-240V / 50-60Hz / 3000W



Induction Stove with Touch Sensor

Product Code	04-003-00257
Dimension	29 x 36 x 7cm
Elec. Spec.	230V / 50Hz / 1800W



MISTRAL Induction Stove / Cooker with Pot

Mistral Induction Cooker gives the maximum value out of its extremely useful features. Its amazing futuristic design is made out of only the finest material to ensure top grade quality.

Product Code	04-003-00302
Elec. Spec.	220-240V / 50Hz / 3000W



CROWN Electric 2-Tier Steamer SW80

Stainless steel finishing. Adjustable temperature control. Indicator light. Easy removable tiers. Steams food to perfection. Safe & easy to maintain.

Product Code	04-003-00244
Dimension	Ø45 x 62cm
Capacity	20l
Elec. Spec.	230V / 50Hz / 3000W



CROWN 4 Ring Cast Iron Burner (LPG) A40

Product Code	04-003-00259
Add. Info.	3 Rings



CROWN 2 Ring Cast Iron Burner (LPG) A30

Product Code	04-003-00260
Add. Info.	2 Rings



CROWN High Pressure Cast Iron Burner (LPG) 5B

Product Code	04-003-00261
Dimension	Ø34cm
Add. Info.	5 Rings



CROWN High Pressure Cast Iron Burner (LPG) 2B

Product Code	04-003-00262
Dimension	Ø22cm
Add. Info.	2 Rings



LACOR Burner without Stand

Product Code	04-003-00267(XX)	04-002-00268(XX)	04-002-00269(XX)
Dimension	Ø30cm	Ø50cm	Ø70cm
Add. Info.	1 Ring		



Aluminium Satay Stove

Product Code	04-003-00275
Dimension	65 x 20 x 14cm



Japanese Stove

Product Code	04-003-00276
Dimension	30.5cm



ROLLER GRILL Proofing Cabinet EP800

Proofer to make the dough rise during 2 hours at 29°C. The steam production is automatically preset in time and quantity. Electrovalves for humidification. Interior in stainless steel. Proofer mounted on 4 castors with brakes system. Grids not included.

Product Code	04-003-00272(XX)
Dimension	79.5 x 64 x 91cm Inside Dimension: 60 x 54.5 x 68cm 8 Levels
Elec. Spec.	230V / 50Hz / 1400W



PRO EQUIP Double Bain Marie

Product Code	04-004-00002
Dimension	67.6 x 56.5 x 26cm
Capacity	2 x 24ℓ Max Heat Setting 80°C
Elec. Spec.	230V / 50W / 3000W
Add. Info.	GN 2 x 1/1 Size



LACOR Stainless Steel Electric Bain Marie

Cooking technique suitable for melting delicate foods (chocolate), curdling traditional desserts (flan, pudding) or savory pastries (pate, fish cake), pre-prepare canning and making delicate sauces. In professional use, in addition, bath keeps hot prepared foods or sauces until serving time.

Product Code	04-004-00005
Dimension	53 x 35 x 25cm
Capacity	24ℓ 70°C
Elec. Spec.	230V / 50W / 1200W
Add. Info.	GN 1/1 Size



IWATANI Portable Gas Cooker ZA3

Automatic safety stop. Safety container setting device. Safety joint. Drip pan reversal prevention mechanism. Uses standard 8 oz butane canister (Sold separately)

Product Code	04-003-00277
--------------	--------------



PRO EQUIP Single Bain Marie

Product Code	04-004-00004
Dimension	35.5 x 56.5 x 26cm
Capacity	24ℓ Max Heat Setting 80°C
Elec. Spec.	230V / 50W / 1500W
Add. Info.	GN 1/1 Size



Stainless Steel Electric Bain Marie, Economy

Product Code	04-004-00006
Dimension	59 x 35 x 28cm
Capacity	24ℓ
Elec. Spec.	230V / 50W / 1200W
Add. Info.	GN 1/1 Size



CCK Electric 3-Compartment Sauce Warmer / Bain Marie

Product Code	04-004-00007
Dimension	47 x 37 x 27cm
Capacity	26ℓ Max Heat Setting 110°C
Elec. Spec.	230V / 50W / 2000W
Add. Info.	(1/2+2x1/6) OR (1/2+1x1/3) size



CCK Electric 3-Compartment Sauce Warmer / Bain Marie

Product Code	04-004-00008
Dimension	50 x 21 x 30cm
Capacity	25l Max Heat Setting 110°C
Elec. Spec.	230V / 50W / 2000W
Add. Info.	GN 2 x 1/4 + 1 x 1/3 Size



CCK Electric 4-Compartment Sauce Warmer / Bain Marie

Product Code	04-004-00009
Dimension	47 x 36 x 34cm
Capacity	20l Max Heat Setting 110°C
Elec. Spec.	230V / 50W / 800W
Add. Info.	GN 1/2 + 1/3 size



CCK Electric GN 1/1 Sauce Warmer / Bain Marie

Product Code	04-004-00010
Dimension	54 x 34 x 36cm
Capacity	24l Max Heat Setting 110°C
Elec. Spec.	230V / 50W / 2000W
Add. Info.	GN 1/1 Size



CCK Electric 2-Compartment Sauce Warmer / Bain Marie

Product Code	04-004-00011
Dimension	27 x 22.5 x 32.3cm
Capacity	25l Max Heat Setting 110°C
Elec. Spec.	230V / 50W / 2000W
Add. Info.	GN 1 x 1/2 OR 2 x 1/4 Size



CCK Electric 3-Compartment Sauce Warmer / Bain Marie

Product Code	04-004-00012
Dimension	51 x 21 x 30cm
Capacity	40l Max Heat Setting 110°C
Elec. Spec.	230V / 50W / 2000W
Add. Info.	GN 3 x 1/6 Size



ROLLER GRILL Electric Double Free Standing Warm It Machine

The double electric warmer WI / 2 is a table-top warmer fitted with 2 black protective shells and a removable display for a pot of jam, honey or spread. This chocolate or sauce warmer can heat up 2 pressure bottles in the same time without bain-marie function.

Product Code	04-004-00015(XX)
Dimension	31 x 21 x 25cm
Capacity	2 x 1l
Elec. Spec.	230V / 50W / 340W



Electric Soup Warmer

Product Code	04-004-00022
Dimension	Ø26 x 35cm
Capacity	5.7l
Elec. Spec.	230V / 50W / 300W



Stainless Steel Electric Soup Warmer

Product Code	04-004-00023
Dimension	Ø26 x 35cm
Capacity	5.7l
Elec. Spec.	230V / 50W / 300W



Stainless Steel Electric Soup Warmer

Product Code	04-004-00024
Dimension	Ø42 x 38cm
Capacity	10l
Elec. Spec.	230V / 50W / 450W



CROWN Stainless Steel Twin Coffee Warmer SW22

High efficiency and energy saving. Non-stick support plate. Safe & easy to maintain. Keep-warm function only.

Product Code	04-004-00031
Dimension	38 x 18cm
Elec. Spec.	230V / 50W / 2 x 100W



JUKI Single Hot Plate

Product Code	04-002-00344
Dimension	26cm
Elec. Spec.	220-240V / 50W / 1250-1500W



JUKI Double Hot Plate

Product Code	04-002-00345
Dimension	47cm
Elec. Spec.	220-240V / 50W / 1900-2250W



LACOR Stainless Steel GN 1/1 Warming Plate with Ceramic Top

It has a thermostat adjustable in temperature, thermo-insulating handles on the sides for a better safe movement and non-slip plugs.

Product Code	04-004-00035
Dimension	55 x 35 x 4.5cm
Temp.	Up to 80°C
Elec. Spec.	230V / 50W / 230W



PRO EQUIP Glass Warmer with Stainless Frame for GN 1/1

Product Code	04-004-00036
Dimension	48 x 40 x 7.5cm
Temp.	40-90°C
Elec. Spec.	230V / 50W / 450W



PRO EQUIP Glass Warmer with Stainless Frame for GN 2/1

Product Code	04-004-00040
Dimension	70.5 x 58 x 7.5cm
Temp.	40-90°C
Elec. Spec.	230V / 50W / 450W



PRO EQUIP Stainless Steel Electric Warming Plate

Product Code	04-004-00037	04-004-00038	04-004-00039
Dimension	53 x 32.5cm	32.5 x 26.5cm	32.5 x 17.6cm
Temp.	40-100°C	40-100°C	40-100°C
Elec. Spec.	230V / 50Hz / 450W	230V / 50Hz / 300W	230V / 50Hz / 200W
Add. Info.	For GN 1/1	For GN 1/2	For GN 1/3



Two Door Hot & Cold Towel Warmer HC-140

Product Code	04-004-00042
Dimension	45 x 31 x 60cm
Capacity	For 140 Towels



Hot & Cold Towel Warmer HC-70

Product Code	04-004-00046
Dimension	45 x 28.5 x 33cm
Capacity	For 70 Towels



Towel Warmer

Product Code	04-004-00044	04-004-00045
Dimension	45 x 28.5 x 33cm	42.5 x 28.5 x 27.5cm
Capacity	For 70 Towels	For 50 Towels



Two Door Towel Warmer CN-140

Product Code	04-004-00043
Dimension	45 x 31 x 60cm
Capacity	For 140 Towels



NEMOX Ice Cube Maker Ice Cube Tech

Produces Ice cubes. Makes 12 ice cubes (10-15g) in app. 6-10minutes. Daily output is about 15kg.

Product Code	04-005-00001
Dimension	36 x 39.5 x 41.5cm
Temp.	Collecting Capacity: 1.5kg (app. 80ice cubes) Water Tank: 4.5ℓ
Elec. Spec.	230V / 50Hz / 150W



NEMOX Shock Freezer Freezy

Essential instruments to grant the best food preservation in the most natural way. SOFT and HARD blast-chilling cycles and shock-freezing cycle are regulated by temperature with the use of a core-probe or by time setting.

The electronic control board is easy to operate. The construction of these appliances is completely in stainless steel AISI 304, as are the grates and supports which can be easily disassembled.

Product Code	04-005-00002(XX) Freezy 5	04-005-00003(XX) Freezy 9
Dimension	59.5 x 61 x 38.5cm Internal Dimension: 34 x 36.4 x 26.7cm	59.5 x 70 x 89.5cm Internal Dimension: 41.2 x 61 x 43cm
Capacity	35ℓ 3 x G/N 2/3 Trays	110ℓ 6 x G/N 1/1 Trays
Elec. Spec.	230V / 50W / 218W	230V / 50W / 600W



NEMOX Gelato and Ice Cream Display Freezer 7 Magic Pro

- Internal storage compartment with its own temperature control
- Curved display canopy for safety, hygiene and visual effect
 - Easy clean condenser design for better protection: less condensation,
 - less rust, less humidity - even in tropical climates
 - Digital temperature display
 - Castors for easy positioning
 - Corrosion resistant construction and equipped with defrost water drain

Product Code	04-006-00001(XX)
Dimension	131.4 x 70.2 x 116.5cm Internal Dimension: 119 x 41.57 x 5l
Elec. Spec.	230V / 50W / 730W



ROLLER GRILL Stainless Steel Merchandiser Refrigerated Display VVF800

Fits 2 x GN 1/1 tray and 2 60x40cm tray. The right equipment to keep fresh your salads, fresh sandwiches, yoghurts, desserts, beverage. The ventilated refrigerated group is warranting an inside temperature of +4 +10° C (at an ambient temperature of 29°C) and an automatic defrosting system. White-cold LED lighting. Tray not included.

Product Code	04-006-00005
Dimension	80 x 73 x 60cm Internal Dimension: 65 x 55 x 29.5cm 2 levels
Elec. Spec.	230V / 50Hz / 350W



ROLLER GRILL Stainless Steel Horizontal Refrigerated Display with LED Light CD800

Product Code	04-006-00032
Dimension	80 x 73 x 60cm 2 x 1/1 GN & 2 Glass Shelves
Elec. Spec.	0.35kW, +2° to +10°C



ROLLER GRILL Stainless Steel Horizontal Refrigerated Display with LED Light CD1200

Product Code	04-006-00034
Dimension	118.5 x 65 x 73.5cm 3 x 1/1 GN & 2 Glass Shelves
Elec. Spec.	0.35kW, +2° to +10°C



ROLLER GRILL Electric Ventilated Positive Cold Display with Fixed Grids RD60F

Positive cold refrigerated display cabinets keep pies, fruit salads or drinks at right temperature of +2°C to + 10°C. Negative refrigerated display cabinets keep your ice creams and frozen desserts between -5°C and -20°C

Product Code	04-006-00006(XX)	04-006-00007(XX)	04-006-00008(XX)
Type	Postive Cold Display With Fixed Grids	Positive Cold Display With Turning Plates	Negative Cold Display With Turning Plates
Dimension	60 x 63 x 185cm Inside dimension: 54.5 x 54.5 x 120cm	60 x 63 x 185cm Inside dimension: 54.5 x 54.5 x 120cm	60 x 63 x 185cm Inside dimension: 54.5 x 54.5 x 120cm
Capacity	360l	360l	360l
Elec. Spec.	230V / 50Hz / 690W	230V / 50Hz / 690W	230V / 50Hz / 800W



ROLLER GRILL *Stainless Steel Ventilated Warming Display WD780DI*

Very easy to use and to clean. The rear glass doors open at 180 ° C for the loading of the professional showcase and for the service. The grids and their supports, the stainless steel lower tray, the water drawer and the firestone are completely removable.

Product Code	04-006-00010
Dimension	78 x 49 x 64cm
Capacity	60 x 40cm trays / 5 Levels
Elec. Spec.	230V / 50W / 1800W
Add. Info.	Comes with 2 grids



ROLLER GRILL *Stainless Steel Ventilated Warming Display WD780SI*

This ventilated heated showcase, equipped with 4 LED ramps, highlights and keeps warm in quantities quiches, pizzas, fondues, meatballs, pastries and so on.

Product Code	04-006-00011
Dimension	78 x 49 x 48cm
Capacity	60 x 40cm trays / 3 Levels
Elec. Spec.	230V / 50W / 1200W
Add. Info.	Comes with 2 grids



ROLLER GRILL *Counter Top Warming Display WDL200*

This stylish compact cabinet will still accommodate a 1/1GN tray on both shelves and provide a thermostatically controlled humidified display for pastries croissants pies and pasties. The upper light box will promote your products and the graphic can be changed to match your menu. Efficient and practical with front and rear opening.

Product Code	04-006-00012
Dimension	59 x 35 x 48cm Internal Dimension: 2 x (54 x 33 x 12.5) cm
Capacity	Fits 2 x GN 1/1 Tray
Elec. Spec.	230V / 50W / 650W



ROLLER GRILL *Counter Top Warming Display WDL100*

Keep products at a constant temperature of 20-95°C. Equipped with top illuminated display sign, and water container for humidity control to keep products moist and delicious. Removable stainless steel presentation tray with top section in glass for easy cleaning and maintenance Tray not included.

Product Code	04-006-00013
Dimension	59 x 35 x 37.5cm Internal Dimension: 54 x 33 x 16.5cm
Capacity	Fits GN 1/1 Tray
Elec. Spec.	230V / 50Hz / 650W



ROLLER GRILL *Stainless Steel Heat Up Display with Glass Shelves*

Precise temperature control with an electronic thermostat. Humidity control, ensuring the maintenance of humidity and taste of products. LED backlight. Inner glass shelves. Rear sliding door.

Product Code	04-006-00033
Dimension	78.5 x 67.5 x 72cm
Capacity	2 Levels
Elec. Spec.	230V / 3000W / 13Amps



ROLLER GRILL *Stainless Steel Heat Up Display 2 Levels with Glass Shelves HD1200-BK*

Precise temperature control with an electronic thermostat. Humidity control, ensuring the maintenance of humidity and taste of products. LED backlight. Inner glass shelves. Rear sliding door.

Product Code	04-006-00035
Dimension	118.5 x 65 x 73.5cm
Capacity	2 Levels, 3 x GN1/1 & 3 x GN1/1
Elec. Spec.	230V / 3000W / 13Amps



ROLLER GRILL *Ventilated Warming Display VHC1000*

Designed for takeaways, markets, kiosks, convenience stores, butchers, market stalls, offers a very good display surface. Modular and panoramic, this display is made up of 2 removable sections: the heating unit and the display cabinet assembled by a system of rollers. Both warming and refrigerating units can be changed with the front display. 2 front and 1 rear liftable door and a removable service tray make loading, serving and cleaning easy. To keep ready-made dishes, starters, main courses at a constant Temperature (+20/+10°C). Pulsed air convection system. LED lights. Tray not included.

Product Code	04-006-00009
Dimension	100 x 72 x 47.5cm Inside dimension: 96 x 53.5 x 28cm Shelf: 96 x 30cm
Capacity	For 3 GN 1/1
Elec. Spec.	230V / 50Hz / 2400W



04-006-00018(XX)



04-006-00019(XX)

SPM Soft Serve Ice Cream, Yoghurt, Slush Machine

For dispensing creamy ice cream soft and delicious frozen yogurt with an exceptional quality.

Product Code	04-006-00018(XX)	04-006-00019(XX)
Model No.	GT Push 1	GT Push 2
Dimension	26 x 43 x 65cm	45 x 43.5 x 65cm
Capacity	5ℓ	2 x 5ℓ
Elec. Spec.	230V / 50Hz / 350W	230V / 50Hz / 750W



04-006-00025(XX)



04-006-00026(XX)

SPM Soft Serve Ice Cream, Yoghurt, Slush Machine

Small, lightweight, revolutionary, NINA is the mini dispenser for creams and other cold dishes.

Product Code	04-006-00025(XX)	04-006-00026(XX)
Model No.	Nina 1	Nina 2
Dimension	13 x 37.5 x 45.5cm	28 x 38.8 x 47.8cm
Capacity	2ℓ	2 x 2ℓ
Elec. Spec.	230V / 50Hz / 270W	230V / 50Hz / 500W



SPM Soft Serve Ice Cream, Yoghurt, Slush Dispenser GT Lab

Compact, practical and touch-controlled, the GT LAB is the latest development in the field of small machines allowing to produce and deliver ice-cream in tubs, like in ice-cream shops.

Product Code	04-006-00017(XX)
Dimension	26 x 43 x 65cm
Capacity	5ℓ
Elec. Spec.	230V / 50Hz / 350W

- **Container Sold Separately**



04-006-00020(XX)



04-006-00021(XX)

SPM Soft Serve Ice Cream, Yoghurt, Slush Machine

GT Touch delivers up to 5 products and is easy to use with exclusive interactive touch screen.

Product Code	04-006-00020(XX)	04-006-00021(XX)
Model No.	GT Touch 1	GT Touch 2
Dimension	26 x 43 x 65cm	45 x 44 x 65cm
Capacity	5ℓ	2 x 5ℓ
Elec. Spec.	230V / 50Hz / 350W	230V / 50Hz / 750W



SPM Soft Serve Ice Cream, Yoghurt, Slush Machine

A control light warns the operator when the product inside the machine reaches the minimum level and it's necessary to fill it up. U-Go is easy to use, to clean and to assemble.

Product Code	04-006-00030(XX)	04-006-00031(XX)
Model No.	U Go Gravity	U Go Pump
Dimension	35.7 x 52.12 x 60cm	35.7 x 52.12 x 60cm
Capacity	Hooper: 7ℓ Cylinder: 2.3ℓ 120cones/h	Hooper: 7ℓ Cylinder: 2.3ℓ 170cones/h
Elec. Spec.	230V / 50Hz / 1000W	230V / 50Hz / 1050W



04-006-00022(XX)



04-006-00023(XX)



04-006-00024(XX)

SPM Slush Machine IP1 Mechanical

The unique insulation bath I-TANK™ technology, integrated with the manual control system. The exclusive insulated bowls powered by i-Tank™ technology minimizes the influence of external temperature, increases the cooling power and enhances product consistency. It reduces condensation on the outer bowl enhancing the product attractiveness.

Product Code	04-006-00022(XX)	04-006-00023(XX)	04-006-00024(XX)
Model No.	IP1 Mechanical	IP2 Mechanical	IP3 Mechanical
Dimension	20 x 58 x 87cm	40 x 58 x 87cm	60 x 58 x 87cm
Capacity	11ℓ	2 x 11ℓ	3 x 11ℓ
Elec. Spec.	230V / 50Hz / 500W	230V / 50Hz / 980W	230V / 50Hz / 1420W



04-006-00027(XX)



04-006-00028(XX)



04-006-00029(XX)

SPM Soft Serve Ice Cream, Yoghurt, Slush Machine SP1

Bench compact machine for dispensing cold creams, sorbets and other creamy dishes. SP is compact and features an elegant design, as well as rounded shapes with stainless steel finishing and white or black finishes. It is easy to clean and user-friendly, and all the components which come into contact with the products can be removed without having to use any tools.

Product Code	04-006-00027(XX)	04-006-00028(XX)	04-006-00029(XX)
Model No.	SP1	SP2	SP3
Dimension	26 x 43 x 61cm	45 x 44 x 61cm	63 x 45 x 61cm
Capacity	5ℓ	2 x 5ℓ	3 x 5ℓ
Elec. Spec.	230V / 50Hz / 350W	230V / 50Hz / 500W	230V / 50Hz / 1000W



04-006-00014



04-006-00015



04-006-00016

SANTOS Cold Drink Dispenser Tank 34

Reliable refrigeration system: Wide air-cooling condenser to continuously chill the drinks. High pressure hermetically sealed compressor giving the guarantee of a high quality, efficient and long-lasting appliance. Compressor designed for tropical countries.

Thermostat controlled. Stirring paddle to avoid foaming and oxidation. High quality compressor. Accepts fruit pieces. Stainless steel body.

Product Code	04-006-00014	04-006-00015	04-006-00016
Type	Single	Double	Triple
Dimension	43 x 19 x 54.5cm	43 x 38 x 54.5cm	43 x 57 x 54.5cm
Capacity	1 x 12ℓ	2 x 12ℓ	3 x 12ℓ
Elec. Spec.	230V / 50W / 260W	230V / 50W / 260W	230V / 50W / 330W

BAKEWARE & PASTRY SUPPLIES



CHAPTER

05

SIA HUAT 
Beyond Foodservice Supplies

www.siahuat.com



DEMARLE SILPAT Silicone Non-Stick Pastry Mat

Product Code	Dimension
05-001-00004	40 x 30cm
05-001-00005	52 x 31.5cm
05-001-00006	58.5 x 38.5cm
05-001-00007	62 x 42cm



DEMARLE Silicone Perforated Non-Stick Baking Mat

Product Code	Dimension	
05-001-00009	52 x 31.5cm	Silpain
05-001-00010	58.5 x 38.5cm	Silpat



DEMARLE SILPAT Silicone Non-Stick Pastry Mat for Macaroon

Product Code	Dimension
05-001-00008	37.5 x 27.5cm



DEMARLE ROUL'PAT Silicone Non-Stick Pastry Mat

Product Code	Dimension
05-001-00011	62 x 42cm



DE BUYER Silicone-Coated Fibreglass Baking Mat Airmat

Product Code	Dimension
05-001-00270	40 x 30cm
05-001-00271	51 x 31cm
05-001-00272	58 x 38cm



DE BUYER Teflon-Coated Fibreglass Baking Mat

Product Code	Dimension	Type
05-001-00014	60 x 40cm	Rectangle
05-001-00015	Ø26cm	Circle



SAFICO PRO Silicone Baking Mat

Product Code	Dimension	
05-001-00001	40 x 30cm	
05-001-00002	51 x 31cm	For GN 1/1 Tray
05-001-00003	60 x 40cm	



SAFICO PRO Teflon Non-Stick Baking Mat

Product Code	Dimension	
05-001-00016	40 x 30 x 0.008cm	With Gift Box



Silicone Parchment Paper

Product Code	Dimension
05-001-00012	45 x 75cm



Baking Parchment Paper

Product Code	Dimension	
05-001-00323	40 x 60cm	45gsm; 50pcs/box



MATFER Blue Steel Baking Tray

Product Code	Dimension	
05-001-00085	60 x 40 x 1cm	45° Rim
05-001-00086	53 x 32.5 x 1cm	45° Rim



MATFER Blue Steel Perforated Baking Tray

Product Code	Dimension	
05-001-00087	60 x 40 x 1cm	45° Rim
05-001-00088	53 x 32.5 x 1cm	45° Rim



DE BUYER Black Steel Baking Tray with 45° Rim

Product Code	Dimension	
05-001-00024	53 x 32.5 x 1cm	45° Rim
05-001-00025	40 x 30 x 1cm	45° Rim
05-001-00027	60 x 40 x 1cm	45° Rim



DE BUYER Black Steel Baking Tray with 90° Rim

Product Code	Dimension	
05-001-00026	53 x 32.5 x 2cm	90° Rim
05-001-00028	60 x 40 x 2cm	90° Rim



DE BUYER Stainless Steel Baking Tray with 90° Rim

Product Code	Dimension	
05-001-00018	32.5 x 26.5 x 2cm	GN 1/2
05-001-00019	53 x 32.5 x 2cm	GN 1/1
05-001-00020	65 x 53 x 2cm	GN 2/1
05-001-00021	40 x 30 x 2cm	
05-001-00022	60 x 40 x 2cm	



SCHNEIDER Aluminium Non-Stick Perforated Tray with 45° Rim

Product Code	Dimension	
05-001-00034	53 x 32.5 x 1cm	GN 1/1
05-001-00035	65 x 53 x 1cm	GN 2/1
05-001-00036	60 x 40 x 1cm	



Non-Stick Aluminium GN 1/1 Baking Tray

Product Code	Dimension	
05-001-00263	53 x 32.5 x 1.4cm	Perforated
05-001-00264	53 x 32.5 x 1.4cm	



DE BUYER Aluminium Baking Tray

Product Code	Dimension	
05-001-00044	60 x 40 x 1cm	45° Rim
05-001-00045	60 x 40 x 2cm	90° Rim



SCHNEIDER Aluminium GN 1/1 Tray with 45° Rim

Product Code	Dimension	
05-001-00043	53 x 32.5 x 1cm	GN 1/1



SCHNEIDER Aluminium Perforated Tray with 45° Rim

Product Code	Dimension	
05-001-00047	53 x 32.5 x 1cm	GN 1/1
05-001-00048	60 x 40 x 1cm	Baking Tray



ALEGACY Aluminium Bun / Biscuit Pan

Product Code	Dimension
05-001-00049	44.3 x 32.1 x 2.5cm Half-Size
05-001-00050	65 x 45 x 2.5cm



ALEGACY Aluminium Perforated Bun / Biscuit Pan

Product Code	Dimension
05-001-00051	44.3 x 32.1 x 2.5cm Half-Size
05-001-00052	65 x 45 x 2.5cm



SUNNEX Aluminium Baking Tray

Product Code	Dimension
05-001-00037	31.8 x 21.6 x 1.9cm
05-001-00038	36.8 x 26.7 x 1.9cm
05-001-00039	41.9 x 30.5 x 1.9cm
05-001-00040	47 x 35.6 x 1.9cm
05-001-00041	52.1 x 41.9 x 1.9cm
05-001-00046	65.4 x 45.1 x 2.5cm



SUNNEX Aluminium Full Size Baking Tray

Product Code	Dimension
05-001-00042	53 x 32.5 x 2.5cm GN 1/1



Aluminium Bake Pan

Product Code	Dimension
05-003-00005	60 x 40 x 3cm
05-003-00006	60 x 40 x 5cm



DE BUYER Aluminium Non-Stick Round Pizza Tray

Product Code	Dimension
05-001-00053	Ø24cm
05-001-00054	Ø28cm
05-001-00055	Ø32cm



Non-Stick Deep Pizza Plate

Product Code	Dimension
05-001-00056	Ø16 x H4cm
05-001-00057	Ø18 x H4cm
05-001-00058	Ø20 x H4cm
05-001-00059	Ø22.5 x H4cm
05-001-00060	Ø30 x H4cm



Non-Stick Pizza Plate

Product Code	Dimension
05-001-00061	Ø15 x H2cm
05-001-00062	Ø18 x H2cm
05-001-00063	Ø23 x H2cm
05-001-00064	Ø25 x H2cm
05-001-00065	Ø27 x H2cm
05-001-00066	Ø30 x H2cm



Aluminium Pizza Tray

Product Code	Dimension
05-001-00067	Ø20cm
05-001-00068	Ø22.5cm
05-001-00069	Ø25cm
05-001-00070	Ø27.5cm
05-001-00071	Ø32.5cm



DE BUYER Aluminium Non-Stick Round Perforated Pizza Tray

Product Code	Dimension
05-001-00072	Ø28cm
05-001-00073	Ø32cm



DE BUYER Aluminium Perforated Pizza Tray

Product Code	Dimension
05-001-00074	Ø24cm
05-001-00075	Ø26cm
05-001-00076	Ø28cm
05-001-00077	Ø32cm



Aluminium Pizza Screen

Product Code	Dimension
05-001-00078	Ø25cm
05-001-00079	Ø27.5cm
05-001-00080	Ø30cm
05-001-00081	Ø32.5cm



UPDATE PLC Sleeve for Pizza Tray Stand

Product Code	Dimension
05-001-00089	3pcs/set



MATFER Alu-Gaufer French Bread Sheet for 6 Baguettes

Product Code	Dimension
05-001-00091	65 x 43cm



DE BUYER Blue Steel Fluted Tuiles Sheet

Product Code	Dimension
05-001-00083	35 x 14cm



Non-Stick Fluted Sheet for "Tuiles"

Product Code	Dimension
05-005-00037	35 x 24cm



DE BUYER Stainless Steel Fluted "Tuiles" Sheet

Product Code	Dimension
05-001-00084	35 x 32 x 2.5cm



Non-Stick Baguettes Tray

Product Code	Dimension
05-005-00038	38 x 32cm
05-005-00039	38 x 21cm



Chrome Plated Rd Footed Cooling Rack

Product Code	Dimension
05-001-00103	Ø20cm
05-001-00104	Ø24cm
05-001-00105	Ø28cm
05-001-00106	Ø32cm
05-001-00107	Ø36cm

Stainless Steel Wire Grid

Product Code	Dimension	
05-001-00092	53 x 32.5cm	GN 1/1
05-001-00093	60 x 40cm	
05-001-00094	65 x 53cm	GN 2/1



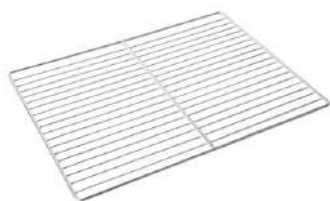

Stainless Steel Wire Grid

Product Code	Dimension
05-001-00320	40 x 30cm



Stainless Steel Footed Shelf / Wire Grid

Product Code	Dimension	
05-001-00321	45 x 25cm	Fits 1/1 Size Food Pan
05-001-00322	25 x 20cm	Fits 1/2 Size Food Pan



Stainless Steel Wire Rack

Product Code	Dimension	
05-001-00261	35.4 x 32.5 x 1cm	GN 2/3
05-001-00262	53 x 32.5 x 1cm	GN 1/1



Stainless Steel Footed GN 1/1 Wire Grid

Product Code	Dimension
05-001-00100	53 x 32.5cm



ALEGACY Chrome-Plated Footed Wire Grid (Fit into Bun Pan)

Product Code	Dimension
05-001-00101	60.9 x 40.6cm



Stainless Steel Wire Grid Tray for Silicone Moulds

Product Code	Dimension
05-001-00102	60 x 40cm



SCHNEIDER Plastic Cake Divider

Product Code	Dimension	
05-001-00120	Ø26.5cm	10 Sections
05-001-00121	Ø26.5cm	12 / 16 Sections
05-001-00122	Ø26.5cm	14 / 16 Sections
05-001-00123	Ø26.5cm	12 / 18 Sections
05-001-00124	Ø26.5cm	14 / 18 Sections
05-001-00125	Ø26.5cm	8 / 12 Sections



Stainless Steel Section Tart Divider

Product Code	Dimension	
05-001-00109	Ø33 x H2.8cm	8 Sections
05-001-00110	Ø33 x H2.8cm	10 Sections
05-001-00111	Ø33 x H2.8cm	12 Sections
05-001-00112	Ø33 x H2.8cm	14 Sections
05-001-00113	Ø33 x H2.8cm	16 Sections
05-001-00114	Ø33 x H2.8cm	18 Sections



WESTMARK Stainless Steel Horizontal Cake Cutter

Product Code	Dimension	
05-001-00115	32.7cm	Single
05-001-00116	32.7cm	Double



CCK Stainless Steel Dough Scraper

Product Code	Dimension	
05-001-00126	15 x 7cm	With Wooden Handle
05-001-00127	17 x 9.3cm	Without Handle



CCK Stainless Steel Scraper

Product Code	Dimension
05-001-00128	13 x 10cm



Stainless Steel Dough Scraper

Product Code	Dimension
05-001-00129	12.5 x 10.5cm



Stainless Steel Roll Tart Strecher Angled

Product Code	Dimension
05-001-00130	20cm
05-001-00131	30cm



Stainless Steel Fluted Dough Cutter

Product Code	Dimension
05-001-00132	10cm



Stainless Steel Cake Smoother / Polisher

Product Code	Dimension
05-001-00133	12.5 x 7.5cm



SCHNEIDER Stainless Steel Spatula with Plastic Handle

Product Code	Dimension
05-001-00153	17cm
05-001-00154	27cm



Chocolate Grater

Product Code	Dimension
05-001-00134	12 x 11cm



Scrapper with Plastic Handle

Product Code	Dimension
05-004-00014	7.6cm
05-004-00015	10.2cm
05-004-00016	12.7cm
05-004-00017	15cm



Stainless Steel Dough Cutter

Product Code	Dimension
05-001-00152	13.6 x 12.5cm



Stainless Steel Dough Scraper with Black PLC Handle

Product Code	Dimension
05-001-00151	15 x 7.5cm



Stainless Steel Decoration Comb

Product Code	Dimension	Type
05-004-00018	10 x 10cm	Square
05-004-00019	11 x 7.5cm	Triangle
05-004-00020	11 x 11cm	Rectangle



Plastic Spatula

Product Code	Dimension
05-001-00141	18 x 9.5cm



ALEGACY Plastic Scraper

Product Code	Dimension
05-001-00143	14.5 x 9cm



MARTELLATO Plastic Asymmetrical Scraper

Product Code	Dimension	
05-001-00155	12.5 x 9cm	Rigid
05-001-00156	12.5 x 9cm	Soft



MARTELLATO Plastic French Scraper

Product Code	Dimension	
05-001-00157	15 x 11cm	Rigid
05-001-00158	15 x 11cm	Soft



MARTELLATO Plastic Smooth Scraper

Product Code	Dimension	
05-001-00159	14.5 x 9.5cm	Rigid
05-001-00160	14.5 x 9.5cm	Soft



MARTELLATO Plastic Oval Scraper

Product Code	Dimension	
05-001-00161	14 x 9cm	Rigid
05-001-00162	14 x 9cm	Soft



MARTELLATO Plastic Shape Scraper

Product Code	Dimension	
05-001-00165	19.5 x 15cm	Semi Circle / Rigid
05-001-00166	21.5 x 12.5cm	Trapezoidal / Rigid



MARTELLATO Plastic Small Smooth Scraper

Product Code	Dimension	
05-001-00163	12 x 9cm	Rigid
05-001-00164	12 x 9cm	Soft



MARTELLATO Plastic Angular Spatula

Product Code	Dimension
05-001-00167	29cm
05-001-00168	39cm



SCHNEIDER Plastic Scraper

Product Code	Dimension
05-001-00144	14.7 x 10cm



SCHNEIDER Rd Dough Scraper

Product Code	Dimension
05-001-00145	11.6 x 7.8cm

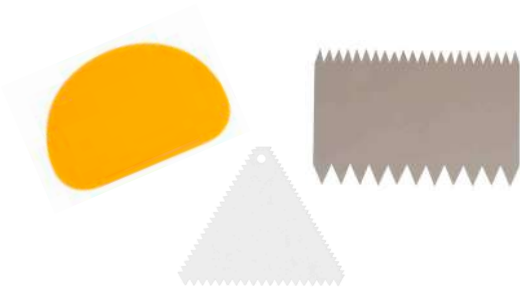

PLC Scraper

Product Code	Dimension	Shape
05-001-00146	12.5 x 9cm	Asymmetrical
05-001-00147	16 x 10cm	Bowl Shape
05-001-00148	11 x 7.5cm	Rect Comb
05-001-00149	11 x 11cm	Triangle Comb (2pcs/pkt)
05-001-00150	9.5 x 9.5cm	Triangle Comb (2pcs/pkt)



MASTRAD Silicone One-Piece Spatula

Dimension	Purple	Red	Green
25.5cm	05-001-00278	05-001-00279	05-001-00280
26.5cm	05-001-00275	05-001-00276	05-001-00277



Plastic Spatula with Rubber Blade

Product Code	Dimension
02-003-00869	25.4cm
02-003-00870	35.5cm
02-003-00871	40.6cm



CCK Wooden Rolling Pin

Product Code	Dimension	
05-001-00172	Ø1 x 26.5cm	Size #2
05-001-00173	Ø1.5 x 40cm	Size #1
05-001-00174	Ø1.5 x 45cm	
05-001-00175	Ø2 x 28cm	
05-001-00176	Ø2 x 28cm	
05-001-00177	Ø3.2 x 60cm	
05-001-00178	Ø3.2 x 75cm	
05-001-00179	Ø3.2 x 90cm	



DE BUYER Polyglass Spatula

Product Code	Dimension
05-001-00135	25cm
05-001-00136	30cm
05-001-00137	35cm
05-001-00138	40cm
05-001-00139	45cm
05-001-00140	50cm



MASTRAD Silicone One-Piece Spatula Spoon

Dimension	Purple	Red	Green
27.5cm	05-001-00281	05-001-00282	05-001-00283



Spatula with Wooden Handle

Product Code	Dimension
05-001-00142	15cm



LACOR Beechwood Rolling Pin

Product Code	Dimension
05-001-00170	43cm
05-001-00171	50cm



CCK Wooden Rolling Pin with Stainless Steel Rod

Product Code	Dimension	
05-001-00180	27.5cm	Size #2
05-001-00181	30.5cm	Size #1



Wooden Mini Revolving Rolling Pin with Red Handle

Product Code	Dimension
05-001-00182	10"



MARTELLATO Plastic Rolling Pin

Product Code	Dimension
05-001-00183	Ø2.5 x 23cm
05-001-00184	Ø4.5 x 50cm
05-001-00185	Ø4.5 x 35cm



MATFER Wooden Rolling Pin without Handle

Product Code	Dimension	
05-001-00208	Ø5 x 50cm	Sorb Tree



GIESSER Pastry Wheel

Product Code	Dimension	
05-001-00188	Ø6cm	Plain
05-001-00189	Ø6cm	Wavy Edge



LACOR Stainless Steel Mini Croissant Cutter

Product Code	Dimension	
05-003-00572	Dough: 15 x 10cm	Single



Stainless Steel Croissant Cutter

Product Code	Dimension
05-001-00190	Dough: 21 x 10cm



Stainless Steel Lattice Pie Top Cutter with PLC Handle

Product Code	Dimension
05-001-00191	Cutting Dimension: 14.7cm



PLC Lattice Top Cutting Roller

Product Code	Dimension
05-001-00192	12cm



SCHNEIDER Stainless Steel Roller Docker with PLC Handle

Product Code	Dimension
05-001-00210	12cm



PLC Roller Docker

Product Code	Dimension
05-001-00193	12.5cm



Kitchen Blowtorch

Product Code	Dimension
05-001-00194	13 x 7 x 16cm



SAFICO Cassette Gas Torch Burner

Product Code	Dimension	Colour
05-001-00195	15.6 x 5.8 x 5cm	Blue



IWATANI Cassette Gas Torch Burner

Product Code	Dimension
05-001-00196	20.5cm



IWATANI Gas Cartridge

Product Code	Capacity
05-001-00197	250gm/can



Stainless Steel Chocolate Dipping Fork with PLC Handle

Product Code	Capacity
05-001-00198	10pcs/set



Stainless Steel Egg Separator

Product Code	Capacity
05-001-00199	53 x 12.8 x 310cm



DE BUYER Stainless Steel Mini Piston Funnel with Stand

Product Code	Dimension	Capacity	Colour
05-001-00200	18.5 x 15 x 15.5cm	0.8l	Black



DE BUYER Stainless Steel Piston Funnel

Product Code	Dimension	Capacity
05-001-00201	Ø19 x H18cm	1.9l



Stainless Steel Piston Funnel with Stand

Product Code	Dimension	Capacity
05-001-00203	13 x 20cm	1.25l

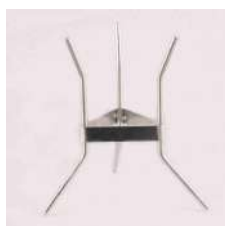

Stainless Steel Stand for Fondant Funnel

Product Code
05-001-00202



MARTELLATO Gradiated 1 Litre Bottle

Product Code	Dimension	
05-001-00204	7 x 7 x 27cm	Square
05-001-00205	Ø8.5 x H25cm	Round



MARTELLATO Plastic Pastry Portioning Ruler

Product Code	Dimension	
05-001-00206	64cm	
05-001-00207	57 x 6cm	2pcs/set, for use with 60x40cm trays



SCHNEIDER Boar Bristles Pastry Brush with Wooden Handle

Product Code	Dimension (Width of Brush)	Type
05-001-00216	2.5cm	Flat
05-001-00217	3cm	Flat
05-001-00218	3.5cm	Flat
05-001-00219	4cm	Flat
05-001-00220	5cm	Flat
05-001-00221	6cm	Flat
05-001-00222	8cm	Flat
05-001-00223	10cm	Flat
05-001-00224	2.5cm	Round



SPARTA Chef Series Basting Brush with Boar Bristles

Product Code	Dimension (Width of Brush)
05-001-00230	10cm
05-001-00231	2.5cm
05-001-00232	3.7cm
05-001-00233	5cm
05-001-00234	7.5cm
05-001-00235	10cm



LACOR Silicone Pastry Brush with Stainless Steel Handle

Product Code	Dimension (Width of Brush)
05-001-00236	3cm
05-001-00237	4cm
05-001-00238	6cm



LACOR Boar Bristles Pastry Brush with Plastic Handle & Stainless Steel Band

Product Code	Dimension (Width of Brush)
05-001-00211	3cm
05-001-00212	3.5cm
05-001-00213	4cm
05-001-00214	4.5cm
05-001-00215	5cm



ALEGACY Pastry Brush with Stainless Steel Band & Wooden Handle

Product Code	Dimension (Width of Brush)
05-001-00225	2.5cm
05-001-00226	3.7cm
05-001-00227	5cm
05-001-00228	6.2cm
05-001-00229	7cm



SPARTA Galaxy Pastry Brush

Product Code	Dimension (Width of Brush)
05-001-00249	2.5cm
05-001-00245	3.7cm
05-001-00246	5cm
05-001-00247	7.5cm
05-001-00248	10cm



SPARTA Waffle & Griddle Rd Brush with 1" Teflon

Product Code	Dimension
05-001-00244	24.5 x 2.5cm



SPARTA Meteor Pastry Brush

Product Code	Dimension
05-001-00250	5cm with 2" Bristles
05-001-00251	7.5cm with 3" Bristles



SCHNEIDER Plastic Flour & Sugar Sieve with Nylon Mesh

Product Code	Dimension
05-001-00239	Ø0.5mm, Ø24cm
05-001-00240	Ø1mm, Ø24cm
05-001-00241	Ø0.5mm, Ø30cm
05-001-00242	Ø1mm, Ø30cm



SCHNEIDER Stainless Steel Sugar Sieve

Product Code	Dimension
05-001-00243	Ø18.5cm



MATFER Stainless Steel Revolving Cake Stand

Product Code	Dimension
05-001-00260	Ø30 x H3.8cm



SCHNEIDER Melamine Tilting Cake Stand / Turntable

Product Code	Dimension
05-001-00117	Ø30 x H16cm



Stainless Steel Revolving Cake Stand / Turntable

Product Code	Dimension
05-001-00254	Ø25 x H17cm
05-001-00255	Ø30 x H17cm



SCHNEIDER Melamine Revolving Cake Display Stand

Product Code	Dimension	Colour
05-001-00256	Ø32 x H10cm	<input type="checkbox"/> White
05-001-00257	Ø32 x H10cm	<input checked="" type="checkbox"/> Black



Aluminium Revolving Cake Stand

Product Code	Dimension	
05-001-00258	Ø30cm	Round



CCK Stainless Steel Dim Sum Box with Cover

Product Code	Dimension	
05-002-00001	30 x 30cm	Square
05-002-00004	30 x 15cm	Rectangle



CCK Stainless Steel Dim Sum Box without Cover

Product Code	Dimension	
05-002-00002	30 x 30cm	Square



CCK Stainless Steel Square Cake Ring

Product Code	Dimension	
05-002-00003	30 x 30cm	Square



CCK Aluminium Square Baking Pan

Product Code	Dimension
05-002-00005	47.5 x 47.5 x 3.7cm
05-002-00006	47.5 x 47.5 x 5cm
05-002-00007	50 x 50 x 3.7cm
05-002-00008	50 x 50 x 5cm



CCK Iron Round Baking Pan

Product Code	Dimension
05-002-00009	Ø45 x 3.7cm
05-002-00010	Ø47.5 x 3.7cm



CCK Aluminium Round Baking Pan

Product Code	Dimension
05-002-00011	Ø47.5 x 3.7cm
05-002-00019	Ø45 x 3.7cm



CCK Stainless Steel Dim Sum Spatula

Product Code	Dimension
05-002-00027	20cm



Dim Sum Spatula

Product Code	Colour
05-002-00020	Transparent



CCK Small Bamboo Pastry Brush

Product Code	Dimension
05-002-00026	15.5cm



CCK PLC Rolling Pin

Product Code	Dimension	Colour
05-002-00021	Ø2 x 28cm	<input type="checkbox"/> White
05-002-00022	Ø2 x 28cm	<input checked="" type="checkbox"/> Red
05-002-00023	Ø4.5 x 50cm	<input type="checkbox"/> White



CCK PLC Rolling Pin Stainless Steel Rod

Product Code	Dimension	
05-002-00024	30.5cm w/o Handle	Size #1
05-002-00025	28cm w/o Handle	Size #2



CCK Stainless Steel Rolling Pin

Product Code	Dimension
05-002-00028	Ø1.5 x 28.5cm
05-002-00029	Ø1.2 x 26.5cm
05-002-00030	Ø2.5 x 28.5cm
05-002-00031	Ø1.5 x 46cm



Stainless Steel Noodle Rolling Pin

Product Code	Dimension
05-002-00032	Ø5.1 x 25cm
05-002-00033	Ø6.3 x 25cm
05-002-00034	Ø7.6 x 25cm



Aluminium Alloy Toast Box with Cover

Product Code	Dimension	Weight
05-003-00001	26 x 14.5 x 12cm	850g
05-003-00002	32.5 x 11.5 x 11.5cm	750g
05-003-00003	33.5 x 12.3 x 12cm	1000g



Aluminium Alloy Bread Box

Product Code	Dimension
05-003-00004	39.5 x 12.5 x 11cm



EIFFEL Aluminium Round Cake Tin

Product Code	Dimension
05-003-00059	Ø18 x H5cm
05-003-00060	Ø18 x H6cm
05-003-00061	Ø20 x H4cm
05-003-00062	Ø20 x H6cm
05-003-00063	Ø25 x H7cm
05-003-00064	Ø28 x H7cm
05-003-00065	Ø22 x H6cm



EIFFEL Aluminium Square Cake Tin

Product Code	Dimension
05-003-00066	20 x 20 x 5.5cm
05-003-00067	22 x 22 x 6cm
05-003-00068	25 x 25 x 6cm



Aluminium Round Deep Cake Mould

Product Code	Dimension
05-003-00027	Ø5 x H3.6cm
05-003-00028	Ø5.7 x H4.4cm
05-003-00029	Ø7 x H5.9cm
05-003-00030	Ø7 x H6.8cm
05-003-00031	Ø8 x H7.5cm
05-003-00032	Ø8.5 x H5.1cm
05-003-00033	Ø8.5 x H8cm



Aluminium Chicken Pie Mould

Product Code	Dimension
05-003-00034	Ø7 x H2.2cm



Aluminium Egg Tart Mould

Product Code	Dimension
05-003-00021	Ø8.8 x H2.5cm



Aluminium Chui Kuay Mould

Product Code	Dimension
05-003-00019	Ø6.5 x H2.7cm
05-003-00020	Ø7.04 x H3cm



Aluminium Cake Mould

Product Code	Dimension
05-003-00010	Ø6.5 x H2.8cm
05-003-00013	Ø7.5 x H3.2cm
05-003-00014	Ø8 x H3.5cm
05-003-00016	Ø8.5 x H3.5cm
05-003-00015	Ø9 x H3.8cm
05-003-00017	Ø10.25 x H4cm
05-003-00018	Ø12 x H4.5cm



Aluminium Cake Mould

Product Code	Dimension
05-003-00011	Ø3"



Aluminium Fluted Tart Mould

Product Code	Dimension
05-003-00022	Ø1.75" (Fine)
05-003-00023	Ø2" (Fine)
05-003-00024	Ø2" (Fine)
05-003-00007	Ø2.75" (Fine)
05-003-00012	Ø3"



Aluminium Round Fluted Cake Mould

Product Code	Dimension
05-003-00025	Ø2"



Aluminium Cake Mould

Product Code	Dimension
05-003-00009	Ø2.5"



CCK Aluminium Fluted Tart Mould

Product Code	Dimension	Number
05-003-00418	Ø4.5 x H1.7cm	22
05-003-00419	Ø5.3 x H1.7cm	20
05-003-00420	Ø5.5 x H1.9cm	21
05-003-00421	Ø6 x H1.9cm	19
05-003-00423	Ø7 x H2.1cm	12
05-003-00422	Ø7.5 x H2.5cm	1



Stainless Steel Mini Cake Mould

Product Code	Dimension
05-003-00408	Ø4.8 x H0.6cm



Aluminium Mini Muffin Pan

Product Code	Dimension	
05-003-00036	20 x 13.8cm Mould Dimension: Ø4.7 x H2.5cm	6 muffins
05-003-00037	26 x 20cm Mould Dimension: Ø4.7 x H2.5cm	12 muffins
05-003-00038	39 x 26cm Mould Dimension: Ø4.7 x H2.5cm	24 muffins



Aluminium Jelly Mould

Product Code	Dimension
05-003-00411	Ø10 x H4cm
05-003-00412	Ø12.5 x H5.5cm
05-003-00413	Ø15 x H6cm
05-003-00414	Ø17 x H6.5cm
05-003-00415	Ø20 x H7.5cm



SCHNEIDER Aluminium Non-Stick Loaf Cake Mould

Product Code	Dimension	Capacity
05-001-00082	25 x 10 x 7cm	1.45ℓ
05-003-00043	30 x 11 x 7.9cm	2.15ℓ
05-003-00044	35 x 12 x 8.5cm	3ℓ



SCHNEIDER Aluminium Non-Stick Ridged Baking Mould

Product Code	Dimension	Capacity
05-003-00045	28 x 11 x 6cm	1.35ℓ
05-003-00046	33 x 11 x 6cm	1.6ℓ



Aluminium Pie Pan

Product Code	Dimension
05-003-00048	Ø24.5 x H4cm



Aluminium Rectangle Loaf Pan

Product Code	Dimension
05-003-00049	11.3 x 6.3 x 3.2cm
05-003-00050	12.8 x 7 x 3.8cm
05-003-00051	13.6 x 7.9 x 6.4cm
05-003-00052	15.2 x 8.8 x 7.1cm
05-003-00053	19 x 9 x 7.3cm



PAVONI PVC Confectionery Ribbon

Product Code	Dimension
05-001-00326	Roll Length L200m x H3cm
05-001-00327	Roll Length L200m x H3.5cm
05-001-00328	Roll Length L200m x H4cm
05-001-00329	Roll Length L200m x H4.5cm
05-001-00330	Roll Length L200m x H5cm
05-003-00799	Roll Length L200m x H6cm



LACOR Aluminium Non-Stick 12-Portion Madeleine Pan

Product Code	Dimension	
05-003-00039	40 x 20cm	12 Moulds



Non-Stick Muffin Pan

Product Code	Dimension	
05-003-00091	24.4 x 18.5 x 2.1cm Mould Dimension: Ø4.2 x H1.5cm	12 mini muffins
05-003-00410	26.8 x 18.2 x 2.7cm Mould Dimension: Ø7 x H2cm	6 muffins
05-003-00092	35.4 x 26.8 x 2.8cm Mould Dimension: Ø7 x H3.2cm	12 muffins



GOBEL Non-Stick Rect Stamped 6 Financier Mould

Product Code	Dimension	
05-003-00099	38 x 18 x 1.3cm	6 Moulds



GOBEL Non-Stick Madeleine Cup Cake Sheet

Product Code	Dimension	
05-003-00245	39.5 x 12.5cm	20 Moulds

GOBEL Non-Stick Rect Stamed 12 Mini Financier Mould

Product Code	Dimension	
05-003-00246	29 x 20cm	12 Moulds

Non-Stick Rect Loaf Pan

Product Code	Dimension
05-003-00096	21 x 11.5 x 7cm Mould Dimension: 19.5 x 10 x 5.6cm

GOBEL Non-Stick Mini Pate Mould with Hinges & Loose Bottom

Product Code	Dimension
05-003-00100	30 x 4 x 6cm
05-003-00101	50 x 4 x 6cm

LACOR Non-Stick Rectangle Cake Mould

Product Code	Dimension
05-003-00093	25 x 12 x 8.5cm
05-003-00094	30 x 12 x 8.5cm
05-003-00095	35 x 12 x 8.5cm

GOBEL Non-Stick Pate Mould with Hinges & Loose Bottom

Product Code	Dimension
05-003-00102	30 x 8 x 8cm
05-003-00103	40 x 8 x 8cm
05-003-00104	50 x 8 x 8cm

MATFER Exopan Rect Pate Mould with Ridges

Product Code	Dimension
05-003-00409	30 x 7 x 8.5cm

GOBEL Non-Stick Closed Savarin Mould

Product Code	Dimension	Packing
05-003-00132	Ø6.5 x H1.5cm	12pcs/pkt
05-003-00133	Ø7 x H1.7cm	12pcs/pkt
05-003-00134	Ø8 x H2cm	12pcs/pkt

GOBEL Non-Stick Round Open Savarin Mould

Product Code	Dimension	Packing
05-003-00135	Ø8 x H2cm	12pcs/pkt
05-003-00136	Ø12 x H2.5cm	3pcs/pkt
05-003-00137	Ø22 x H4.5cm	1pc/pkt
05-003-00138	Ø24 x H5cm	1pc/pkt

GOBEL Non-Stick Rd Open Trois Freres Ring Mould

Product Code	Dimension
05-003-00142	Ø22 x H5.5cm

GOBEL Non-Stick Square Cake Mould with Fixed Bottom

Product Code	Dimension
05-003-00139	10 x 4cm
05-003-00140	22 x 5cm
05-003-00141	24 x 5cm



GOBEL Non-Stick Brioche Mould with Flat Bottom and 9 Ribs

Product Code	Dimension
05-003-00105	Ø6 x H2.5cm
05-003-00106	Ø7 x H2.8cm
05-003-00107	Ø7.5 x H3cm
05-003-00108	Ø8 x H3.2cm
05-003-00109	Ø9 x H3.5cm
05-003-00110	Ø10 x H3.8cm
05-003-00111	Ø11 x H4.2cm
05-003-00112	Ø14 x H4.8cm
05-003-00113	Ø16 x H5.5cm
05-003-00114	Ø18 x H5.6cm
05-003-00115	Ø20 x H7.2cm
05-003-00116	Ø22 x H8.7cm
05-003-00117	Ø24 x H10cm



GOBEL Non-Stick Round Plain Cake Mould with Rolled Edges

Product Code	Dimension	
05-003-00118	Ø10 x H3cm	
05-003-00119	Ø12 x H3.4cm	
05-003-00120	Ø14 x H3.5cm	
05-003-00121	Ø16 x H4cm	
05-003-00122	Ø18 x H4.5cm	
05-003-00123	Ø20 x H4.5cm	
05-003-00124	Ø22 x H5cm	
05-003-00125	Ø24 x H5cm	
05-003-00126	Ø26 x H5cm	
05-003-00127	Ø28 x H5cm	
05-003-00128	Ø30 x H5.3cm	
05-003-00129	Ø32 x H5.5cm	
05-003-00130	Ø10 x H3cm	with Loose Bottom
05-003-00131	Ø18 x H4.5cm	with Loose Bottom



GOBEL Non-Stick Round Deep Fluted Cake Mould with Rolled Edges

Product Code	Dimension
05-003-00143	Ø23 x H6.5cm
05-003-00144	Ø26 x H6.5cm
05-003-00145	Ø29 x H7cm



GOBEL Non-Stick Round Fluted Cake Mould with Fixed Bottom & Narrow Ribs

Product Code	Dimension
05-003-00146	Ø10 x H3cm
05-003-00147	Ø15 x H4cm
05-003-00148	Ø20 x H4.5cm
05-003-00149	Ø25 x H5cm



GOBEL Non-Stick Round Fluted Cake Mould with Loose Bottom & Narrow Ribs

Product Code	Dimension
05-003-00150	Ø10 x H3cm
05-003-00151	Ø15 x H4cm
05-003-00152	Ø20 x H4.5cm
05-003-00153	Ø25 x H5cm



DE BUYER Blue Steel Fluted Pie Pan with Removable Base

Product Code	Dimension
05-003-00076	Ø24 x H3.5cm
05-003-00077	Ø26.3 x H3.5cm



Non-Stick Fluted Pan with Removable Bottom

Product Code	Dimension
05-003-00088	Ø16 x H2.3cm
05-003-00089	Ø20 x H2.6cm
05-003-00090	Ø24 x H2.6cm



GOBEL Non-Stick Rect Reinforced Rolled Edges Baking Sheet

Product Code	Dimension
05-003-00154	35 x 25 x 5cm
05-003-00155	51 x 36 x 5cm
05-003-00156	61 x 41 x 5cm



GOBEL Non-Stick Round Plain Mould with Rolled Edges

Product Code	Dimension	Packing
05-003-00159	Ø6 x H1.7cm	12pcs/pkt
05-003-00160	Ø8 x H1.8cm	12pcs/pkt
05-003-00161	Ø9 x H1.9cm	12pcs/pkt
05-003-00162	Ø10 x H2.1cm	12pcs/pkt



GOBEL Non-Stick Round Fluted Tart Mould with Loose Bottom

Product Code	Dimension
05-003-00163	Ø10 x H1.8cm
05-003-00164	Ø11 x H2cm
05-003-00165	Ø12 x H2cm
05-003-00166	Ø14 x H2.5cm



GOBEL Non-Stick Rect Tart Mould with Fluted Edges and Loose Bottom

Product Code	Dimension
05-003-00157	32 x 2.5cm
05-003-00158	29 x 20.5 x 2.5cm



GOBEL Non-Stick Sq Tart Mould with Fluted Edges and Loose Bottom

Product Code	Dimension
05-003-00198	23 x 2.5cm



GOBEL Non-Stick Rd Fluted Tart Mould with Perforated and Fixed Bottom

Product Code	Dimension
05-003-00211	Ø30 x H2.5cm
05-003-00212	Ø32 x H2.5cm



GOBEL Non-Stick Oval Aspic Mould with Plain Bottom

Product Code	Dimension	Packing
05-003-00215	75 x 55 x 38mm	12pcs/pkt



GOBEL Non-Stick Square Tart Mould with Fluted and Loose Bottom

Product Code	Dimension	Packing
05-003-00228	10 x 10 x 2cm	12pcs/pkt



GOBEL Non-Stick Fluted Square Petit Four Mould

Product Code	Dimension	Packing
05-003-00229	3.5cm	12pcs/pkt



GOBEL Non-Stick Ribbed Dome Petit Four Mould

Product Code	Dimension	Packing
05-003-00230	Ø4.5cm	12pcs/pkt



GOBEL Non-Stick Round Fresh Fruit Tartlet with Fluted

Product Code	Dimension	Packing
05-003-00231	Ø10 x H1.8cm	12pcs/pkt



GOBEL Non-Stick Fluted Oval Petit Four Mould

Product Code	Dimension	Packing
05-003-00232	4.5cm	12pcs/pkt



GOBEL Non-Stick Ribbed Oval Petit Four Mould

Product Code	Dimension	Packing
05-003-00233	4.5cm	12pcs/pkt



GOBEL Non-Stick Diamond Shaped Boat Petit Four Mould

Product Code	Dimension	Packing
05-003-00249	6cm	12pcs/pkt



GOBEL Non-Stick Plain Rect Petit Four Mould

Product Code	Dimension	Packing
05-003-00250	5cm	12pcs/pkt



GOBEL Non-Stick Plain Rect Petit Four Mould

Product Code	Dimension	Packing
05-003-00251	Ø3.5cm	12pcs/pkt



GOBEL Non-Stick Petit Four Mould

Product Code	Packing
05-003-00247	60pcs/set (5pcs x 12models)
05-003-00248	30pcs/set (5pcs x 6models)



GOBEL Non-Stick Plain Oval Boat Petit Four Mould

Product Code	Dimension	Packing
05-003-00216	6 x 2 x 1cm	12pcs/pkt
05-003-00217	7 x 2.8 x 1cm	12pcs/pkt
05-003-00218	8 x 3.3 x 1.2cm	12pcs/pkt
05-003-00219	9 x 4 x 1.2cm	12pcs/pkt
05-003-00220	10 x 4.3 x 1.3cm	12pcs/pkt
05-003-00221	11 x 4.6 x 1.3cm	12pcs/pkt
05-003-00222	12 x 5 x 1.3cm	12pcs/pkt



GOBEL Non-Stick Fluted Oval Boat Mould

Product Code	Dimension	Packing
05-003-00223	8 x 4 x 1.2cm	12pcs/pkt
05-003-00224	9 x 4.3 x 1.2cm	12pcs/pkt
05-003-00225	10 x 4.5 x 1.2cm	12pcs/pkt
05-003-00226	11 x 4.7 x 1.3cm	12pcs/pkt
05-003-00227	12 x 5 x 1.4cm	12pcs/pkt



GOBEL Non-Stick Round Fluted Tart Mould with Fixed Bottom

Product Code	Dimension	Packing
05-003-00167	Ø4.5 x H1cm	12pcs/pkt
05-003-00168	Ø5 x H1cm	12pcs/pkt
05-003-00169	Ø6 x H1cm	12pcs/pkt
05-003-00170	Ø7 x H1cm	12pcs/pkt
05-003-00171	Ø8 x H1.2cm	12pcs/pkt
05-003-00172	Ø9 x H1.5cm	12pcs/pkt
05-003-00173	Ø10 x H1.8cm	12pcs/pkt
05-003-00174	Ø11 x H2cm	12pcs/pkt
05-003-00175	Ø12 x H2cm	12pcs/pkt
05-003-00176	Ø14 x H2.5cm	12pcs/pkt
05-003-00177	Ø20 x H2.5cm	
05-003-00178	Ø22 x H2.5cm	
05-003-00179	Ø24 x H2.5cm	
05-003-00180	Ø26 x H2.5cm	
05-003-00181	Ø28 x H2.5cm	
05-003-00182	Ø30 x H2.5cm	
05-003-00183	Ø32 x H2.5cm	



GOBEL Non-Stick Plain Round Tart Mould with Fixed Bottom

Product Code	Dimension	Packing
05-003-00203	Ø3.5 x H0.8cm	12pcs/pkt
05-003-00204	Ø4 x H0.9cm	12pcs/pkt
05-003-00205	Ø5 x H1.1cm	12pcs/pkt
05-003-00206	Ø6 x H1.2cm	12pcs/pkt
05-003-00207	Ø7 x H1.2cm	12pcs/pkt
05-003-00208	Ø8 x H1.2cm	12pcs/pkt
05-003-00209	Ø9 x H1.2cm	12pcs/pkt
05-003-00210	Ø10 x H1.2cm	12pcs/pkt
05-003-00199	Ø12 x H2.1cm	
05-003-00200	Ø24 x H2.3cm	
05-003-00201	Ø28 x H2.3cm	
05-003-00202	Ø32 x H2.5cm	



GOBEL Non-Stick Round Open Deep Savarin Mould

Product Code	Dimension
05-003-00240	Ø22 x H5.8cm
05-003-00241	Ø24 x H5.8cm
05-003-00242	Ø26 x H6.2cm



GOBEL Non-Stick Round Medium Deep Fluted Cake Mould

Product Code	Dimension	
05-003-00184	Ø20 x H3.5cm	with Fixed Bottom
05-003-00185	Ø22 x H3.5cm	with Fixed Bottom
05-003-00186	Ø24 x H3.5cm	with Fixed Bottom
05-003-00187	Ø26 x H3.5cm	with Fixed Bottom
05-003-00188	Ø28 x H3.5cm	with Fixed Bottom
05-003-00189	Ø30 x H3.5cm	with Fixed Bottom
05-003-00190	Ø32 x H3.5cm	with Fixed Bottom
05-003-00191	Ø20 x H3.5cm	with Loose Bottom
05-003-00192	Ø22 x H3.5cm	with Loose Bottom
05-003-00193	Ø24 x H3.5cm	with Loose Bottom
05-003-00194	Ø26 x H3.5cm	with Loose Bottom
05-003-00195	Ø28 x H3.5cm	with Loose Bottom
05-003-00196	Ø30 x H3.5cm	with Loose Bottom
05-003-00197	Ø32 x H3.5cm	with Loose Bottom



GOBEL Non-Stick Square Tart Mould with Fluted Edges and Loose Bottom

Product Code	Dimension
05-003-00198	23 x 2.5cm



GOBEL Non-Stick Tulip Mould

Product Code	Dimension
05-003-00235	Ø13 x H3.5cm
05-003-00236	Ø14 x H3.7cm
05-003-00237	Ø16.5 x H4.5cm
05-003-00238	Ø17 x H6cm
05-003-00239	Ø18 x H7cm



GOBEL Non-Stick Rd Kougloff Mould

Product Code	Dimension
05-003-00213	Ø21 x H8cm

GOBEL Non-Stick Round Dariole Mould

Product Code	Dimension
05-003-00214	Ø6 x 4.8 x 6cm

GOBEL Non-Stick Round Ramekin Mould

Product Code	Dimension
05-003-00234	Ø8 x H5cm

GOBEL Non-Stick Fluted Heart Mould with Loose Bottom

Product Code	Dimension
05-003-00243	23 x 20 x 3cm

GOBEL Non-Stick Rect Reinforced Rolled Edges Baking Sheet

Product Code	Dimension
05-003-00244	40 x 30 x 5cm

GOBEL Non-Stick Rect Friand Mould

Product Code	Dimension
05-003-00252	10 x 5 x 1.4cm



05-003-00078/79



05-003-00080



05-003-00081/82/83



05-003-00084/85



05-003-00086

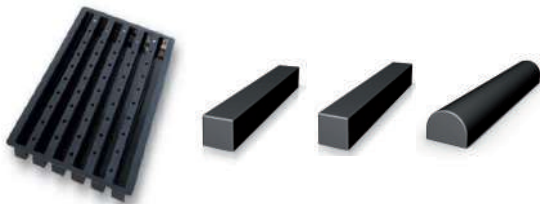

05-003-00087

MARTELLATO Silicone Rectangle Yule Log Mould 60x40

Product Code	Dimension	Capacity	Type
05-003-00347	50 x 3 x 3cm	0.45ℓ 6 pieces	Rectangle Long
05-003-00348	50 x 7 x 7cm	2.45ℓ 4 pieces	Rectangle Long
05-003-00349	50 x 8 x 54.5cm	2.1ℓ 4 pieces	Round Long

DE MARLE Flexipan Sheet

Product Code	Dimension	Capacity	Type
05-003-00078	Ø41 x 12mm	10ml, 30pcs	Mini Savarins
05-003-00079	Ø41 x 12mm	10ml, 60pcs	Mini Savarins
05-003-00080	Ø68 x 25mm	60ml, 12pcs	Fluted Brioches
05-003-00081	Ø26 x 16mm	6ml, 45pcs	Mini Half Spheres
05-003-00082	Ø26 x 16mm	6ml, 96pcs	Mini Half Spheres
05-003-00083	Ø29 x 18mm	10ml, 70pcs	Mini Half Spheres
05-003-00084	Ø70 x 40mm	105ml, 12pcs	Half Spheres
05-003-00085	Ø70 x 40mm	105ml, 24pcs	Half Spheres
05-003-00086	Ø51 x 29mm	45ml, 40pcs	Mini Muffins
05-003-00087	Ø73 x 40mm	125ml, 24pcs	Muffins

MARTELLATO PLC Pre-Cut Confectionery Ribbons

Product Code	Dimension	Capacity
05-003-00328	15 x 2.5cm Thickness: 90microns	1000pcs/pkt
05-003-00329	24 x 3cm Thickness: 90microns	1000pcs/pkt

GOBEL Non-Stick Round Charlotte Mould

Product Code	Dimension
05-003-00352	Ø18 x H10cm



DE BUYER ELASTOMOULE *Silicone 9-Portion Rectangle Cake Mould*

Product Code	Dimension	Capacity
05-003-00356	30 x 17.6cm 9 x 4.8 x 3cm	105ml / 9 Rectangle



DE BUYER ELASTOMOULE *Silicone 9-Portion Madeleine Mould*

Product Code	Dimension	Capacity
05-003-00357	30 x 17.6cm 8 x 4.5 x 1.8cm	30ml / 9 Madeleines



DE BUYER ELASTOMOULE *Silicone 6-Portion Muffin Mould*

Product Code	Dimension	Capacity
05-003-00358	30 x 17.6cm Ø7.4 x H3cm	95ml / 6 Muffins



DE BUYER ELASTOMOULE *Silicone 8-Portion Bordelais Mould*

Product Code	Dimension	Capacity
05-003-00359	30 x 17.6cm Ø5.5 x H5cm	82ml / 8 Bordelais



DE BUYER ELASTOMOULE *Silicone 8-Portion Cube Mould*

Product Code	Dimension	Capacity
05-003-00360	30 x 17.6cm 5 x 5 x 5cm	115ml / 8 Cubes

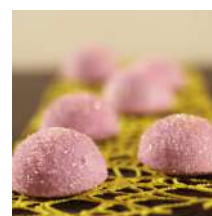

DE BUYER ELASTOMOULE *Silicone 24-Portion Mini Hemi-Spherical Mould*

Product Code	Dimension	Capacity
05-003-00361	30 x 17.6cm Ø3 x H1.7cm	12ml / 24 Mini Hemisphere



DE BUYER ELASTOMOULE *Silicone 30-Portion Mini Madeleine Mould*

Product Code	Dimension	Capacity
05-003-00362	30 x 17.6cm 4 x 3 x 1.1cm	6.4ml / 30 Mini Madeleines



DE BUYER ELASTOMOULE *Silicone 25-Portion Mini Financier Mould*

Product Code	Dimension	Capacity
05-003-00363	30 x 17.6cm 4.9 x 2.6 x 1.1cm	10.5ml / 25 Mini Financiers



DE BUYER ELASTOMOULE *Silicone 28-Portion Bordelais Mould*

Product Code	Dimension	Capacity
05-003-00364	30 x 17.6cm Ø3.5 x H3.5cm	19ml / 28 Bordelais



DE BUYER ELASTOMOULE *Silicone 15-Portion Mini Muffin Mould*

Product Code	Dimension	Capacity
05-003-00365	30 x 17.6cm Ø4.5 x H3cm	39ml / 15 Mini Muffins



DE BUYER ELASTOMOULE *Silicone 15-Portion Mini Cube Mould*

Product Code	Dimension	Capacity
05-003-00366	30 x 17.6cm 3.5 x 3.5 x 3.5cm	40mℓ / 15 Mini Cubes



DE BUYER ELASTOMOULE *Silicone 20-Portion Mini Cake Mould*

Product Code	Dimension	Capacity
05-003-00367	30 x 17.6cm 4.9 x 2.7 x 2.7cm	31.5mℓ / 20 Mini Cakes



PAVONI *Silicone Perforated Pastry Mould*

Product Code	Dimension	Capacity
05-003-00718	60 x 40cm 12.5 x 2.5 x 0.5cm	24 Eclair Manias



PAVONI *Silicone Pastry Mould*

Product Code	Dimension	Capacity	Type
05-003-00691	16.5 x 16.5 x 4cm	1000mℓ	Mars



PAVONI *Silicone Pastry Mould*

Product Code	Dimension	Capacity	Model
05-003-00692	Ø18 x H4.5cm	900mℓ	Flip



PAVONI *Silicone Pastry Mould*

Product Code	Dimension	Capacity	Model
05-003-00693	23 x 10.5 x 4.5cm	1000mℓ	Honore



PAVONI *Silicone Pastry Mould*

Product Code	Dimension	Capacity	Model
05-003-00694	25 x 10 x 4cm	900mℓ	Venus



PAVONI *Silicone Pastry Mould*

Product Code	Dimension	Capacity	Model
05-003-00695	25 x 8 x 8cm	1200mℓ	Atomic



PAVONI *Silicone Pastry Mould*

Product Code	Dimension	Capacity	Model
05-003-00696	Ø18/5.2 x H5.7mm	1000mℓ	Queen



PAVONI *Silicone Pastry Mould*

Product Code	Dimension	Capacity	Model
05-003-00697	Ø18/55.6 x H6cm	1000mℓ	Singapore



PAVONI Silicone Pastry Mould, Top

Product Code	Dimension	Capacity
05-003-00698	30 x 17.5cm	30ml / 6 Ipnosis



PAVONI Silicone Pastry Mould, Top

Product Code	Dimension	Capacity
05-003-00699	19 x 19cm	185ml / 1 Ipnosi



PAVONI Silicone Pastry Mould, Top

Product Code	Dimension	Capacity
05-003-00700	30 x 17.5cm	90ml / 2 Corals



PAVONI Silicone Pastry Mould, Top

Product Code	Dimension	Capacity
05-003-00701	30 x 17.5cm	110ml / 2 Rivers



PAVONI Silicone Pastry Mould, Top

Product Code	Dimension	Capacity
05-003-00702	30 x 17.5cm	90ml / 2 Mayas

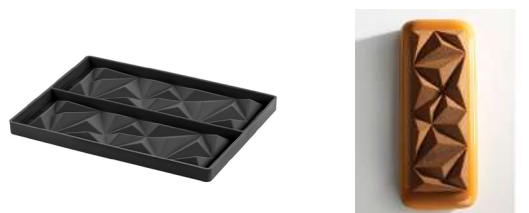

PAVONI Silicone Pastry Mould, Top

Product Code	Dimension	Capacity
05-003-00703	24 x 17.5cm	100ml / 2 Icebergs



PAVONI Silicone Pastry Mould, Pavolex

Product Code	Dimension	Capacity
05-003-00704	40 x 30cm 12.8 x 3 x 2.8cm	90ml / 14 Confys



PAVONI Silicone Pastry Mould, Pavolex

Product Code	Dimension	Capacity
05-003-00705	40 x 30cm 8.2 x 4.4 x 3.7cm	100ml / 15 Delishs



PAVONI Silicone Pastry Mould, Pavolex

Product Code	Dimension	Capacity
05-003-00706	40 x 30cm 13 x 3.2 x 2.8cm	90ml / 14 Pelotas



PAVONI Silicone Pastry Mould, Pavolex

Product Code	Dimension	Capacity
05-003-00707	40 x 30cm 12.5 x 2.8 x 2.8cm	90ml / 14 Pastels



PAVONI Silicone Pastry Mould, Pavalex

Product Code	Dimension	Capacity
05-003-00708	40 x 30cm Ø5.5 x H4.8cm	90ml / 20 Apples



PAVONI Silicone Pastry Mould, Pavalex

Product Code	Dimension	Capacity
05-003-00709	40 x 30cm Ø5.7 x H5cm	90ml / 20 Tangerines



PAVONI Silicone Pastry Mould, Pavalex

Product Code	Dimension	Capacity
05-003-00710	40 x 30cm Ø6.5 x H3.4cm	90ml / 12 Loops



PAVONI Silicone Pastry Mould, Pavalex

Product Code	Dimension	Capacity
05-003-00711	40 x 30cm 8 x 4.6 x 3.8cm	100ml / 15 Turns



PAVONI Silicone Pastry Mould, Pavalex

Product Code	Dimension	Capacity
05-003-00712	40 x 30cm 5.8 x 5.8 x 4cm	100ml / 12 Decos



PAVONI Silicone Pastry Mould, Pavalex

Product Code	Dimension	Capacity
05-003-00713	40 x 30cm Ø6.1 x H5cm	100ml / 12 Moons



PAVONI Silicone Pastry Mould, Pavalex

Product Code	Dimension	Capacity
05-003-00714	40 x 30cm 6.9 x 6.8 x 5.2cm	100ml / 12 Naturals



PAVONI Silicone Pastry Mould, Pavalex

Product Code	Dimension	Capacity
05-003-00715	40 x 30cm Øvaried x H1.8 / 2cm	18ml / 30 Zens



PAVONI Silicone Pastry Mould, Pavalex

Product Code	Dimension	Capacity
05-003-00716	40 x 30cm 4 x 3 x 2cm	18ml / 30 Passions

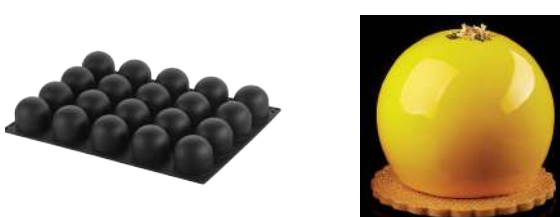

PAVONI Silicone Pastry Mould, Pavalex

Product Code	Dimension	Capacity
05-003-00717	40 x 30cm Ø6cm	110ml / 20 Sferes

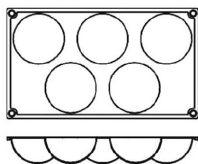

PAVONI Silicone Modular Mould, Formaflex

Product Code	Dimension	Capacity
05-003-00729	30 x 17.5cm Ø8 x H4cm	5 Hemispheres

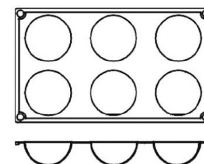

PAVONI Silicone Modular Mould, Formaflex

Product Code	Dimension	Capacity
05-003-00730	30 x 17.5cm Ø7 x H3.5cm	6 Hemispheres

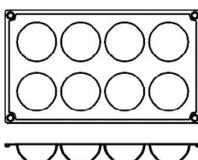

PAVONI Silicone Modular Mould, Formaflex

Product Code	Dimension	Capacity
05-003-00731	30 x 17.5cm Ø6 x H3cm	8 Hemispheres

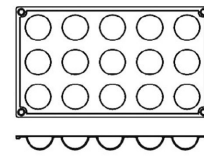

PAVONI Silicone Modular Mould, Formaflex

Product Code	Dimension	Capacity
05-003-00732	30 x 17.5cm Ø4 x H2cm	15 Mini Hemispheres

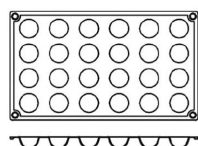

PAVONI Silicone Modular Mould, Formaflex

Product Code	Dimension	Capacity
05-003-00733	30 x 17.5cm Ø3 x H1.7cm	24 Mini Hemispheres

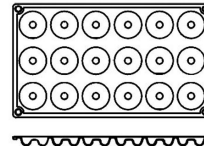

PAVONI Silicone Modular Mould, Formaflex

Product Code	Dimension	Capacity
05-003-00734	30 x 17.5cm Ø4.1 x H1.2cm	18 Mini Savarins

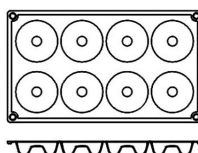

PAVONI Silicone Modular Mould, Formaflex

Product Code	Dimension	Capacity
05-003-00735	30 x 17.5cm Ø6.5 x H2.1cm	8 Savarins

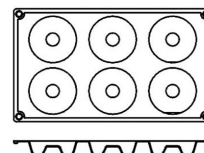

PAVONI Silicone Modular Mould, Formaflex

Product Code	Dimension	Capacity
05-003-00736	30 x 17.5cm Ø7.2 x H2.3cm	6 Savarins

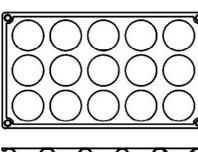

PAVONI Silicone Modular Mould, Formaflex

Product Code	Dimension	Capacity
05-003-00737	30 x 17.5cm Ø4.5 x H1cm	15 Mini Tartellettas

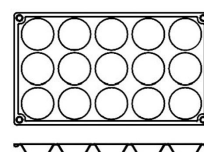

PAVONI Silicone Modular Mould, Formaflex

Product Code	Dimension	Capacity
05-003-00738	30 x 17.5cm Ø5 x H1.5cm	15 Mini Tartellettas

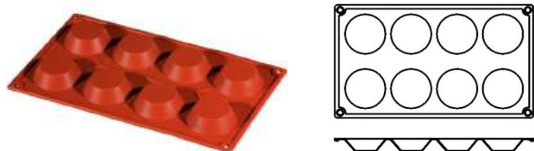

PAVONI Silicone Modular Mould, Formaflex

Product Code	Dimension	Capacity
05-003-00739	30 x 17.5cm Ø6 x H1.7cm	8 Tartellettas

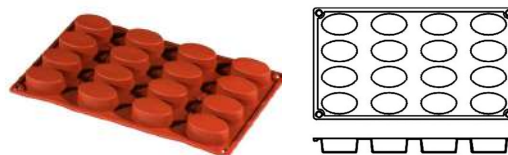

PAVONI Silicone Modular Mould, Formaflex

Product Code	Dimension	Capacity
05-003-00740	30 x 17.5cm 5.5 x 3.3 x 2cm	16 Mini Ovals

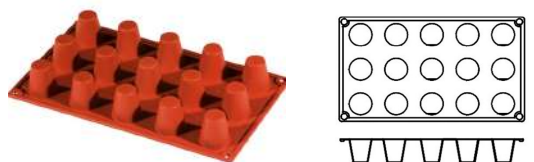

PAVONI Silicone Modular Mould, Formaflex

Product Code	Dimension	Capacity
05-003-00741	30 x 17.5cm Ø3.5 x H3.8cm	15 Mini Cylinders

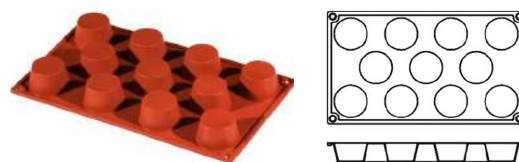

PAVONI Silicone Modular Mould, Formaflex

Product Code	Dimension	Capacity
05-003-00742	30 x 17.5cm Ø5 x H2.8cm	11 Muffins

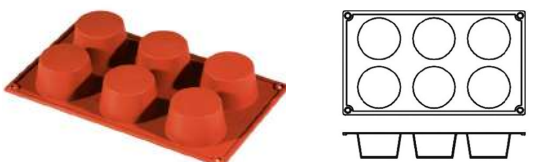

PAVONI Silicone Modular Mould, Formaflex

Product Code	Dimension	Capacity
05-003-00743	30 x 17.5cm Ø7 x H4cm	6 Muffins

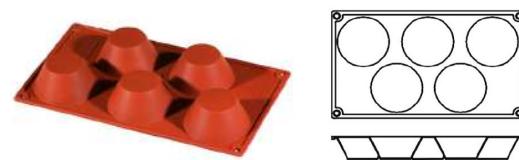

PAVONI Silicone Modular Mould, Formaflex

Product Code	Dimension	Capacity
05-003-00744	30 x 17.5cm Ø8 x H3.5cm	5 Muffins

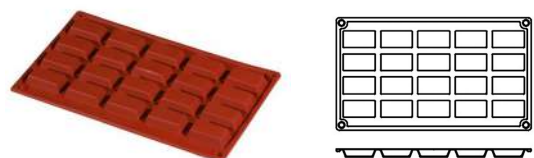

PAVONI Silicone Modular Mould, Formaflex

Product Code	Dimension	Capacity
05-003-00745	30 x 17.5cm 4.9 x 2.6 x 1.1cm	20 Financiers



PAVONI Silicone Modular Mould, Formaflex

Product Code	Dimension	Capacity
05-003-00746	30 x 17.5cm 8 x 3 x 3cm	9 Cakes



PAVONI Silicone Modular Mould, Formaflex

Product Code	Dimension	Capacity
05-003-00747	30 x 17.5cm Ø4 x H2cm	15 Cylinders



PAVONI Silicone Modular Mould, Formaflex

Product Code	Dimension	Capacity
05-003-00748	30 x 17.5cm 4.2 x 3 x 1.15cm	20 Madeleines

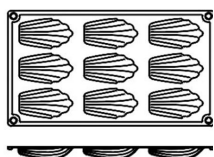

PAVONI Silicone Modular Mould, Formaflex

Product Code	Dimension	Capacity
05-003-00749	30 x 17.5cm 6.8 x 4.5 x 1.8cm	9 Madeleines

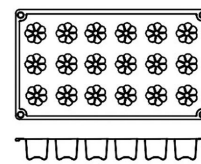

PAVONI Silicone Modular Mould, Formaflex

Product Code	Dimension	Capacity
05-003-00750	30 x 17.5cm Ø3.5 x H3.5cm	18 Mini Borderlais

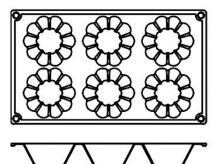

PAVONI Silicone Modular Mould, Formaflex

Product Code	Dimension	Capacity
05-003-00751	30 x 17.5cm Ø7.9 x H3.7cm	6 Briochettes

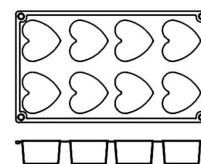

PAVONI Silicone Modular Mould, Formaflex

Product Code	Dimension	Capacity
05-003-00752	30 x 17.5cm 6.5 x 6 x 3.5cm	8 Hearts

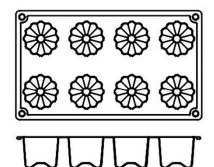

PAVONI Silicone Modular Mould, Formaflex

Product Code	Dimension	Capacity
05-003-00753	30 x 17.5cm Ø5.6 x H5cm	8 Bordelais

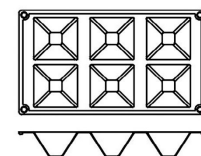

PAVONI Silicone Modular Mould, Formaflex

Product Code	Dimension	Capacity
05-003-00762	30 x 17.5cm 7.1 x 7.1 x 4cm	92ml / 6 Pyramids

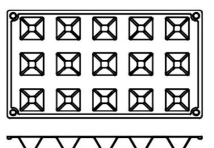

PAVONI Silicone Modular Mould, Formaflex

Product Code	Dimension	Capacity
05-003-00763	30 x 17.5cm 3.6 x 3.6 x 2.2cm	13ml / 15 Pyramids

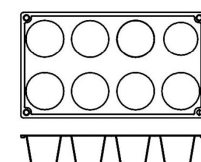

PAVONI Silicone Modular Mould, Formaflex

Product Code	Dimension	Capacity
05-003-00764	30 x 17.5cm Ø5.5 x H6cm	97ml / 8 Big Babas

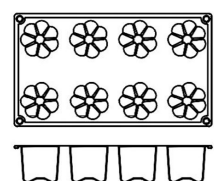

PAVONI Silicone Modular Mould, Formaflex

Product Code	Dimension	Capacity
05-003-00765	30 x 17.5cm Ø5.7 x H5.7cm	110ml / 8 Balvarians

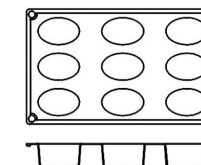

PAVONI Silicone Modular Mould, Formaflex

Product Code	Dimension	Capacity
05-003-00766	30 x 17.5cm 6.5 x 4.1 x 3.4cm	52ml / 9 Ovals

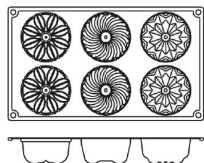

PAVONI Silicone Modular Mould, Formaflex

Product Code	Dimension	Capacity
05-003-00801	30 x 17.5cm Ø7.5 x H3.8cm	6 Fantasies

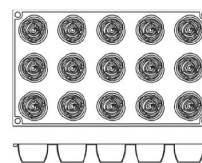
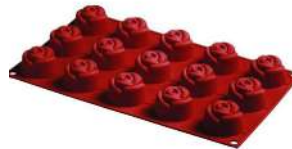

PAVONI Silicone Modular Mould, Formaflex

Product Code	Dimension	Capacity
05-003-00803	30 x 17.5cm Ø4.3 x H2.6cm	15 Rose Mignons

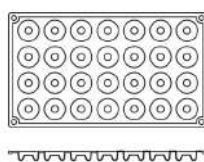

PAVONI Silicone Pastry Mould, Formaflex

Product Code	Dimension	Capacity
05-003-00808	Ø3 x H1.35cm	7.5ml / 28 Micro Savarin Tondos

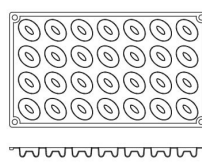

PAVONI Silicone Pastry Mould, Formaflex

Product Code	Dimension	Capacity
05-001-00324	3.5 x 2.5 x 1.35cm	7.5ml / 28 Savarin Ovals

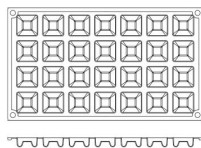

PAVONI Silicone Pastry Mould, Formaflex

Product Code	Dimension	Capacity
05-001-00325	3 x 3 x 1.35cm	9.5ml / 28 Micro Savarin Quadrato



PAVONI Electric Non-Stick Tart Shell Maker Machine

Product Code	Dimension	Capacity
05-003-00809	53 x 44 x 38cm Weight: 22kg	220-240V / 3200W

*Contact us for more information on the accessories



SOLIA PS Round Pastry Disc with Handle, Clear

Product Code	Dimension	Capacity
15-001-00026	Ø7.8 x H2cm	100pcs/pkt, 10pkts/ctn



SOLIA PS Round Pastry Disc with Handle, Black

Product Code	Dimension	Capacity
15-001-00027	Ø7.8 x H2cm	100pcs/pkt, 10pkts/ctn



SOLIA PS Round Pastry Disc with Handle, Silver

Product Code	Dimension	Capacity
15-001-00028	Ø7.8 x H2cm	100pcs/pkt, 10pkts/ctn



SOLIA PS Square Pastry Disc with Handle, Clear

Product Code	Dimension	Capacity
15-001-00029	8 x 8 x 2cm	100pcs/pkt, 10pkts/ctn



SOLIA PS Square Pastry Disc with Handle, Black

Product Code	Dimension	Capacity
15-001-00030	8 x 8 x 2cm	100pcs/pkt, 10pkts/ctn



SOLIA PS Square Pastry Disc with Handle, Silver

Product Code	Dimension	Capacity
15-001-00031	8 x 8 x 2cm	100pcs/pkt, 10pkts/ctn



SOLIA PS Rectangle Pastry Disc with Handle, Clear

Product Code	Dimension	Capacity
15-001-00032	10 x 5.5 x 2cm	100pcs/pkt, 10pkts/ctn



SOLIA PS Rectangle Pastry Disc with Handle, Black

Product Code	Dimension	Capacity
15-001-00033	10 x 5.5 x 2cm	100pcs/pkt, 10pkts/ctn



SOLIA PS Rectangle Pastry Disc with Handle, Silver

Product Code	Dimension	Capacity
15-001-00034	10 x 5.5 x 2cm	100pcs/pkt, 10pkts/ctn



PAVONI FLYCHOC Stainless Steel Leaf Tool

Product Code	Dimension	Size
05-001-00286	5 x 3.6cm	Large
05-001-00287	6 x 4.4cm	Large
05-001-00288	6 x 3cm	Medium
05-001-00289	8 x 4cm	Large



PAVONI FLYCHOC Stainless Steel Plume Tool

Product Code	Dimension	Size
05-001-00290	8 x 2.3cm	Medium
05-001-00291	10 x 2.4cm	Large



DE BUYER Silicone Round Mini Mould

Product Code	Dimension	Capacity
05-003-00368	Ø10 x H2cm	0.1l



PAVONI Silicone Round Tart Mould

Product Code	Dimension	Capacity
05-003-00768	Ø24 x H3cm	1250ml
05-003-00769	Ø28 x H3cm	1700ml



PAVONI Silicone Round Cake Mould

Product Code	Dimension	Capacity
05-003-00754	Ø20 x H4cm	1150ml
05-003-00806	Ø22 x H4cm	1400ml
05-003-00755	Ø24 x H4.2cm	1850ml
05-003-00756	Ø26 x H4.5cm	2250ml
05-003-00767	Ø28 x H4.5cm	2600ml



PAVONI Silicone Kouglopf Mould

Product Code	Dimension	Capacity
05-003-00757	Ø24 x H6cm	1685ml
05-003-00758	Ø22 x H11cm	2750ml



PAVONI Silicone Rectangle Mould

Product Code	Dimension	Capacity
05-003-00759	28 x 24 x 4cm	2670ml



PAVONI Silicone Rectangle Loaf Mould

Product Code	Dimension	Capacity
05-003-00760	24 x 10.5 x 6.5cm	1385ml
05-003-00761	28 x 10.5 x 6.5cm	1660ml



Stainless Steel Cannoli Mould

Product Code	Dimension
05-003-00385	Ø1.5 x 10cm
05-003-00386	Ø2.5 x 10cm
05-003-00387	Ø3.5 x 12.5cm



Stainless Steel Cannoli Mould

Product Code	Dimension
05-003-00390	Ø4.5 x H4cm
05-003-00391	Ø5.5 x H5cm
05-003-00392	Ø6.5 x H6cm



Stainless Steel Cream Horn Oblique

Product Code	Dimension
05-003-00388	Ø3.5 x 13cm
05-003-00389	Ø4 x 16cm



Stainless Steel Pyramide Mould

Product Code	Dimension
05-003-00400	6 x 4cm
05-003-00401	9 x 6cm
05-003-00402	12 x 8cm
05-003-00403	15 x 10cm



Stainless Steel Half Sphere

Product Code	Dimension
05-003-00393	Ø4cm
05-003-00394	Ø6cm
05-003-00395	Ø8cm
05-003-00396	Ø10cm
05-003-00397	Ø12cm
05-003-00398	Ø14cm
05-003-00399	Ø16cm



PLC Fish Shape Mould

Product Code	Dimension	Type
05-003-00416	20cm	Double Fish
05-003-00417	26cm	Single Fish



GOBEL Stainless Steel Heavy Cake Frame

Product Code	Dimension
05-003-00438	50.9 x 30.7 x 4.5cm
05-003-00439	56.5 x 36.5 x 4.5cm
05-003-00440	50.9 x 30.7 x 3.5cm
05-003-00441	56.5 x 36.5 x 3.5cm
05-003-00442	56.5 x 36.5 x 2.5cm

Stainless Steel Round Long Mould

Product Code	Dimension
05-003-00404	50 x 5 x 3.7cm
05-003-00405	50 x 6 x 4.5cm
05-003-00406	50 x 7 x 5cm
05-003-00407	50 x 8 x 6.2cm



GOBEL Stainless Steel Round Pastry Ring

Product Code	Dimension
05-003-00427	Ø14 x H3.5cm
05-003-00428	Ø16 x H3.5cm
05-003-00429	Ø18 x H3.5cm
05-003-00430	Ø20 x H3.5cm
05-003-00431	Ø22 x H3.5cm
05-003-00432	Ø24 x H3.5cm
05-003-00433	Ø26 x H3.5cm
05-003-00434	Ø28 x H3.5cm
05-003-00435	Ø30 x H3.5cm



DE BUYER Stainless Steel Pusher for Pastry Rings

Product Code	Dimension
05-003-00443	7 x 6 x 10cm



DE BUYER Stainless Steel Expandable Round Pastry Ring

Product Code	Dimension
05-003-00448	Ø18-36 x H4.5cm



DE BUYER *Stainless Steel Straight Tear-Drop Pastry Ring*

Product Code	Dimension
05-003-00444	8 x 5 x 4cm
05-003-00445	20 x 12 x 4cm
05-003-00446	23 x 14.5 x 4cm
05-003-00447	26 x 16 x 4cm



DE BUYER *Stainless Steel Heart-Shaped Pastry Ring*

Product Code	Dimension
05-003-00449	Ø6 x H4.5cm
05-003-00450	Ø14 x H4cm
05-003-00451	Ø16 x H4cm
05-003-00452	Ø18 x H4cm



DE BUYER *Stainless Steel Round Pastry Ring*

Product Code	Dimension
05-003-00453	Ø3.25 x H2cm
05-003-00454	Ø4.5 x H2.5cm



DE BUYER *Stainless Steel Square Pastry Ring with Round Angles*

Product Code	Dimension
05-003-00456	6 x 6 x 4cm



MATFER *Stainless Steel Entremets Frame*

Product Code	Dimension
05-003-00570	17 x 17 x 3.5cm

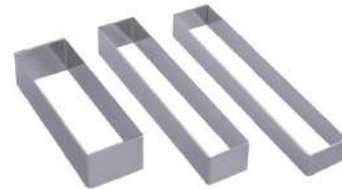

DE BUYER *Stainless Steel Rectangle Pastry Ring*

Product Code	Dimension
05-003-00457	12.4 x 4.3 x 3cm
05-003-00458	16.4 x 3.2 x 2.5cm



Stainless Steel Heart Dessert Ring

Product Code	Dimension
05-003-00476	Ø16 x H5cm
05-003-00477	Ø18 x H5cm
05-003-00478	Ø20 x H5cm



Stainless Steel Tear Drop Dessert Ring

Product Code	Dimension
05-003-00479	16 x 5cm
05-003-00480	18 x 5cm
05-003-00481	20 x 5cm



Stainless Steel Convex Triangle Dessert Ring

Product Code	Dimension
05-003-00482	16 x 5cm
05-003-00483	18 x 5cm
05-003-00484	20 x 5cm



Stainless Steel Convex Square Dessert Ring

Product Code	Dimension
05-003-00485	14 x 5cm
05-003-00486	16 x 5cm
05-003-00487	18 x 5cm



05-003-00488



05-003-00489



05-003-00490



05-003-00491



05-003-00492



05-003-00493



05-003-00494



05-003-00495



05-003-00496



05-003-00497



05-003-00498



05-003-00499



05-003-00500



05-003-00501



05-003-00502

Stainless Steel Mini Dessert Ring

Product Code	Dimension	Type
05-003-00488	Ø7 x H4.5cm	Round
05-003-00489	7 x 4.5cm	Oval
05-003-00490	7 x 4.5cm	Heart
05-003-00491	7 x 4.5cm	Teardrop
05-003-00492	7 x 4.5cm	Coma
05-003-00493	7 x 4.5cm	Hexagon
05-003-00494	7 x 4.5cm	Convex Square
05-003-00495	7 x 4.5cm	Convex Triangle

Product Code	Dimension	Type
05-003-00496	5.5 x 4.5cm	Square
05-003-00497	7 x 4.5cm	Triangle
05-003-00498	7 x 4.5cm	Five Star
05-003-00499	7 x 4.5cm	Blossom
05-003-00500	7 x 4.5cm	3 Blossom
05-003-00501	7 x 4.5cm	American Football
05-003-00502	7 x 4.5cm	Lipstick



GOBEL Stainless Steel Small Convex Pastry Ring

Product Code	Dimension	Type
05-003-00436	5 x 5 x 3cm	Square
05-003-00437	6 x 6 x 3cm	Triangle



Stainless Steel Rectangle Pastry Frame

Product Code	Dimension
05-003-00541	57 x 9 x 4cm



Stainless Steel Rectangle Dessert Frame

Product Code	Dimension
05-003-00540	58 x 38 x 5cm





Stainless Steel Short Tart Ring

Product Code	Dimension
05-003-00459	Ø8 x H2cm
05-003-00460	Ø10 x H2cm
05-003-00461	Ø12 x H2cm
05-003-00462	Ø14 x H2cm
05-003-00463	Ø16 x H2cm
05-003-00464	Ø18 x H2cm
05-003-00465	Ø20 x H2cm
05-003-00466	Ø22 x H2cm
05-003-00467	Ø24 x H2cm
05-003-00468	Ø26 x H2cm
05-003-00469	Ø28 x H2cm
05-003-00470	Ø30 x H2cm
05-003-00471	Ø32 x H2cm
05-003-00472	Ø34 x H2cm



Stainless Steel Round Dessert Ring

Height	Product Code	Dimension
Height 3cm	05-003-00545	Ø8 x H3cm
	05-003-00547	Ø10 x H3cm
	05-003-00549	Ø12 x H3cm
	05-003-00552	Ø14 x H3cm
Height 4cm	05-003-00543	Ø6 x H4cm
	05-003-00544	Ø6 x H4.5cm
	05-003-00546	Ø8 x H4.5cm
	05-003-00548	Ø10 x H4.5cm
	05-003-00550	Ø12 x H4.5cm
	05-003-00553	Ø14 x H4.5cm
	05-003-00555	Ø16 x H4.5cm
	05-003-00557	Ø18 x H4.5cm
	05-003-00559	Ø20 x H4.5cm
	05-003-00561	Ø22 x H4.5cm
Height 4.5cm	05-003-00563	Ø24 x H4.5cm
	05-003-00565	Ø26 x H4.5cm
	05-003-00567	Ø28 x H4.5cm
	05-003-00551	Ø12 x H6cm
	05-003-00554	Ø14 x H6cm
	05-003-00556	Ø16 x H6cm
	05-003-00558	Ø18 x H6cm
	05-003-00560	Ø20 x H6cm
	05-003-00562	Ø22 x H6cm
	05-003-00564	Ø24 x H6cm
	05-003-00566	Ø26 x H6cm
	05-003-00568	Ø28 x H6cm
	05-003-00569	Ø30 x H6cm



Stainless Steel Round Dessert Ring

Height	Product Code	Dimension
Height 4cm	05-003-00505	Ø14 x H4cm
	05-003-00507	Ø16 x H4cm
	05-003-00508	Ø18 x H4cm
	05-003-00509	Ø20 x H4cm
	05-003-00510	Ø22 x H4cm
	05-003-00512	Ø24 x H4cm
Height 5cm	05-003-00514	Ø26 x H4cm
	05-003-00503	Ø10 x H5cm
	05-003-00504	Ø12 x H5cm
	05-003-00506	Ø14 x H5cm
	05-003-00473	Ø16 x H5cm
	05-003-00474	Ø18 x H5cm
	05-003-00475	Ø20 x H5cm
	05-003-00511	Ø22 x H5cm
	05-003-00513	Ø24 x H5cm
	05-003-00515	Ø26 x H5cm
	05-003-00516	Ø28 x H5cm
05-003-00517	Ø30 x H5cm	



Stainless Steel Square Dessert Ring

Product Code	Dimension
05-003-00518	10 x 4cm
05-003-00519	12 x 4cm
05-003-00520	14 x 4cm
05-003-00521	16 x 4cm
05-003-00522	18 x 4cm
05-003-00523	20 x 4cm
05-003-00524	22 x 4cm
05-003-00525	24 x 4cm
05-003-00526	26 x 4cm
05-003-00527	28 x 4cm
05-003-00528	30 x 4cm



Stainless Steel Rectangle Dessert Ring

Product Code	Dimension
05-003-00529	24 x 14 x 4cm
05-003-00530	26 x 16 x 4cm
05-003-00531	28 x 18 x 4cm
05-003-00532	30 x 22 x 4cm
05-003-00533	38 x 26 x 4cm
05-003-00534	40 x 30 x 4cm



LACOR Stainless Steel Perforated Cake Ring

Product Code	Dimension
05-003-00669	Ø16 x 2cm
05-003-00670	Ø18 x 2cm
05-003-00671	Ø20 x 2cm
05-003-00672	Ø24 x 2cm
05-003-00673	Ø16 x 3.5cm
05-003-00674	Ø18 x 3.5cm
05-003-00675	Ø20 x 3.5cm
05-003-00676	Ø24 x 3.5cm



LACOR Stainless Steel Perforated Square Cake Ring

Product Code	Dimension
05-003-00677	16 x 16 x 2cm
05-003-00679	16 x 16 x 3.5cm
05-003-00678	20 x 20 x 2cm
05-003-00680	20 x 20 x 3.5cm



LACOR Stainless Steel Perforated Rectangular Ring

Product Code	Dimension
05-003-00685	20 x 7 x 2cm
05-003-00686	20 x 7 x 3.5cm
05-003-00688	28 x 8 x 2cm
05-003-00687	28 x 8 x 3.5cm



PLC Cutting Roller

Product Code	Dimension
05-003-00574	6.8cm
05-003-00575	17.5cm



Doughnut Cutter

Product Code	Dimension
05-003-00591	Ø8cm



Stainless Steel Expandable Cake Ring

Product Code	Dimension
05-003-00535	21.5 x 11.5 x 7.5cm to 40.5 x 20 x 7.5cm
05-003-00536	21 x 15.2 x 6cm to 39.4 x 27.3 x 6cm
05-003-00537	30 x 30 x 5cm to 56 x 56 x 5cm
05-003-00538	34.2 x 24 x 5cm to 66.7 x 46 x 5cm
05-003-00539	43 x 29 x 5cm to 85 x 55 x 5cm

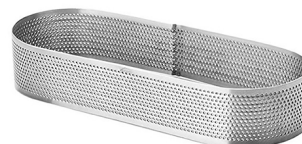

LACOR Stainless Steel Perforated Oval Cake Ring

Product Code	Dimension
05-003-00681	7 x 20 x 2cm
05-003-00682	7 x 20 x 3.5cm
05-003-00684	28 x 8 x 2cm
05-003-00683	28 x 8 x 3.5cm



Stainless Steel Small Oblong Ring

Product Code	Dimension
05-003-00542	8.8 x 5.2 x 4.5cm



SCHNEIDER Pastry Spray Gun Type "Alexo 500"

Product Code	Capacity	Elec. Spec.
05-003-00573	500ml	40W



Expandable 5-Wheels Serrated Dough Cutter

Product Code	Dimension
05-003-00576	17 x 17 x 3.5cm



SCHNEIDER Stainless Steel Single Croissant Cutter with PLC Handle

Product Code	Dimension
05-003-00619	A11cm H15cm



05-003-00616



05-003-00617



05-003-00618



05-003-00637



05-003-00638



05-003-00639



05-003-00640



05-003-00641

Stainless Steel Pastry Cutter Set

Product Code	Dimension	Packaging	Type
05-003-00616	Ø3.8 to 9.2cm	8pcs/set	Fluted Heart
05-003-00617	Ø3 to 9.6cm	12pcs/set	Round Fluted
05-003-00618	Ø3 to 9.6cm	12pcs/set	Round Plain

CCK Stainless Steel Pastry Cutter Set

Product Code	Dimension	Packaging	Type
05-003-00637	Ø4 to 11.3cm	6 pieces	Flower
05-003-00638	Ø2.5 to 10cm	12 pieces	Heart
05-003-00639	Ø2.5 to 10cm	8 pieces	Round Fluted
05-003-00640	Ø2 to 10cm	14 pieces	Round Plain
05-003-00641	Ø3.5 to 11.8cm	6 pieces	Star

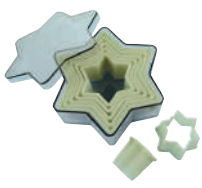

05-003-00621



05-003-00622



05-003-00623



05-003-00624



05-003-00625



05-003-00626



05-003-00627



05-003-00628

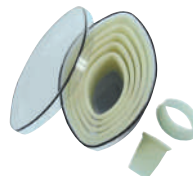

05-003-00629



05-003-00630



05-003-00631



05-003-00632



05-003-00633



05-003-00634

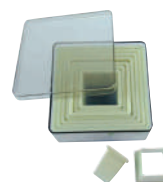

05-003-00635



05-003-00636

DE BUYER Fibreglass Cutter Set

Product Code	Dimension	Packaging	Type
05-003-00621	Ø3 to 12cm	7pcs/set	6-Point Star
05-003-00622	Ø1.5 to 10cm	8pcs/set	Clover
05-003-00623	7 to 11cm	8pcs/set	Crescent
05-003-00624	Ø1.8 to 11.5cm	8pcs/set	Flower
05-003-00625	Ø2 to 10cm	8pcs/set	Fluted Flower
05-003-00626	1.5 to 9.5cm	7pcs/set	Heart
05-003-00627	1.5 to 9.5cm	7pcs/set	Fluted Heart
05-003-00628	Ø1.5 to 9cm	9pcs/set	Hexagon

Product Code	Dimension	Packaging	Type
05-003-00629	2 to 11cm	7pcs/set	Oval Boat
05-003-00630	2 to 11cm	7pcs/set	Fluted Oval Boat
05-003-00631	3.2 to 11cm	7pcs/set	Oval
05-003-00632	3.2 to 11cm	7pcs/set	Fluted Oval
05-003-00633	Ø2 to 10cm	9pcs/set	Round
05-003-00634	Ø2 to 10cm	9pcs/set	Fluted Round
05-003-00635	1.8 to 9.5cm	9pcs/set	Square
05-003-00636	2 to 12.5cm	8pcs/set	Tear Drop



Stainless Steel Mini Dessert Ring

Product Code	Dimension	Packaging	Type
05-003-00577	Ø3-8cm	6pcs/set	Round Plain
05-003-00578	Ø3-11cm	9pcs/set	Round Plain
05-003-00579	Ø3-8cm	6pcs/set	Round Fluted
05-003-00580	Ø3-11cm	9pcs/set	Round Fluted
05-003-00581	4 x 3cm - 9 x 7cm	6pcs/set	Oval Plain
05-003-00582	4 x 3cm - 12 x 10cm	9pcs/set	Oval Plain
05-003-00583	Ø3-11cm	6pcs/set	Heart
05-003-00584	Ø3-8cm	9pcs/set	Heart
05-003-00585	Ø4-10cm	6pcs/set	Star
05-003-00586	Ø2.5 x H2cm	40pcs/set	Alphabet & Number
05-003-00587	Ø2.5 x H2cm	26pcs/set	Alphabet
05-003-00588	Ø3.2-13 x 2cm	35pcs/set	Christmas
05-003-00589	Ø2.5-4 x H2cm	18pcs/set	Geometric
05-003-00590	Ø3 x H2cm	12pcs/set	Standard Shape
05-003-00592	Ø1.6 x H2cm	12pcs/set	Add. Extra Mini
05-003-00593	Ø2 x H2cm	12pcs/set	Extra Mini
05-003-00594	Ø4 x H2cm	20pcs/set	Flower
05-003-00595	Ø4 x H2cm	14pcs/set	Flower
05-003-00596	Ø3.4 x H5cm		Heart
05-003-00597	Ø3.5, 6, 8.5 x H2cm	3pcs/set	Heart
05-003-00598	Ø3.5, 6, 8.5 x H3.2cm	3pcs/set	Heart
05-003-00599	Ø2.5 x H2cm	10pcs/set	Heart

Product Code	Dimension	Packaging	Type
05-003-00600	3.5, 5.5, 8 x 2cm	3pcs/set	Hexagon
05-003-00601	3.5, 5.5, 8 x 3.2cm	3pcs/set	Hexagon
05-003-00602	Ø2.5 x H2cm	12pcs/set	Mini
05-003-00603	Ø3 x H2cm	12pcs/set	Small
05-003-00604	Ø2.5 x H2cm	16pcs/set	Number
05-003-00605	Ø3.5 x H2cm	9pcs/set	Number
05-003-00606	3.5 x 2.5 x 2cm 5.5 x 4.8 x 2cm 7.5 x 6.5cm x 2cm	3pcs/set	Oval
05-003-00607	3.5 x 2.5 x 3.2cm 5.5 x 4.8 x 3.2cm 7.5 x 6.5cm x 3.2cm	3pcs/set	Oval
05-003-00608	3.5 x 2.5 x 2cm 5.5 x 4.5 x 2cm 7.5 x 6.5cm x 2cm	3pcs/set	Rectangle
05-003-00609	3.5 x 2.5 x 3.2cm 5.5 x 4.5 x 3.2cm 7.5 x 6.5cm x 3.2cm	3pcs/set	Rectangle
05-003-00610	Ø3, 5, 7 x H2cm	3pcs/set	Round
05-003-00611	Ø3, 5, 7 x H3.2cm	3pcs/set	Round
05-003-00612	3, 5, 6.5 x H2cm	3pcs/set	Square
05-003-00613	3, 5, 6.5 x H3.2cm	3pcs/set	Square
05-003-00614	3.5, 6, 8.5 x H2cm	3pcs/set	Triangle
05-003-00615	3.5, 6, 8.5 x H3.2cm	3pcs/set	Triangle



Wire Wall Rack for Pastry Bag & Tubes

Product Code	Dimension
05-004-00021	50 x 48cm



LACOR Cookie Press & Icing Set

Product Code
05-004-00022



DE BUYER PC Pastry Tube Set

Product Code	Packaging	Type
05-004-00029	6pcs/set	Plain
05-004-00030	6pcs/set	Star
05-004-00031	6pcs/set	Assorted
05-004-00032	12pcs/set	Assorted
05-004-00033	24pcs/set	Assorted



SCHNEIDER Tritan Tubes Set

Product Code	Packaging	Type
05-004-00037	8pcs/set	Plain
05-004-00038	8pcs/set	Star ☆
05-004-00039	8pcs/set	Decorating
05-004-00040	8pcs/set	French Star ☆



PLC Assorted Pastry Tube

Product Code	Packaging	Type
05-004-00359	12pcs/set	Assorted



DE BUYER Piston Pastry Tube Syringe with 2 Nozzles & 13 Decor Discs

Product Code	Capacity
05-004-00028	0.75ℓ



SCHNEIDER Plastic Pastry Bag Holder Stand

Product Code	Dimension
05-004-00034	Ø19.5 x 23cm



SCHNEIDER Polypropylene Tubes Set

Product Code	Dimension	Capacity
05-004-00035	Ø3, 5, 7, 9, 11, 13mm	6 pieces/set
05-004-00036	Ø5, 7, 9, 11, 13, 15mm	6 pieces/set



SCHNEIDER Polycarbonate Decorating Tubes

Product Code	Packaging
05-004-00041	60 pieces/set
05-004-00042	23 pieces/set including 1 adaptor



SCHNEIDER Nylon Pastry Icing Bag

Product Code	Dimension
05-004-00043	25cm
05-004-00044	28cm
05-004-00045	34cm
05-004-00046	37cm
05-004-00047	40cm
05-004-00048	46cm
05-004-00049	50cm
05-004-00050	55cm
05-004-00051	60cm
05-004-00052	65cm
05-004-00053	70cm
05-004-00054	75cm



Nylon Pastry Icing Bag without Rim and Hook

Product Code	Dimension
05-004-00083	20cm
05-004-00084	25cm
05-004-00085	30cm
05-004-00086	35cm
05-004-00087	40cm
05-004-00088	45cm
05-004-00089	50cm
05-004-00090	55cm
05-004-00091	60cm



MARTELLATO Super Flex Pastry Bag

Product Code	Dimension
05-004-00062	34cm
05-004-00063	45cm
05-004-00064	50cm



DE BUYER Assorted Pastry Nozzles

Product Code	Packaging
05-004-00061	6pcs/box



DE BUYER Polyethylene Disposable Pastry Bags

Product Code	Dimension	Capacity
05-004-00023	30cm	100pcs/roll
05-004-00024	40cm	100pcs/roll
05-004-00025	45cm	100pcs/roll
05-004-00026	50cm	100pcs/roll
05-004-00027	55cm	100pcs/roll



SCHNEIDER Disposable Heat-Resistant Pastry Bags

Product Code	Dimension	Packaging
05-004-00055	35 x 19.5cm	100pcs/box
05-004-00056	47 x 23cm	100pcs/box
05-004-00057	53 x 27.5cm	100pcs/box
05-004-00058	60 x 30cm	100pcs/box



PAL PE Piping Bag

Product Code	Dimension	Packaging
05-004-00059	52cm	100pcs/box



Asst Icing Nozzles Set

Product Code	Packaging
05-004-00060	24pcs/set



SAFICO Stainless Steel Open Star Tube

Product Code	Dimension	Packaging
05-004-00070	Ø0.9cm	2pcs/set



SAFICO Stainless Steel Leaf Tube

Product Code	Dimension	Packaging
05-004-00065	0.1 x 0.6cm	2pcs/set
05-004-00066	0.2 x 1.3cm	2pcs/set



SAFICO Stainless Steel Petal Tube

Product Code	Dimension	Packaging
05-004-00067	0.25 x 1.2cm	2pcs/set
05-004-00068	0.3 x 1.8cm	2pcs/set
05-004-00069	0.45 x 2.4cm	2pcs/set



SAFICO Stainless Steel Bird Nest Tube

Product Code	Dimension
05-004-00071	8 Holes



SAFICO Cake Decor Set with 6 Tubes

Product Code	Packaging
05-004-00072	6pcs/set



SAFICO Stainless Steel Set of Decorating Pastry Tube with Std Coupling & Assorted Tubes

Product Code	Packaging
05-004-00076	Set of 29
05-004-00077	Set of 55



SAFICO Stainless Steel Drop Flower Tube

Product Code	Dimension	Packaging
05-004-00082	Ø2mm, 6mm, 6.5mm & 7mm	5pcs/set



SAFICO Stainless Steel Bismark Filling Tube

Product Code	Dimension	Packaging
05-004-00144	Ø4 & 8mm	2pcs/set



SAFICO Stainless Steel Plain Tube Set

Product Code	Dimension	Packaging
05-004-00093	Ø2, 3, 4, 6, 7, 8, 10, 11, 14, 15, 17 & 20mm	12pcs/set
05-004-00094	Ø2, 4, 7, 10, 11 & 15mm	6pcs/set

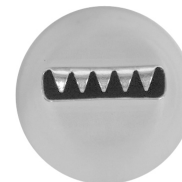

SAFICO Stainless Steel Star Ribbon Tube

Product Code	Dimension	Packaging
05-004-00078	12 x 3mm	2pcs/set
05-004-00079	16 x 2.2cm	2pcs/set
05-004-00080	20 x 3mm	2pcs/set
05-004-00081	26 x 3.5mm	2pcs/set



SAFICO Stainless Steel Plain Tube

Product Code	Dimension	Packaging
05-004-00107	Ø2mm	2pcs/set
05-004-00108	Ø3mm	2pcs/set
05-004-00109	Ø4mm	2pcs/set
05-004-00110	Ø5mm	2pcs/set
05-004-00111	Ø6mm	2pcs/set
05-004-00112	Ø7mm	2pcs/set
05-004-00113	Ø8mm	2pcs/set
05-004-00114	Ø9mm	2pcs/set
05-004-00115	Ø10mm	2pcs/set
05-004-00116	Ø11mm	2pcs/set
05-004-00117	Ø12mm	2pcs/set
05-004-00118	Ø13mm	2pcs/set
05-004-00119	Ø14mm	2pcs/set
05-004-00120	Ø15mm	2pcs/set
05-004-00121	Ø16mm	2pcs/set
05-004-00122	Ø17mm	2pcs/set
05-004-00123	Ø18mm	2pcs/set
05-004-00124	Ø20mm	2pcs/set
05-004-00125	Ø22mm	2pcs/set
05-004-00126	Ø24mm	2pcs/set



SAFICO Stainless Steel Star Tube Set

Product Code	Dimension	Packaging
05-004-00145	Ø4, 6, 7, 10, 12 & 14mm	6pcs/set
05-004-00146	Ø3, 4, 6, 7, 9, 10, 12, 13, 14, 16 & 18mm	12pcs/set



SAFICO Stainless Steel Plain Tube

Product Code	Dimension	Packaging
05-004-00127	Ø2mm	2pcs/set
05-004-00128	Ø3mm	2pcs/set
05-004-00129	Ø4mm	2pcs/set
05-004-00130	Ø5mm	2pcs/set
05-004-00131	Ø6mm	2pcs/set
05-004-00132	Ø7mm	2pcs/set
05-004-00133	Ø8mm	2pcs/set
05-004-00134	Ø9mm	2pcs/set
05-004-00135	Ø10mm	2pcs/set
05-004-00136	Ø11mm	2pcs/set
05-004-00137	Ø12mm	2pcs/set
05-004-00138	Ø13mm	2pcs/set
05-004-00139	Ø14mm	2pcs/set
05-004-00140	Ø15mm	2pcs/set
05-004-00141	Ø16mm	2pcs/set
05-004-00142	Ø17mm	2pcs/set
05-004-00143	Ø18mm	2pcs/set

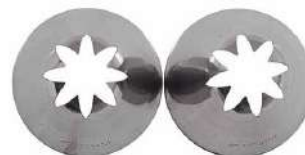

SAFICO Stainless Steel Close Star Tube

Product Code	Dimension	Packaging
05-004-00095	Ø2mm	2pcs/set
05-004-00096	Ø4mm	2pcs/set
05-004-00097	Ø6mm	2pcs/set
05-004-00098	Ø8mm	2pcs/set
05-004-00099	Ø10mm	2pcs/set
05-004-00100	Ø12mm	2pcs/set
05-004-00101	Ø15mm	2pcs/set



SAFICO Stainless Steel French Star Tube

Product Code	Dimension	Packaging
05-004-00102	Ø7mm	2pcs/set
05-004-00103	Ø9mm	2pcs/set
05-004-00104	Ø10mm	2pcs/set
05-004-00105	Ø15mm	2pcs/set
05-004-00106	Ø18mm	2pcs/set



MARTELLATO Mini Compressor for Air Brush

Product Code	Dimension	
05-004-00350	0.2mm nozzle	1.5 Bar



MARTELLATO Compressor for Air Brush

Product Code	Capacity	Elec. Spec.	
05-004-00351	11l/min	230V / 50Hz / 170W	4 bar

MARTELLATO Double Action Air Brush

Product Code	Dimension	Capacity
05-004-00353	0.3mm nozzle	7cc

MARTELLATO Stainless Steel Air Brush Holder

Product Code
05-004-00355

SCHNEIDER Pastry Spray Gun "Alexo 200"

Product Code	Capacity	Elec. Spec.
05-001-00252	Dispense Quantity: 280g/min Volume: 700m ^l Pressure: 0-160bar	230V / 50Hz / 60W

SCHNEIDER Rd Jet Nozzle for Spray Gun "Alexo 200"

Product Code	Type
05-001-00312	Nozzle R4
05-001-00313	Nozzle R6
05-001-00314	Nozzle R8

SCHNEIDER Flat Ray Nozzle F7S for Spray Gun "Alexo 200"

Product Code
05-001-00315

SCHNEIDER Cleaning Nozzle for Spray Gun "Alexo 200"

Product Code
05-001-00316

SCHNEIDER Bent Nozzle Extension for Spray Gun "Alexo 200"

Product Code
05-001-00317

SCHNEIDER Container (Excludes Lid) for Spray Gun "Alexo 200"

Product Code	Capacity
05-001-00318	700m ^l

SCHNEIDER Spin with Spring for Spray Gun "Alexo 200"

Product Code
05-001-00319

SCHNEIDER Pastry Spray Gun Type "Alexo 500"

Product Code	Capacity	Elec. Spec.
05-003-00573	550m ^l	40W



SCHNEIDER Plastic Pressure Sprayer

Product Code	Dimension	Capacity
05-001-00253	Ø14 x 28cm	1.6l



DE BUYER Stainless Steel Caramelizing Iron "Soudogaz X2000"

Product Code	Dimension
05-004-00356	33 x 11.5 x 23..5cm



SCHNEIDER Plastic Round Bread Proofing Basket

Product Code	Dimension	Capacity	Colour
05-005-00007	Ø19cm	500g	Green
05-005-00008	Ø22cm	1000g	Orange
05-005-00009	Ø25cm	1500g	Blue



SCHNEIDER Plastic Rectangle Bread Proofing Basket

Product Code	Dimension	Capacity	Colour
05-005-00010	27 x 12cm	500g	Green
05-005-00011	35 x 13cm	1000g	Orange
05-005-00012	42 x 14cm	1500g	Blue



SCHNEIDER Cotton Liner for Bread Proofing Basket

Product Code	Dimension	Type
05-005-00001	27 x 12cm	Rectangle
05-005-00002	35 x 13cm	Rectangle
05-005-00003	42 x 4cm	Rectangle
05-005-00004	Ø19mm	Round
05-005-00005	Ø22mm	Round
05-005-00006	Ø25mm	Round



SCHNEIDER Wooden Round Bread Proofing Basket

Product Code	Dimension	Capacity
05-005-00013	Ø19mm	500g
05-005-00014	Ø22mm	1000g
05-005-00015	Ø25mm	1500g
05-005-00016	Ø29mm	2000g



SCHNEIDER Wooden Oval Bread Proofing Basket

Product Code	Dimension	Capacity
05-005-00017	24 x 14cm	500g
05-005-00018	26 x 16cm	1000g
05-005-00019	32 x 18cm	1500g
05-005-00020	36 x 20cm	2000g



SCHNEIDER Wooden Round Long Bread Proofing Basket

Product Code	Dimension	Capacity
05-005-00021	24 x 13cm	500g
05-005-00022	34 x 13cm	1000g
05-005-00023	43 x 13cm	1500g
05-005-00024	46 x 15cm	2000g



SCHNEIDER *Wooden Rectangle Angled-Shape Bread Proofing Basket*

Product Code	Dimension	Capacity
05-005-00025	32 x 13cm	1000g
05-005-00026	36 x 13cm	1250g
05-005-00027	36 x 14cm	1500g
05-005-00028	44 x 14cm	2000g



SCHNEIDER *Wooden Triangle Bread Proofing Basket*

Product Code	Dimension	Capacity
05-005-00029	23 x 23 x 8cm	1000g



Aluminium Bread Pan

Product Code	Dimension
05-005-00040	19.7 x 10.6 x 11cm
05-005-00041	31.6 x 11 x 11.6cm
05-005-00042	32.7 x 10.6 x 12.2cm
05-005-00043	32.7 x 12.1 x 12.1cm
05-005-00044	37 x 12 x 12.5cm



GOBEL *Non-Stick Rectangle Bread Pan with Lid*

Product Code	Dimension
05-005-00032	40 x 10.5 x 9cm
05-005-00033	25 x 9.3 x 7.6cm



MATFER *Large Covered Bread Exopan*

Product Code	Dimension
05-005-00045	40cm



GOBEL *Non-Stick Round Bread Mould*

Product Code	Dimension
05-005-00030	Ø23 x H6cm
05-005-00031	Ø27 x H6cm



GOBEL *Non-Stick Rectangle Folding Cake Mould*

Product Code	Dimension
05-005-00034	24 x 9.5 x 7cm
05-005-00035	27 x 10 x 7.5cm



GOBEL *Non-Stick Rectangle Folding Bread Pan*

Product Code	Dimension
05-005-00036	30 x 10 x 7.5cm



SCHNEIDER *Horse Hair Bristles Flour Brush with Wooden Handle*

Product Code	Dimension
05-005-00046	30cm



05-006-00129



05-006-00130



05-006-00131



05-006-00132



05-006-00133

Analogue Chocolate Dry Melting Container 1/2 Size

Product Code	Dimension	Capacity
05-006-00129	40 x 33 x 13.5cm	6ℓ
05-006-00130	40 x 24 x 13.5cm	3.6ℓ
05-006-00131(XX)	45 x 39 x 13.5cm	9ℓ
05-006-00132(XX)	62 x 39.5 x 13.5cm	13.7ℓ
05-006-00133(XX)	79 x 29 x 13.5cm	4 x 1.5ℓ



LACOR Semi-Professional Chocolate Bain Marie

Product Code	Dimension	Capacity	Elec. Spec.
05-006-00128	29 x 22 x 12cm	1ℓ	230V / 50Hz / 70W



Chocolate Fountain with Removable Basin

Product Code	Dimension
05-006-00136	H27"
05-006-00137	H34"



MARTELLATO Digital Chocolate Dry Melting Container Pro 1/3 Size

Product Code	Dimension	Capacity
05-006-00001	24 x 40 x 13.5cm	3.6ℓ





05-006-00002

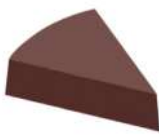

05-006-00003



05-006-00004



05-006-00005



05-006-00006

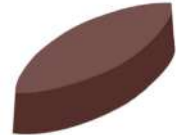

05-006-00007



05-006-00008



05-006-00009



05-006-00010



05-006-00011



05-006-00012



05-006-00013



05-006-00014



05-006-00015



05-006-00017



05-006-00018



05-006-00016



05-006-00019



05-006-00020



05-006-00021



05-006-00026



05-006-00027



05-006-00028



05-006-00029



05-006-00031



05-006-00030



05-006-00032



05-006-00033



05-006-00034



05-006-00035



05-006-00036



05-006-00037



05-006-00038



05-006-00039



05-006-00040



05-006-00041



05-006-00042



05-006-00043



05-006-00044



05-006-00045

CHOCOLATE WORLD PC Chocolate Mould

Product Code	Dimension	Capacity	Type
05-006-00002	27 x 23.5 x 13mm	4 x 6pc / 7g	Zeshoek
05-006-00003	38 x 29.5 x 10mm	2 x 8pc / 7g	Slice Triangle
05-006-00004	45 x 25 x 10mm	2 x 7pc / 8.5g	Cloud
05-006-00005	24 x 24 x 20mm	4 x 6pc / 9.5g	Small Round
05-006-00006	45 x 32 x 10mm	2 x 6pc / 10.5g	Text Ballon
05-006-00007	53 x 20 x 12mm	3 x 4pc / 10.5g	Calison
05-006-00008	35 x 20 x 17mm	3 x 10pc / 14g	Rectangle
05-006-00009	26 x 26 x 18.5mm	3 x 8pc / 12g	Alphanumeric Set 1
05-006-00010	26 x 26 x 18.5mm	3 x 8pc / 12g	Alphanumeric Set 2
05-006-00011	30 x 30 x 12mm	3 x 7pc / 10g	100% Cocoa
05-006-00012	250 x 160 x 23mm	1 pc / 1kg	1 Kg Tablet
05-006-00013	73 x 26 x 8mm	4 x 3pc / 2 x 8.5g	3D Dolphin
05-006-00014	Ø40mm	3 x 6pc / 2 x 20g	3D Golf Ball
05-006-00015	30 x 30 x 9mm	3 x 7pc / 2 x 4.5g	3D Heart
05-006-00016	35 x 20 x 26mm	3 x 8pc / 2 x 5g	3D Precious Stones
05-006-00017	52 x 22 x 7mm	3 x 6pc / 2 x 7g	3D Sea Horse
05-006-00018	44 x 22 x 7mm	3 x 8pc / 2 x 5g	3D Sea Shell
05-006-00019	275 x 135 x 24mm	22pc / 2 x 6g	3D Sea Shells
05-006-00020	Ø26mm	4 x 8pc / 2 x 6g	3D Soccer Ball
05-006-00021	27 x 27 x 13mm	4 x 9pc / 2 x 6g	3D Sphere
05-006-00022	Ø27mm	4 x 8pc / 2 x 6g	3D Sphere
05-006-00023	Ø39mm	3 x 5pc / 2 x 19g	3D Sphere
05-006-00024	Ø50 x H25mm	12pc / 2 x 40g	3D Sphere
05-006-00025	Ø70 x H35mm	2 x 3pc / 2 x 113g	3D Sphere
05-006-00026	38 x 29 x 7mm	3 x 6pc / 2 x 4g	3D Star Fish
05-006-00027	37 x 29 x 14mm	3 x 8pc / 2 x 7.5g	3D Walnut
05-006-00028	27.5 x 23.5 x 14.5mm	4 x 7pc / 9g	4 Leaves Clover
05-006-00029	48 x 37 x 15mm	1 x 6pc / 11g	Bear Pop
05-006-00030	Rhinoceros: 30.5 x 51 x 33 mm, Lion: 38 x 50 x 28 mm, Buffalo: 40 x 51 x 32.5mm, Leopard: 31 x 51 x 33mm, Elephant: 35 x 50 x 30 mm, Baobab tree: 37 x 51 x 28 mm	2 x 6 pc / 30g	Big Five
05-006-00031	32 x 24 x 13mm	4 x 7pc / 9g	Butterfly
05-006-00032	Car 1: 32 x 23 x 9 mm, Car 2: 31.5 x 22 x 9 mm, Car 3: 37.5 x 22 x 9 mm	3 x 8pc / 5g	Cars
05-006-00033	25 x 25 x 25mm	4 x 9pc / 14g	Coffee Bean
05-006-00034	25 x 20 x 8mm	3 x 8pc / 3g	Coffee Bean
05-006-00035	275 x 135 x 35mm Mould: Ø26.5 x 30mm	3 x 7pc / 10g	Couberdon
05-006-00036	275 x 135 x 24mm Mould: 23 x 23 x 20mm	3 x 6pc / 12g	Cube
05-006-00037	26 x 26 x 12mm	3 x 8pc / 8g	Cube Cocoa
05-006-00038	39 x 29 x 19.5mm	3 x 6pc / 11g	Eland
05-006-00039	40 x 39 x 10mm	3 x 6pc / 6.5g	Fishes
05-006-00040	Ø43 x H5mm	2 x 5pc / 6g	Flowers
05-006-00041	48 x 29 x 11mm	4 x 5pc / 19g	Gold Bar
05-006-00042	Ø31 x H18mm	3 x 7pc / 10g	Half Sphere
05-006-00043	27.5 x 27.5 x 15mm	3 x 7pc / 7g	Halve Bol
05-006-00044	29 x 34.5 x 17mm	3 x 7pc / 12g	Heart
05-006-00045	30 x 22 x 20mm	3 x 9pc / 11g	Heart



05-006-00046



05-006-00047



05-006-00048



05-006-00049



05-006-00050



05-006-00051



05-006-00052



05-006-00053



05-006-00054



05-006-00055



05-006-00056

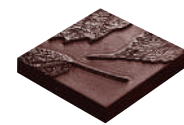

05-006-00057



05-006-00058



05-006-00059



05-006-00060



05-006-00061



05-006-00062

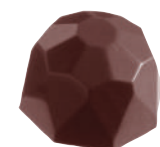

05-006-00063



05-006-00064



05-006-00065



05-006-00066



05-006-00067



05-006-00068



05-006-00069



05-006-00070



05-006-00071



05-006-00072



05-006-00073



05-006-00074



05-006-00075



05-006-00076



05-006-00077



05-006-00078



05-006-00079



05-006-00080



05-006-00081



05-006-00082

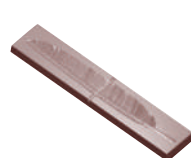

05-006-00083



05-006-00084



05-006-00085



05-006-00086



05-006-00087



05-006-00088



05-006-00089



05-006-00090



05-006-00091



05-006-00092



05-006-00093

CHOCOLATE WORLD PC Chocolate Mould

Product Code	Dimension	Capacity	Type
05-006-00046	30 x 36 x 19mm	3 x 7pc / 14g	Heart
05-006-00047	31 x 27 x 17mm	4 x 7pc / 9g	Heart
05-006-00048	32 x 28 x 15mm	4 x 8pc / 11g	Heart
05-006-00049	54 x 63 x 12mm	1 x 4pc / 29g	Heart Pop
05-006-00050	Bear 1: 33 x 25 x 11.5mm Bear 2: 33 x 25 x 15.5mm	3 x 6pc / 2 x 5.5g	Ice Bear
05-006-00051	66 x 35 x 10mm	10pc / 16g	Ice Cream Pop
05-006-00052	120 x 26 x 18.5mm	3 x 2pc / 40g	Kirsten Tibballs
05-006-00053	61 x 45 x 10mm	2 x 4pc / 2 x 10g	Ladies Shoes
05-006-00054	37 x 27 x 18mm	3 x 8pc / 12g	Leaf
05-006-00055	37 x 31 x 16mm	3 x 7pc / 14g	Leaf
05-006-00056	33 x 29 x 20mm	3 x 8pc / 16g	Leaf
05-006-00057	41 x 41 x 7mm	2 x 4pc / 13g	Leaf Print
05-006-00058	32 x 15.5 x 8mm	3 x 12pc / 2.5g	Lips
05-006-00059	Cavities in Mould: 47 x 33 x 23mm Finishing Product: 33 X 33 X 33 mm	1 x 5pc / 2 x 20.5g	Lolly Cube
05-006-00060	49.5 x 42.5 x 11mm	1 x 4pc / 12g	Lolly Monkey
05-006-00061	50 x 26 x 12mm	2 x 8pc / 2 x 10.5g	Matroesjka
05-006-00062	275x135x30mm Mould: Ø34.5 x 24.5mm	3 x 6pc / 17g	Melo Cake
05-006-00063	28.5 x 28.5 x 18mm	3 x 8pc / 10g	Multi-Faceted
05-006-00064	39 x 18 x 16.5mm	3 x 8pc / 8g	Norman Love
05-006-00065	Ø28 x H25mm	3 x 8pc / 15g	Octagonal
05-006-00066	40 x 38 x 12mm	3 x 6pc / 14g	Orchid
05-006-00067	29 x 28 x 16mm	4 x 7pc / 9g	Oriental Fan
05-006-00068	35 x 23 x 16mm	3 x 8pc / 9g	Oval
05-006-00069	33 x 29 x 12.5mm	3 x 6pc / 2 x 6g	Penguin
05-006-00070	45.5 x 25 x 12.5mm	2 x 8pc / 7g	Quenelle Less is More
05-006-00071	45.5 x 25 x 12.5mm	2 x 8pc / 2 x 10g	Quenelle
05-006-00072	32 x 21 x 14mm	3 x 8pc / 9g	Rectangle
05-006-00073	34 x 24 x 12mm	3 x 8pc / 10g	Rectangle
05-006-00074	35 x 30 x 19mm	3 x 7pc / 13.5g	Rectangle
05-006-00075	36 x 22 x 20mm	3 x 8pc / 15g	Rectangle
05-006-00076	36 x 26 x 18mm	3 x 8pc / 18g	Rectangle
05-006-00077	36 x 28 x 9mm	2 x 6pc / 6g	Rectangle
05-006-00078	39 x 18 x 15.5mm	5 x 5pc / 10g	Rectangle
05-006-00079	78 x 21 x 17mm	5 x 3pc / 25g	Rectangle Bar
05-006-00080	79 x 14 x 7mm	2 x 14pc / 8g	Rectangle Bar
05-006-00081	91 x 36 x 9mm	1 x 6pc / 26g	Rectangle Bar
05-006-00082	117 x 58 x 15mm	1 x 4pc / 100g	Rectangle Bar
05-006-00083	123 x 22 x 6mm	4 x 2pc / 16.5g	Rectangle Bar
05-006-00084	123 x 66 x 12mm	1 x 3pc / 103g	Rectangle Bar
05-006-00085	140 x 24 x 11mm	1 x 8pc / 23g	Rectangle Bar
05-006-00086	142 x 63 x 6mm	1 x 3pc / 47g	Rectangle Bar
05-006-00087	150 x 75 x 11mm	1 x 3pc / 109g	Rectangle Bar
05-006-00088	155 x 72 x 9mm	1 x 3pc / 97g	Rectangle Bar
05-006-00089	156 x 77 x 8mm	1 x 3pc / 80g	Rectangle Bar
05-006-00090	35 x 18 x 15mm	3 x 8pc / 7g	Rectangular Log
05-006-00091	41 x 24 x 10mm	3 x 4pc / 11g	Rectangular Domino
05-006-00092	55 x 42 x 15mm	2 x 5pc / 16g	Robot
05-006-00093	Ø38 x H20mm	3 x 7pc / 12g	Rose



05-006-00094



05-006-00095



05-006-00096



05-006-00097



05-006-00098



05-006-00099



05-006-00100



05-006-00101



05-006-00102



05-006-00103



05-006-00104



05-006-00106



05-006-00105



05-006-00107



05-006-00108



05-006-00109



05-006-00110



05-006-00111



05-006-00112

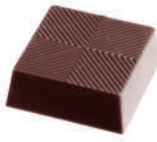

05-006-00113



05-006-00114



05-006-00115



05-006-00116



05-006-00117



05-006-00118



05-006-00119



05-006-00120



05-006-00121



05-006-00122



05-006-00123



05-006-00124



05-006-00125



05-006-00126

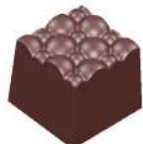

05-006-00127

CHOCOLATE WORLD PC Chocolate Mould

Product Code	Dimension	Capacity	Type
05-006-00094	25 x 25 x 16mm	3 x 8pc / 7g	Round
05-006-00095	28 x 28 x 19mm	3 x 8pc / 11g	Round
05-006-00096	29.5 x 29.5 x 20.2mm	3 x 7pc / 12.3g	Round
05-006-00097	31 x 31 x 15.4mm	3 x 7pc / 12.35g	Round
05-006-00098	Ø29 x H17mm	3 x 8pc / 11g	Round
05-006-00099	Ø30 x H16mm	3 x 8pc / 12g	Round
05-006-00100	Ø30 x H19mm	3 x 7pc / 14g	Round
05-006-00101	Ø31 x H22mm	3 x 8pc / 15g	Round
05-006-00102	Ø39 x H8mm	3 x 6pc / 7g	Round
05-006-00103	33.5 x 32 x 7.5mm	3 x 7pc / 4.5g	Rounded Triangle
05-006-00104	38 x 27 x 17.5mm	3 x 7pc / 10.5g	Santa Claus
05-006-00105	38 x 20 x 7mm	4 x 7pc / 4.5g	Sea Creature
05-006-00106	120 x 135mm	1 x 2pc / 260g	Sea Shell
05-006-00107	37.5 x 32 x 12.5mm	3 x 6pc / 2 x 7.5g	Sheep
05-006-00108	Ø28 x 19mm	3 x 7pc / 7g	Signature Mld Hirai
05-006-00109	49 x 24.5 x 9mm	2 x 8pc / 9.5g	Smiley Face
05-006-00110	25.5 x 25.5 x 18.9mm	3 x 8pc / 11.75g	Square
05-006-00111	26 x 26 x 14mm	3 x 8pc / 10g	Square
05-006-00112	26 x 26 x 18mm	4 x 8pc / 11g	Square
05-006-00113	39 x 39 x 14mm	3 x 6pc / 27g	Square
05-006-00114	33.5 x 18 x 9.5mm	3 x 8pc / 2 x 4g	Star Truffle Alexandre
05-006-00115	156 x 77 x 8mm	1 x 3pc / 93g	Table Cocoa Bean
05-006-00116	40 x 22 x 13mm	3 x 7pc / 5.5g	Tasty Stick
05-006-00117	50 x 39 x 13mm	2 x 6pc / 16g	Teddy Bear
05-006-00118	44 x 36 x 16mm	3 x 7pc / 13g	Transport
05-006-00119	Ø31 x 21.5mm	3 x 7pc / 10g	Volcano Louis Tanuh
05-006-00120	35 x 33 x 12.5mm	3 x 6pc / 2 x 6g	Zeehond
05-006-00121	100 x 100 x 8mm	1 x 2pc / 75g	Tablet Squared
05-006-00122	23 x 23 x 20mm	4 x 8pc / 12g	Cube
05-006-00123	Ø30 x 15mm	3 x 7pc / 9.5g	Smiley
05-006-00124	Ø28 x 14mm	3 x 7pc / 6.5g	Shere Strik
05-006-00125	22.5 x 22.5 x 20mm	4 x 8pc / 12g	Structura 1 Leather
05-006-00126	22.5 x 22.5 x 19.5mm	4 x 8pc / 11.5g	Structura 2 Wood
05-006-00127	22.5 x 22.5 x 20.5mm	4 x 8pc / 11.5g	Structura 3 Bubble

PA ST RY



Discover the whole range
www.pavonitalia.com



pavoni
ITALIA

STORAGE ORGANIZATION & SHELVING



CHAPTER

06

SIA HUAT 
Beyond Foodservice Supplies

www.siahuat.com

EASY & QUICK TO CLEAN

For A Sanitary Storage Area

- Shelf plates are easy to remove and run through the dishwasher.
- Smooth polypropylene surface quickly wipes clean.
- Spills clean quickly and easily, reducing the risk of cross-contamination.
- Camshelving® is weldless, so liquids and dirt cannot get inside crevices.



- Inhibits the growth of mold, fungus and bacteria.
- Camguard works continuously to suppress the growth of microbes between cleanings.
- All shelf plates are embedded with Camguard antimicrobial so it will not scrape off, wash off or wear out.



STRONG & DURABLE

For A Sanitary Storage Area

- Posts and traverses are the weight bearing components, constructed with a steel core and encapsulated by a thick polypropylene outer layer.
- Inner steel core ensures that Camshelving is strong, durable and stable.
- Thick, polypropylene outer layer will not chip, break or corrode.
- Post connectors provide exceptional cross stabilization.

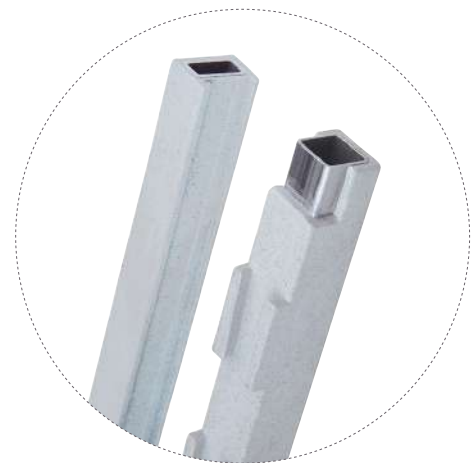

Weight bearing components are made with a steel core.

Weight Bearing Capacity



	Single Unit - 4 Shelves	Single Unit - 4 Shelves	Dunnage Stand	Corner Unit	Mobile Unit
Traverse Length	610 to 1220mm	1370 to 1830mm	1300 to 1830mm	610 to 1220mm	610 to 1220mm
Weight Bearing Capacity Per Shelf	363kg	272kg	454kg	181kg	-
Weight Bearing Capacity Per Unit with 4 Shelves	1451kg	1089kg	-	726kg	340kg

Dunnage Stands are used only on the bottom shelf. Recommended for traverses 1370mm or longer.

Corner Connectors are recommended for use on traverses 1220mm or less.

Due to the weight bearing capacity of casters, maximum weight load on an entire Mobile Camshelving Unit is 340kg.

COMPONENTS

Camshelving is a modular system that allows the flexibility to assemble shelving to fit any size area. The key components, including posts, post connectors, traverses and shelf plates, are available in a variety of sizes.

They can be easily configured to custom build shelving to maximize storage space. Unique design elements such as shared posts and corner connectors simplify assembly and increase storage capacity.

Traverses

Traverses have a steel core with a polypropylene exterior to provide strength and durability. Traverses connect to the post by sliding on to the dovetail on the post.

Two traverses are needed to build one shelf, and they define the length of the unit.

Shelf Plates

Shelf Plates are made of polypropylene. Dishwasher safe.

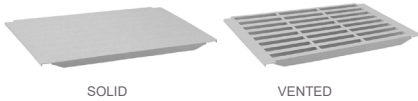

SOLID

VENTED



Post Kit

Includes two Traverses and Shelf Plates to fit the length of the Traverses.

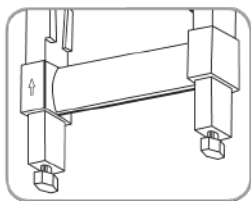

Posts For Stationary Unit

Posts have a steel core with polypropylene exterior to provide strength and durability.

Posts define the height of the shelving unit and are measured with the leveling foot fully engaged.

Post for Stationary unit



STATIONARY UNIT

Post Connectors

Post connectors hold two posts together and define the width of the unit. They are made of polypropylene and provide excellent cross stabilization.

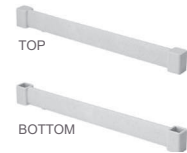

TOP

BOTTOM

Post Kit

Includes two Posts and a set of one top and one bottom Post Connector.



Post for Mobile Camshelving

Mobile Camshelving posts must be used to build mobile Camshelving units.

Post for Mobile unit



MOBILE UNIT

MOBILE UNIT

Castors

Available in standard for dry storage or premium for freezers, cold, or wet applications.



MAXIMIZE SPACE UTILIZATION

Starter Units

- Available in stationary or mobile units.
- Starter units ship complete with two post kits, traverses and shelf plates to build an entire unit.
- Spills clean quickly and easily, reducing the risk of cross-contamination.
- Camshelving® is weldless, so liquids and dirt cannot get inside crevices.

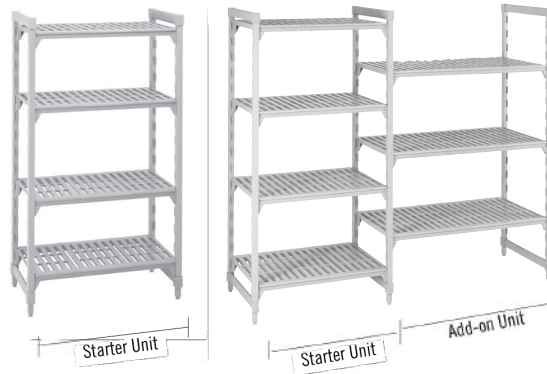

Add-On Units

- Add-On units ship complete with one post kit, traverses and shelf plates to attach to an adjoining unit.
- The traverses on both the first and second unit share the middle post.
- No add-on clips or S-hooks required.
- There is no loss of weight bearing capacity when built in a straight line.

Corner Unit & U Shape Units

- Corner connectors can be used to build corner units and U Shape units.
- Traverses snap onto corner connectors just like they snap onto the dovetails of the posts.



Corner Connector Set

- Attaches a basic unit to a second unit at a 90° angle or to form a U shape.
- A set of corner connectors are needed for each shelf.

Mobile Units

- Mobile Camshelving units are built by using posts for mobile carts and inserting casters.
- Mobile units are not designed to serve as transport carts.



Mobile unit shown with optional fencing.

Accessories

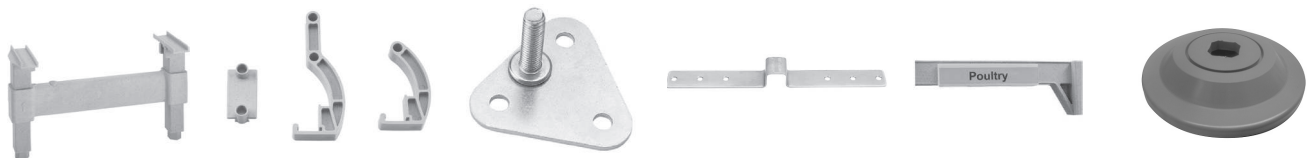

Dunnage Stand	Fence System	Seismic Foot	Wall Fastener	Identification Tag	Donut Bumper
<ul style="list-style-type: none"> • Increases weight bearing capacity to 454 kg on the bottom shelf. • Recommended for units 1380 mm or longer. 	<ul style="list-style-type: none"> • Prevents stored items from falling off shelving units. • Ideal for mobile shelving. 	<ul style="list-style-type: none"> • Bolts a post to the floor for a more stable base. • Screws not included. 	<ul style="list-style-type: none"> • Fastens a unit to a wall as a safety precaution. • Screws not included. 	<ul style="list-style-type: none"> • Easily clips onto traverses to identify stored items. • Made of PVC. • Includes 12 HACCP labels. 	<ul style="list-style-type: none"> • Protects mobile Camshelving. • 90 mm Bumper.

CAMBRO PREMIUM 4-Shelves Vented Units (64" Height)

Depth	Dimensions	Starter Unit	Add-On
18" Depth Premium Series	18 x 24 x 64"	CPU182464V4-480	CPA182464V4-480
	18 x 30 x 64"	CPU183064V4-480	CPA183064V4-480
	18 x 36 x 64"	CPU183664V4-480	CPA183664V4-480
	18 x 42 x 64"	CPU184264V4-480	CPA184264V4-480
	18 x 48 x 64"	CPU184864V4-480	CPA184864V4-480
	18 x 54 x 64"	CPU185464V4-480	CPA185464V4-480
	18 x 60 x 64"	CPU186064V4-480	CPA186064V4-480
	18 x 72 x 64"	CPU187264V4PKG-480	CPA187264V4PKG-480
21" Depth Premium Series	21 x 24 x 64"	CPU212464V4-480	CPA212464V4-480
	21 x 30 x 64"	CPU213064V4-480	CPA213064V4-480
	21 x 36 x 64"	CPU213664V4-480	CPA213664V4-480
	21 x 42 x 64"	CPU214264V4-480	CPA214264V4-480
	21 x 48 x 64"	CPU214864V4-480	CPA214864V4-480
	21 x 54 x 64"	CPU215464V4-480	CPA215464V4-480
	21 x 60 x 64"	CPU216064V4-480	CPA216064V4-480
	21 x 72 x 64"	CPU217264V4PKG-480	CPA217264V4PKG-480
24" Depth Premium Series	24 x 24 x 64"	CPU242464V4-480	CPA242464V4-480
	24 x 30 x 64"	CPU243064V4-480	CPA243064V4-480
	24 x 36 x 64"	CPU243664V4-480	CPA243664V4-480
	24 x 42 x 64"	CPU244264V4-480	CPA244264V4-480
	24 x 48 x 64"	CPU244864V4-480	CPA244864V4-480
	24 x 54 x 64"	CPU245464V4-480	CPA245464V4-480
	24 x 60 x 64"	CPU246064V4-480	CPA246064V4-480
	24 x 72 x 64"	CPU247264V4PKG-480	CPA247264V4PKG-480

CAMBRO ELEMENT 4-Shelves Vented Units (72" Height)

Depth	Dimensions	Starter Unit	Add-On
18" Depth Element Series	18 x 24 x 72"	ESU182472V4-580	EA182472V4-580
	18 x 30 x 72"	ESU183072V4-580	EA183072V4-580
	18 x 36 x 72"	ESU183672V4-580	EA183672V4-580
	18 x 42 x 72"	ESU184272V4-580	EA184272V4-580
	18 x 48 x 72"	ESU184872V4-580	EA184872V4-580
	18 x 54 x 72"	ESU185472V4-580	EA185472V4-580
	18 x 60 x 72"	ESU186072V4-580	EA186072V4-580
	18 x 72 x 72"	ESU187272V4-580	EA187272V4-580
21" Depth Element Series	21 x 24 x 72"	ESU212472V4-580	EA212472V4-580
	21 x 30 x 72"	ESU213072V4-580	EA213072V4-580
	21 x 36 x 72"	ESU213672V4-580	EA213672V4-580
	21 x 42 x 72"	ESU214272V4-580	EA214272V4-580
	21 x 48 x 72"	ESU214872V4-580	EA214872V4-580
	21 x 54 x 72"	ESU215472V4-580	EA215472V4-580
	21 x 60 x 72"	ESU216072V4-580	EA216072V4-580
	21 x 72 x 72"	ESU217272V4-580	EA217272V4-580
24" Depth Element Series	24 x 24 x 72"	ESU242472V4-580	EA242472V4-580
	24 x 30 x 72"	ESU243072V4-580	EA243072V4-580
	24 x 36 x 72"	ESU243672V4-580	EA243672V4-580
	24 x 42 x 72"	ESU244272V4-580	EA244272V4-580
	24 x 48 x 72"	ESU244872V4-580	EA244872V4-580
	24 x 54 x 72"	ESU245472V4-580	EA245472V4-580
	24 x 60 x 72"	ESU246072V4-580	EA246072V4-580
	24 x 72 x 72"	ESU247272V4-580	EA247272V4-580

CAMBRO PREMIUM 4-Shelves Vented Units (72" Height)

Depth	Dimensions	Starter Unit	Add-On	
18" Depth Premium Series	18 x 24 x 72"	CPU182472V4-480	CPA182472V4-480	
	18 x 30 x 72"	CPU183072V4-480	CPA183072V4-480	
	18 x 36 x 72"	CPU183672V4-480	CPA183672V4-480	
	18 x 42 x 72"	CPU184272V4-480	CPA184272V4-480	
	18 x 48 x 72"	CPU184872V4-480	CPA184872V4-480	
	18 x 54 x 72"	CPU185472V4-480	CPA185472V4-480	
	18 x 60 x 72"	CPU186072V4-480	CPA186072V4-480	
	18 x 72 x 72"	CPU187272V4PKG-480	CPA187272V4PKG-480	
	21" Depth Premium Series	21 x 24 x 72"	CPU212472V4-480	CPA212472V4-480
		21 x 30 x 72"	CPU213072V4-480	CPA213072V4-480
21 x 36 x 72"		CPU213672V4-480	CPA213672V4-480	
21 x 42 x 72"		CPU214272V4-480	CPA214272V4-480	
21 x 48 x 72"		CPU214872V4-480	CPA214872V4-480	
21 x 54 x 72"		CPU215472V4-480	CPA215472V4-480	
21 x 60 x 72"		CPU216072V4-480	CPA216072V4-480	
21 x 72 x 72"		CPU217272V4PKG-480	CPA217272V4PKG-480	
24" Depth Premium Series		24 x 24 x 72"	CPU242472V4-480	CPA242472V4-480
		24 x 30 x 72"	CPU243072V4-480	CPA243072V4-480
	24 x 36 x 72"	CPU243672V4-480	CPA243672V4-480	
	24 x 42 x 72"	CPU244272V4-480	CPA244272V4-480	
	24 x 48 x 72"	CPU244872V4-480	CPA244872V4-480	
	24 x 54 x 72"	CPU245472V4-480	CPA245472V4-480	
	24 x 60 x 72"	CPU246072V4-480	CPA246072V4-480	
	24 x 72 x 72"	CPU247272V4PKG-480	CPA247272V4PKG-480	

EASY TO ASSEMBLE & ADJUST

Build Any Configuration and Fit Any Size Area

- Create a space efficient layout for any area.
- Assembles in minutes, requiring only the use of a mallet.
- Shelves can be adjusted in 100mm increments without disassembling the entire unit.
- Two units can be connected together with shelves at alternating heights for maximum storage flexibility
- Corners Connectors attach units to create a 90° angle or U shape.

EASY TO ADJUST!

Shelves can be adjusted in 100mm increments, without disassembling the unit.

EASY TO ASSEMBLE!

Traverses slide easily down onto dovetail

- Mobile units are not designed to serve as transport carts.



- Mobile Camshelving units are built by using posts for mobile carts and inserting casters.

CAMBRO PREMIUM 4-Shelves Vented Mobile Unit (67" Height)

Depth	Dimensions	Mobile Unit
18" Depth <i>Premium Series</i>	18 x 36 x 67"	CPMU183667V4-480
	18 x 42 x 67"	CPMU184267V4-480
	18 x 48 x 67"	CPMU184867V4-480
21" Depth <i>Premium Series</i>	21 x 36 x 67"	CPMU213667V4-480
	21 x 42 x 67"	CPMU214267V4-480
	21 x 48 x 67"	CPMU214867V4-480
24" Depth <i>Premium Series</i>	24 x 36 x 67"	CPMU243667V4-480
	24 x 42 x 67"	CPMU244267V4-480
	24 x 48 x 67"	CPMU244867V4-480

CAMBRO PREMIUM 4-Shelves Vented Mobile Unit (75" Height)

Depth	Dimensions	Mobile Unit
18" Depth <i>Premium Series</i>	18 x 36 x 75"	CPMU183675V4-480
	18 x 42 x 75"	CPMU184275V4-480
	18 x 48 x 75"	CPMU184875V4-480
21" Depth <i>Premium Series</i>	21 x 36 x 75"	CPMU213675V4-480
	21 x 42 x 75"	CPMU214275V4-480
	21 x 48 x 75"	CPMU214875V4-480
24" Depth <i>Premium Series</i>	24 x 36 x 75"	CPMU243675V4-480
	24 x 42 x 75"	CPMU244275V4-480
	24 x 48 x 75"	CPMU244875V4-480

CAMBRO ELEMENT 4-Shelves Vented Mobile Unit (70" Height)

Depth	Dimensions	Mobile Unit
18" Depth <i>Element Series</i>	18 x 36 x 70"	EMU183670V4-580
	18 x 42 x 70"	EMU184270V4-580
	18 x 48 x 70"	EMU184870V4-580
	18 x 54 x 70"	EMU185470V4-580
	18 x 60 x 70"	EMU186070V4-580
21" Depth <i>Element Series</i>	21 x 36 x 70"	EMU213670V4-580
	21 x 42 x 70"	EMU214270V4-580
	21 x 48 x 70"	EMU214870V4-580
	21 x 54 x 70"	EMU215470V4-580
24" Depth <i>Element Series</i>	21 x 60 x 70"	EMU216070V4-580
	24 x 36 x 70"	EMU243670V4-580
	24 x 42 x 70"	EMU244270V4-580
	24 x 48 x 70"	EMU244870V4-580
24" Depth <i>Element Series</i>	24 x 54 x 70"	EMU245470V4-580
	24 x 60 x 70"	EMU246070V4-580

CAMBRO ELEMENT 4-Shelves Vented Mobile Unit (78" Height)

Depth	Dimensions	Mobile Unit
18" Depth <i>Element Series</i>	18 x 36 x 78"	EMU183678V4-580
	18 x 42 x 78"	EMU184278V4-580
	18 x 48 x 78"	EMU184878V4-580
	18 x 54 x 78"	EMU185478V4-580
	18 x 60 x 78"	EMU186078V4-580
	21 x 36 x 78"	EMU213678V4-580
21" Depth <i>Element Series</i>	21 x 42 x 78"	EMU214278V4-580
	21 x 48 x 78"	EMU214878V4-580
	21 x 54 x 78"	EMU215478V4-580
	21 x 60 x 78"	EMU216078V4-580
24" Depth <i>Element Series</i>	24 x 36 x 78"	EMU243678V4-580
	24 x 42 x 78"	EMU244278V4-580
	24 x 48 x 78"	EMU244878V4-580
	24 x 54 x 78"	EMU245478V4-580
24" Depth <i>Element Series</i>	24 x 60 x 78"	EMU246078V4-580

RUST FREE

For Use In Any Area, Wet or Dry

- Camshelving is weldless with no exposed metal, so it remains rust free.
- Not even salt water or sea air will corrode Camshelving.
- Safe to -38°C, making Camshelving the ideal shelving system for freezers, walk-ins or any wet or humid environment



Lifetime limited warranty against rust and corrosion for traverses and stationary posts.



CAMBRO Full Wrap Mobile Security Cage

Product Code	Dimension
06-001-00303(XX)	127.6 x 68 x 172.1cm



CAMBRO Camshelving Accessory Security Cage

Product Code	Dimension
06-001-00302(XX)	108 x 64 x 46cm



CAMBRO Camshelving Drying Racks

Product Code	Dimension	Colour
06-001-00283(XX)	59.4 x 24 x 9.6cm	Soft Gray



CAMBRO Camshelving Accessory Donut Bumper

Product Code	Dimension
06-001-00279(XX)	3.5"



CAMBRO Camshelving Accessory Dunnage Stand

Product Code	Dimension	Colour
06-001-00284(XX)	18"	Soft Gray
06-001-00285(XX)	21"	Soft Gray



CAMBRO Camshelving Accessory High Density Donut Bumper

Product Code
06-001-00301(XX)



CAMBRO Camshelving Accessory ID Tag

Product Code	Dimension	Colour
06-001-00299	8 x 2.5cm	Speckled Gray

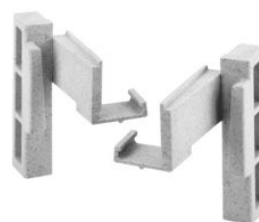

CAMBRO Camshelving Accessory Corner Connector Set of 10

Product Code	Colour
06-001-00307(XX)	Elements / Brushed Graphite



CAMBRO Camshelving Accessory Angled Pan Divider Bar

Product Code	Colour
06-001-00281(XX)	Speckled Gray



CAMBRO Camshelving Accessory Seismic Foot

Product Code	Colour
06-001-00286(XX)	Silver



CAMBRO Camshelving Accessory Wall Fastener

Product Code	Colour
06-001-00304(XX)	Silver



CAMBRO Camshelving Accessory Wall Solid Shelf Extender

Product Code	Dimension	Colour
06-001-00305(XX)	18" x 48"	Speckled Gray
06-001-00306(XX)	48"	Black



JIWIN Vented Starter Unit 4 Shelves

Product Code	Dimension (L x W x H)	Product Code	Dimension (L x W x H)	Product Code	Dimension (L x W x H)
06-001-00084	36" x 14" x 64"	06-001-00105	42" x 18" x 79"	06-001-00126	54" x 14" x 72"
06-001-00085	36" x 14" x 64"	06-001-00106	42" x 21" x 64"	06-001-00127	54" x 18" x 72" (5 Shelves)
06-001-00086(XX)	36" x 14" x 64"	06-001-00107	42" x 21" x 64"	06-001-00128	54" x 21" x 64"
06-001-00087	36" x 14" x 72"	06-001-00108	42" x 21" x 79"	06-001-00129	54" x 21" x 72"
06-001-00088	36" x 18" x 64"	06-001-00109	42" x 24" x 64"	06-001-00130	54" x 24" x 72"
06-001-00089(XX)	36" x 18" x 64"	06-001-00110	42" x 24" x 64"	06-001-00131	60" x 14" x 72"
06-001-00090	36" x 18" x 72"	06-001-00111	42" x 24" x 72"	06-001-00132	60" x 18" x 72"
06-001-00091	36" x 18" x 79"	06-001-00112	48" x 14" x 64"	06-001-00133	60" x 18" x 79"
06-001-00092	36" x 21" x 64"	06-001-00113	48" x 14" x 80"	06-001-00134	60" x 18" x 79"
06-001-00093	36" x 21" x 64"	06-001-00114	48" x 18" x 64"	06-001-00135	60" x 21" x 64"
06-001-00094	36" x 21" x 72"	06-001-00115	48" x 18" x 72"	06-001-00136	60" x 21" x 72"
06-001-00095	36" x 21" x 79"	06-001-00116	48" x 18" x 79"	06-001-00137	60" x 24" x 72"
06-001-00096	36" x 24" x 64"	06-001-00117	48" x 21" x 64"	06-001-00138	72" x 14" x 64"
06-001-00097	36" x 24" x 64"	06-001-00118	48" x 21" x 64"	06-001-00139(XX)	72" x 14" x 64"
06-001-00098	36" x 24" x 72"	06-001-00119	48" x 24" x 64"	06-001-00140	72" x 18" x 72"
06-001-00099	36" x 24" x 79"	06-001-00120	48" x 21" x 72"	06-001-00141	72" x 21" x 72"
06-001-00100	42" x 14" x 64"	06-001-00121	48" x 21" x 79"	06-001-00142	72" x 24" x 64"
06-001-00101(XX)	42" x 14" x 64"	06-001-00122	48" x 24" x 64"	06-001-00143(XX)	72" x 24" x 64" (5 Shelves)
06-001-00102	42" x 18" x 64"	06-001-00123	48" x 24" x 72"	06-001-00144	72" x 24" x 72"
06-001-00103	42" x 18" x 64"	06-001-00124(XX)	48" x 24" x 75"	06-001-00145(XX)	72" x 24" x 72" (5 Shelves)
06-001-00104	42" x 18" x 72"	06-001-00125	48" x 24" x 79"		



JIWIN Shelf Plate Kit with Vented Shelf Plates

Product Code	Dimension
06-001-00325(XX)	36" x 14"
06-001-00326(XX)	36" x 18"
06-001-00327(XX)	36" x 21"
06-001-00328(XX)	36" x 24"
06-001-00329(XX)	42" x 18"
06-001-00330(XX)	42" x 21"
06-001-00331(XX)	42" x 24"

Product Code	Dimension
06-001-00332(XX)	48" x 14"
06-001-00333(XX)	48" x 18"
06-001-00334(XX)	48" x 21"
06-001-00335(XX)	48" x 24"
06-001-00336(XX)	54" x 18"
06-001-00337(XX)	54" x 21"
06-001-00338(XX)	54" x 24"

Product Code	Dimension
06-001-00339(XX)	60" x 14"
06-001-00340(XX)	60" x 18"
06-001-00341(XX)	60" x 21"
06-001-00342(XX)	60" x 24"
06-001-00378(XX)	72" x 21"
06-001-00379(XX)	72" x 24"



JIWIN Shelf Plate Kit with Vented Shelf Plates

Product Code	Dimension
06-001-00376(XX)	36" x 14"
06-001-00343(XX)	36" x 18"
06-001-00344(XX)	36" x 21"
06-001-00345(XX)	36" x 24"
06-001-00346(XX)	42" x 18"
06-001-00347(XX)	42" x 21"

Product Code	Dimension
06-001-00348(XX)	42" x 24"
06-001-00349(XX)	48" x 18"
06-001-00350(XX)	48" x 21"
06-001-00351(XX)	48" x 24"
06-001-00352(XX)	54" x 18"
06-001-00353(XX)	54" x 21"

Product Code	Dimension
06-001-00354(XX)	54" x 24"
06-001-00377(XX)	60" x 14"
06-001-00355(XX)	60" x 18"
06-001-00356(XX)	60" x 21"
06-001-00357(XX)	60" x 24"



JIWIN Add-On Unit 4 Shelves

Product Code	Dimension (L x W x H)
06-001-00200	36" x 18" x 72"
06-001-00201	36" x 18" x 79"
06-001-00202	36" x 21" x 64"
06-001-00203	36" x 21" x 72"
06-001-00204	36" x 24" x 72"
06-001-00205	42" x 18" x 72"
06-001-00206	42" x 18" x 79"
06-001-00207	42" x 21" x 72"
06-001-00208	42" x 24" x 64"
06-001-00209	42" x 24" x 72"
06-001-00210	48" x 18" x 72"
06-001-00211	48" x 21" x 64"
06-001-00212	48" x 21" x 72"
06-001-00213	48" x 24" x 64"
06-001-00214	48" x 24" x 72"
06-001-00215	54" x 18" x 79"
06-001-00216	54" x 21" x 64"
06-001-00217	54" x 21" x 72"
06-001-00218	54" x 24" x 72"

Product Code	Dimension (L x W x H)
06-001-00219	60" x 18" x 72"
06-001-00220	60" x 18" x 79"
06-001-00221	60" x 21" x 72"
06-001-00222	60" x 24" x 72"
06-001-00223	36" x 14" x 64"
06-001-00224	36" x 14" x 72"
06-001-00225	36" x 18" x 64"
06-001-00227	36" x 24" x 64"
06-001-00228	42" x 14" x 64"
06-001-00229	42" x 14" x 72"
06-001-00230	42" x 18" x 64"
06-001-00231	42" x 21" x 64"
06-001-00232	48" x 14" x 64"
06-001-00233	48" x 14" x 72"
06-001-00234	48" x 18" x 64"
06-001-00235	54" x 14" x 64"
06-001-00236	54" x 14" x 72"
06-001-00237	54" x 18" x 64"
06-001-00238	54" x 18" x 72"

Product Code	Dimension (L x W x H)
06-001-00239	54" x 24" x 64"
06-001-00240(XX)	54" x 24" x 72" (5 Shelves)
06-001-00241	60" x 14" x 64"
06-001-00242	60" x 14" x 72"
06-001-00243	60" x 18" x 64"
06-001-00244	60" x 21" x 64"
06-001-00245	60" x 24" x 64"
06-001-00246	72" x 14" x 64"
06-001-00247	72" x 14" x 72"
06-001-00248	72" x 18" x 64"
06-001-00249	72" x 18" x 72"
06-001-00250	72" x 21" x 64"
06-001-00251	72" x 21" x 72"
06-001-00252	72" x 24" x 64"
06-001-00253(XX)	72" x 9.5" x 25" (5 Shelves)
06-001-00254	72" x 24" x 72"
06-001-00255(XX)	72" x 24" x 72" (5 Shelves)



JIWINS Shelving Accessory Post Kit

Product Code	Dimension
06-001-00358(XX)	14" x 64"
06-001-00359(XX)	14" x 72"
06-001-00360(XX)	14" x 79"
06-001-00361(XX)	18" x 64"
06-001-00362(XX)	18" x 72"
06-001-00363(XX)	18" x 79"
06-001-00364(XX)	21" x 64"
06-001-00365(XX)	21" x 72"
06-001-00366(XX)	21" x 79"
06-001-00367(XX)	24" x 64"
06-001-00368(XX)	24" x 72"
06-001-00369(XX)	24" x 79"

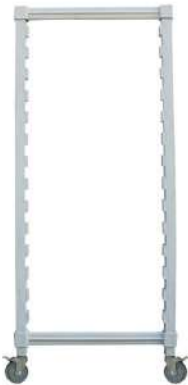

JIWINS Shelving Accessory Post Kit with Caster and Brake

Product Code	Dimension
06-001-00370(XX)	24" x 64"



JIWINS Post Kit with Caster

Product Code	Dimension
06-001-00380(XX)	18" x 79"



JIWINS Shelving Accessory Traverse

Product Code	Dimension
06-001-00371(XX)	36"
06-001-00372(XX)	42"
06-001-00373(XX)	48"
06-001-00374(XX)	54"
06-001-00375(XX)	60"



JIWINS Caster with Brake for Shelving

Product Code
06-001-00324(XX)



JIWINS Corner Connector Set

Product Code	Dimension
06-001-00308(XX)	3.5"



TRUST Plastic Food Storage Trolley / Plastic Front Loading Trolley

Product Code	Dimension	Add. Info.
06-007-00001	60.3 x 47.3 x 172.4cm Shelf Width - 33cm	For GN 1/1 Size Pans. 17 tray slots in total. Fits either 3pc GN1/3, 2pc GN1/2, 1pc GN 1/1 per slot.
06-007-00017	80.6 x 60.3 x 172.4cm	For 66x45.7cm baking pans



Stainless Steel Single Column Trolley for GN 1/1 Inserts

Product Code	Dimension
06-007-00002	38 x 55 x 100cm



Stainless Steel Single Column Trolley for GN 1/1 Inserts

Product Code	Dimension
06-007-00005	38 x 55 x 173.5cm



Stainless Steel Double Column Trolley for GN 1/1 Inserts

Product Code	Dimension
06-007-00003	74 x 55 x 100cm



Stainless Steel Double Column Trolley for GN 1/1 Inserts

Product Code	Dimension
06-007-00006	74 x 55 x 173.5cm



Stainless Steel Single Column Trolley for GN 2/1 Inserts

Product Code	Dimension
06-007-00004	59 x 67 x 100cm



Stainless Steel Single Column Trolley for GN 2/1 Inserts

Product Code	Dimension
06-007-00007	59 x 67 x 173.5cm



Stainless Steel 16-Tier Single Column Trolley for 60x40cm Inserts

Product Code	Dimension
06-007-00019	62 x 47 x 173.5cm



Stainless Steel 16-Tier Single Column Trolley for 26x18" Bun Pans

Product Code	Dimension
06-007-00018	66.5 x 51.5 x 173.5cm



Stainless Steel Trolley for GN 1/1 Pans with Worktop

Product Code	Dimension
06-007-00008(XX)	135 x 56 x 86.5cm 2 x 9 Tiers



CCK Stainless Steel 3-Tier Utility Trolley

Product Code	Dimension
06-008-00070	62.5 x 37.5 x 90cm
06-008-00071	81 x 45.5 x 80cm
06-008-00068	80 x 50 x 90cm



Stainless Steel 3-Tier Utility Trolley

Product Code	Dimension
06-008-00051	70 x 39 x 81cm
06-008-00050	79 x 45 x 83cm



Stainless Steel 3-Tier Utility Trolley

Product Code	Dimension
06-008-00055	85 x 45 x 90cm
06-008-00054	95 x 50 x 90cm



Stainless Steel 2-Tier Trolley

Product Code	Dimension
06-008-00053	85 x 45 x 90cm
06-008-00052	95 x 50 x 90cm



TRUST Bitbar 2 Tier Utility Cart

Product Code	Dimension	Capacity	Colour
06-008-00036	97.8 x 43.5 x 98.7cm	Max load 230kg	■ Black
06-008-00035	115 x 64.1 x 98.7cm	Max load 230kg	■ Black



TRUST Bitbar 2 Tier Flat Shelf Utility Cart

Product Code	Dimension	Capacity	Colour
06-008-00037	97.8 x 43.5 x 96.8cm	Max load 230kg	■ Black



TRUST 4-Tier Trolley

Product Code	Dimension	Capacity	Colour
06-008-00038	103.2 x 50.8 x 129.5cm	Load 135kg	■ Black



Plastic 3-Tier Trolley with 2-Wheel Brake

Product Code	Dimension	Colour
06-008-00087	102 x 50 x 96cm	■ Black
06-008-00088	81.5 x 43 x 95cm	■ Black



Plastic 3-Tier Trolley with 2-Wheel Brake and 3 Side Panels

Product Code	Dimension	Colour
06-008-00089	102 x 50 x 96cm	■ Black



CARLISLE Bussing Cart with Doors and Panels

Product Code	Dimension	Colour
06-008-00028	92 x 45.7 x 96.5cm	■ Black



CARLISLE Bussing Cart with Panels

Product Code	Dimension	Colour
06-008-00029	92 x 45.7 x 96.5cm	■ Black



CARLISLE Bussing Cart Open

Product Code	Dimension	Colour
06-008-00027	92 x 45.7 x 96.5cm	■ Black
06-008-00030	106.7 x 51 x 92.3cm	



CARLISLE Cutlery Bin for Bussing Cart

Product Code	Capacity
06-008-00025	8ℓ



CARLISLE Trash Bin for Bussing Cart

Product Code	Capacity
06-008-00026	24ℓ



CAMBRO Polypropylene 3-Tier Utility Trolley

Product Code	Dimension	Capacity	Colour
06-008-00013	83.5 x 41.3 x 96.5cm	Load Capacity 136kg	■ Black
06-008-00014	83.5 x 41.3 x 96.5cm	Load Capacity 136kg	■ Speckled Gray



CAMBRO Polypropylene 3-Tier Utility Trolley

Product Code	Dimension	Capacity	Colour	Matching Single 1-Tier Panel (Set of 3pcs)	Flatware Container	Trash Container
06-008-00017	101.5 x 54 x 95cm	Load Capacity 180kg	■ Black	06-008-00019	06-008-00015 Dimension: 33 x 24 x 18.5cm	06-008-00016 Dimension: 33 x 24 x 56cm
06-008-00018	101.5 x 54 x 95cm	Load Capacity 180kg	■ Speckled Gray	06-008-00020	Capacity: 9.5ℓ	Capacity: 30ℓ



UNICA PLC 3-Tier Trolley with 2-Wheel Brake

Product Code	Dimension	Colour
06-008-00078	71 x 42 x 90cm	■ Beige
06-008-00079	71 x 42 x 90cm	■ Black
06-008-00086	71 x 42 x 90cm	■ Grey



UNICA PLC 3-Tier Trolley with 2-Wheel Brake

Product Code	Dimension	Colour
06-008-00084	101.5 x 54 x 95cm	■ Black
06-008-00085	101.5 x 54 x 95cm	■ Grey

*Accessories - 06-008-00046 / 06-008-00047



UNICA Plastic Refuse Bin

Product Code	Dimension	Capacity	Colour
06-008-00042	33.7 x 23.1 x 56cm	30ℓ	■ Black



UNICA Plastic Cutlery Bin

Product Code	Dimension	Capacity	Colour
06-008-00043	33.7 x 23.1 x 18.7cm	9.5ℓ	■ Black



UNICA 1-Tier Shelf Panel for 06-008-00084 (set of 3pc)

Product Code	Colour
06-008-00046	■ Black



UNICA 1-Tier Shelf Panel for 06-008-00085 (set of 3pc)

Product Code	Colour
06-008-00047	■ Gray



CARLISLE Fold N Go Cart

Product Code	Dimension	Capacity	Colour
06-008-00032(XX)	74 x 40.6 x 90.8cm	Load Capacity 136kg	■ Dove Gray
06-008-00034(XX)	101.6 x 52.1 x 90.8cm	Load Capacity 180kg	■ Dove Gray



JIWINS Polypropylene Big Folding Cart

Product Code	Dimension	Colour
06-008-00083	76 x 42 x 90cm	■ Black
06-008-00082	99 x 52 x 90cm	■ Black



TRUST Oeasly Platform Truck with Pneumatic Casters

Product Code	Dimension	Capacity	Colour
06-008-00001	132.4 x 61 x 107cm	Max load 540kg	■ Black
06-008-00002	162.9 x 76.2 x 107cm	Max load 540kg	■ Black



TRUST Oeasly Platform Truck

Product Code	Dimension	Capacity	Colour
06-008-00003	162.9 x 76.2 x 105.7cm	Max load 1130kg	■ Black



TRUST Oeasy Panel Platform Cart

Product Code	Dimension	Capacity	Colour
06-008-00006(XX)	111.8 x 61 x 99.7cm	Max load 450kg	Black



TRUST Foldable Goods Trolley

Product Code	Dimension	Capacity	Colour
06-008-00004	82.6 x 52.1cm	Max load 110kg	Black
06-008-00005	82.6 x 52.1cm	Max load 230kg	Black



PLC Foldable Goods Trolley

Product Code	Dimension
06-008-00009	73 x 49 x 86cm
06-008-00010	91 x 60 x 89cm



JAPAN PLC Cargo / Goods Trolley

Product Code	Dimension	Size
06-008-00093	36 x 24 x 34"	Size 1
06-008-00092	18 x 28 x 34"	Size 2



PLC Cargo / Goods Trolley

Product Code	Dimension	Size
06-008-00094	29 x 19 x 34"	Size 1



CCK Stainless Steel Goods Trolley

Product Code	Dimension
06-008-00069	80 x 50 x 90cm



PLC Foldable Goods Trolley

Product Code	Dimension
06-008-00007	74 x 48 x 87cm
06-008-00008	90 x 60 x 90cm



JAPAN Metal Cargo / Goods Trolley

Product Code	Dimension	Size
06-008-00091	36 x 24 x 34"	Size 1
06-008-00090	18 x 28 x 34"	Size 2

**CAMBRO Slant Top Ingredient Bin**

Product Code	Dimension	Capacity	Colour
06-002-00004	33 x 75 x 71cm	81ℓ / 21gal	<input type="checkbox"/> White

**CAMBRO Slant Top Ingredient Bin**

Product Code	Dimension	Capacity	Colour
06-002-00005	42 x 75 x 71cm	102ℓ / 27gal	<input type="checkbox"/> White

**CAMBRO Slant Top Ingredient Bin**

Product Code	Dimension	Capacity	Colour
06-002-00006	55 x 75 x 71cm	140ℓ / 37gal	<input type="checkbox"/> White

**CAMBRO Vegetable Crisper**

Product Code	Dimension	Capacity
06-002-00014	56 x 61 x 58.8cm	121ℓ / 32gal

**CAMBRO Flat Top Ingredient Bin**

Product Code	Dimension	Capacity	Colour
06-002-00001	56 x 61 x 58.8cm	121ℓ / 32gal	<input type="checkbox"/> White
06-002-00002	39 x 75 x 74cm	129ℓ / 36gal	<input type="checkbox"/> White
06-002-00003	47 x 75 x 74cm	161ℓ / 44gal	<input type="checkbox"/> White

**TRUST Ingredient Bin with Sliding Lid and Scoop Hook**

Product Code	Dimension	Capacity	Colour
06-002-00011	74.3 x 33.4 x 71.1cm	80ℓ	<input type="checkbox"/> White
06-002-00012	74.3 x 39.4 x 71.1cm	100ℓ	<input type="checkbox"/> White
06-002-00013	74.3 x 45.7 x 71.1cm	120ℓ	<input type="checkbox"/> White

**CAMBRO Flat Top Ingredient Bin with Sliding Lid**

Product Code	Dimension	Capacity	Colour
06-002-00007	33 x 76.5 x 72.5cm	102ℓ / 27gal	<input type="checkbox"/> White

**JWINS Shelf Ingredient Bin with Lid and Scoop**

Product Code	Dimension	Capacity	Colour
06-002-00010	36.7 x 29.6 x 21.9cm	8ℓ	<input type="checkbox"/> White
06-002-00008	59.3 x 29 x 43.2cm	20ℓ	<input type="checkbox"/> White
06-002-00009	59.3 x 48.6 x 43.2cm	40ℓ	<input type="checkbox"/> White



CAMBRO Polypropylene Slotted Dunnage Rack

Product Code	Dimension	Colour
06-001-00309	76 x 53.3 x 30cm	Gray
06-001-00310	91.5 x 53.3 x 30cm	Gray
06-001-00311	122 x 53.3 x 30cm	Speckled Gray
06-001-00312	152.5 x 53.3 x 30cm	Speckled Gray



CAMBRO Polypropylene Solid Dunnage Rack

Product Code	Dimension	Colour
06-001-00313	76 x 53.3 x 30cm	Speckled Gray
06-001-00314	91.5 x 53.3 x 30cm	Speckled Gray
06-001-00315	122 x 53.3 x 30cm	Speckled Gray
06-001-00316	152.5 x 53.3 x 30cm	Speckled Gray



CAMBRO Dunnage Rack Accessory Camlink

Product Code
06-001-00317



JIWINS Vented Dunnage Rack

Product Code	Dimension
06-001-00318	36" x 12" x 9"
06-001-00319	48" x 21" x 9"



TRUST Dunnage Rack

Product Code	Dimension	Capacity	Colour
06-001-00320	122 x 61 x 30.5cm	Max load 900kg	Black



UNICA Plastic Stackable Container

Product Code	Dimension	Colour
06-004-00030	66 x 45 x 38.5cm	Blue
06-004-00031	66 x 45 x 38.5cm	Black



A-STAR Plastic Heavy Duty Nestable Basket with Metal Handles

Product Code	Dimension	Colour
06-004-00080	63.5 x 43.5 x 30cm	Blue
06-004-00081	63.5 x 43.5 x 30cm	Green
06-004-00082	63.5 x 43.5 x 30cm	Red



A-STAR Plastic Heavy Duty Nestable Container with Metal Handles

Product Code	Dimension	Colour
06-004-00013	62.5 x 43.2 x 30.2cm	Blue
06-004-00014	62.5 x 43.2 x 30.2cm	Green
06-004-00015	62.5 x 43.2 x 30.2cm	Red



UNICA Plastic Heavy Duty Nestable Basket with Metal Handles

Product Code	Dimension	Colour
06-004-00097	70 x 49 x 43cm	Blue
06-004-00098	70 x 49 x 43cm	Green
06-004-00099	70 x 49 x 43cm	Red



Plastic Stackable Food Container

Product Code	Dimension	Colour
06-004-00100(XX)	59.1 x 38.7 x 18.5cm	Blue
06-004-00101(XX)	59.1 x 38.7 x 18.5cm	Green
06-004-00102(XX)	59.1 x 38.7 x 18.5cm	Red
06-004-00103(XX)	59.1 x 38.7 x 18.5cm	Yellow



A-STAR Heavy Duty Plastic Rectangle Container

Product Code	Dimension
06-004-00104	50 x 39.5 x 16cm



UNICA Plastic Stackable Container

Product Code	Dimension	Colour
06-004-00048	34.5 x 27 x 12.7cm	Blue
06-004-00049	34.5 x 27 x 12.7cm	Gray
06-004-00054	43 x 26 x 13cm	Blue
06-004-00055	43 x 26 x 13cm	Gray
06-004-00058	46 x 36 x 15cm	Blue
06-004-00059	46 x 36 x 15cm	Gray
06-004-00074	66 x 45 x 23cm	Blue
06-004-00075	66 x 45 x 23cm	Gray
06-004-00076	66 x 45 x 23cm	Red



Plastic Stackable Container

Product Code	Dimension	Colour
06-004-00040	53 x 38.5 x 10cm	Blue
06-004-00041	55 x 38.5 x 24cm	Red
06-004-00042	55 x 38.5 x 24cm	Yellow



UNICA Plastic Stackable Container

Product Code	Dimension	Colour
06-004-00060	53 x 40 x 10cm	Gray
06-004-00062	53 x 40 x 8.6cm	Gray
06-004-00072	64 x 42 x 9cm	Blue
06-004-00073	64 x 42 x 9cm	Gray



UNICA Plastic Stackable Container

Product Code	Dimension	Colour
06-004-00046	23.5 x 14.8 x 12.2cm	Blue
06-004-00047	23.5 x 14.8 x 12.2cm	Gray
06-004-00050	34.6 x 20.9 x 14.5cm	Blue
06-004-00051	34.6 x 20.9 x 14.5cm	Gray



Plastic Stackable Container

Product Code	Dimension	Colour
06-004-00037	40 x 26 x 8cm	Blue
06-004-00038	40 x 26 x 8cm	Red
06-004-00039	40 x 26 x 8cm	Yellow



UNICA Plastic Stackable Container

Product Code	Dimension	Colour
06-004-00052	42 x 32 x 9cm	Blue
06-004-00053	42 x 32 x 9cm	Gray



UNICA Plastic Stackable Container

Product Code	Dimension	Colour
06-004-00070	64 x 42 x 16cm	Blue
06-004-00071	64 x 42 x 16cm	Gray



UNICA Plastic Stackable Container

Product Code	Dimension	Colour
06-004-00056	46 x 31 x 20cm	Blue
06-004-00057	46 x 31 x 20cm	Green



UNICA Plastic Stackable Container

Product Code	Dimension	Colour
06-004-00063	55 x 42.5 x 24cm	Blue
06-004-00064	55 x 42.5 x 24cm	Gray



UNICA Plastic Stackable Container

Product Code	Dimension	Colour
06-004-00065	60 x 45 x 22cm	Blue
06-004-00066	60 x 45 x 22cm	Gray
06-004-00067	60 x 45 x 32.5cm	Blue
06-004-00068	60 x 45 x 32.5cm	Gray



UNICA Plastic Stackable Container

Product Code	Dimension	Colour
06-004-00069	62 x 36.5 x 13.5cm	Blue



Plastic Stackable Container

Product Code	Dimension	Colour
06-004-00043	65.7 x 44.5 x 23.5cm	Green
06-004-00044	65.7 x 44.5 x 23.5cm	Red
06-004-00045	65.7 x 44.5 x 23.5cm	Yellow



A-STAR Plastic Heavy Duty Rectangle Container

Product Code	Dimension	Colour
06-004-00002	44 x 29 x 76cm	Blue



A-STAR Plastic Heavy Duty Rectangle Container

Product Code	Dimension	Colour
06-004-00003	56.5 x 38 x 7.6cm	Blue



A-STAR Plastic Heavy Duty Rectangle Container

Product Code	Dimension	Colour
06-004-00004	59.8 x 35.5 x 15.5cm	Blue



A-STAR Plastic Heavy Duty Rectangle Container

Product Code	Dimension	Colour
06-004-00005	64 x 39 x 18cm	Blue
06-004-00006	64 x 39 x 18cm	Red



A-STAR Plastic Heavy Duty Rectangle Container

Product Code	Dimension	Colour
06-004-00007	65.5 x 44.5 x 23cm	Blue
06-004-00008	65.5 x 44.5 x 23cm	Green
06-004-00009	65.5 x 44.5 x 23cm	Gray
06-004-00010	65.5 x 44.5 x 23cm	Red
06-004-00011	65.5 x 44.5 x 23cm	Yellow



Plastic Stackable Food Container

Product Code	Dimension	Colour
06-004-00078	49 x 37 x 9cm	Yellow
06-004-00079	53 x 40 x 8cm	Yellow



UNICA Plastic Translucent Lid

Product Code	Dimension	For
06-004-00026	46 x 36cm	06-004-00058/59
06-004-00033	53.5 x 40.5cm	06-004-00060/61/62
06-004-00034	55 x 43cm	06-004-00063/64
06-004-00035	61 x 46cm	06-004-00065/66
06-004-00032	65.5 x 42.5cm	06-004-00070/71/72/73
06-004-00036(XX)	67 x 46cm	06-004-00030/31/74/75/76/77



A-STAR Plastic Translucent Storage Container with Lid

Product Code	Dimension
06-004-00016	48.8 x 38 x 22.4cm
06-004-00017	56.8 x 41.6 x 26cm
06-004-00018	56.8 x 41.6 x 34cm
06-004-00019	56.8 x 41.6 x 39cm



A-STAR Plastic Industrial Container with Assembled Lid

Product Code	Dimension
06-004-00001	64.3 x 43 x 32.5cm



A-STAR Plastic Translucent Storage Container with Wheels

Product Code	Dimension
06-004-00020	57 x 41.5 x 41.2cm



UNICA Plastic Container with Lid

Product Code	Dimension	Colour
06-004-00027	48 x 33 x 27cm	Gray



A-STAR Plastic Storage Container with Lid

Product Code	Dimension	Colour
06-004-00021	44 x 30.2 x 20cm	Blue
06-004-00012	49.2 x 35 x 27.2cm	Blue



A-STAR Plastic Container with Translucent Lid

Product Code	Dimension	Colour
06-004-00028	42.5 x 28 x 20cm	Gray
06-004-00029	42.5 x 28 x 28cm	Gray



CAMBRO Polycarbonate Rectangle Pizza Dough Box

Product Code	Dimension	Colour	Matching Lid
06-003-00001	26 x 18 x 3"	White	06-003-00003
06-003-00002	26 x 18 x 6"	White	06-003-00003



CAMBRO Polypropylene Rectangle Pizza Dough Box

Product Code	Dimension	Colour	Matching Lid
06-003-00004	26 x 18 x 3"	White	06-003-00005





JIWINS Polypropylene Pizza Dough Box

Product Code	Dimension	Colour	Matching Lid
06-009-00137	65.5 x 45.5 x 8.6cm	White	06-009-00136
06-009-00138	65.5 x 45.5 x 16.3cm	White	06-009-00136

CAMBRO Dolly for Pizza Dough Boxes

Product Code	Dimension	Colour
06-003-00006	71 x 50.5 x 26cm	Beige



06-003-00041 06-003-00042 06-003-00043 06-003-00044 06-003-00045 06-003-00046 06-003-00047 06-003-00103/104/105

CAMBRO Polycarbonate Clear Storage Container, Camwear®

	Product Code	Dimensions	Capacity	Matching Lid
Square	06-003-00041	18.5 x 18.5 x 10cm	1.9ℓ / 2qt	06-003-00104
	06-003-00042	18.5 x 18.5 x 18.7cm	3.8ℓ / 4qt	
	06-003-00043	21.5 x 21.5 x 18.5cm	5.7ℓ / 6qt	06-003-00105
	06-003-00044	21.5 x 21.5 x 23cm	7.6ℓ / 8qt	
	06-003-00045	25.6 x 31 x 21cm	11.4ℓ / 12qt	06-003-00103
	06-003-00046	25.6 x 31 x 32cm	17.2ℓ / 18qt	
	06-003-00047	25.6 x 31 x 40cm	20.8ℓ / 22qt	



06-003-00086 06-003-00087 06-003-00088 06-003-00089 06-003-00090 06-003-00091 06-003-00092 06-003-00093 06-003-00094/95/96/97

CAMBRO Polycarbonate Clear Storage Container, Camwear®

	Product Code	Dimensions	Capacity	Matching Lid
Round	06-003-00086	Ø15.4 x 12.7cm	0.9ℓ / 1qt	06-003-00094
	06-003-00087	Ø20.8 x 11.1cm	1.9ℓ / 2qt	
	06-003-00088	Ø20.8 x 21.8cm	3.8ℓ / 4qt	06-003-00096
	06-003-00089	Ø25.2 x 20.2cm	5.7ℓ / 6qt	
	06-003-00090	Ø25.2 x 27.6cm	7.6ℓ / 8qt	06-003-00097
	06-003-00091	Ø37.8 x 21.3cm	11.4ℓ / 12qt	
	06-003-00092	Ø37.8 x 30.5cm	17.2ℓ / 18qt	
	06-003-00093	Ø37.8 x 38.1cm	20.8ℓ / 22qt	06-003-00095



CAMBRO Polypropylene Translucent Storage Container

	Product Code	Dimensions	Capacity	Matching Lid
Square	06-003-00055	18.5 x 18.5 x 10cm	1.9ℓ / 2qt	06-003-00100
	06-003-00056	18.5 x 18.5 x 18.7cm	3.8ℓ / 4qt	
	06-003-00057	21.5 x 21.5 x 18.5cm	5.7ℓ / 6qt	06-003-00101
	06-003-00058	21.5 x 21.5 x 23cm	7.6ℓ / 8qt	
	06-003-00059	25.6 x 31 x 21cm	11.4ℓ / 12qt	06-003-00098
	06-003-00060	25.6 x 31 x 32cm	17.2ℓ / 18qt	
	06-003-00061	25.6 x 31 x 40cm	20.8ℓ / 22qt	



CAMBRO Polypropylene Translucent Storage Container

	Product Code	Dimensions	Capacity	Matching Lid
Round	06-003-00073	Ø20.8 x 11.1cm	1.9ℓ / 2qt	06-003-00084
	06-003-00074	Ø20.8 x 21.8cm	3.8ℓ / 4qt	
	06-003-00075	Ø25.2 x 20.2cm	5.7ℓ / 6qt	06-003-00085
	06-003-00076	Ø25.2 x 27.6cm	7.6ℓ / 8qt	
	06-003-00077	Ø37.8 x 21.3cm	11.4ℓ / 12qt	06-003-00083
	06-003-00078	Ø37.8 x 30.5cm	17.2ℓ / 18qt	
	06-003-00079	Ø37.8 x 38.1cm	20.8ℓ / 22qt	



CAMBRO Polyethylene White Storage Container

	Product Code	Dimensions	Capacity	Matching Lid
Square	06-003-00048	18.5 x 18.5 x 10cm	1.9ℓ / 2qt	06-003-00100
	06-003-00049	18.5 x 18.5 x 18.7cm	3.8ℓ / 4qt	
	06-003-00050	21.5 x 21.5 x 18.5cm	5.7ℓ / 6qt	06-003-00101
	06-003-00051	21.5 x 21.5 x 23cm	7.6ℓ / 8qt	
	06-003-00052	25.6 x 31 x 21cm	11.4ℓ / 12qt	06-003-00098
	06-003-00053	25.6 x 31 x 32cm	17.2ℓ / 18qt	
	06-003-00054	25.6 x 31 x 40cm	20.8ℓ / 22qt	



CAMBRO Utility Box

	Dimension	Black	Dark Brown	Light Grey	Matching Lid
Rectangle	20 x 15 x 5"	06-008-00056	06-008-00057	06-008-00058	06-008-00067
	21 x 15 x 5"	06-008-00060	06-008-00061	06-008-00062	
	21 x 15 x 7"	06-008-00063	06-008-00064	06-008-00065	
	21 x 16 x 5"			06-008-00059	
	22 x 17 x 5"			06-008-00066	



CARLISLE Polycarbonate Food Storage Lid Storplus™

Dimension	Clear	Red	Green	Blue	Yellow
18 x 12"	06-003-00117	06-003-00118	06-003-00119	06-003-00120	06-003-00121
26 x 18"	06-003-00143	06-003-00144(XX)	06-003-00145	06-003-00146	06-003-00147



06-003-00159 06-003-00160 06-003-00161 06-003-00162 06-003-00163 06-003-00164 06-003-00165



06-003-00173 06-003-00174 06-003-00175

CARLISLE PC Storplus™ Square Food Container

	Product Code	Dimension	Capacity	Matching Lid
Square	06-003-00159	7.13 x 3.81"	1.9ℓ / 2qt	06-003-00173
	06-003-00160	7.13 x 7.31"	3.8ℓ / 4qt	
	06-003-00161	8.75 x 9"	5.7ℓ / 6qt	06-003-00174
	06-003-00162	8.75 x 9"	7.6ℓ / 8qt	
	06-003-00163	11.13 x 8.25"	11.4ℓ / 12qt	06-003-00175
	06-003-00164	11.13 x 12.56"	17.2ℓ / 18qt	
	06-003-00165	11.13 x 15.75"	20.8ℓ / 22qt	



06-003-00166 06-003-00167 06-003-00168 06-003-00169 06-003-00170 06-003-00171 06-003-00172



06-003-00173 06-003-00174 06-003-00175

CARLISLE Polyethylene White Storage Container

	Product Code	Dimension	Capacity	Matching Lid
Square	06-003-00166	7 x 7 x 4"	1.9ℓ / 2qt	06-003-00173
	06-003-00167	7 x 7 x 7"	3.8ℓ / 4qt	
	06-003-00168	9 x 9 x 7"	5.7ℓ / 6qt	06-003-00174
	06-003-00169	9 x 9 x 9"	7.6ℓ / 8qt	
	06-003-00170	11 x 11 x 8"	11.4ℓ / 12qt	06-003-00175
	06-003-00171	11 x 11 x 13"	17.2ℓ / 18qt	
	06-003-00172	11 x 11 x 16"	20.8ℓ / 22qt	



06-003-00149 06-003-00150 06-003-00151 06-003-00152



06-003-00153 06-003-00154 06-003-00155 06-003-00156 06-003-00157 06-003-00158

CARLISLE Polyethylene White Storage Container

	Product Code	Dimension	Capacity	Matching Lid
Rectangle	06-003-00149	18 x 12 x 4"	6.6ℓ / 7qt	06-003-00152
	06-003-00150	18 x 12 x 6"	11.4ℓ / 12qt	
	06-003-00151	18 x 12 x 9"	18ℓ / 19qt	
	06-003-00153	18 x 26 x 3.5"	18.9ℓ / 20qt	06-003-00158
	06-003-00154	18 x 26 x 6"	33.1ℓ / 35qt	
	06-003-00155	18 x 26 x 9"	49.2ℓ / 52qt	
	06-003-00156	18 x 26 x 12"	64.4ℓ / 68qt	
06-003-00157	18 x 26 x 15"	83.3ℓ / 88qt		



06-003-00182 06-003-00183 06-003-00184 06-003-00185 06-003-00186 06-003-00187

CARLISLE Polyethylene Translucent Storage Container

	Product Code	Dimension	Capacity	Matching Lid
Square	06-003-00182	7 x 7 x 4"	1.9ℓ / 2qt	06-003-00186
	06-003-00183	7 x 7 x 7"	3.8ℓ / 4qt	
	06-003-00184	9 x 9 x 7"	5.7ℓ / 6qt	06-003-00187
	06-003-00185	9 x 9 x 9"	7.6ℓ / 8qt	



CARLISLE Polyethylene Translucent Storage Container

	Product Code	Dimension	Capacity	Matching Lid
Rectangle	06-003-00188(XX)	14 x 8 x 13"	17.2ℓ / 18qt	06-003-00189(XX)



06-003-00211 06-003-00212 06-003-00213 06-003-00214 06-003-00215 06-003-00216 06-003-00217 06-003-00218



06-003-00207 06-003-00208 06-003-00209 06-003-00210

JIWINS Polycarbonate Clear Storage Container

	Product Code	Dimension	Capacity	Matching Lid
Round	06-003-00211	Ø5 x H5"	1ℓ / 1qt	06-003-00207
	06-003-00212	Ø7 x H4"	2ℓ / 2qt	06-003-00208
	06-003-00213	Ø8 x H9"	4ℓ / 4qt	
	06-003-00214	Ø9 x H8"	6ℓ / 6qt	06-003-00209
	06-003-00215	Ø11 x H9"	8ℓ / 8qt	
	06-003-00216	Ø8 x H12"	10ℓ / 10qt	06-003-00210
	06-003-00217	Ø12 x H12"	15ℓ / 15qt	
	06-003-00218	Ø15 x H12"	20ℓ / 21qt	



06-003-00204



06-003-00205



06-003-00206

JIWINS Translucent PP Square Food Container

	Product Code	Dimension	Capacity	Matching Lid
Square	06-003-00197	18 x 18 x 10cm	1.9ℓ / 2qt	06-003-00204
	06-003-00198	18 x 18 x 19cm	3.8ℓ / 4qt	
	06-003-00199	22.5 x 22.5 x 19cm	5.7ℓ / 6qt	06-003-00205
	06-003-00200	22.5 x 22.5 x 23cm	7.6ℓ / 8qt	
	06-003-00201	28.5 x 28.5 x 21cm	11.4ℓ / 12qt	06-003-00206
	06-003-00202	28.5 x 28.5 x 32cm	17.2ℓ / 18qt	
	06-003-00203	28.5 x 28.5 x 40cm	20.8ℓ / 22qt	



JIWINS Clear PC Square Food Container

Product Code	Dimension	Capacity
06-003-00190	18 x 18 x 10cm	1.9ℓ / 2qt
06-003-00191	18 x 18 x 19cm	3.8ℓ / 4qt
06-003-00192	22.5 x 22.5 x 19cm	5.7ℓ / 6qt
06-003-00193	22.5 x 22.5 x 23cm	7.6ℓ / 8qt
06-003-00194	28.5 x 28.5 x 21cm	11.4ℓ / 12qt
06-003-00195	28.5 x 28.5 x 32cm	17.6ℓ / 18qt
06-003-00196	28.5 x 28.5 x 40cm	20.8ℓ / 22qt



TRUST Polyethylene White Storage Huskee Container

Product Code	Dimension	Capacity	Matching Lid
06-002-00015	Ø40 x H44cm	38ℓ	06-002-00016
06-002-00017(XX)	Ø49 x H57cm	75ℓ	06-002-00021
06-002-00018(XX)	Ø56 x H70cm	121ℓ	06-002-00022



Polyethylene Utility Box

Product Code	Dimension
06-008-00076	54 x 38.5 x 17.5cm
06-008-00077	62 x 42.5 x 18cm



UNICA Plastic Utility Box

Product Code	Dimension
06-008-00074	48 x 35 x 17cm
06-008-00075	48 x 35 x 12cm



CAMBRO Round Crock Container with Lid

Product Code	Dimension	Capacity	Colour
06-003-00062	Ø13.3 x H13.7cm	1.1ℓ / 1.2qt	Clear
06-003-00063	Ø12.9 x H13.2cm	1.1ℓ / 1.2qt	Black
06-003-00064	Ø16.8 x H11cm	1.4ℓ / 1.5qt	Black
06-003-00065	Ø16.8 x H17.2cm	2.4ℓ / 2.7qt	Black

TRUST Utility Box

Product Code	Dimension
06-008-00072	50.8 x 38.1 x 12.7cm
06-008-00073	54.6 x 43.5 x 17.8cm



A-STAR Plastic Square Air-Tight Microwaveable Container with Blue Lid

Product Code	Dimension	Capacity
06-003-00010	21.5 x 21.5 x 8.8cm	3.04ℓ
06-003-00011	24 x 24 x 10cm	4.14ℓ
06-003-00012	28 x 28 x 11cm	6.5ℓ
06-003-00013	31.5 x 31.5 x 12cm	9.3ℓ



Plastic Rectangle Air-Tight Container with Lid

Product Code	Dimension	Capacity
06-003-00241	17.9 x 12.8 x 5.8cm	0.91ℓ
06-003-00243	20.6 x 14.8 x 6.8cm	1.4ℓ
06-003-00240	17.8 x 12.5 x 10.7cm	1.7ℓ
06-003-00242	20.6 x 14.8 x 13cm	2.92ℓ
06-003-00244	25.6 x 17.9 x 9.8cm	3.3ℓ
06-003-00245	26 x 17.9 x 15.3cm	5ℓ
06-003-00246	30.3 x 20.7 x 10.7cm	5.05ℓ
06-003-00247	30 x 20.7 x 16.5cm	7.9ℓ
06-003-00248	34.3 x 23.5 x 11.6cm	6.9ℓ
06-003-00250	39.6 x 26.7 x 12.6cm	10ℓ
06-003-00249	34.3 x 23.9 x 17.7cm	11ℓ
06-003-00251	39.6 x 26.7 x 19cm	15.8ℓ



A-STAR Plastic Rectangle Air-Tight Container with Lid

Product Code	Dimension	Capacity
06-003-00014	15.3 x 11 x 5.8cm	0.64ℓ
06-003-00015	15 x 11 x 9cm	0.96ℓ
06-003-00016	17.5 x 13 x 7.3cm	1.1ℓ
06-003-00017	17.5 x 12.6 x 11.5cm	1.86ℓ
06-003-00018	20.2 x 14.5 x 9cm	1.9ℓ
06-003-00019	19.6 x 14.2 x 14cm	2.82ℓ
06-003-00020	26.5 x 18.5 x 10cm	4.2ℓ
06-003-00021	27.5 x 16.5 x 13.3cm	4.42ℓ
06-003-00022	31 x 21.5 x 10.8cm	5.9ℓ
06-003-00023	34.5 x 24.5 x 12cm	8.5ℓ
06-003-00024	37 x 27.5 x 13.2cm	10.3ℓ



A-STAR Plastic Round Air-Tight Container with Lid

Product Code	Dimension	Capacity
06-003-00025	Ø13.3 x H16.5cm	1.6ℓ
06-003-00026	Ø16.3 x H18.3cm	2.9ℓ
06-003-00027	Ø18.7 x H22.5cm	4.5ℓ



BIKIPS Plastic Airtight Microwavable Round Food Container

Product Code	Dimension	Capacity
06-003-00038	Ø11 x H5.6cm	0.24ℓ
06-003-00039	Ø11 x H11cm	0.55ℓ



BIKIPS Plastic Airtight Cereal Container

Product Code	Dimension	Capacity
06-003-00040	24.5 x 11.7 x 24.8cm	4ℓ



BIKIPS Plastic Airtight Microwavable Food Containers

Product Code	Dimension	Capacity
06-003-00029	11 x 7.8 x 5.6cm	0.2ℓ
06-003-00030	15.6 x 11 x 5.6cm	0.5ℓ
06-003-00031	18.5 x 13 x 5.6cm	0.7ℓ
06-003-00032	15.6 x 11 x 11cm	1.1ℓ
06-003-00033	15.6 x 15.6 x 8.5cm	1.22ℓ
06-003-00034	18.5 x 13 x 7cm	1ℓ
06-003-00035	22 x 15.6 x 11cm	2.5ℓ
06-003-00036	26 x 18.5 x 13.8cm	4.8ℓ
06-003-00037	31.2 x 22 x 11cm	5.5ℓ
06-003-00028 (contains a drain shelf)	31.2 x 22 x 16.4cm	8.3ℓ



Plastic Rectangle Air-Tight Container with Lid

Product Code	Dimension	Capacity
06-003-00256	11.5 x 7.5 x 4cm	0.2ℓ
06-003-00257	14.5 x 10 x 4cm	0.4ℓ
06-003-00258	18.5 x 12 x 5.5cm	0.85ℓ
06-003-00259	21 x 14 x 6.5cm	1.3ℓ
06-003-00260	25 x 19 x 9cm	2.6ℓ
06-003-00261	30 x 23 x 10cm	4.5ℓ
06-003-00262	35 x 28 x 12cm	8ℓ
06-003-00263	40 x 32 x 14cm	12.5ℓ
06-003-00264	27 x 20 x 16.5cm	7.6ℓ
06-003-00265	32 x 25 x 19.5cm	13.4ℓ
06-003-00266	37 x 30 x 22.5cm	23.8ℓ
06-003-00267	42 x 34.5 x 22.5cm	31.9ℓ



TOYOGO Plastic Rectangle Container with Lid

Product Code	Dimension	Capacity
06-003-00222	24 x 11 x 6.5cm	1.7ℓ
06-003-00223	24 x 11 x 9cm	1.9ℓ
06-003-00224	24 x 11 x 13.5cm	2.9ℓ
06-003-00225	28.5 x 15.5 x 9cm	3.1ℓ
06-003-00226	28.5 x 15.5 x 11.5cm	3.9ℓ
06-003-00227	28.5 x 15.5 x 16cm	5.5ℓ
06-003-00228	32 x 19 x 12cm	6ℓ
06-003-00229	32 x 19 x 14cm	7.2ℓ
06-003-00230	32 x 19 x 18.5cm	9.6ℓ



Plastic Container

Product Code	Dimension	Capacity	Type
06-003-00253	17 x 17 x 11.5cm	2.5ℓ	Rectangle
06-003-00254	17 x 17 x 18cm	4ℓ	Square
06-003-00255	17 x 17 x 24cm	5.5ℓ	Square



Plastic Round Container with Lid

Product Code	Dimension	Capacity
06-003-00268	Ø13 x H13.5cm	1.6ℓ
06-003-00269	Ø15 x H17cm	3ℓ
06-003-00270	Ø18 x H19cm	4.5ℓ
06-003-00271	Ø22 x H22cm	8.3ℓ
06-003-00272	Ø26 x H26cm	11.4ℓ



TOYOGO Plastic Round Container with Screw Top Cover

Product Code	Dimension	Capacity
06-003-00219	Ø12.5 x H9cm	0.8ℓ
06-003-00220	Ø12.5 x H13cm	1.3ℓ
06-003-00221	Ø12.5 x H17.5cm	1.7ℓ



TOYOGO Plastic Round Container

Product Code	Dimension	Capacity
06-003-00231	Ø15.5 x H12.5cm	1.9ℓ
06-003-00232	Ø15.5 x H14.5cm	2.2ℓ
06-003-00233	Ø15.5 x H20cm	3.1ℓ
06-003-00234	Ø18.5 x H18cm	3ℓ
06-003-00235	Ø23 x H18.5cm	5ℓ
06-003-00236	Ø19 x H24.5cm	4.5ℓ
06-003-00237	Ø22 x H29cm	7ℓ
06-003-00238	Ø23 x H32cm	9ℓ
06-003-00239	Ø31 x H37cm	20ℓ



A-STAR Plastic Square Container with Red Lid

Product Code	Dimension	Capacity
06-003-00008	11.2 x 11.2 x 9.5cm	0.75ℓ
06-003-00009	10 x 8.7 x 7cm	0.4ℓ



Plastic Square Container

Product Code	Dimension	Capacity
06-003-00252	11 x 11 x 10cm	1ℓ



Acrylic Clear Container

Product Code	Dimension	Capacity
06-003-00305	Ø4.4 x H9.5cm	0.07ℓ
06-003-00304	Ø5.5 x H10.5cm	0.1ℓ
06-003-00303	Ø7.2 x H13cm	0.19ℓ
06-003-00302	Ø8.6 x H15cm	0.34ℓ
06-003-00301	Ø9.5 x H17cm	0.47ℓ
06-003-00300	8.7 x 8.7 x 16.5cm	0.52ℓ



MYE Round Glass Jar with Acacid Wd Lid

Product Code	Dimension	Capacity
06-003-00280	Ø9 x H7.5cm	0.325ℓ
06-003-00281	Ø9 x H10.4cm	0.5ℓ
06-003-00282	Ø9 x H15cm	0.75ℓ
06-003-00284	Ø9 x H19.4cm	1ℓ



Glass Storage Jar with Metallic Cap

Product Code	Dimension	Capacity
06-003-00295	23 x 32.5cm	10.5ℓ



Glass Storage Jar with Metallic Cap

Product Code	Dimension	Capacity
06-003-00289	11 x 27.5cm	2.5ℓ
06-003-00290	16 x 23cm	4.5ℓ
06-003-00291	16 x 26cm	5ℓ
06-003-00292	18 x 20.5cm	5ℓ
06-003-00293	18 x 27.5cm	7ℓ
06-003-00294	18 x 32cm	9ℓ



LE PARFAIT Glass Preserving Jar with Clip, Bocaux Super

Product Code	Dimension	Capacity
06-003-00331	Ø7cm	0.25ℓ
06-003-00328	Ø8.5cm	0.5ℓ
06-003-00326	Ø8.5cm	1.5ℓ
06-003-00339	Ø8.5cm	2ℓ
06-003-00324	Ø10cm	3ℓ



LE PARFAIT Glass Preserving Jar with Clip, Terrines Super

Product Code	Dimension	Capacity
06-003-00327	Ø7cm	0.125ℓ
06-003-00325	Ø7cm	0.2ℓ
06-003-00338	Ø8.5 x H9cm	0.35ℓ
06-003-00333	Ø10cm	0.75ℓ
06-003-00332	Ø10cm	1ℓ



LE PARFAIT Glass Preserving Jar with Screw Top, Terrines Familia

Product Code	Dimension	Capacity
06-003-00335	Ø8.2 x H7cm	0.2ℓ
06-003-00336	Ø10 x H8cm	0.35ℓ
06-003-00337	Ø10 x H10cm	0.5ℓ
06-003-00319	Ø10 x H18cm	1ℓ
06-003-00329	Ø10 x H22cm	1.5ℓ



LE PARFAIT Rubber Ring Puller

Product Code	Packaging
06-003-00330	50pcs/pkt



LE PARFAIT Rubber Seals, Super

Product Code	Packaging	For
06-003-00334	10pcs/pkt	Ø7cm
06-003-00340	10pcs/pkt	Ø8.5cm
06-003-00315	10pcs/pkt	Ø10cm



ARCOROC RONDO Glass Jar

Product Code	Dimension	Capacity
06-003-00285	Ø9.5x H9.9cm	0.5ℓ / 16.75oz
06-003-00286	Ø9.5x H13.4cm	0.75ℓ / 25.25oz
06-003-00287	Ø9.5x H16.5cm	1ℓ / 33.75oz



Stainless Steel Condiment Dispenser with Bottle Holder

Product Code	Dimension	Capacity
06-009-00057(XX)	45 x 10.5 x 15.5cm	6 compartments



SAN JAMAR Stainless Steel Condiment Dispenser Ez-Chill®

Product Code	06-009-00039	06-009-00040	06-009-00041	06-009-00048(XX)
Dimension	20.3 x 63.8 x 19.4cm	20.3 x 32.4 x 41.3cm	20.3 x 64.1 x 41.9cm	32.4 x 53 x 30.5cm
Capacity				3 x 0.95ℓ, 12 x 0.47ℓ
Add. Info.	4x1/6pans, 2 flex lids, 4 ez-chill ice packs	3x1/9pans, 2x1/6pans, tongs, 4 ez-chill ice packs	8x1/6pans, 4 flex lids, 8 ez-chill ice packs	3x1qt, 12x1pt, 2 bar caddies, 6 ez-chill ice packs



SAN JAMAR Self-Service Condiment Center

Product Code	06-009-00051(XX)
Dimension	35.6 x 57.2 x 30.8cm
Capacity	4 x 0.95ℓ, 2 x 2.4ℓ
Add. Info.	4x1qt inserts with notched lids and spoons, 2x2.5qt black jars with ultra pumps



SAN JAMAR Universal Countertop Box System Frontline™

Product Code	06-009-00054(XX)
Dimension	Ø20.6 x H24.1cm
Capacity	0.65ℓ / 7qt
Colour	■ Black



SAN JAMAR Accessory Round Inset Container Frontline™

Product Code	06-009-00049(XX)
Dimension	Ø24cm
Capacity	0.65ℓ / 7qt
Colour	■ Gray



SAN JAMAR Stainless Steel Condiment Dispenser Ez-Chill®

Product Code	06-009-00045	06-009-00046
Dimension	31.8 x 25.7 x 20cm	31.8 x 35.6 x 20cm
Capacity	2 x 2.4ℓ	3 x 2.4ℓ
Add. Info.	2 x 2.5qt jars with ultra pumps	3 x 2.5qt jars with ultra pumps



SAN JAMAR Condiment Pump Box Ez-Chill®

Product Code	06-009-00047	06-009-00052
Dimension	26.7 x 17.8 x 18.1cm	43.8 x 17.8 x 18.1cm
Capacity	4ℓ	4ℓ
Add. Info.	For #10can, 1 ez-chill ice pack	1 ultra pump, 1 ez-chill ice pack



CAMBRO Fixed Nozzle Pump and Cover Kit

Product Code	Dimension
06-009-00035	18.4 x 29.5 x 29.8cm

CAMBRO Standard Pump and Lid Kit

Product Code	Dimension	Capacity
06-009-00036	18.4 x 22.8 x 28.5cm	Per portion 29.5ml

CAMBRO Maxi Pump and Lid Kit

Product Code	Dimension	Add. Info.
06-009-00038	18.4 x 26 x 31.4cm	For chunky condiments

SAN JAMAR Stainless Steel Pump for 06-009-00044

Product Code	Dimension	Add. Info.
06-009-00043	25.7 x 11 x 17.8cm	For use with 2.5qt jar (06-009-00044)

SAN JAMAR Plastic Fountain Jar for 06-009-00043

Product Code	06-009-00044
Capacity	2.5qt
Colour	Black
Add. Info.	For use with stainless steel pump (06-009-00043)

SAN JAMAR Ultra Pump

Product Code	06-009-00042
Dimension	2 pumps per packet
Capacity	1oz portion
Add. Info.	Pump only

SCHNEIDER Acrylic 4 Compartments Ice Cream Cone Holder

Product Code	Dimension	Capacity
06-009-00103(XX)	25 x 9 x 9.5cm	Ø3.4cm

SCHNEIDER Stainless Steel 3 Compartments Ice Cream Cone Holder

Product Code	Dimension	Capacity
06-009-00104(XX)	20 x 9.5 x 8.5cm	Ø2.6cm

SAN JAMAR Wall Mount Ice Cream Cone Dispenser

Product Code	Dimension
06-009-00102(XX)	77.8 x 15.2cm



DOT-IT Food Labels Dissolve-It (Square)

Product Code	Dimension	Capacity	Text
06-005-00006	Ø1.9cm	1000/roll	Sunday
06-005-00007	Ø1.9cm	1000/roll	Monday
06-005-00008	Ø1.9cm	1000/roll	Tuesday
06-005-00009	Ø1.9cm	1000/roll	Wednesday
06-005-00010	Ø1.9cm	1000/roll	Thursday
06-005-00011	Ø1.9cm	1000/roll	Friday
06-005-00012	Ø1.9cm	1000/roll	Saturday



DOT-IT Food Labels Dissolve-It (Triangle)

Product Code	Dimension	Capacity	Text
06-005-00013	5 x 5cm	250/roll	Sunday
06-005-00014	5 x 5cm	250/roll	Monday
06-005-00015	5 x 5cm	250/roll	Tuesday
06-005-00016	5 x 5cm	250/roll	Wednesday
06-005-00017	5 x 5cm	250/roll	Thursday
06-005-00018	5 x 5cm	250/roll	Friday
06-005-00019	5 x 5cm	250/roll	Saturday



DOT-IT Food Labels Mighty Peel (Circle)

Product Code	Dimension	Capacity	Text
06-005-00020	Ø5cm	1000/roll	Sunday
06-005-00021	Ø5cm	1000/roll	Monday
06-005-00022	Ø5cm	1000/roll	Tuesday
06-005-00023	Ø5cm	1000/roll	Wednesday
06-005-00024	Ø5cm	1000/roll	Thursday
06-005-00025	Ø5cm	1000/roll	Friday
06-005-00026	Ø5cm	1000/roll	Saturday



DOT-IT Food Labels Dissolve-It (Triangle)

Product Code	Dimension	Capacity	Text
06-005-00027	5 x 5cm	500/roll	Sunday
06-005-00028	5 x 5cm	500/roll	Monday
06-005-00029	5 x 5cm	500/roll	Tuesday
06-005-00030	5 x 5cm	500/roll	Wednesday
06-005-00031	5 x 5cm	500/roll	Thursday
06-005-00032	5 x 5cm	500/roll	Friday
06-005-00033	5 x 5cm	500/roll	Saturday

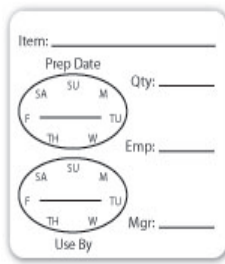

DOT-IT Day Clock Calendar Label Dissolve-It

Product Code	Dimension	Capacity
06-005-00034	5.1 x 5.1cm	250/roll



DOT-IT Food Label Dispensers

Product Code	Dimension	Capacity
06-005-00035	20.5 x 16 x 11cm	For 7 rolls of Ø1.9cm labels
06-005-00036	42.5 x 16 x 11cm	For 7 rolls of L5.1cm dispensers



DOT-IT Food Print Labelling Gun

Product Code
06-005-00037

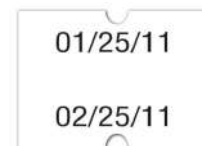

DOT-IT Marking Gun Label Roll

Product Code	Colour
06-005-00045	<input type="checkbox"/> White

ACCESSORIES:

- Ink Refill: 06-005-00042



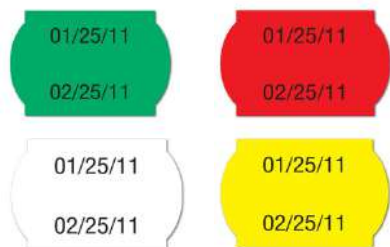

DOT-IT Food Print Labelling Gun Label Roll

Product Code	Capacity	Colour
06-005-00038	1125/roll	Green
06-005-00039	1125/roll	Red
06-005-00040	1125/roll	White
06-005-00041	1125/roll	Yellow



SAN JAMAR Cling Film and Aluminium Foil Dispenser SAF-T Wrap®

Product Code	Dimension	Add. Info.
06-005-00002	70 x 22 x 21cm	Film/foil rolls 30-45cm width. Max dia 12.95cm date rolls 1.9-7.6cm width. Max dia 8.25cm



CAMBRO Adjustable Dish Caddy

Product Code	Dimension	Colour
06-006-00001	96 x 73 x 81cm	Black
06-006-00002	96 x 73 x 81cm	Dark Brown
06-006-00003	96 x 73 x 81cm	Speckled Gray



CAMBRO Vinyl Cover for Adjustable Dish Caddy

Product Code
06-006-00004(XX)



CAMBRO Adjustable Tray and Dish Cart

Product Code	Dimension	Colour
06-006-00013	99 x 59 x 88cm	Coffee Beige



EDLUND Cling Film and Aluminium Foil Dispenser

Product Code	Add. Info.
06-005-00001(XX)	For 30-45cm width foil / film



TABLECRAFT Cling Film and Aluminium Foil Dispenser

Product Code	Dimension	Add. Info.
06-005-00004	56 x 18.5 x 20cm	For 30-45cm width foil / film with max. diameter of 12.95cm



SAN JAMAR SAF-T Wrap® Stacker

Product Code	Dimension	Add. Info.
06-005-00003	19.5 x 41.8 x 23.5cm	Dispense film/foil rolls from 30.5-45.7cm



TRUST Adjustable Dish Caddy

Product Code	Dimension	Colour
06-006-00017	68 x 68 x 81cm	Dark Brown
06-006-00018	68 x 68 x 81cm	Speckled Gray



CAMBRO Tray and Silverware Cart

Product Code	Dimension	Colour
06-006-00014(XX)	82 x 54 x 116cm	Black
06-006-00015(XX)	82 x 54 x 116cm	Dark Brown
06-006-00016(XX)	97 x 58 x 105cm	Black



CAMBRO Dish Caddy (Fit 7" Plate)

Product Code	Dimension	Colour
06-006-00006	83 x 60 x 81cm	Dark Brown



CAMBRO Dish Caddy (Fit 8.25" Plate)

Product Code	Dimension	Colour
06-006-00007(XX)	73 x 60.5 x 81.5cm	Dark Brown
06-006-00008	73 x 60.5 x 81.5cm	Granite Gray



CAMBRO Dish Caddy (Fit 9.5" Plate)

Product Code	Dimension	Colour
06-006-00011	78 x 69 x 81cm	Dark Brown
06-006-00012	78 x 69 x 81cm	Speckled Gray



CAMBRO Dish Caddy (Fit 11.25" Plate)

Product Code	Dimension	Colour
06-006-00009	78 x 69 x 81cm	Dark Brown
06-006-00010(XX)	78 x 69 x 81cm	Black



CAMBRO Dish Caddy (Fit 12.25" Plate)

Product Code	Dimension	Colour
06-006-00005	83 x 70 x 81.5cm	Dark Brown

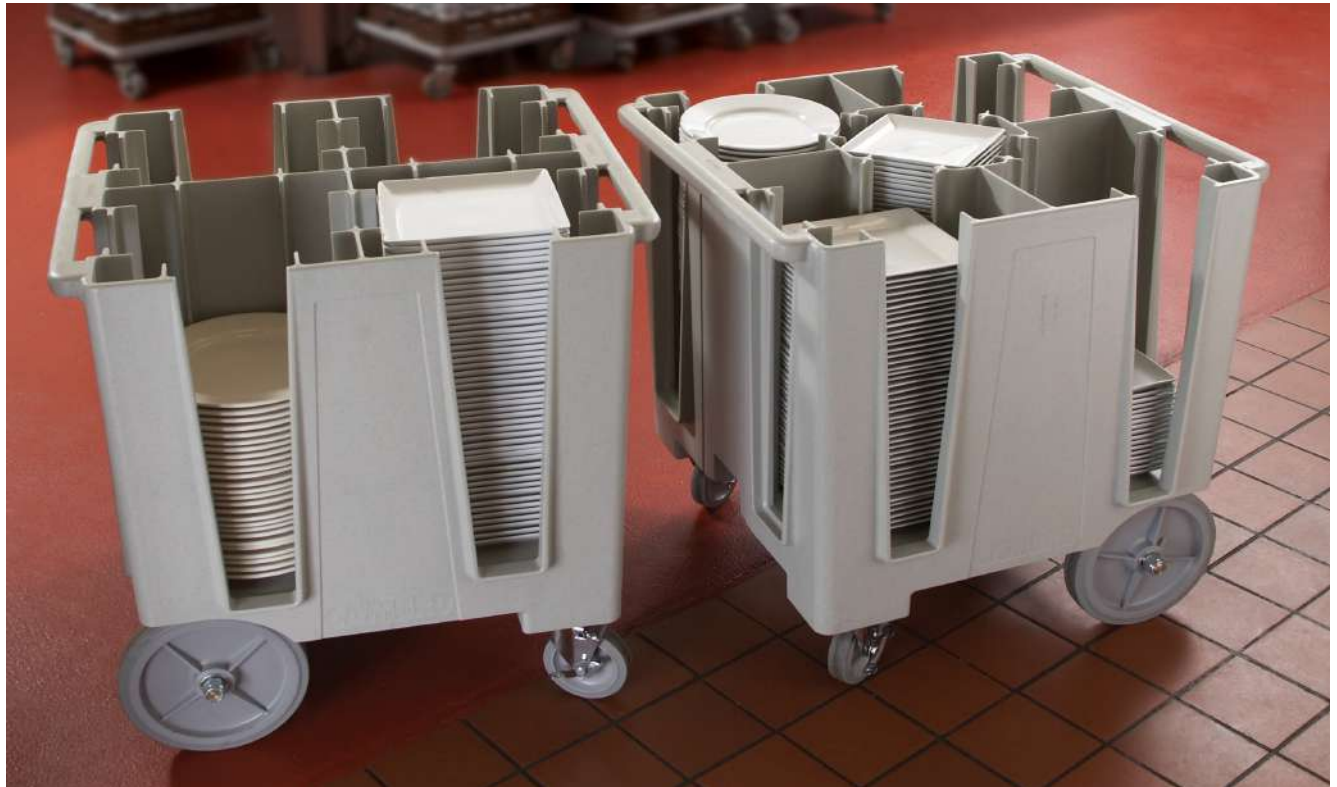

Rack Size Chart

Cambro

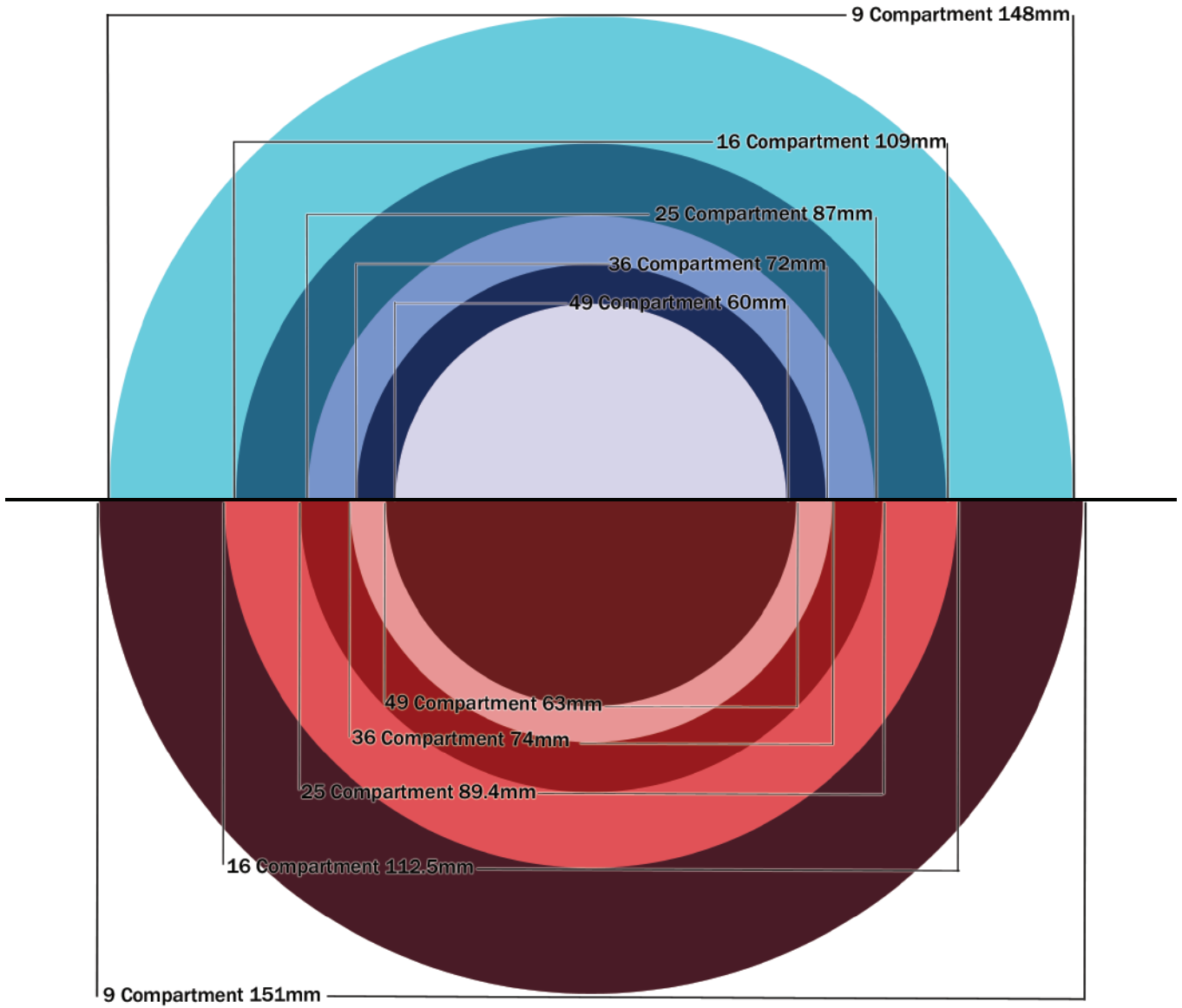

Goldplas



06-006-00051



06-006-00204(XX)



06-006-00157(XX)



06-006-00047



06-006-00048

CAMBRO Glass Rack (50 x 25cm)

No. of Compartments	Base Rack	Half Size Open Extender	Full Drop Extender	Half Drop Extender	Dolly w/o Handle	Dolly w/ Handle
8 (W10.5cm)			06-006-00157(XX)	06-006-00158(XX)		
10 (W8.8cm)	06-006-00051	06-006-00204(XX)	06-006-00054(XX)	06-006-00055(XX)	06-006-00047	06-006-00048
17 (W7.4cm)			06-006-00085(XX)	06-006-00086(XX)		



06-006-00046



06-006-00033



06-006-00039



06-006-00040



06-006-00048



06-006-00049

CAMBRO Glass Rack (50 x 50cm)

No. of Compartments	Base Rack	Full Size Open Extender	Full Drop Extender	Half Drop Extender	Dolly w/o Handle	Dolly w/ Handle	Rack Cover
9 (W15cm)			06-006-00027	06-006-00028	06-006-00306	06-006-00309	06-006-00049
16 (W11.1cm)			06-006-00039	06-006-00040			
25 (W8.9cm)	06-006-00046	06-006-00033	06-006-00041	06-006-00042			
36 (W7.3cm)			06-006-00043	06-006-00044			
49 (W6.2cm)			06-006-00144(XX)	06-006-00145(XX)			



06-006-00284



06-006-00303



06-006-00298



06-006-00292

UNICA Glass Rack (50 x 50cm)

No. of Compartments	Base Rack	Full Drop Open Extender	Extender	Rack Cover
9 (W15cm)	06-006-00284(XX)			06-006-00292(XX)
16 (W11.1cm)	06-006-00251(XX)		06-006-00298(XX)	
25 (W8.9cm)	06-006-00264(XX)	06-006-00303	06-006-00300	
36 (W7.3cm)	06-006-00271(XX)		06-006-00301(XX)	
49 (W6.2cm)	06-006-00278(XX)		06-006-00302(XX)	



06-006-00021



06-006-00022



06-006-00155



06-006-00053



06-006-00047



06-006-00048



06-006-00049

CAMBRO Cup Rack

Type	No. of Compartments	Base Rack	Half Drop Extender	Open Extender	Dolly w/o Handle	Dolly w/ Handle	Rack Cover
50 x 50cm	16 (W11.1cm)			06-006-00040	06-006-00047	06-006-00048	06-006-00049
	20 (W8.8cm)	06-006-00021		06-006-00022			
50 x 25cm	8 (W10.4cm)	06-006-00155(XX)	06-006-00158(XX)				
	10 (W8.8cm)	06-006-00053(XX)	06-006-00055(XX)				



06-006-00219

06-006-00216

06-006-00208

06-006-00215

06-006-00222



06-006-00227



06-006-00228



06-006-00221

GOLDPLAS Glass Rack / Cup Racks

No. of Compartments	Base Rack	Full Size Open Extender	Full Drop Extender	Half Drop Extender	Dolly w/o Handle	Handle	Rack Cover
Glass Racks							
9 (W15cm)			06-006-00214	06-006-00215	06-006-00227	06-006-00228	06-006-00221
16 (W11.1cm)			06-006-00206	06-006-00207			
25 (W8.9cm)	06-006-00219	06-006-00216	06-006-00208	06-006-00209			
36 (W7.3cm)			06-006-00210	06-006-00211			
49 (W6.2cm)			06-006-00212	06-006-00213			
Cup Racks							
16 (W11.1cm)	06-006-00222						
20 (W8.8cm)	06-006-00223						

*Full size Base Rack available in 4 colours: ■ 06-006-00219 ■ 06-006-00217 ■ 06-006-00218 ■ 06-006-00220

**CAMBRO 8-Compartment Flatware Dishwashing Basket with Handles**

Product Code	Colour
06-006-00025	■ Soft Gray

**CAMBRO 8-Compartment Flatware Dishwashing Basket without Handles**

Product Code	Colour
06-006-00026	■ Soft Gray

**UNICA 8-Compartment Cutlery Dishwashing Basket with Handles**

Product Code	Dimension	Colour
06-006-00244	45 x 19.5 x 32cm	■ Gray

**UNICA 8-Compartment Cutlery Dishwashing Basket without Handles**

Product Code	Colour
06-006-00250(XX)	■ Gray

**CAMBRO Full Peg Plate / Tray Rack**

Product Code	Colour
06-006-00036	■ Soft Gray

**CAMBRO Full Peg Plate / Tray Rack with Extender**

Product Code	Colour
06-006-00037	■ Soft Gray



CAMBRO Full Peg Rack with Extender

Product Code	Colour
06-006-00038	Soft Gray



UNICA Plates and Trays Dishwashing Peg Rack (Standard)

Product Code	Dimension
06-006-00246	50 x 50 x 10cm



UNICA Plates and Trays Dishwashing Peg Rack (Open End)

Product Code	Dimension
06-006-00247	50 x 50 x 10cm



CAMBRO Full Flatware Rack

Product Code	Colour
06-006-00034	Beige
06-006-00050	Soft Gray



GOLDPLAS Full Size Flatware Rack

Product Code	Colour
06-006-00224	Gray



CAMBRO Half Flatware Rack

Product Code	Colour
06-006-00035	Soft Gray



CAMBRO Cup Keeper (Regal)

Product Code	Dimension	Colour
06-006-00205(XX)	14" x 18"	Beige



GOLDPLAS Open Tray Rack

Product Code	Colour
06-006-00225	Gray



THERMOFUTURE BOX Accessory Trolley for Frontloader 60x40

Product Code	Dimension
06-006-00243(XX)	70 x 50 x 17cm



UNICA Cutlery Dishwashing Rack

Product Code	Dimension
06-006-00245	50 x 50 x 10cm



UNICA Plastic Rack Cutlery Holder

Product Code	Dimension
06-006-00291(XX)	10.8 x 10.8 x 13.8cm



CAMBRO Dolly with Handle for Dish Rack

Product Code	Dimension	Colour
06-006-00175(XX)	65.7 x 56.5 x 93.7cm	Dark Brown



UNICA Rack Dust Cover

Product Code	Dimension
06-006-00304(XX)	55 x 55 x 122cm



UNICA Rack Clip Tag

Product Code	Colour	Capacity
06-006-00293(XX)	Blue	50pc/pkt
06-006-00294(XX)	Green	50pc/pkt
06-006-00295(XX)	Red	50pc/pkt
06-006-00296(XX)	White	50pc/pkt
06-006-00297(XX)	Yellow	50pc/pkt

Tags can be easily clipped on to all base racks for users to identify the items in each rack.



CAMBRO 12-Compartment Flatware and Condiment Organizer

Product Code	Dimension	Colour
06-009-00003	64.8 x 54.3 x 36.2cm	Speckled Gray



CAMBRO Polyethylene 8-Compartment Flatware and Condiment Organizer

Product Code	Dimension	Colour
06-009-00007	64.8 x 48.8 x 24.1cm	Speckled Gray



CAMBRO Polyethylene 9-Compartment Flatware and Condiment Organizer

Product Code	Dimension	Colour
06-009-00008	51.1 x 54.3 x 36.2cm	Black
06-009-00009	51.1 x 54.3 x 36.2cm	Speckled Gray



CAMBRO Polyethylene 6-Compartment Flatware and Condiment Organizer

Product Code	Dimension	Colour
06-009-00004	51.1 x 48.8 x 24.1cm	Black
06-009-00006	51.1 x 48.8 x 24.1cm	Speckled Gray



CAMBRO Polyethylene Organizer Bin

Product Code	Dimension	Colour
06-009-00010	13 x 30.5 x 11cm	Dark Brown
06-009-00011	13 x 30.5 x 11cm	Speckled Gray
06-009-00012(XX)	13 x 30.5 x 11cm	Black



JIWINS VERSA Polypropylene Organizers Box, Spot Dust

Product Code	Dimension
06-009-00131	29.3 x 12.7 x 10.9cm



JIWINS VERSA PP+Aluminium Organizers Box

Product Code	Dimension	For
06-009-00132	44 x 31 x 30cm	6 Organizers
06-009-00133	56.8 x 31 x 30cm	8 Organizers
06-009-00134	44 x 31 x 47.5cm	9 Organizers
06-009-00135	56.8 x 31 x 47.5cm	12 Organizers



JIWINS Polypropylene 4-Compartment Flatware Utility Box

Product Code	Dimension	Colour
06-009-00016	52 x 29 x 10cm	Black
06-009-00017	52 x 29 x 10cm	Gray



EVELIN 4-Compartment Gastro Cutlery Tray

Product Code	Dimension	Hand Made Finishing
06-006-00310	52 x 29.5 x 10cm	Hand Made Finishing



Stainless Steel Cutlery Cylinder (with Holes)

Product Code	Dimension
06-009-00021	Ø9.5 x H13.5cm



Stainless Steel Cutlery Organizer with Stainless Steel Baskets

Product Code	Dimension	Configuration
06-009-00025	38.5 x 15 x 18cm	3 Compartments
06-009-00026	50.5 x 15 x 18cm	4 Compartments



CAMBRO 4-Compartment Flatware Utility Box

Product Code	Dimension	Colour
06-009-00001	52 x 28.9 x 9.5cm	Black
06-009-00002	52 x 28.9 x 8.5cm	Light Gray



SUNNEX Polyethylene 4-Compartment Cutlery Box

Product Code	Colour
06-009-00018	Gray



Stainless Steel Cutlery Cylinder (without Holes)

Product Code	Dimension
06-009-00020	Ø9.5 x H13.5cm



Stainless Steel Cutlery Organizers

Product Code	Dimension	Configuration
06-009-00022	26.5 x 30.5 x 20cm	4 Compartments
06-009-00023	38.5 x 30.5 x 20cm	6 Compartments
06-009-00024	50.5 x 30.5 x 20cm	8 Compartments



Stainless Steel Cutlery Organizer with Plastic Baskets

Product Code	Dimension	Configuration
06-009-00027	50.5 x 15 x 18cm	1 x 4
06-009-00028	26.5 x 30.5 x 20cm	2 x 2
06-009-00029	38.5 x 30.5 x 20cm	2 x 3
06-009-00034(XX)	38.5 x 15 x 18cm	1 x 3



Stainless Steel Square Chopstick Holder

Product Code	Dimension
06-009-00031	7.5 x 7 x 15.5cm



Stainless Steel Round Chopstick Holder

Product Code	Dimension
06-009-00032	Ø10 x H16cm
06-009-00033	Ø12.5 x H16cm



CCK Stainless Steel Chopstick Holder

Product Code	Dimension
06-009-00013	9 x 13cm
06-009-00014	10 x 16.5cm
06-009-00015	13 x 16.5cm



Plastic Cutlery Basket

Product Code	Dimension
06-009-00030	Ø11.5 x H14.5cm



SAN JAMAR Polystyrene Lid Towers

Product Code	Dimension	Capacity
06-009-00092(XX)	47.6 x 14 x 33cm	2 lid compartments, 1 straw compartment
06-009-00093	62.2 x 14 x 33cm	3 lid compartments, 1 straw compartment



SAN JAMAR Lid Dispenser Cabinets with Black Trim Rings Ez-Fit®

Product Code	Dimension	Capacity
06-009-00091(XX)	38.4 x 19.7 x 64.5cm	1 x (70-95mm) lid dispenser, 1 x (95-114mm) lid dispenser



SAN JAMAR In-Counter Lid Dispenser EZ-Fit®

Product Code	Dimension	Capacity
06-009-00089(XX)	Ø12.4 x H60.3cm	For 24-46oz (720-1380mℓ)
06-009-00090(XX)	Ø14.6 x H60.3cm	



SAN JAMAR Stainless Steel Wall Mount Lid Dispenser

Product Code	Dimension	Capacity	Lid Rim
06-009-00095	59.7cm	For 6-10oz (180ml-300mℓ)	89mm
06-009-00096(XX)	59.7cm	For 12-24oz (360-720mℓ)	101mm



SAN JAMAR Stainless Steel Adjustable Lid Organizer

Product Code	Dimension	Capacity
06-009-00094	16.5 x 43.5 x 13cm	3 Stacks



SAN JAMAR Cup Dispenser and Lid Organizer Wireworks™

Product Code	Dimension	Capacity
06-009-00085	49.2 x 16.2 x 46.4cm	For 8-44oz (240-1320mℓ) 2 cup dispensers, 1 lid organizer



SAN JAMAR Dispenser and Lid Organizer Wireworks™

Product Code	Dimension	Capacity
06-009-00086	62 x 16.2 x 46.4cm	For 8-44oz (240-1320ml) 3 cup dispensers, 1 lid organizer



SAN JAMAR Cup and Lid Dispenser Stand

Product Code	Dimension	Capacity
06-009-00084(XX)	Ø25.4 x H92cm	Suitable for stainless steel pull type cup dispensers



SAN JAMAR Accessory Spindles for Dom Lid Wireworks™

Product Code
06-009-00060(XX)

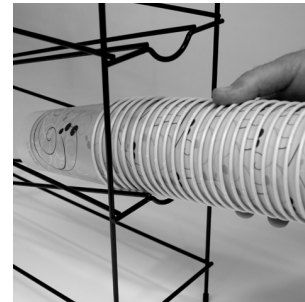

SAN JAMAR Accessory Lid Organizer for Wireworks™ Cup Dispenser

Product Code
06-009-00059



SAN JAMAR In-Counter Adjustable Cup Dispenser Sentry®

Product Code	Dimension	Capacity
06-009-00087	Ø13.4 x H59.7cm	For 8-44oz (240-1320ml) Cup rim diameter 79-114mm



SAN JAMAR In-Counter Cup Dispenser Euro Sentry®

Product Code	Dimension	Capacity
06-009-00088	Ø12.4 x H59.7cm	For 4-24oz (120-720ml) Cup rim diameter 62-92mm



SAN JAMAR Counter Mount Adjustable Cup Dispenser

Product Code	Dimension	Capacity
06-009-00070	Ø11.9 x H59.7cm	For 12-24oz (360-720ml) Cup rim diameter 70-98mm
06-009-00071	Ø14.4 x H59.7cm	For 32-46oz (960-1380ml) Cup rim diameter 101-124mm



SAN JAMAR Counter Mount Stainless Steel Adjustable Cup Dispenser

Product Code	Dimension
06-009-00074(XX)	Ø10.6 x H59.7cm

SAN JAMAR Counter / Surface Mount Cup Dispenser EZ-Fit®

Product Code	Dimension	Capacity	
06-009-00076	Ø14.6 x H45.7cm	For 8-46oz (240-1380ml)	Cup rim diameter 73-121mm
06-009-00075	Ø14.6 x H59cm	For 8-46oz (240-1380ml)	Cup rim diameter 73-121mm
06-009-00072(XX)	Ø16.8 x H57.2cm	For 32-46oz (960-1380ml)	Cup rim diameter 124-143mm
06-009-00073(XX)	Ø8.3 x H40.6cm	For 0.5-2.5oz (15-70ml)	Cup rim diameter 38-59mm

SAN JAMAR Wall Mount Pull-Type Adjustable Cup Dispenser

Product Code	Dimension	Capacity	
06-009-00099	59.7cm	For 6-10oz (180-300ml)	Cup rim diameter 56-81mm
06-009-00100	59.7cm	For 12-24oz (360-720ml)	Cup rim diameter 70-98mm
06-009-00101(XX)	59.7cm	For 32-46oz (960-1380ml)	Cup rim diameter 101-124mm

SAN JAMAR Wall Mount Medium Pull-Type Plastic Cup Dispenser (Arctic Blue)

Product Code	Dimension	Capacity	
06-009-00097(XX)	40.6cm	For 4-10oz (120-300ml)	Cup rim diameter 64-83mm

SAN JAMAR Wall Mount Plastic Pull-Type Cup Dispenser (Transparent Bronze)

Product Code	Dimension	Capacity
06-009-00098(XX)	40.6cm	For cone 4.5-7oz (130-210ml), cup 6-12oz (180-360ml)

SAN JAMAR Stainless Steel Counter Mount Collar Cup Dispenser

Product Code	Dimension	Capacity	
06-009-00125	23.5"	For 6-10oz	Cup rim diameter 64-79mm
06-009-00126	23.5"	For 12-24oz	Cup rim diameter 76-98mm
06-009-00127	23.5"	For 32-46oz	Cup rim diameter 101-117mm

SAN JAMAR Beverage and Lid Dispenser Cabinet Sentry®

Product Code	Dimension	Capacity
06-009-00062(XX)	38.9 x 19.7 x 64.5cm	1 x (79-114mm) Sentry cup dispenser, 1 x (70-95mm) EZ-Fit lid dispenser
06-009-00063(XX)	38.9 x 19.7 x 64.5cm	1 x (79-114mm) Sentry cup dispenser, 1 x (95-114mm) EZ-Fit lid dispenser
06-009-00064(XX)	56.8 x 19.7 x 64.5cm	1 x (79-114mm) Sentry cup dispenser, 1 x (70-95mm) EZ-Fit lid dispenser, 1 straw

SAN JAMAR Beverage Dispenser Cabinet with Black Trim Rings Sentry®

Product Code	Dimension	
06-009-00066(XX)	38.4 x 19.7 x 60.4cm	2 x Sentry cup dispensers
06-009-00067	56.8 x 19.7 x 60.4cm	3 x Sentry cup dispensers



SAN JAMAR Beverage Dispenser Cabinet with Black Trim Rings EZ-Fit®

Product Code	Dimension
06-009-00065(XX)	38.1 x 19.7 x 60.3cm 2 x EZ-Fit cup dispensers



SAN JAMAR Beverage Dispenser Cabinet with Metal Trim Rings EZ-Fit®

Product Code	Dimension
06-009-00068(XX)	38.1 x 19.7 x 60.3cm 2 x EZ-Fit cup dispensers



SAN JAMAR Countertop Fullfold Napkin Dispenser with Stand Venue®

Product Code	Dimension	Capacity	Colour
06-009-00080	44.5 x 20.3 x 33cm	450+	Clear



SAN JAMAR Countertop Fullfold / Interfold Napkin Dispenser Venue®

Product Code	Dimension	Capacity	Colour
06-009-00079	18.4 x 20.3 x 40cm	450+	Clear
06-009-00081	18.4 x 20.3 x 40cm	550+	Black Pearl



SAN JAMAR Countertop Minifold Napkin Dispenser Venue®

Product Code	Dimension	Capacity	Colour
06-009-00082	14.9 x 20.3 x 40cm	450+	Clear
06-009-00083	14.9 x 20.3 x 40cm	450+	Black Pearl



Stainless Steel Rectangle Napkin Holder

Product Code	Dimension
06-009-00118(XX)	15 x 15 x 14.3cm



SAN JAMAR Counter-Top Fullfold Napkin Dispenser

Product Code	Dimension	Capacity	Colour
06-009-00077	14 x 19.4 x 27.9cm	300+	Black / Chrome
06-009-00078	14 x 19.4 x 27.9cm	300+	Black / Clear



Stainless Steel Napkin Holder

Product Code	Dimension
06-009-00116	9 x 7.5cm
06-009-00117	12 x 7.5cm



EVELIN Modern Napkin Holder with Handmade Finishing

Product Code	Dimension
09-002-00017	14 x 5.5 x 8cm



06-009-00121



06-009-00122

SAN JAMAR Napkin Dispenser Interfold

Product Code	Dimension	For
06-009-00121	56.3 x 23.9 x 34.6cm	Straw and Napkin
06-009-00122	56.3 x 23.9 x 34.6cm	Organizer and Napkin



TABLECRAFT Glass Straw Dispenser

Product Code	Dimension
06-009-00106	10 x 10 x 28.1cm



TABLECRAFT Stainless Steel Two-Sided Straw Dispenser

Product Code	Dimension
06-009-00105	23.8 x 17.7 x 18cm



TRAEX 2-Sided Giant Straw Dispenser

Product Code	Dimension	Capacity	Colour
06-009-00110	9" x 10" x 7"	500	Dark Walnut Woodgrain



TRAEX 1-Sided Giant Straw Dispenser

Product Code	Dimension	Capacity	Colour
06-009-00108	7" x 9" x 4"	250	Dark Walnut Woodgrain
06-009-00109	7" x 9" x 4"	250	Light Oak Woodgrain



Plastic Single-Sided Straw Dispenser

Product Code	Dimension	Colour
06-009-00113	23.5 x 12 x 18cm	Woodgrain



Stainless Steel Round Straw Holder

Product Code	Dimension
06-009-00114	Ø7.3 x H8.5cm
06-009-00115	Ø7.3 x H13cm



TABLECRAFT Acrylic Straw Dispenser

Product Code	Dimension
06-009-00128	12.25 x 5.5 x 6.75"



TABLECRAFT Stainless Steel Toothpick Dispenser

Product Code	Dimension
06-009-00107(XX)	9.5 x 7.5 x 11.3cm



Mel Rectangle Chopstick Box

Product Code	Dimension	Colour
06-009-00139	30.3 x 10.1 x 7.2cm	Black



Mel Rectangle Chopstick Box

Product Code	Dimension	Colour
06-009-00140	28.2 x 9.9 x 8.1cm	Black



STEWARDING & HOUSEKEEPING





TRUST Lid for Cube Truck for 07-005-00143/144

Product Code	Dimension	Colour
07-005-00145(XX)	109.6 x 69.9 x 21.6cm	■ Black



TRUST Cube Truck

Product Code	Dimension	Capacity	Colour
07-005-00142(XX)	96.5 x 66 x 71.5cm	Max load 135kg	■ Black
07-005-00143(XX)	108.6 x 71.1 x 83.8cm	Max load 180kg	■ Black
07-005-00144(XX)	108.6 x 71.1 x 83.8cm	Max load 180kg	□ White



TRUST Tilt Truck Industrial Strength

Product Code	Dimension	Capacity	Colour
07-005-00141(XX)	47 x 26 x 45cm	Max load 390kg	■ Black



UNICA Mobile Refuse Bin with Pedal

Product Code	Dimension	Capacity	Colour
07-005-00146	56 x 48 x 78cm	80ℓ	■ Green
07-005-00147	56 x 48 x 78cm	80ℓ	■ Gray
07-005-00148	55.5 x 48 x 93cm	120ℓ	■ Green
07-005-00149	55.5 x 48 x 93cm	120ℓ	■ Gray
07-005-00150	46 x 32 x 66cm	60ℓ	■ Gray Base ■ Green Lid
07-005-00151	46 x 32 x 66cm	60ℓ	■ Gray Base ■ Gray Lid



UNICA Mobile Refuse Bin without Pedal

Product Code	Dimension	Capacity	Colour
07-005-00152	56 x 48 x 78cm	80ℓ	■ Green
07-005-00153	56 x 48 x 78cm	80ℓ	■ Gray
07-005-00154	55.5 x 48 x 93cm	120ℓ	■ Green
07-005-00155	55.5 x 48 x 93cm	120ℓ	■ Gray



Garbage Bin 2 Wheel

Product Code	Dimension	Capacity	Colour
07-005-00160	136 x 132 x 80cm	240ℓ	■ Green
07-005-00161	136 x 132 x 80cm	240ℓ	■ Gray



TRUST Square Huskee Container

Product Code	Dimension	Capacity	Colour
07-005-00040	54.6 x 54.6 x 57.2cm	106ℓ	■ Gray
07-005-00041	59.7 x 59.7 x 73cm	150ℓ	■ Gray



TRUST Dolly for Square Huskee Container 07-005-00041

Product Code	Dimension	Colour
07-005-00045	Ø43.8 x H15.9cm	■ Black



TRUST Lid for Square Huskee Container 07-005-00040/41

Product Code	Colour	For
07-005-00042	■ Gray	07-005-00040
07-005-00043	■ Red	07-005-00040
07-005-00044	■ Gray	07-005-00041



TRUST Round Huskee Bin

Product Code	Dimension	Capacity	Colour
07-005-00046	Ø40 x H44cm	38ℓ	Gray
07-005-00047	Ø49 x H57cm	75ℓ	Gray
07-005-00048	Ø56 x H70cm	121ℓ	Gray
07-005-00049	Ø61 x H80cm	166ℓ	Gray
07-005-00050	Ø67 x H84cm	208ℓ	Gray

*Other colours available upon request



TRUST Lid for Round Huskee Container 07-005-00046/47/48/49/50

Product Code	Colour	For
07-005-00063	Gray	07-005-00046
07-005-00064	Gray	07-005-00047
07-005-00065	Gray	07-005-00048
07-005-00066	Gray	07-005-00049
07-005-00067	Gray	07-005-00050

*Other colours available upon request



TRUST Dolly for Round Huskee Container 07-005-00047/48/49/50

Product Code	Dimension	Colour
07-005-00077	Ø46.4 x H16.8cm	Black



TRUST Drum Dolly for 07-005-00040/41/46/47/48/49/50

Product Code	Dimension	Colour
07-005-00078	114 x 51 x 20cm	Black



A-STAR Utility Can with Iron Handle

Product Code	Dimension	Capacity
07-005-00007	Ø45 x H57.5cm	64ℓ



A-STAR Swing Lid for Utility Can 07-005-00007

Product Code	Dimension
07-005-00008	Ø45 x H21.4cm



Flat Cover



Dome Shaped Cover

UNICA Plastic Utility Bin with Lid

Product Code	Dimension	Capacity	Type
07-005-00001	Ø31 x H32.5cm	9.2ℓ	Flat Cover
07-005-00002	Ø34 x H37.5cm	15.1ℓ	Flat Cover
07-005-00003	Ø46.5 x H54cm	45.4ℓ	Dome Shaped Cover
07-005-00005	Ø39 x H40.5cm	22.7	Flat Cover
07-005-00006	Ø55x H64cm	68.1ℓ	Dome Shaped Cover

*Available in ■ Red and ■ Blue Colours



Plastic Round Bin with Lid

Product Code	Capacity	Colour
07-005-00009	80ℓ	Black



Plastic Rectangle Bin with Lid

Product Code	Dimension	Capacity
07-005-00010	38 x 47 x 48cm	85.7ℓ



EKO REGENT Stainless Steel Square Step Bin with Soft Closing Lid

Dimension	Capacity	Brushed Finishing	Black	Champagne Gold
24 x 32.8 x 31.4cm	9ℓ	07-005-00171	07-005-00186	07-005-00189
24 x 32.8 x 40.5cm	12ℓ	07-005-00172	07-005-00187	07-005-00190
27 x 35.5 x 53.1cm	20ℓ	07-005-00173	07-005-00188	07-005-00191



EKO LUNA Stainless Steel Step Bin with Soft Closing Lid

Dimension	Capacity	Cream	Titanium Grey	Black
Ø21 x 27.2x H29cm	5ℓ	07-005-00182	07-005-00198	07-005-00202
Ø23.2 x 29.5 x H35.5cm	8ℓ	07-005-00183	07-005-00199	07-005-00203
Ø25.5 x 31.9 x H40cm	12ℓ	07-005-00184	07-005-00200	07-005-00204
Ø30.8 x 38 x H46cm	20ℓ	07-005-00185	07-005-00201	07-005-00205



EKO ECO FLY Stainless Steel Step Bin with Soft Closing Lid (Brushed Finishing)

Product Code	Dimension	Capacity
07-005-00174	22.2 x 41.7 x 36.5cm	12ℓ
07-005-00175	25.5 x 44.8 x 46.5cm	20ℓ
07-005-00176	25.5 x 44.8 x 64.6cm	30ℓ
07-005-00177	27.5 x 53.2 x 66.1cm	45ℓ
07-005-00178	27.5 x 53.2 x 66.1cm	20ℓ + 20ℓ

EKO EVA Stainless Steel Step Bin with Soft Closing Lid (Brushed Finishing)

Product Code	Dimension	Capacity
07-005-00167	Ø25 x 31.4 x H39.5cm	12ℓ
07-005-00168	Ø29.2 x 36.3 x H44.8cm	20ℓ



EKO TOUCH PRO Stainless Steel Step Bin with Soft Closing Lid (Brushed Finishing)

Product Code	Dimension	Capacity
07-005-00164	37.7 x 27.4 x 64.2cm	30ℓ
07-005-00165	46 x 29 x 67.4cm	45ℓ
07-005-00166	46 x 29 x 67.4cm	20ℓ + 20ℓ



EKO ECOSMART Stainless Steel Square Motion Sensor Bin

Dimension	Capacity	Brushed Finishing	Champagne Gold
21 x 21 x 31.5cm	6ℓ	07-005-00179	07-005-00192
24 x 24 x 43cm	12ℓ	07-005-00180	07-005-00193
27 x 27 x 57.5cm	21ℓ	07-005-00181	07-005-00194



EKO Drawstring Bin Liners

Product Code	For	Packaging
07-005-00213	10-15ℓ	20pcs/pkt
07-005-00214	18-21ℓ	20pcs/pkt
07-005-00215	25-35ℓ	20pcs/pkt
07-005-00216	40-60ℓ	20pcs/pkt



Plastic Round Pedal Bin

Product Code	Dimension	Capacity
07-005-00012	Ø28 x H36cm	9ℓ
07-005-00013	Ø28 x H36cm	35ℓ



Plastic Square Pedal Bin

Product Code	Dimension	Capacity	Colour
07-005-00080	32 x 26 x 38cm	12ℓ	Gray Base Black Lid
07-005-00081	37 x 28 x 48cm	25ℓ	Gray Base Black Lid
07-005-00082	40 x 30 x 56cm	35ℓ	Gray Base Black Lid



Plastic Step On Bin

Product Code	Dimension	Colour
07-005-00011	38.8 x 28.8 x 50.8cm	Gray



Plastic Square Pedal Bin

Product Code	Dimension	Capacity
07-005-00014	25.5 x 27.5 x 35.5cm	12ℓ



Stainless Steel Round Pedal Bin (Mirror Finish)

Product Code	Dimension	Capacity
07-005-00126	Ø16.7 x H27cm	3ℓ
07-005-00127	Ø20.3 x H28.4cm	5ℓ
07-005-00123	Ø24.8 x H40cm	12ℓ
07-005-00124	Ø29.2 x H44.5cm	20ℓ
07-005-00125	Ø29.2 x H64cm	30ℓ



Stainless Steel Square Dustbin Swing Top

Product Code	Dimension
07-005-00083	25 x 25 x 61cm
07-005-00084(XX)	30 x 30 x 61cm



Stainless Steel Dome Pedal Bin

Product Code	Dimension	Capacity	Colour
07-005-00122	Ø35 x H70cm	33ℓ	■ Gray



TRUST Step-On Pedal Bin

Product Code	Dimension	Capacity	Colour
07-005-00029	41.3 x 40 x 40cm	30ℓ	■ Beige
07-005-00030	41.3 x 40 x 60cm	45ℓ	■ Beige
07-005-00031	50.2 x 41 x 67.3cm	68ℓ	■ Beige
07-005-00032	50.2 x 44.7 x 82.6cm	87ℓ	■ Beige



07-005-00033/34



07-005-00035



07-005-00036



07-005-00037



07-005-00038



TRUST Rectangle Waste Basket

Product Code	Dimension	Capacity	Colour
07-005-00085	36.5 x 26 x 38.1cm	26ℓ	■ Beige
07-005-00086	35.5 x 26 x 38.1cm	26ℓ	■ Gray
07-005-00087	38.7 x 27.9 x 50.5cm	39ℓ	■ Beige
07-005-00088	38.7 x 27.9 x 50.5cm	39ℓ	■ Gray



TRUST Slim Rectangle Bin

Product Code	Dimension	Capacity	Colour
07-005-00093	51 x 27 x 63cm	60ℓ	■ Beige
07-005-00094	51 x 27 x 63cm	60ℓ	■ Brown
07-005-00095	51 x 27 x 63cm	60ℓ	■ Gray
07-005-00096	51 x 27 x 76cm	87ℓ	■ Beige
07-005-00097	51 x 27 x 76cm	87ℓ	■ Brown
07-005-00098	51 x 27 x 76cm	87ℓ	■ Gray

Plastic Swing Top Dustbin

Product Code	Dimension	Capacity
07-005-00033	18 x 23 x 39cm	9ℓ
07-005-00034	25 x 31 x 52cm	23ℓ
07-005-00035	26 x 17 x 42cm	10ℓ
07-005-00036	31 x 20 x 48cm	15ℓ
07-005-00037	35.5 x 23 x 56cm	25ℓ
07-005-00038	26.5 x 36.5 x 60.5cm	37ℓ



TRUST Swing Top Lid for Rectangle Bin

Product Code	Colour	For
07-005-00089	■ Beige	07-005-00085/86
07-005-00090	■ Black	07-005-00085/86
07-005-00091	■ Beige	07-005-00087/88
07-005-00092	■ Black	07-005-00087/88



TRUST Swing Top Lid for Slim Rectangle Bin

Product Code	Dimension	Colour	For
07-005-00099	52.3 x 28.8 x 11.5cm	■ Beige	07-005-00093/94/95
07-005-00100	52.3 x 28.8 x 11.5cm	■ Black	07-005-00096/97/98
07-005-00101	52.3 x 28.8 x 11.5cm	■ Gray	07-005-00096/97/98



TRUST Bottle & Can Recycling Lid for Slim Rectangle Bin

Product Code	Dimension	Colour
07-005-00102	52.2 x 28.8 x 6.7cm	Green



TRUST Paper Recycling Lid for Slim Rectangle Bin

Product Code	Dimension	Colour
07-005-00103	52.2 x 28.8 x 6.7cm	Blue



TRUST Dolly for Slim Rectangle Bin

Product Code	Dimension	Colour
07-005-00104	51.6 x 29 x 26cm	Black



TRUST Double-Compartment Dolly for Slim Rectangle Bin

Product Code	Dimension	Colour
07-005-00105	58.2 x 51.7 x 24cm	Black



TRUST Square Bin

Product Code	Dimension	Capacity	Colour
07-005-00106	39.4 x 39.4 x 78.5cm	87ℓ	Beige
07-005-00107	39.4 x 39.4 x 78.5cm	87ℓ	Black
07-005-00108	39.4 x 39.4 x 78.5cm	87ℓ	Gray



TRUST Vertical Push Lid for Square Bin

Product Code	Dimension	Colour	For
07-005-00109	40.6 x 40.6 x 10.2cm	Beige	07-005-000106/107/108
07-005-00110	40.6 x 40.6 x 10.2cm	Black	07-005-000106/107/108
07-005-00111	40.6 x 40.6 x 10.2cm	Gray	07-005-000106/107/108



TRUST Toilet Pump

Product Code	Dimension	Colour
07-002-00321	Ø14 x H50.5cm	Black
07-002-00322	Ø14.5 x H51.5cm	Black



TRUST Collection Tong

Product Code	Dimension	Colour
07-002-00323	45cm	Black
07-002-00324	84cm	Black



TRUST Unfire Fire-Resistant Wastebasket

Product Code	Dimension	Capacity	Colour
07-005-00129	28.3 x 21 x 31.1cm	13ℓ	Beige



EKO Fire-Resistant Waste Bin

Product Code	Dimension	Colour
07-005-00128	23 x 15.5 x 26cm	Gray



EKO Waste Basket

Product Code	Dimension	Type	Colour
07-005-00131	29.8 x 21.5 x 30cm	Rectangle	Silver
07-005-00132	Ø29.5 x H34.5cm	Round	Black
07-005-00133	Ø26.5 x H29.5cm	Round	Black
07-005-00134	Ø23.5 x H29.5cm	Round	Black
07-005-00135	27 x 27 x 29.5cm	Square	Black
07-005-00136	25 x 35 x 35cm	Square	Black
07-005-00137	25 x 35 x 35cm	Square	Silver
07-005-00138	22 x 22 x 20cm	Square	Black
07-005-00139	22 x 22 x 20cm	Square	Silver



07-005-00112

07-005-00113

07-005-00114

07-005-00115

07-005-00116

07-005-00117

Stainless Steel Ashtray Bin

Product Code	Dimension	Type
07-005-00112	Ø30 x H65cm	Round
07-005-00113	Ø25 x H61cm	Round
07-005-00114	30 x 24 x 62cm	Rectangle Black
07-005-00115	30 x 24 x 62cm	Rectangle Matt Finish
07-005-00116	24 x 24 x 62cm	Square Black
07-005-00117	24 x 24 x 62cm	Square Matt Finish



TRUST Wall Mounted Cigarette Butts Bucket

Product Code	Dimension	Type
07-005-00118	8 x 8 x 48cm	Metallic Silver
07-005-00119	8 x 8 x 48cm	Metallic Silver with Slant Cover

TRUST Floor Standing Cigarette Butts Bucket

Product Code	Dimension	Type
07-005-00120	30 x 90cm	Metallic Silver
07-005-00121	30 x 104cm	Metallic Silver



TRUST Housekeeping Cart w/ Doors

Product Code	Dimension	Colour
07-006-00003(XX)	152.4 x 55.9 x 171cm	Black



TRUST Housekeeping Cart w/ Doors & Protective Security Hood

Product Code	Dimension	Colour
07-006-00002	152.4 x 55.9 x 171cm	Black



TRUST Housekeeping Cart

Product Code	Dimension	Colour
07-006-00004	152.4 x 55.9 x 127cm	Black



TRUST Fine Housekeeping Cart

Product Code	Dimension	Colour
07-006-00005	124 x 55.9 x 123cm	Black



TRUST Janitorial Cleaning Cart

Product Code	Dimension	Colour
07-006-00001	116.8 x 55.2 x 97.5cm	Black



TRUST Janitor Cart Accessory - Spray Bottle Stack

Product Code	Dimension	Colour
07-008-00001	76.5 x 47 x 5.7cm	Black

Fits 4 Spray Bottles



TRUST Deluxe Carry Caddy

Product Code	Dimension	Colour
07-008-00002	38.6 x 28 x 17cm	Black



Plastic Pressure Sprayer

Product Code	Capacity
07-002-00304	2ℓ (4.5 pints)



TRUST Pressure Sprayer

Product Code	Capacity
07-002-00301	1ℓ
07-002-00302	1.5ℓ
07-002-00303	2ℓ



TRUST Plastic Spray Bottle

Product Code	Dimension	Capacity	Colour
07-002-00308	12.5 x 8.5 x 34cm	0.95ℓ	Red



A-STAR Plastic Water Sprayer

Product Code	Capacity
07-002-00305	0.25l



Plastic Water Sprayer

Product Code	Capacity
07-002-00306	0.5l



CARLISLE Strip Window Washer Head

Product Code	Dimension	Matching Handle
07-002-00220	35cm	07-002-00181



CARLISLE Replaceable Strip Window Washer Mitt

Product Code	For	Matching Handle
07-002-00228	07-002-00220	07-002-00181



CARLISLE Wooden Handle with Tapered End for 07-002-00220 & Rubber Floor Squeegee with Metal Frame

Product Code	Dimension
07-002-00181	150cm



CARLISLE Window & Floor Scraper with Blade

Product Code	Dimension	Matching Handle
07-002-00227(XX)	15cm	07-002-00181



CARLISLE Windshield Washer / Squeegee

Product Code	Dimension	Matching Handle
07-002-00229	Sponge 20cm; Handle 37.2cm	07-002-00181



CARLISLE Rubber Window Squeegee with Zinc Plated Handle

Product Code	Dimension	Type	Matching Handle
07-002-00221	30cm	Single Blade	07-002-00181
07-002-00222	40cm	Single Blade	
07-002-00223	20cm	Double Blade	
07-002-00224	25cm	Double Blade	
07-002-00226	30cm	Double Blade	
07-002-00225	35cm	Double Blade	



TRUST Laundry Cart

Product Code	Dimension	Capacity	Colour
07-006-00006	70.5 x 63.5 x 87.6cm	170l	■ Gray
07-006-00007	94 x 63.5 x 106.2cm	340l	■ Gray



TRUST Heavy Duty Laundry Net

Product Code	Dimension	Colour
07-006-00008	91.4 x 61cm	□ White



07-008-00004

07-008-00005

07-008-00006

TRUST Wet Floor Sign

Product Code	Dimension	Colour	Type
07-008-00004	66 x 27.9 x 30.5cm	Yellow	Folding
07-008-00005	66 x 33 x 33.6cm	Yellow	Stable Base
07-008-00006	31.1 x 31.1 x 91.4cm	Yellow	Cone

**SAN JAMAR Hand Washing Station Smart Chart**

Product Code	Dimension
07-008-00008	22.9 x 15.2cm

**Plastic Utility Pail with Handle**

Product Code	Dimension	Capacity
07-002-00292	Ø15 x H12.4cm	1.8ℓ
07-002-00294	Ø19.5 x H16.4cm	3.7ℓ
07-002-00314	Ø20 x H16cm	3.7ℓ
07-002-00293	Ø23.6 x H20.3cm	6.8ℓ
07-002-00317	Ø27 x H24cm	7.5ℓ
07-002-00318	Ø29 x H27cm	11.3ℓ
07-002-00319	Ø29 x H30cm	15.1ℓ
07-002-00315	Ø34 x H32cm	18.9ℓ
07-002-00316	Ø34 x H35cm	22.7ℓ

*Available in ■ Red and ■ Blue Colours**UNICA Plastic Mop Cover for 07-002-00319**

Product Code	Dimension	Colour
07-002-00048	Ø30 x H10cm	White

**TRUST Barrier Chain for Safety Cones**

Product Code	Dimension	Colour
07-008-00007	2.2 x 2.2 x 610cm	Yellow

**Plastic Round Basin**

Product Code	Dimension	Capacity
07-002-00265	Ø20 x H8.5cm	2.4ℓ
07-002-00266	Ø27.9 x H8.7cm	3.9ℓ
07-002-00267	Ø30.5 x H11.2cm	6.3ℓ
07-002-00268	Ø36 x H13cm	9.4ℓ
07-002-00269	Ø34 x H10.2cm	7.9ℓ
07-002-00270	Ø40 x H15cm	14.4ℓ
07-002-00271	Ø46 x H17cm	21.9ℓ
07-002-00272	Ø58.2 x H23.1cm	48.5ℓ
07-002-00310	Ø51 x H25cm	40.8ℓ
07-002-00311	Ø55 x H25cm	42.5ℓ
07-002-00312	Ø66 x H30cm	76.6ℓ

**Plastic Pail with Iron Handle**

Product Code	Dimension	Capacity
07-002-00273	Ø26 x H23cm	7.5ℓ
07-002-00274	Ø29 x H26cm	11.3ℓ
07-002-00275	Ø31 x H30cm	15.1ℓ
07-002-00276	Ø35 x H35cm	22.7ℓ
07-002-00044	Ø35.5 x H31.5cm	18.9ℓ

**Plastic Mop Dryer for 07-002-00044**

Product Code
07-002-00045



TRUST Plastic Divided Pail

Product Code	Dimension	Capacity	Colour
07-002-00277	38.2 x 35.4 x 25.2cm	16ℓ	Gray



TRUST Rectangular Utility Bucket

Product Code	Dimension	Capacity	Colour
07-002-00284	21.3 x 17.7 x 21.5cm	4.7ℓ	Blue
07-002-00285	21.3 x 17.7 x 21.5cm	4.7ℓ	Green
07-002-00286	21.3 x 17.7 x 21.5cm	4.7ℓ	Red
07-002-00287	21.3 x 17.7 x 21.5cm	4.7ℓ	Yellow
07-002-00288	35.8 x 21.8 x 20.5cm	9.5ℓ	Blue
07-002-00289	35.8 x 21.8 x 20.5cm	9.5ℓ	Green
07-002-00290	35.8 x 21.8 x 20.5cm	9.5ℓ	Red
07-002-00291	35.8 x 21.8 x 20.5cm	9.5ℓ	Yellow



Plastic Mop Bucket with Wringer

Product Code	Capacity	Colour
07-002-00046	24.6ℓ	Yellow



TRUST Plastic Mop Bucket

Product Code	Dimension	Capacity	Colour
07-002-00047	43 x 31.2 x 31.6cm	14ℓ	Gray



TRUST Toilet Bowl Brush with Plastic Handle / Brush Holder

Product Code	Dimension	Colour	
07-008-00010	13.5cm	White	Brush Holder
07-008-00011	42cm	White	Brush



TRUST Plastic Round Huskee Bucket with Pouring Spout

Product Code	Dimension	Capacity	Colour
07-002-00283	Ø26.7 x H26cm	10ℓ	Blue
07-002-00278	Ø26.7 x H26cm	10ℓ	Gray
07-002-00279	Ø26.7 x H26cm	10ℓ	Red
07-002-00280	Ø30.5 x H28.6cm	13ℓ	Blue
07-002-00281	Ø30.5 x H28.6cm	13ℓ	Gray
07-002-00282	Ø30.5 x H28.6cm	13ℓ	Red



SAN JAMAR Plastic Square Klean Pail

Product Code	Capacity	Colour
07-002-00332	2.84ℓ	Red
07-002-00333	5.68ℓ	Red
07-002-00334	7.57ℓ	Red
07-002-00335	2.84ℓ	Green
07-002-00336	5.68ℓ	Green
07-002-00337	7.57ℓ	Green



TRUST Mop Bucket with Side Press Wringer

Product Code	Dimension	Capacity	Colour
07-002-00041	51.5 x 40.6 x 92.7cm	33ℓ	Blue
07-002-00042	51.5 x 40.6 x 92.7cm	33ℓ	Brown
07-002-00043	51.5 x 40.6 x 92.7cm	33ℓ	Yellow
07-002-00330	50 x 37.2 x 90cm	25ℓ	Yellow



CARLISLE Roll & Grip Plus Broom & Brush Holder

Product Code	Dimension	Add. Info.
07-008-00003	41cm	Constructed of light-weight, durable ABS and rubber. Grips accommodate items from 5/8" - 1-1/4" in diameter and 0.4 - 8-1/4 lbs



CARLISLE Automatic Sponge Mop with Long Handle

Product Code	Dimension	Colour
07-002-00049	30cm	 Yellow



CARLISLE Replaceable Roller Sponge Mop for 07-002-00049

Product Code	For
07-002-00050	07-002-00049









Non-Woven Fibre & Cotton Mop Head

Product Code	Matching Handle
07-002-00061	07-002-00107 / 108 / 109 (Page 348)



CARLISLE 4-Ply Synthetic Cotton Lopped End Mop

Product Code	Dimension	Capacity	Colour
07-002-00051	45cm	Small	 Yellow Band
07-002-00052	45cm	Medium	 Green Band
07-002-00053	45cm	Large	 Red Band
07-002-00054	45cm	X-Large	 Blue Band
07-002-00055	45cm	Medium	 Blue Band with Green Yarn
07-002-00056	45cm	Medium	 Green Band with Green Yarn

Matching Handle: 07-002-00102 (Page 348)



CARLISLE Tie-Back Dust Mop

Product Code	Dimension	Matching Mop Frame
07-002-00057	60 x 12.5cm	07-002-00072
07-002-00058	90 x 12.5cm	07-002-00073



CARLISLE Tie-Back Dust Mop Frame

Product Code	Dimension	Matching Handle
07-002-00072	60cm	07-002-00181
07-002-00073	90cm	



Mop Head (Screw Type) Economy

Product Code	Capacity	Matching Handle
07-002-00059	20oz	07-002-00107 / 108 / 109 (Page 348)
07-002-00060	24oz	



CARLISLE Aluminium Telescopic Handle for all Mop Pad

Product Code	Dimension
07-002-00104	Max Length 117.8cm
07-002-00187(XX)	Max Length 426.72cm



CARLISLE Flat Mop Pad Head

Product Code	Dimension	Matching Handle
07-002-00062	45cm	07-002-00104
07-002-00063	60cm	
07-002-00064(XX)	90cm	



CARLISLE Microfibre Dry Mop Pad, Looped Fringe

Product Code	Dimension	Matching Handle
07-002-00065	45cm	07-002-00102
07-002-00066	60cm	
07-002-00067	90cm	



CARLISLE Microfibre Wet Mop Pad

Product Code	Dimension	Colour	Matching Handle
07-002-00068	45cm	Blue	07-002-00102
07-002-00069	60cm	Blue	
07-002-00070(XX)	45cm	Yellow	
07-002-00071(XX)	45cm	Red	



CARLISLE Straight Rubber Floor Squeegee with Metal Frame

Product Code	Dimension	Matching Handle
07-002-00075	45cm	07-002-00181
07-002-00076	60cm	
07-002-00077	90cm	



Water Pusher Head, Economy

Product Code	Dimension	Matching Handle
07-002-00074	45cm	07-002-00107 / 108 / 109



CARLISLE Dual Action Scrub Brush with Squeegee

Product Code	Dimension	Colour	Matching Handle
07-002-00078	25cm	Blue	07-002-00170 to 175



CARLISLE Curved End Rubber Floor Squeegee with Metal Frame

Product Code	Dimension	Matching Handle
07-002-00079	60cm	07-002-00181



CARLISLE Curved End Rubber Floor Squeegee with Metal Frame

Product Code	Dimension	Matching Handle
07-002-00080	90cm	07-002-00181



CARLISLE Duo-Sweeper™ Multi-Surface Floor Sweep with Handle

Product Code	Dimension	Colour
07-002-00010	23.7cm	Blue



CARLISLE One Piece Rubber Floor Squeegee

Product Code	Dimension	Colour	Matching Handle
07-002-00081	50cm	White	07-002-00181
07-002-00082	50cm	Yellow	
07-002-00083	50cm	Red	
07-002-00084	50cm	Green	
07-002-00085	50cm	Blue	
07-002-00086	60cm	White	
07-002-00087	60cm	Yellow	
07-002-00088	60cm	Red	
07-002-00089	60cm	Green	
07-002-00090	60cm	Blue	



CARLISLE Duo-Sweep Flagged Lobby Broom with Handle

Product Code	Dimension	Colour
07-002-00011	75cm	Blue



CARLISLE Duo-Sweep Flagged Angle Broom Head

Product Code	Dimension	Colour	Matching Handle
07-002-00012	30cm	Brown	07-002-00105 07-002-00107 07-002-00108 07-002-00109
07-002-00013	30cm	White	
07-002-00014	30cm	Yellow	
07-002-00015	30cm	Red	
07-002-00016	30cm	Green	
07-002-00017	30cm	Blue	



CARLISLE Nylon Bristle Brush Head (Screw Type)

Product Code	Dimension	Matching Handle
07-002-00091	22cm	07-002-00105
		07-002-00107
		07-002-00108
		07-002-00109



Nylon Soft Broom Head (Screw Type)

Product Code	Dimension	Matching Handle
07-002-00092	25cm	07-002-00105
		07-002-00107
		07-002-00108
		07-002-00109



Nylon Soft Broom Head (Screw Type)

Product Code	Dimension	Matching Handle
07-002-00018	23cm	07-002-00105
		07-002-00107
		07-002-00108
		07-002-00109



TRUST Angle Broom with Handle

Product Code	Dimension	Colour
07-002-00029	19cm	Black / Yellow



CARLISLE Housekeeping Broom with Handle

Product Code	Dimension	
07-002-00030	137cm	Corn blend brooms have a heavy-duty lacquered wood handle and a high bristle fill

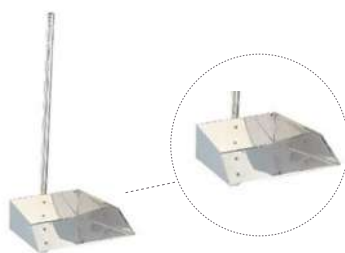

Stainless Steel Dustpan with Handle

Product Code	Dimension
07-002-00031(XX)	28 x 22 x 60cm



Plastic Dust Pan with Handle

Product Code	Dimension	Colour
07-002-00032	27 x 25 x 12cm; Handle 71cm	Blue



TRUST Upright Dust Pan with Hook

Product Code	Dimension	Colour
07-002-00034	32.3 x 13.9 x 95.8cm	Black



TRUST Upright Dust Pan with Cover and Hook

Product Code	Dimension	Colour
07-002-00035	33.2 x 14.4 x 95.8cm	Black



UNICA Plastic Dustpan

Product Code	Dimension	Colour	Matching Handle
07-002-00033	30 x 30 x 16cm	<input checked="" type="checkbox"/> Blue / <input checked="" type="checkbox"/> Red	07-002-00105 07-002-00107 07-002-00108 07-002-00109



TRUST Heavy-Duty Dustpan

Product Code	Dimension	Colour
07-002-00036	31.1 x 21 x 6.7cm	<input checked="" type="checkbox"/> Black



TRUST Heavy-Duty Dustpan & Counter Brush

Product Code	Dimension	Colour
07-002-00037	31.1 x 21 x 6.7cm	<input checked="" type="checkbox"/> Black



TRUST Extra Large Dust Pan

Product Code	Dimension	Colour
07-002-00038	40.6 x 37.5 x 13.7cm	<input checked="" type="checkbox"/> Black



Nylon Bottle Brush

Product Code	Dimension	Capacity
07-002-00199	11 and 24cm	2pcs/set



CARLISLE Bottle, Jar and Jug Brushes

Product Code	Dimension	Colour
07-002-00110(XX)	30cm	<input type="checkbox"/> White / Sparta
07-002-00111(XX)	40cm	<input type="checkbox"/> White / Sparta
07-002-00117(XX)	41.3cm	<input checked="" type="checkbox"/> Sparta



CARLISLE Polypropylene Kitchen Brush with Nylon Bristles

Product Code	Dimension	Colour
07-002-00114	20 x 7.7cm	<input type="checkbox"/> White / Sparta



CARLISLE Dishwashing Brush with Polyester Bristles

Product Code	Dimension	Colour
07-002-00093	30cm	Sparta



CARLISLE Twin Glass Washing Brush

Product Code	Dimension
07-002-00121	20cm



CARLISLE Triple Glass Washing Brush

Product Code	Dimension
07-002-00122	20cm



CARLISLE Tank and Kettle Head Brush with Nylon Bristles

Product Code	Dimension	Colour
07-002-00123(XX)	18.7 x 13.7cm	Sparta



CARLISLE Polypropylene Kitchen Brush with Polyester Bristles

Product Code	Dimension	Colour
07-002-00124	50.8 x 7.7cm	<input type="checkbox"/> White / Sparta



CARLISLE Polypropylene Block Kitchen 8" Utility Scrub Brush with Polyester Bristles

Product Code	Dimension	Colour
07-002-00126	20 x 7.7cm	<input type="checkbox"/> White / Sparta
07-002-00127	20 x 7.7cm	<input checked="" type="checkbox"/> Blue / Sparta



CARLISLE Counter Top / Bench Brush with Polyester Bristles

Product Code	Dimension	Colour
07-002-00128	20.3 x 6.4cm	<input type="checkbox"/> White / Sparta
07-002-00129	20.3 x 6.4cm	<input checked="" type="checkbox"/> Black / Sparta



CARLISLE Spectrum Cutting Board Brush with Polyester Bristle

Product Code	Dimension	Colour
07-002-00130	15 x 6.5cm	<input type="checkbox"/> White / Sparta
07-002-00131	15 x 6.5cm	<input checked="" type="checkbox"/> Yellow / Sparta
07-002-00132	15 x 6.5cm	<input checked="" type="checkbox"/> Red / Sparta
07-002-00133	15 x 6.5cm	<input checked="" type="checkbox"/> Green / Sparta
07-002-00134	15 x 6.5cm	<input checked="" type="checkbox"/> Blue / Sparta
07-002-00135	15 x 6.5cm	<input checked="" type="checkbox"/> Tan / Sparta



CARLISLE Hand & Nail Brush with Polyester Bristles

Product Code	Dimension	Colour
07-002-00142	13 x 6.5 x 5.5cm	Sparta



CARLISLE Multi-Purpose Hand Scrub with Polyester Bristles

Product Code	Dimension
07-002-00143(XX)	18.1cm



CARLISLE Scrub Brush with Stiff Polyester Bristles

Product Code	Dimension	Colour
07-002-00151	15 x 6.2cm	Sparta



CARLISLE Iron Style Brush with Polypropylene Bristles

Product Code	Dimension
07-002-00152(XX)	15cm



CARLISLE Straight Fryer Brush with Stiff Teflon™ Bristles

Product Code	Dimension
07-002-00157	71cm



CARLISLE Utility Brush with Stiff Palmyra Bristles Wood Handle

Product Code	Dimension	Colour
07-002-00149	21.25 x 7.5cm	Sparta
07-002-00150	50 x 7.5cm	Sparta



CARLISLE Utility Brush with Stiff Palmyra Bristles Plastic Handle

Product Code	Dimension	Colour
07-002-00148	21.25 x 7.5cm	Sparta



CARLISLE Stainless Steel Bristle Oven Brush & Scraper with Handle

Product Code	Dimension
07-002-00158	21.5cm; Handle 77cm



CARLISLE Wooden Butcher Board Brush with Steel Bristles

Product Code	Dimension
07-002-00159	22.5 x 10cm



CARLISLE Wire Scratch Brush Scraper with Carbon Steel Bristles Plastic Handle

Product Code	Dimension	Colour
07-002-00160	28.7cm	Blue / Sparta



CARLISLE Oven Brush & Scraper Head

Product Code	Dimension	Matching Handle
07-002-00161	25.4 x 8.89 x 3.81cm	07-002-00106



CARLISLE Oven/Grill Brush Scraper & Flatwire Stainless Steel Bristles with 30° handle

Product Code	Dimension
07-002-00162	75cm



ALEGACY Boiler / Grill Brush with Plastic Handle

Product Code	Dimension
07-002-00094	27.5cm



CARLISLE Grill Brush with Carbon Steel Bristles Wood Handle

Product Code	Dimension
07-002-00163	35cm



CARLISLE Grill Brick

Product Code	Dimension
07-002-00200	20 x 10 x 8.75cm



CARLISLE Grill Polishing Pad

Product Code	Dimension
07-002-00201	10 x 13.5cm



CARLISLE Grill Pad Holder

Product Code	Dimension
07-002-00202	10 x 14.5cm



CARLISLE Grill Screen

Product Code	Dimension	Capacity
07-002-00203	10 x 14cm	20pcs/pkt



CARLISLE Polypropylene Swivel Scrub® with 48° handle

Product Code	Dimension	Colour
07-002-00101	Brush Head 20cm	Black



CARLISLE Crimped Garage Floor Sweep with Hardwood Block

Product Code	Dimension	Colour	Matching Handle
07-002-00001	40cm	Maroon	07-002-00106
07-002-00002	60cm	Maroon	(Page 347)



CARLISLE Flagged Polypropylene Floor Sweep with Plastic Block

Product Code	Dimension	Colour	Matching Handle
07-002-00003(XX)	45cm	Gray	07-002-00181
07-002-00004	60cm	Gray	



CARLISLE Polypropylene Heavy Floor Sweep with Plastic Block

Product Code	Dimension	Colour	Matching Handle
07-002-00005	45cm	Maroon	07-002-00181



CARLISLE All Purpose Floor Sweep

Unique sweep that combines the features of fine, medium and heavy floor sweeps



CARLISLE Tampico Floor Sweep

Product Code	Dimension	Matching Handle
07-002-00009	45cm	07-002-00181

Product Code	Dimension	Colour	Matching Handle
07-002-00019	45cm	White / Sparta	07-002-00170 to 07-002-00180 (Page 347)
07-002-00020	45cm	Yellow / Sparta	
07-002-00021	45cm	Red / Sparta	
07-002-00022	45cm	Green / Sparta	
07-002-00023	45cm	Blue / Sparta	
07-002-00024	60cm	White / Sparta	
07-002-00025	60cm	Yellow / Sparta	
07-002-00026	60cm	Red / Sparta	
07-002-00027	60cm	Green / Sparta	
07-002-00028	60cm	Blue / Sparta	



CARLISLE Polypropylene Floor Scrub Brush

Product Code	Dimension	Colour	Matching Handle
07-002-00095	25cm	Brown / Sparta	07-002-00170 to 07-002-00180
07-002-00096	25cm	White / Sparta	
07-002-00097	25cm	Yellow / Sparta	
07-002-00098	25cm	Red / Sparta	
07-002-00099	25cm	Green / Sparta	
07-002-00100	25cm	Blue / Sparta	



CARLISLE Fibreglass Handle for 07-002-00019/20/21/22/23/24/25/26/27/28/95/96/97/98/99/100

Product Code	Dimension	Colour
07-002-00176	120cm	White
07-002-00177	120cm	Yellow
07-002-00178	120cm	Red
07-002-00179	120cm	Green
07-002-00180	120cm	Blue



CARLISLE Wooden Handle with Tapered End for 07-002-00220 & Rubber Floor Squeegee with Metal Frame

Product Code	Dimension
07-002-00181	150cm



CARLISLE Metal Telescopic Handle for Window Brush and Squeegee

Product Code	Dimension
07-002-00168	84-147.5cm



CARLISLE Aluminium Telescopic Handle with Locking Joints, 3 Parts for Window Brush and Squeegee

Product Code	Dimension
07-002-00167	135-240cm



CARLISLE Fibreglass Handle for 07-002-00019/20/21/22/23/24/25/26/27/28/95/96/97/98/99/100

Product Code	Dimension	Colour
07-002-00170	150cm	Brown
07-002-00171	150cm	White
07-002-00172	150cm	Yellow
07-002-00173	150cm	Red
07-002-00174	150cm	Green
07-002-00175	150cm	Blue



CARLISLE 3-Piece Threaded Aluminium Handle (Screw Type) for Window Brush and Squeegee

Product Code	Dimension
07-002-00169	150cm



CARLISLE Wooden Handle with Metal Threaded End for 07-002-00001/00002 (Page 347)

Product Code	Dimension
07-002-00106	100cm



CARLISLE Wooden Handle with Nylon Threaded End for Tank Brush / Scrub Brush / Floor Sweeps

Product Code	Dimension
07-002-00182	150cm



CARLISLE Jaw Style Mop Handle for Looped-End Mops

Product Code	Dimension
07-002-00102	150cm



CARLISLE Quick Release Fiberglass Mop Handle

Product Code	Dimension	Colour
07-002-00183	150cm	Yellow
07-002-00184	150cm	Red
07-002-00185	150cm	Green
07-002-00186	150cm	Blue



SAN JAMAR Station Mat, Anti-Fatigue Sponge

Product Code	Dimension	Colour
07-003-00006	67.5 x 90cm	Black

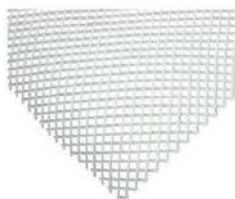

SAN JAMAR Poly-Liner, Soft Plastic

Product Code	Dimension	Colour
07-003-00001	61 x 31.8cm	Clear
07-003-00002	61 x 31.8cm	Black
07-003-00003	61 x 121.9cm	Clear



Plastic Handle Screw Type

Product Code	Dimension	Remarks
07-002-00105	4ft	For mops / brooms



Solid Metal Handle Screw Type

Product Code	Dimension	Remarks
07-002-00107	4ft	For mops / brooms



Wooden Handle (Screw Type) Economy

Product Code	Dimension	Remarks
07-002-00108	3ft	For dustpans screw type
07-002-00109	4ft	For mops / brooms screw type

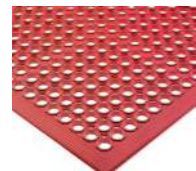

SAN JAMAR Kitchen Mat

Product Code	Dimension	Colour
07-003-00004	150 x 90cm	Black
07-003-00005	150 x 90cm	Red



3M Dirt Trap Mat

Product Code	Dimension	Colour
07-003-00012	45 x 60cm	Gray
07-003-00013	45 x 60cm	Red
07-003-00015	60 x 90cm	Gray
07-003-00016	60 x 90cm	Red



Cotton Bath / Face Towel

Product Code	Dimension	Colour	Type	Packaging
07-002-00230	75 x 150cm	<input type="checkbox"/> White		12pc/pkt
07-002-00233	30 x 30cm	<input type="checkbox"/> White	Thick	12pc/pkt
07-002-00234	30 x 30cm	<input type="checkbox"/> White	Thin	12pc/pkt



Cotton Good Morning Towel

Product Code	Dimension	Type	Packaging
07-002-00232	82.5 x 32.5cm	Thick	12pc/pkt



TRUST Superfine Microfiber Kitchen Cloth

Product Code	Dimension	Packaging	Colour
07-002-00254	48.3 x 60cm	12pcs/pkt	<input type="checkbox"/> Red
07-002-00255	48.3 x 60cm	12pcs/pkt	<input type="checkbox"/> Yellow
07-002-00256	48.3 x 60cm	12pcs/pkt	<input type="checkbox"/> Blue
07-002-00257	48.3 x 60cm	12pcs/pkt	<input type="checkbox"/> Green



Tea Towel

Product Code	Dimension	Packaging	Colour
07-002-00242	60 x 40cm	12pcs/pkt	<input type="checkbox"/> Blue
07-002-00243	60 x 40cm	12pcs/pkt	<input type="checkbox"/> Green
07-002-00244	60 x 40cm	12pcs/pkt	<input type="checkbox"/> Red
07-002-00245	65 x 45cm	12pcs/pkt	<input type="checkbox"/> Blue
07-002-00246	65 x 45cm	12pcs/pkt	<input type="checkbox"/> Green
07-002-00247	65 x 45cm	12pcs/pkt	<input type="checkbox"/> Red
07-002-00248	100 x 50cm	12pcs/pkt	<input type="checkbox"/> Blue

Glass Cloth

07-002-00251	70 x 50cm	12pcs/pkt	<input type="checkbox"/> Green
07-002-00252	70 x 50cm	12pcs/pkt	<input type="checkbox"/> Red
07-002-00253	70 x 50cm	12pcs/pkt	<input type="checkbox"/> Yellow



TRUST Microfiber Glass Cloth

Product Code	Dimension	Packaging	Colour
07-002-00241	40.6 x 40.6cm	12pcs/pkt	<input checked="" type="checkbox"/> Blue



3M Microfibre Cloths

The product is designed to absorb separately or together dust, dirt, fingerprints, grease and moisture. Can be used dry or damp, with or without chemicals. Machine-washable up to 95°C more than 50 times.

Product Code	Dimension	Packaging	Colour
07-002-00235	36 x 36cm	10pcs/pkt	<input checked="" type="checkbox"/> Dark Blue
07-002-00236	36 x 36cm	10pcs/pkt	<input checked="" type="checkbox"/> Green
07-002-00237	36 x 36cm	10pcs/pkt	<input checked="" type="checkbox"/> Gray
07-002-00238	36 x 36cm	10pcs/pkt	<input checked="" type="checkbox"/> Purple
07-002-00239	36 x 36cm	10pcs/pkt	<input checked="" type="checkbox"/> Red
07-002-00240	36 x 36cm	10pcs/pkt	<input checked="" type="checkbox"/> Yellow
07-002-00342	36 x 36cm	10pcs/pkt	<input type="checkbox"/> White



PAL Non-Woven Multipurpose Dry Wipers

Product Code	Packaging	Colour
07-002-00258	25pcs/pkt	<input checked="" type="checkbox"/> Blue
07-002-00259	25pcs/pkt	<input checked="" type="checkbox"/> Green
07-002-00260	25pcs/pkt	<input checked="" type="checkbox"/> Red
07-002-00261	25pcs/pkt	<input checked="" type="checkbox"/> Yellow



Stainless Steel Scraper with Wooden Handle

Product Code	Dimension
07-002-00188	5cm
07-002-00189	6.25cm
07-002-00190	7.5cm
07-002-00191	10cm



PAL TX Surface Wipes Medium 200

2.0L Canister for general disinfection of surfaces within food environments. This is an easy to store and convenient to use canister of 200 wipes making this a popular format for food environments as well as general use areas. Pal TX Surface Disinfectant wipes are Food safe and proven to kill most microorganisms such as bacteria, yeast & viruses. Pal TX Surface Disinfectant Wipes clean and disinfect without using Quats, PHMB or alcohol.

Product Code	Dimension	Packaging	
07-002-00328	19 x 20.5cm	200pcs/bot 10bot/ctn	Halal Certified



Stainless Steel Decanter Cleaning Ball

Product Code
07-002-00205



3M Extra Heavy Duty Scouring Pad

Product Code	Colour	Packaging
07-002-00207	Purple	1pc/pkt



3M Light Duty White Scouring Pad

Product Code	Dimension	Packaging
07-002-00211	15 x 9cm	1pc/pkt



3M Medium Duty Scrubbing Sponge

Product Code	Dimension	Packaging
07-002-00215	15 x 9cm	1pc/pkt



PAL Wall Bracket for Medium Wipes Dispenser

Product Code
07-002-00264(XX)



3M Heavy Duty Scouring Pad

Product Code	Dimension	Packaging
07-002-00206	13.7 x 9.7cm	1pc/pkt



3M Heavy Duty Scrubbing Pad with Anti-Microbial Sponge

Product Code	Dimension	Packaging
07-002-00208	11.2 x 7cm	1pc/pkt



3M General Purpose Scouring Pad

Product Code	Dimension	Packaging
07-002-00212	22.5 x 15cm	1pc/pkt



3M Extra Heavy Duty Scouring Pad

Product Code	Dimension	
07-002-00209	22.5 x 15cm	Tough fibres and abrasives clean grills and ovens.
07-002-00210	12.5 x 8.7cm	For extremely hard to remove stains on pots and pans. Removes heavily encrusted baked-on food.



3M General Purpose Scrubbing Pad

Product Code	Dimension	Packaging
07-002-00213	22.5 x 15cm	1pc/pkt
07-002-00214	15 x 10cm	12pcs/pkt



3M Scotch-Brite Low Scratch Scour Sponge 3001HEX

Product Code	Dimension	Packaging
07-002-00338	11.3 x 9.8cm	4pcs/pkt

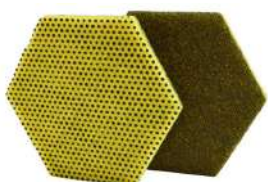

3M Scotch-Brite Scour Sponge 96HEX-FL

Product Code	Dimension	Packaging
07-002-00341	11.3 x 9.8cm	4pcs/pkt



3M General Purpose Scrubbing Sponge

Product Code	Dimension	Packaging
07-002-00216	10 x 7.5cm	6pcs/pkt



3M Light Duty Cleaning Sponge

Product Code	Dimension	Packaging
07-002-00217	15 x 9cm	2pcs/pkt



3M Light Duty Scrubbing Sponge

Product Code	Dimension	Packaging
07-002-00218	14 x 8.3cm	3pcs/pkt
07-002-00219	12.6 x 8.8cm	1pc/pkt



Coconut Brush

Product Code	Dimension
07-002-00194	10cm
07-002-00195	15cm



Heavy Duty Coconut Brush

Product Code	Dimension
07-002-00196	15cm



Toilet Brush with Holder

Product Code	Dimension
07-002-00197	40cm



CARLISLE Round Duster with Soft Flagged PVC Bristles

Product Code	Dimension	Matching Handle
07-002-00198	Ø18cm x H23cm	07-002-00168



3M Kitchen Cleaner and Degreaser Wipes with Scotchgard Protector

Product Code	Dimension	Packaging
07-002-00347	30.4 x 22.8cm	30pcs/pkt; 6pkts/ctn



3M Stainless Steel Cleaner & Polish

Product Code	Capacity
07-004-00011	600g



3M Sharpshooter Stain Remover

This no-rinse cleaner removes tough stains such as grease, lipstick, crayon, black heel marks, pencil marks and smoke film from most washable hard surfaces. Quart containers come with trigger sprayers. Authorized by USDA for use in federally inspected meat and poultry plants. Used on almost any washable hard surface, including: walls, floors, partitions, vinyl, chrome, grout, stainless steel, formica, fiberglass, ceramic, porcelain, etc.

Product Code	Capacity
07-004-00013	0.946ℓ



3M Quick Cleaning Liquid

A powerful griddle cleaning liquid that is safe for use on food contact surfaces. The Scotch-Brite™ Quick Clean Griddle Liquid loosens and lifts carbonized grease and food soil upon contact on a hot griddle for easy removal. No strong chemical odors or irritating fumes. Formulation does not contain caustic soda found in other griddle cleaning chemicals.

Product Code	Capacity
07-004-00016	0.946ℓ



ZEBRA Steel Cleaner

Product Code	Capacity
07-004-00010	250g



MAUVIEL Copper Polish "Copperbrill"

Product Code	Capacity
07-004-00012	0.15ℓ



3M Glass Cleaner and Protector with Trigger Sprayer

Product Code	Packaging
07-004-00017	12/CS



3M Stainless Cleaner with Scotch Guard Protector

Product Code	Packaging
07-004-00018	6/CS



3M Creme Cleanser

Product Code	Capacity
07-004-00015	0.946ℓ



UNICA Plastic Stool

Product Code	Dimension	Colour
07-008-00018	28.5 x 19 x 15cm	Red



TRUST Folding Stepstool

Product Code	Dimension	Capacity	Colour
07-008-00019	47.5 x 51.5 x 59cm	Max Load 150kg	Gray



TRUST Movable Stepstool

Product Code	Dimension	Capacity	Colour
07-008-00020	Ø40.6cm x H34.3cm	Max Load 160kg	Black



Aluminium Ladder with Safety Handrail

Product Code	Dimension	Type
07-008-00012	66 - 276cm	3 Steps
07-008-00013	88 - 298cm	4 Steps
07-008-00014	110 - 320cm	5 Steps
07-008-00015	132 - 342cm	6 Steps
07-008-00016	152 - 364cm	7 Steps
07-008-00017	173 - 386cm	8 Steps



SAN JAMAR Large Capacity Ultrafold Dispenser

High capacity, reduces need to refill frequently.

Product Code	Dimension	Capacity	Colour
07-007-00001	47.5 x 29.8 x 15.9cm	750 multifolds / 450C-folds	Black Pearl
07-007-00002	47.5 x 29.8 x 15.9cm	750 multifolds / 450C-folds	Arctic Blue



SAN JAMAR Integra™ Level Roll Towel Dispenser

Product Code	Dimension	Capacity	Colour
07-007-00003	34.2 x 29.2 x 28.5cm	Ø21.5 x W20.9cm rolls	Black
07-007-00004	34.2 x 29.2 x 28.5cm	Ø21.5 x W20.9cm rolls	Blue



SAN JAMAR Adjustable Mini Centerpull Towel Dispenser

Universal centerpull dispenser, adjusts for all grades of paper from single ply to industrial wipes.

Product Code	Dimension	Capacity	Colour
07-007-00007	31.4 x 19 x 18.7cm	Ø15.2cm rolls	Black Pearl
07-007-00008	34 x 24.4 x 23.8cm	Ø24.1 x 24.1cm wide rolls	Black Pearl



SAN JAMAR Smart Essence™ No Touch Roll Towel

Adjustable paper length (8", 12", 16") and delay (0, 1½, 3 seconds).

Product Code	Dimension	Capacity
07-007-00006	36.7 x 29.8 x 23.2cm	20cm wide rolls



C-Fold Junior Napkin Dispenser

Product Code
07-007-00010



SAN JAMAR Reserva® Jumbo Bath Tissue Dispenser

Holds one 9-10½" (230-270 mm) jumbo bath roll and one 5" (127 mm) single stub roll. Continual availability of paper provided by the Infinity System®.

Product Code	Dimension	Capacity	Colour
07-007-00012	31.5 x 42.5 x 14cm	JBT 23-27cm Stub 12.7cm	Black Pearl
07-007-00013	31.5 x 42.5 x 14cm	JBT 23-27cm Stub 12.7cm	Arctic Blue



SAN JAMAR Spare Key for All Soap & Washroom Dispensers

Product Code
07-007-00011



TRUST Ironing Organizer

Product Code	Dimension	Colour
07-009-00003	13.3 x 29.4cm	White



Foldable Ironing Board

Product Code	Dimension	
07-009-00002	105cm	Comes with fire proof cloth



SAN JAMAR Rely™ Hybrid Soap & Sanitizer Dispenser

Touchless electronic soap & sanitizer dispensing.

Product Code	Dimension	Capacity	Colour
07-007-00016	30.5 x 14 x 10.2cm	0.9ℓ	Black Pearl



SAN JAMAR Soap & Hand Sanitizer Dispenser

Product Code	Dimension	Colour
07-007-00014	26.7 x 11.4 x 11.1cm	Black Pearl
07-007-00015	26.7 x 11.4 x 11.1cm	Arctic Blue



Electric Insect Killer

Product Code	Dimension	Capacity	Elec. Spec.
07-001-00003	39.5 x 8.6 x 32cm	80m ²	230V / 50Hz / 40W
07-001-00004	65 x 8.6 x 32cm	150m ²	230V / 50Hz / 40W



BESSER VACUUM Cutlery Polisher / Dryer

Product Code	Dimension	Elec. Spec.
07-001-00002	60 x 53 x 40cm	230V / 50Hz / 500W



BESSER VACUUM Glass Polisher

Product Code	Dimension	Capacity	Elec. Spec.
07-001-00001	32.5 x 30 x 50cm	350 glasses/hr	230V / 50Hz / 1650W

APPAREL &
PROTECTIVE
WEAR



CHAPTER

08

SIA HUAT 
Beyond Foodservice Supplies

www.siahuat.com



FISCHER Stainless Steel Protective Glove

Product Code	Size	Colour
08-003-00001	XX-Small	Brown
08-003-00002	X-Small	Green
08-003-00003	Small	White
08-003-00004	Medium	Red
08-003-00005	Large	Blue



SAN JAMAR Cut Resistant Butcher Glove with Antimicrobial Agent

Product Code	Size	ANSI Level 4 cut protection
08-003-00060	X-Small	ANSI Level 4 cut protection
08-003-00058	Small	ANSI Level 4 cut protection
08-003-00057	Medium	ANSI Level 4 cut protection
08-003-00056	Large	ANSI Level 4 cut protection
08-003-00059	X-Large	ANSI Level 4 cut protection



Rubber Glove

Product Code	Size
08-003-00073	Medium
08-003-00072	Large
08-003-00075	X-Large



SAN JAMAR Bestguard® Oven Mitt with Kevlar® Webguard™

Protects up to 232°C for 30s.

Product Code	Dimension	Colour
08-003-00026	32.5cm	Black
08-003-00027	37.5cm	Black
08-003-00028	42.5cm	Black
08-003-00029	60cm	Black



SAN JAMAR Cut Resistant Glove with Dyneema® Fiber & Antimicrobial Agent

Product Code	Dimension	Size	Colour	ANSI Level 5 Cut Protection
08-003-00061	27.9cm	Large	Blue	ANSI Level 5 Cut Protection
08-003-00062	27.9cm	Medium	Blue	ANSI Level 5 Cut Protection
08-003-00063	27.9cm	Large	Red	
08-003-00064	27.9cm	Medium	Red	
08-003-00065	27.9cm	Large	Yellow	
08-003-00066	27.9cm	Medium	Yellow	



SAN JAMAR Mani-Kare™ Bandages Assorted

Mani-Kare® bandages have been specifically designed for dressing minor wounds that can contaminate foods during preparation. Mani-Kare® bandages are bright blue in color for easy detection in food if inadvertently dropped and for proper monitoring of wound dressing (even under gloves) by restaurant management. Includes 2 boxes of strip bandages (100pc), 1 box of small finger bandages (40pc), 1 box of knuckle bandages (40pc), 1 box of large fingertip bandages (25pc), and 1 box of large patch bandages (25pc).

Product Code	Capacity
08-003-00055(XX)	Assorted set of 6 boxes



Rubber Hand Glove

Product Code	Dimension	Size	Colour
08-003-00077	30cm	Small	Pink
08-003-00076	34cm	Medium	Pink
08-003-00074	38cm	Large	Pink



SAN JAMAR Bestgrip Oven Mitt with Kevlar® Webguard™

Heat protection up to 260°C for 60s.

Product Code	Dimension	Colour
08-003-00033	37.5cm	Tan / Black
08-003-00034	42.5cm	Tan / Black

SAN JAMAR Bestgrip Puppet Oven Mitt with Kevlar® Webguard™

Heat protection up to 260°C for 60s.

Product Code	Dimension	Colour
08-003-00035	37.5cm	Tan / Black
08-003-00036	42.5cm	Tan / Black

SAN JAMAR Silicon-Coated Oven Mitt

Heat protection up to 204°C for 30s.

Product Code	Dimension	Colour
08-003-00030	32.5cm	Silver
08-003-00031	37.5cm	Silver
08-003-00032	42.5cm	Silver

SAN JAMAR Cool Touch Flame™ Puppet Oven Mitt with Kevlar

Heat protection up to 280°C for 30s.

Product Code	Dimension	Colour
08-003-00037	30cm	Red
08-003-00038	37.5cm	Red
08-003-00039	45cm	Red

SAN JAMAR Cool Touch Flame™ Oven Mitt with Kevlar

Heat protection up to 280°C for 30s.

Product Code	Dimension
08-003-00040	30cm
08-003-00041	37.5cm
08-003-00042	45cm

SAFICO PRO Leather Baker's Gloves

Product Code	Dimension
08-003-00016	34.5cm
08-003-00017	44cm

SAFICO PRO Leather Baker's Mitts

Product Code	Dimension
08-003-00018	33.5cm
08-003-00019	43cm

SAN JAMAR Ultigrip Oven Mitt

Heat, cold, steam protection. Protects from -78°C up to 260°C for 15s.

Product Code	Dimension	Colour
08-003-00043	32.5cm	Black
08-003-00044	37.5cm	Black
08-003-00045	42.5cm	Black

SAN JAMAR Ultigrip Puppet Style Oven Mitt

Heat, cold, steam protection. Protects from -78°C up to 260°C for 15s.

Product Code	Dimension	Colour
08-003-00048	37.5cm	Black
08-003-00049	42.5cm	Black



MASTRAD Orka Pro Silicone Oven Mitt

Heat protection up to 300°C.

Product Code	Dimension	Colour
08-003-00078	28cm	Black
08-003-00079	43cm	Black



SAN JAMAR Oyster Shucking Glove

Product Code
08-003-00054



Silicon-Coated Oven Mitt

Product Code	Dimension	Colour
08-003-00068	35cm	Silver
08-003-00069	40cm	Silver



Cotton Labour Glove

Product Code	Capacity
08-003-00024	12pairs/pkt



SAN JAMAR Cool Touch Flame™ Hot Pads

Product Code	Dimension	Colour
08-003-00052	20 x 20cm	Maroon



SAN JAMAR Fryer Oven Mitt

Heat protection up to 260°C for 15s.

Product Code	Dimension	Colour
08-003-00051	35.6cm	Black



SAN JAMAR Frozen Food Glove with Safety Cuff

Cold protection as low as -17°C for 60s.

Product Code	Colour
08-003-00025	Orange



Synthetic Fiber Oven Mitt

Product Code	Dimension	Colour
08-003-00070	28cm	Beige
08-003-00071	22cm	Beige



Cotton White Hand Glove

Product Code	Capacity
08-003-00023	12pairs/pkt



SAN JAMAR Bestguard® Handle Holder

Protects up to 232°C for 15s.

Product Code	Dimension	Colour
08-003-00053	16.5 x 8.3cm	Black



SAN JAMAR Ultigrips Hot Pad

Protects from -18°C to 260°C for 15s.

Product Code	Dimension
08-003-00046	25.4 x 25.4cm
08-003-00047	17.8 x 17.8cm



PAL Royale Chef's Hat Non-Woven

Product Code	Dimension	Capacity
08-001-00108	20cm	10pcs/pkt, 5pkt/carton
08-001-00109	25cm	10pcs/pkt, 5pkt/carton
08-001-00110	30cm	10pcs/pkt, 5pkt/carton



PAL Chef's Hat Embossed Textured Paper

Product Code	Dimension	Capacity
08-001-00102	19.5cm	10pcs/pkt, 5pkt/carton
08-001-00103	26.5cm	10pcs/pkt, 5pkt/carton



PAL Forage Style Paper Hat

Product Code	Capacity	Colour
08-001-00104	100pcs/box, 10box/carton	□ Plain
08-001-00105	100pcs/box, 10box/carton	■ Red Stripe
08-001-00106	100pcs/box, 10box/carton	■ Blue Stripe

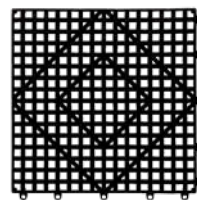

SAN JAMAR Versa-Mat Deck Tile

Product Code	Dimension	Colour
08-003-00050	30 x 30cm	■ Black



PAL La-Grande Chef's Hat Non-Woven

Product Code	Dimension	Capacity
08-001-00111	25cm	10pcs/pkt, 5pkt/carton
08-001-00112	30cm	10pcs/pkt, 5pkt/carton



PAL PICO Chef's Hat Viscose Non-Woven

Product Code	Dimension	Capacity
08-001-00113	25cm	10pcs/pkt, 5pkt/carton
08-001-00114	30cm	10pcs/pkt, 5pkt/carton



PAL Continental Chef's Hat Crepe Paper

Product Code	Dimension	Capacity
08-001-00101	23.5cm	10pcs/pkt, 5pkt/carton



PAL Chef's Hat Viscose Non-Woven

Product Code	Dimension	Capacity
08-001-00107	10cm	50pcs/pkt, 10pkt/carton



PAL Dorset Net Cap with Nylon Peak

Product Code	Capacity
08-002-00040	10pcs/pkt, 10pkt/carton



PAL Leicester Snood Polycotton

Product Code	Size	Capacity
08-002-00041	Large	10pcs/pkt, 10pkt/carton



PAL Rutland Snood Polycotton

Product Code	Size	Capacity
08-002-00042	Large	10pcs/pkt, 10pkt/carton
08-002-00043	X-Large	10pcs/pkt, 10pkt/carton



PAL Snood Cap Non-Woven Fabric

Product Code	Capacity
08-002-00034	100pcs/box, 5box/carton



PAL Bouffant Cap Non-Woven

Product Code	Capacity
08-002-00033	100pcs/pkt, 10pkt/carton



PAL PICO Mob Cap Single Elastic Non-Woven

Product Code	Capacity	Colour
08-002-00045	100pcs/pkt, 10pkt/carton	<input type="checkbox"/> White
08-002-00046	100pcs/pkt, 10pkt/carton	<input checked="" type="checkbox"/> Blue



PAL Mob Cap Double Elastic Polypropylene

Product Code	Capacity	Colour
08-002-00035	100pcs/pkt, 10pkt/carton	<input type="checkbox"/> White



PAL Lightweight Hair Net

Product Code	Capacity	Colour
08-002-00047	100pcs/box, 10box/carton	<input checked="" type="checkbox"/> Brown



SAFICO PRO Plastic Transparent Sanitary Mask

Product Code	Capacity
08-002-00031	10pcs/box, 20box/carton



SAFICO PRO Replacement Film for Plastic Transparent Sanitary Mask

Product Code	Capacity
08-002-00032	20pcs/pkt, 5pkt/carton



PAL High Filtration Face Mask (3-Ply)

Product Code	Capacity	Colour
08-002-00044	50pcs/pkt, 20pkt/carton	■ Blue



PAL Economy Face Mask (2-Ply)

Product Code	Capacity
08-002-00030	100pcs/pkt, 10pkt/carton



PAL Polyethylene Disposable Oversleeve

Product Code	Capacity	Colour
08-002-00021	100pcs/pkt, 20pkt/carton	□ White



PAL Polyethylene Disposable Overshoe

Product Code	Dimension	Capacity	Colour
08-002-00050	35cm	100pcs/pkt, 20pkt/carton	■ Blue



PAL Visitor's Coat Non-Woven

Product Code	Size	Capacity
08-002-00048	Large	25pcs/pkt, 4pkt/carton
08-002-00049	X-Large	25pcs/pkt, 4pkt/carton



PAL Polyethylene Disposable Apron

Product Code	Dimension	Capacity	Colour
08-001-00082	69 x 107cm	100pcs/box, 10box/carton	□ White
08-001-00083	69 x 107cm	100pcs/box, 10box/carton	■ Blue



PAL Nitrile Disposable Glove

Pal nitrile gloves are manufactured to a medical grade 1.5 AQL standard. They are a great alternative to Latex gloves in almost all environments, offering high dexterity and durability with excellent resistance to oils, acids and other chemicals.

Product Code	Size	Capacity	Colour
08-002-00013	Small	100pcs/box, 10box/carton	■ Blue
08-002-00014	Medium	100pcs/box, 10box/carton	■ Blue
08-002-00015	Large	100pcs/box, 10box/carton	■ Blue



PAL Powdered Disposable Vinyl Glove

Product Code	Size	Capacity	Colour
08-002-00001	Small	100pcs/box, 10box/carton	□ Clear
08-002-00002	Medium	100pcs/box, 10box/carton	□ Clear
08-002-00003	Large	100pcs/box, 10box/carton	□ Clear
08-002-00004	Small	100pcs/box, 10box/carton	■ Blue
08-002-00005	Medium	100pcs/box, 10box/carton	■ Blue
08-002-00006	Large	100pcs/box, 10box/carton	■ Blue



PAL Powderfree Disposable Vinyl Glove

Product Code	Size	Capacity	Colour
08-002-00007	Small	100pcs/box, 10box/carton	<input type="checkbox"/> Clear
08-002-00008	Medium	100pcs/box, 10box/carton	<input type="checkbox"/> Clear
08-002-00009	Large	100pcs/box, 10box/carton	<input type="checkbox"/> Clear
08-002-00010	Small	100pcs/box, 10box/carton	<input checked="" type="checkbox"/> Blue
08-002-00011	Medium	100pcs/box, 10box/carton	<input checked="" type="checkbox"/> Blue
08-002-00012	Large	100pcs/box, 10box/carton	<input checked="" type="checkbox"/> Blue



PAL Polyethylene Disposable Gloves

Product Code	Size	Capacity	Colour
08-002-00019	Medium	100pcs/box, 50box/carton	<input type="checkbox"/> Clear
08-002-00020	Large	100pcs/box, 50box/carton	<input type="checkbox"/> Clear



PAL Powderfree Disposable Vinyl Glove (4AQL)

Pal vinyl gloves are manufactured to 4 AQL from highest quality vinyl to give comfort and strength with beaded cuffs to resist tearing.

Product Code	Size	Capacity	Colour
08-002-00016	Small	100pcs/box, 10box/carton	<input type="checkbox"/> Clear
08-002-00017	Medium	100pcs/box, 10box/carton	<input type="checkbox"/> Clear
08-002-00018	Large	100pcs/box, 10box/carton	<input type="checkbox"/> Clear



PAL Powdered Disposable Vinyl Glove (4AQL)

Product Code	Size	Capacity	Colour
08-002-00022	Small	100pcs/box, 10box/carton	<input type="checkbox"/> Clear
08-002-00023	Medium	100pcs/box, 10box/carton	<input type="checkbox"/> Clear
08-002-00024	Large	100pcs/box, 10box/carton	<input type="checkbox"/> Clear
08-002-00025	Small	100pcs/box, 10box/carton	<input checked="" type="checkbox"/> Blue
08-002-00026	Medium	100pcs/box, 10box/carton	<input checked="" type="checkbox"/> Blue
08-002-00027	Large	100pcs/box, 10box/carton	<input checked="" type="checkbox"/> Blue



PAL Stainless Steel Glove Box Holder

Product Code
08-002-00028



PAL Eco-Pak Glove Dispenser

Pal Ecopak Dispenser can be used to dispense a variety of Pal products. This dual purpose dispenser can be installed horizontally to dispense Pal aprons on-a-roll or vertically to dispense a range of headwear and workwear including Pal mob caps, overshoes and oversleeves. It is easy to install and is a great way to hygienically store and dispense high use products helping to keep the workplace tidy. Colour coded options for various user areas.

Product Code	Dimension	Colour
08-002-00029	51 x 22 x 20cm	<input checked="" type="checkbox"/> Blue / <input type="checkbox"/> White



pal[®]

Hygiene at work. Everywhere.



A UK Company established
for over 40 years

Disinfectant Wipes & Hygiene Workwear

for the food and beverage industry



Quality
Efficacy
Innovation
Cost Effectiveness.

Available from
Sia Huat Pte Ltd

enquiry@siahuat.com.sg

WE ARE THE
FORCE
BEHIND THE
FORCE



SFC CAMBRIDGE Men's Work Shoes

Product Code	Euro Size	US Size	Colour
08-001-00415(XX)	38	6	Black
08-001-00182	39	7	Black
08-001-00183	40	7.5	Black
08-001-00184	41	8	Black
08-001-00185	42	9	Black
08-001-00186	43	10	Black
08-001-00187	44	10.5	Black
08-001-00188	45	11	Black
08-001-00189	46	12	Black
08-001-00416(XX)	47	13	Black



SFC ZINC Slip Shoes

Product Code	Euro Size	US Size	Colour
08-001-00356	37	4	Black
08-001-00357	38	5	Black
08-001-00358	39	6	Black
08-001-00359	40	7	Black
08-001-00360	41	8	Black
08-001-00361	42	9	Black
08-001-00362	43	10	Black
08-001-00363	44	11	Black
08-001-00364	45	12	Black
08-001-00365	46	13	Black
08-001-00366	47	14	Black



SFC GUARDIAN Steel Toe IV Boots

Product Code	Euro Size	US Size	Colour
08-001-00428	37	5	White
08-001-00429	38	6	White
08-001-00430	39	7	White
08-001-00431	41	8	White
08-001-00432	42	9	White
08-001-00433	43	10	White
08-001-00434	45	11	White
08-001-00435	46	12	White
08-001-00436	47	13	White



SFC ENVY III Ladies Work Shoes

Product Code	Euro Size	US Size	Colour
08-001-00291	35	5	Black
08-001-00292	36	5.5	Black
08-001-00293	37	6.5	Black
08-001-00294	38	7.5	Black
08-001-00295	39	8.5	Black
08-001-00296	40	9	Black



SFC RADIUM Slip Shoes

Product Code	Euro Size	US Size	Colour
08-001-00344	36	3	Black
08-001-00345	37	4	Black
08-001-00346	38	5	Black
08-001-00347	39	6	Black
08-001-00348	40	7	Black
08-001-00349	41	8	Black
08-001-00350	42	9	Black
08-001-00351	43	10	Black
08-001-00352	44	11	Black
08-001-00353	45	12	Black
08-001-00354	46	13	Black
08-001-00355	47	14	Black



SFC ENDEAVOR III Aluminium Toe

Product Code	Euro Size	US Size	Colour
08-001-00422	36.5	4.5	Black
08-001-00423	37	5	Black
08-001-00424	38	6	Black
08-001-00425	39	7	Black
08-001-00426	41	8	Black
08-001-00427	42	9	Black
08-001-00417	43	10	Black
08-001-00418	45	11	Black
08-001-00419	46	12	Black
08-001-00420	47	13	Black



SFC FREESTYLE II Men's Shoes

Product Code	Euro Size	US Size	Colour
08-001-00309	39	7	Black
08-001-00310	40	7.5	Black
08-001-00311	41	8	Black
08-001-00312	42	9	Black
08-001-00313	43	10	Black
08-001-00314	44	10.5	Black
08-001-00315	45	11	Black
08-001-00316	46	12	Black



SFC LIBERTY Women's Shoes

Product Code	Euro Size	US Size	Colour
08-001-00297	35	5	Black
08-001-00298	36	5.5	Black
08-001-00299	37	6.5	Black
08-001-00300	38	7.5	Black



SAFICO PRO Half Size Apron

Product Code	Dimension	Pocket	Colour
08-001-00098	60 x 90cm	3 Pockets	Black/White



SAFICO PRO Half Size Cotton Apron

Product Code	Dimension	Pocket	Colour
08-001-00089	70 x 75cm	1 Pocket	Black
08-001-00090	85 x 90cm	3 Pockets	Black



SAFICO PRO Full Size PVC Apron

Product Code	Dimension	Colour
08-001-00084	106 x 68cm	Black



GIESSER Stainless Steel Mesh Safety Apron

Product Code	Dimension
08-003-00007(XX)	55 x 78cm



SAFICO PRO Full Size Cotton Apron

Product Code	Dimension	Colour
08-001-00085	90 x 73cm	Black
08-001-00086	90 x 73cm	Dark Blue
08-001-00087	90 x 73cm	Maroon
08-001-00088	90 x 73cm	White



SAFICO PRO Thermal Parka Jacket with Hood & Reflective Stripes

Product Code	Size	Colour
08-003-00010	Medium	Blue
08-003-00009	Large	Blue
08-003-00011	X-Large	Blue
08-003-00012(XX)	XX-Large	Blue



SAFICO PRO Ultra Thick Winter Parka

Product Code	Size
08-003-00013(XX)	Large
08-003-00015(XX)	X-Large



Short Sleeve Chef's Uniform (White with White Buttons)

Product Code	Size
08-001-00012	M
08-001-00011	L
08-001-00013	XL
08-001-00014	XXL
08-001-00015	XXXL



Short Sleeve Chef's Uniform (White with Black Buttons)

Product Code	Size
08-001-00017	M
08-001-00016	L
08-001-00018	XL
08-001-00019	XXL
08-001-00020	XXXL



Short Sleeve Worker's Shirt (White Buttons)

Product Code	Size
08-001-00022	M
08-001-00021	L
08-001-00023	XL
08-001-00024	XXL



Short Sleeve Shirt without Collar

Product Code	Size
08-001-00048	M
08-001-00047	L



Short Sleeve Chef's Uniform (Black Trimming with Black Buttons)

Product Code	Size
08-001-00032	S
08-001-00031	M
08-001-00030	L
08-001-00033	XL
08-001-00034	XXL
08-001-00035	XXXL



Short Sleeve Chef's Uniform (Black Trimming with Pearl Black Buttons)

Product Code	Size
08-001-00043	M
08-001-00042	L
08-001-00044	XL
08-001-00045	XXL
08-001-00046	XXXL



Short Sleeve Chef's Uniform (Black Trimming with Pressed Buttons)

Product Code	Size
08-001-00055	M
08-001-00054	L
08-001-00056	XL
08-001-00057	XXL
08-001-00058	XXXL



Long Sleeve Chef's Uniform (White with White Buttons)

Product Code	Size
08-001-00002	M
08-001-00001	L
08-001-00003	XL
08-001-00004	XXL
08-001-00005	XXXL



Long Sleeve Chef's Uniform (White with Black Buttons)

Product Code	Size
08-001-00007	M
08-001-00006	L
08-001-00008	XL
08-001-00009	XXL
08-001-00010	XXXL



Long Sleeve Chef's Uniform (Black Trimming with Black Buttons)

Product Code	Size
08-001-00026	M
08-001-00025	L
08-001-00027	XL
08-001-00028	XXL
08-001-00029	XXXL



Long Sleeve Chef's Uniform (Black Trimming with Pearl Black Buttons)

Product Code	Size
08-001-00037	M
08-001-00036	L
08-001-00038	XL
08-001-00039	XXL
08-001-00040	XXXL
08-001-00041	XXXXL



Long Sleeve Chef's Uniform (Black Trimming with Pressed Buttons)

Product Code	Size
08-001-00051	S
08-001-00050	M
08-001-00049	L
08-001-00052	XL
08-001-00053	XXXL

**Chef's Pants**

Product Code	Size	Colour
08-001-00078	M	Black
08-001-00077	L	Black
08-001-00079	XL	Black
08-001-00080	XXL	Black
08-001-00075	XXXL	Black/White Checked
08-001-00076	XXXXL	Black/White Checked

**DENNYS Bib Apron with Pocket**

Product Code	Dimension	Type
08-001-00317	L100 x W80cm	Sea Grass
08-001-00318	L100 x W80cm	Claret
08-001-00319	L100 x W80cm	Olive
08-001-00320	L100 x W80cm	Peat
08-001-00321	L100 x W80cm	Griffin

**LE CHEF PREP Crossover Bib Apron**

Product Code	Dimension	Colour
08-001-00407	L90 x W70cm	Black
08-001-00341	L90 x W70cm	Khaki

**LE CHEF Apron without Adjustable Halter**

Product Code	Dimension	Colour
08-001-00408	L17 x H96cm	Black/White Stripe

**LE CHEF PREP Statement Denim Bib Apron with Adjustable Leather Halter**

Product Code	Dimension	Colour
08-001-00342	L90 x W70cm	Indigo

**LE CHEF STAYCOOL Short Sleeve Chef Academy Tunic (White)**

Product Code	Size
08-001-00273	XS
08-001-00272	S
08-001-00271	M
08-001-00270	L
08-001-00269	XL
08-001-00268	XXL



LE CHEF STAYCOOL Short Sleeve Chef Uniform (White with Black Underarm Side Panels)

Product Code	Size
08-001-00261	XS
08-001-00260	S
08-001-00259	M
08-001-00258	L
08-001-00257	XL
08-001-00256	XXL



LE CHEF STAYCOOL Short Sleeve Chef Uniform (White)

Product Code	Size
08-001-00267	XS
08-001-00266	S
08-001-00265	M
08-001-00264	L
08-001-00263	XL
08-001-00262	XXL



LE CHEF LITE WEIGHT Short Sleeve Chef Jacket (White)

Product Code	Size
08-001-00389	XS
08-001-00390	S
08-001-00391	M
08-001-00392	L
08-001-00393	XL
08-001-00394	XXL



LE CHEF PREP Short Sleeve Chef Jacket (White)

Product Code	Size
08-001-00327	S
08-001-00328	M
08-001-00329	L
08-001-00330	XL
08-001-00331	XXL



LE CHEF PREP Short Sleeve Chef Shirt with Collar (White)

Product Code	Size
08-001-00322	S
08-001-00323	M
08-001-00324	L
08-001-00325	XL
08-001-00326	XXL



LE CHEF STAYCOOL Long Sleeve Chef Uniform with White Removable Studs (White)

Product Code	Size
08-001-00285	XS
08-001-00284	S
08-001-00283	M
08-001-00282	L
08-001-00281	XL
08-001-00280	XXL



LE CHEF LITEWEIGHT Short Sleeve Chef Jacket (Black)

Product Code	Size
08-001-00382	XS
08-001-00381	S
08-001-00277	M
08-001-00276	L
08-001-00275	XL
08-001-00274	XXL



LE CHEF PREP Short Sleeve Chef Jacket (Black)

Product Code	Size
08-001-00395	XS
08-001-00396	S
08-001-00397	M
08-001-00398	L
08-001-00399	XL
08-001-00400	XXL



LE CHEF PREP Short Sleeve Chef Jacket (Grey)

Product Code	Size
08-001-00332	S
08-001-00333	M
08-001-00334	L
08-001-00335	XL
08-001-00336	XXL



LE CHEF STAYCOOL Short Sleeve Chef Uniform (Black with Black Underarm Side Panels)

Product Code	Size
08-001-00383	XS
08-001-00384	S
08-001-00385	M
08-001-00386	L
08-001-00387	XL
08-001-00388	XXL



LE CHEF Chef Pants (Black)

Product Code	Size
08-001-00380	XS
08-001-00379	S
08-001-00290	M
08-001-00289	L
08-001-00288	XL
08-001-00287	XXL
08-001-00286	XXXL



LE CHEF PREP Trousers Cross Dyed Denim (Black)

Product Code	Size
08-001-00401	XS
08-001-00402	S
08-001-00403	M
08-001-00404	L
08-001-00405	XL
08-001-00406	XXL

CATERING,
BUFFET & FOOD
TRANSPORTATION



CHAPTER

09

SIA HUAT 
Beyond Foodservice Supplies

www.siahuat.com



Stainless Steel Rice Pot / Warmer Stand

Product Code	Dimension
09-003-00001	Ø40.5 x H66.5cm
09-003-00002	Ø36.5 x H66cm



ZEBRA Stainless Steel Food Carrier with Smart Lock

Product Code	Dimension	Capacity
09-003-00145	Ø14cm	4-Tier



ZEBRA Stainless Steel Loop Handle Pot with Auto Lock & 1 Insert

Product Code	Dimension
09-003-00146	Ø10cm
09-003-00147	Ø12cm
09-003-00148	Ø14cm
09-003-00149	Ø16cm



Stainless Steel Insulated Pot with Lid

Product Code	Dimension	Capacity
09-003-00012	Ø27 x H27cm	15ℓ
09-003-00013(XX)	Ø30 x H30cm	20ℓ
09-003-00014(XX)	Ø35 x H35cm	30ℓ
09-003-00015(XX)	Ø35 x H48cm	45ℓ
09-003-00016(XX)	Ø40 x H45cm	55ℓ
09-003-00017(XX)	Ø45 x H45cm	70ℓ
09-003-00018(XX)	Ø45 x H60cm	90ℓ



Plastic Insulated Bucket

Product Code	Capacity	Colour
09-003-00177	2ℓ	Red
09-003-00178	2ℓ	Blue
09-003-00179	2ℓ	Green
09-003-00180	4ℓ	Red
09-003-00181	4ℓ	Blue
09-003-00182	4ℓ	Green
09-003-00183	5.5ℓ	Red
09-003-00184	5.5ℓ	Blue
09-003-00185	5.5ℓ	Green
09-003-00186	9ℓ	Red
09-003-00187	9ℓ	Blue
09-003-00188	9ℓ	Green
09-003-00189	15.5ℓ	Red
09-003-00190	15.5ℓ	Blue
09-003-00191	15.5ℓ	Green
09-003-00192	18ℓ	Red
09-003-00193	18ℓ	Blue
09-003-00194	18ℓ	Green
09-003-00195	25ℓ	Red
09-003-00196	25ℓ	Blue
09-003-00197	25ℓ	Green
09-003-00198	25ℓ	Grey



ZEBRA Stainless Steel Food Carrier

Product Code	Dimension	Capacity
09-003-00132	Ø12cm	2-Tier
09-003-00133	Ø12cm	3-Tier
09-003-00134	Ø12cm	4-Tier
09-003-00136	Ø14cm	2-Tier
09-003-00137	Ø14cm	3-Tier
09-003-00138	Ø14cm	4-Tier
09-003-00139	Ø14cm	5-Tier
09-003-00140	Ø16cm	3-Tier
09-003-00141	Ø16cm	4-Tier
09-003-00142	Ø16cm	5-Tier



Stainless Steel Insulated Tea Warmer with Faucet

Product Code	Dimension	Capacity
09-003-00019(XX)	Ø18 x H18cm	4ℓ
09-003-00020(XX)	Ø20 x H20cm	6ℓ
09-003-00021(XX)	Ø22 x H22cm	8ℓ
09-003-00022(XX)	Ø27 x H20cm	10ℓ
09-003-00023(XX)	Ø30 x H23cm	15ℓ
09-003-00024(XX)	Ø35 x H28cm	25ℓ
09-003-00025(XX)	Ø40 x H30cm	35ℓ
09-003-00026(XX)	Ø45 x H33cm	50ℓ
09-003-00027(XX)	Ø45 x H40cm	60ℓ
09-003-00036(XX)	Ø50 x H42cm	80ℓ
09-003-00037(XX)	Ø50 x H52cm	100ℓ



Stainless Steel Insulated Rice Warmer with Faucet

Product Code	Dimension	Capacity
09-003-00039(XX)	Ø18 x H18cm	4ℓ
09-003-00040(XX)	Ø20 x H20cm	6ℓ
09-003-00041(XX)	Ø22 x H22cm	8ℓ
09-003-00028(XX)	Ø27 x H20cm	10ℓ
09-003-00029(XX)	Ø30 x H23cm	15ℓ
09-003-00030(XX)	Ø35 x H28cm	25ℓ
09-003-00031(XX)	Ø40 x H30cm	35ℓ
09-003-00032(XX)	Ø45 x H33cm	50ℓ
09-003-00033(XX)	Ø45 x H40cm	60ℓ
09-003-00034(XX)	Ø50 x H42cm	80ℓ
09-003-00035(XX)	Ø50 x H52cm	100ℓ



09-003-00154



09-003-00155



09-003-00156



09-003-00157



09-003-00158

CARLISLE Cateraid™ Insulated Ice Caddy

Product Code	Dimension	Capacity	Colour	Type	Wheels Type
09-003-00154	86.7 x 59.7 x 98.4cm	90kg	Brown	2 Swivel Casters, 1 w/ Brake	10"
09-003-00155	86.7 x 59.7 x 98.4cm	90kg	Black	2 Swivel Casters, 1 w/ Brake	10"
09-003-00156	72.4 x 58.5 x 97.5cm	57kg	Black	2 Swivel Casters, 1 w/ Brake	8"
09-003-00157	75.1 x 58.4 x 74.6cm	57kg	Brown	4 Swivel Casters, 1 w/ Brake	5"
09-003-00158	75.1 x 58.4 x 74.6cm	57kg	Black	4 Swivel Casters, 1 w/ Brake	5"



SAN JAMAR SAF-T-Ice Tote

Product Code	Capacity	Colour
09-003-00159	22.7ℓ	Clear Blue
09-003-00160	18.9ℓ	Clear Blue



Snap Tight Lid for SAF-T-Ice Tote

Product Code
09-003-00161



SAN JAMAR SAF-T-Ice Tote

Double the productivity. Transport 2 Saf-T-Ice totes. Totes sold separately.

Product Code	Capacity
09-003-00162	For 22.7ℓ
09-003-00163	For 18.9ℓ



SAN JAMAR SAF-T-Ice Value Pack

Product Code	Add. Info.
09-003-00164	Includes 1 Saf-T-Ice tote (22.7L), 1 64/86oz Saf-T-Scoop and 1 Guardian system.



CAMBRO Cooling Pack for Transport Carts and Ultra Pan Carriers - Camchiller

Product Code	Dimension	Capacity	Colour
09-003-00046	53 x 33 x 3.8cm	GN 1/1	Cold Blue



CAMBRO Slant Top Ice Caddy with Sliding Lid

Product Code	Dimension	Capacity	Colour
09-003-00166	57 x 77 x 73cm	46kg	Coffee Beige
09-003-00171	57 x 77 x 73cm	46kg	Granite Gray



CAMBRO Ice Caddy with Sliding Lid

Product Code	Dimension	Capacity	Colour
09-003-00167	58.5 x 80 x 74.5cm	57kg	Dark Brown
09-003-00172	58.5 x 80 x 74.5cm	57kg	Dark Brown
09-003-00170	61 x 95.5 x 74.5cm	80kg	Dark Brown



CAMBRO Barrier for Transport Carts & Ultra Pan Carriers - Thermobarrier

Product Code	Dimension	Colour	
09-003-00050	53 x 33.5 x 3.8cm	Slate Blue	Fits for UPC1600, Camkiosk, UPC1600TR
09-003-00051	53 x 33.5 x 3.8cm	Coffee Beige	Fits for 300MPC, UPC600, 1318MTC
09-003-00052	53 x 33.5 x 3.8cm	Gray	Fits for UPC400, UPC800, UPC400TR, UPCS400, UPC800TR



CAMBRO Tall Ice Caddy with Sliding Lid

Polyethylene body and thick foam insulation enables holding of ice for days. Recessed well and drain shelf keep ice out of water, extending holding times.

Product Code	Dimension	Capacity	Colour
09-003-00169	58.5 x 80 x 88cm	57kg	Dark Brown
09-003-00173	58.5 x 86.5 x 95.5cm	80kg	Coffee Beige
09-003-00174	58.5 x 86.5 x 100.5cm	91kg	Dark Brown



CAMBRO Insulated Front Loader Ultra Pan Carrier S-Series

Product Code	Dimension	Capacity	Colour
09-003-00047	46 x 63.5 x 63cm	Fits 6 x GN 1/1 (6.5cm deep) pans	Dark Brown
09-003-00048	46 x 63.5 x 63cm	Fits 6 x GN 1/1 (6.5cm deep) pans	Speckled Gray



09-003-00048



09-003-00055



09-003-00056



09-003-00057



09-003-00058

CAMBRO Polyethylene Insulated Transport Cart Ultra Camcarts

Product Code	Dimension	Capacity	Colour
09-003-00055(XX)	72.5 x 82 x 116cm	Fits 8 x GN 2/1 pans, or 16 x GN 1/1 pans (6.5cm deep)	Dark Brown
09-003-00056(XX)	71.5 x 82 x 135cm	Fits 8 x GN 2/1 pans, or 16 x GN 1/1 pans (6.5cm deep)	Dark Brown
09-003-00057(XX)	52 x 69 x 137cm	Fits 12 x GN 1/1 pans (6.5cm deep)	Dark Brown
09-003-00058(XX)	52 x 69 x 137cm	57k Fits 12 x GN 1/1 pans (6.5cm deep)	Granite Gray



09-002-00012



09-002-00013



09-002-00014



09-002-00015



09-002-00016

CAMBRO Hot Holding / Heated Transport Cart

Product Code	Dimension	Capacity	Elec. Spec.	Colour
09-002-00012(XX)	73 x 84.7 x 137.5cm	Fits 12 x GN 2/1 pans, or 24 x GN 1/1 pans (6.5cm deep)	230V / 50Hz / 506W	Granite Gray
09-002-00013(XX)	46 x 67 x 63cm	Fits 6 x GN 1/1 pans (6.5cm deep)	230V / 50Hz / 265W	Dark Brown
09-002-00014(XX)	46 x 67 x 63cm	Fits 6 x GN 1/1 pans (6.5cm deep)	230V / 50Hz / 265W	Granite Gray
09-002-00015(XX)	52 x 69 x 137.2cm	Fits 12 x GN 1/1 pans (6.5cm deep)	230V / 50Hz / 265W	Dark Brown
09-002-00016(XX)	52 x 69 x 137.2cm	Fits 12 x GN 1/1 pans (6.5cm deep)	230V / 50Hz / 265W	Granite Gray



CAMBRO Mobile Food / Salad Bar with Standard Casters

Product Code	Dimension	Capacity
09-002-00003(XX)	208.3 x 108 x 159.4cm	183cm VERSA



CAMBRO Mobile Food / Salad Bar with Heavy-Duty Casters

Product Code	Dimension	Capacity
09-002-00005(XX)	175.3 x 108 x 141.6cm	152cm VERSA



CAMBRO Accessory Tray Rail for Versa Food Bar 09-002-00003(XX)

Product Code	Dimension	Colour
09-002-00007	167.6 x 29.2 x 11.6cm	Black



CAMBRO Accessory Tray Rail for Versa Food Bar 09-002-00005(XX)

Product Code	Dimension	Colour
09-002-00006	134.6 x 29.2 x 11.6cm	Granite Gray



CAMBRO Insulated Transport Container Pancarrier S-Series

Product Code	Dimension	Capacity	Colour
09-003-00059(XX)	64 x 43.5 x 30.5cm	Fits GN 1/1 pan	■ Speckled Gray

COLEMAN Chiller Pack

Product Code	Capacity
09-003-00060	350ml



09-003-00062



09-003-00063



09-003-00072



09-003-00065/66/69



09-003-00074

COLEMAN PolyLite Cooler

Product Code	Dimension	Capacity
09-003-00063	27 x 21 x 18cm	4.7ℓ
09-003-00072	25 x 17.5 x 18cm	8.5ℓ
09-003-00062	40 x 30 x 28cm	15.1ℓ
09-003-00065	57 x 34 x 37cm	45.4ℓ
09-003-00069	57 x 42 x 38cm	51.1ℓ
09-003-00074	80 x 45 x 45cm (with wheels)	58.6ℓ
09-003-00066	70 x 40 x 45cm	66.2ℓ

*Available in ■ Red and ■ Blue Colours



THERMOFUTURE BOX Shelf for Cool Pack for GN 1/1

Product Code	Dimension	Colour
09-003-00080	60 x 40cm (GN1/1)	■ Black



THERMOFUTURE BOX EPP Insulated Box GN 1/1 Premium

Product Code	Dimension	Capacity	Colour
09-003-00075	60 x 40 x 18cm (Internal)	21ℓ	■ Black
09-003-00076	60 x 40 x 23cm (Internal)	30ℓ	■ Black
09-003-00077	60 x 40 x 28cm (Internal)	39ℓ	■ Black
09-003-00078	60 x 40 x 32cm (Internal)	46ℓ	■ Black
09-003-00079	60 x 40 x 40cm (Internal)	61ℓ	■ Black



THERMOFUTURE BOX Accessory Lid for GN 1/1 Premium

Product Code	Dimension	Colour
09-003-00081	60 x 40cm (GN1/1)	■ Black



THERMOFUTURE BOX Accessory Lid with Integrated Thermometer

Product Code	Colour	Add. Info.
09-003-00082	■ Black	(from -30°C up to +90°C)

THERMOFUTURE BOX EPP Insulated Stackable Box Salto GN 1/1

Product Code	Dimension	Capacity	Colour
09-003-00083	60 x 40 x 12.5cm 53.8 x 33.7 x 8cm (Internal)	15ℓ	■ Black
09-003-00084	60 x 40 x 16.5cm 53.8 x 33.7 x 12cm (Internal)	21ℓ	■ Black

THERMOFUTURE BOX EPP Insulated Box GN 1/1 Deluxe

Product Code	Dimension	Capacity	Colour
09-003-00085	67.5 x 40 x 29cm 53.5 x 32.5 x 21.5cm (Internal)	37ℓ	■ Black
09-003-00086	67.5 x 40 x 33.5cm 53.5 x 32.5 x 26cm (Internal)	45ℓ	■ Black

THERMOFUTURE BOX Accessory Cooling Top for GN 1/1 Deluxe

Product Code	Dimension	Colour
09-003-00087	67.5 x 40cm	■ Black

THERMOFUTURE BOX EPP Foldable Insulated Box GN 1/1 Falbox

Product Code	Dimension	Capacity
09-003-00088	60 x 40 x 25cm 60 x 40 x 11cm (Folded) 55 x 35 x 20cm (Internal)	38ℓ

THERMOFUTURE BOX EPP Transport Box Frontloader

Product Code	Dimension	Capacity
09-003-00089	64.5 x 44.5 x 62.5cm	93ℓ Fits 6 x GN 1/1 (6.5cm deep)

THERMOFUTURE BOX EPP Foldable Insulated Box

Product Code	Dimension	Capacity	Size
09-003-00203	55 x 35 x 17cm (External)	33ℓ	GN 1/1

THERMOFUTURE BOX EPP Insulated Box

Product Code	Dimension	Capacity	Type
09-003-00204	54 x 33 x 38.5cm (Internal)	69ℓ	Fits 5 x GN 1/1 (6.5cm deep)

THERMOFUTURE BOX EPP Delivery Box Frontloader Pizza

Product Code	Dimension	Capacity	Colour
09-003-00094	49 x 49 x 54cm 42 x 42cm (Internal)	83ℓ	■ Black



THERMOFUTURE BOX EPP Insulated Box GN 1/2 Premium

Product Code	Dimension	Capacity	Colour
09-003-00090	39 x 33 x 18cm 33 x 27 x 11.7cm (Internal)	10ℓ	■ Black
09-003-00091	39 x 33 x 23cm 33 x 27 x 16.7cm (Internal)	15ℓ	■ Black
09-003-00092	39 x 33 x 28cm 33 x 27 x 21.7cm (Internal)	19ℓ	■ Black



THERMOFUTURE BOX EPP Insulated Box Allround 60x40

Product Code	Dimension	Capacity	Colour
09-003-00095	68.5 x 48.5 x 18cm 62.5 x 42.5 x 12cm (Internal)	32ℓ	■ Black
09-003-00096	68.5 x 48.5 x 22cm 62.5 x 42.5 x 16cm (Internal)	42ℓ	■ Black
09-003-00097	68.5 x 48.5 x 26cm 62.5 x 42.5 x 20cm (Internal)	53ℓ	■ Black
09-003-00098	68.5 x 48.5 x 36cm 62.5 x 42.5 x 30cm (Internal)	80ℓ	■ Black



THERMOFUTURE BOX EPP Insulated Box for Ice Cream Container Ice-Box

Product Code	Dimension	Capacity	Colour
09-003-00103	60 x 40 x 26cm 2 x (36 x 25 x 15cm) (Internal)	2 x 8ℓ	■ Black
09-003-00104	60 x 40 x 26cm 3 x (36 x 25 x 15cm) (Internal)	3 x 8ℓ	■ Black

THERMOFUTURE BOX Accessory Cooling Top for GN 1/2 Premium

Product Code	Dimension	Colour
09-003-00093	39 x 33cm	■ Black For GN 1/2 Premium
09-003-00099	68.5 x 48.5cm	■ Black For Allround 60x40



THERMOFUTURE BOX Spare Lid for Salto 60x40

Product Code	Colour
09-003-00100	■ Black



THERMOFUTURE BOX EPP Insulated Stackable Box Salto 60x40

Product Code	Dimension	Capacity	Colour
09-003-00101	68.5 x 48.5 x 12.5cm 62.5 x 42.5 x 8cm (Internal)	18ℓ	■ Black
09-003-00102	68.5 x 48.5 x 16.5cm 62.5 x 42.5 x 12cm (Internal)	32ℓ	■ Black



THERMOFUTURE BOX Accessory Extension Frames for Ice-Box

Product Code	Dimension	Colour
09-003-00105	60 x 40 x 8.5cm	■ Black

THERMOFUTURE BOX EPP Insulated Box with High Lid & Carrying Belt

Product Code	Dimension	Capacity	Colour
09-003-00108	42.5 x 28 x 42cm 36.5 x 22.5 x 36.5cm (Internal)	27ℓ	■ Black

THERMOFUTURE BOX EPP Insulated Shopping Box with Carrying Belt

Product Code	Dimension	Capacity	Colour
09-003-00106	32.5 x 25.5 x 32.5cm 27.5 x 21.5 x 26cm (Internal)	15ℓ	■ Black
09-003-00107	41 x 33 x 39cm 36.5 x 27.5 x 32cm (Internal)	24ℓ	■ Black

 09-003-00109 / 09-003-00175 /
09-003-00199 / 09-003-00208

09-003-00110/111/112/117/118/119

THERMOFUTURE BOX Cooling Pack

Colour coded cooling system! Pack with 3 different temperatures for all types of food. Solid quality with reinforced edges. Specially designed to avoid bending when frozen. For cool packs to reach their desired temperatures, a freezer of at least 6°C lower than the indicated temperature of cool pack is recommended. Freezing takes approximately 5 hours to complete.

Colour	Temperature	For	Product Code	Dimension	Capacity
■ Frozen Yellow	-21°C	Frozen food, ice cream	09-003-00109	26.5 x 16.2 x 3cm	GN1/4
			09-003-00112	32.5 x 17.6 x 3cm	GN1/3
			09-003-00199	53 x 32.5 x 2.5cm	GN1/1
			09-003-00119	60 x 40 x 2.8cm	60x40
■ Cold Blue	-12°C	Meat, Seafood	09-003-00111	32.5 x 17.6 x 3cm	GN1/3
			09-003-00208	53 x 32.5 x 2.5cm	GN1/1
			09-003-00118	60 x 40 x 2.8cm	60x40
■ Fresh Green	-3°C	Vegetables, Cheese	09-003-00110	32.5 x 17.6 x 3cm	GN1/3
			09-003-00175	53 x 32.5 x 3cm	GN 1/1
			09-003-00117	60 x 40 x 2.8cm	60x40

THERMOFUTURE BOX Pizza Soft Bag with Carrying Belt

Product Code	Dimension	Add. Info
09-003-00150	40 x 40 x 25cm	Oven hot pizza 70 - 80°C

THERMOFUTURE BOX Pizza Soft Bag Warm-Bag

Product Code	Dimension	
09-003-00152(XX)	40 x 40 x 25cm	With 12V supply cord
09-003-00153(XX)	45 x 45 x 25cm	With 12V supply cord

THERMOFUTURE BOX Baguette Soft Bag with Carrying Belt

Product Code	Dimension
09-003-00151	36 x 36 x 18cm

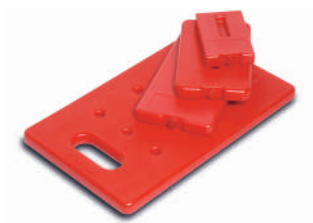

THERMOFUTURE BOX *Hot Pack*

Helps to maintain high temperature during transportation in the EPP transport boxes. Heats to 85°C in 30 minutes in the oven at 100°C or 35 mins in boiling water.

Product Code	Dimension	Capacity
09-003-00113	53 x 32.5 x 3cm	GN 1/1
09-003-00126	26.5 x 16.2 x 2cm	GN 1/4
09-003-00127	32.5 x 17.6 x 3cm	GN 1/3



THERMOFUTURE BOX *Accessory Trolley for Frontloader 60x40*

Product Code	Dimension
06-006-00243(XX)	70 x 50 x 17cm

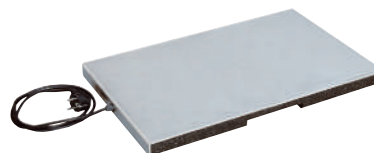

THERMOFUTURE BOX *EPP Hot Plate*

Warming plate for EPP-boxes, buffets or catering. Flat, lightweight and robust. Warms up to approx. 75°C in 5 minutes.

Product Code	Dimension	Capacity	Elec. Spec.
09-003-00120	51 x 32.5 x 3.4cm	GN 1/1	230V / 50Hz / 250W
09-003-00122	48 x 32.5 x 3.4cm	GN 1/1	230V / 50Hz / 230W
09-003-00123(XX)	58.5 x 40 x 2.9cm	60x40	230V / 50Hz / 280W

Transportation and Insulation

**THERMO
FUTURE
BOX®**

HIGH QUALITY



**HOT
COLD
FRESH**

- > robust, made of EPP
- > durable and lightweight
- > excellent insulation attributes (from - 40° up to +120 °C) with high thermal stability
- > safe food transportation: for hot, cold and fresh food
- > hygienic and dishwasher-proof
- > 100% recyclable

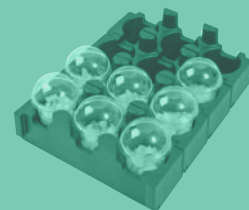

| BAR
SUPPLIES



SIA HUAT 
Beyond Foodservice Supplies

www.siahuat.com

CHAPTER

10



Chrome Plated Decanter Rack with Drip Tray

Product Code	Dimension
10-001-00044	Ø20 x H20cm



Plastic Cork Lifter

Product Code	Dimension	Colour
10-001-00045	24cm	Black



Vacuum Wine Pump + 2 Stopper Set

Product Code	Capacity
10-001-00123	30oz



Vacuum Wine Pump (Giovanni), Corkpops

Product Code
10-001-00125



Champagne Stopper

Product Code
10-001-00126



Plastic Bottle Stopper (2pcs/pkt)

Product Code	Dimension	Colour
10-001-00030	Ø3.7 x 7.7cm	Blue
10-001-00031	Ø3.7 x 7.7cm	Green
10-001-00032	Ø3.7 x 7.7cm	Red
10-001-00033	Ø3.7 x 7.7cm	Yellow



Stainless Steel Bar Blade

Product Code	Dimension
10-001-00035	19cm



Stainless Steel Bar Blade Opener

Product Code	Dimension	Colour
10-001-00040	19cm	Black Vinyl



Stainless Steel Flat Bottle Opener

Product Code	Dimension
10-001-00039	19cm



Copper Plated Flat Opener

Product Code	Dimension
10-001-00138	7" / 18cm



Stainless Steel Can Punch & Bottle Opener

Product Code	Dimension
10-001-00038	17.5 x 4cm



Wall Mounted Bottle Opener

Product Code	Dimension
10-001-00037	11cm



Bottle Cap Opener

Product Code	Dimension	Colour
10-001-00036	9cm	Nickelplated



Corkpop Legacy, Corkpops

Product Code	Dimension
10-001-00127	5 x 6 x 17cm



Refill Set of 2 (For Legacy), Corkpops

Product Code
10-001-00128



SUNNEX Chrome Plated Corkscrew Opener

Product Code	Dimension	Colour
10-001-00034	15.2cm	White



Waiter's Friend, Full Stainless Steel

Product Code	Dimension
10-001-00129	12cm



TABLECRAFT Waiter's Corkscrew with Plastic Handle

Product Code
10-001-00152



Zinc Alloy Rabbit Corkscrew

Product Code
10-001-00130



Ice Chipper

Product Code	Dimension
10-001-00085	23cm



Stainless Steel Ice Pick

Product Code	Dimension
10-001-00086	21.9cm



SAFICO Silicone Ice Ball Mould (2pcs/pkt)

Product Code	Dimension	Colour
10-001-00131	Ø7.8cm	Purple



ARCOROC Tempered Stackable Mixing Glass

Product Code	Dimension	Capacity
10-001-00029	Ø8.7 x H14.7cm	470mℓ



Boston Shaker

Product Code	Capacity	Colour
10-001-00003	840mℓ	Blue Vinyl
10-001-00002	840mℓ	Black Vinyl



Stainless Steel Boston Shaker

Product Code	Capacity
10-001-00008	900mℓ



Copper Plated Bar Shaker without Base

Product Code	Capacity
10-001-00141	900mℓ / 30oz



Stainless Steel Cocktail Shaker

Product Code	Capacity
10-001-00010	240mℓ
10-001-00011	360mℓ
10-001-00012	480mℓ
10-001-00013	700mℓ



Delux Copper Plated Cocktail Shakers (3pc)

Product Code	Capacity
10-001-00139	16oz



VENUS Stainless Steel Cocktail Shaker, Copper Plated, Hammered Finish

Product Code	Dimension	Capacity
10-001-00150	Ø9 x H24cm	750mℓ
10-001-00151	Ø9 x H20cm	500mℓ



Copper Plated 2 Pcs Cocktail Shaker

Product Code	Capacity
10-001-00140	20oz



Copper Plated Mug with Handle

Product Code
10-001-00144



Copper Plated Moscow Mule Mug Plain

Product Code	Capacity
10-001-00146	20oz



LACOR Stainless Steel Cocktail Strainer

Product Code	Dimension
10-001-00028	Ø8 x 18cm



Stainless Steel Bar / Cocktail Strainer

Product Code	Dimension
10-001-00009	15 x 8cm



Copper Plated Bar Strainer with 4 Prongs

Product Code
10-001-00137



Stainless Steel Julip Strainer

Product Code	Dimension
10-001-00018	16cm



Stainless Steel Lemon Squeezer with Strainer

Product Code	Dimension
10-002-00001	14.5 x 11.2cm



BONZER Stainless Steel Bar Mixing Spoon with Sugar Crusher Top

Product Code	Dimension
10-001-00026	25cm



Stainless Steel Bar Spoon

Product Code	Dimension
10-001-00006	28cm



Stainless Steel Bar Spoon

Product Code	Dimension
10-001-00005	31cm



Stainless Steel Bar Spoon & Fork

Product Code	Dimension
10-001-00004	25cm



Stainless Steel Bar Spoon & Fork

Product Code	Dimension
10-001-00007	30cm



Copper Plated Bar Spoon with Red Knob

Product Code	Dimension
10-001-00143	11"



Plastic Muddler

Product Code	Dimension	Colour
10-001-00101	20cm	<input type="checkbox"/> White
10-001-00102	20cm	<input checked="" type="checkbox"/> Red



TABLECRAFT Wooden Muddler

Product Code	Dimension
10-001-00149	L8"



Glass Wine Measure

Product Code	Capacity
10-001-00024	45mℓ



Copper Plated Jigger International

Product Code	Capacity
10-001-00145	30 / 60mℓ



Stainless Steel Jiggers

Product Code	Capacity
10-001-00014	15 / 30mℓ
10-001-00015	20 / 40mℓ
10-001-00016	25 / 50mℓ
10-001-00017	30 / 60mℓ



Stainless Steel Speed Rack

Product Code	Dimension
10-001-00093	105cm / 42"
10-001-00020	80cm / 32"
10-001-00019	55cm / 22"



BONZER *Single Bottle Shelf Bracket*

Product Code	Capacity
10-001-00094	Fits 0.75-1ℓ bottles



BONZER *Rotary Stand with Free Standing & Standard Bracks*

Product Code	Capacity
10-001-00095	Fits 0.75-1ℓ bottles; For 6 bottles



BONZER *Welded Black Eclipse*

Product Code	Capacity
10-001-00096	3cl



BONZER *Adaptor for Special Bottle*

Product Code	Colour
10-001-00097	■ Black



TABLECRAFT *Chrome Plated Free Flow Speed Pourer*

Product Code	Colour
10-001-00022	■ Black



CARLISLE *Pour Free, Chrome Top, Black Collar*

Product Code
10-001-00136



WESTMARK *Free Flow Speed Pourer*

Product Code	Colour
10-001-00083	Brass



JIWINS *PC+PVC Whiskeygate Speed Pourer*

Product Code	Dimension	Colour
10-001-00108	11cm	■ Black

JIWINS Plastic Free Flow Speed Pourer

Product Code	Dimension	Colour
10-001-00119	11cm	Black
10-001-00120	11cm	Blue
10-001-00121	11cm	Green
10-001-00122	11cm	Red

JIWINS Flexible Free Flow Speed Pourer

Product Code	Colour
10-001-00113	Black
10-001-00114	Clear
10-001-00115	Red

PIAZZA PLC Store N Pour, Versus

Product Code	Capacity
10-001-00132	0.5l / 1pt
10-001-00133	1l / 1qt
10-001-00134	2l / 0.5 Gallon

*Assorted colours available

JIWINS Plastic Store N Pour

Product Code	Capacity
10-001-00103	0.5l
10-001-00104	1l
10-001-00105	2l

*Assorted colours available

JIWINS Flair / Practise Bottle

Product Code	Dimension	Colour
10-001-00106	Ø7.7 x 29cm	White

JIWINS Flair Bottle

Product Code	Dimension	Colour
10-001-00107	Ø7.7 x 29cm	Fluorescent

CARLISLE 2-Tier Glass Rimmer

Product Code	Dimension	Colour
10-001-00135	20 x 16 x 7.5cm	Black

Plastic 3-Tier Glass Rimmer

Product Code	Dimension	Colour
10-001-00088	20 x 16 x 7.5cm	Black

Irish Coffee / Brandy Warmer Complete with Firestar Burner

Product Code	Colour
10-001-00057(XX)	Gold

Stainless Steel Milk Shake Cup

Product Code	Capacity
10-001-00001	30oz

Stainless Steel Milk Frothing Cup

Product Code	Dimension	Capacity
10-001-00050	Ø7.5 x H9.5cm	350mℓ
10-001-00051	Ø9.1 x H10.5cm	720mℓ
10-001-00048	Ø10.5 x H11.8cm	1080mℓ
10-001-00049	Ø12.4 x H14.5cm	1440mℓ

TABLECRAFT Stainless Steel Milk Frothing Cup

Product Code	Dimension	Capacity
10-001-00052	Ø7.1 x H9cm	414mℓ
10-001-00053	Ø8 x H11cm	710mℓ
10-001-00054	Ø9.5 x H12cm	1064mℓ



Chrome Plated Glass Hanger

Product Code	Dimension
10-001-00089	16"
10-001-00090	24"



IBILI Stainless Steel Cocoa Stencils (Set of 3)

Product Code	Dimension
10-001-00056	Ø10cm



Stainless Steel Bill Spike with Round Base

Product Code	Dimension
10-001-00084	23cm



JIWINS Rubber Service Mat

Product Code	Dimension	Colour
10-001-00109	45 x 31cm	■ Black



JIWINS Rubber Bar Mat

Product Code	Dimension	Colour
10-001-00111	60.5 x 7.6cm	■ Black



Plastic Beverage Holder / Buffet Clip

Product Code	Capacity	Colour
10-001-00080	50pcs/packet	□ White



Call Bell

Product Code	Dimension
10-001-00087	Ø8.5cm



Clear Acrylic Shot Glass Holder

Product Code	Dimension	Type
10-001-00081	34 x 13 x 10.5cm	2 x 6
10-001-00082	23 x 14 x 10.5cm	3 x 4



CCK Stainless Steel Mug with Handle

Product Code	Dimension	Capacity
10-001-00059	Ø12.7 x 12.7cm	1.5ℓ
10-001-00062	Ø14 x 14cm	2ℓ
10-001-00063	Ø15.2 x 15.2cm	2.5ℓ
10-001-00064	Ø16.5 x 16.5cm	3.25ℓ



SAFICO Stainless Steel Double Wall Wine Cooler & Stand, Hammered Finishing

Product Code	Dimension
14-002-00001	Cone: Ø22.5 x H51.5 cm Internal Depth: H21 cm Stand: 39 x 69.5 cm



SAFICO Stainless Steel Double Wall Oval Shape Cooler for 2 Bottles
(Cover Sold Separately)

Product Code	Dimension
14-002-00002	30 x 22 x 23cm
14-002-00003(XX)	Stainless Steel Cover for 14-002-00002



SAFICO Stainless Steel Wine Cooler Stand for 14-002-00002

Product Code	Dimension
14-002-00004	22 x 18 x 63cm



Stainless Steel Double Wall (Barrel) Wine Cooler

Product Code	Dimension
14-002-00005	Ø22 x H25cm



Stainless Steel Wine Cooler Stand for 14-002-00005

Product Code	Dimension
14-002-00006	Ø25 x H61cm



Stainless Steel Double Wall Wine Cooler

Product Code	Dimension
14-002-00007	Ø19 x H22cm



Stainless Steel Wine Cooler Stand for 14-002-00007

Product Code	Dimension
14-002-00008	Ø20 x H74cm



LACOR LUXE Stainless Steel Wine Cooler

Product Code	Dimension	Capacity
14-002-00009	Ø22cm	5.5ℓ



LACOR Stainless Steel Wine Cooler Stand for 14-002-00009

Product Code	Dimension
14-002-00010	Ø20 x H65cm



Stainless Steel Wine Bucket

Product Code	Dimension
14-002-00026	Ø21.3 x H20.5cm



Stainless Steel Wine Champagne Bucket Stand for 14-002-00026

Product Code	Dimension
14-002-00027	Ø18 x H66.4cm



SAFICO Stainless Steel Wine Cooler Hammered Finishing

Product Code	Dimension
14-002-00011	Ø21 x H22cm



SAFICO Stainless Steel Wine Cooler

Product Code	Dimension
14-002-00012	Ø21 x H22cm



SAFICO Stainless Steel Wine Cooler (Economy)

Product Code	Dimension
14-002-00013	Ø19.5 x H18cm



SAFICO Stainless Steel Wine Cooler Stand for 14-002-00011/12/13

Product Code	Dimension
14-002-00014	Ø19 x H63cm



SAFICO Stainless Steel Wine Cooler for 2 Bottles (Mirror Finish)

Product Code	Dimension
14-002-00031	Ø24.9 x H21.3cm



SAFICO Stainless Steel Wine Cooler for 2 Bottles (Mirror Finish) for 14-002-00031

Product Code	Dimension
14-002-00032	Ø21 x H63cm



SAFICO Stainless Steel Wine Cooler

Product Code	Dimension
14-002-00015	Ø24.5 x H29cm



Stainless Steel Hammered Wine Bucket

Product Code	Dimension
14-002-00020	Ø20 x H21cm



Stainless Steel Wine Cooler

Product Code	Dimension
14-002-00022	Ø20 x H25cm



Stainless Steel Wine Cooler with Flexible Handles

Product Code	Dimension
14-002-00024	Ø19 x H22cm



Stainless Steel Wine Cooler Stand

Product Code	Dimension
14-002-00021	Ø20 x H61cm



Stainless Steel Wine Cooler Stand

Product Code	Dimension
14-002-00025	Ø20 x H75cm



Stainless Steel Double Wall Wine Cooler

Product Code	Dimension
14-002-00028	Ø11.7 x H20.2cm



SAFICO 18-8 Stainless Steel Double Wall Wine Cooler

Product Code	Dimension
14-002-00029	Ø14 x H22cm



CAMBRO Wine Cooler / Bucket

Product Code	Colour
14-002-00052	Clear



CAMBRO PC Wine Cooler / Bucket without Handle

Product Code	Colour
14-002-00053	Clear



SAFICO Stainless Steel Square Double Wall Ice Bucket with Cover & Tong (Mirror Finish)

Product Code	Dimension	Capacity
14-002-00033	13.5 x 13.5 x 18cm	1.23ℓ
	Tong: 13.8cm	



SAFICO Stainless Steel Double Wall Oval Shape Ice Bucket with Cover & Tong

Product Code	Dimension	Capacity
14-002-00034	22 x 14 x 18.5cm	1.4ℓ



SAFICO Stainless Steel Double Wall Ice Bucket with Cover & Tong

Product Code	Dimension	Capacity
14-002-00035	Ø14 x H12.5cm	1.2ℓ



SAFICO Stainless Steel Double Wall Ice Bucket with Cover & Tong

Product Code	Dimension	Capacity
14-002-00036	Ø15.5 x H18.5cm	1.6ℓ



Stainless Steel Double Wall Ice Bucket with Lid

Product Code	Dimension	Capacity
14-002-00041	Ø20 x H22cm	5ℓ



Stainless Steel Insulated Ice Bucket with Tongs

Product Code	Dimension	Capacity
14-002-00037	Ø12 x H17.5cm	1ℓ



Stainless Steel Insulated Ice Bucket

Product Code	Dimension	Capacity
14-002-00038	Ø15.2 x H22cm	2ℓ



SAFICO Stainless Steel Small Double Wall Ice Bucket with Cover & Tong

Product Code	Dimension	Capacity
14-002-00042	Ø11.7 x H16.5cm Tong: 13.7cm	0.95ℓ



Stainless Steel Double Wall Ice Bucket with Tong & Loop Handle

Product Code	Dimension	Capacity
14-002-00044	Ø12 x H13cm	1ℓ



Stainless Steel Insulated Ice Bucket with Tong & Loop Handle

Product Code	Dimension	Capacity
14-002-00045	Ø15 x H16cm	2ℓ



SAFICO Stainless Steel Ice Bucket with Tong

Product Code	Dimension	Capacity
14-002-00046	Ø14 x H14cm	1.25ℓ



San Plastic Ice Bucket

Product Code	Dimension	Capacity
14-002-00047	Ø12.5 x H14.3cm	1.4ℓ



Acrylic Ice Bucket

Product Code	Dimension	Capacity
14-002-00048	Ø12.5 x H14cm	1ℓ



Acrylic Ice Bucket

Product Code	Dimension	Capacity
14-002-00049	Ø12 x H14cm	1ℓ



Acrylic Ice Bucket

Product Code	Dimension	Capacity
14-002-00050	Ø12 x H11.5cm	1ℓ



Stainless Steel Wine Bar Holder

Product Code	Dimension
14-002-00051	20 x 9 x 22cm

FURNITURE & BANQUET EQUIPMENT



CHAPTER

11

SIA HUAT 
Beyond Foodservice Supplies

www.siahuat.com



16-001-00001



16-001-00002

TABLECRAFT Wooden Baby High Chair Unassembled

Product Code	Dimension	Colour
16-001-00001	50 x 48 x 66cm, 3/4"	Natural
16-001-00002	50 x 48 x 66cm, 3/4"	Walnut

**TRUST Baby Chair without Wheels, Kid & Cool**

Product Code	Dimension	Colour
16-001-00005	63.6 x 58.3 x 76.8cm	Platinum

**Rectangle Foldable Table 4"**

Product Code	Dimension
16-002-00007	120 x 61 x 74cm

**Square Foldable Table**

Product Code	Dimension
16-002-00009	84.5 x 84.5 x 74cm

**ROCAM Folding Room Service Table**

Product Code
16-002-00010(XX)

**TRUST Baby Chair with Wheels, Kid & Cool**

Product Code	Dimension	Colour
16-001-00004	63.6 x 58.3 x 77.3cm	Platinum

**TRUST Tray for Baby Chair 16-001-00004/5, Kid & Cool**

Product Code	Dimension	Colour
16-001-00006(XX)	42.4 x 30 x 5.5cm	Red
16-001-00007	42.4 x 30 x 5.5cm	Platinum

**Rectangle Foldable Table With 2pc Top & Locking Button, 6ft**

Product Code	Dimension
16-002-00008	180 x 74 x 74cm

**Rectangle Foldable Table**

Product Code	Dimension	Colour	Max Load
16-002-00049	122 x 60 x 74cm	Yellow Woodgrain	150kgs
16-002-00050	180 x 70 x 74cm	Yellow Woodgrain	150kgs

**Classroom Table**

Product Code	Dimension
16-002-00011(XX)	183 x 45 x 76cm



Aluminium Lazy Susan Ring

Product Code	Dimension
16-002-00016	31cm
16-002-00017	41cm
16-002-00018	46cm



Lazy Susan Glass

Product Code	Dimension	Colour
16-002-00035	46cm	Clear
16-002-00036	56cm	Clear
16-002-00037	61cm	Clear
16-002-00038	76cm	Clear
16-002-00039(XX)	122cm	Clear
16-002-00040	76cm	Sand Blasting Center



Lazy Susan Glass

Product Code	Dimension	Colour
16-002-00041	61cm	Tinted
16-002-00042	76cm	Tinted
16-002-00043	91cm	Tinted
16-002-00044	107cm	Tinted
16-002-00045(XX)	112cm	Tinted
16-002-00046(XX)	119cm	Tinted
16-002-00047	122cm	Tinted
16-002-00048(XX)	70cm	Tempered



Stainless Steel Lazy Susan Trolley

Product Code	Dimension	Load
16-003-00002(XX)	88.5 x 68.5 x 82.5cm	20pcs of Ø80 x H1cm Lazy Susan



16-002-00019



16-002-00022



16-002-00025

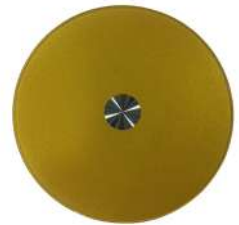

16-002-00028



16-002-00031

Lazy Susan Glass with Silver Base Ring & Duck Beak Edge

Product Code	Dimension	Colour
16-002-00019	Ø60 x H1cm	Vertical Gold Thread
16-002-00020	Ø75 x H1cm	Vertical Gold Thread
16-002-00021	Ø90 x H1cm	Vertical Gold Thread
16-002-00022	Ø60 x H1cm	Shiny Silver
16-002-00023	Ø75 x H1cm	Shiny Silver
16-002-00024	Ø90 x H1cm	Shiny Silver
16-002-00025	Ø60 x H1cm	Laser Black
16-002-00026	Ø75 x H1cm	Laser Black
16-002-00027	Ø90 x H1cm	Laser Black
16-002-00028	Ø60 x H1cm	Shiny Champagne Gold
16-002-00029	Ø75 x H1cm	Shiny Champagne Gold
16-002-00030	Ø90 x H1cm	Shiny Champagne Gold
16-002-00031	Ø60 x H1cm	Wavy Gold Thread
16-002-00032	Ø75 x H1cm	Wavy Gold Thread
16-002-00033	Ø90 x H1cm	Wavy Gold Thread



Lazy Susan Trolley

Product Code	Dimension	Slots
16-003-00003(XX)	120 x 65 x 148.5cm	10 Slots



SECURIT Pine Wood Pavement Chalk Board

Product Code	Dimension	Colour
14-004-00003	70 x 120cm	Black
14-004-00004	70 x 120cm	Teak



SECURIT Woody Chalk Board - Wood with Lacquered Teak Finish (White Chalk Marker & Mounting Kit Included)

Product Code	Dimension	Colour
14-004-00005	20 x 24cm	Black
14-004-00006	20 x 40cm	Black
14-004-00007	30 x 40cm	Black
14-004-00008	40 x 60cm	Black
14-004-00009	60 x 80cm	Black



SECURIT Long Hard Wood Chalk Board - with Lacquered Teak Finish (Wall Mounting Screws Included)

Product Code	Dimension	Colour
14-004-00010	56 x 100cm	Black
14-004-00011	56 x 120cm	Black
14-004-00012	56 x 150cm	Black

SECURIT Woody Chalk Board - Wood with Lacquered Black Finish (White Chalk Marker & Mounting Kit Included)

Product Code	Dimension	Colour
14-004-00013	40 x 60cm	Black



SECURIT Liquid Chalk Markers with 1-2mm Tip

Product Code	Capacity	Colour
14-004-00014	7pcs/pkt	White
14-004-00015	7pcs/pkt	Blue / Orange / Purple / Pink / Red / Green / Yellow



SECURIT Liquid Chalk Markers with 1-2mm Tip

Product Code	Capacity	Colour
14-004-00016	4pcs/pkt	Yellow / Orange / Pink / Purple
14-004-00017	4pcs/pkt	White
14-004-00018	4pcs/pkt	Blue / Red / Green / White



SECURIT Liquid Chalk Marker with 2-6mm Tip

Product Code	Colour
14-004-00019	Yellow
14-004-00020	White
14-004-00001	Silver
14-004-00022	Red
14-004-00023	Purple
14-004-00024	Pink
14-004-00025	Orange
14-004-00026	Green
14-004-00027	Gold
14-004-00028	Blue



Stainless Steel Q-Up Post with Belt

Product Code	Dimension	Colour
16-004-00001	H100cm; Belt 200cm	Black
16-004-00002	H100cm; Belt 200cm	Blue
16-004-00003	H100cm; Belt 200cm	Red



Signboard with Black PLC Holder for 16-004-00001/00002/00003

Product Code	Dimension
16-004-00004	30.5 x 21.7cm



Velvet Rope for Q-Post with Mirror-Finished Hook for 16-004-00007

Product Code	Dimension	Colour
16-004-00005	Ø3.2 x H150cm	Black



Stainless Steel Q Post (Mirror Finish) for 16-004-00005

Product Code	Dimension
16-004-00007	Ø31 x H95.2cm; Pole Ø5cm



TRUST Mobile Work Center with 4-Drawers & Cabinet, Bitbar

Product Code	Dimension	Capacity	Colour
16-004-00008(XX)	124.5 x 67 x 97.2cm	340kg	Black



TRUST Heimdall Baby Changing Station

Product Code	Dimension
16-004-00009(XX)	84.5 x 54.6 x 10.2cm

| INDEX
NUMERICAL

SIA HUAT 
Beyond Foodservice Supplies

www.siahuat.com

CHAPTER

12

PRODUCT CODE	PAGE								
01-001-00001	27	01-001-00096	6	01-001-00200	15	01-001-00311(XX)	2	01-001-00392	7
01-001-00002	27	01-001-00097	6	01-001-00201	15	01-001-00312	9	01-001-00393	7
01-001-00003	27	01-001-00098	6	01-001-00202	15	01-001-00313	9	01-001-00394	7
01-001-00004	27	01-001-00099	6	01-001-00203(XX)	15	01-001-00314	9	01-001-00400	12
01-001-00005	27	01-001-00100	6	01-001-00204	15	01-001-00315	9	01-001-00404	30
01-001-00006	27	01-001-00101	6	01-001-00205	15	01-001-00316	9	01-001-00405	30
01-001-00007	27	01-001-00102	6	01-001-00206	15	01-001-00317	9	01-001-00406	29
01-001-00008	27	01-001-00111	11	01-001-00207	15	01-001-00318	9	01-001-00407	29
01-001-00009	27	01-001-00112	11	01-001-00208	13	01-001-00319	9	01-001-00408	29
01-001-00011	8	01-001-00113	11	01-001-00209	13	01-001-00320	9	01-001-00409	29
01-001-00012	8	01-001-00114	11	01-001-00210	13	01-001-00321	9	01-001-00410	29
01-001-00013	8	01-001-00115	11	01-001-00211(XX)	13	01-001-00322	9	01-001-00411	29
01-001-00014	8	01-001-00116	11	01-001-00212(XX)	13	01-001-00323(XX)	7	01-001-00412	29
01-001-00015	8	01-001-00117	11	01-001-00213(XX)	15	01-001-00324(XX)	7	01-001-00413	29
01-001-00016	8	01-001-00118	11	01-001-00214(XX)	14	01-001-00325(XX)	7	01-001-00414	29
01-001-00017	8	01-001-00128	11	01-001-00215(XX)	14	01-001-00326(XX)	7	01-001-00415	29
01-001-00018	8	01-001-00130	11	01-001-00217	2	01-001-00327(XX)	7	01-001-00416(XX)	25
01-001-00019	8	01-001-00131	11	01-001-00218	2	01-001-00328(XX)	7	01-001-00417	22
01-001-00024	6	01-001-00132	11	01-001-00219	2	01-001-00329(XX)	7	01-001-00418	22
01-001-00025	6	01-001-00133	11	01-001-00220	2	01-001-00330(XX)	7	01-001-00419	22
01-001-00026	6	01-001-00134	11	01-001-00224	8	01-001-00331(XX)	7	01-001-00420	22
01-001-00027	6	01-001-00144	11	01-001-00225	8	01-001-00332	7	01-001-00421	22
01-001-00028	6	01-001-00145	11	01-001-00226	8	01-001-00333	3	01-001-00422(XX)	25
01-001-00030	6	01-001-00146	11	01-001-00227	8	01-001-00334	12	01-001-00425	16
01-001-00031	6	01-001-00147	11	01-001-00228	8	01-001-00335	12	01-001-00426	16
01-001-00032	6	01-001-00148	11	01-001-00229	8	01-001-00336	12	01-001-00429	16
01-001-00033	6	01-001-00149	11	01-001-00230	8	01-001-00337	12	01-001-00430	16
01-001-00034	6	01-001-00150	26	01-001-00231	8	01-001-00338	12	01-001-00431	16
01-001-00035	6	01-001-00151	26	01-001-00232	8	01-001-00339	12	01-001-00432	13
01-001-00036	6	01-001-00152	26	01-001-00233	8	01-001-00340	12	01-001-00433(XX)	13
01-001-00037	6	01-001-00153	26	01-001-00234	8	01-001-00341	12	01-001-00434(XX)	16
01-001-00038	6	01-001-00154	26	01-001-00235	8	01-001-00342	12	01-001-00435	2
01-001-00047(XX)	11	01-001-00155	11	01-001-00236	7	01-001-00343	12	01-001-00436	2
01-001-00048	11	01-001-00156	28	01-001-00237	7	01-001-00344	7	01-001-00437	2
01-001-00049	11	01-001-00157	27	01-001-00238	7	01-001-00345	7	01-001-00438(XX)	9
01-001-00050	11	01-001-00158	27	01-001-00239	7	01-001-00346	7	01-001-00439(XX)	9
01-001-00051	11	01-001-00159	28	01-001-00240	7	01-001-00347	15	01-001-00440(XX)	9
01-001-00052	11	01-001-00160	28	01-001-00241	7	01-001-00348	16	01-001-00441(XX)	9
01-001-00053	11	01-001-00161	28	01-001-00242	7	01-001-00349(XX)	16	01-001-00442	9
01-001-00054	11	01-001-00162	27	01-001-00243	7	01-001-00353	14	01-001-00443	29
01-001-00055	11	01-001-00163	27	01-001-00244	7	01-001-00354	15	01-001-00444	29
01-001-00056	11	01-001-00164	27	01-001-00245	7	01-001-00355	15	01-001-00445	29
01-001-00061	14	01-001-00165	27	01-001-00246	7	01-001-00356	15	01-001-00446	29
01-001-00062	14	01-001-00166	27	01-001-00247	7	01-001-00357	15	01-001-00447	29
01-001-00063	14	01-001-00167	27	01-001-00248	7	01-001-00358	13	01-001-00448	29
01-001-00064	14	01-001-00168	28	01-001-00249	7	01-001-00359(XX)	13	01-001-00449	9
01-001-00068	8	01-001-00169	28	01-001-00258	11	01-001-00360(XX)	13	01-001-00450	7
01-001-00069	8	01-001-00170	28	01-001-00259	11	01-001-00362(XX)	13	01-001-00451	7
01-001-00070	8	01-001-00171	28	01-001-00260	11	01-001-00363	13	01-001-00452	7
01-001-00071	8	01-001-00172	28	01-001-00261	11	01-001-00364	13	01-001-00453	7
01-001-00072	8	01-001-00173	28	01-001-00273	11	01-001-00365	13	01-001-00454	30
01-001-00073	8	01-001-00174	28	01-001-00274	11	01-001-00366(XX)	13	01-001-00455	29
01-001-00074	8	01-001-00175	28	01-001-00275	11	01-001-00369	12	01-001-00456	29
01-001-00075	8	01-001-00176	28	01-001-00276	11	01-001-00370	12	01-001-00457	29
01-001-00076	8	01-001-00177	28	01-001-00277	27	01-001-00371	12	01-001-00458	29
01-001-00077	8	01-001-00179	28	01-001-00278	27	01-001-00372	9	01-001-00459	29
01-001-00078	8	01-001-00180	28	01-001-00279	27	01-001-00373	9	01-001-00460	29
01-001-00079	8	01-001-00181	28	01-001-00280	27	01-001-00375	2	01-001-00468	4, 32
01-001-00080	8	01-001-00182	28	01-001-00281	27	01-001-00376	2	01-001-00469	2
01-001-00081	8	01-001-00183	28	01-001-00282	27	01-001-00377	2	01-001-00470	29
01-001-00082	8	01-001-00184	28	01-001-00283	27	01-001-00378	8	01-001-00471	29
01-001-00083	8	01-001-00185	28	01-001-00284	27	01-001-00379	8	01-001-00472	29
01-001-00084	8	01-001-00186	28	01-001-00285	27	01-001-00380	8	01-001-00473(XX)	33
01-001-00085	8	01-001-00187	28	01-001-00286	27	01-001-00381	8	01-001-00474(XX)	33
01-001-00086	8	01-001-00189	28	01-001-00287	27	01-001-00382	8	01-001-00475(XX)	33
01-001-00087	6	01-001-00190	28	01-001-00288	27	01-001-00383	9	01-001-00476	29
01-001-00088	6	01-001-00191	28	01-001-00289	27	01-001-00384	9	01-001-00477	29
01-001-00089	6	01-001-00192	27	01-001-00290	27	01-001-00385	9	01-001-00478	29
01-001-00090	6	01-001-00193	27	01-001-00291	27	01-001-00386	9	01-001-00480	29
01-001-00091	6	01-001-00194	27	01-001-00293	15	01-001-00387	7	01-001-00481	29
01-001-00092	6	01-001-00195	27	01-001-00294	15	01-001-00388	7	01-001-00482	29
01-001-00093	6	01-001-00196	27	01-001-00308(XX)	2	01-001-00389	7	01-001-00483	29
01-001-00094	6	01-001-00197	27	01-001-00309(XX)	2	01-001-00390	7	01-001-00484	29
01-001-00095	6	01-001-00199	15	01-001-00310(XX)	2	01-001-00391	7	01-001-00485	29

PRODUCT CODE	PAGE								
01-001-00486	29	01-001-00583	32	01-001-00680	19	01-001-00781(XX)	24	01-001-00881	65
01-001-00496	31	01-001-00584	32	01-001-00681	19	01-001-00782(XX)	23	01-001-00906(XX)	64
01-001-00497	31	01-001-00589	32	01-001-00682	19	01-001-00784(XX)	23	01-001-00907(XX)	25
01-001-00498	31	01-001-00590	32	01-001-00683	19	01-001-00788(XX)	25	01-001-00909	34
01-001-00499	31	01-001-00591	32	01-001-00684	19	01-001-00793(XX)	23	01-001-00910	34
01-001-00500	31	01-001-00593	16	01-001-00685(XX)	23	01-001-00794	17	01-001-00911(XX)	34
01-001-00501	31	01-001-00598	31	01-001-00686	23	01-001-00795	3	01-001-00914(XX)	34
01-001-00502	31	01-001-00599	31	01-001-00688	23	01-001-00796	3	01-001-00922(XX)	26
01-001-00503	31	01-001-00600(XX)	25	01-001-00691(XX)	23	01-001-00799(XX)	25	01-001-00923(XX)	26
01-001-00505	31	01-001-00602(XX)	25	01-001-00692(XX)	23	01-001-00800(XX)	25	01-001-00924	9
01-001-00507	30	01-001-00604(XX)	24	01-001-00693(XX)	23	01-001-00801(XX)	20	01-001-00925	9
01-001-00508	30	01-001-00605(XX)	24	01-001-00694(XX)	23	01-001-00802(XX)	20	01-001-00926	27
01-001-00509	30	01-001-00607	23	01-001-00700	21	01-001-00803	20	01-001-00927	31
01-001-00510	30	01-001-00609	23	01-001-00701	21	01-001-00804(XX)	19	01-001-00928	31
01-001-00511	30	01-001-00610	23	01-001-00703	20	01-001-00805(XX)	19	01-001-00929	31
01-001-00512	30	01-001-00612	23	01-001-00704	20	01-001-00806(XX)	19	01-001-00930	31
01-001-00513	30	01-001-00613	23	01-001-00705	20	01-001-00807(XX)	19	01-001-00931	33
01-001-00514	30	01-001-00615(XX)	23	01-001-00706	18	01-001-00808(XX)	19	01-001-00932	31
01-001-00515	30	01-001-00617(XX)	23	01-001-00707	18	01-001-00809(XX)	19	01-001-00933	33
01-001-00516	30	01-001-00618(XX)	23	01-001-00708	18	01-001-00810	19	01-001-00934	29
01-001-00517	30	01-001-00620	23	01-001-00709	18	01-001-00811(XX)	19	01-001-00935	29
01-001-00518	30	01-001-00621(XX)	23	01-001-00710	18	01-001-00812(XX)	19	01-001-00936	29
01-001-00519	30	01-001-00623	24	01-001-00711	18	01-001-00813(XX)	19	01-001-00937	29
01-001-00520	30	01-001-00624	24	01-001-00712	18	01-001-00814	19	01-001-00938	29
01-001-00521	30	01-001-00625(XX)	24	01-001-00713	18	01-001-00815	19	01-001-00939	29
01-001-00522	30	01-001-00626(XX)	24	01-001-00714	18	01-001-00816(XX)	20	01-001-00940	31
01-001-00523	30	01-001-00627(XX)	24	01-001-00715	18	01-001-00817(XX)	20	01-001-00941	31
01-001-00524	30	01-001-00628(XX)	24	01-001-00716	18	01-001-00818(XX)	20	01-001-00942	31
01-001-00525	30	01-001-00629(XX)	24	01-001-00717	18	01-001-00819(XX)	20	01-001-00943	31
01-001-00526	30	01-001-00630(XX)	24	01-001-00718	18	01-001-00820(XX)	20	01-001-00944	31
01-001-00527	30	01-001-00631	25	01-001-00719	18	01-001-00821(XX)	20	01-001-00945	31
01-001-00528	30	01-001-00632	23	01-001-00720	18	01-001-00822(XX)	20	01-001-00946	31
01-001-00529(XX)	33	01-001-00633	23	01-001-00721	18	01-001-00823(XX)	20	01-001-00947	31
01-001-00530(XX)	33	01-001-00635	23	01-001-00722	18	01-001-00824(XX)	20	01-001-00948	31
01-001-00532	33	01-001-00636	23	01-001-00723	18	01-001-00825(XX)	20	01-001-00949	32
01-001-00533	31	01-001-00637	23	01-001-00726(XX)	23	01-001-00826(XX)	20	01-001-00950	32
01-001-00534	31	01-001-00638	23	01-001-00728(XX)	23	01-001-00827(XX)	20	01-001-00951	32
01-001-00535	31	01-001-00639	23	01-001-00729(XX)	23	01-001-00834(XX)	21	01-001-00952	32
01-001-00536	31	01-001-00640	23	01-001-00731	23	01-001-00835(XX)	21	01-001-00953	32
01-001-00537	31	01-001-00640(XX)	15	01-001-00732	23	01-001-00836(XX)	21	01-001-00954	32
01-001-00538	26	01-001-00641	23	01-001-00735	23	01-001-00837(XX)	21	01-001-00955	32
01-001-00539	26	01-001-00643	23	01-001-00736(XX)	23	01-001-00839(XX)	16	01-001-00956	32
01-001-00540	26	01-001-00644	23	01-001-00737(XX)	23	01-001-00841(XX)	15	01-001-00957	31
01-001-00541	26	01-001-00646(XX)	25	01-001-00739(XX)	23	01-001-00842(XX)	15	01-001-00958	31
01-001-00542	26	01-001-00647(XX)	25	01-001-00741	20	01-001-00846	2, 64	01-001-00959	31
01-001-00543	26	01-001-00649(XX)	25	01-001-00742	20	01-001-00847	2, 64	01-001-00960	31
01-001-00544	26	01-001-00650(XX)	25	01-001-00743	20	01-001-00851	65	01-001-00961	31
01-001-00545	26	01-001-00651(XX)	25	01-001-00745	17	01-001-00852	65	01-001-00962	31
01-001-00546	26	01-001-00652(XX)	25	01-001-00746	17	01-001-00853	65	01-001-00963	31
01-001-00547	30	01-001-00654	24	01-001-00747	17	01-001-00854	65	01-001-00964	32
01-001-00548	30	01-001-00655	24	01-001-00748	17	01-001-00855	65	01-001-00965	31
01-001-00549	30	01-001-00656	24	01-001-00749	17	01-001-00856	65	01-001-00966	31
01-001-00550	30	01-001-00657(XX)	24	01-001-00750	17	01-001-00858	65	01-001-00967	32
01-001-00551	30	01-001-00658(XX)	24	01-001-00751	18	01-001-00859	65	01-001-00968	32
01-001-00552	30	01-001-00659(XX)	23	01-001-00752	18	01-001-00860	65	01-001-00969	32
01-001-00553	30	01-001-00660(XX)	23	01-001-00753	18	01-001-00861	65	01-001-00970	32
01-001-00554	30	01-001-00661(XX)	23	01-001-00754	18	01-001-00862	65	01-001-00971	32
01-001-00555	30	01-001-00662(XX)	23	01-001-00755	18	01-001-00863	65	01-001-00972	34
01-001-00556	2	01-001-00663(XX)	25	01-001-00756	18	01-001-00864	65	01-001-00973	28
01-001-00557	24	01-001-00664(XX)	23	01-001-00757	18	01-001-00865	65	01-001-00974(XX)	28
01-001-00558	24	01-001-00666(XX)	25	01-001-00758	18	01-001-00866	20	01-001-00975(XX)	28
01-001-00562	21	01-001-00667	19	01-001-00759	18	01-001-00867	20	01-001-00976(XX)	28
01-001-00563	21	01-001-00668	19	01-001-00760	18	01-001-00868	20	01-001-00977	64
01-001-00564	21	01-001-00669	19	01-001-00761	18	01-001-00869	20	01-001-00978	64
01-001-00565(XX)	24	01-001-00670	19	01-001-00762	18	01-001-00870	20	01-001-00979	64
01-001-00566	21	01-001-00671	19	01-001-00763(XX)	23	01-001-00871	20	01-001-00980	64
01-001-00569(XX)	23	01-001-00672	19	01-001-00764(XX)	23	01-001-00872(XX)	20	01-001-00981	64
01-001-00570	21	01-001-00673	19	01-001-00770	21	01-001-00873(XX)	20	01-001-00982	64
01-001-00571(XX)	24	01-001-00674	19	01-001-00771	21	01-001-00874(XX)	20	01-001-00983	64
01-001-00572	21	01-001-00675	19	01-001-00772	21	01-001-00876	65	01-001-00984	64
01-001-00573	21	01-001-00676	19	01-001-00773	21	01-001-00877	65	01-001-00985	64
01-001-00574	21	01-001-00677	19	01-001-00774	21	01-001-00878	65	01-001-00986	64
01-001-00575(XX)	25	01-001-00678	19	01-001-00775	19	01-001-00879	65	01-001-00987	64
01-001-00582	32	01-001-00679	19	01-001-00780(XX)	24	01-001-00880	65	01-001-00988	64

PRODUCT CODE	PAGE								
02-002-00871	91	02-002-00994	83	02-003-00017	100	02-003-00113	96	02-003-00208	92
02-002-00874	91	02-002-00995	83	02-003-00018	100	02-003-00114	96	02-003-00209	92
02-002-00875	91	02-002-00996	83	02-003-00020	98	02-003-00115	96	02-003-00210	92
02-002-00878	70	02-002-00997	83	02-003-00024	96	02-003-00116	96	02-003-00211	92
02-002-00880	70	02-002-00998	83	02-003-00025	96	02-003-00117	95	02-003-00216	93
02-002-00881	70	02-002-00999	83	02-003-00031	96	02-003-00118	96	02-003-00227	92
02-002-00883	70	02-002-01000	83	02-003-00032	96	02-003-00119	96	02-003-00228	92
02-002-00884	70	02-002-01001	83	02-003-00038	91	02-003-00120	96	02-003-00229	92
02-002-00886	70	02-002-01023	65	02-003-00039	91	02-003-00121	96	02-003-00230	92
02-002-00889	70	02-002-01024	65	02-003-00040	91	02-003-00122	96	02-003-00231	92
02-002-00891	70	02-002-01025	65	02-003-00041	91	02-003-00123	96	02-003-00232	92
02-002-00892	70	02-002-01026	65	02-003-00042	91	02-003-00124	96	02-003-00233	92
02-002-00893	70	02-002-01027	65	02-003-00043	94	02-003-00125	96	02-003-00234	92
02-002-00894	70	02-002-01028	65	02-003-00044	94	02-003-00130	99	02-003-00235	92
02-002-00895	70	02-002-01029	65	02-003-00045	94	02-003-00131	99	02-003-00236	92
02-002-00896	70	02-002-01030	65	02-003-00046	94	02-003-00132	97	02-003-00237	92
02-002-00902	69	02-002-01031	65	02-003-00047	91	02-003-00133	98	02-003-00238	92
02-002-00903	69	02-002-01032	65	02-003-00048	91	02-003-00134	98	02-003-00239	92
02-002-00904	69	02-002-01033	65	02-003-00049	91	02-003-00135	98	02-003-00240	92
02-002-00905	69	02-002-01034	65	02-003-00050	94	02-003-00136	98	02-003-00241	92
02-002-00907	69	02-002-01035	65	02-003-00051	94	02-003-00137	98	02-003-00242	92
02-002-00908	69	02-002-01036	65	02-003-00052	94	02-003-00138	98	02-003-00243	92
02-002-00909	69	02-002-01037	65	02-003-00053	94	02-003-00139	98	02-003-00244	92
02-002-00910	70	02-002-01063	63	02-003-00054	94	02-003-00140(XX)	98	02-003-00245	92
02-002-00913	70	02-002-01064	63	02-003-00055	94	02-003-00141	96	02-003-00246	92
02-002-00914	69	02-002-01065	63	02-003-00056	94	02-003-00143	98	02-003-00247	92
02-002-00917	69	02-002-01066	63	02-003-00057	94	02-003-00144	97	02-003-00248	92
02-002-00918	69	02-002-01067	63	02-003-00059	100	02-003-00145	96	02-003-00249	92
02-002-00919	69	02-002-01068	63	02-003-00062	91	02-003-00146	99	02-003-00250	92
02-002-00920	69	02-002-01069	63	02-003-00063	91	02-003-00147	99	02-003-00251	92
02-002-00925	70	02-002-01070	82	02-003-00064	91	02-003-00149	97	02-003-00252	92
02-002-00926	69	02-002-01071	82	02-003-00065	93	02-003-00150	97	02-003-00253	92
02-002-00927	70	02-002-01072	82	02-003-00066	93	02-003-00151	97	02-003-00255	107
02-002-00928	70	02-002-01073	82	02-003-00067	93	02-003-00152	98	02-003-00256	107
02-002-00933	72	02-002-01088	65	02-003-00070	93	02-003-00153	98	02-003-00257	107
02-002-00935	72	02-002-01089	65	02-003-00071	93	02-003-00154	98	02-003-00261	107
02-002-00936(XX)	72	02-002-01090	65	02-003-00072	97	02-003-00155	98	02-003-00262	107
02-002-00939	71	02-002-01091	65	02-003-00073	94	02-003-00156	98	02-003-00263	107
02-002-00940	71	02-002-01092	82	02-003-00074	94	02-003-00157	98	02-003-00264	107
02-002-00941	71	02-002-01093	73	02-003-00075	94	02-003-00158	97	02-003-00265	107
02-002-00942	70	02-002-01098	62	02-003-00076	95	02-003-00163	99	02-003-00266	107
02-002-00943	71	02-002-01100	81	02-003-00077	95	02-003-00164	99	02-003-00267	107
02-002-00944	71	02-002-01101	81	02-003-00078	95	02-003-00165	99	02-003-00268	107
02-002-00945	71	02-002-01102	81	02-003-00079	95	02-003-00174	97	02-003-00269	107
02-002-00946	71	02-002-01103	81	02-003-00080	95	02-003-00175	98	02-003-00270	107
02-002-00947	71	02-002-01104	81	02-003-00081	95	02-003-00176	99	02-003-00271	107
02-002-00948	71	02-002-01105	81	02-003-00082	95	02-003-00177	96	02-003-00272	107
02-002-00949	70	02-002-01107	72	02-003-00083	95	02-003-00178	97	02-003-00273	107
02-002-00950	71	02-002-01112	78	02-003-00084	95	02-003-00179	97	02-003-00274	107
02-002-00951	71	02-002-01128	66	02-003-00085	95	02-003-00180	98	02-003-00275	107
02-002-00952	71	02-002-01129	66	02-003-00086	95	02-003-00181	98	02-003-00276	107
02-002-00953	72	02-002-01130	66	02-003-00087	95	02-003-00182	98	02-003-00277	107
02-002-00954	72	02-002-01131	66	02-003-00088	95	02-003-00183	98	02-003-00278	107
02-002-00955	72	02-002-01132	66	02-003-00089	95	02-003-00184	98	02-003-00281	103
02-002-00956	90	02-002-01133	66	02-003-00090	95	02-003-00185	98	02-003-00282	102
02-002-00957	90	02-002-01134	66	02-003-00091	95	02-003-00186	98	02-003-00283	102
02-002-00958	90	02-002-01135	66	02-003-00092	95	02-003-00187	98	02-003-00284	102
02-002-00959	90	02-002-01136	65	02-003-00095	95	02-003-00188	99	02-003-00285	102
02-002-00960	90	02-002-01137	65	02-003-00096	95	02-003-00189	96	02-003-00286	102
02-002-00963	90	02-002-01138	65	02-003-00097	95	02-003-00190	96	02-003-00287	102
02-002-00964	90	02-002-01139	65	02-003-00098	95	02-003-00191	98	02-003-00288	102
02-002-00965	90	02-002-01140	65	02-003-00099(XX)	99	02-003-00192	98	02-003-00289	102
02-002-00966	90	02-002-01141	65	02-003-00100(XX)	99	02-003-00194	99	02-003-00290	102
02-002-00967	90	02-002-01142	65	02-003-00102(XX)	97	02-003-00195	97	02-003-00291	103
02-002-00968	90	02-002-01143	66	02-003-00103	97	02-003-00198	99	02-003-00294	100
02-002-00971	70	02-002-01144	66	02-003-00104	97	02-003-00199	99	02-003-00295	100
02-002-00972	70	02-002-01145	66	02-003-00105	97	02-003-00200	99	02-003-00296	101
02-002-00973	70	02-002-01146	66	02-003-00106	97	02-003-00201	99	02-003-00297	101
02-002-00974	70	02-003-00008	94	02-003-00107	97	02-003-00202	99	02-003-00298	103
02-002-00975	72	02-003-00009	94	02-003-00108	95	02-003-00203	99	02-003-00301	101
02-002-00980	90	02-003-00010	94	02-003-00109	96	02-003-00204	92	02-003-00302	101
02-002-00981	90	02-003-00011	94	02-003-00110	96	02-003-00205	92	02-003-00303	101
02-002-00992	83	02-003-00012	94	02-003-00111	96	02-003-00206	92	02-003-00304	101
02-002-00993	83	02-003-00016	100	02-003-00112	96	02-003-00207	92	02-003-00305	101

PRODUCT CODE	PAGE						
02-003-00780	108	02-004-00029	118	02-005-00099	121	03-001-00020	131
02-003-00781	108	02-004-00030	118	02-005-00100(XX)	121	03-001-00021	131
02-003-00782	108	02-004-00031	118	02-005-00102	122	03-001-00022	131
02-003-00783	108	02-004-00032	118	02-005-00103	122	03-001-00023	131
02-003-00784	108	02-004-00033	118	02-005-00104	122	03-001-00024	131
02-003-00785	116	02-004-00034	118	02-005-00105	122	03-001-00025	131
02-003-00786	116	02-004-00035	118	02-005-00106	122	03-001-00026	130
02-003-00788	116	02-004-00036	118	02-005-00107	121	03-001-00027	132
02-003-00789	108	02-004-00037	119	02-005-00108(XX)	122	03-001-00028	132
02-003-00790	108	02-004-00038	119	02-005-00109	123	03-001-00029	132
02-003-00791	108	02-004-00039	119	02-005-00111	123	03-001-00030	132
02-003-00793	94	02-004-00041	118	02-005-00112	122	03-001-00031	132
02-003-00794	94	02-004-00042	118	02-005-00113	123	03-001-00032	132
02-003-00795	105	02-004-00043	118	02-005-00114	123	03-001-00033	132
02-003-00796	105	02-005-00001(XX)	119	02-005-00115	123	03-001-00034	132
02-003-00797	105	02-005-00002	119	02-005-00116	122	03-001-00035	132
02-003-00798	105	02-005-00004	120	02-005-00117	123	03-001-00036	132
02-003-00799	105	02-005-00005	119	02-005-00118(XX)	123	03-001-00037	132
02-003-00809	107	02-005-00006	119	02-005-00120	123	03-001-00038	132
02-003-00812	113	02-005-00007	119	02-005-00121	125	03-001-00039	132
02-003-00814	113	02-005-00008	119	02-005-00122	125	03-001-00040	132
02-003-00815	113	02-005-00009	119	02-005-00123	124	03-001-00041	132
02-003-00816	113	02-005-00015(XX)	119	02-005-00124	125	03-001-00042	132
02-003-00817	113	02-005-00016(XX)	119	02-005-00125	125	03-001-00043	132
02-003-00819	113	02-005-00017(XX)	119	02-005-00126	124	03-001-00044	140
02-003-00820	113	02-005-00018(XX)	119	02-005-00127	124	03-001-00045	140
02-003-00830	92	02-005-00019(XX)	119	02-005-00129	125	03-001-00046	140
02-003-00831	92	02-005-00020(XX)	119	02-005-00130	122	03-001-00047	140
02-003-00832	92	02-005-00021	120	02-005-00131	123	03-001-00048	140
02-003-00833	92	02-005-00022	120	02-005-00132	123	03-001-00049	140
02-003-00834	92	02-005-00024	119	02-005-00133	123	03-001-00050	140
02-003-00835	92	02-005-00025	119	02-005-00134	124	03-001-00051	140
02-003-00836	92	02-005-00026	119	02-005-00135	124	03-001-00062	131
02-003-00837	92	02-005-00027	120	02-005-00136	124	03-001-00063	131
02-003-00838	92	02-005-00028	120	02-005-00137	126	03-001-00064	131
02-003-00839	92	02-005-00032	121	02-005-00138	124	03-001-00067	131
02-003-00840	92	02-005-00033	121	02-005-00139	124	03-001-00068	131
02-003-00841	92	02-005-00036	121	02-005-00140	124	03-001-00069	131
02-003-00842	92	02-005-00037	121	02-005-00141	125	03-001-00070	130
02-003-00843	92	02-005-00038	120	02-005-00142	123	03-001-00071	130
02-003-00864	91	02-005-00039	120	02-005-00143	125	03-001-00072	130
02-003-00865	91	02-005-00041	120	02-005-00144	125	03-001-00073	130
02-003-00866	91	02-005-00067	120	02-005-00145	125	03-001-00074	131
02-003-00867	94	02-005-00068	120	02-005-00146	126	03-001-00075	131
02-003-00868	94	02-005-00069	120	02-005-00147	125	03-001-00076	148
02-003-00869	236	02-005-00070	120	02-005-00149(XX)	126	03-001-00077	148
02-003-00870	236	02-005-00071	120	02-005-00150	126	03-001-00078	131
02-003-00871	236	02-005-00072	120	02-005-00152	126	03-001-00079	131
02-004-00001	118	02-005-00073	120	02-005-00154(XX)	126	03-001-00080	131
02-004-00002	118	02-005-00074	120	02-005-00155	126	03-001-00081	131
02-004-00003	119	02-005-00075	120	02-005-00156	126	03-001-00082	131
02-004-00004	118	02-005-00076	120	02-005-00157	126	03-001-00083	131
02-004-00005	118	02-005-00077	120	02-005-00160	126	03-001-00084	131
02-004-00006	118	02-005-00078	120	02-005-00161	124	03-001-00085	131
02-004-00008	116	02-005-00079	120	02-005-00162	122	03-001-00086	131
02-004-00009	116	02-005-00080	120	03-001-00001	131	03-001-00087	131
02-004-00010	116	02-005-00081	120	03-001-00002	131	03-001-00088	131
02-004-00011	117	02-005-00082	120	03-001-00003	131	03-001-00089	131
02-004-00012	117	02-005-00083	120	03-001-00004	131	03-001-00090	131
02-004-00013	117	02-005-00084	120	03-001-00005	131	03-001-00091	131
02-004-00014	117	02-005-00085	120	03-001-00006	131	03-001-00092	131
02-004-00015	117	02-005-00086	120	03-001-00007	131	03-001-00093	131
02-004-00016	117	02-005-00087	120	03-001-00008	131	03-001-00094	131
02-004-00017	117	02-005-00088	120	03-001-00009	131	03-001-00095	131
02-004-00018	117	02-005-00089	120	03-001-00010	131	03-001-00096	131
02-004-00019	117	02-005-00090	120	03-001-00011	131	03-001-00097	131
02-004-00020(XX)	116	02-005-00091	121	03-001-00012	131	03-001-00098	131
02-004-00021	117	02-005-00092	121	03-001-00013	131	03-001-00099	131
02-004-00022	117	02-005-00093	121	03-001-00014	131	03-001-00100	131
02-004-00023	117	02-005-00094(XX)	122	03-001-00015	131	03-001-00101	131
02-004-00024(XX)	117	02-005-00095(XX)	123	03-001-00016	131	03-001-00102	131
02-004-00025(XX)	118	02-005-00096	121	03-001-00017	131	03-001-00103	131
02-004-00026(XX)	118	02-005-00097	121	03-001-00018	131	03-001-00104	131
02-004-00028	118	02-005-00098	121	03-001-00019	131	03-001-00105	131
						03-001-00106	131
						03-001-00107	131
						03-001-00108	131
						03-001-00109	131
						03-001-00110	131
						03-001-00111	131
						03-001-00112	131
						03-001-00113	131
						03-001-00114	131
						03-001-00115	131
						03-001-00116	131
						03-001-00117	131
						03-001-00118	131
						03-001-00119	132
						03-001-00120	132
						03-001-00121	132
						03-001-00122	132
						03-001-00123	132
						03-001-00124	132
						03-001-00125	132
						03-001-00126	132
						03-001-00127	132
						03-001-00128	132
						03-001-00129	132
						03-001-00130	132
						03-001-00131	132
						03-001-00132	141
						03-001-00133	141
						03-001-00134	141
						03-001-00135	141
						03-001-00136	141
						03-001-00137	141
						03-001-00138	141
						03-001-00139	141
						03-001-00140	141
						03-001-00141	141
						03-001-00142	141
						03-001-00143	141
						03-001-00149	141
						03-001-00150	141
						03-001-00151	141
						03-001-00152	141
						03-001-00153	141
						03-001-00154	141
						03-001-00155	141
						03-001-00156	141
						03-001-00157	141
						03-001-00158	141
						03-001-00159	141
						03-001-00160	141
						03-001-00161	141
						03-001-00162	141
						03-001-00163	141
						03-001-00164	141
						03-001-00165	141
						03-001-00171	140
						03-001-00172	140
						03-001-00173	130
						03-001-00174	132
						03-001-00175	132
						03-001-00176	132
						03-001-00177	132
						03-001-00178	132
						03-001-00179	132
						03-001-00180	132
						03-001-00181	132
						03-001-00182	132
						03-001-00183	132
						03-001-00184	132
						03-001-00185	132
						03-001-00186	132
						03-001-00187	132
						03-001-00188	132
						03-001-00189	132

PRODUCT CODE	PAGE						
03-001-00640	148	03-002-00052	144	03-002-00134	146	03-002-00223	150
03-001-00641	147	03-002-00053	144	03-002-00135	146	03-002-00224	151
03-001-00642	147	03-002-00054	144	03-002-00136	146	03-002-00225	151
03-001-00643	147	03-002-00055	144	03-002-00137	146	03-002-00227	151
03-001-00644	147	03-002-00056	144	03-002-00138	146	03-002-00228	151
03-001-00645	147	03-002-00057	144	03-002-00139	146	03-002-00229(XX)	152
03-001-00646	147	03-002-00058	144	03-002-00140	146	03-002-00230	152
03-001-00647	147	03-002-00060	143	03-002-00141	146	03-002-00231	152
03-001-00650	143	03-002-00061	143	03-002-00142	146	03-002-00232	152
03-001-00651	143	03-002-00062	143	03-002-00143	146	03-002-00233	152
03-001-00652	130	03-002-00063	143	03-002-00144	146	03-002-00234	152
03-001-00653	133	03-002-00064	143	03-002-00145	146	03-002-00235	152
03-001-00655	133	03-002-00065	143	03-002-00146	146	03-002-00270	150
03-001-00656	136	03-002-00066	143	03-002-00147	146	03-002-00271	150
03-001-00657	137	03-002-00067	143	03-002-00149	146	03-002-00272	151
03-001-00658	136	03-002-00068	143	03-002-00150	146	03-002-00273	151
03-001-00659	136	03-002-00069	144	03-002-00151	146	03-002-00274	151
03-001-00660	129	03-002-00070	144	03-002-00152	146	03-002-00275	151
03-001-00661	131	03-002-00071	144	03-002-00153	146	03-002-00276	151
03-001-00662	131	03-002-00072	144	03-002-00154	143	03-002-00277	151
03-001-00663	132	03-002-00073	144	03-002-00155	146	03-002-00278	152
03-001-00664	132	03-002-00074	144	03-002-00156	146	03-002-00281	151
03-001-00665	132	03-002-00077	144	03-002-00157	146	03-002-00282	151
03-001-00666	141	03-002-00078	144	03-002-00158	146	03-002-00283	151
03-001-00667	141	03-002-00079	144	03-002-00159	146	03-002-00284	151
03-001-00668	132	03-002-00083	145	03-002-00160	147	03-002-00285	151
03-001-00669	132	03-002-00084	145	03-002-00162	145	03-002-00286	151
03-001-00670	136	03-002-00085	145	03-002-00163	145	03-002-00287	151
03-001-00671	136	03-002-00086	145	03-002-00164	145	03-002-00288	152
03-001-00672	136	03-002-00087	145	03-002-00165	145	03-002-00289	151
03-001-00673	136	03-002-00088	145	03-002-00166	145	03-002-00290	152
03-001-00675	141, 142	03-002-00089	145	03-002-00167	145	03-002-00291	152
03-001-00676	142	03-002-00090	145	03-002-00168	145	03-002-00292	152
03-001-00677	142	03-002-00091	145	03-002-00169	145	03-002-00294	152
03-001-00678	142	03-002-00092	145	03-002-00170	146	03-002-00295	152
03-001-00679	141	03-002-00093	145	03-002-00171	146	03-002-00296	152
03-001-00680	141	03-002-00094	145	03-002-00172	146	03-002-00297	152
03-001-00687	184	03-002-00095	145	03-002-00173	146	03-002-00298	152
03-002-00001	142	03-002-00096	145	03-002-00174	146	03-002-00299	152
03-002-00004	142	03-002-00097	145	03-002-00176	147	03-002-00301	152
03-002-00007	142	03-002-00098	145	03-002-00177	147	03-002-00304	153
03-002-00009	142	03-002-00099	145	03-002-00178	147	03-002-00305	153
03-002-00012	148	03-002-00100	145	03-002-00179	147	03-002-00306	153
03-002-00013	148	03-002-00101	145	03-002-00180	147	03-002-00307	153
03-002-00014	148	03-002-00102	145	03-002-00181	148	03-002-00308	153
03-002-00020	148	03-002-00103	143	03-002-00183	149	03-002-00310	153
03-002-00021	148	03-002-00104	143	03-002-00184	149	03-002-00311	153
03-002-00025	148	03-002-00105	143	03-002-00185	149	03-002-00312	153
03-002-00026	148	03-002-00106	143	03-002-00186	149	03-002-00313	153
03-002-00027	148	03-002-00109	144	03-002-00189	149	03-002-00314	153
03-002-00028	143	03-002-00110	144	03-002-00190	150	03-002-00315	153
03-002-00029	143	03-002-00111	144	03-002-00193	150	03-002-00316	153
03-002-00030	143	03-002-00112	144	03-002-00194	150	03-002-00317	153
03-002-00031	143	03-002-00113	144	03-002-00195	150	03-002-00318	153
03-002-00032	143	03-002-00114	145	03-002-00196	150	03-002-00320	153
03-002-00033	144	03-002-00115	145	03-002-00198	150	03-002-00324	153
03-002-00034	144	03-002-00116	143	03-002-00199	138, 150	03-002-00325	153
03-002-00035	144	03-002-00117	143	03-002-00201	138, 150	03-002-00326	153
03-002-00036	143	03-002-00118	143	03-002-00202	151	03-002-00327	154
03-002-00037	143	03-002-00119	143	03-002-00203	151	03-002-00328	154
03-002-00038	143	03-002-00120	143	03-002-00205	149	03-002-00329	154
03-002-00039	144	03-002-00121	143	03-002-00206	149	03-002-00330	135, 154
03-002-00040	144	03-002-00122	145	03-002-00208(XX)	149	03-002-00331(XX)	154
03-002-00041	144	03-002-00123	145	03-002-00210	149	03-002-00332	154
03-002-00042	144	03-002-00124	145	03-002-00211	150	03-002-00333	154
03-002-00043	144	03-002-00125	145	03-002-00212	149	03-002-00334	135, 154
03-002-00044	144	03-002-00126	145	03-002-00213	149	03-002-00335	154
03-002-00045	144	03-002-00127	145	03-002-00214	149	03-002-00336	154
03-002-00046	144	03-002-00128	145	03-002-00215	150	03-002-00337	154
03-002-00047	144	03-002-00129	145	03-002-00216	150	03-002-00338	154
03-002-00048	144	03-002-00130	145	03-002-00217	150	03-002-00339	154
03-002-00049	144	03-002-00131	145	03-002-00219	147	03-002-00340	154
03-002-00050(XX)	144	03-002-00132	145	03-002-00221	151	03-002-00341	154
03-002-00051	144	03-002-00133	143	03-002-00222	150	03-002-00361	159
						03-002-00362	159
						03-002-00363	159
						03-002-00364	159
						03-002-00365	159
						03-002-00366	159
						03-002-00367	159
						03-002-00368	159
						03-002-00369	159
						03-002-00370	159
						03-002-00371	159
						03-002-00372	159
						03-002-00373	159
						03-002-00380	159
						03-002-00381	159
						03-002-00382	159
						03-002-00383	159
						03-002-00384	159
						03-002-00385	159
						03-002-00386	159
						03-002-00387	159
						03-002-00388	159
						03-002-00389	159
						03-002-00390	159
						03-002-00391(XX)	159
						03-002-00392	160
						03-002-00393	160
						03-002-00394	160
						03-002-00395	160
						03-002-00396	160
						03-002-00397	160
						03-002-00398	160
						03-002-00399	160
						03-002-00400	160
						03-002-00401	160
						03-002-00402	160
						03-002-00403	160
						03-002-00404	160
						03-002-00405	160
						03-002-00406	160
						03-002-00407	160
						03-002-00408	160
						03-002-00409	160
						03-002-00410	160
						03-002-00411	160
						03-002-00412	160
						03-002-00413	160
						03-002-00414	160
						03-002-00415	160
						03-002-00416	160
						03-002-00417	160
						03-002-00418	160
						03-002-00419	160
						03-002-00420	160
						03-002-00421	160
						03-002-00422	160
						03-002-00423	160
						03-002-00424	160
						03-002-00425	160
						03-002-00426	160
						03-002-00427	160
						03-002-00428	160
						03-002-00429	160
						03-002-00430	160
						03-002-00431	160
						03-002-00432	160
						03-002-00433	160
						03-002-00434	160
						03-002-00435	160
						03-002-00436	160
						03-002-00437	160
						03-002-00438	160
						03-002-00439	160
						03-002-00440	160
						03-002-00441	160

PRODUCT CODE	PAGE								
03-002-00442	160	03-002-00518	161	03-002-00598	155	03-002-00676	158	04-001-00051	170
03-002-00443	160	03-002-00519(XX)	161	03-002-00599	155	03-002-00677	158	04-001-00052	170
03-002-00444	160	03-002-00520(XX)	161	03-002-00600	155	03-002-00678	158	04-001-00053(XX)	170
03-002-00445	160	03-002-00521(XX)	161	03-002-00601	155	03-002-00679	158	04-001-00054	170
03-002-00446	160	03-002-00522(XX)	161	03-002-00602	155	03-002-00680	158	04-001-00055(XX)	170
03-002-00447	160	03-002-00523	161	03-002-00603	155	03-002-00681	158	04-001-00056(XX)	180
03-002-00448	160	03-002-00524	161	03-002-00604	155	03-002-00682	159	04-001-00057(XX)	180
03-002-00449	160	03-002-00525	161	03-002-00605	155	03-002-00683	159	04-001-00058(XX)	168
03-002-00450	160	03-002-00526	161	03-002-00606	155	03-002-00684	152	04-001-00059	166
03-002-00451	160	03-002-00527	161	03-002-00607	155	03-002-00685	159	04-001-00060	169
03-002-00452	160	03-002-00528	161	03-002-00608	155	03-002-00686	159	04-001-00061	180
03-002-00453	160	03-002-00529	161	03-002-00609	155	03-002-00687	159	04-001-00062	169
03-002-00454	160	03-002-00530	161	03-002-00610	155	03-002-00688	159	04-001-00065	165
03-002-00455	160	03-002-00533(XX)	161	03-002-00611	155	03-002-00689	159	04-001-00068	165
03-002-00456	160	03-002-00534(XX)	161	03-002-00612	155	03-002-00690	159	04-001-00069	169
03-002-00457	160	03-002-00535	161	03-002-00613	155	03-002-00691	159	04-001-00070	165
03-002-00458	160	03-002-00536	161	03-002-00614	155	03-002-00692	159	04-001-00071	165
03-002-00459	160	03-002-00537	161	03-002-00615	155	03-002-00693	159	04-001-00072	165
03-002-00460	160	03-002-00538	161	03-002-00616	155	03-002-00694	159	04-001-00082	165
03-002-00461	160	03-002-00539	161	03-002-00617	156	03-002-00695	159	04-002-00001	172
03-002-00462	160	03-002-00540	161	03-002-00619	157	03-002-00696	159	04-002-00002	172
03-002-00463	160	03-002-00541	161	03-002-00620	157	03-002-00697	159	04-002-00005	172
03-002-00464	160	03-002-00542(XX)	161	03-002-00622	157	03-002-00698	159	04-002-00007	173
03-002-00465	160	03-002-00543(XX)	161	03-002-00623	157	03-002-00699	147	04-002-00010	173
03-002-00466	160	03-002-00544	161	03-002-00624	157	03-002-00700	148	04-002-00011	173
03-002-00467	160	03-002-00545	161	03-002-00625	157	03-002-00701	148	04-002-00012	172
03-002-00468	160	03-002-00546	161	03-002-00626	157	03-002-00702	148	04-002-00013	171
03-002-00469	160	03-002-00547	161	03-002-00627(XX)	155	03-002-00706	142	04-002-00015	172
03-002-00470	160	03-002-00548	161	03-002-00628	156	03-002-00707	148	04-002-00016	172
03-002-00471	160	03-002-00549	161	03-002-00629	156	03-002-00708	148	04-002-00017	171
03-002-00472	160	03-002-00550	161	03-002-00630	156	03-002-00709	149	04-002-00018	173
03-002-00473	160	03-002-00551(XX)	161	03-002-00631	156	03-002-00710	149	04-002-00019	173
03-002-00474	160	03-002-00552	161	03-002-00632	155	03-002-00711	149	04-002-00021	173
03-002-00475	160	03-002-00553	161	03-002-00633	156	03-003-00010	153	04-002-00022	173
03-002-00476	160	03-002-00554	161	03-002-00634	156	03-003-00015	150	04-002-00023	173
03-002-00477	160	03-002-00555	161	03-002-00635	156	03-003-00022	135	04-002-00025	171
03-002-00478	160	03-002-00556	161	03-002-00637	156	03-003-00023	140	04-002-00025(XX)	172
03-002-00479	160	03-002-00557	161	03-002-00639	156	03-005-00002	156	04-002-00026(XX)	172
03-002-00480	160	03-002-00558	161	03-002-00640	157	03-005-00003	156	04-002-00027	173
03-002-00481	160	03-002-00559	161	03-002-00641	157	03-005-00004	158	04-002-00028	174
03-002-00482	160	03-002-00560	161	03-002-00642	157	03-005-00005	155	04-002-00029	174
03-002-00483	160	03-002-00561	161	03-002-00643(XX)	157	03-005-00006	157	04-002-00030	174
03-002-00484	160	03-002-00562	161	03-002-00644(XX)	157	03-005-00007	157	04-002-00032	171
03-002-00485	160	03-002-00563(XX)	161	03-002-00645	157	03-005-00008	157	04-002-00033	171
03-002-00486	160	03-002-00565	161	03-002-00646	157	04-001-00001	164	04-002-00034	172
03-002-00487	160	03-002-00566	161	03-002-00647	158	04-001-00002(XX)	164	04-002-00037	174
03-002-00488	161	03-002-00567	161	03-002-00648	155	04-001-00003	165	04-002-00038	174
03-002-00489	161	03-002-00568	161	03-002-00649	157	04-001-00004	165	04-002-00039	172
03-002-00490	161	03-002-00569	161	03-002-00650	157	04-001-00005	164	04-002-00040	175
03-002-00491	161	03-002-00570	161	03-002-00651	157	04-001-00007	164	04-002-00041	175
03-002-00492	161	03-002-00573	162	03-002-00652	158	04-001-00008(XX)	164	04-002-00043	175
03-002-00493	160	03-002-00575	162	03-002-00653	158	04-001-00009	166	04-002-00045(XX)	176
03-002-00494	160	03-002-00576	162	03-002-00654	158	04-001-00010	164	04-002-00046(XX)	176
03-002-00495	160	03-002-00577	162	03-002-00655	158	04-001-00011	164	04-002-00048(XX)	176
03-002-00496	160	03-002-00578	162	03-002-00656	158	04-001-00013(XX)	164	04-002-00051(XX)	176
03-002-00497	160	03-002-00579	162	03-002-00657	158	04-001-00025(XX)	164	04-002-00052(XX)	176
03-002-00498	160	03-002-00580	162	03-002-00658	158	04-001-00027	166	04-002-00053(XX)	176
03-002-00500	160	03-002-00581	162	03-002-00659(XX)	158	04-001-00028	166	04-002-00054(XX)	176
03-002-00501	160	03-002-00582	162	03-002-00660(XX)	158	04-001-00030	166	04-002-00055(XX)	176
03-002-00502	160	03-002-00583	162	03-002-00661(XX)	158	04-001-00031	167	04-002-00056(XX)	176
03-002-00503	160	03-002-00584	162	03-002-00662(XX)	158	04-001-00032	167	04-002-00057	175
03-002-00504	160	03-002-00585	162	03-002-00663(XX)	158	04-001-00033	167	04-002-00058(XX)	175
03-002-00505	160	03-002-00586	162	03-002-00664(XX)	158	04-001-00034	167	04-002-00059	175
03-002-00506	160	03-002-00587	162	03-002-00665(XX)	158	04-001-00035	167	04-002-00060	176
03-002-00507	160	03-002-00588	162	03-002-00666(XX)	158	04-001-00036	166	04-002-00061(XX)	175
03-002-00509	161	03-002-00589	155	03-002-00667	158	04-001-00037	167	04-002-00062(XX)	176
03-002-00510	161	03-002-00590	155	03-002-00668	158	04-001-00038	167	04-002-00063	176
03-002-00511	161	03-002-00591	155	03-002-00669	158	04-001-00039	167	04-002-00064(XX)	175
03-002-00512	161	03-002-00592	155	03-002-00670	158	04-001-00040	168	04-002-00065(XX)	175
03-002-00513	161	03-002-00593	155	03-002-00671	158	04-001-00041	168	04-002-00066	176
03-002-00514	161	03-002-00594	155	03-002-00672	158	04-001-00045	168	04-002-00067	176
03-002-00515	161	03-002-00595	155	03-002-00673	158	04-001-00047	169	04-002-00068	176
03-002-00516	161	03-002-00596	155	03-002-00674	158	04-001-00049	169	04-002-00071	176
03-002-00517	161	03-002-00597	155	03-002-00675	159	04-001-00050	169	04-002-00072	175

PRODUCT CODE	PAGE						
04-002-00073	176	04-002-00186(XX)	183	04-002-00285(XX)	191	04-003-00030	199
04-002-00074(XX)	175	04-002-00191	183	04-002-00286(XX)	191	04-003-00031	199
04-002-00077	168	04-002-00192	183	04-002-00287	191	04-003-00034(XX)	200
04-002-00078	168	04-002-00193(XX)	184	04-002-00288	191	04-003-00035(XX)	200
04-002-00079	168	04-002-00194	184	04-002-00289	191	04-003-00036	200
04-002-00080	168	04-002-00197	184	04-002-00290(XX)	191	04-003-00043(XX)	200
04-002-00081	168	04-002-00199	184	04-002-00291	191	04-003-00044	199
04-002-00088	178	04-002-00200	184	04-002-00292	191	04-003-00046	200
04-002-00091	177	04-002-00201	184	04-002-00293	192	04-003-00048	202
04-002-00092(XX)	177	04-002-00202	185	04-002-00294	192	04-003-00049	202
04-002-00093(XX)	177	04-002-00203	185	04-002-00295	192	04-003-00050	202
04-002-00094	177	04-002-00204	185	04-002-00296	192	04-003-00051	202
04-002-00095	177	04-002-00205	185	04-002-00297	192	04-003-00057	201
04-002-00096(XX)	177	04-002-00206	185	04-002-00304	191	04-003-00061	202
04-002-00097(XX)	177	04-002-00207	185	04-002-00305(XX)	191	04-003-00062	201
04-002-00098	177	04-002-00208	185	04-002-00306	193	04-003-00063	202
04-002-00099	178	04-002-00211	186	04-002-00307	193	04-003-00064	201
04-002-00100	178	04-002-00212(XX)	186	04-002-00308	193	04-003-00067	202
04-002-00101	178	04-002-00213	186	04-002-00309(XX)	193	04-003-00068	202
04-002-00102	178	04-002-00214	186	04-002-00310(XX)	193	04-003-00069	201
04-002-00103	178	04-002-00215	186	04-002-00311(XX)	193	04-003-00070	201
04-002-00104	178	04-002-00216	186	04-002-00312(XX)	193	04-003-00072	202
04-002-00105	178	04-002-00217	186	04-002-00313(XX)	193	04-003-00073	201
04-002-00107(XX)	179	04-002-00218	186	04-002-00315(XX)	193	04-003-00074	201
04-002-00109(XX)	179	04-002-00219(XX)	186	04-002-00316	192	04-003-00075	202
04-002-00110	179	04-002-00221	187	04-002-00317	192	04-003-00076	203
04-002-00111	179	04-002-00222(XX)	187	04-002-00320	196	04-003-00077	203
04-002-00112	179	04-002-00225	186	04-002-00321	195	04-003-00079	203
04-002-00113(XX)	179	04-002-00226	187	04-002-00322	195	04-003-00083	203
04-002-00114(XX)	179	04-002-00227	187	04-002-00323	195	04-003-00087	207
04-002-00115(XX)	179	04-002-00228(XX)	187	04-002-00324	195	04-003-00091(XX)	207
04-002-00116	179	04-002-00229	186	04-002-00325	196	04-003-00092(XX)	207
04-002-00117	179	04-002-00232	187	04-002-00326	196	04-003-00093	206
04-002-00118	179	04-002-00233	187	04-002-00327	196	04-003-00094	206
04-002-00119(XX)	179	04-002-00234(XX)	187	04-002-00328(XX)	196	04-003-00095(XX)	206
04-002-00120(XX)	179	04-002-00235(XX)	187	04-002-00330	174	04-003-00096(XX)	206
04-002-00121(XX)	179	04-002-00236(XX)	187	04-002-00331	174	04-003-00097	205
04-002-00122(XX)	179	04-002-00237(XX)	187	04-002-00332	174	04-003-00098	205
04-002-00123(XX)	179	04-002-00238(XX)	187	04-002-00335	183	04-003-00099	205
04-002-00124(XX)	179	04-002-00239(XX)	187	04-002-00337	185	04-003-00100	205
04-002-00125(XX)	179	04-002-00240(XX)	187	04-002-00338	185	04-003-00101	204
04-002-00126(XX)	180	04-002-00241(XX)	187	04-002-00340	188	04-003-00102	204
04-002-00127	180	04-002-00242(XX)	187	04-002-00341	184	04-003-00103	204
04-002-00128(XX)	180	04-002-00243	188	04-002-00342	183	04-003-00105(XX)	204
04-002-00129	180	04-002-00244	188	04-002-00344	222	04-003-00106	204
04-002-00130	181	04-002-00249	188	04-002-00345	222	04-003-00107	204
04-002-00131	181	04-002-00250(XX)	188	04-002-00348	195	04-003-00114	206
04-002-00132	181	04-002-00255	188	04-002-00349	196	04-003-00115	206
04-002-00133	181	04-002-00256(XX)	189	04-002-00350	195	04-003-00116	206
04-002-00134	181	04-002-00257(XX)	189	04-002-00351	198	04-003-00118	207
04-002-00135	181	04-002-00258	188	04-002-00352	199	04-003-00119(XX)	207
04-002-00136	181	04-002-00259	188	04-002-00356	183	04-003-00124	203
04-002-00137	181	04-002-00260	189	04-002-00357	178	04-003-00125	203
04-002-00138	181	04-002-00261	189	04-002-00358	185	04-003-00126	203
04-002-00152	181	04-002-00262	189	04-002-00359	185	04-003-00127	205
04-002-00153(XX)	181	04-002-00263	189	04-002-00365	178	04-003-00128	205
04-002-00154(XX)	181	04-002-00265	190	04-002-00369	178	04-003-00130	204
04-002-00155(XX)	182	04-002-00266	190	04-003-00002	178	04-003-00131	204
04-002-00156(XX)	182	04-002-00267	190	04-003-00008(XX)	197	04-003-00132	209
04-002-00157	182	04-002-00268	190	04-003-00009	197	04-003-00133	209
04-002-00158	182	04-002-00269	190	04-003-00010(XX)	197	04-003-00134	209
04-002-00159	182	04-002-00270	190	04-003-00011(XX)	197	04-003-00135	209
04-002-00160	182	04-002-00271	190	04-003-00012(XX)	197	04-003-00136	209
04-002-00163(XX)	182	04-002-00272	190	04-003-00013	197	04-003-00138	208
04-002-00166	183	04-002-00273	190	04-003-00014	197	04-003-00139	208
04-002-00168	183	04-002-00274	190	04-003-00015	197	04-003-00140	208
04-002-00169(XX)	183	04-002-00274	190	04-003-00016(XX)	197	04-003-00141	208
04-002-00170(XX)	183	04-002-00275	190	04-003-00017(XX)	198	04-003-00142	208
04-002-00171(XX)	183	04-002-00276	190	04-003-00018	198	04-003-00143(XX)	208
04-002-00172(XX)	183	04-002-00277	190	04-003-00019	198	04-003-00144(XX)	208
04-002-00173(XX)	183	04-002-00278	190	04-003-00020	198	04-003-00145(XX)	208
04-002-00174(XX)	182	04-002-00279	190	04-003-00021	198	04-003-00146(XX)	208
04-002-00177(XX)	183	04-002-00280	190	04-003-00022	198	04-003-00147	209
04-002-00184(XX)	183	04-002-00281	190	04-003-00023(XX)	198	04-003-00148(XX)	209
		04-002-00282	190	04-003-00024	198		
						04-003-00149	209
						04-003-00150	209
						04-003-00152	210
						04-003-00153	210
						04-003-00154(XX)	209
						04-003-00156	210
						04-003-00157	210
						04-003-00161(XX)	210
						04-003-00162(XX)	210
						04-003-00163	211
						04-003-00165	211
						04-003-00166	211
						04-003-00167	211
						04-003-00168	211
						04-003-00169	211
						04-003-00172	212
						04-003-00173	212
						04-003-00175	212
						04-003-00176	212
						04-003-00179	213
						04-003-00180	212
						04-003-00182	212
						04-003-00183(XX)	212
						04-003-00184	213
						04-003-00185	213
						04-003-00186	213
						04-003-00187(XX)	213
						04-003-00188	213
						04-003-00191	213
						04-003-00192	213
						04-003-00196(XX)	213
						04-003-00197(XX)	213
						04-003-00200(XX)	214
						04-003-00201	214
						04-003-00202	214
						04-003-00203(XX)	214
						04-003-00215	215
						04-003-00216	215
						04-003-00217	215
						04-003-00218	215
						04-003-00219	215
						04-003-00220	215
						04-003-00222	215
						04-003-00223	215
						04-003-00226	216
						04-003-00227	216
						04-003-00228	216
						04-003-00229	216
						04-003-00230	216
						04-003-00231	216
						04-003-00232	216
						04-003-00233	216
						04-003-00234	216
						04-003-00236	216
						04-003-00237(XX)	215
						04-003-00244	219
						04-003-00246	217
						04-003-00250	218
						04-003-00252	218
						04-003-00253	218
						04-003-00254	218
						04-003-00255	218
						04-003-00257	218
						04-003-00259	219
						04-003-00260	219
						04-003-00261	219
						04-003-00262	219
						04-003-00264	207
						04-003-00267(XX)	219
						04-003-00268(XX)	219
						04-003-00269(XX)	219
						04-003-00272(XX)	220
						04-003-00275	219
						04-003-00276	219

PRODUCT CODE	PAGE								
04-003-00277	220	04-006-00022(XX)	227	05-001-00069	231	05-001-00152	234	05-001-00230	239
04-003-00278	217	04-006-00023(XX)	227	05-001-00070	231	05-001-00153	234	05-001-00231	239
04-003-00279	217	04-006-00024(XX)	227	05-001-00071	231	05-001-00154	234	05-001-00232	239
04-003-00280	217	04-006-00025(XX)	226	05-001-00072	231	05-001-00155	235	05-001-00233	239
04-003-00281	217	04-006-00026(XX)	226	05-001-00073	231	05-001-00156	235	05-001-00234	239
04-003-00283	201	04-006-00027(XX)	227	05-001-00074	232	05-001-00157	235	05-001-00235	239
04-003-00284	201	04-006-00028(XX)	227	05-001-00075	232	05-001-00158	235	05-001-00236	239
04-003-00285	211	04-006-00029(XX)	227	05-001-00076	232	05-001-00159	235	05-001-00237	239
04-003-00286	215	04-006-00030(XX)	226	05-001-00077	232	05-001-00160	235	05-001-00238	239
04-003-00287	215	04-006-00031(XX)	226	05-001-00078	232	05-001-00161	235	05-001-00239	240
04-003-00288	199	04-006-00032	224	05-001-00079	232	05-001-00162	235	05-001-00240	240
04-003-00289	218	04-006-00033	225	05-001-00080	232	05-001-00163	235	05-001-00241	240
04-003-00293	199	04-006-00034	224	05-001-00081	232	05-001-00164	235	05-001-00242	240
04-003-00294	198	04-006-00035	225	05-001-00082	244	05-001-00165	235	05-001-00243	240
04-003-00295	211	05-001-00001	229	05-001-00083	232	05-001-00166	235	05-001-00244	239
04-003-00296	211	05-001-00002	229	05-001-00084	232	05-001-00167	235	05-001-00245	239
04-003-00297	212	05-001-00003	229	05-001-00085	230	05-001-00168	235	05-001-00246	239
04-003-00298	217	05-001-00004	229	05-001-00086	230	05-001-00170	236	05-001-00247	239
04-003-00299	217	05-001-00005	229	05-001-00087	230	05-001-00171	236	05-001-00248	239
04-003-00300	217	05-001-00006	229	05-001-00088	230	05-001-00172	236	05-001-00249	239
04-003-00301	217	05-001-00007	229	05-001-00089	232	05-001-00173	236	05-001-00250	239
04-003-00302	218	05-001-00008	229	05-001-00091	232	05-001-00174	236	05-001-00251	239
04-003-00303	207	05-001-00009	229	05-001-00092	232	05-001-00175	236	05-001-00252	272
04-003-00354	205	05-001-00010	229	05-001-00093	232	05-001-00176	236	05-001-00253	273
04-003-00355	205	05-001-00011	229	05-001-00094	232	05-001-00177	236	05-001-00254	240
04-004-00002	220	05-001-00012	229	05-001-00100	233	05-001-00178	236	05-001-00255	240
04-004-00004	220	05-001-00014	229	05-001-00101	233	05-001-00179	236	05-001-00256	240
04-004-00005	220	05-001-00015	229	05-001-00102	233	05-001-00180	236	05-001-00257	240
04-004-00006	220	05-001-00016	229	05-001-00103	232	05-001-00181	236	05-001-00258	240
04-004-00007	220	05-001-00018	230	05-001-00104	232	05-001-00182	236	05-001-00260	240
04-004-00008	221	05-001-00019	230	05-001-00105	232	05-001-00183	237	05-001-00261	233
04-004-00009	221	05-001-00020	230	05-001-00106	232	05-001-00184	237	05-001-00262	233
04-004-00010	221	05-001-00021	230	05-001-00107	232	05-001-00185	237	05-001-00263	230
04-004-00011	221	05-001-00022	230	05-001-00109	233	05-001-00188	237	05-001-00264	230
04-004-00012	221	05-001-00024	230	05-001-00110	233	05-001-00189	237	05-001-00270	229
04-004-00015(XX)	221	05-001-00025	230	05-001-00111	233	05-001-00190	237	05-001-00271	229
04-004-00018	216	05-001-00026	230	05-001-00112	233	05-001-00191	237	05-001-00272	229
04-004-00019	216	05-001-00027	230	05-001-00113	233	05-001-00192	237	05-001-00275	236
04-004-00022	221	05-001-00028	230	05-001-00114	233	05-001-00193	237	05-001-00276	236
04-004-00023	221	05-001-00034	230	05-001-00115	233	05-001-00194	237	05-001-00277	236
04-004-00024	222	05-001-00035	230	05-001-00116	233	05-001-00195	238	05-001-00278	236
04-004-00031	222	05-001-00036	230	05-001-00117	240	05-001-00196	238	05-001-00279	236
04-004-00035	222	05-001-00037	231	05-001-00120	233	05-001-00197	238	05-001-00280	236
04-004-00036	222	05-001-00038	231	05-001-00121	233	05-001-00198	238	05-001-00281	236
04-004-00037	222	05-001-00039	231	05-001-00122	233	05-001-00199	238	05-001-00282	236
04-004-00038	222	05-001-00040	231	05-001-00123	233	05-001-00200	238	05-001-00283	236
04-004-00039	222	05-001-00041	231	05-001-00124	233	05-001-00201	238	05-001-00286	260
04-004-00040	222	05-001-00042	231	05-001-00125	233	05-001-00202	238	05-001-00287	260
04-004-00042	223	05-001-00043	230	05-001-00126	233	05-001-00203	238	05-001-00288	260
04-004-00043	223	05-001-00044	230	05-001-00127	233	05-001-00204	238	05-001-00289	260
04-004-00044	223	05-001-00045	230	05-001-00128	234	05-001-00205	238	05-001-00290	260
04-004-00045	223	05-001-00046	231	05-001-00129	234	05-001-00206	239	05-001-00291	260
04-004-00046	223	05-001-00047	230	05-001-00130	234	05-001-00207	239	05-001-00312	272
04-005-00001	223	05-001-00048	230	05-001-00131	234	05-001-00208	237	05-001-00313	272
04-005-00002(XX)	223	05-001-00049	231	05-001-00132	234	05-001-00210	237	05-001-00314	272
04-005-00003(XX)	223	05-001-00050	231	05-001-00133	234	05-001-00211	239	05-001-00315	272
04-006-00001(XX)	224	05-001-00051	231	05-001-00134	234	05-001-00212	239	05-001-00316	272
04-006-00005	224	05-001-00052	231	05-001-00135	236	05-001-00213	239	05-001-00317	272
04-006-00006(XX)	224	05-001-00053	231	05-001-00136	236	05-001-00214	239	05-001-00318	272
04-006-00007(XX)	224	05-001-00054	231	05-001-00137	236	05-001-00215	239	05-001-00319	272
04-006-00008(XX)	224	05-001-00055	231	05-001-00138	236	05-001-00216	239	05-001-00320	233
04-006-00009	226	05-001-00056	231	05-001-00139	236	05-001-00217	239	05-001-00321	233
04-006-00010	225	05-001-00057	231	05-001-00140	236	05-001-00218	239	05-001-00322	233
04-006-00011	225	05-001-00058	231	05-001-00141	235	05-001-00219	239	05-001-00323	229
04-006-00012	225	05-001-00059	231	05-001-00142	236	05-001-00220	239	05-001-00324	258
04-006-00013	225	05-001-00060	231	05-001-00143	235	05-001-00221	239	05-001-00325	258
04-006-00014	227	05-001-00061	231	05-001-00144	235	05-001-00222	239	05-001-00326	244
04-006-00015	227	05-001-00062	231	05-001-00145	235	05-001-00223	239	05-001-00327	244
04-006-00016	227	05-001-00063	231	05-001-00146	236	05-001-00224	239	05-001-00328	244
04-006-00017(XX)	226	05-001-00064	231	05-001-00147	236	05-001-00225	239	05-001-00329	244
04-006-00018(XX)	226	05-001-00065	231	05-001-00148	236	05-001-00226	239	05-001-00330	244
04-006-00019(XX)	226	05-001-00066	231	05-001-00149	236	05-001-00227	239	05-002-00001	240
04-006-00020(XX)	226	05-001-00067	231	05-001-00150	236	05-001-00228	239	05-002-00002	240
04-006-00021(XX)	226	05-001-00068	231	05-001-00151	234	05-001-00229	239	05-002-00003	240

PRODUCT CODE	PAGE								
06-004-00070	300	06-006-00013	315	06-006-00278(XX)	318	06-008-00061	305	06-009-00046	312
06-004-00071	300	06-006-00014(XX)	315	06-006-00284(XX)	318	06-008-00062	305	06-009-00047	312
06-004-00072	300	06-006-00015(XX)	315	06-006-00291(XX)	321	06-008-00063	305	06-009-00048(XX)	312
06-004-00073	300	06-006-00016(XX)	315	06-006-00292(XX)	318	06-008-00064	305	06-009-00049(XX)	312
06-004-00074	300	06-006-00017	315	06-006-00293(XX)	321	06-008-00065	305	06-009-00051(XX)	312
06-004-00075	300	06-006-00018	315	06-006-00294(XX)	321	06-008-00066	305	06-009-00052	312
06-004-00076	300	06-006-00021	318	06-006-00295(XX)	321	06-008-00067	305	06-009-00054(XX)	312
06-004-00078	301	06-006-00022	318	06-006-00296(XX)	321	06-008-00068	294	06-009-00057(XX)	311
06-004-00079	301	06-006-00025	319	06-006-00297(XX)	321	06-008-00069	297	06-009-00059	324
06-004-00080	299	06-006-00026	319	06-006-00298(XX)	318	06-008-00070	294	06-009-00060(XX)	324
06-004-00081	299	06-006-00027	318	06-006-00300	318	06-008-00071	294	06-009-00062(XX)	325
06-004-00082	299	06-006-00028	318	06-006-00301(XX)	318	06-008-00072	308	06-009-00063(XX)	325
06-004-00097	299	06-006-00033	318	06-006-00302(XX)	318	06-008-00073	308	06-009-00064(XX)	325
06-004-00098	299	06-006-00034	320	06-006-00303	318	06-008-00074	308	06-009-00065(XX)	326
06-004-00099	299	06-006-00035	320	06-006-00304(XX)	321	06-008-00075	308	06-009-00066(XX)	325
06-004-00100(XX)	299	06-006-00036	319	06-006-00306	318	06-008-00076	308	06-009-00067	325
06-004-00101(XX)	299	06-006-00037	319	06-006-00309	318	06-008-00077	308	06-009-00068(XX)	326
06-004-00102(XX)	299	06-006-00038	320	06-006-00310	322	06-008-00078	296	06-009-00070	324
06-004-00103(XX)	299	06-006-00039	318	06-007-00001	292	06-008-00079	296	06-009-00071	324
06-004-00104	300	06-006-00040	318	06-007-00002	293	06-008-00082	296	06-009-00072(XX)	325
06-005-00001(XX)	315	06-006-00041	318	06-007-00003	293	06-008-00083	296	06-009-00073(XX)	325
06-005-00002	315	06-006-00042	318	06-007-00004	293	06-008-00084	296	06-009-00074(XX)	324
06-005-00003	315	06-006-00043	318	06-007-00005	293	06-008-00085	296	06-009-00075	325
06-005-00004	315	06-006-00044	318	06-007-00006	293	06-008-00086	296	06-009-00076	325
06-005-00006	314	06-006-00046	318	06-007-00007	293	06-008-00087	294	06-009-00077	326
06-005-00007	314	06-006-00047	317, 318	06-007-00008(XX)	294	06-008-00088	294	06-009-00078	326
06-005-00008	314	06-006-00048	317, 318	06-007-00017	292	06-008-00089	294	06-009-00079	326
06-005-00009	314	06-006-00049	318	06-007-00018	293	06-008-00090	297	06-009-00080	326
06-005-00010	314	06-006-00050	320	06-007-00019	293	06-008-00091	297	06-009-00081	326
06-005-00011	314	06-006-00051	317	06-008-00001	296	06-008-00092	297	06-009-00082	326
06-005-00012	314	06-006-00054(XX)	317	06-008-00002	296	06-008-00093	297	06-009-00083	326
06-005-00013	314	06-006-00055(XX)	317, 318	06-008-00003	296	06-008-00094	297	06-009-00084(XX)	324
06-005-00014	314	06-006-00085(XX)	317	06-008-00004	297	06-009-00001	322	06-009-00085	323
06-005-00015	314	06-006-00086(XX)	317	06-008-00005	297	06-009-00002	322	06-009-00086	324
06-005-00016	314	06-006-00144(XX)	318	06-008-00006(XX)	297	06-009-00003	321	06-009-00087	324
06-005-00017	314	06-006-00145(XX)	318	06-008-00007	297	06-009-00004	321	06-009-00088	324
06-005-00018	314	06-006-00153(XX)	318	06-008-00008	297	06-009-00006	321	06-009-00089(XX)	323
06-005-00019	314	06-006-00155(XX)	318	06-008-00009	297	06-009-00007	321	06-009-00090(XX)	323
06-005-00020	314	06-006-00157(XX)	317	06-008-00010	297	06-009-00008	321	06-009-00091(XX)	323
06-005-00021	314	06-006-00158(XX)	317, 318	06-008-00013	295	06-009-00009	321	06-009-00092(XX)	323
06-005-00022	314	06-006-00175(XX)	321	06-008-00014	295	06-009-00010	321	06-009-00093	323
06-005-00023	314	06-006-00204(XX)	317	06-008-00015	295	06-009-00011	321	06-009-00094	323
06-005-00024	314	06-006-00205(XX)	320	06-008-00016	295	06-009-00012(XX)	321	06-009-00095	323
06-005-00025	314	06-006-00206	319	06-008-00017	295	06-009-00013	323	06-009-00096(XX)	323
06-005-00026	314	06-006-00207	319	06-008-00018	295	06-009-00014	323	06-009-00097(XX)	325
06-005-00027	314	06-006-00208	319	06-008-00019	295	06-009-00015	323	06-009-00098(XX)	325
06-005-00028	314	06-006-00209	319	06-008-00020	295	06-009-00016	322	06-009-00099	325
06-005-00029	314	06-006-00210	319	06-008-00025	295	06-009-00017	322	06-009-00100	325
06-005-00030	314	06-006-00211	319	06-008-00026	295	06-009-00018	322	06-009-00101(XX)	325
06-005-00031	314	06-006-00212	319	06-008-00027	295	06-009-00020	322	06-009-00102(XX)	313
06-005-00032	314	06-006-00213	319	06-008-00028	295	06-009-00021	322	06-009-00103(XX)	313
06-005-00033	314	06-006-00214	319	06-008-00029	295	06-009-00022	322	06-009-00104(XX)	313
06-005-00034	314	06-006-00215	319	06-008-00030	295	06-009-00023	322	06-009-00105	327
06-005-00035	314	06-006-00216	319	06-008-00032(XX)	296	06-009-00024	322	06-009-00106	327
06-005-00036	314	06-006-00217	319	06-008-00034(XX)	296	06-009-00025	322	06-009-00107(XX)	327
06-005-00037	314	06-006-00218	319	06-008-00035	294	06-009-00026	322	06-009-00108	327
06-005-00038	315	06-006-00219	319	06-008-00036	294	06-009-00027	322	06-009-00109	327
06-005-00039	315	06-006-00220	319	06-008-00037	294	06-009-00028	322	06-009-00110	327
06-005-00040	315	06-006-00221	319	06-008-00038	294	06-009-00029	322	06-009-00113	327
06-005-00041	315	06-006-00222	319	06-008-00042	296	06-009-00030	323	06-009-00114	327
06-005-00042	314	06-006-00223	319	06-008-00043	296	06-009-00031	323	06-009-00115	327
06-005-00045	314	06-006-00224	320	06-008-00046	296	06-009-00032	323	06-009-00116	326
06-006-00001	315	06-006-00225	320	06-008-00047	296	06-009-00033	323	06-009-00117	326
06-006-00002	315	06-006-00227	319	06-008-00050	294	06-009-00034(XX)	322	06-009-00118(XX)	326
06-006-00003	315	06-006-00228	319	06-008-00051	294	06-009-00035	312	06-009-00121	326
06-006-00004(XX)	315	06-006-00243(XX)	320, 381	06-008-00052	294	06-009-00036	313	06-009-00122	326
06-006-00005	316	06-006-00244	319	06-008-00053	294	06-009-00038	313	06-009-00125	325
06-006-00006	316	06-006-00245	320	06-008-00054	294	06-009-00039	312	06-009-00126	325
06-006-00007(XX)	316	06-006-00246	320	06-008-00055	294	06-009-00040	312	06-009-00127	325
06-006-00008	316	06-006-00247	320	06-008-00056	305	06-009-00041	312	06-009-00128	327
06-006-00009	316	06-006-00250(XX)	319	06-008-00057	305	06-009-00042	313	06-009-00131	321
06-006-00010(XX)	316	06-006-00251(XX)	318	06-008-00058	305	06-009-00043	313	06-009-00132	322
06-006-00011	316	06-006-00264(XX)	318	06-008-00059	305	06-009-00044	313	06-009-00133	322
06-006-00012	316	06-006-00271(XX)	318	06-008-00060	305	06-009-00045	312	06-009-00134	322

PRODUCT CODE	PAGE								
06-009-00135	322	07-002-00070(XX)	341	07-002-00170	347	07-002-00248	349	07-002-00347	352
06-009-00136	303	07-002-00071(XX)	341	07-002-00171	347	07-002-00251	349	07-003-00001	348
06-009-00137	303	07-002-00072	340	07-002-00172	347	07-002-00252	349	07-003-00002	348
06-009-00138	303	07-002-00073	340	07-002-00173	347	07-002-00253	349	07-003-00003	348
06-009-00139	327	07-002-00074	341	07-002-00174	347	07-002-00254	349	07-003-00004	348
06-009-00140	327	07-002-00075	341	07-002-00175	347	07-002-00255	349	07-003-00005	348
07-001-00001	354	07-002-00076	341	07-002-00176	347	07-002-00256	349	07-003-00006	348
07-001-00002	354	07-002-00077	341	07-002-00177	347	07-002-00257	349	07-003-00012	348
07-001-00003	354	07-002-00078	341	07-002-00178	347	07-002-00258	349	07-003-00013	348
07-001-00004	354	07-002-00079	341	07-002-00179	347	07-002-00259	349	07-003-00015	348
07-002-00001	346	07-002-00080	341	07-002-00180	347	07-002-00260	349	07-003-00016	348
07-002-00002	346	07-002-00081	341	07-002-00181	337, 347	07-002-00261	349	07-004-00010	352
07-002-00003(XX)	346	07-002-00082	341	07-002-00182	348	07-002-00264(XX)	350	07-004-00011	352
07-002-00004	346	07-002-00083	341	07-002-00183	348	07-002-00265	338	07-004-00012	16, 352
07-002-00005	346	07-002-00084	341	07-002-00184	348	07-002-00266	338	07-004-00013	352
07-002-00009	346	07-002-00085	341	07-002-00185	348	07-002-00267	338	07-004-00015	352
07-002-00010	341	07-002-00086	341	07-002-00186	348	07-002-00268	338	07-004-00016	352
07-002-00011	341	07-002-00087	341	07-002-00187(XX)	340	07-002-00269	338	07-004-00017	352
07-002-00012	342	07-002-00088	341	07-002-00188	349	07-002-00270	338	07-004-00018	352
07-002-00013	342	07-002-00089	341	07-002-00189	349	07-002-00271	338	07-005-00001	330
07-002-00014	342	07-002-00090	341	07-002-00190	349	07-002-00272	338	07-005-00002	330
07-002-00015	342	07-002-00091	342	07-002-00191	349	07-002-00273	338	07-005-00003	330
07-002-00016	342	07-002-00092	342	07-002-00194	351	07-002-00274	338	07-005-00005	330
07-002-00017	342	07-002-00093	343	07-002-00195	351	07-002-00275	338	07-005-00006	330
07-002-00018	342	07-002-00094	345	07-002-00196	351	07-002-00276	338	07-005-00007	330
07-002-00019	346	07-002-00095	347	07-002-00197	351	07-002-00277	339	07-005-00008	330
07-002-00020	346	07-002-00096	347	07-002-00198	351	07-002-00278	339	07-005-00009	330
07-002-00021	346	07-002-00097	347	07-002-00199	343	07-002-00279	339	07-005-00010	330
07-002-00022	346	07-002-00098	347	07-002-00200	345	07-002-00280	339	07-005-00011	332
07-002-00023	346	07-002-00099	347	07-002-00201	346	07-002-00281	339	07-005-00012	332
07-002-00024	346	07-002-00100	347	07-002-00202	346	07-002-00282	339	07-005-00013	332
07-002-00025	346	07-002-00101	346	07-002-00203	346	07-002-00283	339	07-005-00014	332
07-002-00026	346	07-002-00102	348	07-002-00205	350	07-002-00284	339	07-005-00029	333
07-002-00027	346	07-002-00104	340	07-002-00206	350	07-002-00285	339	07-005-00030	333
07-002-00028	346	07-002-00105	348	07-002-00207	350	07-002-00286	339	07-005-00031	333
07-002-00029	342	07-002-00106	347	07-002-00208	350	07-002-00287	339	07-005-00032	333
07-002-00030	342	07-002-00107	348	07-002-00209	350	07-002-00288	339	07-005-00033	333
07-002-00031(XX)	342	07-002-00108	348	07-002-00210	350	07-002-00289	339	07-005-00034	333
07-002-00032	342	07-002-00109	348	07-002-00211	350	07-002-00290	339	07-005-00035	333
07-002-00033	343	07-002-00110(XX)	343	07-002-00212	350	07-002-00291	339	07-005-00036	333
07-002-00034	342	07-002-00111(XX)	343	07-002-00213	351	07-002-00292	338	07-005-00037	333
07-002-00035	342	07-002-00114	343	07-002-00214	351	07-002-00293	338	07-005-00038	333
07-002-00036	343	07-002-00117(XX)	343	07-002-00215	350	07-002-00294	338	07-005-00040	329
07-002-00037	343	07-002-00121	343	07-002-00216	351	07-002-00301	336	07-005-00041	329
07-002-00038	343	07-002-00122	343	07-002-00217	351	07-002-00302	336	07-005-00042	329
07-002-00041	339	07-002-00123(XX)	344	07-002-00218	351	07-002-00303	336	07-005-00043	329
07-002-00042	339	07-002-00124	344	07-002-00219	351	07-002-00304	336	07-005-00044	329
07-002-00043	339	07-002-00126	344	07-002-00220	337	07-002-00305	337	07-005-00045	329
07-002-00044	338	07-002-00127	344	07-002-00221	337	07-002-00306	337	07-005-00046	330
07-002-00045	338	07-002-00128	344	07-002-00222	337	07-002-00308	336	07-005-00047	330
07-002-00046	339	07-002-00129	344	07-002-00223	337	07-002-00310	338	07-005-00048	330
07-002-00047	339	07-002-00130	344	07-002-00224	337	07-002-00311	338	07-005-00049	330
07-002-00048	338	07-002-00131	344	07-002-00225	337	07-002-00312	338	07-005-00050	330
07-002-00049	340	07-002-00132	344	07-002-00226	337	07-002-00314	338	07-005-00063	330
07-002-00050	340	07-002-00133	344	07-002-00227(XX)	337	07-002-00315	338	07-005-00064	330
07-002-00051	340	07-002-00134	344	07-002-00228	337	07-002-00316	338	07-005-00065	330
07-002-00052	340	07-002-00135	344	07-002-00229	337	07-002-00317	338	07-005-00066	330
07-002-00053	340	07-002-00142	344	07-002-00230	349	07-002-00318	338	07-005-00067	330
07-002-00054	340	07-002-00143(XX)	344	07-002-00232	349	07-002-00319	338	07-005-00077	330
07-002-00055	340	07-002-00148	345	07-002-00233	349	07-002-00321	334	07-005-00078	330
07-002-00056	340	07-002-00149	345	07-002-00234	349	07-002-00322	334	07-005-00080	332
07-002-00057	340	07-002-00150	345	07-002-00235	349	07-002-00323	334	07-005-00081	332
07-002-00058	340	07-002-00151	344	07-002-00236	349	07-002-00324	334	07-005-00082	332
07-002-00059	340	07-002-00152(XX)	344	07-002-00237	349	07-002-00328	350	07-005-00083	333
07-002-00060	340	07-002-00157	344	07-002-00238	349	07-002-00330	339	07-005-00084(XX)	333
07-002-00061	340	07-002-00158	345	07-002-00239	349	07-002-00332	339	07-005-00085	333
07-002-00062	340	07-002-00159	345	07-002-00240	349	07-002-00333	339	07-005-00086	333
07-002-00063	340	07-002-00160	345	07-002-00241	349	07-002-00334	339	07-005-00087	333
07-002-00064(XX)	340	07-002-00161	345	07-002-00242	349	07-002-00335	339	07-005-00088	333
07-002-00065	341	07-002-00162	345	07-002-00243	349	07-002-00336	339	07-005-00089	333
07-002-00066	341	07-002-00163	345	07-002-00244	349	07-002-00337	339	07-005-00090	333
07-002-00067	341	07-002-00167	347	07-002-00245	349	07-002-00338	351	07-005-00091	333
07-002-00068	341	07-002-00168	347	07-002-00246	349	07-002-00341	351	07-005-00092	333
07-002-00069	341	07-002-00169	347	07-002-00247	349	07-002-00342	349	07-005-00093	333

PRODUCT CODE	PAGE								
08-001-00417	365	08-003-00012(XX)	366	09-003-00002	373	09-003-00100	379	09-003-00190	373
08-001-00418	365	08-003-00013(XX)	366	09-003-00012	373	09-003-00101	379	09-003-00191	373
08-001-00419	365	08-003-00015(XX)	366	09-003-00013(XX)	373	09-003-00102	379	09-003-00192	373
08-001-00420	365	08-003-00016	357	09-003-00014(XX)	373	09-003-00103	379	09-003-00193	373
08-001-00422	365	08-003-00017	357	09-003-00015(XX)	373	09-003-00104	379	09-003-00194	373
08-001-00423	365	08-003-00018	357	09-003-00016(XX)	373	09-003-00105	379	09-003-00195	373
08-001-00424	365	08-003-00019	357	09-003-00017(XX)	373	09-003-00106	380	09-003-00196	373
08-001-00425	365	08-003-00023	358	09-003-00018(XX)	373	09-003-00107	380	09-003-00197	373
08-001-00426	365	08-003-00024	358	09-003-00019(XX)	374	09-003-00108	380	09-003-00198	373
08-001-00427	365	08-003-00025	358	09-003-00020(XX)	374	09-003-00109	380	09-003-00199	380
08-001-00428	365	08-003-00026	356	09-003-00021(XX)	374	09-003-00110	380	09-003-00203	378
08-001-00429	365	08-003-00027	356	09-003-00022(XX)	374	09-003-00111	380	09-003-00204	378
08-001-00430	365	08-003-00028	356	09-003-00023(XX)	374	09-003-00112	380	09-003-00208	380
08-001-00431	365	08-003-00029	356	09-003-00024(XX)	374	09-003-00113	381	10-001-00001	388
08-001-00432	365	08-003-00030	357	09-003-00025(XX)	374	09-003-00117	380	10-001-00002	385
08-001-00433	365	08-003-00031	357	09-003-00026(XX)	374	09-003-00118	380	10-001-00003	385
08-001-00434	365	08-003-00032	357	09-003-00027(XX)	374	09-003-00119	380	10-001-00004	386
08-001-00435	365	08-003-00033	356	09-003-00028(XX)	374	09-003-00120	381	10-001-00005	386
08-001-00436	365	08-003-00034	356	09-003-00029(XX)	374	09-003-00122	381	10-001-00006	386
08-002-00001	361	08-003-00035	357	09-003-00030(XX)	374	09-003-00123(XX)	381	10-001-00007	386
08-002-00002	361	08-003-00036	357	09-003-00031(XX)	374	09-003-00126	381	10-001-00008	385
08-002-00003	361	08-003-00037	357	09-003-00032(XX)	374	09-003-00127	381	10-001-00009	386
08-002-00004	361	08-003-00038	357	09-003-00033(XX)	374	09-003-00132	373	10-001-00010	385
08-002-00005	361	08-003-00039	357	09-003-00034(XX)	374	09-003-00133	373	10-001-00011	385
08-002-00006	361	08-003-00040	357	09-003-00035(XX)	374	09-003-00134	373	10-001-00012	385
08-002-00007	362	08-003-00041	357	09-003-00036(XX)	374	09-003-00136	373	10-001-00013	385
08-002-00008	362	08-003-00042	357	09-003-00037(XX)	374	09-003-00137	373	10-001-00014	387
08-002-00009	362	08-003-00043	357	09-003-00039(XX)	374	09-003-00138	373	10-001-00015	387
08-002-00010	362	08-003-00044	357	09-003-00040(XX)	374	09-003-00139	373	10-001-00016	387
08-002-00011	362	08-003-00045	357	09-003-00041(XX)	374	09-003-00140	373	10-001-00017	387
08-002-00012	362	08-003-00046	359	09-003-00046	375	09-003-00141	373	10-001-00018	386
08-002-00013	361	08-003-00047	359	09-003-00047	375	09-003-00142	373	10-001-00019	387
08-002-00014	361	08-003-00048	357	09-003-00048	375	09-003-00145	373	10-001-00020	387
08-002-00015	361	08-003-00049	357	09-003-00050	375	09-003-00146	373	10-001-00022	387
08-002-00016	362	08-003-00050	359	09-003-00051	375	09-003-00147	373	10-001-00024	387
08-002-00017	362	08-003-00051	358	09-003-00052	375	09-003-00148	373	10-001-00026	386
08-002-00018	362	08-003-00052	358	09-003-00055(XX)	376	09-003-00149	373	10-001-00028	386
08-002-00019	362	08-003-00053	358	09-003-00056(XX)	376	09-003-00150	380	10-001-00029	385
08-002-00020	362	08-003-00054	358	09-003-00057(XX)	376	09-003-00151	380	10-001-00030	384
08-002-00021	361	08-003-00055(XX)	356	09-003-00058(XX)	376	09-003-00152(XX)	380	10-001-00031	384
08-002-00022	362	08-003-00056	356	09-003-00059(XX)	377	09-003-00153(XX)	380	10-001-00032	384
08-002-00023	362	08-003-00057	356	09-003-00060	377	09-003-00154	374	10-001-00033	384
08-002-00024	362	08-003-00058	356	09-003-00062	377	09-003-00155	374	10-001-00034	385
08-002-00025	362	08-003-00059	356	09-003-00063	377	09-003-00156	374	10-001-00035	384
08-002-00026	362	08-003-00060	356	09-003-00065	377	09-003-00157	374	10-001-00036	384
08-002-00027	362	08-003-00061	356	09-003-00066	377	09-003-00158	374	10-001-00037	384
08-002-00028	362	08-003-00062	356	09-003-00069	377	09-003-00159	374	10-001-00038	384
08-002-00029	362	08-003-00063	356	09-003-00072	377	09-003-00160	374	10-001-00039	384
08-002-00030	361	08-003-00064	356	09-003-00074	377	09-003-00161	374	10-001-00040	384
08-002-00031	360	08-003-00065	356	09-003-00075	377	09-003-00162	374	10-001-00044	384
08-002-00032	360	08-003-00066	356	09-003-00076	377	09-003-00163	374	10-001-00045	384
08-002-00033	360	08-003-00068	358	09-003-00077	377	09-003-00164	374	10-001-00048	388
08-002-00034	360	08-003-00069	358	09-003-00078	377	09-003-00166	375	10-001-00049	388
08-002-00035	360	08-003-00070	358	09-003-00079	377	09-003-00167	375	10-001-00050	388
08-002-00040	360	08-003-00071	358	09-003-00080	377	09-003-00169	375	10-001-00051	388
08-002-00041	360	08-003-00072	356	09-003-00081	377	09-003-00170	375	10-001-00052	388
08-002-00042	360	08-003-00073	356	09-003-00082	377	09-003-00171	375	10-001-00053	388
08-002-00043	360	08-003-00074	356	09-003-00083	378	09-003-00172	375	10-001-00054	388
08-002-00044	361	08-003-00075	356	09-003-00084	378	09-003-00173	375	10-001-00056	389
08-002-00045	360	08-003-00076	356	09-003-00085	378	09-003-00174	375	10-001-00057(XX)	388
08-002-00046	360	08-003-00077	356	09-003-00086	378	09-003-00175	380	10-001-00059	389
08-002-00047	360	08-003-00078	358	09-003-00087	378	09-003-00177	373	10-001-00062	389
08-002-00048	361	08-003-00079	358	09-003-00088	378	09-003-00178	373	10-001-00063	389
08-002-00049	361	09-002-00003(XX)	376	09-003-00089	378	09-003-00179	373	10-001-00064	389
08-002-00050	361	09-002-00005(XX)	376	09-003-00090	379	09-003-00180	373	10-001-00080	389
08-003-00001	356	09-002-00006	376	09-003-00091	379	09-003-00181	373	10-001-00081	389
08-003-00002	356	09-002-00007	376	09-003-00092	379	09-003-00182	373	10-001-00082	389
08-003-00003	356	09-002-00012(XX)	376	09-003-00093	379	09-003-00183	373	10-001-00083	387
08-003-00004	356	09-002-00013(XX)	376	09-003-00094	378	09-003-00184	373	10-001-00084	389
08-003-00005	356	09-002-00014(XX)	376	09-003-00095	379	09-003-00185	373	10-001-00085	385
08-003-00007(XX)	366	09-002-00015(XX)	376	09-003-00096	379	09-003-00186	373	10-001-00086	385
08-003-00009	366	09-002-00016(XX)	376	09-003-00097	379	09-003-00187	373	10-001-00087	389
08-003-00010	366	09-002-00017	326	09-003-00098	379	09-003-00188	373	10-001-00088	388
08-003-00011	366	09-003-00001	373	09-003-00099	379	09-003-00189	373	10-001-00089	389

PRODUCT CODE	PAGE						
10-001-00090	389	14-002-00027	390	16-002-00021	396	CPA243072V4-480	287
10-001-00093	387	14-002-00028	392	16-002-00022	396	CPA243664V4-480	287
10-001-00094	387	14-002-00029	392	16-002-00023	396	CPA243672V4-480	287
10-001-00095	387	14-002-00031	391	16-002-00024	396	CPA244264V4-480	287
10-001-00096	387	14-002-00032	391	16-002-00025	396	CPA244272V4-480	287
10-001-00097	387	14-002-00033	392	16-002-00026	396	CPA244864V4-480	287
10-001-00101	386	14-002-00034	392	16-002-00027	396	CPA244872V4-480	287
10-001-00102	386	14-002-00035	392	16-002-00028	396	CPA245464V4-480	287
10-001-00103	388	14-002-00036	392	16-002-00029	396	CPA245472V4-480	287
10-001-00104	388	14-002-00037	392	16-002-00030	396	CPA246064V4-480	287
10-001-00105	388	14-002-00038	393	16-002-00031	396	CPA246072V4-480	287
10-001-00106	388	14-002-00041	392	16-002-00032	396	CPA247264V4PKG-480	287
10-001-00107	388	14-002-00042	393	16-002-00033	396	CPA247272V4PKG-480	287
10-001-00108	387	14-002-00044	393	16-002-00035	396	CPMU183667V4-480	288
10-001-00109	389	14-002-00045	393	16-002-00036	396	CPMU183675V4-480	288
10-001-00111	389	14-002-00046	393	16-002-00037	396	CPMU184267V4-480	288
10-001-00113	388	14-002-00047	393	16-002-00038	396	CPMU184275V4-480	288
10-001-00114	388	14-002-00048	393	16-002-00039(XX)	396	CPMU184867V4-480	288
10-001-00115	388	14-002-00049	393	16-002-00040	396	CPMU184875V4-480	288
10-001-00119	388	14-002-00050	393	16-002-00041	396	CPMU213667V4-480	288
10-001-00120	388	14-002-00051	393	16-002-00042	396	CPMU213675V4-480	288
10-001-00121	388	14-002-00052	392	16-002-00043	396	CPMU214267V4-480	288
10-001-00122	388	14-002-00053	392	16-002-00044	396	CPMU214275V4-480	288
10-001-00123	384	14-004-00003	397	16-002-00045(XX)	396	CPMU214867V4-480	288
10-001-00125	384	14-004-00004	397	16-002-00046(XX)	396	CPMU214875V4-480	288
10-001-00126	384	14-004-00005	397	16-002-00047	396	CPMU243667V4-480	288
10-001-00127	384	14-004-00006	397	16-002-00048(XX)	396	CPMU243675V4-480	288
10-001-00128	384	14-004-00007	397	16-002-00049	395	CPMU244267V4-480	288
10-001-00129	385	14-004-00008	397	16-002-00050	395	CPMU244275V4-480	288
10-001-00130	385	14-004-00009	397	16-003-00002(XX)	396	CPMU244867V4-480	288
10-001-00131	385	14-004-00010	397	16-003-00003(XX)	396	CPMU244875V4-480	288
10-001-00132	388	14-004-00011	397	16-004-00001	398	CPU182464V4-480	287
10-001-00133	388	14-004-00012	397	16-004-00002	398	CPU182472V4-480	287
10-001-00134	388	14-004-00013	397	16-004-00003	398	CPU183064V4-480	287
10-001-00135	388	14-004-00014	397	16-004-00004	398	CPU183072V4-480	287
10-001-00136	387	14-004-00015	397	16-004-00005	398	CPU183664V4-480	287
10-001-00137	386	14-004-00016	397	16-004-00007	398	CPU183672V4-480	287
10-001-00138	384	14-004-00017	397	16-004-00008(XX)	398	CPU184264V4-480	287
10-001-00139	385	14-004-00018	397	16-004-00009(XX)	398	CPU184272V4-480	287
10-001-00140	385	14-004-00019	397	CPA182464V4-480	287	CPU184864V4-480	287
10-001-00141	385	14-004-00020	397	CPA182472V4-480	287	CPU184872V4-480	287
10-001-00143	386	14-004-00021	397	CPA183064V4-480	287	CPU185464V4-480	287
10-001-00144	386	14-004-00022	397	CPA183072V4-480	287	CPU185472V4-480	287
10-001-00145	387	14-004-00023	397	CPA183664V4-480	287	CPU186064V4-480	287
10-001-00146	386	14-004-00024	397	CPA183672V4-480	287	CPU186072V4-480	287
10-001-00149	386	14-004-00025	397	CPA184264V4-480	287	CPU187264V4PKG-480	287
10-001-00150	385	14-004-00026	397	CPA184272V4-480	287	CPU187272V4PKG-480	287
10-001-00151	385	14-004-00027	397	CPA184864V4-480	287	CPU212464V4-480	287
10-001-00152	385	14-004-00028	397	CPA184872V4-480	287	CPU212472V4-480	287
10-002-00001	386	15-001-00026	259	CPA185464V4-480	287	CPU213064V4-480	287
13-002-00008	20	15-001-00027	259	CPA185472V4-480	287	CPU213072V4-480	287
13-002-00009	20	15-001-00028	259	CPA186064V4-480	287	CPU213664V4-480	287
14-001-00015	148	15-001-00029	259	CPA186072V4-480	287	CPU213672V4-480	287
14-002-00001	389	15-001-00030	259	CPA187264V4PKG-480	287	CPU214264V4-480	287
14-002-00002	390	15-001-00031	259	CPA187272V4PKG-480	287	CPU214272V4-480	287
14-002-00003(XX)	390	15-001-00032	259	CPA212464V4-480	287	CPU214864V4-480	287
14-002-00004	390	15-001-00033	259	CPA212472V4-480	287	CPU214872V4-480	287
14-002-00005	390	15-001-00034	259	CPA213064V4-480	287	CPU215464V4-480	287
14-002-00006	390	16-001-00001	395	CPA213072V4-480	287	CPU215472V4-480	287
14-002-00007	390	16-001-00002	395	CPA213664V4-480	287	CPU216064V4-480	287
14-002-00008	390	16-001-00004	395	CPA213672V4-480	287	CPU216072V4-480	287
14-002-00009	390	16-001-00005	395	CPA214264V4-480	287	CPU217264V4PKG-480	287
14-002-00010	390	16-001-00006(XX)	395	CPA214272V4-480	287	CPU217272V4PKG-480	287
14-002-00011	391	16-001-00007	395	CPA214864V4-480	287	CPU242464V4-480	287
14-002-00012	391	16-002-00007	395	CPA214872V4-480	287	CPU242472V4-480	287
14-002-00013	391	16-002-00008	395	CPA215464V4-480	287	CPU243064V4-480	287
14-002-00014	391	16-002-00009	395	CPA215472V4-480	287	CPU243072V4-480	287
14-002-00015	391	16-002-00010(XX)	395	CPA216064V4-480	287	CPU243664V4-480	287
14-002-00020	391	16-002-00011(XX)	395	CPA216072V4-480	287	CPU243672V4-480	287
14-002-00021	392	16-002-00016	396	CPA217264V4PKG-480	287	CPU244264V4-480	287
14-002-00022	391	16-002-00017	396	CPA217272V4PKG-480	287	CPU244272V4-480	287
14-002-00024	391	16-002-00018	396	CPA242464V4-480	287	CPMU244864V4-480	287
14-002-00025	392	16-002-00019	396	CPA242472V4-480	287	CPMU244872V4-480	287
14-002-00026	390	16-002-00020	396	CPA243064V4-480	287	CPU245464V4-480	287

PRODUCT CODE	PAGE		
CPU245472V4-480	287	ESU217272V4-580	287
CPU246064V4-480	287	ESU242472V4-580	287
CPU246072V4-480	287	ESU243072V4-580	287
CPU247264V4PKG-480	287	ESU243672V4-580	287
CPU247272V4PKG-480	287	ESU244272V4-580	287
EA182472V4-580	287	ESU244872V4-580	287
EA183072V4-580	287	ESU245472V4-580	287
EA183672V4-580	287	ESU246072V4-580	287
EA184272V4-580	287	ESU247272V4-580	287
EA184872V4-580	287	ESU245472V4-580	287
EA185472V4-580	287	ESU246072V4-580	287
EA186072V4-580	287	ESU247272V4-580	287
EA187272V4-580	287		
EA212472V4-580	287		
EA213072V4-580	287		
EA213672V4-580	287		
EA214272V4-580	287		
EA214872V4-580	287		
EA215472V4-580	287		
EA216072V4-580	287		
EA217272V4-580	287		
EA242472V4-580	287		
EA243072V4-580	287		
EA243672V4-580	287		
EA244272V4-580	287		
EA244872V4-580	287		
EA245472V4-580	287		
EA246072V4-580	287		
EA247272V4-580	287		
EMU183670V4-580	288		
EMU183678V4-580	288		
EMU184270V4-580	288		
EMU184278V4-580	288		
EMU184870V4-580	288		
EMU184878V4-580	288		
EMU185470V4-580	288		
EMU185478V4-580	288		
EMU186070V4-580	288		
EMU186078V4-580	288		
EMU213670V4-580	288		
EMU213678V4-580	288		
EMU214270V4-580	288		
EMU214278V4-580	288		
EMU214870V4-580	288		
EMU214878V4-580	288		
EMU215470V4-580	288		
EMU215478V4-580	288		
EMU216070V4-580	288		
EMU216078V4-580	288		
EMU243670V4-580	288		
EMU243678V4-580	288		
EMU244270V4-580	288		
EMU244278V4-580	288		
EMU244870V4-580	288		
EMU244878V4-580	288		
EMU245470V4-580	288		
EMU245478V4-580	288		
EMU246070V4-580	288		
EMU246078V4-580	288		
ESU182472V4-580	287		
ESU183072V4-580	287		
ESU183672V4-580	287		
ESU184272V4-580	287		
ESU184872V4-580	287		
ESU185472V4-580	287		
ESU186072V4-580	287		
ESU187272V4-580	287		
ESU212472V4-580	287		
ESU213072V4-580	287		
ESU213672V4-580	287		
ESU214272V4-580	287		
ESU214872V4-580	287		
ESU215472V4-580	287		
ESU216072V4-580	287		



Sia Huat Pte Ltd

(Corporate Office/Showroom/Warehouse)

No. 20 Pandan Road

Singapore 609272

T : +65 6268 3922

F : +65 6262 2796

enquiry@siahuat.com.sg

www.SiaHuat.com

(Retail Sales)

No. 7, 9 & 11 Temple Street

Singapore 058559

T : +65 6223 1732

F : +65 6223 4630

Hocatsu (M) Sdn Bhd

Wisma Sia Huat

No. 3A, Jalan 225, Seksyen 51A,

46100 Petaling Jaya, Selangor, Malaysia

T : +60 3 7958 6288

F : +60 3 7957 6288

enquiry@hocatsu.com.my

www.Hocatsu.com.my

PT Sia Huat Indonesia

Sahid Sudirman Centre, 56th floor

Jalan Jenderal Sudirman Kav. 86

Jakarta 10220, Indonesia

T : +62 21 8063 1820

F : +62 21 8063 1999

