

REACTOR™

312065H

ENG

Electric, Heated, Plural Component Proportioner
For spraying polyurethane foam and polyurea coatings. For professional use only.
Not for use in explosive atmospheres.



Important Safety Instructions

Read all warnings and instructions in this manual.
Save these instructions.

See page 3 for model information, including maximum working pressure and approvals.

Model E-XP1 Shown

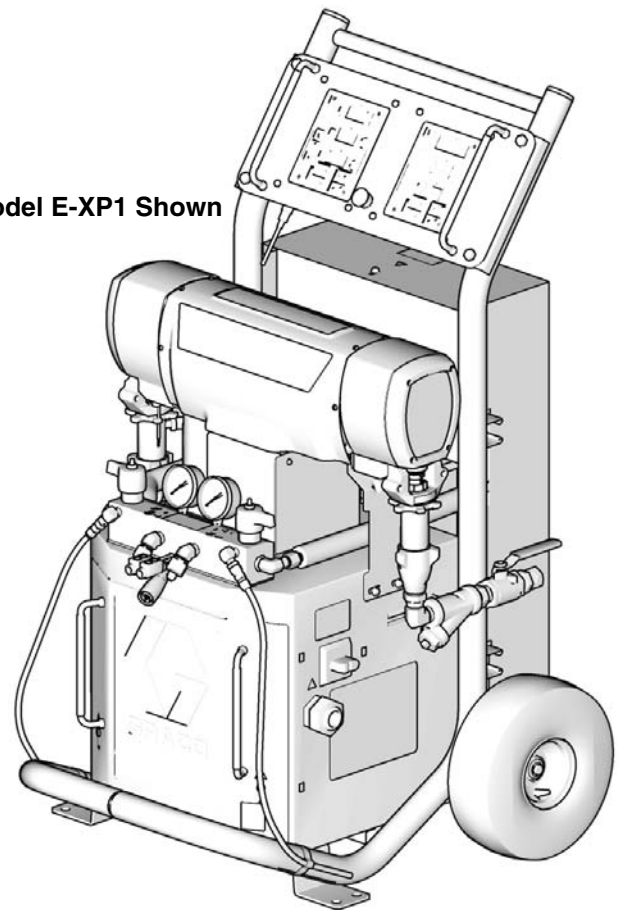

CE



9902471
Conforms to ANSI/UL
Std. 499 Certified to
CAN/CSA Std.
C22.2 No. 88

Taiwan Patent No. 1 303996
Australian Patent No. 2003291660
Other patents pending

T110953a

Contents

Models	3	Motor Controls and Indicators	15
Supplied Manuals	4	Motor ON/OFF Key/LED	15
Related Manuals	4	PARK Key/LED	15
Warnings	5	PSI/BAR Keys/LEDs	15
Important Two-Component Material Information .	8	Pressure Key/LED	15
Isocyanate Conditions	8	Cycle Count Key/LED	15
Material Self-ignition	8	Pressure Arrow Keys	16
Keep Components A and B Separate	8	Pressure/Cycle Display	16
Moisture Sensitivity of Isocyanates	8	Spray Adjustments	16
Foam Resins with 245 fa Blowing Agents	9	Setup	17
Changing Materials	9	Startup	23
Typical Installation, with circulation	10	Spraying	27
Typical Installation, without circulation	11	Shutdown	29
Component Identification	12	Pressure Relief Procedure	30
Temperature Controls and Indicators	13	Fluid Circulation	31
Main Power Switch	13	Circulation Through Reactor	31
Red Stop Button	13	Circulation Through Gun Manifold	32
Actual Temperature Key/LED	13	Jog Mode	33
Target Temperature Key/LED	13	Diagnostic Codes	34
Temperature Scale Keys/LEDs	14	Temperature Control Diagnostic Codes	34
Heater Zone On/Off Keys/LEDs	14	Motor Control Diagnostic Codes	34
Temperature Arrow Keys	14	Maintenance	35
Temperature Displays	14	Fluid Inlet Strainer Screen	35
Circuit Breakers	14	Pump Lubrication System	36
		Flushing	37
		Accessories	37
		Dimensions	38
		Technical Data	39
		Graco Standard Warranty	40
		Graco Information	40

Models

E-20 SERIES

Part, Series	Full Load Peak Amps*	Voltage (phase)	System Watts†	Primary Heater Watts	Max Flow Rate◆ lb/min (kg/min)	Approximate Output per Cycle (A+B) gal. (liter)	Maximum Fluid Working Pressure psi (MPa, bar)
259025, D	48	230V (1)	10,200	6,000	20 (9)	0.0104 (0.0395)	2000 (14, 140)
259030, D	24	400V (3)	10,200	6,000	20 (9)	0.0104 (0.0395)	2000 (14, 140)
259034, D	32	230V (3)	10,200	6,000	20 (9)	0.0104 (0.0395)	2000 (14, 140)

E-30 SERIES

Part, Series	Full Load Peak Amps*	Voltage (phase)	System Watts†	Primary Heater Watts	Max Flow Rate◆ lb/min (kg/min)	Approximate Output per Cycle (A+B) gal. (liter)	Maximum Fluid Working Pressure psi (MPa, bar)
259026, D	78	230V (1)	17,900	10,200	30 (13.5)	0.0272 (0.1034)	2000 (14, 140)
259031, D	34	400V (3)	17,900	10,200	30 (13.5)	0.0272 (0.1034)	2000 (14, 140)
259035, D	50	230V (3)	17,900	10,200	30 (13.5)	0.0272 (0.1034)	2000 (14, 140)
259057, D	100	230V (1)	23,000	15,300	30 (13.5)	0.0272 (0.1034)	2000 (14, 140)
259058, D	62	230V (3)	23,000	15,300	30 (13.5)	0.0272 (0.1034)	2000 (14, 140)
259059, D	35	400V (3)	23,000	15,300	30 (13.5)	0.0272 (0.1034)	2000 (14, 140)

E-XP1 SERIES

Part, Series	Full Load Peak Amps*	Voltage (phase)	System Watts†	Primary Heater Watts	Max Flow Rate◆ gpm (lpm)	Approximate Output per Cycle (A+B) gal. (liter)	Maximum Fluid Working Pressure psi (MPa, bar)
259024, D	69	230V (1)	15,800	10,200	1.0 (3.8)	0.0104 (0.0395)	2500 (17.2, 172)
259029, D	24	400V (3)	15,800	10,200	1.0 (3.8)	0.0104 (0.0395)	2500 (17.2, 172)
259033, D	43	230V (3)	15,800	10,200	1.0 (3.8)	0.0104 (0.0395)	2500 (17.2, 172)

E-XP2 SERIES

Part, Series	Full Load Peak Amps*	Voltage (phase)	System Watts†	Primary Heater Watts	Max Flow Rate◆ gpm (lpm)	Approximate Output per Cycle (A+B) gal. (liter)	Maximum Fluid Working Pressure psi (MPa, bar)
259028, D	100	230V (1)	23,000	15,300	2.0 (7.6)	0.0203 (0.0771)	3500 (24.1, 241)
259032, D	35	400V (3)	23,000	15,300	2.0 (7.6)	0.0203 (0.0771)	3500 (24.1, 241)
259036, D	62	230V (3)	23,000	15,300	2.0 (7.6)	0.0203 (0.0771)	3500 (24.1, 241)

* Full load amps with all devices operating at maximum capabilities. Fuse requirements at various flow rates and mix chamber sizes may be less.

† Total system watts, based on maximum hose length for each unit:

- E-20 and E-XP1 series, 210 ft (64 m) maximum heated hose length, including whip hose.
- E-30 and E-XP2 series, 310 ft (94.5 m) maximum heated hose length, including whip hose.

◆ Maximum flow rate given for 60 Hz operation. For 50 Hz operation, maximum flow rate is 5/6 of 60 Hz maximum flow.

Supplied Manuals

The following manuals are shipped with the Reactor™ Proportioner. Refer to these manuals for detailed equipment information.

Order Part 15M334 for a compact disk of Reactor manuals translated in several languages.

Manuals are also available at www.graco.com.

Reactor Hydraulic Proportioner	
Part	Description
312066	Reactor Electric Proportioner, Repair-Parts Manual (English)
Reactor Electrical Diagrams	
Part	Description
312067	Reactor Electric Proportioner, Electrical Diagrams (English)
Proportioning Pump	
Part	Description
309577	Electric Reactor Displacement Pump Repair-Parts Manual (English)

Related Manuals





The following manuals are for accessories used with the Reactor™.

Order Part 15M334 for a compact disk of Reactor manuals translated in several languages.

Reactor Data Reporting Kit	
Part	Description
309867	Instruction-Parts Manual (English)
Fusion Spray Gun	
Part	Description
309550	Instruction-Parts Manual (English)
Heated Hose	
Part	Description
309572	Instruction-Parts Manual (English)
Circulation and Return Tube Kit	
Part	Description
309852	Instruction-Parts Manual (English)
Rupture Disk Assembly Kit	
Part	Description
312416	Instruction-Parts Manual (English)
Electric Reactor Installation	
Part	Description
310815	Instruction Manual (English)

Warnings

The following warnings are for the setup, use, grounding, maintenance, and repair of this equipment. The exclamation point symbol alerts you to a general warning and the hazard symbol refers to procedure-specific risk. Refer back to these warnings. Additional, product-specific warnings may be found throughout the body of this manual where applicable.

 WARNING	
	<p>ELECTRIC SHOCK HAZARD</p> <p>This equipment must be grounded. Improper grounding, setup, or usage of the system can cause electric shock.</p> <ul style="list-style-type: none"> • Turn off and disconnect power at main switch before disconnecting any cables and before servicing equipment. • Connect only to grounded power source. • All electrical wiring must be done by a qualified electrician and comply with all local codes and regulations.
	<p>TOXIC FLUID OR FUMES HAZARD</p> <p>Toxic fluids or fumes can cause serious injury or death if splashed in the eyes or on skin, inhaled, or swallowed.</p> <ul style="list-style-type: none"> • Read MSDSs to know the specific hazards of the fluids you are using. • Store hazardous fluid in approved containers, and dispose of it according to applicable guidelines. • Always wear chemically impermeable gloves when spraying, dispensing, or cleaning equipment.
	<p>PERSONAL PROTECTIVE EQUIPMENT</p> <p>You must wear appropriate protective equipment when operating, servicing, or when in the operating area of the equipment to help protect you from serious injury, including eye injury, inhalation of toxic fumes, burns, and hearing loss. This equipment includes but is not limited to:</p> <ul style="list-style-type: none"> • Protective eyewear • Clothing and respirator as recommended by the fluid and solvent manufacturer • Gloves • Hearing protection
	<p>SKIN INJECTION HAZARD</p> <p>High-pressure fluid from gun, hose leaks, or ruptured components will pierce skin. This may look like just a cut, but it is a serious injury that can result in amputation. Get immediate surgical treatment.</p> <ul style="list-style-type: none"> • Do not point gun at anyone or at any part of the body. • Do not put your hand over the spray tip. • Do not stop or deflect leaks with your hand, body, glove, or rag. • Do not spray without tip guard and trigger guard installed. • Engage trigger lock when not spraying. • Follow Pressure Relief Procedure in this manual, when you stop spraying and before cleaning, checking, or servicing equipment.



WARNING



FIRE AND EXPLOSION HAZARD

Flammable fumes, such as solvent and paint fumes, in **work area** can ignite or explode. To help prevent fire and explosion:

- Use equipment only in well ventilated area.
- Eliminate all ignition sources; such as pilot lights, cigarettes, portable electric lamps, and plastic drop cloths (potential static arc).
- Keep work area free of debris, including solvent, rags and gasoline.
- Do not plug or unplug power cords, or turn power or light switches on or off when flammable fumes are present.
- Ground all equipment in the work area. See **Grounding** instructions.
- Use only grounded hoses.
- Hold gun firmly to side of grounded pail when triggering into pail.
- If there is static sparking or you feel a shock, **stop operation immediately**. Do not use equipment until you identify and correct the problem.
- Keep a working fire extinguisher in the work area.



PRESSURIZED ALUMINUM PARTS HAZARD

Use of fluids that are incompatible with aluminum in pressurized equipment can cause serious chemical reaction and equipment rupture. Failure to follow this warning can result in death, serious injury, or property damage.

- Do not use 1,1,1-trichloroethane, methylene chloride, other halogenated hydrocarbon solvents or fluids containing such solvents.
- Many other fluids may contain chemicals that can react with aluminum. Contact your material supplier for compatibility.



EQUIPMENT MISUSE HAZARD

Misuse can cause death or serious injury.

- This equipment is for professional use only.
- Do not leave the work area while equipment is energized or under pressure. Turn off all equipment and follow the **Pressure Relief Procedure** in this manual when equipment is not in use.
- Do not operate the unit when fatigued or under the influence of drugs or alcohol.
- Do not exceed the maximum working pressure or temperature rating of the lowest rated system component. See **Technical Data** in all equipment manuals.
- Use fluids and solvents that are compatible with equipment wetted parts. See **Technical Data** in all equipment manuals. Read fluid and solvent manufacturer's warnings. For complete information about your material, request MSDS forms from distributor or retailer.
- Check equipment daily. Repair or replace worn or damaged parts immediately with genuine manufacturer's replacement parts only.
- Do not alter or modify equipment.
- Use equipment only for its intended purpose. Call your distributor for information.
- Route hoses and cables away from traffic areas, sharp edges, moving parts, and hot surfaces.
- Do not kink or over bend hoses or use hoses to pull equipment.
- Keep children and animals away from work area.
- Comply with all applicable safety regulations.

**WARNING****MOVING PARTS HAZARD**

Moving parts can pinch or amputate fingers and other body parts.

- Keep clear of moving parts.
- Do not operate equipment with protective guards or covers removed.
- Pressurized equipment can start without warning. Before checking, moving, or servicing equipment, follow the **Pressure Relief Procedure** in this manual. Disconnect power or air supply.

**BURN HAZARD**

Equipment surfaces and fluid that's heated can become very hot during operation. To avoid severe burns, do not touch hot fluid or equipment. Wait until equipment/fluid has cooled completely.

Important Two-Component Material Information

Isocyanate Conditions



Spraying or dispensing materials containing isocyanates creates potentially harmful mists, vapors, and atomized particulates.

Read material manufacturer's warnings and material MSDS to know specific hazards and precautions related to isocyanates.

Prevent inhalation of isocyanate mists, vapors, and atomized particulates by providing sufficient ventilation in the work area. If sufficient ventilation is not available, a supplied-air respirator is required for everyone in the work area.

To prevent contact with isocyanates, appropriate personal protective equipment, including chemically impermeable gloves, boots, aprons, and goggles, is also required for everyone in the work area.

Keep Components A and B Separate

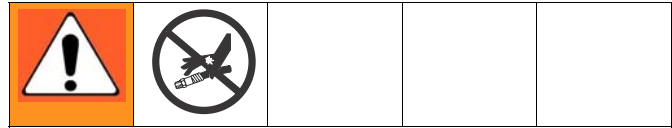

Cross-contamination can result in cured material in fluid lines which could cause serious injury or damage equipment. To prevent cross-contamination of the equipment's wetted parts, **never** interchange component A (isocyanate) and component B (resin) parts.

Moisture Sensitivity of Isocyanates

Isocyanates (ISO) are catalysts used in two component foam and polyurea coatings. ISO will react with moisture (such as humidity) to form small, hard, abrasive crystals, which become suspended in the fluid. Eventually a film will form on the surface and the ISO will begin to gel, increasing in viscosity. If used, this partially cured ISO will reduce performance and the life of all wetted parts.

 The amount of film formation and rate of crystallization varies depending on the blend of ISO, the humidity, and the temperature.

To prevent exposing ISO to moisture:

- Always use a sealed container with a desiccant dryer in the vent, or a nitrogen atmosphere. **Never** store ISO in an open container.
- Keep the ISO lube pump reservoir (if installed) filled with Graco Throat Seal Liquid (TSL), Part 206995. The lubricant creates a barrier between the ISO and the atmosphere.
- Use moisture-proof hoses specifically designed for ISO, such as those supplied with your system.
- Never use reclaimed solvents, which may contain moisture. Always keep solvent containers closed when not in use.
- Never use solvent on one side if it has been contaminated from the other side.
- Always lubricate threaded parts with ISO pump oil or grease when reassembling.

Material Self-ignition

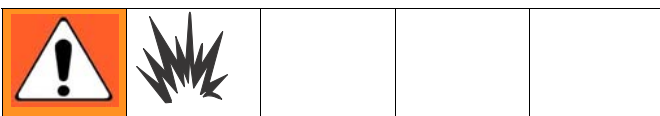

Some materials may become self-igniting if applied too thickly. Read material manufacturer's warnings and material MSDS.

Foam Resins with 245 fa Blowing Agents

Some foam blowing agents will froth at temperatures above 90°F (33°C) when not under pressure, especially if agitated. To reduce frothing, minimize preheating in a circulation system.

Changing Materials

- When changing materials, flush the equipment multiple times to ensure it is thoroughly clean.
- Always clean the fluid inlet strainers after flushing.
- Check with your material manufacturer for chemical compatibility.
- Most materials use ISO on the A side, but some use ISO on the B side.
- Epoxies often have amines on the B (hardener) side. Polyureas often have amines on the B (resin) side.

Typical Installation, with circulation

Key for FIG. 1

- | | | | |
|---|--------------------------------|---|----------------------------------|
| A | Reactor Proportioner | G | Feed Pump Air Supply Lines |
| B | Heated Hose | J | Fluid Supply Lines |
| C | Fluid Temperature Sensor (FTS) | K | Feed Pumps |
| D | Heated Whip Hose | L | Agitator |
| E | Fusion Spray Gun | M | Desiccant Dryer |
| F | Gun Air Supply Hose | P | Gun Fluid Manifold (part of gun) |
| | | R | Circulation Lines |

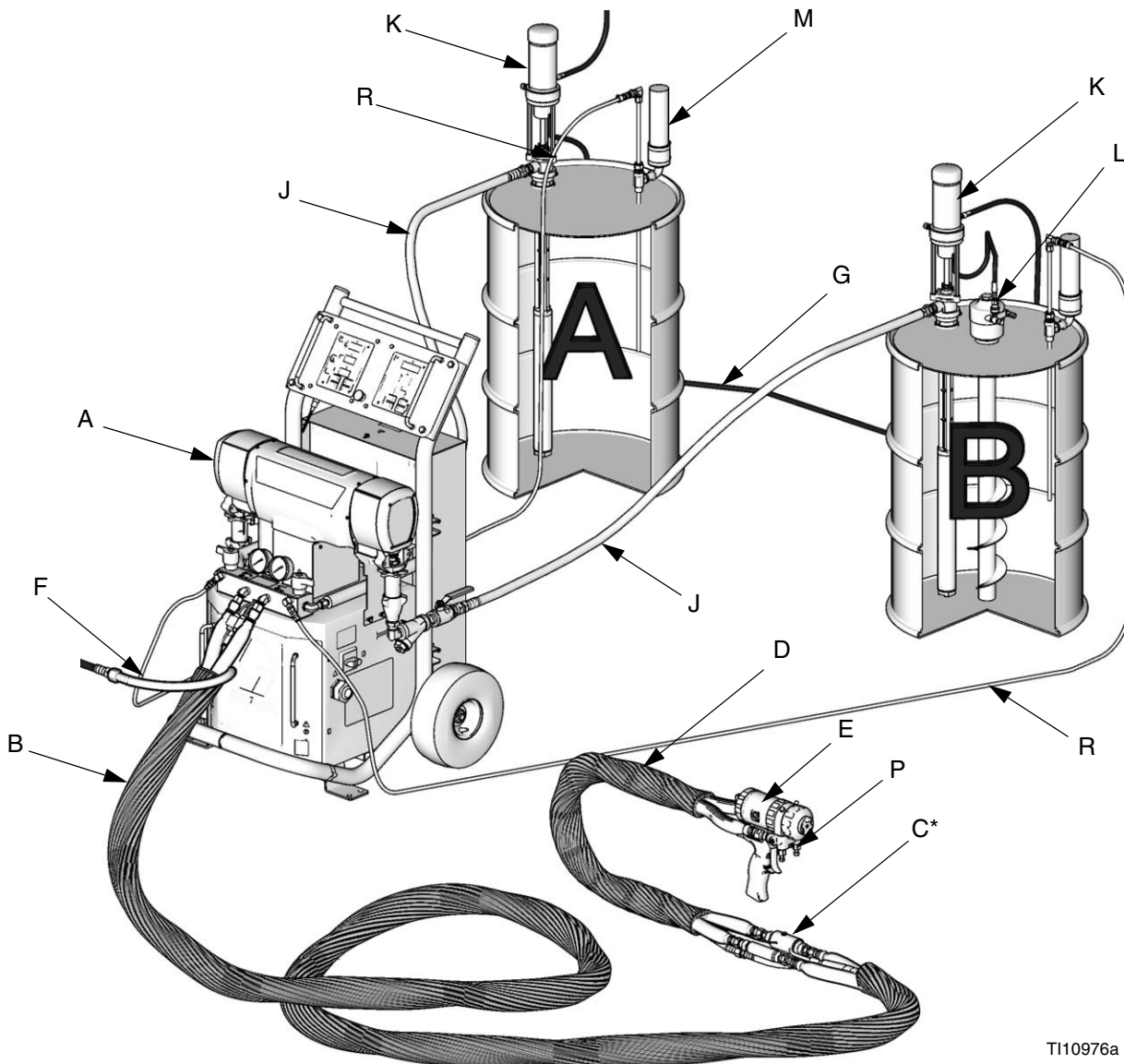

* Shown exposed for clarity. Wrap with tape during operation,

FIG. 1: Typical Installation, with circulation

Typical Installation, without circulation

Key for FIG. 2

- | | | | |
|---|--------------------------------|---|----------------------------------|
| A | Reactor Proportioner | H | Waste Containers |
| B | Heated Hose | J | Fluid Supply Lines |
| C | Fluid Temperature Sensor (FTS) | K | Feed Pumps |
| D | Heated Whip Hose | L | Agitator |
| E | Fusion Spray Gun | M | Desiccant Dryer |
| F | Gun Air Supply Hose | N | Bleed Lines |
| G | Feed Pump Air Supply Lines | P | Gun Fluid Manifold (part of gun) |
| | | Q | Air Filter/Separator |

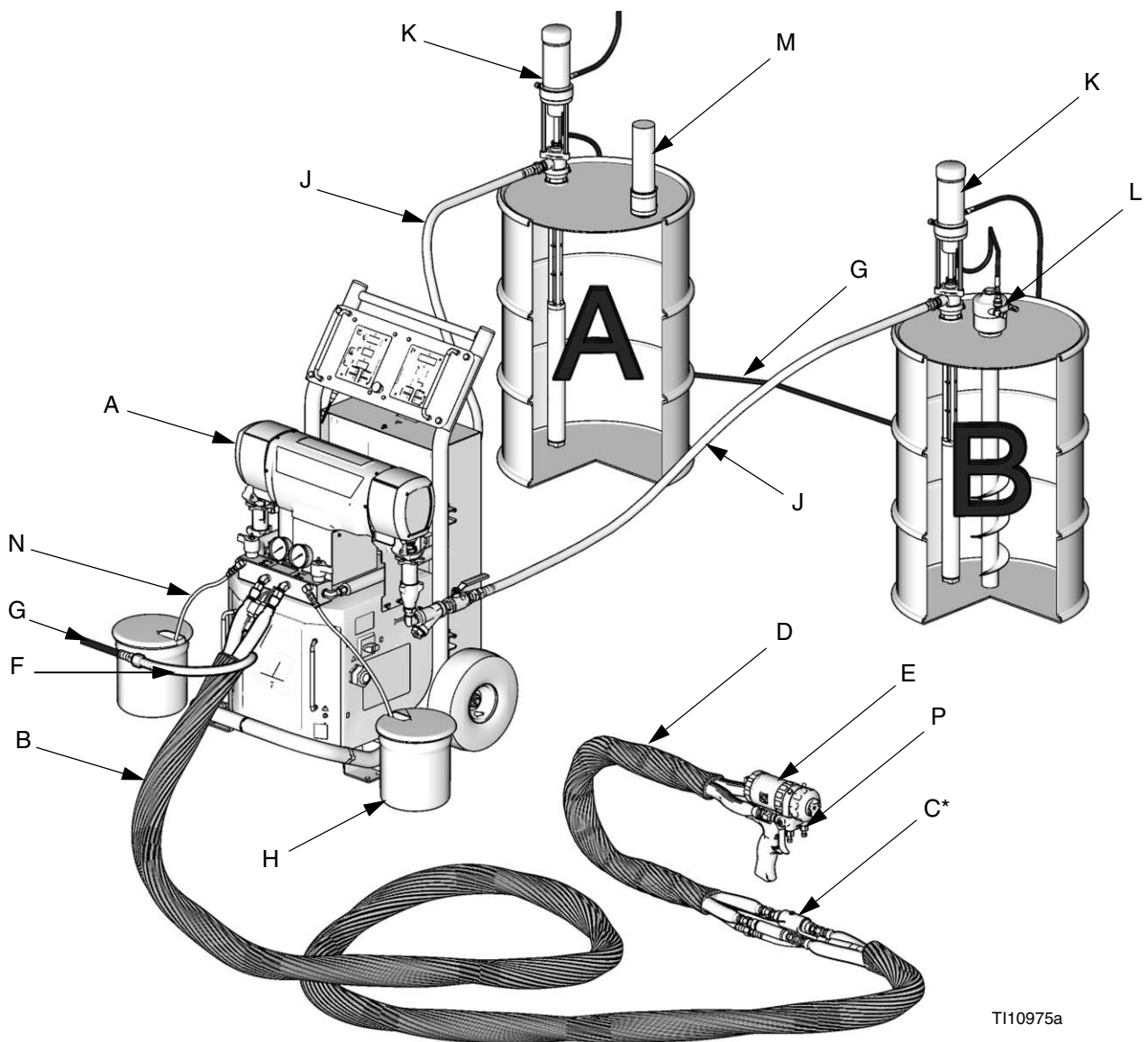

* Shown exposed for clarity. Wrap with tape during operation,

FIG. 2: Typical Installation, without circulation

Component Identification

Key for FIG. 3

- BA Component A Pressure Relief Outlet
- BB Component B Pressure Relief Outlet
- FA Component A Fluid Manifold Inlet (behind manifold block)
- FB Component B Fluid Manifold Inlet
- GA Component A Pressure Gauge
- GB Component B Pressure Gauge
- HA Component A Hose Connection
- HB Component B Hose Connection
- PA Component A Pump
- PB Component B Pump
- SA Component A PRESSURE RELIEF/SPRAY Valve
- SB Component B PRESSURE RELIEF/SPRAY Valve
- TA Component A Pressure Transducer (behind gauge GA)
- TB Component B Pressure Transducer (behind gauge GB)

- DG Drive Gear Housing
- EC Electrical Cord Strain Relief
- EM Electric Motor
- FH Fluid Heaters (behind shroud)
- FM Reactor Fluid Manifold
- FV Fluid Inlet Valve (B side shown)
- HC Heated Hose Electrical Connector
- MC Motor Control Display
- MP Main Power Switch
- RS Red Stop Button
- SC Fluid Temperature Sensor Cable
- SN Serial No. Plate
- TC Temperature Control Display

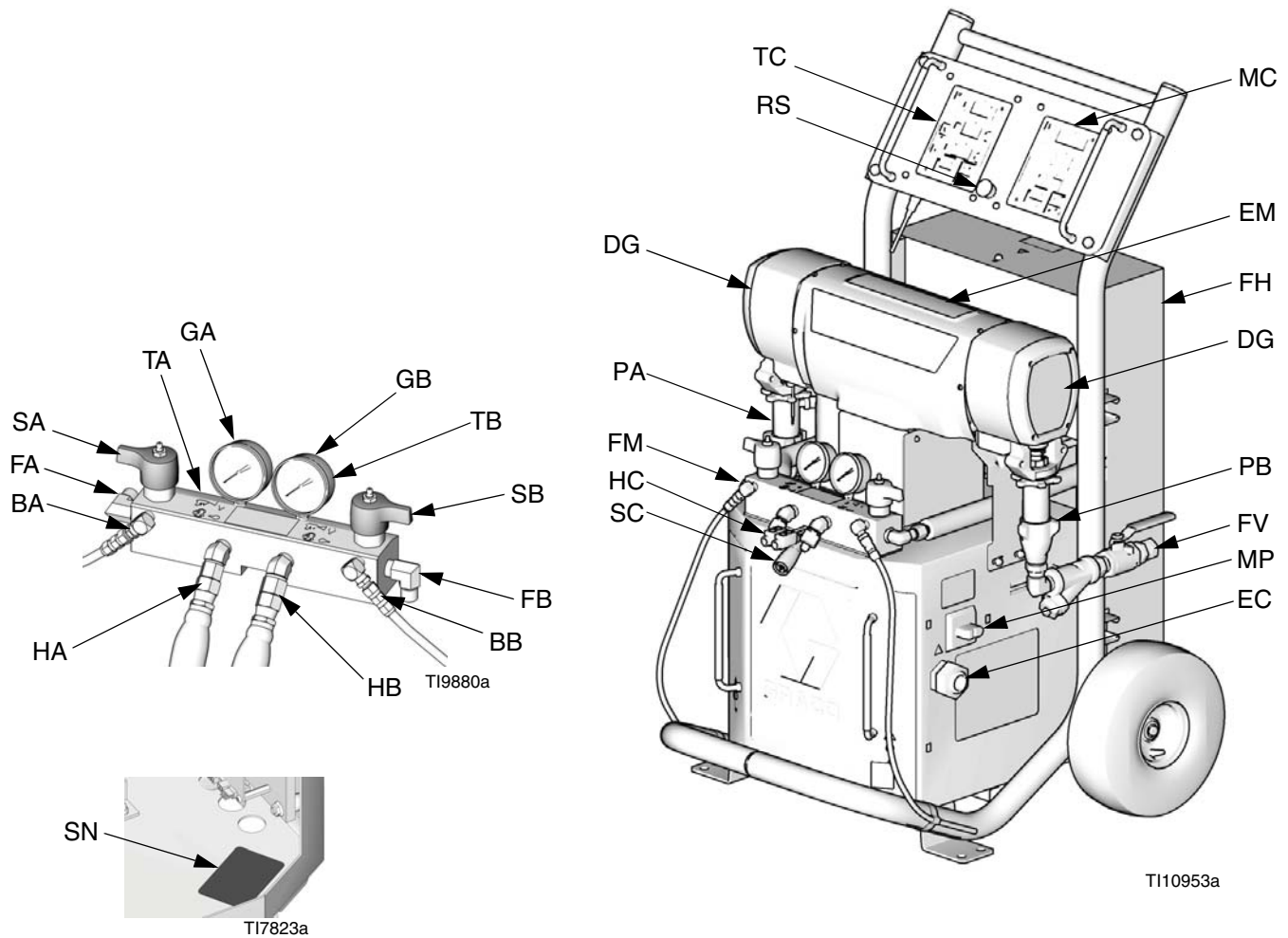

FIG. 3: Component Identification (Model EXP-1 Shown)

Temperature Controls and Indicators

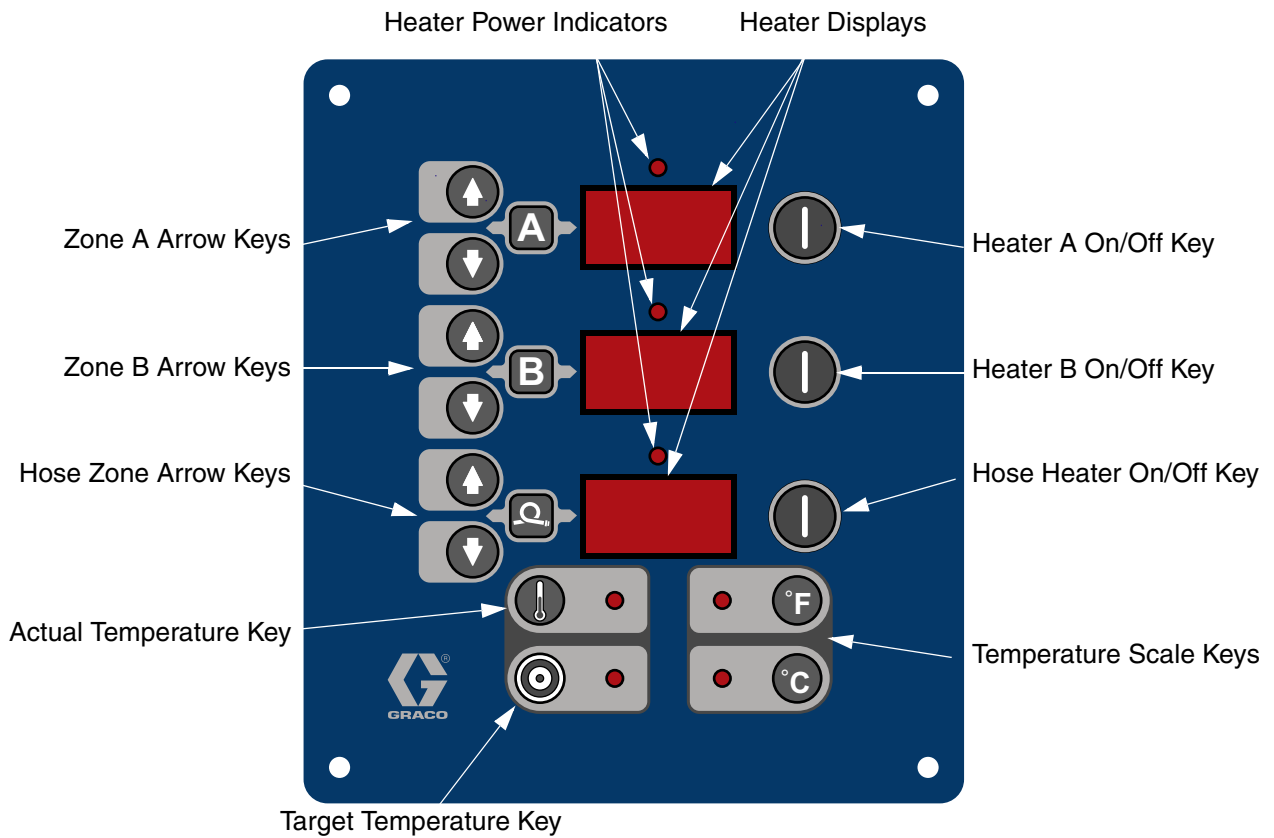

FIG. 4. Temperature Controls and Indicators

Main Power Switch

Located on right side of unit, page 12. Turns Reactor

power ON  and OFF . Does not turn heater zones or pumps on.

Red Stop Button

Located between temperature control panel and motor

control panel, page 12. Press  to shut off motor and heater zones only. Use main power switch to shut off all power to unit.

Actual Temperature Key/LED

Press  to display actual temperature.

Press and hold  to display electrical current.

Target Temperature Key/LED

Press  to display target temperature.

Press and hold  to display heater control circuit board temperature.

Temperature Scale Keys/LEDs

Press **°F** or **°C** to change temperature scale.

Heater Zone On/Off Keys/LEDs

Press **I** to turn heater zones on and off. Also clears heater zone diagnostic codes, see page 34.

 LEDs flash when heater zones are on. The duration of each flash shows the extent that the heater is turned on.

Temperature Arrow Keys

Press **⊙**, then press **↑** or **↓** to adjust temperature settings in 1 degree increments.

Temperature Displays

Show actual temperature or target temperature of heater zones, depending on selected mode. Defaults to actual at startup. Range is 32-190°F (0-88°C) for A and B, 32-180°F (0-82°C) for hose.

Circuit Breakers

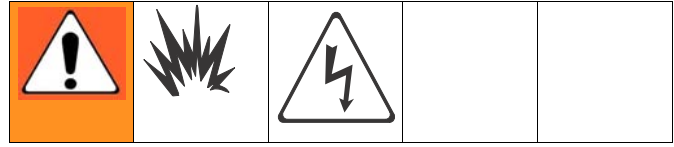

Located inside Reactor cabinet.

Ref.	Size	Component
CB1	50 A	Hose/Transformer Secondary
CB2	40 A	Transformer Primary
CB3	25, 40*	Heater A
CB4	25, 40*	Heater B
CB5	20	Motor/Pumps

* Depending on model.

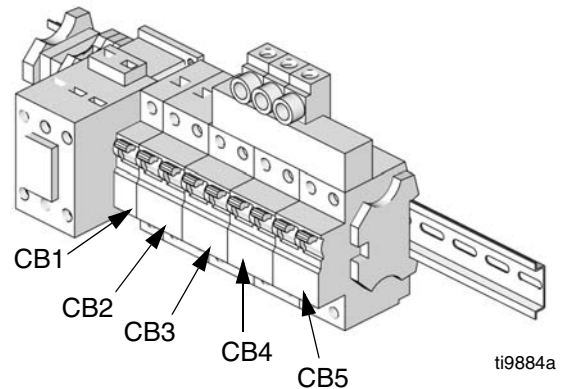

For wiring and cabling, see repair manual 312066.

Motor Controls and Indicators

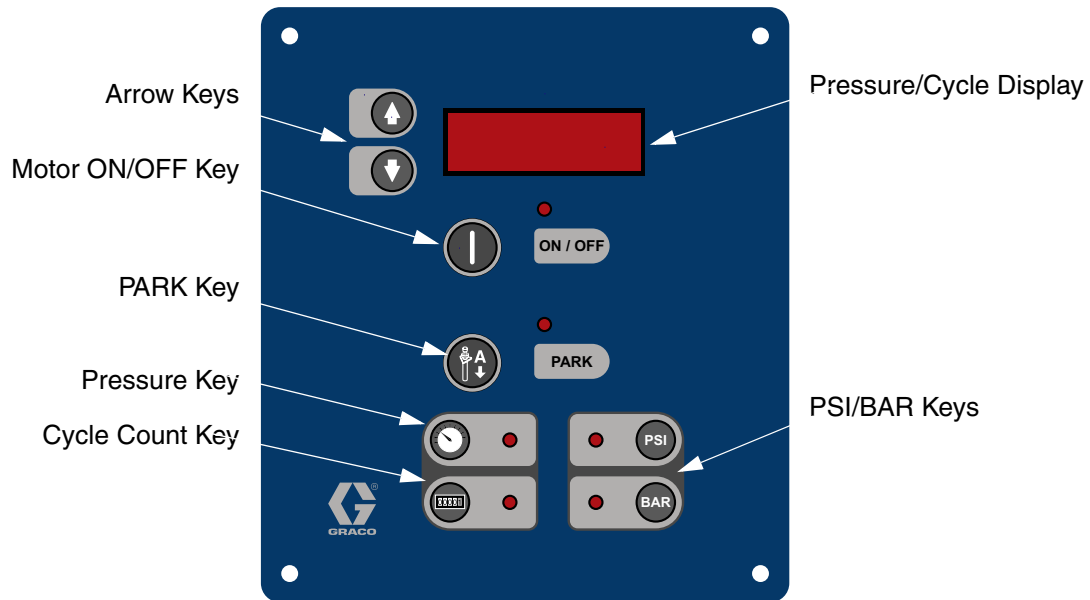



FIG. 5. Motor Controls and Indicators



Motor ON/OFF Key/LED

Press  to turn motor ON and OFF. Also clears some motor control diagnostic codes, see page 34.

PARK Key/LED

Press  at end of day to cycle component A pump to home position, submerging displacement rod. Trigger gun until pump stops. Once parked, motor will automatically shut off.

PSI/BAR Keys/LEDs

Press  or  to change pressure scale.



Pressure Key/LED

Press  to display fluid pressure.



 If pressures are imbalanced, display shows higher of two pressures.

Cycle Count Key/LED

Press  to display cycle count.

 To clear counter, press and hold  for 3 sec.

Pressure Arrow Keys

Press  or  to adjust fluid pressure when motor is ON. Setpoint displays for 10 sec.

When motor is OFF, pressing  will enter jog mode.

To exit jog mode, press  until display shows dashes or current pressure.

Pressure/Cycle Display

Shows fluid pressure or cycle count, depending on mode selected.

Displays J 1 through J 10 when in jog mode, page 33.

Spray Adjustments

Flow rate, atomization, and amount of overspray are affected by four variables.

- **Fluid pressure setting.** Too little pressure results in an uneven pattern, coarse droplet size, low flow, and poor mixing. Too much pressure results in excessive overspray, high flow rates, difficult control, and excessive wear.
- **Fluid temperature.** Similar effects to fluid pressure setting. The A and B temperatures can be offset to help balance the fluid pressure.
- **Mix chamber size.** Choice of mix chamber is based on desired flow rate and fluid viscosity.
- **Clean-off air adjustment.** Too little clean-off air results in droplets building up on the front of the nozzle, and no pattern containment to control overspray. Too much clean-off air results in air-assisted atomization and excessive overspray.

Setup

CAUTION

Proper system setup, start up, and shutdown procedures are critical to electrical equipment reliability. The following procedures ensure steady voltage. Failure to follow these procedures will cause voltage fluctuations that can damage electrical equipment and void the warranty.

1. Locate Reactor

- a. Locate Reactor on a level surface. See **Dimensions** page 38, for clearance and mounting hole dimensions.
- b. Do not expose Reactor to rain.

CAUTION

Bolt Reactor to original shipping pallet before lifting.

- c. Use the casters to move Reactor to a fixed location, or bolt to shipping pallet and move with forklift.
- d. To mount on a truck bed or trailer, remove casters and secure rear axle with 15B805 mobile mounting bracket (MB), available separately. Bolt bracket and mounting feet (MF) directly to truck or trailer bed. See page 38.

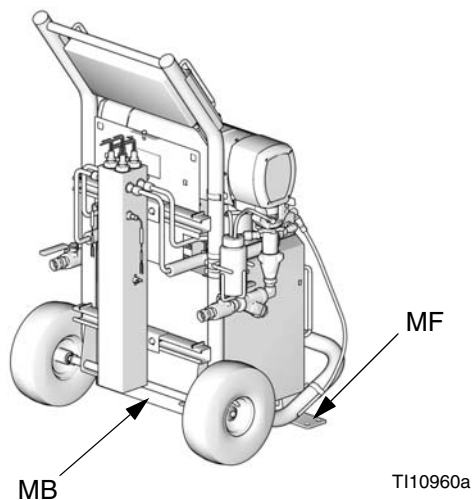

FIG. 6

2. General equipment guidelines

- Determine the correct size generator. Using the correct size generator and proper air compressor will enable the proportioner to run at a nearly constant RPM. Failure to do so will cause voltage fluctuations that can damage electrical equipment. Ensure the generator matches the voltage and phase of the proportioner.

Use the following procedure to determine the correct size generator.

- a. List system components that use peak load requirements in watts.
- b. Add the wattage required by the system components.
- c. Perform the following equation:
Total watts x 1.25 = kVA (kilovolt-amperes)
- d. Select a generator size that is equal to or greater than the determined kVA.

- Use proportioner power cords that meet or exceed the requirements listed in Table 2. Failure to do so will cause voltage fluctuations that can damage electrical equipment.
- Use an air compressor with constant speed head unloading devices. Direct online air compressors that start and stop during a job will cause voltage fluctuations that can damage electrical equipment.
- Maintain and inspect the generator, air compressor, and other equipment per the manufacturer recommendations to avoid an unexpected shutdown. Unexpected equipment shutdown will cause voltage fluctuations that can damage electrical equipment.
- Use a wall power supply with enough current to meet system requirements. Failure to do so will cause voltage fluctuations that can damage electrical equipment.

3. Electrical requirements

See TABLE 1.

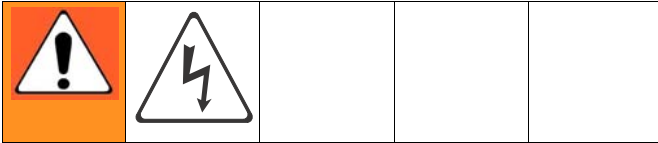

Installing this equipment requires access to parts which may cause electric shock or other serious injury if work is not performed properly. Have a qualified electrician connect power and ground to main power switch terminals, see page 19. Be sure your installation complies with all National, State and Local safety and fire codes.

**Table 1: Electrical Requirements
(kW/Full Load Amps)**

E SERIES				
Part No.	Model	Voltage (phase)	Full Load Peak Amps*	System Watts**
259025	E-20	230V (1)	48	10,200
249030	E-20	400V (3)	24	10,200
259034	E-20	230V (3)	32	10,200

**Table 1: Electrical Requirements
(kW/Full Load Amps)**

E SERIES				
259026	E-30	230V (1)	78	17,900
259031	E-30	400V (3)	34	17,900
259035	E-30	230V (3)	50	17,900
259057	E-30†	230V (1)	100	23,000
259058	E-30†	230V (3)	62	23,000
259059	E-30†	400V (3)	35	23,000
E-XP SERIES				
259024	E-XP1	230V (1)	69	15,800
259029	E-XP1	400V (3)	24	15,800
259033	E-XP1	230V (3)	43	15,800
259028	E-XP2	230V (1)	100	23,000
259032	E-XP2	400V (3)	35	23,000
259036	E-XP2	230V (3)	62	23,000

* Full load amps with all devices operating at maximum capabilities. Fuse requirements at various flow rates and mix chamber sizes may be less.

** E-20 and E-XP1 with 210 ft (64.1 m) hose; E-30 and E-XP2 with 310 ft (94.6 m) hose.

† E-30 with 15.3 kW of heat.

4. Connect electrical cord

 Power cord is not supplied. See Table 2.

Table 2: Power Cord Requirements

Part	Model	Cord Specification AWG (mm ²)
259024	E-XP1	4 (21.2), 2 wire + ground
259025	E-20	6 (13.3), 2 wire + ground
259026	E-30	4 (21.2), 2 wire + ground
259028	E-XP2	4 (21.2), 2 wire + ground
259029	E-XP1	10 (5.3), 4 wire + ground
259030	E-20	10 (5.3), 4 wire + ground
259031	E-30	8 (8.4), 4 wire + ground
259032	E-XP2	8 (8.4), 4 wire + ground
259033	E-XP1	8 (8.4), 3 wire + ground
259034	E-20	8 (8.4), 3 wire + ground
259035	E-30	6 (13.3), 3 wire + ground
259036	E-XP2	6 (13.3), 3 wire + ground
259057	E-30	4 (21.2), 2 wire + ground
259058	E-30	6 (13.3), 3 wire + ground
259059	E-30	8 (8.4), 4 wire + ground



- a. **230V, 1 phase:** Using 5/32 or 4 mm hex allen wrench, connect two power leads to L1 and L2. Connect green to ground (GND).

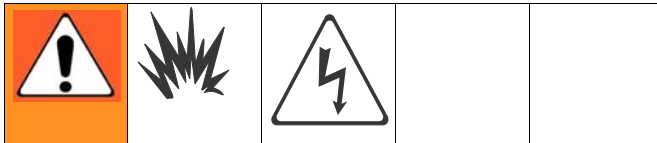
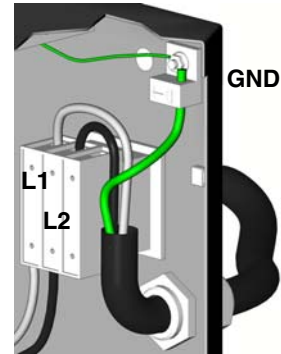

ti2515b

- b. **230V, 3 phase:** Using 5/32 or 4 mm hex allen wrench, connect three power leads to L1, L2, and L3. Connect green to ground (GND).

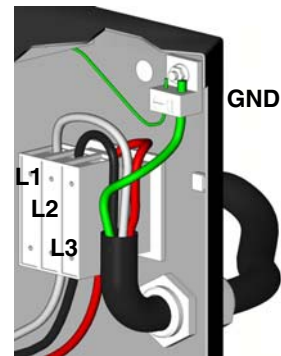

ti3248b

- c. **400V, 3 phase:** Using 5/32 or 4 mm hex allen wrench, connect three power leads to L1, L2, and L3. Connect neutral to N. Connect green to ground (GND).

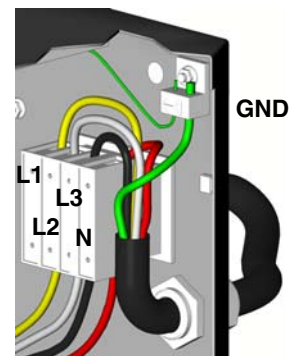

ti2725a

5. Connect feed pumps

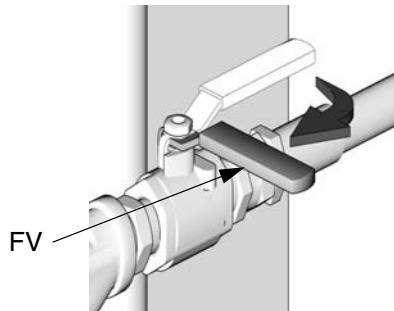

- Install feed pumps (K) in component A and B supply drums. See FIG. 1 and FIG. 2, pages 10 and 11.
- Seal component A drum and use desiccant dryer (M) in vent.
- Install agitator (L) in component B drum, if necessary.
- Ensure A and B inlet valves (FV) are closed.



T110971a

 Supply hoses from feed pumps should be 3/4 in. (19 mm) ID.

6. Connect pressure relief lines

				
<p>Do not install shutoffs downstream of the PRESSURE RELIEF/SPRAY valve outlets (BA, BB). The valves function as overpressure relief valves when set to SPRAY . Lines must be open so valves can automatically relieve pressure when machine is operating.</p> <p>If circulating fluid back to the supply drums, use high pressure hose rated to withstand the maximum working pressure of this equipment.</p>				

- Recommended: Connect high pressure hose (R) to relief fittings (BA, BB) of both PRESSURE RELIEF/SPRAY valves, Route hose back to component A and B drums. See FIG. 1, page 10.

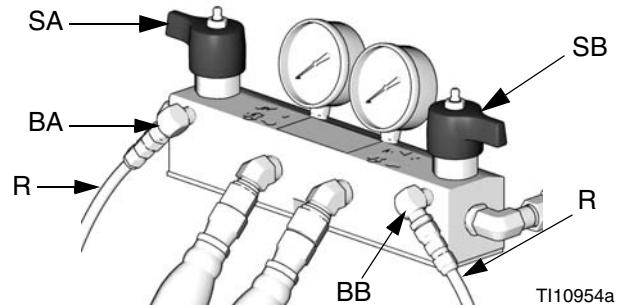

- Alternately:** Secure supplied bleed tubes (N) in grounded, sealed waste containers (H). See FIG. 2, page 11.

7. Install Fluid Temperature Sensor (FTS)

The Fluid Temperature Sensor (FTS) is supplied. Install FTS between main hose and whip hose. See Heated Hose manual 309572 for instructions.

8. Connect heated hose

 See Heated Hose manual 309572 for detailed instructions on connecting heated hoses.

CAUTION

The fluid temperature sensor (C) and whip hose (D) must be used with heated hose, see page 20. Hose length, including whip hose, must be 60 ft (18.3 m) minimum.

- Turn main power OFF .
- Assemble heated hose sections, FTS, and whip hose.

- c. Connect A and B hoses to A and B outlets on Reactor fluid manifold (FM). Hoses are color coded: red for component A (ISO), blue for component B (RES). Fittings are sized to prevent connection errors.

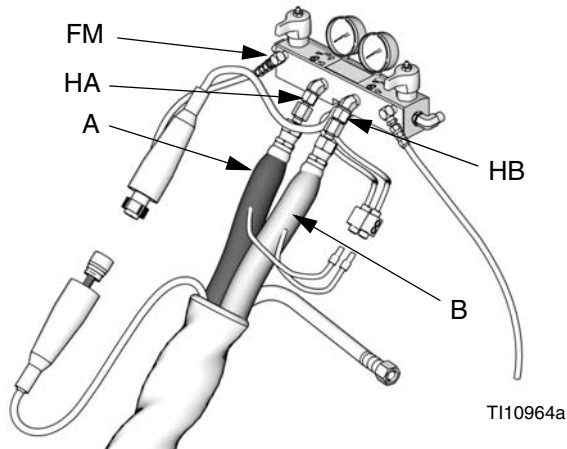

Manifold hose adapters (HA, HB) allow use of 1/4 in. and 3/8 in. ID fluid hoses. To use 1/2 in. (13 mm) ID fluid hoses, remove adapters from fluid manifold and install as needed to connect whip hose.

- d. Connect cables (Y). Connect electrical connectors (V). Be sure cables have slack when hose bends. Wrap cable and electrical connections with electrical tape.

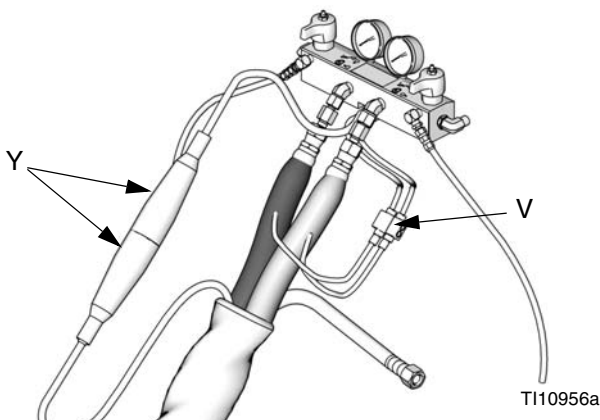

9. Close gun fluid manifold valves A and B

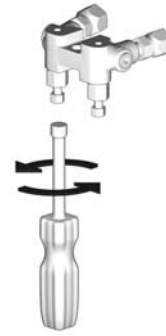

ti2411a

10. Connect whip hose to gun fluid manifold

Do not connect manifold to gun.

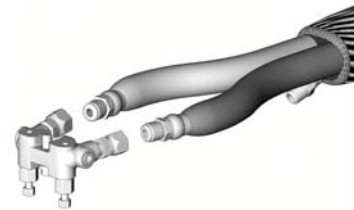

ti2417a

11. Pressure check hose

See hose manual. Pressure check for leaks. If no leaks, wrap hose and electrical connections to protect from damage.

12. Ground system

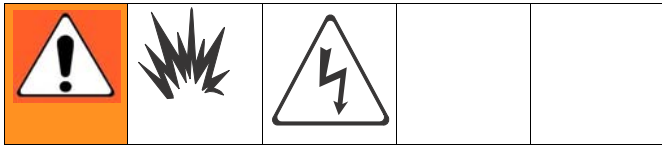

- Reactor*: is grounded through power cord. See page 19.
- Spray gun*: connect whip hose ground wire to FTS, page 20. Do not disconnect wire or spray without whip hose.
- Fluid supply containers*: follow your local code.
- Object being sprayed*: follow your local code.
- Solvent pails used when flushing*: follow your local code. Use only metal pails, which are conductive, placed on a grounded surface. Do not place pail on a nonconductive surface, such as paper or cardboard, which interrupts grounding continuity
- To maintain grounding continuity when flushing or relieving pressure*, hold a metal part of spray gun firmly to the side of a grounded *metal* pail, then trigger gun.

13. Supply wet cups with Throat Seal Liquid (TSL)

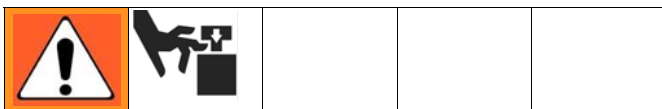

Pump rod and connecting rod move during operation. Moving parts can cause serious injury such as pinching or amputation. Keep hands and fingers away from wet-cup during operation. Turn main power OFF



before filling wet cup.

- Component A (ISO) Pump**: Keep reservoir (R) filled with Graco Throat Seal Liquid (TSL), Part 206995. Wet-cup piston circulates TSL through wet-cup, to carry away isocyanate film on displacement rod.

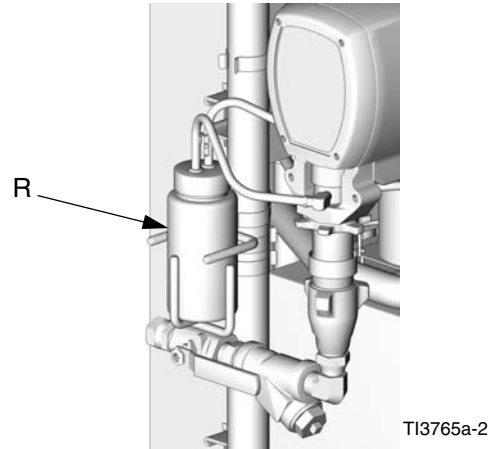

FIG. 7

- Component B (Resin) Pump**: Check felt washers in packing nut/wet-cup (S) daily. Keep saturated with Graco Throat Seal Liquid (TSL), Part No. 206995, to prevent material from hardening on displacement rod. Replace felt washers when worn or contaminated with hardened material.

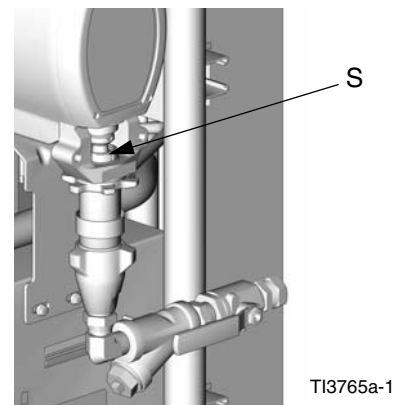
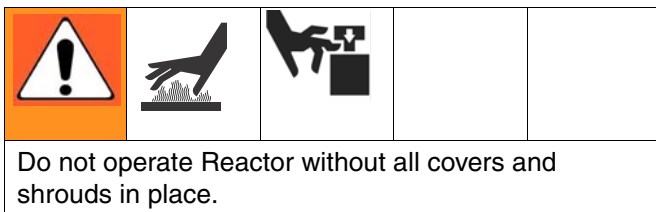

FIG. 8

Startup

CAUTION

Proper system setup, startup, and shutdown procedures are critical to electrical equipment reliability. The following procedures ensure steady voltage. Failure to follow these procedures will cause voltage fluctuations that can damage electrical equipment and void the warranty.



1. Check generator fuel level.

Running out of fuel will cause voltage fluctuations that can damage electrical equipment.

2. Ensure the main breaker on the generator is in the off position.

3. Start the generator. Allow it to reach full operating temperature.

4. Close the bleed valve on the air compressor.

5. Switch on the air compressor starter and air dryer, if included.

6. Turn on power to the Reactor.

7. Load fluid with feed pumps



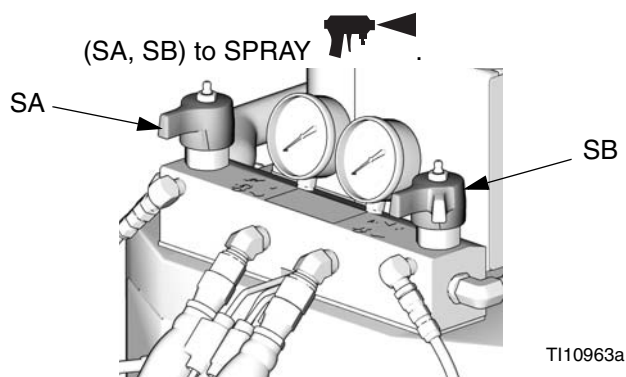

 The Reactor is tested with oil at the factory. Flush out the oil with a compatible solvent before spraying. See page 37.

- Check that all **Setup** steps are complete.
- Check that inlet screens are clean before daily startup, page 35.
- Check level and condition of ISO lube daily, page 35.
- Turn on component B agitator, if used.
- Turn both PRESSURE RELIEF/SPRAY valves (SA, SB) to SPRAY

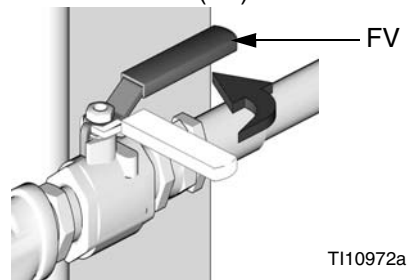

- Start feed pumps.
- Open fluid inlet valves (FV). Check for leaks.



				
<p>Do not mix components A and B during startup. Always provide two grounded waste containers to keep component A and component B fluids separate.</p>				

- h. Use feed pumps to load system. Hold gun fluid manifold over two grounded waste containers. Open fluid valves A and B until clean, air-free fluid comes from valves. Close valves.

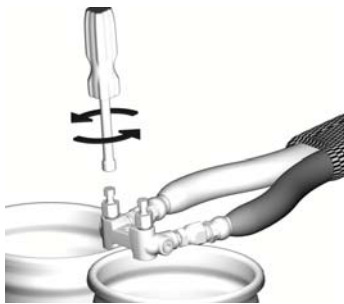

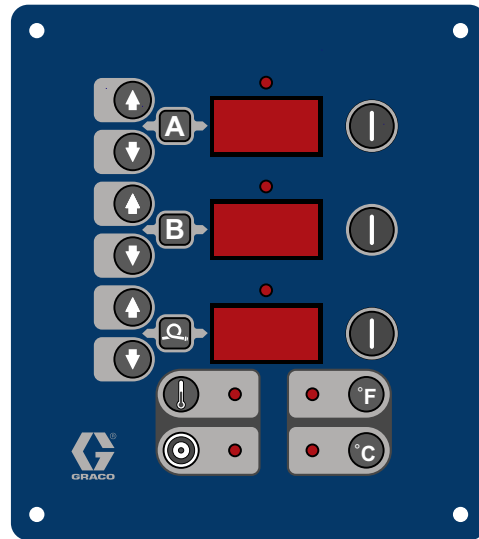

ti2484a

8. Set temperatures







Temperature Controls and Indicators, see page 13



				
<p>This equipment is used with heated fluid, which can cause equipment surfaces to become very hot. To avoid severe burns:</p> <ul style="list-style-type: none"> • Do not touch hot fluid or equipment. • Allow equipment to cool completely before touching it. • Wear gloves if fluid temperature exceeds 110°F (43°C). 				

- a. Turn main power ON .



- b. Press  or  to change temperature scale.



- c. Press .



- d. To set **A** heat zone target temperature, press  or  until display shows desired temperature. Repeat for **B** and  zones.

 For  zone only, if FTS is disconnected at startup, display will show hose current (0A). See step j, page 25.

- e. Press  to display actual temperatures.

				
Do not turn on hose heat without fluid in hoses.				

- f. Turn on  heat zone by pressing . Preheat hose (15-60 min). Indicator will flash very slowly when fluid reaches target temperature. Display shows actual fluid temperature in hose near FTS.



				
Thermal expansion can cause overpressurization, resulting in equipment rupture and serious injury, including fluid injection. Do not pressurize system when preheating hose.				

- g. Turn on **A** and **B** heat zones by pressing  for each zone.



- h. Hold  to view electrical currents for each zone.

- i. Hold  to view heater control circuit board temperature.

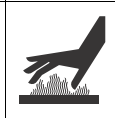
- j. **Manual current control mode only:**

				
When in manual current control mode, monitor hose temperature with thermometer. Install per instructions below. Thermometer reading must not exceed 160°F (71°C). Never leave machine unattended when in manual current control mode.				

If FTS is disconnected or display shows diagnostic code E04, turn main power switch OFF





 then ON  to clear diagnostic code and enter manual current control mode.

 display will show current to hose. Current is not limited by target temperature.

To prevent overheating, install hose thermometer close to gun end, within operator view. Insert thermometer through foam cover of A component hose so stem is next to inner tube. Thermometer reading will be about 20°F less than actual fluid temperature.

If thermometer reading exceeds 160°F (71°C), reduce current with  key.

9. Set pressure

- a. Press  .
- b. Press motor  . Motor and pumps start.
Display shows system pressure. Motor runs until setpoint is reached.
- c. Press  or  until display shows desired fluid pressure. Display will show setpoint for 10 seconds, then change to actual pressure.

 If display pressure is greater than setpoint pressure, trigger gun to reduce pressure.

 If display shows J xx, unit is in jog mode. To exit jog mode, see page 33.

- d. To display cycle count, press  .

 To clear counter, press  and hold for 3 seconds.

- e. Press  or  to change pressure scale.

Spraying



1. Engage gun piston safety lock.



ti2409a

2. Close gun fluid manifold valves A and B.

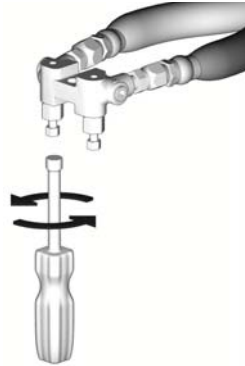

ti2728a

3. Attach gun fluid manifold. Connect gun air line. Open air line valve.

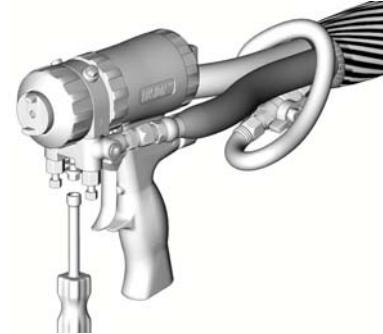

ti2543a

4. Set PRESSURE RELIEF/SPRAY valves (SA, SB) to SPRAY

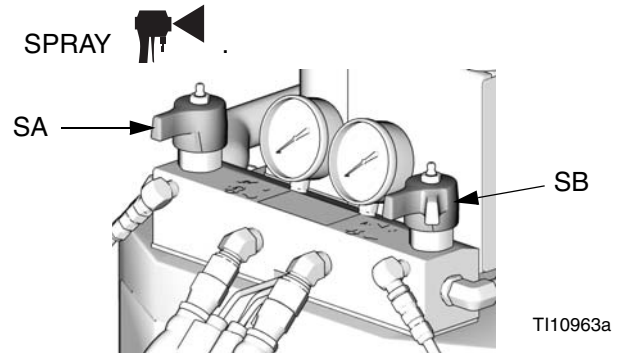

TI10963a

5. Check that heat zones are on and temperatures are on target, page 24.
6. Press motor  to start motor and pumps.
7. Check fluid pressure display and adjust as necessary, page 27.

8. Check fluid pressure gauges (GA, GB) to ensure proper pressure balance. If imbalanced, reduce pressure of higher component by **slightly** turning PRESSURE RELIEF/SPRAY valve for that component toward PRESSURE RELIEF/CIRCULATION



, until gauges show balanced pressures.

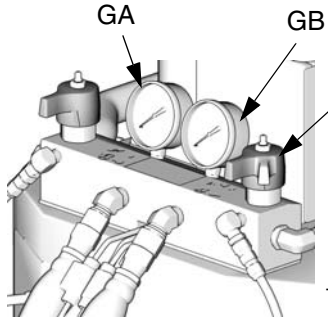

In this example, B side pressure is higher, so use the B side valve to balance pressures.

TI10963a

9. Open gun fluid manifold valves A and B.

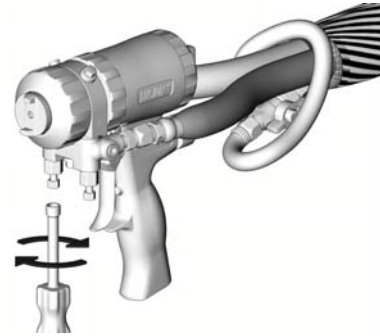

ti2414a

 On impingement guns, **never** open fluid manifold valves or trigger gun if pressures are imbalanced.

10. Disengage gun piston safety lock.



ti2410a

11. Test spray onto cardboard. Adjust pressure and temperature to get desired results.
12. Equipment is ready to spray.

 If you stop spraying for a period of time, the unit will enter standby (if enabled). See page 29.

Shutdown

CAUTION
<p>Proper system setup, startup, and shutdown procedures are critical to electrical equipment reliability. The following procedures ensure steady voltage. Failure to follow these procedures will cause voltage fluctuations that can damage electrical equipment and void the warranty.</p>

1. Shut off **A** , **B** , and **P** heat zones.

2. Park pumps.

a. Press  .

b. Trigger gun until pump A stops in the retracted position and the pressure of both pumps bleeds down.

3. Turn main power OFF  .

4. Relieve pressure, page 30.
5. Turn off the air compressor and air dryer, if included.
6. Open air compressor bleed valve to relieve pressure and remove water from tank.
7. Turn off the main breaker on the generator.
8. Allow generator dwell time, per manufacturer recommendations, prior to shutdown.
9. Close both fluid supply valves (FV).

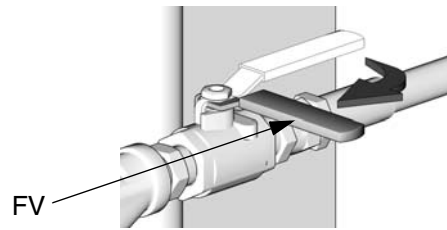

ti10971a

10. Shut down feed pumps as required.

Pressure Relief Procedure

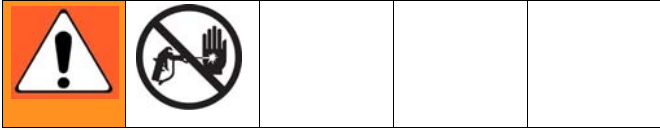

1. Relieve pressure in gun and perform gun shutdown procedure. See gun manual.
2. Close gun fluid manifold valves A and B.

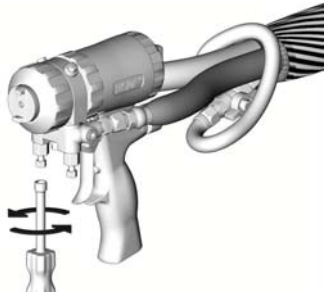

ti2421a

3. Shut off feed pumps and agitator, if used.
4. Turn PRESSURE RELIEF/SPRAY valves (SA, SB)

to PRESSURE RELIEF/CIRCULATION . Route

fluid to waste containers or supply tanks. Ensure gauges drop to 0.

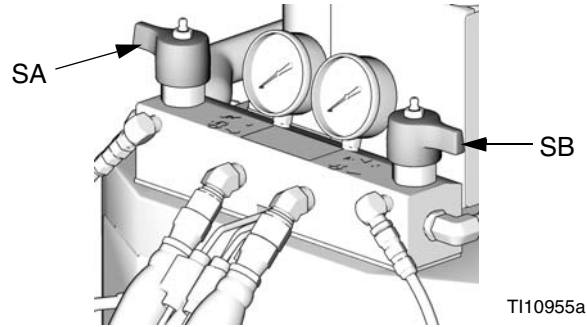

T110955a

5. Engage gun piston safety lock.



ti2409a

6. Disconnect gun air line and remove gun fluid manifold.

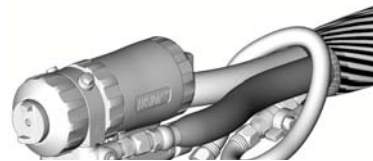

Fluid Circulation

Circulation Through Reactor

Do not circulate fluid containing a blowing agent without consulting with your material supplier regarding fluid temperature limits.				

To circulate through gun manifold and preheat hose, see page 32.

1. **Check generator fuel level. Running out of fuel will cause voltage fluctuations that can damage electrical equipment.**, page 23.

Do not install shutoffs downstream of the PRESSURE RELIEF/SPRAY valve outlets (BA, BB). The valves function as overpressure relief valves when set to SPRAY . Lines must be open so valves can automatically relieve pressure when machine is operating.				

2. See **Typical Installation, with circulation**, page 10. Route circulation lines back to respective component A or B supply drum. Use hoses rated at the maximum working pressure of this equipment. See **Technical Data**, page 39.

3. Set PRESSURE RELIEF/SPRAY valves (SA, SB) to

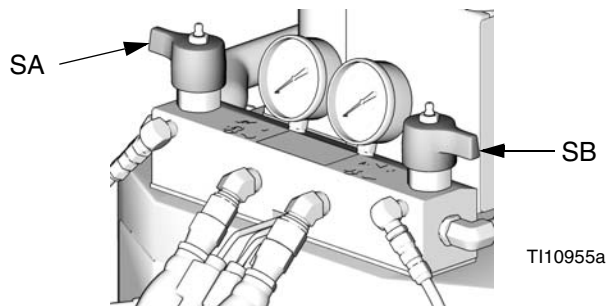

PRESSURE RELIEF/CIRCULATION

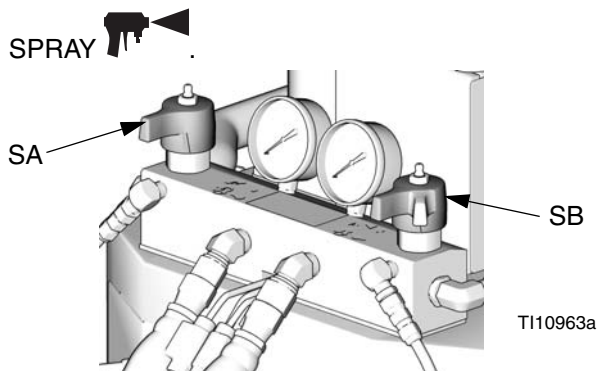

4. Turn main power ON
5. Set temperature targets, see page 24. Turn on **A** and **B** heat zones by pressing
- Do not** turn on heat zone unless hoses are already loaded with fluid.
6. Press to display actual temperatures.
7. Circulate fluid in jog mode until **A** and **B** temperatures reach targets.
8. Turn on heat zone by pressing .
9. Set PRESSURE RELIEF/SPRAY valves (SA, SB) to SPRAY .



Circulation Through Gun Manifold

				
Do not circulate fluid containing a blowing agent without consulting with your material supplier regarding fluid temperature limits.				

Circulating fluid through the gun manifold allows rapid preheating of hose.



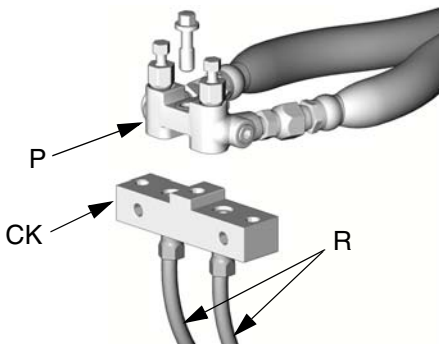





1. Install gun fluid manifold (P) on Part 246362 accessory circulation kit (CK). Connect high pressure circulation lines (R) to circulation manifold.



ti2767a

2. Route circulation lines back to respective component A or B supply drum. Use hoses rated at the maximum working pressure of this equipment. See **Typical Installation, without circulation**, page 11.
3. Follow **Check generator fuel level. Running out of fuel will cause voltage fluctuations that can damage electrical equipment.**, page 24.



4. Turn main power ON .
5. Set temperature targets, see page 24. Turn on , , and  heat zones by pressing .
6. Press  to display actual temperatures.
7. Circulate fluid in jog mode until  and  temperatures reach targets.

Jog Mode

Jog mode has two purposes:

- It can speed fluid heating during circulation.
- It can ease pump repair/replacement. See repair manual.

1. Turn main power on .





2. Ensure motor  is OFF (LED is off; display may show dashes or pressure).

3. Press  to select J1 (jog speed 1).

4. Press motor  to start motor.

5. Press  or  to change job speed (J1 through J10).

 Jog speeds correlate to 3-30% of motor power, but will not operate over 700 psi (4.9 MPa, 49 bar) for either A or B.

6. To exit jog mode, press  until display shows dashes or current pressure.

Diagnostic Codes

Temperature Control Diagnostic Codes

Temperature control diagnostic codes appear on temperature display.

These alarms turn off heat. E99 clears automatically when communication is regained. Codes E03 through

E06 can be cleared by pressing . For other codes,

turn main power OFF  then ON  to clear.

See repair manual for corrective action.

Code	Code Name	Alarm Zone
01	High fluid temperature	Individual
02	High current	Individual
03	No current	Individual
04	FTS not connected	Individual
05	Board overtemperature	Individual
06	Loss of zone communication	Individual
30	Momentary loss of communication	All
99	Loss of display communication	All

 For hose zone only, if FTS is disconnected at startup, display will show hose current 0A.

Motor Control Diagnostic Codes

Motor control diagnostic codes E21 through E29 appear on pressure display.



There are two types of motor control codes: alarms and warnings. Alarms take priority over warnings.

See repair manual for corrective action.

Alarms



Alarms turn off Reactor. Turn main power OFF 

then ON  to clear.

 Alarms can also be cleared, except for code 23, by pressing .

Warnings

Reactor will continue to run. Press  to clear. A warning will not recur for a predetermined amount of time (varies for different warnings), or until main power

is turned OFF  then ON .

Code No.	Code Name	Alarm or Warning
21	No transducer (component A)	Alarm
22	No transducer (component B)	Alarm
23	High pressure	Alarm
24	Pressure imbalance	Selectable; see repair manual
25	High line voltage	Alarm
26	Low line voltage	Alarm
27	High motor temperature	Alarm
28	High current	Alarm
29	Brush wear	Warning

Maintenance

- Check wet cup TSL level daily.
- Do not overtighten packing nut/wet cup. Throat u-cup is not adjustable.
- Inspect fluid inlet strainer screens daily, see below.
- Grease circulation valves weekly with Fusion grease (117773).

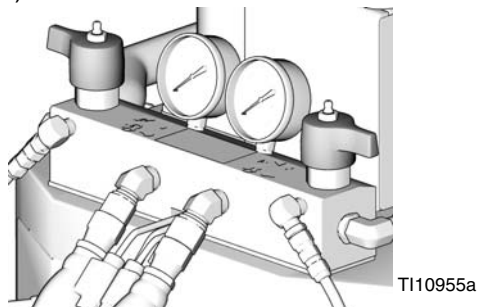

- Inspect ISO lubricant level and condition daily, see page 36. Refill or replace as needed.
- Keep component A from exposure to moisture in atmosphere, to prevent crystallization.
- Clean gun mix chamber ports regularly. See gun manual.
- Clean gun check valve screens regularly. See gun manual.
- Use compressed air to prevent dust buildup on control boards, fan, motor (under shield), and hydraulic oil coolers.
- Keep vent holes on bottom of electrical cabinet open.

Fluid Inlet Strainer Screen

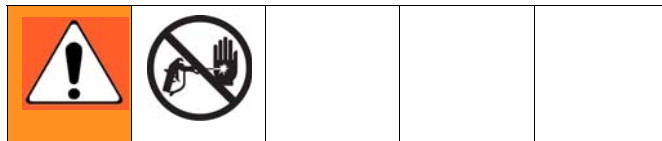

The inlet strainers filter out particles that can plug the pump inlet check valves. Inspect the screens daily as part of the startup routine, and clean as required.

Use clean chemicals and follow proper storage, transfer, and operating procedures, to minimize contamination of the A-side screen.

 Clean the A-side screen only during daily startup. This minimizes moisture contamination by immediately flushing out any isocyanate residue at the start of dispensing operations.

1. Close the fluid inlet valve at the pump inlet and shut off the appropriate feed pump. This prevents material from being pumped while cleaning the screen.
2. Place a container under the strainer manifold (59d) to catch fluid. Remove the strainer plug (59j).
3. Remove the screen (59g) from the strainer manifold. Thoroughly flush the screen with compatible solvent and shake it dry. Inspect the screen. If more than 25% of the mesh is blocked, replace the screen. Inspect the gasket (59h) and replace as required.
4. Ensure the pipe plug (59k) is screwed into the strainer plug (59j). Install the strainer plug with the screen (59g) and gasket (59h) in place and tighten. Do not overtighten. Let the gasket make the seal.
5. Open the fluid inlet valve, ensure that there are no leaks, and wipe the equipment clean. Proceed with operation.

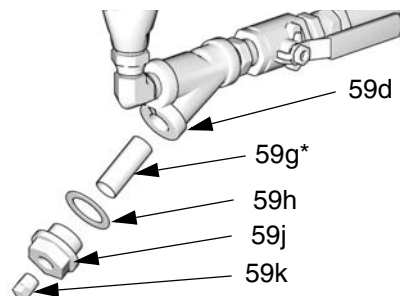

Ti10974a

FIG. 9. Fluid Inlet Strainer

Pump Lubrication System



Check the condition of the ISO pump lubricant daily. Change the lubricant if it becomes a gel, its color darkens, or it becomes diluted with isocyanate.

Gel formation is due to moisture absorption by the pump lubricant. The interval between changes depends on the environment in which the equipment is operating. The pump lubrication system minimizes exposure to moisture, but some contamination is still possible.

Lubricant discoloration is due to continual seepage of small amounts of isocyanate past the pump packings during operation. If the packings are operating properly, lubricant replacement due to discoloration should not be necessary more often than every 3 or 4 weeks.

To change pump lubricant:

1. Relieve pressure, page 30.
2. Lift the lubricant reservoir (LR) out of the bracket (RB) and remove the container from the cap. Holding the cap over a suitable container, remove the check valve and allow the lubricant to drain. Reattach the check valve to the inlet hose. See FIG. 10.
3. Drain the reservoir and flush it with clean lubricant.
4. When the reservoir is flushed clean, fill with fresh lubricant.
5. Thread the reservoir onto the cap assembly and place it in the bracket.
6. Push the larger diameter supply tube (ST) approximately 1/3 of the way into the reservoir.
7. Push the smaller diameter return tube (RT) into the reservoir until it reaches the bottom.

 **Important:** The return tube (RT) must reach the bottom of the reservoir, to ensure that isocyanate crystals will settle to the bottom and not be siphoned into the supply tube (ST) and returned to the pump.

8. The lubrication system is ready for operation. No priming is required.

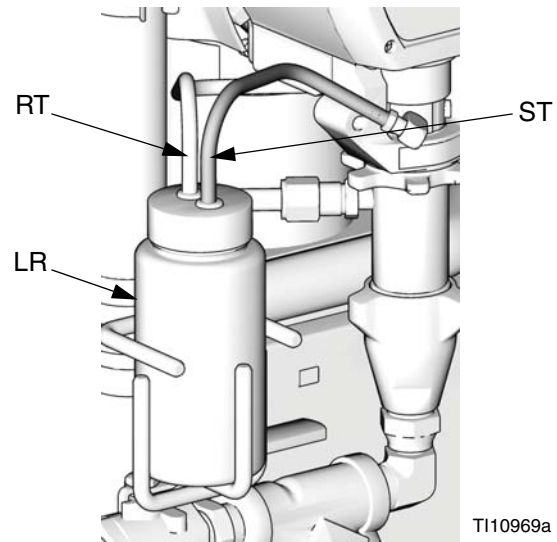
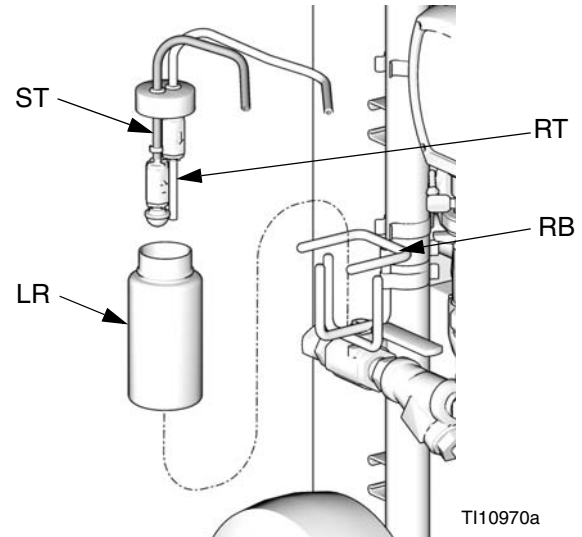
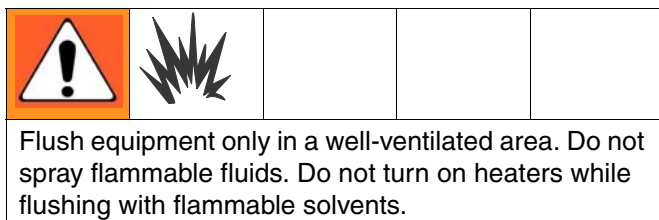

FIG. 10. Pump Lubrication System

Flushing



- Flush out old fluid with new fluid, or flush out old fluid with a compatible solvent before introducing new fluid.
- Use the lowest possible pressure when flushing.
- All fluid components are compatible with common solvents. Use only moisture-free solvents.

Accessories

Feed Pump Kits

Pumps, hoses, and mounting hardware to supply fluids to Reactor. Includes 246483 Air Supply Kit. See 309815.

246483 Air Supply Kit

Hoses and fittings to supply air to feed pumps, agitator, and gun air hose. Included in feed pump kits. See 309827.

246978 Circulation Kit

Return hoses and fittings to make circulation system. Includes two 246477 Return Tube Kits. See 309852.

246477 Return Tube Kit

Desiccant dryer, return tube, and fittings for one drum. Two included in 246978 Circulation Kit. See 309852.

248669 Conversion Kit

Convert any E-XP2 to a E-30 with 15.3kW of heat. Include new pumps, bearing, and fitting to accomplish conversion. See manual 309574.

- To flush feed hoses, pumps, and heaters separately from heated hoses, set PRESSURE RELIEF/SPRAY valves (SA, SB) to PRESSURE

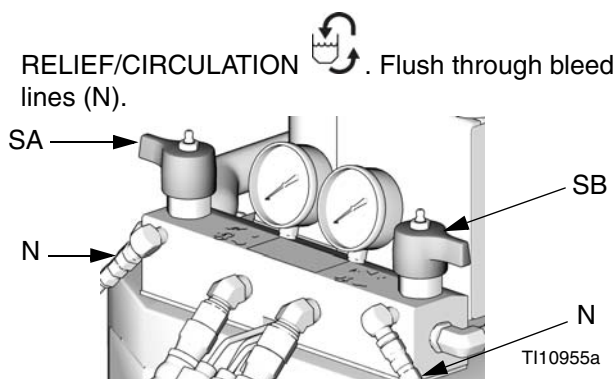

- To flush entire system, circulate through gun fluid manifold (with manifold removed from gun).
- To prevent moisture from reacting with isocyanate, always leave the system dry or filled with a moisture-free plasticizer or oil. Do not use water. See page 8.

Heated Hoses

50 ft (15.2 m) and 25 ft (7.6 m) lengths, 1/4 in. (6 mm), 3/8 in. (10 mm), or 1/2 in. (13 mm) diameter, 2000 psi (14 MPa, 140 bar) or 3500 psi (24 MPa, 241 bar). See 309572.

Heated Whip Hoses

10 ft (3 m) whip hose, 1/4 in. (6 mm) or 3/8 in. (10 mm) diameter, 2000 psi (14 MPa, 140 bar) or 3500 psi (24 MPa, 241 bar). See 309572.

Fusion Spray Gun

Air purge gun, available in round or flat pattern. See 309550.

246085 Data Reporting Kit

Records actual temperature, temperature setpoint, actual pressure, cycles, and diagnostic code data from Reactor. Downloads data to PC with Microsoft® Windows 98 or later. See 309867.

248848 Data Reporting Kit

Records actual temperature, temperature setpoint, actual pressure, cycles, and diagnostic code data from Reactor. Downloads data to PC with Microsoft® Windows 98 or later. Does not include interface module. See 309867.

Dimensions

Dimension	in. (mm)
A	46.0 (1168)
B	31.0 (787)
C	33.0 (838)

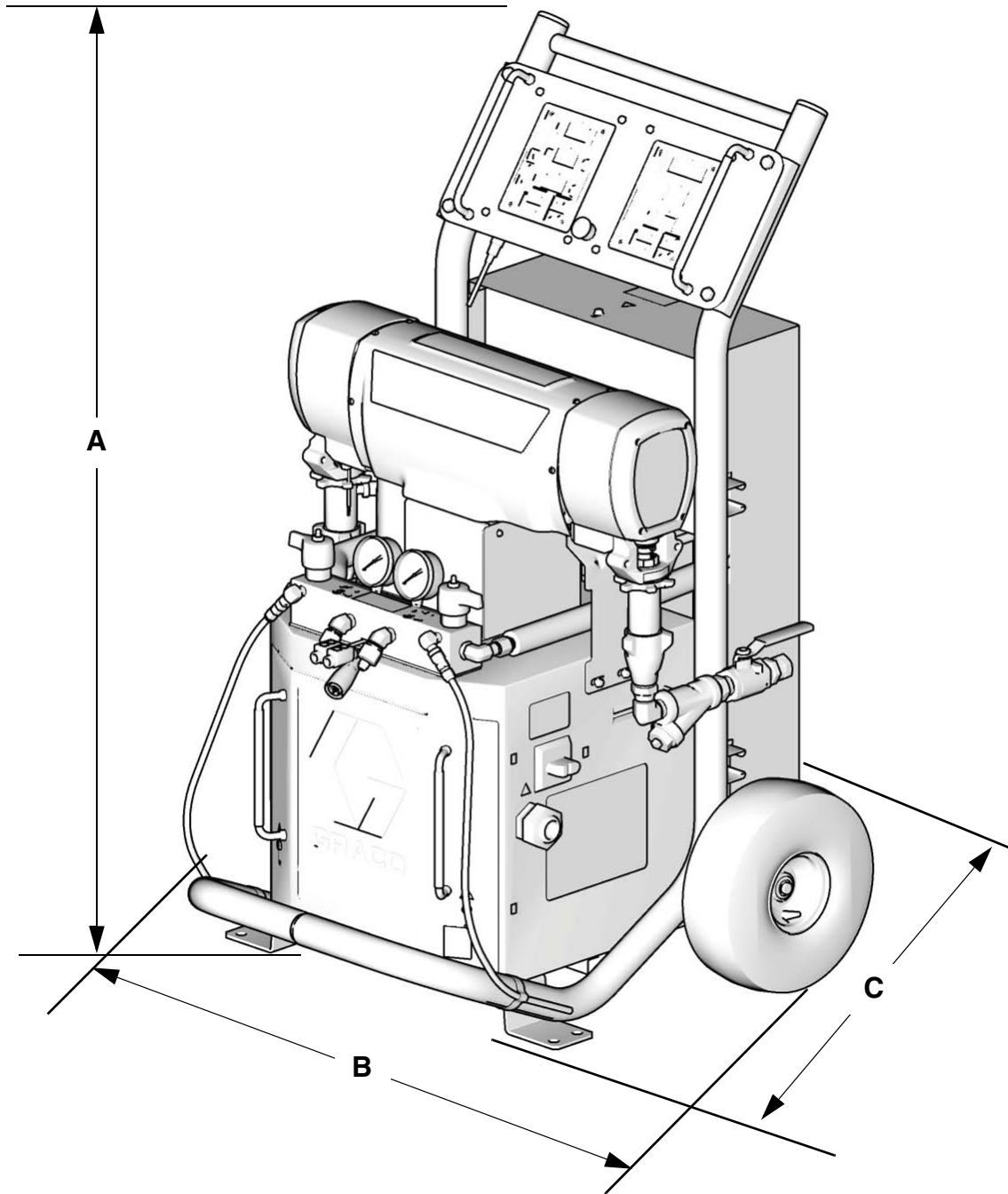

T110953a

Technical Data

Category	Data
Maximum Fluid Working Pressure	Models E-20 and E-30: 2000 psi (14 MPa, 140 bar) Model E-XP1: 2500 psi (17.2 MPa, 172 bar) Model E-XP2: 3500 psi (24.1 MPa, 241 bar)
Maximum Fluid Temperature	190°F (88°C)
Maximum Output	Model E-20: 20 lb/min (9 kg/min) Model E-30: 30 lb/min (13.5 kg/min) Model E-XP1: 1 gpm (3.8 liter/min) Model E-XP2: 2 gpm (7.6 liter/min)
Output per Cycle (A and B)	Model E-20 and E-XP1: 0.0104 gal. (0.0395 liter) Model E-30: 0.272 gal. (0.1034 liter) Model E-XP2: 0.0203 gal. (.0771 liter)
Line Voltage Requirement	Parts 259024, 259025, 259026, 259028, 259057: 195-264 Vac, 50/60 Hz Parts 259029, 259030, 259031, 259032, 259059: 338-457 Vac, 50/60 Hz Parts 2590330, 259034, 259035, 259036, 259058: 195-264 Vac, 50/60 Hz
Amperage Requirement	See Table 1, page 17.
Heater Power	Model E-20: 6000 Watts Model E-30 and E-XP1: 10200 Watts Models E-XP2 and E-30 with 15.3kW of heat: 15300 Watts
Sound Power, per ISO 9614-2	Model E-20: 80 dB(A) at 2000 psi (14 MPa, 140 bar), 0.5 gpm (1.9 lpm) Model E-30: 93.5 dB(A) at 1000 psi (7 MPa, 70 bar), 3.0 gpm (11.4 lpm) Model E-XP1: 80 dB(A) at 2000 psi (14 MPa, 140 bar), 0.5 gpm (1.9 lpm) Model E-XP2: 83.5 dB(A) at 3000 psi (21 MPa, 210 bar), 1.0 gpm (3.8 lpm)
Sound Pressure, 1 m from equipment	Model E-20: 70.2 dB(A) at 2000 psi (14 MPa, 140 bar), 0.5 gpm (1.9 lpm) Model E-30: 83.6 dB(A) at 1000 psi (7 MPa, 70 bar), 3.0 gpm (11.4 lpm) Model E-XP1: 70.2 dB(A) at 2000 psi (14 MPa, 140 bar), 0.5 gpm (1.9 lpm) Model E-XP2: 73.6 dB(A) at 3000 psi (21 MPa, 210 bar), 1.0 gpm (3.8 lpm)
Fluid Inlets	3/4 npt(f), with 3/4 npsm(f) union
Fluid Outlets	Component A (ISO): #8 (1/2 in.) JIC, with #5 (5/16 in.) JIC adapter Component B (RES): #10 (5/8 in.) JIC, with #6 (3/8 in.) JIC adapter
Fluid Circulation Ports	1/4 npsm(m), with plastic tubing; 250 psi (1.75 MPa, 17.5 bar) maximum
Weight	Model E-20 and E-XP1: 342 lb (155 kg) Model E-30: 400 lb (181kg) Models E-XP2 and E-30 with 15.3kW of heat: 438 lb (198 kg)
Wetted Parts	Aluminum, stainless steel, zinc plated, carbon steel, brass, carbide, chrome, chemically resistant o-rings, PTFE, ultra-high molecular weight polyethylene

All other brand names or marks are used for identification purposes and are trademarks of their respective owners.

Graco Standard Warranty

Graco warrants all equipment referenced in this document which is manufactured by Graco and bearing its name to be free from defects in material and workmanship on the date of sale to the original purchaser for use. With the exception of any special, extended, or limited warranty published by Graco, Graco will, for a period of twelve months from the date of sale, repair or replace any part of the equipment determined by Graco to be defective. This warranty applies only when the equipment is installed, operated and maintained in accordance with Graco's written recommendations.

This warranty does not cover, and Graco shall not be liable for general wear and tear, or any malfunction, damage or wear caused by faulty installation, misapplication, abrasion, corrosion, inadequate or improper maintenance, negligence, accident, tampering, or substitution of non-Graco component parts. Nor shall Graco be liable for malfunction, damage or wear caused by the incompatibility of Graco equipment with structures, accessories, equipment or materials not supplied by Graco, or the improper design, manufacture, installation, operation or maintenance of structures, accessories, equipment or materials not supplied by Graco.

This warranty is conditioned upon the prepaid return of the equipment claimed to be defective to an authorized Graco distributor for verification of the claimed defect. If the claimed defect is verified, Graco will repair or replace free of charge any defective parts. The equipment will be returned to the original purchaser transportation prepaid. If inspection of the equipment does not disclose any defect in material or workmanship, repairs will be made at a reasonable charge, which charges may include the costs of parts, labor, and transportation.

THIS WARRANTY IS EXCLUSIVE, AND IS IN LIEU OF ANY OTHER WARRANTIES, EXPRESS OR IMPLIED, INCLUDING BUT NOT LIMITED TO WARRANTY OF MERCHANTABILITY OR WARRANTY OF FITNESS FOR A PARTICULAR PURPOSE.

Graco's sole obligation and buyer's sole remedy for any breach of warranty shall be as set forth above. The buyer agrees that no other remedy (including, but not limited to, incidental or consequential damages for lost profits, lost sales, injury to person or property, or any other incidental or consequential loss) shall be available. Any action for breach of warranty must be brought within two (2) years of the date of sale.

GRACO MAKES NO WARRANTY, AND DISCLAIMS ALL IMPLIED WARRANTIES OF MERCHANTABILITY AND FITNESS FOR A PARTICULAR PURPOSE, IN CONNECTION WITH ACCESSORIES, EQUIPMENT, MATERIALS OR COMPONENTS SOLD BUT NOT MANUFACTURED BY GRACO. These items sold, but not manufactured by Graco (such as electric motors, switches, hose, etc.), are subject to the warranty, if any, of their manufacturer. Graco will provide purchaser with reasonable assistance in making any claim for breach of these warranties.

In no event will Graco be liable for indirect, incidental, special or consequential damages resulting from Graco supplying equipment hereunder, or the furnishing, performance, or use of any products or other goods sold hereto, whether due to a breach of contract, breach of warranty, the negligence of Graco, or otherwise.

FOR GRACO CANADA CUSTOMERS

The Parties acknowledge that they have required that the present document, as well as all documents, notices and legal proceedings entered into, given or instituted pursuant hereto or relating directly or indirectly hereto, be drawn up in English. Les parties reconnaissent avoir convenu que la rédaction du présente document sera en Anglais, ainsi que tous documents, avis et procédures judiciaires exécutés, donnés ou intentés, à la suite de ou en rapport, directement ou indirectement, avec les procédures concernées.

Graco Information

For the latest information about Graco products, visit www.graco.com.

TO PLACE AN ORDER, contact your Graco distributor or call to identify the nearest distributor.

Phone: 612-623-6921 **or Toll Free:** 1-800-328-0211, **Fax:** 612-378-3505

*All written and visual data contained in this document reflects the latest product information available at the time of publication.
Graco reserves the right to make changes at any time without notice.*

Original Instructions. *This manual contains English. MM 312065*

Graco Headquarters: Minneapolis

International Offices: Belgium, China, Japan, Korea

GRACO INC. P.O. BOX 1441 MINNEAPOLIS, MN 55440-1441

Copyright 2007, Graco Inc. is registered to ISO 9001

www.graco.com

Revised 01/2010