

Nd:YAG LaserLine Components

Table of Contents

Nd:YAG LASER OPTICS

Laser Mirrors	4.2
Laser Line Mirrors	4.2
Dual Band Mirrors	4.3
Laser Harmonic Separators	4.4
Laser Output Couplers	4.6
Laser Rear Mirrors	4.8
Laser Beamsplitters	4.9
Laser Line Anti-Reflection Coated Precision Windows	4.11
Anti-Reflective Coated Lens Kits	4.12
Thin Film Laser Polarizers	4.14
56° Angle of Incidence	4.14
45° Angle of Incidence	4.14
Quartz Retardation Plates	4.16
Zero Order Optically Contacted Waveplates	4.16
Zero Order Air-Spaced Waveplates	4.16
Low Order Waveplates	4.17
Multiple Order Waveplates	4.17
Multiple Order Dual Wavelength Waveplates	4.18
Polarization Plane Rotators	4.18
Variable Attenuator for Nd:YAG Linearly Polarized Laser Beam 990-0070	4.19
Variable Attenuator for Nd:YAG Linearly Polarized Laser Beam 990-0071	4.20
Variable Attenuator for Nd:YAG Linearly Polarized Laser Beam 990-0072	4.21
Variable Attenuator for Nd:YAG Linearly Polarized Laser Beam 990-0073	4.22

Nd:YAG LASER CRYSTALS

Nd:YAG Crystals (Standard Rods)	4.23
Nonlinear Crystals for SHG @ 1064 nm	4.24
LBO crystals	4.24
KTP crystals	4.24
DKDP crystals	4.24
Nonlinear Crystals for THG @ 1064 nm	4.25
LBO crystals	4.25
DKDP crystals	4.25
Nonlinear Crystals for 4HG @ 1064 nm	4.25
BBO crystals	4.25
KDP crystals	4.25



OPTICAL COMPONENTS CLEANING INSTRUCTIONS

See page A.4



Nd:YAG Laser Optics

LASER MIRRORS

Our Nd:YAG laser mirrors are suitable for fundamental Nd:YAG laser 1064 nm, frequency-doubled 532 nm, frequency-tripled 355 nm and frequency quadrupled 266 nm wavelength application. Two kinds of substrate material are available. Laser line mirrors

are designed for 45° angle of incidence. Featuring high polishing quality, low scattering and high damage threshold, our dielectric reflectors enables perfect beam steering for Nd:YAG lasers.

SUBSTRATE

Material	UV grade Fused Silica or BK7 glass
S1 Surface Flatness	$\lambda/10$ at 633 nm
S1 Surface Quality	20-10 scratch & dig (MIL-PRF-13830B)
S2 Surface Quality	Commercial polish
Diameter Tolerance	+0.00 mm -0.12 mm
Thickness Tolerance	± 0.25 mm
Wedge	< 3 min
Chamfer	0.3 mm at 45° typical

COATING

Technology	Electron beam multilayer dielectric or Ion Beam Sputtering
Adhesion and Durability	Per MIL-C-675A. Insoluble in lab solvents
Clear Aperture	Exceeds central 85% of diameter
Damage Threshold:	
BK7 laser line mirrors	5 J/cm ² , 8 nsec pulse, 1064 nm typical
UV FS laser line mirrors	8 J/cm ² , 8 nsec pulse, 1064 nm typical
BK7 dual line mirrors	1 J/cm ² , 8 nsec pulse, 1064 nm typical
UV FS dual line mirrors	2 J/cm ² , 8 nsec pulse, 1064 nm typical
Coated Surface Flatness	$\lambda/10$ at 633 nm over clear aperture
Angle of Incidence	0 or 45°

Laser Line Mirrors

Substrate material: **BK7 grade A**

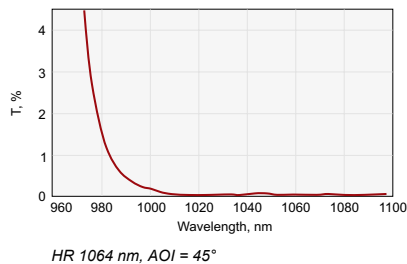

Size – $\varnothing 12.7 \times 3$ mm

Wavelength, nm	R, % (s+p)/2		Catalogue number		Price, EUR
	AOI=0°	AOI=45°	AOI=0°	AOI=45°	AOI=0° / AOI=45°
351–361	99.7 / 99.5		031-0350-i0	031-0350	59 / 59
527–532	99.7 / 99.5		031-0530-i0	031-0530	56 / 56
1047–1064	99.7 / 99.5		031-1060-i0	031-1060	57 / 57

Size – $\varnothing 12.7 \times 6$ mm

Wavelength, nm	R, % (s+p)/2		Catalogue number		Price, EUR
	AOI=0°	AOI=45°	AOI=0°	AOI=45°	AOI=0° / AOI=45°
351–361	99.7 / 99.5		031-0350T6-i0	031-0350T6	59 / 59
527–532	99.7 / 99.5		031-0530T6-i0	031-0530T6	56 / 56
1047–1064	99.7 / 99.5		031-1060T6-i0	031-1060T6	57 / 57

Size – $\varnothing 25.4 \times 6$ mm

Wavelength, nm	R, % (s+p)/2		Catalogue number		Price, EUR
	AOI=0°	AOI=45°	AOI=0°	AOI=45°	AOI=0° / AOI=45°
351–361	99.7 / 99.5		032-0350-i0	032-0350	90 / 90
527–532	99.7 / 99.5		032-0530-i0	032-0530	74 / 74
1047–1064	99.7 / 99.5		032-1060-i0	032-1060	75 / 75

Size – $\varnothing 50.8 \times 8$ mm

Wavelength, nm	R, % (s+p)/2		Catalogue number		Price, EUR
	AOI=0°	AOI=45°	AOI=0°	AOI=45°	AOI=0° / AOI=45°
351–361	99.7 / 99.5		035-0350-i0	035-0350	128 / 128
527–532	99.7 / 99.5		035-0530-i0	035-0530	110 / 110
1047–1064	99.7 / 99.5		035-1060-i0	035-1060	110 / 110

Size – $\varnothing 76.2 \times 12.7$ mm

Wavelength, nm	R, % (s+p)/2		Catalogue number		Price, EUR
	AOI=0°	AOI=45°	AOI=0°	AOI=45°	AOI=0° / AOI=45°
527–532	99.7 / 99.5		037-0530-i0	037-0530	185 / 185
1047–1064	99.7 / 99.5		037-1060-i0	037-1060	185 / 185

Laser Line Mirrors

Substrate material: **UV grade Fused Silica**

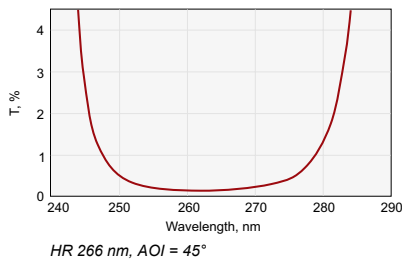

Size – **Ø12.7 × 3 mm**

Wavelength, nm	R, % (s+p)/2 AOI=0° / AOI=45°	Catalogue number		Price, EUR AOI=0° / AOI=45°
		AOI=0°	AOI=45°	
262–266	99 / 99	041-0260-i0	041-0260	71 / 71
351–361	99.7 / 99.5	041-0350-i0	041-0350	67 / 67
527–532	99.7 / 99.5	041-0530-i0	041-0530	62 / 62
1047–1064	99.7 / 99.5	041-1060-i0	041-1060	62 / 62

Size – **Ø12.7 × 6 mm**

Wavelength, nm	R, % (s+p)/2 AOI=0° / AOI=45°	Catalogue number		Price, EUR AOI=0° / AOI=45°
		AOI=0°	AOI=45°	
262–266	99 / 99	041-0260T6-i0	041-0260T6	71 / 71
351–361	99.7 / 99.5 – / 99.9	041-0350T6-i0 –	041-0350T6 041-0350HHR T6	67 / 67 – / 110
527–532	99.7 / 99.5 99.9 / 99.9	041-0530T6-i0 041-0530HHR T6-i0	041-0530T6 041-0530HHR T6	62 / 62 75 / 75
1047–1064	99.7 / 99.5 99.9 / 99.9	041-1060T6-i0 041-1060HHR T6-i0	041-1060T6 041-1060HHR T6	62 / 62 75 / 75

Size – **Ø25.4 × 6 mm**

Wavelength, nm	R, % (s+p)/2 AOI=0° / AOI=45°	Catalogue number		Price, EUR AOI=0° / AOI=45°
		AOI=0°	AOI=45°	
262–266	99 / 99	042-0260-i0	042-0260	99 / 99
351–361	99.7 / 99.5 – / 99.9	042-0350-i0 –	042-0350 042-0350HHR	95 / 95 – / 130
527–532	99.7 / 99.5 99.9 / 99.9	042-0530-i0 042-0530HHR-i0	042-0530 042-0530HHR	90 / 90 105 / 105
1047–1064	99.7 / 99.5 99.9 / 99.9	042-1060-i0 042-1060HHR-i0	042-1060 042-1060HHR	90 / 90 105 / 105

Size – **Ø50.8 × 8 mm**

Wavelength, nm	R, % (s+p)/2 AOI=0° / AOI=45°	Catalogue number		Price, EUR AOI=0° / AOI=45°
		AOI=0°	AOI=45°	
262–266	99 / 99	045-0260-i0	045-0260	207 / 207
351–361	99.7 / 99.5	045-0350-i0	045-0350	187 / 187
527–532	99.7 / 99.5	045-0530-i0	045-0530	169 / 169
1047–1064	99.7 / 99.5	045-1060-i0	045-1060	169 / 169

Size – **Ø76.2 × 12.7 mm**

Wavelength, nm	R, % (s+p)/2 AOI=0° / AOI=45°	Catalogue number		Price, EUR AOI=0° / AOI=45°
		AOI=0°	AOI=45°	
351–361	99.7 / 99.5	047-0350-i0	047-0350	281 / 281
527–532	99.7 / 99.5	047-0530-i0	047-0530	258 / 258
1047–1064	99.7 / 99.5	047-1060-i0	047-1060	258 / 258

Dual Band Mirrors

Substrate material: **BK7 grade A**

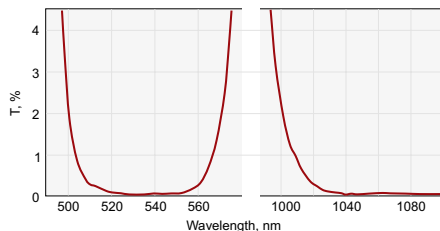

Size – **Ø12.7 × 3 mm**

Wavelength, nm	R, % (s+p)/2 AOI=0° / AOI=45°	Catalogue number		Price, EUR AOI=0° / AOI=45°
		AOI=0°	AOI=45°	
532+1064	99.7 / 99.5	051-5306-i0	051-5306	85 / 85
633+1064	99.7 / 99.5	051-6306-i0	051-6306	85 / 85

Size – **Ø12.7 × 6 mm**

Wavelength, nm	R, % (s+p)/2 AOI=0° / AOI=45°	Catalogue number		Price, EUR AOI=0° / AOI=45°
		AOI=0°	AOI=45°	
532+1064	99.7 / 99.5	051-5306T6-i0	051-5306T6	85 / 85
633+1064	99.7 / 99.5	051-6306T6-i0	051-6306T6	85 / 85

Size – **Ø25.4 × 6 mm**

Wavelength, nm	R, % (s+p)/2 AOI=0° / AOI=45°	Catalogue number		Price, EUR AOI=0° / AOI=45°
		AOI=0°	AOI=45°	
532+1064	99.7 / 99.5	052-5306-i0	052-5306	103 / 103
633+1064	99.7 / 99.5	052-6306-i0	052-6306	103 / 103

Size – **Ø50.8 × 8 mm**

Wavelength, nm	R, % (s+p)/2 AOI=0° / AOI=45°	Catalogue number		Price, EUR AOI=0° / AOI=45°
		AOI=0°	AOI=45°	
532+1064	99.7 / 99.5	055-5306-i0	055-5306	151 / 151
633+1064	99.7 / 99.5	055-6306-i0	055-6306	151 / 151

Size – **Ø76.2 × 12.7 mm**

Wavelength, nm	R, % (s+p)/2 AOI=0° / AOI=45°	Catalogue number		Price, EUR AOI=0° / AOI=45°
		AOI=0°	AOI=45°	
532+1064	99.7 / 99.5	057-5306-i0	057-5306	227 / 227
633+1064	99.7 / 99.5	057-6306-i0	057-6306	227 / 227

RELATED PRODUCTS

Prisms

See page 1.49

Kinematic
Mirror/Beamsplitter
Mounts 840-0056

See page 7.38



Dual Band Mirrors

Substrate material: **UV grade Fused Silica**

Size – **Ø12.7 × 3 mm**

Wavelength, nm	R, % (s+p)/2	Catalogue number		Price, EUR
	AOI=0° / AOI=45°	AOI=0°	AOI=45°	AOI=0° / AOI=45°
532+1064	99.7 / 99.5	061-5306-i0	061-5306	109 / 109
633+1064	99.7 / 99.5	061-6306-i0	061-6306	109 / 109
355+532	99.7 / 99.5	061-3553-i0	061-3553	115 / 115

Size – **Ø12.7 × 6 mm**

Wavelength, nm	R, % (s+p)/2	Catalogue number		Price, EUR
	AOI=0° / AOI=45°	AOI=0°	AOI=45°	AOI=0° / AOI=45°
532+1064	99.7 / 99.5	061-5306T6-i0	061-5306T6	109 / 109
633+1064	99.7 / 99.5	061-6306T6-i0	061-6306T6	109 / 109
355+532	99.7 / 99.5	061-3553T6-i0	061-3553T6	115 / 115

Size – **Ø25.4 × 6 mm**

Wavelength, nm	R, % (s+p)/2	Catalogue number		Price, EUR
	AOI=0° / AOI=45°	AOI=0°	AOI=45°	AOI=0° / AOI=45°
532+1064	99.7 / 99.5	062-5306-i0	062-5306	134 / 134
	99.9 / 99.9	062-5306HHR-i0	062-5306HHR	180 / 180
633+1064	99.7 / 99.5	062-6306-i0	062-6306	134 / 134
355+532	99.7 / 99.5	062-3553-i0	062-3553	139 / 139

Size – **Ø50.8 × 8 mm**

Wavelength, nm	R, % (s+p)/2	Catalogue number		Price, EUR
	AOI=0° / AOI=45°	AOI=0°	AOI=45°	AOI=0° / AOI=45°
532+1064	99.7 / 99.5	065-5306-i0	065-5306	209 / 209
633+1064	99.7 / 99.5	065-6306-i0	065-6306	209 / 209
355+532	99.7 / 99.5	065-3553-i0	065-3553	215 / 215

Size – **Ø76.2 × 12.7 mm**

Wavelength, nm	R, % (s+p)/2	Catalogue number		Price, EUR
	AOI=0° / AOI=45°	AOI=0°	AOI=45°	AOI=0° / AOI=45°
532+1064	99.7 / 99.5	067-5306-i0	067-5306	318 / 318
633+1064	99.7 / 99.5	067-6306-i0	067-6306	318 / 318
355+532	99.7 / 99.5	067-3553-i0	067-3553	323 / 323

RELATED PRODUCTS

Laser Line and Dual Laser Line Mirrors of other wavelengths

See page 1.19



Metal Coated Mirrors

See page 1.24

LASER HARMONIC SEPARATORS

- Offered on Ø 0.5 or 1 inch substrates of BK7 or UV FS with surface flatness $\lambda/10$

Harmonic separators are dichroic beamsplitters that reflect one wavelength and transmit the others. Reflectance is higher than 99.5% for the wavelength of interest and transmittance is at least 90% for the rejected wavelengths. The rear surface of harmonic separators is antireflection coated.

SUBSTRATE

Material	UV grade Fused Silica or BK7 glass
S1 Surface Flatness	$\lambda/10$ typical at 633 nm
S1 Surface Quality	20–10 scratch & dig (MIL-PRF-13830B)
S2 Surface Flatness	$\lambda/10$ typical at 633 nm
S2 Surface Quality	20–10 scratch & dig (MIL-PRF-13830B)
Diameter Tolerance	+0.00 mm -0.12 mm
Thickness Tolerance	± 0.25 mm
Parallelism	< 30 arcsec
Chamfer	0.3 mm at 45° typical

Laser Harmonic Separators with High Transmission

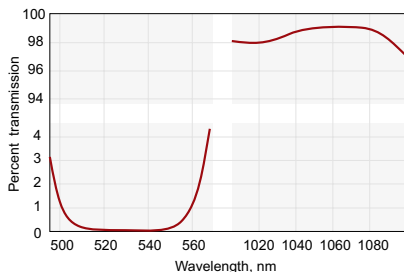

041-5105HT.
 HR > 99.9% @ 532 nm,
 HT > 99% @ 1064 nm, AOI = 45°

COATING

Technology	Ion Beam Sputtering (IBS)
Damage Threshold	>10 J/cm ² , 8 nsec pulse, 1064 nm typical
Back side anti-reflection coated	AOI 45°, R<0.25% AOI 0°, R<0.2%

Reflected wavelength, nm	Transmitted wavelength, nm	Transmission, %	AOI, deg	Substrate material	Code		Price, EUR
					Ø12.7x3 mm	Ø25.4x6 mm	
R > 99.9%							
532	1064	>99	0	UVFS	041-5100HT	042-5100HT	160 / 205
532	1064	>99	45	UVFS	041-5105HT	042-5105HT	160 / 205
1064	532	>99	0	UVFS	041-6500HT	042-6500HT	165 / 210
1064	532	>99	45	UVFS	041-6505HT	042-6505HT	165 / 210

Standard Laser Harmonic Separators

COATING

Technology	Electron beam multilayer dielectric
Adhesion and Durability	Per MIL-C-675A. Insoluble in lab solvents
Clear Aperture	Exceeds central 85% of diameter
Damage Threshold:	
BK7	>2 J/cm ² , 8 nsec pulse, 1064 nm typical
UV FS	>5 J/cm ² , 8 nsec pulse, 1064 nm typical
Coated Surface Flatness	$\lambda/10$ at 633 nm over clear aperture
Back side antireflection coated	AOI 45°, R<0.5% AOI 0°, R<0.1%

RELATED PRODUCTS

Pellin-Broca Prisms

See page 1.51

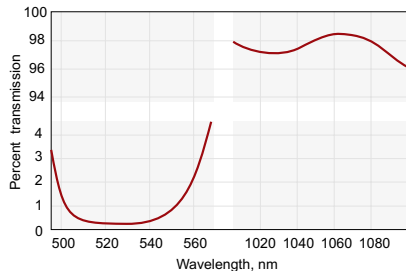

031-5105.
HR > 99.5% @ 532 nm, HT > 95% @ 1064 nm, AOI = 45°

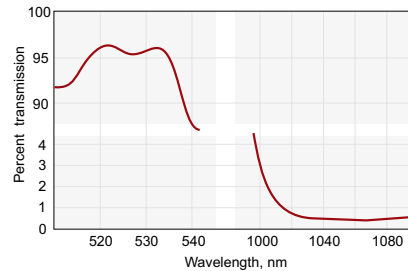

031-6500.
HR > 99.5% @ 1064 nm, HT > 93% @ 532 nm, AOI = 0°

Reflected wavelength, nm, R > 99.5%	Transmitted wavelength, nm	Transmission, %	AOI, deg	Substrate material	Code		Price, EUR
					Ø12.7x3 mm	Ø25.4x6 mm	
266	355+532+1064	>90	0	UVFS	041-2310	042-2310	155 / 185
266	355+532+1064	>90	45	UVFS	041-2315	042-2315	155 / 185
266	532	>95	0	UVFS	041-2500	042-2500	135 / 165
266	532	>95	45	UVFS	041-2505	042-2505	135 / 165
355	1064	>95	0	UVFS	041-3100	042-3100	115 / 145
355	1064	>95	45	UVFS	041-3105	042-3105	115 / 145
355	532	>95	0	UVFS	041-3500	042-3500	115 / 145
355	532	>95	45	UVFS	041-3505	042-3505	115 / 145
355	532+1064	>95	0	UVFS	041-3510	042-3510	125 / 155
355	532+1064	>95	45	UVFS	041-3515	042-3515	125 / 155
532	1064	>95	0	BK7	031-5100	032-5100	90 / 115
532	1064	>95	45	BK7	031-5105	032-5105	90 / 115
532	1064	>95	0	UVFS	041-5100	042-5100	115 / 145
532	1064	>95	45	UVFS	041-5105	042-5105	115 / 145
532+1064	355	>85	0	UVFS	041-5140	042-5140	205 / 230
532+1064	355	>85	45	UVFS	041-5145	042-5145	205 / 230
1064	532	>93	0	BK7	031-6500	032-6500	95 / 120
1064	532	>93	45	BK7	031-6505	032-6505	95 / 120
1064	532	>93	0	UVFS	041-6500	042-6500	120 / 150
1064	532	>93	45	UVFS	041-6505	042-6505	120 / 150

HOUSING ACCESSORIES

Adapter for Beamsplitter at 45° 840-0116

See page 7.41



Kinematic Mirror and Beamsplitter Mount 840-0020

See page 7.33



LASER OUTPUT COUPLERS

An output coupler is a partially reflecting dielectric mirror used in a laser cavity. It transmits a part of the circulating intracavity power for generating a useful output from the laser. A low transmission output coupler leads to a low laser threshold, but also possibly to poor laser efficiency if the losses due to output coupling do not dominate over other parasitic losses in the laser cavity. The output coupler transmission is often chosen to maximize the achieved output power, although its optimum value may be lower or higher if there are other design purposes (minimizing the intracavity intensities or suppressing Q-switching instabilities in a passively mode-locked laser).

SUBSTRATE

Material	UV grade Fused Silica or BK7 glass
S1 Surface Flatness	$\lambda/10$ typical at 633 nm
S1 Surface Quality	20–10 scratch & dig (MIL-PRF-13830B)
S2 Surface Flatness	$\lambda/10$ typical at 633 nm
S2 Surface Quality	20–10 scratch & dig (MIL-PRF-13830B)
Diameter Tolerance	+0.00 mm -0.12 mm
Thickness Tolerance	± 0.25 mm
Parallelism	30 arcsec
Chamfer	0.3 mm at 45° typical

COATING

Technology	Electron beam multilayer dielectric
Adhesion and Durability	Per MIL-C-675A. Insoluble in lab solvents
Clear Aperture	Exceeds central 85% of diameter
Damage Threshold:	
BK7	>3 J/cm ² , 8 nsec pulse, 1064 nm typical
UV FS	>6 J/cm ² , 8 nsec pulse, 1064 nm typical
Coated Surface Flatness	$\lambda/10$ at 633 nm over clear aperture
Angle of Incidence	0°–8° (normal)
Back side antireflection coated	R<0.2%

Laser Output Couplers

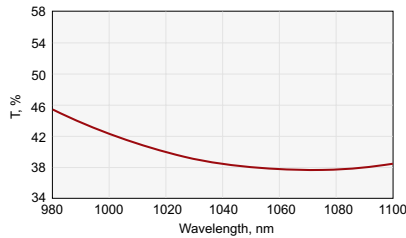

R = 60±2% @ 1064 nm, AOI=0°

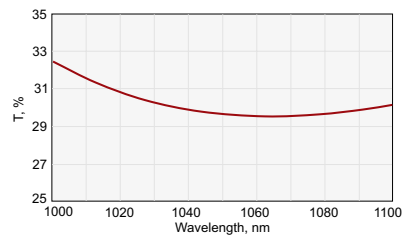

R = 70±2% @ 1064 nm, AOI=0°

Size – Ø12.7 × 3 mm

Wavelength, nm	Reflection, %	Transmission, %	Substrate material	Code	Price, EUR
1064	15±3	85±3	BK7	031-0015	75
1064	20±3	80±3	BK7	031-0020	75
1064	25±3	75±3	BK7	031-0025	75
1064	30±3	70±3	BK7	031-0030	75
1064	40±3	60±3	BK7	031-0040	75
1064	50±3	50±3	BK7	031-0050	75
1064	60±3	40±3	BK7	031-0060	75
1064	65±3	35±3	BK7	031-0065	75
1064	70±3	30±3	BK7	031-0070	75
1064	75±3	25±3	BK7	031-0075	75
1064	80±3	20±3	BK7	031-0080	75
1064	85±3	15±3	BK7	031-0085	75
1064	90±2	10±2	BK7	031-0090	82
1064	95±2	5±2	BK7	031-0095	82
1064	97±1	3±1	BK7	031-0097	89
1064	98±1	2±1	BK7	031-0098	89
1064	99.0±0.5	1.0±0.5	BK7	031-0099	96
1064	20±3	80±3	UV FS	041-0020	95
1064	30±3	70±3	UV FS	041-0030	95
1064	40±3	60±3	UV FS	041-0040	95
1064	50±3	50±3	UV FS	041-0050	95
1064	60±3	40±3	UV FS	041-0060	95
1064	65±3	35±3	UV FS	041-0065	95
1064	70±3	30±3	UV FS	041-0070	95
1064	75±3	25±3	UV FS	041-0075	95
1064	80±3	20±3	UV FS	041-0080	95
1064	85±3	15±3	UV FS	041-0085	95
1064	90±2	10±2	UV FS	041-0090	102
1064	95±2	5±2	UV FS	041-0095	102
1064	97±1	3±1	UV FS	041-0097	109
1064	98±1	2±1	UV FS	041-0098	109
1064	99.0±0.5	1.0±0.5	UV FS	041-0099	116

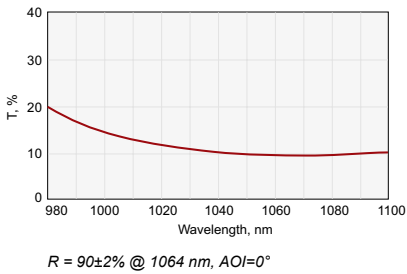
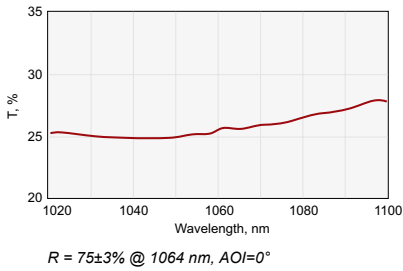

Size – Ø25.4 × 6 mm

Wavelength, nm	Reflection, %	Transmission, %	Substrate material	Code	Price, EUR
1064	15±3	85±3	BK7	032-0015	95
1064	20±3	80±3	BK7	032-0020	95
1064	25±3	75±3	BK7	032-0025	95
1064	30±3	70±3	BK7	032-0030	95
1064	40±3	60±3	BK7	032-0040	95
1064	50±3	50±3	BK7	032-0050	95
1064	60±3	40±3	BK7	032-0060	95
1064	65±3	35±3	BK7	032-0065	95
1064	70±3	30±3	BK7	032-0070	95
1064	75±3	25±3	BK7	032-0075	95
1064	80±3	20±3	BK7	032-0080	95
1064	85±3	15±3	BK7	032-0085	95
1064	90±2	10±2	BK7	032-0090	102
1064	95±2	5±2	BK7	032-0095	102
1064	97±1	3±1	BK7	032-0097	109
1064	98±1	2±1	BK7	032-0098	109
1064	99.0±0.5	1.0±0.5	BK7	032-0099	116
1064	15±3	85±3	UV FS	042-0015	115
1064	20±3	80±3	UV FS	042-0020	115
1064	25±3	75±3	UV FS	042-0025	115
1064	30±3	70±3	UV FS	042-0030	115
1064	40±3	60±3	UV FS	042-0040	115
1064	50±3	50±3	UV FS	042-0050	115
1064	60±3	40±3	UV FS	042-0060	115
1064	65±3	35±3	UV FS	042-0065	115
1064	70±3	30±3	UV FS	042-0070	115
1064	75±3	25±3	UV FS	042-0075	115
1064	80±3	20±3	UV FS	042-0080	115
1064	85±3	15±3	UV FS	042-0085	115
1064	90±2	10±2	UV FS	042-0090	122
1064	95±2	5±2	UV FS	042-0095	122
1064	97±1	3±1	UV FS	042-0097	129
1064	98±1	2±1	UV FS	042-0098	129
1064	99.0±0.5	1.0±0.5	UV FS	042-0099	136

RELATED PRODUCTS

Uncoated Flat Windows

See page 1.10

Kinematic Mirror and Beamsplitter Mount

840-0020

See page 7.33



LASER REAR MIRRORS

High reflectivity ($R > 99.8\%$) coatings are applied on laser rear mirrors. The UV FS substrates are suggested for pulsed and CW high power fundamental Nd:YAG laser application.

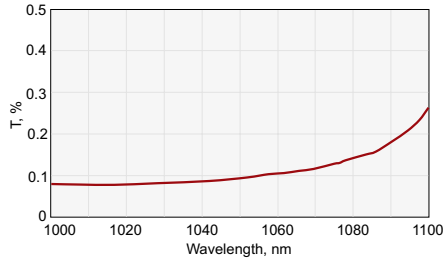

$R > 99.8\%$ @ 1064 nm

SUBSTRATE

Material	UV grade Fused Silica or BK7 glass
S1 Surface Flatness	$\lambda/10$ at 633 nm
S1 Surface Quality	20–10 scratch & dig (MIL-PRF-13830B)
S2 Surface Quality	Commercial polish
Diameter Tolerance	+0.00 mm-0.12 mm
Thickness Tolerance	± 0.25
Chamfer	0.3 mm at 45° typical

COATING

Technology	Electron beam multilayer dielectric
Adhesion and Durability	Per MIL-C-675A. Insoluble in lab solvents
Clear Aperture	Exceeds central 85% of diameter
Damage Threshold:	
BK7	> 2 J/cm ² , 8 nsec pulse, 1064 nm
UV FS	> 5 J/cm ² , 8 nsec pulse, 1064 nm
Angle of Incidence	0°–8° (normal)
Reflectivity	$R > 99.7\%$

Wavelength, nm	Substrate type	Radius, mm	Substrate material	Code	Price, EUR
				Ø25.4×6 mm	
1047–1064	Plano	∞	BK7	032-1060-i0	75
1064	Plano-concave	-50	BK7	032-8005	89
1064	Plano-concave	-100	BK7	032-8010	89
1064	Plano-concave	-150	BK7	032-8015	89
1064	Plano-concave	-200	BK7	032-8020	89
1064	Plano-concave	-250	BK7	032-8025	89
1064	Plano-concave	-500	BK7	032-8050	89
1064	Plano-concave	-1000	BK7	032-8100	89
1064	Plano-concave	-2000	BK7	032-8200	89
1064	Plano-concave	-2500	BK7	032-8250	89
1064	Plano-concave	-4000	BK7	032-8400	89
1064	Plano-concave	-5000	BK7	032-8500	89
1047–1064	Plano	∞	UV FS	042-1060-i0	90
1064	Plano-concave	-50	UV FS	042-8005	109
1064	Plano-concave	-100	UV FS	042-8010	109
1064	Plano-concave	-150	UV FS	042-8015	109
1064	Plano-concave	-200	UV FS	042-8020	109
1064	Plano-concave	-250	UV FS	042-8025	109
1064	Plano-concave	-500	UV FS	042-8050	109
1064	Plano-concave	-1000	UV FS	042-8100	109
1064	Plano-concave	-2000	UV FS	042-8200	109
1064	Plano-concave	-2500	UV FS	042-8250	109
1064	Plano-concave	-4000	UV FS	042-8400	109
1064	Plano-concave	-5000	UV FS	042-8500	109
1064	Plano-convex	+100	BK7	032-9010	93
1064	Plano-convex	+200	BK7	032-9020	93
1064	Plano-convex	+300	BK7	032-9030	93
1064	Plano-convex	+500	BK7	032-9050	93
1064	Plano-convex	+1000	BK7	032-9100	93
1064	Plano-convex	+2000	BK7	032-9200	93
1064	Plano-convex	+3000	BK7	032-9300	93
1064	Plano-convex	+4000	BK7	032-9400	93
1064	Plano-convex	+100	UV FS	042-9010	113
1064	Plano-convex	+200	UV FS	042-9020	113
1064	Plano-convex	+300	UV FS	042-9030	113
1064	Plano-convex	+500	UV FS	042-9050	113
1064	Plano-convex	+1000	UV FS	042-9100	113
1064	Plano-convex	+2000	UV FS	042-9200	113
1064	Plano-convex	+3000	UV FS	042-9300	113
1064	Plano-convex	+4000	UV FS	042-9400	113

RELATED PRODUCTS

Uncoated
Curved Windows
See page 1.8

Kinematic Mirror
Mount 840-0010
See page 7.33



LASER BEAMSPLITTERS

- Designed for average polarization: $R=(R_s+R_p)/2$ and $T=(T_s+T_p)/2$

Beamsplitter splits average polarized laser beam into two beams separated by 90° from each other.

RELATED PRODUCTS

Uncoated Flat Windows
See page 1.10

SUBSTRATE

Material	UV FS, BK7
S1 Surface Flatness	λ/10 at 633 nm
S1 Surface Quality	20-10 scratch & dig (MIL-PRF-13830B)
S2 Surface Flatness	λ/10 at 633 nm
S2 Surface Quality	20-10 scratch & dig (MIL-PRF-13830B)
Diameter Tolerance	+0.00 mm-0.12 mm
Thickness Tolerance	±0.25
Parallelism	30 arcsec
Chamfer	0.3 mm at 45° typical

COATING

Technology	Electron beam multilayer dielectric
Adhesion and Durability	Per MIL-C-675A. Insoluble in lab solvents
Clear Aperture	Exceeds central 85% of diameter
Damage Threshold:	
BK7	5 J/cm ² , 8 nsec pulse, 1064 nm
UV FS	8 J/cm ² , 8 nsec pulse, 1064 nm
Angle of Incidence	45±3 degrees
Backside antireflection coated	R<0.5%

Designed for average polarization: $R=(R_s+R_p)/2$ and $T=(T_s+T_p)/2$

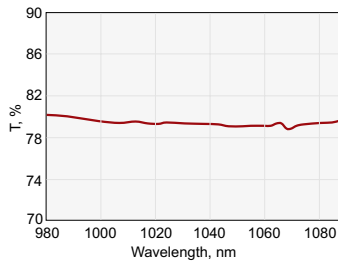

042-7120A.
R = 20±3%, T = 80±3% @ 1064 nm

Wavelength, nm	Reflection, %	Transmission, %	Substrate material	Size		Price, EUR
				Ø12.7x3 mm	Ø25.4x6 mm	
1064	20±3	80±3	BK7	031-7120A	032-7120A	75 / 95
1064	30±3	70±3	BK7	031-7130A	032-7130A	75 / 95
1064	50±3	50±3	BK7	031-7150A	032-7150A	75 / 95
1064	70±3	30±3	BK7	031-7170A	032-7170A	75 / 95
1064	75±3	25±3	BK7	031-7175A	032-7175A	75 / 95
1064	80±3	20±3	BK7	031-7180A	032-7180A	75 / 95
1064	90±3	10±3	BK7	031-7190A	032-7190A	75 / 95
532	20±3	80±3	BK7	031-7220A	032-7220A	73 / 93
532	30±3	70±3	BK7	031-7230A	032-7230A	73 / 93
532	50±3	50±3	BK7	031-7250A	032-7250A	73 / 93
532	70±3	30±3	BK7	031-7270A	032-7270A	73 / 93
532	80±3	20±3	BK7	031-7280A	032-7280A	73 / 93
1064	20±3	80±3	UV FS	041-7120A	042-7120A	95 / 115
1064	30±3	70±3	UV FS	041-7130A	042-7130A	95 / 115
1064	50±3	50±3	UV FS	041-7150A	042-7150A	95 / 115
1064	70±3	30±3	UV FS	041-7170A	042-7170A	95 / 115
1064	75±3	25±3	UV FS	041-7175A	042-7175A	95 / 115
1064	80±3	20±3	UV FS	041-7180A	042-7180A	95 / 115
1064	90±3	10±3	UV FS	041-7190A	042-7190A	95 / 115
532	20±3	80±3	UV FS	041-7220A	042-7220A	93 / 113
532	30±3	70±3	UV FS	041-7230A	042-7230A	93 / 113
532	50±3	50±3	UV FS	041-7250A	042-7250A	93 / 113
532	70±3	30±3	UV FS	041-7270A	042-7270A	93 / 113
532	80±3	20±3	UV FS	041-7280A	042-7280A	93 / 113
355	20±3	80±3	UV FS	041-7320A	042-7320A	105 / 135
355	30±3	70±3	UV FS	041-7330A	042-7330A	105 / 135
355	50±3	50±3	UV FS	041-7350A	042-7350A	105 / 135
355	70±3	30±3	UV FS	041-7370A	042-7370A	105 / 135
355	80±3	20±3	UV FS	041-7380A	042-7380A	105 / 135
266	20±3	80±3	UV FS	041-7920A	042-7920A	115 / 145
266	30±3	70±3	UV FS	041-7930A	042-7930A	115 / 145
266	50±3	50±3	UV FS	041-7950A	042-7950A	115 / 145
266	70±3	30±3	UV FS	041-7970A	042-7970A	115 / 145
266	80±3	20±3	UV FS	041-7980A	042-7980A	115 / 145

Designed for S- polarization

Wavelength, nm	Reflection, %	Transmission, %	Substrate material	Size		Price, EUR Ø12.7 / Ø25.4
				Ø12.7x3 mm	Ø25.4x6 mm	
1064	20±3	80±3	BK7	031-7120S	032-7120S	75 / 95
1064	30±3	70±3	BK7	031-7130S	032-7130S	75 / 95
1064	50±3	50±3	BK7	031-7150S	032-7150S	75 / 95
1064	70±3	30±3	BK7	031-7170S	032-7170S	75 / 95
1064	80±3	20±3	BK7	031-7180S	032-7180S	75 / 95
532	20±3	80±3	BK7	031-7220S	032-7220S	73 / 93
532	30±3	70±3	BK7	031-7230S	032-7230S	73 / 93
532	50±3	50±3	BK7	031-7250S	032-7250S	73 / 93
532	70±3	30±3	BK7	031-7270S	032-7270S	73 / 93
532	80±3	20±3	BK7	031-7280S	032-7280S	73 / 93
1064	20±3	80±3	UV FS	041-7120S	042-7120S	95 / 115
1064	30±3	70±3	UV FS	041-7130S	042-7130S	95 / 115
1064	50±3	50±3	UV FS	041-7150S	042-7150S	95 / 115
1064	70±3	30±3	UV FS	041-7170S	042-7170S	95 / 115
1064	80±3	20±3	UV FS	041-7180S	042-7180S	95 / 115
532	20±3	80±3	UV FS	041-7220S	042-7220S	93 / 113
532	30±3	70±3	UV FS	041-7230S	042-7230S	93 / 113
532	50±3	50±3	UV FS	041-7250S	042-7250S	93 / 113
532	70±3	30±3	UV FS	041-7270S	042-7270S	93 / 113
532	80±3	20±3	UV FS	041-7280S	042-7280S	93 / 113
355	20±3	80±3	UV FS	041-7320S	042-7320S	105 / 135
355	30±3	70±3	UV FS	041-7330S	042-7330S	105 / 135
355	50±3	50±3	UV FS	041-7350S	042-7350S	105 / 135
355	70±3	30±3	UV FS	041-7370S	042-7370S	105 / 135
355	80±3	20±3	UV FS	041-7380S	042-7380S	105 / 135
266	20±3	80±3	UV FS	041-7920S	042-7920S	115 / 145
266	30±3	70±3	UV FS	041-7930S	042-7930S	115 / 145
266	50±3	50±3	UV FS	041-7950S	042-7950S	115 / 145
266	70±3	30±3	UV FS	041-7970S	042-7970S	115 / 145
266	80±3	20±3	UV FS	041-7980S	042-7980S	115 / 145

Designed for P- polarization

Wavelength, nm	Reflection, %	Transmission, %	Substrate material	Size		Price, EUR Ø12.7 / Ø25.4
				Ø12.7x3 mm	Ø25.4x6 mm	
1064	20±3	80±3	BK7	031-7120P	032-7120P	75 / 95
1064	30±3	70±3	BK7	031-7130P	032-7130P	75 / 95
1064	50±3	50±3	BK7	031-7150P	032-7150P	75 / 95
1064	70±3	30±3	BK7	031-7170P	032-7170P	75 / 95
1064	80±3	20±3	BK7	031-7180P	032-7180P	75 / 95
532	20±3	80±3	BK7	031-7220P	032-7220P	73 / 93
532	30±3	70±3	BK7	031-7230P	032-7230P	73 / 93
532	50±3	50±3	BK7	031-7250P	032-7250P	73 / 93
532	70±3	30±3	BK7	031-7270P	032-7270P	73 / 93
532	80±3	20±3	BK7	031-7280P	032-7280P	73 / 93
1064	20±3	80±3	UV FS	041-7120P	042-7120P	95 / 115
1064	30±3	70±3	UV FS	041-7130P	042-7130P	95 / 115
1064	50±3	50±3	UV FS	041-7150P	042-7150P	95 / 115
1064	70±3	30±3	UV FS	041-7170P	042-7170P	95 / 115
1064	80±3	20±3	UV FS	041-7180P	042-7180P	95 / 115
532	20±3	80±3	UV FS	041-7220P	042-7220P	93 / 113
532	30±3	70±3	UV FS	041-7230P	042-7230P	93 / 113
532	50±3	50±3	UV FS	041-7250P	042-7250P	93 / 113
532	70±3	30±3	UV FS	041-7270P	042-7270P	93 / 113
532	80±3	20±3	UV FS	041-7280P	042-7280P	93 / 113
355	20±3	80±3	UV FS	041-7320P	042-7320P	105 / 135
355	30±3	70±3	UV FS	041-7330P	042-7330P	105 / 135
355	50±3	50±3	UV FS	041-7350P	042-7350P	105 / 135
355	70±3	30±3	UV FS	041-7370P	042-7370P	105 / 135
355	80±3	20±3	UV FS	041-7380P	042-7380P	105 / 135
266	20±3	80±3	UV FS	041-7920P	042-7920P	115 / 145
266	30±3	70±3	UV FS	041-7930P	042-7930P	115 / 145
266	50±3	50±3	UV FS	041-7950P	042-7950P	115 / 145
266	70±3	30±3	UV FS	041-7970P	042-7970P	115 / 145
266	80±3	20±3	UV FS	041-7980P	042-7980P	115 / 145

HOUSING ACCESSORIES

Kinematic Mirror and Beamsplitter Mount
840-0030-02
See page 7.33



Adapter for Beamsplitter at 45° 840-0116
See page 7.41



Flipping Mirror/Beamsplitter Mount 840-0155
See page 7.45



LASER LINE ANTI-REFLECTION COATED PRECISION WINDOWS

- Made of premium quality UV FS and BK7
- AR coated at 266 nm, 355 nm, 532 nm, 1064 nm

Precision windows are mostly used in laser systems. High quality AR multilayer coatings are applied on windows for fundamental Nd:YAG laser 1064 nm, frequency-doubled 532 nm, frequency-tripled 355nm and frequency-quadrupled 266nm applications. Featuring high optical transmission with little distortion of the transmitted signal, precision windows are a good solution for applications that require protective windows.

SPECIFICATIONS

Material	BK7, UV FS
Surface quality	20-10 scratch & dig (MIL-PRF-13830B)
Clear aperture	90% of the diameter
Diameter tolerance	+0.00-0.12 mm
Thickness tolerance	±0.2 mm
Surface flatness	λ/10@633 nm
Parallelism	30 arcsec or 3 arcsec

COATING

Technology	Electron beam multilayer dielectric
Adhesion and Durability	Per MIL-C-675A. Insoluble in lab solvents
Clear Aperture	Exceeds central 85% of diameter
Damage Threshold:	
BK7	>5 J/cm ² , 8 nsec pulse, 1064 nm
UV FS	>10 J/cm ² , 8 nsec pulse, 1064 nm
Angle of Incidence	0 degrees
Coated Surface Flatness	λ/10 at 633 nm over clear aperture

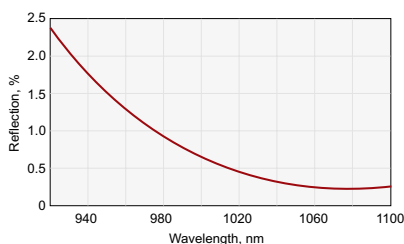

R<0.25%@1064 nm AOI=0°

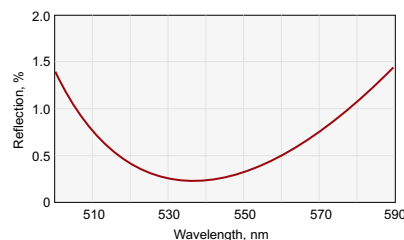

R<0.25%@532 nm AOI=0°

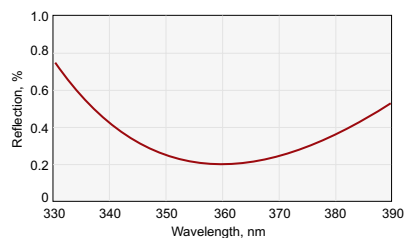

R<0.25%@355 nm, AOI=0°

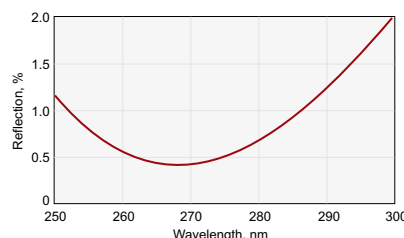

R<0.4%@266 nm, AOI=0°

Parallelism 30 arcsec

Catalogue number	Wavelength,	Diameter D,	Thickness T,	Price, EUR	
BK7	UV FS	nm	mm	BK7 / UV FS	
-	224-1101E	266	12.7	3.0	- / 79
-	223-1101E	355	12.7	3.0	- / 65
222-0101E	222-1101E	532	12.7	3.0	51 / 65
221-0101E	221-1101E	1064	12.7	3.0	51 / 65
-	224-1201E	266	25.4	6.0	- / 85
-	223-1201E	355	25.4	6.0	- / 70
222-0201E	222-1201E	532	25.4	6.0	61 / 70
221-0201E	221-1201E	1064	25.4	6.0	61 / 70
-	224-1402E	266	38.1	8.0	- / 131
-	223-1402E	355	38.1	8.0	- / 126
222-0402E	222-1402E	532	38.1	8.0	86 / 126
221-0402E	221-1402E	1064	38.1	8.0	86 / 126
-	224-1502E	266	50.8	10.0	- / 181
-	223-1502E	355	50.8	10.0	- / 176
222-0502E	222-1502E	532	50.8	10.0	99 / 176
221-0502E	221-1502E	1064	50.8	10.0	99 / 176

Parallelism 3 arcsec

Catalogue number		Wavelength,	Diameter D,	Thickness T,	Price, EUR
BK7	UV FS	nm	mm	mm	BK7 / UV FS
-	224-1103E	266	12.7	3.0	- / 96
-	223-1103E	355	12.7	3.0	- / 82
222-0103E	222-1103E	532	12.7	3.0	66 / 82
221-0103E	221-1103E	1064	12.7	3.0	66 / 82
-	224-1203E	266	25.4	6.0	- / 125
-	223-1203E	355	25.4	6.0	- / 111
222-0203E	222-1203E	532	25.4	6.0	88 / 111
221-0203E	221-1203E	1064	25.4	6.0	88 / 111
-	224-1403E	266	38.1	10.0	- / 176
-	223-1403E	355	38.1	10.0	- / 170
222-0403E	222-1403E	532	38.1	10.0	121 / 170
221-0403E	221-1403E	1064	38.1	10.0	121 / 170
-	224-1503E	266	50.8	12.0	- / 217
-	223-1503E	355	50.8	12.0	- / 212
222-0503E	222-1503E	532	50.8	12.0	148 / 212
221-0503E	221-1503E	1064	50.8	12.0	148 / 212

RELATED PRODUCTS

Uncoated Precision Windows

See page 1.12

AR COATED LENS KITS



Lens kits contain different types (plano-convex, biconvex, plano-concave, biconcave) of Ø25.4 mm lenses with various focal lengths. Kits are packed into foam lined plastic the new plastic boxes for safe handling and storage.

Large lens kit consists of 40 lenses and small lens kit consists of 15 lenses made either of N-BK7 glass or UV FS. Kits are available with multilayer anti-reflection coatings for Nd:YAG laser fundamental and harmonics wavelengths: 226 nm, 355 nm, 532 nm, 1064 nm.

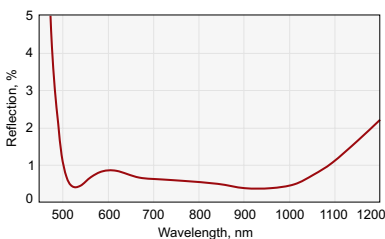

R<1.5% @ 500-1100 nm, AOI=0°

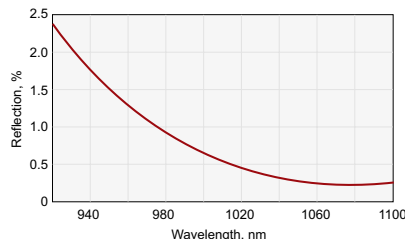

R<0.25% @ 1064 nm AOI=0°

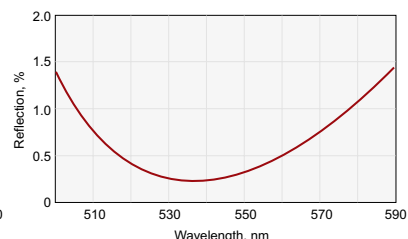

R<0.25% @ 532 nm AOI=0°

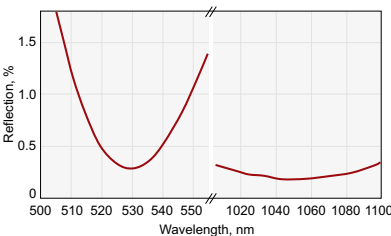

R<0.5% @ 532 nm + 1064 nm, AOI=0°

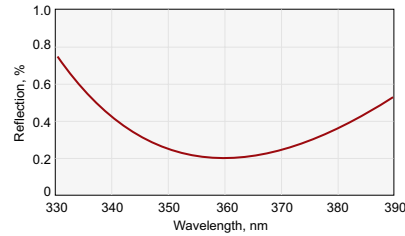

R<0.25% @ 355 nm, AOI=0°

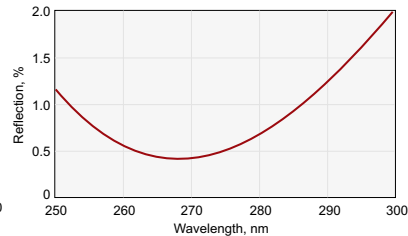

R<0.4% @ 266 nm, AOI=0°

BK7 Lenses Kits



Small Lenses Kit

Large kit of 40 pcs. N-BK7 lenses:

Code	Coating	Price, EUR
140-0240-AR400-700	BBAR @ 400–700 nm, R<0.9%	1820
140-0240-AR650-1100	BBAR @ 650–1100, R<1.0%	1930
140-0240-AR1050-1700	BBAR @ 1050–1700 nm, R<1.0%	2030
140-0240-AR532+1064	AR @ 532 + 1064 nm, R<0.5%	1750
140-0240-AR1064	AR @ 1064 nm, R<0.25%	1550
140-0240-AR532	AR @ 532 nm, R<0.25%	1550

Small kit of 15 pcs. N-BK7 lenses:

Code	Coating	Price, EUR
140-0215-AR400-700	BBAR @ 400–700 nm, R<0.9%	990
140-0215-AR650-1100	BBAR @ 650–1100 nm, R<1.0%	1050
140-0240-AR1050-1700	BBAR @ 1050–1700 nm, R<1.0%	1150
140-0215-AR532+1064	AR @ 532 + 1064 nm, R<0.5%	770
140-0215-AR1064	AR @ 1064 nm, R<0.25%	700
140-0215-AR532	AR @ 532 nm, R<0.25%	700

Small BK7 Lens Kit

Code	Type	Dia, mm	F, mm
110-0205E	pl/cx	25.4	30
110-0207E	pl/cx	25.4	40
110-0209E	pl/cx	25.4	50
110-0211E	pl/cx	25.4	60
110-0215E	pl/cx	25.4	75
110-0219E	pl/cx	25.4	100
110-0227E	pl/cx	25.4	150
110-0231E	pl/cx	25.4	200
110-0247E	pl/cx	25.4	500
110-0259E	pl/cx	25.4	1000
112-0207E	pl/cv	25.4	-40
112-0209E	pl/cv	25.4	-50
112-0215E	pl/cv	25.4	-75
112-0219E	pl/cv	25.4	-100
112-0227E	pl/cv	25.4	-150

Large BK7 Lens Kit

Code	Type	Dia, mm	F, mm	Code	Type	Dia, mm	F, mm
110-0205E	pl/cx	25.4	30	111-0214E	bi/cx	25.4	60
110-0207E	pl/cx	25.4	40	111-0216E	bi/cx	25.4	75
110-0209E	pl/cx	25.4	50	111-0218E	bi/cx	25.4	100
110-0211E	pl/cx	25.4	60	111-0222E	bi/cx	25.4	150
110-0215E	pl/cx	25.4	75	111-0226E	bi/cx	25.4	200
110-0219E	pl/cx	25.4	100	111-0228E	bi/cx	25.4	250
110-0223E	pl/cx	25.4	125	111-0234E	bi/cx	25.4	500
110-0227E	pl/cx	25.4	150	111-0250E	bi/cx	25.4	1000
110-0231E	pl/cx	25.4	200	112-0207E	pl/cv	25.4	-40
110-0235E	pl/cx	25.4	250	112-0209E	pl/cv	25.4	-50
110-0239E	pl/cx	25.4	300	112-0215E	pl/cv	25.4	-75
110-0241E	pl/cx	25.4	350	112-0219E	pl/cv	25.4	-100
110-0243E	pl/cx	25.4	400	112-0227E	pl/cv	25.4	-150
110-0247E	pl/cx	25.4	500	112-0231E	pl/cv	25.4	-200
110-0251E	pl/cx	25.4	700	114-0204E	bi/cv	25.4	-25
110-0259E	pl/cx	25.4	1000	114-0208E	bi/cv	25.4	-50
111-0204E	bi/cx	25.4	25	114-0212E	bi/cv	25.4	-75
111-0206E	bi/cx	25.4	30	114-0214E	bi/cv	25.4	-100
111-0208E	bi/cx	25.4	40	114-0220E	bi/cv	25.4	-150
111-0210E	bi/cx	25.4	50	114-0224E	bi/cv	25.4	-200

UV FS Lenses Kits



Large Lenses Kit

Large kit of 40 pcs. UV FS lenses:

Code	Coating	Price, EUR
140-1240-AR210-400	BBAR @ 210–400 nm, R<2%	3490
140-1240-AR350-900	BBAR @ 350–900 nm, R<1.5%	3290
140-1240-AR650-1100	BBAR @ 650–1100 nm, R<1.0%	3310
140-1240-AR532+1064	AR @ 532 + 1064 nm, R<0.5%	3130
140-1240-AR1064	AR @ 1064 nm, R<0.25%	2930
140-1240-AR532	AR @ 532 nm, R<0.25%	2930
140-1240-AR355	AR @ 355 nm, R<0.25%	3030
140-1240-AR266	AR @ 266 nm, R<0.4%	3130

Small kit of 15 pcs. UV FS lenses:

Code	Coating	Price, EUR
140-1215-AR210-400	BBAR @ 210–400 nm, R<2%	1830
140-1215-AR350-900	BBAR @ 350–900 nm, R<1.5%	1660
140-1215-AR650-1100	BBAR @ 650–1100 nm, R<1.0%	1670
140-1215-AR532+1064	AR @ 532 + 1064 nm, R<0.5%	1390
140-1215-AR1064	AR @ 1064 nm, R<0.25%	1320
140-1215-AR532	AR @ 532 nm, R<0.25%	1320
140-1215-AR355	AR @ 355 nm, R<0.25%	1350
140-1215-AR266	AR @ 266 nm, R<0.4%	1380

Small UV FS Lens Kit

Code	Type	Dia, mm	F, mm
110-1203E	pl/cx	25.4	30
110-1205E	pl/cx	25.4	50
110-1209E	pl/cx	25.4	75
110-1211E	pl/cx	25.4	100
110-1216E	pl/cx	25.4	125
110-1217E	pl/cx	25.4	150
110-1219E	pl/cx	25.4	200
110-1223E	pl/cx	25.4	300
110-1233E	pl/cx	25.4	500
110-1245E	pl/cx	25.4	1000
112-1205E	pl/cv	25.4	-50
112-1209E	pl/cv	25.4	-75
112-1211E	pl/cv	25.4	-100
112-1215E	pl/cv	25.4	-125
112-1217E	pl/cv	25.4	-150

Large UV FS Lens Kit

Code	Type	Dia, mm	F, mm
110-1203E	pl/cx	25.4	30
110-1205E	pl/cx	25.4	50
110-1209E	pl/cx	25.4	75
110-1210E	pl/cx	25.4	80
110-1211E	pl/cx	25.4	100
110-1216E	pl/cx	25.4	125
110-1217E	pl/cx	25.4	150
110-1219E	pl/cx	25.4	200
110-1221E	pl/cx	25.4	250
110-1223E	pl/cx	25.4	300
110-1225E	pl/cx	25.4	350
110-1227E	pl/cx	25.4	400
110-1233E	pl/cx	25.4	500
110-1235E	pl/cx	25.4	600
110-1239E	pl/cx	25.4	750
110-1245E	pl/cx	25.4	1000
111-1204E	bi/cx	25.4	25
111-1207E	bi/cx	25.4	40
111-1210E	bi/cx	25.4	50
111-1214E	bi/cx	25.4	75

Code	Type	Dia, mm	F, mm
111-1218E	bi/cx	25.4	100
111-1222E	bi/cx	25.4	150
111-1226E	bi/cx	25.4	200
111-1230E	bi/cx	25.4	250
111-1234E	bi/cx	25.4	300
111-1238E	bi/cx	25.4	400
111-1240E	bi/cx	25.4	500
111-1260E	bi/cx	25.4	1000
112-1205E	pl/cv	25.4	-50
112-1209E	pl/cv	25.4	-75
112-1211E	pl/cv	25.4	-100
112-1217E	pl/cv	25.4	-150
112-1219E	pl/cv	25.4	-200
112-1223E	pl/cv	25.4	-300
114-1204E	bi/cv	25.4	-25
114-1208E	bi/cv	25.4	-50
114-1212E	bi/cv	25.4	-75
114-1216E	bi/cv	25.4	-100
114-1220E	bi/cv	25.4	-150
114-1224E	bi/cv	25.4	-200

RELATED PRODUCTS

Uncoated Lens Kits

See page 1.46



Beam Expanders

See page 6.3



Self-Centring Lens Mounts 830-0010

See page 7.25



Tweezers/Forceps for Optical Components 260-1050

See page A.4



THIN FILM LASER POLARIZERS (56° Angle of Incidence)

Thin film polarizers separate s- and p- polarization components. Due to their high laser damage threshold, thin film polarizers can be used as an alternative to Glan-Taylor laser polarizing prisms or cube polarizing beam splitters.

Nd:YAG Laser Line thin film polarizers are used in high energy lasers. They can be used as extracavity attenuators for Nd:YAG laser fundamental and its harmonics or intracavity Q-switch hold-off polarizers. The most efficient way to use these polarizers is at Brewster's angle – $56 \pm 2^\circ$.

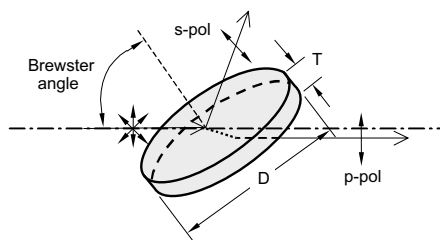

SPECIFICATIONS

Material	BK7, UV FS
Surface quality	20–10 scratch & dig (MIL-PRF-13830B)
Transmitted wavefront distortion	$\lambda/10$ @ 633 nm
Parallelism	<30 arcsec
Clear aperture	>90%
Angle of incidence (AOI)	$56 \pm 2^\circ$
Diameter tolerance	+0.0 -0.12 mm
Thickness tolerance	± 0.2 mm
Laser damage threshold	6 J/cm ² 10 nsec pulse at 1064 nm typical

High Extinction Ratio Polarizers

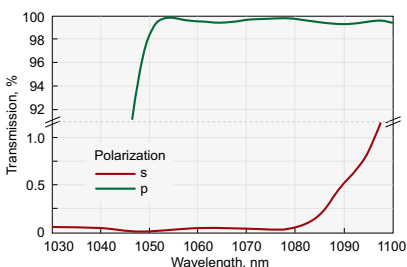

420-1258HE.
 $T_p > 98\%$, $T_s < 0.1\%$

Round Polarizers. Material – UV FS; $T_p > 98\%$, $T_s < 0.1\%$; extinction ratio for transmitted light $T_p/T_s: >1000:1$

Catalogue number	Diameter D, mm	Thickness T, mm	Wavelength, nm	Price, EUR
420-1252HE	25.4	3	355	218
420-1254HE	25.4	3	532	185
420-1258HE	25.4	3	1064	216

Rectangular Polarizers. Material – UV FS; $T_p > 98\%$, $T_s < 0.1\%$; extinction ratio for transmitted light $T_p/T_s: >1000:1$

Catalogue number	Rectangular dimensions Length, mm	Width, mm	Thickness T, mm	Wavelength, nm	Price, EUR
420-1484HE	20	15	6	532	155
420-1584HE	30	20	6	532	210
420-1488HE	20	15	6	1064	165
420-1588HE	30	20	6	1064	220

Ultra High Transmission Thin Film Polarizers

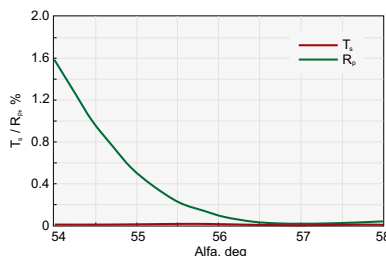

420-1254UHT.
Ultra High Transmission @ 532 nm,
 $T_s < 0.2\%$, $R_p < 0.2\%$, AOI=56°

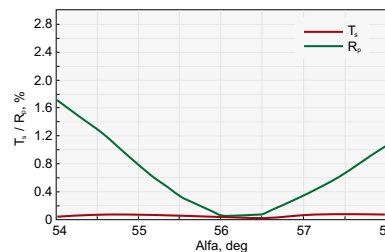

420-1258UHT.
Ultra High Transmission @ 1064 nm,
 $T_s < 0.2\%$, $R_p < 0.2\%$, AOI=56°

Round Polarizers. Material – UV FS; $T_s < 0.2\%$, $R_p < 0.2\%$ ($R_s/T_p > 99.8/99.8\%$)

Catalogue number	Diameter D, mm	Thickness T, mm	Wavelength, nm	Price, EUR
420-1254UHT	25.4	3.0	532	260
420-1258UHT	25.4	3.0	1064	304

High Transmission Thin Film Polarizers

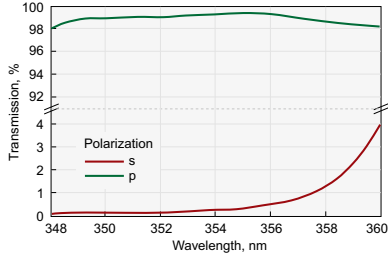

420-1252HT.
High Transmission @ 355 nm
 $R_s/T_p > 99.5/99.0\%$

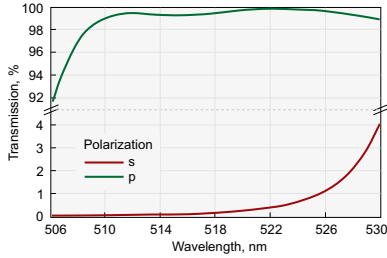

420-1254HT.
High Transmission @ 532 nm
 $R_s/T_p > 99.5/99.0\%$

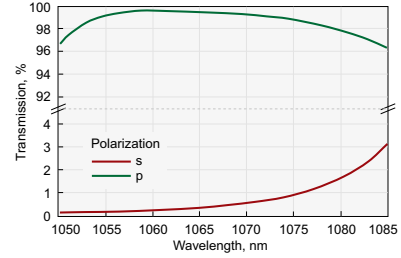

420-1258HT.
High Transmission @ 1064 nm
 $R_s/T_p > 99.5/99.0\%$

Round Polarizers. $R_s/T_p > 99.5/99.0\%$

Catalogue number	Diameter D, mm	Thickness T, mm	Wavelength, nm	Price, EUR
420-1252HT	25.4	3.0	355	237
420-1254HT	25.4	3.0	532	200
420-1258HT	25.4	3.0	1064	234

Rectangular Polarizers. $R_s/T_p > 99.5/99.0\%$

Catalogue number	Rectangular dimensions Length, mm Width, mm	Thickness T, mm	Wavelength, nm	Price, EUR
420-1288HT	28.6 14.3	3.0	1064	270

Standard Thin Film Polarizers

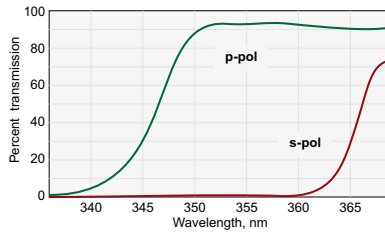

420-1252.
Transmission @ 355 nm, $R_s/T_p > 99.5/95\%$

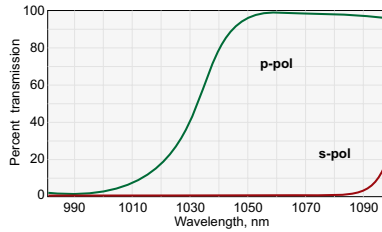

420-1258.
Transmission @ 1064 nm, $R_s/T_p > 99.5/95\%$

Round Polarizers. Material – BK7; $R_s/T_p > 99.5/95.0\%$

Catalogue number	Diameter D, mm	Thickness T, mm	Wavelength, nm	Price, EUR
420-0124E	12.7	3.0	532	108
420-0128E	12.7	3.0	1064	115
420-0254E	25.4	3.0	532	128
420-0258E	25.4	3.0	1064	155
420-0504E	50.8	6.0	532	206
420-0508E	50.8	6.0	1064	255

Round Polarizers. Material – UV FS; $R_s/T_p > 99.5/95.0\%$

Catalogue number	Diameter D, mm	Thickness T, mm	Wavelength, nm	Price, EUR
420-1122E	12.7	3.0	355	164
420-1124E	12.7	3.0	532	131
420-1128E	12.7	3.0	1064	145
420-1252E	25.4	3.0	355	182
420-1254E	25.4	3.0	532	154
420-1258E	25.4	3.0	1064	180
420-1502E	50.8	6.0	355	325
420-1504E	50.8	6.0	532	295
420-1508E	50.8	6.0	1064	315

Rectangular Polarizers. Material – BK7; $R_s/T_p > 99.5/95.0\%$

Catalogue number	Rectangular dimensions Length, mm Width, mm	Thickness T, mm	Wavelength, nm	Price, EUR
420-0284	28.6 14.3	3.0	532	142
420-0288	28.6 14.3	3.0	1064	170

Rectangular Polarizers. Material – UV FS; $R_s/T_p > 99.5/95.0\%$

Catalogue number	Rectangular dimensions Length, mm Width, mm	Thickness T, mm	Wavelength, nm	Price, EUR
420-1282	28.6 14.3	3.0	355	255
420-1284	28.6 14.3	3.0	532	215
420-1288	28.6 14.3	3.0	1064	225

RELATED PRODUCTS

Thin Film Laser Polarizers of other wavelengths
See page 1.54

Glan and Wollaston Prisms
See page 1.61

Adapters for Polarizer at 56°
840-0117,
840-0118
See page 7.43



Variable Attenuator for Nd:YAG linearly Polarized Laser Beam 990-0070
See page 4.21



THIN FILM LASER POLARIZERS (45° Angle of Incidence)

These thin film polarizers separate or combine the s- and p-polarization components at 45° angle of incidence. They are designed for use in high energy lasers. Polarizers are made from UV FS and feature high laser damage threshold reaching 10 J/cm² at 1064 nm.

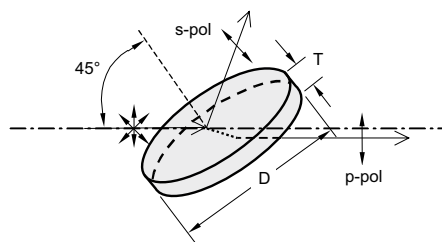

SPECIFICATIONS

Substrate material	UV FS
Surface quality	20-10 scratch & dig (MIL-PRF-13830B)
Transmitted wavefront distortion	$\lambda/10$ @ 633 nm
Clear aperture	>90% of diameter
Angle of Incidence (AOI)	45 ± 2°
Parallelism	<30 arcsec

Thin Film Polarizers with High Extinction Ratio

Round Polarizers. Material – UV FS. $T_p > 98\%$, $T_s < 0.1\%$.
Extinction ratio for transmitted light T_p/T_s : >1000:1

Catalogue number	Diameter D, mm	Thickness T, mm	Wavelength, nm	Price, EUR
420-1252i45HE	25.4	3	355	328
420-1254i45HE	25.4	3	532	295
420-1258i45HE	25.4	3	1064	315
420-1502i45HE	50.8	6	355	640
420-1504i45HE	50.8	6	532	555
420-1508i45HE	50.8	6	1064	620

Standard Thin Film Polarizers

Round Polarizers. Material – UV FS. $R_s / T_p > 99.5 / 95.0\%$.
Extinction ratio for transmitted light T_p/T_s >200:1

Catalogue number	Diameter D, mm	Thickness T, mm	Wavelength, nm	Price, EUR
420-1252i45	25.4	3	355	238
420-1254i45	25.4	3	532	200
420-1258i45	25.4	3	1064	225
420-1502i45	50.8	6	355	455
420-1504i45	50.8	6	532	395
420-1508i45	50.8	6	1064	440

QUARTZ RETARDATION PLATES

Quartz Retardation Plates are made of material enabling linear birefringence. These plates are made of high quality optical grade crystalline quartz, featuring high damage threshold. Retardation

plates rotate polarization's direction ($\lambda/2$) or convert linear into circular polarization or vice versa ($\lambda/4$). Quartz retardation plates are supplied mounted and AR coated.

ZERO ORDER OPTICALLY CONTACTED WAVEPLATES



- Zero Order Waveplates for Nd:YAG fundamental and its harmonics
- Easily aligned
- Temperature insensitive
- Moderately insensitive to wavelength

Ø12.7 mm waveplates, clear aperture Ø11 mm, unmounted

Wavelength, nm	Retardation $\lambda/2$		Retardation $\lambda/4$	
	Catalogue number	Price, EUR	Catalogue number	Price, EUR
1064	460-4205D12	165	460-4405D12	165
532	460-4230D12	165	460-4430D12	165
355	460-4240D12	175	460-4440D12	175
266	460-4245D12	185	460-4445D12	185

Ø20 mm waveplates, clear aperture Ø17 mm, mounted into Ø25.4 mm ring holder

Wavelength, nm	Retardation $\lambda/2$		Retardation $\lambda/4$	
	Catalogue number	Price, EUR	Catalogue number	Price, EUR
1064	460-4205	245	460-4405	245
532	460-4230	245	460-4430	245
355	460-4240	270	460-4440	270
266	460-4245	280	460-4445	280

Zero order plates are comprised of two different plates cut parallel to their optical axis. This construction make plates less dependent on temperature. The plates are polished to different thicknesses enabling to achieve required retardation difference. These component plates have orthogonal optic axis directions, so that the roles of the ordinary and extraordinary rays are interchanged in passing from one plate to another. The thickness of the plate determines the phase shift between the ordinary and extraordinary beams for any specific wavelength.

SPECIFICATIONS

Material	Single crystal quartz
Optical axis	normal to facet on circumference of retarder
Clear aperture	Ø17 mm (other dimensions on request)
Ring mount outer diameter	25.4 +0.0 / -0.12 mm
Nominal thickness of waveplate	1.5–2.5 mm
Surface quality	20-10 scratch & dig (MIL-PRF-13830B)
Wavefront distortion	$\lambda/10$ @ 633 nm
Parallelism	< 10 arcsec
AR coating	R < 0.4%
Damage threshold	> 0.5 J/cm ² , 10 nsec pulse, 1064 nm typical

RELATED PRODUCTS

Zero Order Optically Contacted Plates of other wavelengths	Achromatic Air-Spaced Waveplates
<i>See page 1.64</i>	<i>See page 1.66</i>

ZERO ORDER AIR-SPACED WAVEPLATES

- For high power laser application



Wavelength, nm	AR coating range, nm	Retardation $\lambda/2$		Retardation $\lambda/4$	
		Catalogue number	Price, EUR	Catalogue number	Price, EUR
1064	1035–1095	464-4205	310	464-4405	310
532	515–545	464-4230	310	464-4430	310
355	345–365	464-4240	335	464-4440	335
266	257–275	464-4245	345	464-4445	345
213	210–216	464-4253	420	464-4453	420

SPECIFICATIONS

Material	Single crystal quartz
Optical axis	normal to facet on circumference of retarder
Clear aperture	Ø17 mm
Ring mount outer diameter	25.4 +0.0 / -0.12 mm
Wavefront distortion	$\lambda/10$ @ 633 nm
Surface quality	20-10 scratch & dig (MIL-PRF-13830B)
Parallelism	< 10 arcsec
AR coating	R < 0.5%
Damage threshold	>10 J/cm ² , 10 nsec pulse, 1064 nm typical

RELATED PRODUCTS

Polarizer Holder 840-0180	
<i>See page 7.48</i>	

LOW ORDER WAVEPLATES

- Thickness 0.15–0.35 mm
- Thinner than multiple order

Low order plates are less temperature sensitive and temperature dependent than multiple order plates. These plates are suitable for high and low power applications.

Ø12.7 mm waveplates, clear aperture Ø11 mm, unmounted

Wavelength, nm	Retardation $\lambda/2$		Retardation $\lambda/4$	
	Catalogue number	Price, EUR	Catalogue number	Price, EUR
1064	461-4205D12	105	461-4405D12	105
532	461-4230D12	105	461-4430D12	105
355	461-4240D12	115	461-4440D12	115

Ø20 mm waveplates, clear aperture Ø17 mm, mounted into Ø25.4 mm ring holder

Wavelength, nm	Retardation $\lambda/2$		Retardation $\lambda/4$	
	Catalogue number	Price, EUR	Catalogue number	Price, EUR
1064	461-4205	160	461-4405	160
532	461-4230	160	461-4430	160
355	461-4240	192	461-4440	192

SPECIFICATIONS

Material	Single crystal quartz
Optical axis	normal to facet on circumference of retarder
Clear aperture	Ø17 mm (others dimensions on request)
Ring mount outer diameter	25.4 +0.0 / -0.2 mm
Nominal thickness of waveplate	0.15–0.35 mm
Wavefront distortion	$\lambda/10$ @ 633 nm
Surface quality	20-10 scratch & dig (MIL-PRF-13830B)
Parallelism	< 10 arcsec
AR coating	R < 0.4%
Damage threshold	10 J/cm ² , 10 nsec pulse, 1064 nm typical

RELATED PRODUCTS

Low Order Plates of other wavelengths

See page 1.67

High Precision Rotation Polarizer, Waveplate Mount 840-0186

See page 7.49



MULTIPLE ORDER WAVEPLATES

- Polished to 1-1.5 mm thickness
- Made from a single crystalline plate

Multiple order plates are more dependent on the temperature changes than zero order plates. A change of $\pm 1\%$ from the designed wavelength of multiple order plate can result in difficulties in retardation. Contrary, with zero order plates $\pm 1\%$ and even $\pm 2\%$ change from the designed wavelength can cause only small retardation change.

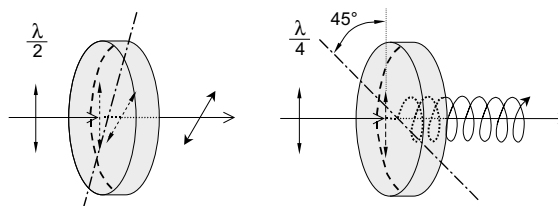

SPECIFICATIONS

Material	Single crystal quartz
Optical axis	Normal to facet on circumference of retarder
Clear aperture	Ø17 mm (others dimensions on request)
Ring mount outer diameter	25.4 +0.0 / -0.2 mm
Nominal thickness of waveplate	0.8–1.5 mm
Surface quality	20-10 scratch & dig (MIL-PRF-13830B)
Wavefront distortion	$\lambda/10$ @ 633 nm
Parallelism	< 10 arcsec
AR coating	R < 0.4%
Damage threshold	10 J/cm ² , 10 nsec pulse, 1064 nm typical

Ø12.7 mm waveplates, clear aperture Ø11 mm, unmounted

Wavelength, nm	Retardation $\lambda/2$		Retardation $\lambda/4$	
	Catalogue number	Price, EUR	Catalogue number	Price, EUR
1064	462-4205D12	90	462-4405D12	90
532	462-4230D12	90	462-4430D12	90
355	462-4240D12	95	462-4440D12	95

Ø20 mm waveplates, clear aperture Ø17 mm, mounted into Ø25.4 mm ring holder

Wavelength, nm	Retardation $\lambda/2$		Retardation $\lambda/4$	
	Catalogue number	Price, EUR	Catalogue number	Price, EUR
1064	462-4205	138	462-4405	138
532	462-4230	138	462-4430	138
355	462-4240	143	462-4440	143
266	462-4245	153	462-4445	153

RELATED PRODUCTS

Multiple Order Plates of other wavelengths

See page 1.68

Adjustable Polarizer Holder of Side Drive 840-0195

See page 7.52



MULTIPLE ORDER DUAL WAVELENGTH WAVEPLATES

- Operate at both first and second Nd:YAG laser harmonics
- Retardation tolerance $\lambda/300$

SPECIFICATIONS

Material	Single crystal quartz
Optical axis	normal to facet on circumference of retarder
Wavefront distortion	$\lambda/10$ @ 633 nm
Clear aperture	$\varnothing 17$ mm
Ring mount outer diameter	25.4 +0.0 / -0.2 mm
Surface quality	20-10 scratch & dig (MIL-PRF-13830B)
Parallelism	< 10 arcsec
AR coating	R < 0.5%
Nominal thickness of waveplate	0.2-1.2 mm
Damage threshold	5 J/cm ² , 10 nsec pulse, 1064 nm typical

Retardation and Wavelength	Catalogue number	Price, EUR
λ @ 1064 nm + $\lambda/2$ @ 532 nm	463-4120	215
λ @ 1064 nm + $\lambda/4$ @ 532 nm	463-4140	215
$\lambda/2$ @ 1064 nm + λ @ 532 nm	463-4210	215
$\lambda/2$ @ 1064 nm + $\lambda/2$ @ 532 nm	463-4220	215
$\lambda/2$ @ 1064 nm + $\lambda/4$ @ 532 nm	463-4240	215
$\lambda/4$ @ 1064 nm + λ @ 532 nm	463-4410	215
$\lambda/4$ @ 1064 nm + $\lambda/2$ @ 532 nm	463-4420	215
$\lambda/4$ @ 1064 nm + $\lambda/4$ @ 532 nm	463-4440	215

POLARIZATION PLANE ROTATORS

- Made of crystalline quartz
- Intended to rotate a beam polarization plane strictly to an appropriate angle using the circular birefringent effect

Compared to a waveplate, a rotator has an intrinsic advantage, being independent of rotation around its own optical axis. It needs no adjustment, only to be installed normal to incident radiation. A polarization plane rotator is normally used for the specific wavelength. It is only slightly dependent on ambient temperature.

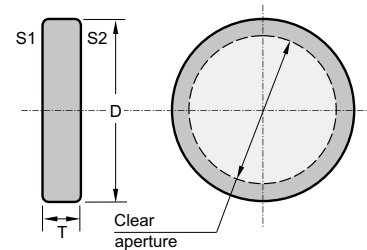

Polarization plane rotators for any wavelength from 200 to 2300 nm are available.

SPECIFICATIONS

Material	Single crystal quartz
Optical axis	Normal to faces S1, S2 of rotator
Clear aperture	17 mm for 20 mm diameter
Ring mount outer diameter	D = 25.4 +0.0 / -0.2 mm
Mount Thickness	T = 6-20 mm (depending on wavelength and rotation angle)
Surface quality	20-10 scratch & dig (MIL-PRF-13830B)
Wavefront distortion	$\lambda/10$
Parallelism	< 10 arcsec
AR coating	R < 0.2% both sides
Damage threshold	5 J/cm ² , 10 nsec pulse, 1064 nm typical

RELATED PRODUCTS

Polarization plane rotators of other wavelengths

See page 1.70

Kinematic Mirror and Beamsplitter Mount 840-0020

See page 7.33



Kinematic Positioning Mount 840-0193

See page 7.51



Catalogue number	Wavelength, nm	Rotation angle of polarization plane, deg	Price, EUR
470-4264	266	45	245
470-4269	266	90	245
470-4354	355	45	195
470-4359	355	90	195
470-4534	532	45	195
470-4539	532	90	195
470-4644	1064	45	215
470-4649	1064	90	215

Please contact us for other size or wavelengths requirements.

VARIABLE ATTENUATOR FOR Nd:YAG LINEARLY POLARIZED LASER BEAM 990-0070



Note: Movable base 820-0090, Rod Holder 820-0050-02 and standard rod should be ordered separately.

- Divides laser beam into two parallel beams of manually adjustable intensity ratio
- Large dynamic range
- Transmitted beam shift ~0.5 mm
- High Optical damage threshold
- Weight – 0.35 kg

This variable attenuator/beamsplitter consists of special design opto-mechanical Adapter and precision opto-mechanical holder 840-0197. Two thin film brewster type polarizers, which reflect s-polarized light while transmitting p-polarized light, are housed into adapter. A quartz multiple order half waveplate is housed in rotating holder 840-0197.

The intensity ratio of those two beams may be continuously varied without alteration of other beam parameters by rotating the waveplate. The intensity of either exit beam, or their intensity ratio, can be controlled over a wide dynamic range. P-

polarization could be selected for maximum transmission, or high-purity s-polarization could be reflected when maximum attenuation of the transmitted beam takes place. The holder 840-0197 allows to adjust angle of incidence of the Thin Film Brewster type polarizers by $\pm 2^\circ$ and to get the maximum polarization contrast.

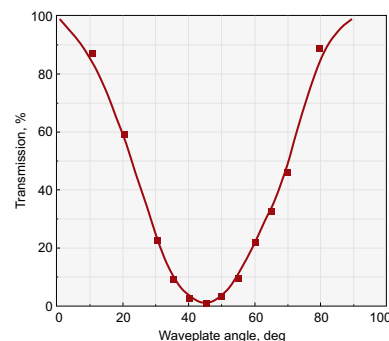
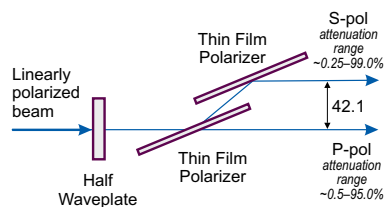

SPECIFICATIONS

Aperture diameter	17 mm
Damage threshold	5 J/cm ² pulsed at 1064 nm, typical
Polarization Contrast (after 1st polarizer)	>1:200
Polarization Contrast (after 2nd polarizer)	>1:500

Catalogue number	Wavelength, nm	Price, EUR
990-0070-266H *	266	1020
990-0070-355	355	750
990-0070-532	532	650
990-0070-1064	1064	650

* With Zero Order Air-Spaced half waveplate.

RELATED PRODUCTS

Neutral Density Filters

See page 1.14

Thin Film Laser Polarizers for Nd:YAG applications

See page 4.15

Motorized Variable Attenuator for Linearly Polarized Laser Beam 990-0070M

See page 6.14



Beam dumps 990-0800, 990-0820

See page 6.21



VARIABLE ATTENUATOR FOR Nd:YAG LINEARLY POLARIZED LASER BEAM 990-0071



Note: Solid Base Height Extender 820-0210 and Standard Rod 820-0020-20 should be ordered separately

- Divides laser beam into separated by 68° angle two beams of manually adjustable intensity ratio
- Large dynamic range
- Transmitted beam shift ~0.5 mm
- High Optical damage threshold
- Weight – 0.25 kg

This variable attenuator/beamsplitter consists of special design opto-mechanical adapter for polarizer at 56° 840-0117A or 840-0118A and precision opto-mechanical holder 840-0197. Thin Film Brewster type polarizer, which reflect s-polarized light at 56° while transmitting p-polarized light, is housed into adapter for polarizer at 56°. Quartz multiple order half waveplate is housed in rotating holder 840-0197.

The intensity ratio of those two beams may be continuously varied without alteration of other beam parameters by rotating the waveplate. The intensity of

either exit beam, or their intensity ratio, can be controlled over a wide dynamic range. P-polarization could be selected for maximum transmission, or high-purity s-polarization could be reflected when maximum attenuation of the transmitted beam takes place. The holder 840-0197 allows to adjust Angle Of Incidence of the Thin Film Brewster type polarizer by $\pm 2^\circ$ and to get the maximum polarization contrast.

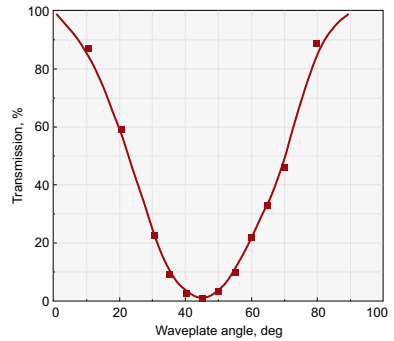
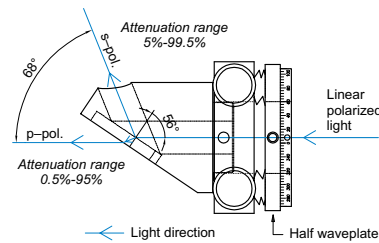

SPECIFICATIONS

Aperture diameter	10 mm
Damage threshold	5 J/cm ² pulsed at 1064 nm, typical
Polarization Contrast	>1:200

Catalogue number	Wavelength, nm	Price, EUR
990-0071-266H *	266	690
990-0071-355	355	475
990-0071-532	532	445
990-0071-1064	1064	445

* With Zero Order Air-Spaced half waveplate.

RELATED PRODUCTS

Motorized Variable Attenuator for Linearly Polarized Laser Beam 990-0071M

See page 6.17



Multiple Order Plates for Nd:YAG applications

See page 4.19

Thin Film Laser Polarizers for Nd:YAG applications

See page 4.15

VARIABLE ATTENUATOR FOR Nd:YAG LASER PULSES 990-0072



- Divides laser beam into two beams of manually adjustable intensity ratio separated by 68° angle
- Large dynamic range
- Transmitted beam shift ~1 mm
- High optical damage threshold
- Motorized version 990-0072M available online

This variable attenuator/beamsplitter consists of Polarizer Holder 840-0190-01 and Kinematic Mirror/Beamsplitter Mount 840-0056-12. UVFS Thin Film Brewster type polarizer diameter 50.8 mm, which reflect s-polarized light while transmitting p-polarized light, is housed into Beamsplitter Mount 840-0056-12. A quartz Multi Order Half Waveplate diameter 25.4 mm housed in rotating holder 840-0190-01 and placed in the incident linearly polarized laser beam.

The intensity ratio of those two separated and different polarized beams may be continuously varied without alteration of other beam parameters by rotating the waveplate. The intensity of either exit beam, or their intensity ratio, can be controlled over a wide dynamic range. P-polarization could be selected for maximum transmission, or high-purity s-polarization could be reflected when maximum attenuation of the transmitted beam takes place.

The holder 840-0056-12 allows to adjust Angle Of Incidence of the Thin Film Brewster type polarizers by $\pm 4.5^\circ$ and to get the maximum extinction contrast. The mounts are on rods, rod holders and Movable Base 820-0090. The optical axis height from the table top can be adjusted in the range 78-88 mm. Other height can be offered as custom changing the standard rods and rod holders into higher.

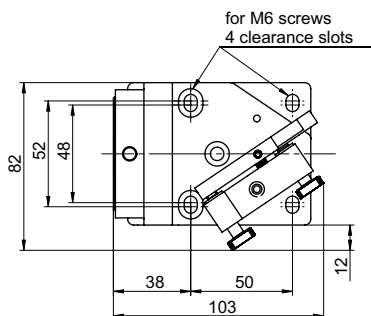
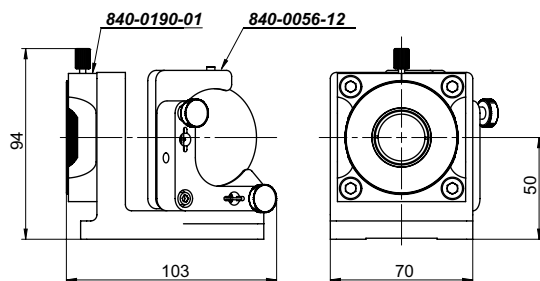
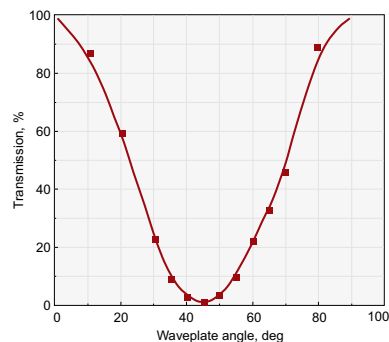

SPECIFICATIONS

Clear Aperture diameter	22 mm
Damage threshold	>5 J/cm ² , 10 ns pulse, 10 Hz at 1064 nm, typical
Polarization Contrast	>1:200
Transmitted beam shift	~1 mm
Weight	0.45 kg

Catalogue number	Wavelength, nm	Price, EUR
990-0072-266H *	266	1085
990-0072-355	355	765
990-0072-532	532	735
990-0072-1064	1064	755

* With Zero Order Air-Spaced half waveplate.

VARIABLE ATTENUATOR FOR Nd:YAG LASER PULSES 990-0073



- Divides laser beam into two beams of manually adjustable intensity ratio separated by 68° angle
- Large dynamic range
- Transmitted beam shift ~1.4 mm
- High optical damage threshold

This variable attenuator/beamsplitter consists of Polarizer Holder 840-0180-A2 and Kinematic Mirror/Beamsplitter Mount 840-0056-13. UVFS Thin Film Brewster type polarizer Ø76.2 mm, which reflect s-polarized light while transmitting p-polarized light, is housed into Beamsplitter Mount 840-0056-13. A quartz Multi Order Half Waveplate Ø40 mm housed in rotating holder 840-0180-A2 and placed in the incident linearly polarized laser beam. The intensity ratio of those two separated and different polarized beams may be continuously varied without alteration of other beam parameters by rotating the waveplate. The intensity of either exit beam, or their intensity ratio, can be controlled over a wide dynamic range. P-polarization could be selected for maximum transmission, or high-purity s-polarization could be reflected when maximum attenuation of the transmitted beam takes place.

The holder 840-0056-13 allows to adjust Angle Of Incidence of the Thin Film Brewster type polarizers by ±4.5° and to get the maximum extinction contrast. The mounts are on rods, rod holders and Movable Base 820-0090. The optical axis height from the table top can be adjusted in the range 92-98 mm. Other height can be offered as custom changing the standard rods and rod holders into higher.

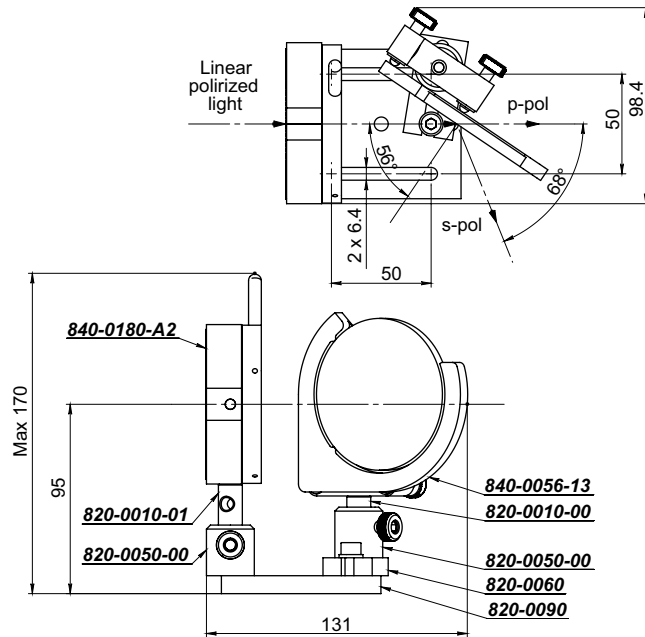
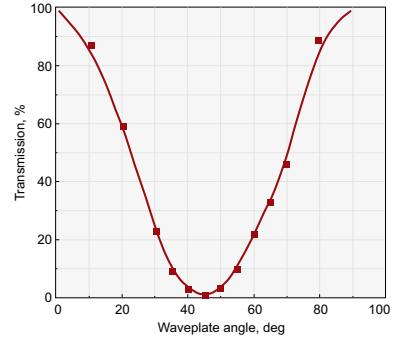

SPECIFICATIONS

Clear Aperture diameter	36 mm
Damage threshold	>5 J/cm ² , 10 ns pulse 10 Hz at 1064 nm, typical
Polarization Contrast	>1:200
Transmitted beam shift	~1.4 mm
Weight	0.6 kg

Catalogue number	Wavelength, nm	Price, EUR
990-0073-266H *	266	1790
990-0073-355	355	1460
990-0073-532	532	1440
990-0073-1064	1064	1515

* With Zero Order Air-Spaced half waveplate.



Nd:YAG Laser Crystals

Nd:YAG CRYSTALS (Standard Rods)



EKSMA OPTICS offers standard specifications high optical quality Nd:YAG rods with high damage threshold AR @ 1064 nm coatings.

SPECIFICATIONS OF STANDARD Nd:YAG LASER RODS

Nd Doping Level	0.8% or 1.1%
Orientation	<111> crystalline direction
Surface Quality	10-5 scratch & dig (MIL-PRF-13830B)
Surface Flatness	λ/10 at 633 nm
Parallelism	< 10 arcsec
Perpendicularity	< 5 arcmin for plano/plano ends
Diameter Tolerance	+0/-0.05 mm
Length Tolerance	+1/-0.5 mm
Clear Aperture	> 90 % of full aperture
Chamfers	0.1 mm at 45 deg
Coating	Both sides coated AR @ 1064 nm, R < 0.2%, AOI = 0 deg
Barrel Grooving	All dia 6.35, 8, 10, 12 mm rods with barrel grooving

Code	Description	Diameter, mm	Length, mm	Doping, %	Wedge of the ends, deg	Coating	Application	Price, EUR
E-Y-3-0.9-A/A	Nd:YAG	3	53	0.9	0/0	AR/AR @ 1064 nm	Generation @ 1064 nm	215
E-Y-3-0.8-A/A	Nd:YAG	3	65	0.8	0/0	AR/AR @ 1064 nm	Generation @ 1064 nm	265
E-Y-3-1.1-A/A	Nd:YAG	3	65	1.1	0/0	AR/AR @ 1064 nm	Generation @ 1064 nm	325
E-Y-4-0.8-A/A	Nd:YAG	4	65	0.8	3/3 parallel	AR/AR @ 1064 nm	Generation @ 1064 nm	530
E-Y-4-1.1-A/A	Nd:YAG	4	65	1.1	3/3 parallel	AR/AR @ 1064 nm	Generation @ 1064 nm	530
E-Y-6.35-1.1-A/A	Nd:YAG	6.35	85*	1.1	3/3 parallel	AR/AR @ 1064 nm	Generation @ 1064 nm	890
E-Y-8-1.1-A/A	Nd:YAG	8	85*	1.1	3/3 parallel	AR/AR @ 1064 nm	Generation @ 1064 nm	1340
E-Y-10-1.1-A/A	Nd:YAG	10	85*	1.1	3/3 parallel	AR/AR @ 1064 nm	Generation @ 1064 nm	2200
E-Y-12-0.8-A/A	Nd:YAG	12	100*	0.8	3/3 parallel	AR/AR @ 1064 nm	Generation @ 1064 nm	4740
E-Y-12-1.1-A/A	Nd:YAG	12	100*	1.1	3/3 parallel	AR/AR @ 1064 nm	Generation @ 1064 nm	4740

* rods with barrel grooving, except 10 mm at both ends of the rod without grooving.

RELATED PRODUCTS

Laser Safety Eyewear
See page 1.17



Visualizator 990-0840
See page 1.17

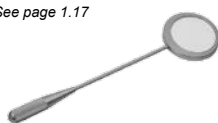

Pockels Cells for Q-Switching
See page 3.3



NONLINEAR CRYSTALS for SHG@1064 nm

LBO crystals

LBO crystals feature the highest damage threshold, small walk-off and have high efficiency. These crystals are the best choice for harmonics generation of relatively high power and high repetition rate Q-switched or mode-locked lasers.

Catalogue number	Size, mm	Orientation		Type	Coating	Application	Price, EUR
		Theta, deg	Phi, deg				
LBO-401	3x3x10	90	11.6	Type 1	AR/AR @ 1064+532 nm	SHG@1064 nm	245
LBO-402	3x3x15	90	11.6	Type 1	AR/AR @ 1064+532 nm	SHG@1064 nm	325
LBO-301	4x4x10	90	11.6	Type 1	AR/AR @ 1064+532 nm	SHG@1064 nm	510
LBO-302	4x4x15	90	11.6	Type 1	AR/AR @ 1064+532 nm	SHG@1064 nm	630
LBO-303	4x4x20	90	11.6	Type 1	AR/AR @ 1064+532 nm	SHG@1064 nm	745
LBO-501	5x5x10	90	11.6	Type 1	AR/AR @ 1064+532 nm	SHG@1064 nm	655
LBO-503	5x5x15	90	11.6	Type 1	AR/AR @ 1064+532 nm	SHG@1064 nm	765
LBO-502	5x5x20	90	11.6	Type 1	AR/AR @ 1064+532 nm	SHG@1064 nm	940
LBO-404	3x3x15	90	0	Type 1	AR/AR @ 1064+532 nm	NCPM SHG@1064 nm, T=149 °C	325
LBO-405	3x3x20	90	0	Type 1	AR/AR @ 1064+532 nm	NCPM SHG@1064 nm, T=149 °C	405
LBO-409	3x3x30	90	0	Type 1	AR/AR @ 1064+532 nm	NCPM SHG@1064 nm, T=149 °C	710
LBO-410	3x3x50	90	0	Type 1	AR/AR @ 1064+532 nm	NCPM SHG@1064 nm, T=149 °C	1300
LBO-304	4x4x10	90	0	Type 1	AR/AR @ 1064+532 nm	NCPM SHG@1064 nm, T=149 °C	510
LBO-305	4x4x15	90	0	Type 1	AR/AR @ 1064+532 nm	NCPM SHG@1064 nm, T=149 °C	630
LBO-306	4x4x20	90	0	Type 1	AR/AR @ 1064+532 nm	NCPM SHG@1064 nm, T=149 °C	745

KTP crystals

KTP crystals feature the highest efficiency and are suited for low average power or CW lasers applications. These crystals are temperature change insensitive and operate with sharply focused or highly divergent laser beams.

Catalogue number	Size, mm	Orientation		Type	Coating	Application	Price, EUR
		Theta, deg	Phi, deg				
KTP-401	3x3x5	90	23.5	Type 2	AR/AR @ 1064+532 nm	SHG@1064 nm	76
KTP-402	3x3x10	90	23.5	Type 2	AR/AR @ 1064+532 nm	SHG@1064 nm	109
KTP-403	4x4x6	90	23.5	Type 2	AR/AR @ 1064+532 nm	SHG@1064 nm	118
KTP-404	7x7x9	90	23.5	Type 2	AR/AR @ 1064+532 nm	SHG@1064 nm	529

DKDP crystals

Large aperture DKDP crystals are used for high energy Q-switched lasers with large beam diameters.

Catalogue number	Size, mm	Orientation		Type	Coating	Application	Price, EUR
		Theta, deg	Phi, deg				
DKDP-401	15x15x13	36.5	45	Type 1	AR/AR @ 1064/1064+532 nm	SHG@1064 nm	485
DKDP-402	15x15x13	53.5	0	Type 2	AR/AR @ 1064/1064+532 nm	SHG@1064 nm	485
DKDP-404	12x12x20	53,5	0	Type 2	AR/AR @ 1064/1064+532 nm	SHG@1064 nm	475
DKDP-405	15x15x20	53,5	0	Type 2	AR/AR @ 1064/1064+532 nm	SHG@1064 nm	579

Please contact EKSMA OPTICS
for special OEM and large volume pricing.

RELATED PRODUCTS

Ovens with thermocontrollers and heaters for different crystal sizes

See pages 2.27–2.30



NONLINEAR CRYSTALS for THG@1064 nm

LBO crystals

Catalogue number	Size, mm	Orientation		Type	Coating	Application	Price, EUR
		Theta, deg	Phi, deg				
LBO-406	3x3x10	42.2	90	Type 2	AR/AR @ 1064+532/355 nm	THG@1064 nm	245
LBO-407	3x3x15	42.2	90	Type 2	AR/AR @ 1064+532/355 nm	THG@1064 nm	325
LBO-508	5x5x15	42.2	90	Type 2	AR/AR @ 1064+532/355 nm	THG@1064 nm	765

DKDP crystals

Catalogue number	Size, mm	Orientation		Type	Coating	Application	Price, EUR
		Theta, deg	Phi, deg				
DKDP-403	12x12x20	59.3	0	Type 2	AR/AR @ 1064+532/355 nm	THG@1064 nm	475
DKDP-406	15x15x20	59.3	0	Type 2	AR/AR @ 1064+532/355 nm	THG@1064 nm	579

NONLINEAR CRYSTALS for 4HG@1064 nm

BBO crystals

Catalogue number	Size, mm	Orientation		Type	Coating	Application	Price, EUR
		Theta, deg	Phi, deg				
BBO-700	7x7x6	47.6	90	Type 1	P/P @ 532/266 nm	SHG@532 nm	925

KDP crystals

Catalogue number	Size, mm	Orientation		Type	Coating	Application	Price, EUR
		Theta, deg	Phi, deg				
KDP-401	12x12x5	76.5	45	Type 1	AR/AR @ 532/266 nm	SHG@532 nm	408
KDP-402	15x15x7	76.5	45	Type 1	AR/AR @ 532/266 nm	SHG@532 nm	480

HOUSING ACCESSORIES

Ring Holders
for Nonlinear Crystals

See page 2.25



Positioning Mount
840-0199 for
Nonlinear Crystal
Housing

See page 2.26



Please visit
www.eksmaoptics.com

- online shopping
- product updates
- company news

ND:YAG LASER OPTICS

ND:YAG LASER AND NONLINEAR CRYSTALS