

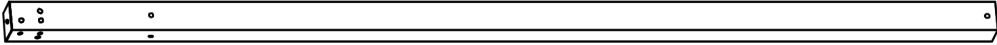









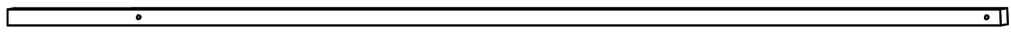
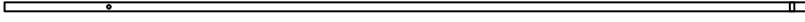

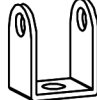
Part#	Image	Qty
1		4
2		4
3		4
4		4
5		8
7		8
8		1
10		4
H ₁	 M6*15	56
H ₂	 M6*30	8
H ₃	 M6*35	8
I		16
J		8
K		2
L		1
M		1
N		4

step01

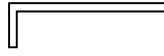
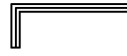
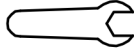
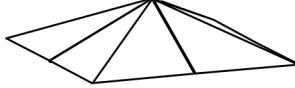

step02

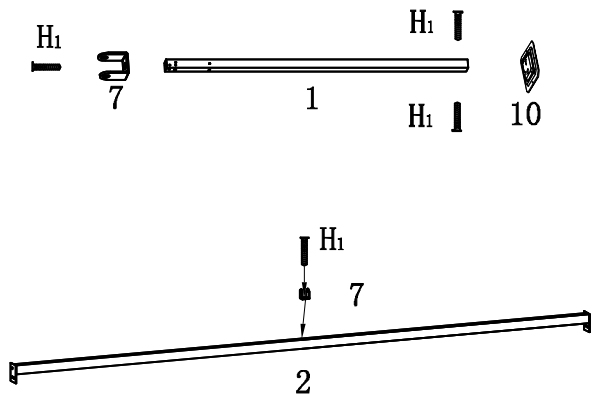
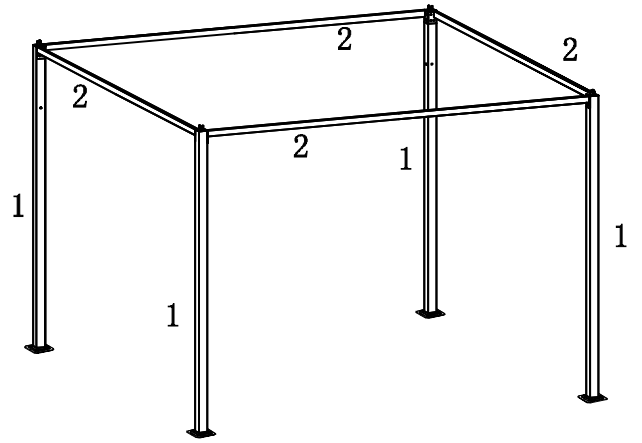

step03

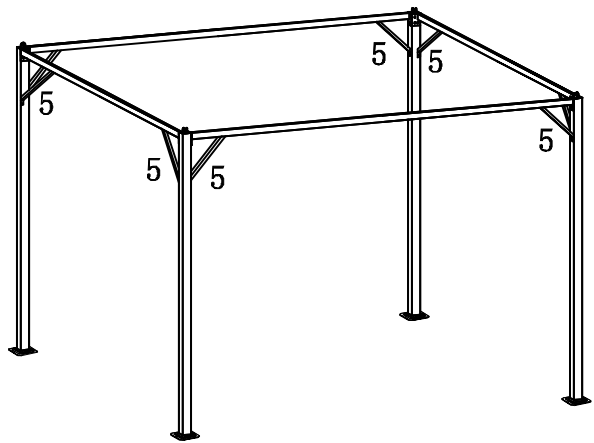

step04

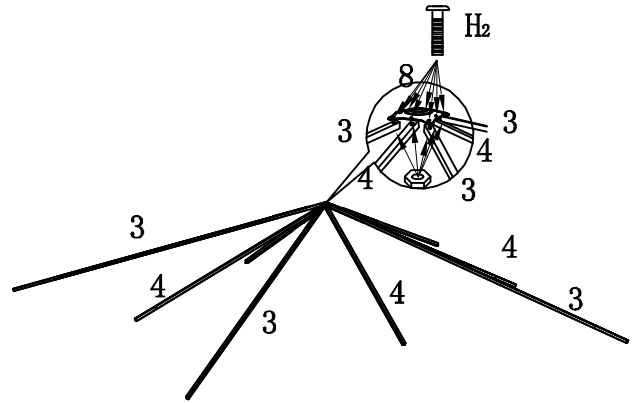

step05

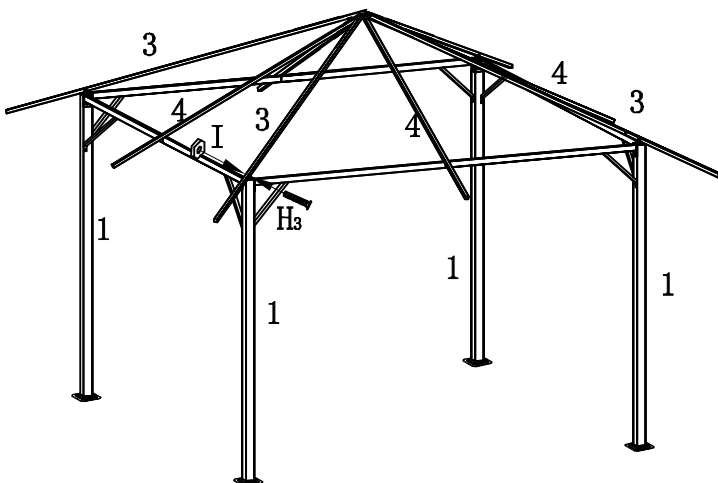

step06

