



**Arrow**  
COUNTY SUPPLIES

Washroom



Skincare



Industrial Wiping



Cleaning Chemicals



Cleaning Equipment



Floorcare



Waste Management



Catering



PPE



**Product Directory**  
2018/19

## HOW TO ORDER:



**01743 283 600**

Call us from 08:30 to 17:00  
Monday to Friday

**Phone**



**shop.arrowcounty.com**

Create an account and use  
our online ordering system

**Online**



**response@arrowcounty.com**

Our response team will deal  
with your orders promptly

**Email**

## ADVISE SUPPLY SUPPORT

It is our aim to provide you with an **excellent range of products** and ensure you receive **outstanding customer service** at all times. **Customer care** is one of Arrow's great strengths, all staff have the same aim and work collectively to achieve this.

### DELIVERY INFORMATION

We design **bespoke delivery solutions** to match your requirements, with pre-scheduled, next-day or same-day arrangements available to meet your needs.

A UK mainland shipping and handling charge of £10.00 will apply to all orders under £75 + VAT.

### REFUNDS & RETURNS

Contact our **Customer Response Team** and provide them with the details of the product you wish to return and the reasons for return. They will then issue the correct paperwork to enable our despatch department to arrange uplift of the goods. If the items have been purchased specifically for you, **goods cannot be returned unless faulty**. A £10 collection fee may be applied, dependent on the reason for the return.

### If you have a query or a discrepancy...

For queries please call us on **01743 283 600** or e-mail us on **response@arrowcounty.com** and it will be dealt with quickly and efficiently. All calls are logged as a service call and you will be provided with a unique reference number for tracking.



## A MESSAGE FROM BRUCE...

At Arrow, we aim to do things differently. We provide exceptional personal customer support as well as our focus on delivering an insight led approach to ensure that we understand the specific needs and objectives of our customers.

We take time to conduct detailed investigations of current operations to help identify potential alternative ways of working or tooling in areas where hygiene and cleanliness is important.

We make it our mission is to inspire cleaning professionals to deliver improvements through innovation, so please get in touch if you would like to find out more on how we can help you.



**Bruce Blackledge**  
Managing Director

## PAGE REFERENCES



**Washroom**  
PAGES 9-28



**Skincare**  
PAGES 29-38



**Industrial Wiping**  
PAGES 39-43



**Cleaning Chemicals**  
PAGES 45-69



**Cleaning Equipment**  
PAGES 71-95



**Floorcare**  
PAGES 97-116



**Waste Management**  
PAGES 117-125



**Catering**  
PAGES 127-133



**PPE**  
PAGES 135-146



**Index, Terms & Conditions**

PAGES 149-153



# THE ARROW WAY

The Arrow Way is our **unique business process** developed and refined through years of experience, ensuring a **superior customer journey**.



## ADVISE

You can rely on us for quality advice and expertise that will help you deliver outstanding results.

We help you review your working methods and tool selection to identify improvements and to help you harness relevant innovations in cleaning and hygiene.



## SUPPLY

You can rely on us to have the right stock, the right products and to deliver your goods on time and in full.

We take pride in offering a highly personal and responsive service to customers that exceeds expectations. Our sustainable, national and international sourcing gives you flexible product choice, competitive pricing and a superior range.



## SUPPORT

You can depend on us to listen to you and take ownership of things to make sure you get the answer and solutions you need.

We invest in our customer relationships and take the time to listen. We work hard to make your life simple and our dedicated Customer Response team handle queries quickly and efficiently, so you can be confident your requirements will be met.

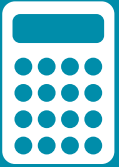

## QUICK QUOTE

Want a comparative price fast? Then our Quick Quote system is for you.

Great advice, great products and a quick response. Get access to over 7,000 products including our Andarta range alternatives for even more savings. Responsive and personalised service.



## ASK ARROW

Find out how you can make the most of your existing cleaning team and budget.

Ask Arrow for great advice on how to reduce cleaning costs, impartial sustainability advice and how to increase your compliance in all aspects of cleaning, price and performance. We compare high performing specialist cleaning products and look at how you can save time and money and give you access to products that can significantly improve hygiene standards.



## INNOVATION IN ACTION

At Arrow, we approach things differently. Our innovation culture aims to bring a fresh perspective to problems and identify new solutions.

'Technology, for the sake of technology' is not our proposition. We research and look into technologies that have the greatest tangible benefits. We can help you harness cleaning innovation and in return you can increase your team's performance and exceed your clients' expectations.



# **OUR UK SUPPLY NETWORK**

Arrow County Supplies is one of the UK's most efficient distributors of janitorial supplies. Our extensive stock holding and advanced logistics systems make sure we have the right products available so you receive all your goods when you expect them. We deliver on our promises so you can keep yours.



## **CENTRAL HUB**

Head Office and National  
Distribution Centre  
Longden Road  
Shrewsbury  
SY3 9AE



## **NORTHERN HUB**

Kinross



## **SOUTHERN HUB**

Leighton Buzzard



**NORTHERN HUB**

**CENTRAL HUB**

**SOUTHERN HUB**



# Introducing Andarta...

Effective, safe, environmentally sustainable and **compliant** cleaning products.

*always*  
**andarta**®  
*products that never cost the earth*

With **forty years of knowledge** of cleaning and hygiene products, it was logical to develop a range of cleaning products that is unbeatable in terms of job-efficiency, cost-effectiveness and eco-friendliness.

We want to make decision making simple for your janitorial and cleaning supplies, no matter what your requirements.

## What does Andarta offer?

There are many other benefits to choosing Andarta for your cleaning and janitorial needs. Andarta products:

- **Always** carefully selected by us to ensure minimal impact to the environment
- **Always** provide high performance at realistic pricing, offering value for money against other premium brands
- **Always** have well designed labelling for clarity of identification and instructions for use
- **Always** guarantee consistent high quality, resulting from our own control over product source

[arrowcounty.com/Andarta](http://arrowcounty.com/Andarta)



# WASHROOM

Products included in this category...



**Toilet Tissue**



**Toilet Roll Dispensers**



**Hand Towels**



**Roll Towel Dispensers**



**Facial Tissues**

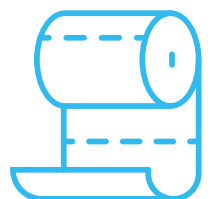

**WASHROOM**



**You can rely on us**  
for quality advice and  
outstanding service that  
ensures you get the best  
return on your cleaning  
and hygiene investment

**Bruce Blackledge**  
Managing Director

# ▶ LOWERING PRODUCT USAGE, RAISING STANDARDS

Everyone wants to lower the cost of providing users with the safest and most hygienic washroom environment. The obvious way to do this is to buy the lowest cost products, however this can be a false economy, as the lowest product price may, depending on washroom use and environment, prove to be a more expensive option.

Cost-in-use is the total cost of washroom provision, which is the total cost of product, maintenance, storage, consumption and waste.

Using the correct washroom systems help to ensure the best cost-in-use.

## ▶ COST-IN-USE... WHAT'S IT ALL ABOUT?

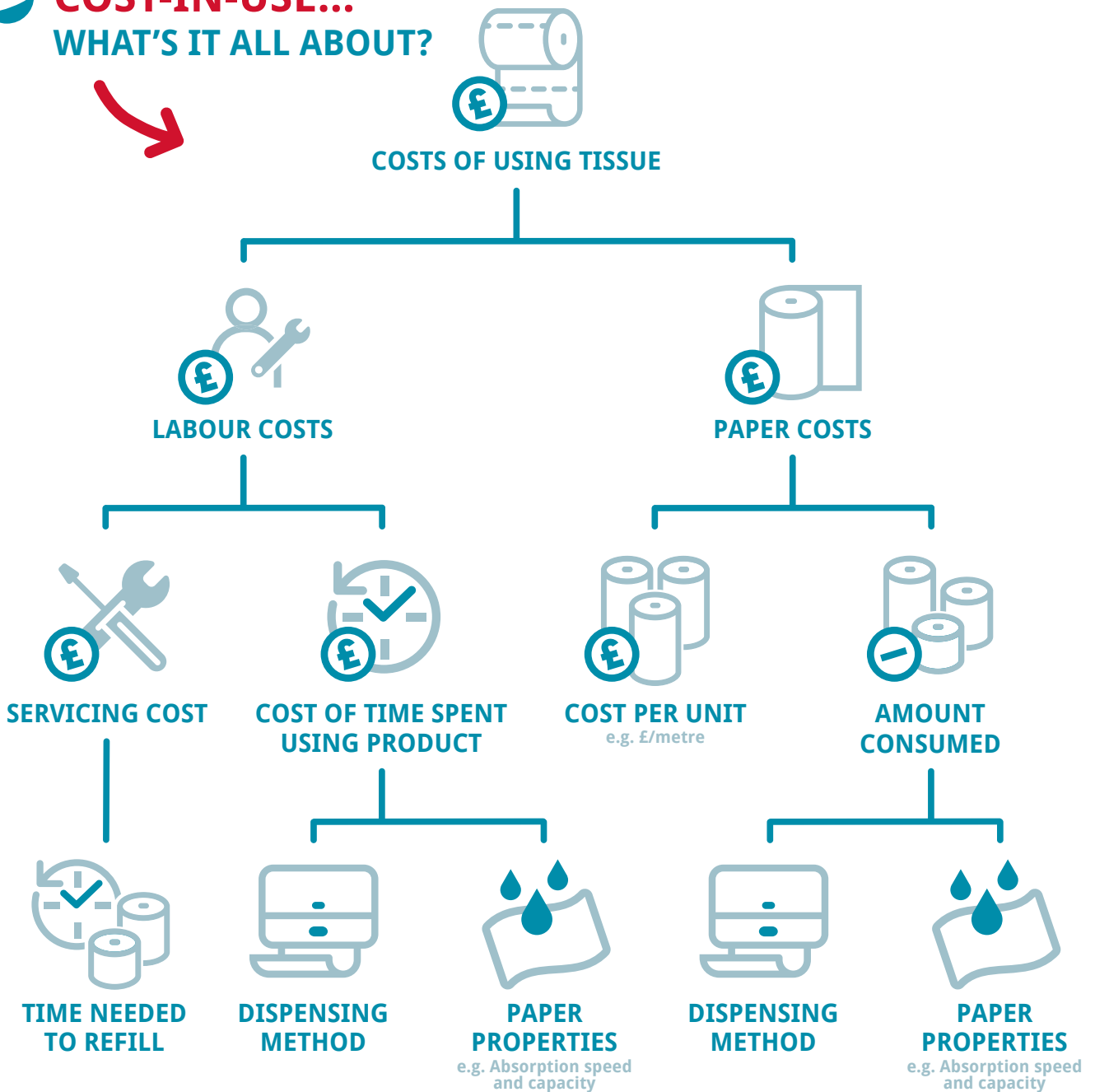



Finest possible quality

**LAMBI SATIN 160 SHEET**

- 3 Ply
- Quilted and embossed
- 100% Virgin fibre
- Nordic Swan accreditation.

01-014 | 3 ply | 24 Rolls |

**£23.99**  
Cost per roll £0.99



**ANDARTA 320 SHEET**

- 2 Ply
- Micro embossed tissue
- Made from recycled tissue

01-002 | 36 Rolls |

**£13.95**  
Cost per roll £0.39



Luxury toilet tissue

**SOFCELL 240 SHEET**

- 2 Ply
- Quality embossed premium tissue
- Strong and absorbent

01-034 | 40 Rolls |

**£15.99**  
Cost per roll £0.40



**STANDARD 200 SHEET**

- 2 Ply
- Embossed
- Made from recycled tissue

01-005 | 36 Rolls |

**£10.99**  
Cost per roll £0.31



**WHISPER**

2 ply luxury toilet tissue. Laminated and micro-embossed for superior softness and strength to deliver a high quality toilet tissue for end users time and again.

- 2 ply
- White
- Grade: Pure Pulp
- Sheets per Roll: 210
- Dimensions: 104mm x 23.1m

01-074 |

**£17.97**  
Cost per roll £0.45

Code	Description	Ply	Sheet	Pack	Pack price	Price/roll
01-014	Lambi Satin	3	160	24	<b>£23.99</b>	<b>£0.99</b>
01-002	Andarta	2	320	36	<b>£13.95</b>	<b>£0.39</b>
01-034	Sofcell	2	240	40	<b>£15.99</b>	<b>£0.40</b>
01-005	Standard	2	200	36	<b>£10.99</b>	<b>£0.31</b>
01-074	Whisper	2	210	-	<b>£17.97</b>	<b>£0.45</b>

ASSOCIATED DISPENSERS/HOLDERS



**METAL LOCKABLE TOILET ROLL HOLDER**

06-004 | 1 |

**£17.49**



**ANDARTA TWIN TOILET ROLL DISPENSER**

06-082 | 1 |

**£17.50**



**ANDARTA PLASTIC BULK PACK DISPENSER**

06-014 | 1 | **£16.99**

**KLEENEX PREMIER 200 SHEET BULK PACK**

- 2 Ply
- Fresh, white and hygienic
- Embossed

01-059 | 24 Packs | **£39.99**



**SCOTT PERFORMANCE 300 SHEET BULK PACK**

- 2 Ply
- 100% recycled
- Soft white tissues

01-058 | 36 Packs | **£47.99**



**ANDARTA 250 SHEET BULK PACK**

- 2 Ply
- Edge embossed to minimise ply separation
- Made from 100% pure tissue - softer and whiter

01-016 | 36 Packs | **£26.65**



**METAL JUMBO / MINI JUMBO DISPENSER**

06-010 | Jumbo | 1 | **£24.49**  
06-011 | Mini Jumbo | 1 | **£21.99**



**PLASTIC JUMBO / MINI JUMBO DISPENSER**

06-029 | Jumbo | 1 | **£16.49**  
06-028 | Mini Jumbo | 1 | **£16.99**



**STAINLESS STEEL JUMBO / MINI JUMBO DISPENSER**

06-035 | Mini Jumbo | 1 | **41.29**  
06-046 | Jumbo | 1 | **79.99**



**ANDARTA JUMBO/MINI JUMBO TOILET ROLL**

01-018	2 ply	150m Mini	12 Rolls	62mm core	<b>£19.50</b>
01-019	2 ply	150m Mini	12 Rolls	76mm core	<b>£19.50</b>
01-017	2 ply	200m Mini	12 Rolls	62mm core	<b>£23.49</b>
01-020	2 ply	200m Mini	12 Rolls	76mm core	<b>£23.99</b>
01-023	2 ply	250m Midi	6 Rolls	76mm core	<b>£14.49</b>
01-025	2 ply	300m Jumbo	6 Rolls	62mm core	<b>£18.99</b>
01-022	2 ply	410m Jumbo	6 Rolls	62mm core	<b>£23.99</b>
01-026	2 ply	410m Jumbo	6 Rolls	76mm core	<b>£23.99</b>



Perfect for poor drainage and reoccurring blockage problems

**KATRIN EASYFLUSH 300 SHEET**

- Made from fast dissolving tissue

01-012 | 2 ply | 20 Rolls | **£14.99**  
Cost per roll £0.75

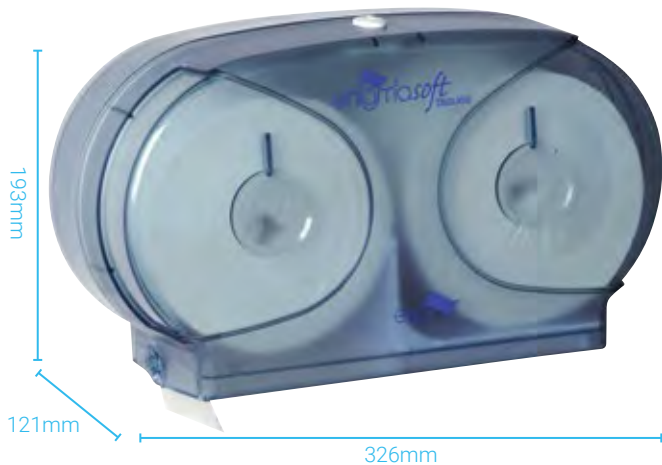

**CORELESS TWIN ROLL DISPENSER**

- Slide mechanism prevents access to the new roll until the original roll is used. No chance of part unused rolls
- Holds two coreless toilet rolls
- Contents can be monitored without opening
- Fully lockable dispenser
- Can be refilled while second roll is in use, so tissue is always available
- Roll remains fully enclosed

06-103 | Up to 1800 sheet capacity | 1 | **£22.99**



**LEONARDO VERSATWIN DISPENSER**

- Slide mechanism prevents access to the new roll until the original roll is used. No chance of part unused rolls
- Twin roll capacity ensures no wastage, all roll is used
- Reduced service times as clear front allows contents to be monitored without opening
- Crimped key lock prevents pilferage
- Dispenser can be refilled during convenient cleaning times
- Roll remains fully enclosed

06-019 | 600 sheet capacity | 1 | **£29.99**



**ANDARTA 2PLY WHITE CORELESS TOILET ROLL**

- 100% pure cellulose, soft, absorbent and micro embossed
- Universal sized inner hole allows use with any coreless dispenser

01-031 | 100m | 900 sheets | 36 Rolls | **£49.99**  
Cost per roll £1.39



**LEONARDO 2PLY VERSATWIN TOILET ROLL**

- 100% recycled paper
- Ecoflower accreditation

01-029 | 125m | 330 sheets | 24 Rolls | **£34.60**

1



**ANDARTA SYSTEM 600 TWIN TOILET ROLL DISPENSER WHITE**

- Slide mechanism prevents access to the new roll until the original roll is used. No chance of part unused rolls
- Combines twin roll high capacity with controlled use
- Reduced service times as clear front allows contents to be monitored without opening
- Fully lockable dispenser
- Can be refilled while second roll is in use, so tissue is always available
- Rolls remain fully enclosed
- Dispenser can be individually branded with company logo or customised design
- Upto 6000 sheet capacity

1 06-105 | White | £22.99

**ANDARTA SYSTEM 600 PLUS 300M TOILET ROLL**

- Virgin fibre base sheet - much whiter and breaks down quicker
- 300m
- 3000 sheets
- Ecoflower accreditation

2 01-066 | 12 Rolls | 3000 Sheets | £37.70  
Cost per roll £3.14

**ANDARTA SYSTEM 600 PREMIUM 2PLY WHITE 200M TOILET ROLL**

- Virgin fibre base sheet - much whiter and breaks down quicker
- 200m
- 2000 sheets
- Ecoflower accreditation

3 01-063 | 12 Rolls | 2000 Sheets | £29.75  
Cost per roll £2.48





**KATRIN CLASSIC 2PLY ECOLOGICAL TOILET ROLL**

- 100% recycled paper
- Certified under Nordic Swan, Eco Label and EU Flower

01-033 | 92m | 800 sheet | 36 Rolls | **£44.99**  
 Cost per roll £1.25



**KATRIN BASIC 1PLY TOILET ROLL**

- Micro embossed

01-041 | 115m | 918 sheet | 36 Rolls | **£40.99**  
 Cost per roll £1.14



**KATRIN PLUS 3PLY TOILET ROLL**

- High quality, soft effective tissue
- Has that little extra in terms of gentleness, absorbency and strength

01-071 | 60m | 500 Sheet | 42 Rolls | **£36.60**  
 Cost per roll £1.02



**KATRIN SYSTEM TOILET ROLL DISPENSER WITH CORE CATCHER**

- Automatic drop-down roll system
- Holds two System toilet rolls
- Contents can be monitored without opening
- Optional lock - with or without key
- Can be refilled while second roll is in use, so tissue is always available
- Roll remains fully enclosed
- Adjustable braking system to help control usage
- Core Catcher

06-121 | Up to 1800 sheet capacity | 1 | **£29.99**





**TORK T6 COMPACT AUTO SHIFT TWIN ROLL DISPENSER**

- New roll automatically falls into position when last sheet of old roll is used
- Holds two T6 toilet rolls
- Semi-transparent window so that contents can be checked without opening
- Optional lock - with or without key
- Can be refilled while second roll is in use, so tissue is always available
- Roll remains fully enclosed
- Small levelling device ensures accurate installation
- Empty cores are collected inside the dispenser preventing cores littering the floor

**1** 06-067 | 1 | **£39.29**

**TORK PREMIUM T6 2 PLY TOILET ROLL**

- 100% recycled paper

**2** 01-050 | 100m | Unperforated | 27 Rolls | **£44.99**  
 Cost per roll £1.67





#### ANDARTA 2PLY WHITE V-FOLD

- Quality embossed towel
- Soft and absorbent - effective balance between cost and performance
- Stable handle – makes it easy to carry two or more bag packages.
- Practical perforation – makes it easy to open the package rapidly.
- Maximum hygiene – the folded paper towel is protected against moisture.
- Multi-purpose – empty bag packages can be used as rubbish bags.
- Low volume of waste – bags can be 100 % recycled.
- Environmental – PE films do not include any plasticisers or heavy metals, do not contaminate ground water, burn residue-free and offer a re-usable energy source.
- Sheet size: 23 x 25cm

02-045 | 3200 Towels |

**£39.99**

Cost per 1000 towels £12.50



**ANDARTA 3PLY WHITE W-FOLD**

- Premium quality, soft and luxurious
- Superior wet strength compared to TAD or Airflex alternatives
- Narrow width - compatible with Kimberly Clark Aqua dispenser
- Sheet size: 20.5 x 34cm

02-057 | 1890 Towels | **£32.99**  
Cost per 1000 towels £17.46



**TORK PREMIUM 2PLY WHITE W-FOLD**

- Premium quality, soft and luxurious
- Through-Air-Dried (TAD) technology provides superior absorbent qualities
- Sheet size: 21 x 34cm

02-035 | 2100 Towels | **£57.18**  
Cost per 1000 towels £27.23



**SCOTT 1PLY WHITE W-FOLD**

- Provides basic drying performance
- Airflex technology gives towel a quality feel
- Sheet size: 21.5 x 31.5cm

02-069 | 3180 Towels | **£57.63**  
Cost per 1000 towels £18.12



**KLEENEX ULTRA SUPER SOFT 3PLY WHITE W-FOLD**

- First-class hand drying performance
- Soft, textile-like feel and appearance
- Sheet size: 21.5 x 31.5cm

02-060 | 2880 Towels | **£85.50**  
Cost per 1000 towels £29.69



**KATRIN CLASSIC 2PLY WHITE W-FOLD**

- Soft, absorbent quality embossed towel
- Soft and absorbent - effective balance between cost and performance
- Sheet size: 23.5 x 34cm

02-023 | 2310 Towels | **£49.99**  
Cost per 1000 towels £21.64

Perfect for tight spaces

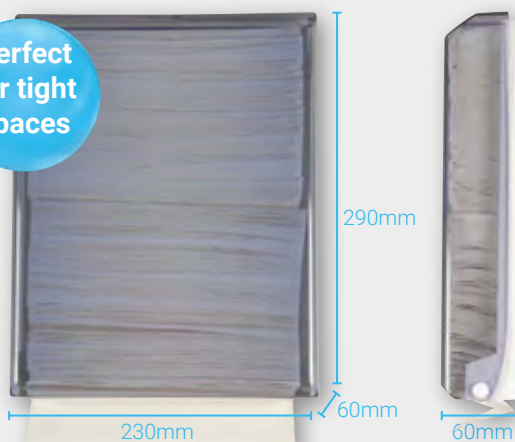

**CLEAR COMPACT HAND TOWEL DISPENSER**

- Slimline dispenser - only 60mm deep

06-040 | Slimline dispenser | 1 | **£19.49**

Specially made for Compact Dispenser that's only 60mm deep - less than half the depth of standard dispensers



**COMPACT TOWEL 1PLY WHITE W-FOLD**

- Regular size towel but interfolded in a compact five-panel style
- Made from strong, absorbent paper
- Sheet size: 20 x 24cm

02-003 | 2400 Towels | **£37.99**  
Cost per 1000 towels £15.83

**ANDARTA 2PLY WHITE Z-FOLD**

- Soft, absorbent quality embossed towel
- Superior wet strength compared to TAD or Airflex alternatives
- Sheet size: 22 x 24cm

**02-043** | 3000 Towels | **£29.99**  
Cost per 1000 towels £9.99

**ANDARTA 1PLY BLUE Z-FOLD**

- Basic performance and good value for money
- 43gsm paper provides superior wet strength
- Sheet size: 22 x 24cm

**02-008** | 3000 Towels | **£24.99**  
Cost per 1000 towels £8.33



Perfect for poor drainage and reoccurring blockage problems

**KATRIN CLASSIC 2PLY WHITE Z-FOLD FLUSHABLE**

- Soft and absorbent
- Will not break up when drying
- Sheet size: 20.6 x 25cm

**02-001** | 3045 Towels | **£41.99**  
Cost per 1000 towels £13.79

**TORK PREMIUM 2PLY WHITE Z-FOLD**

- Premium quality, soft and luxurious
- Through-Air-Dried (TAD) technology provides superior absorbent qualities
- Sheet size: 21 x 25.5cm

**02-027** | 3150 Towels | **£70.49**  
Cost per 1000 towels £13.87



Polythene packaging is 80% less volume of waste than cardboard cartons

**KATRIN PLUS 2PLY WHITE Z FOLD**

- Premium quality, soft and luxurious
- Superior wet strength compared to TAD or Airflex alternatives
- Sheet size: 20.5 x 25.5cm

**02-076** | 2025 Towels | **£24.50**  
Cost per 1000 towels £12.10

**SCOTT 1PLY WHITE Z-FOLD**

- Provides basic drying performance
- Airflex technology gives towel a quality feel
- Sheet size: 20 x 24cm

**02-085** | 4000 Towels | **£41.88**  
Cost per 1000 towels £10.47



Narrow width - compatible with Kimberly Clark Aqua dispenser

**KATRIN CLASSIC 2PLY WHITE Z-FOLD**

- Soft, quality embossed towel
- Soft and absorbent - effective balance between cost and performance
- Sheet size: 20.5 x 25cm

**02-015** | 3360 Towels | **£26.99**  
Cost per 1000 towels £8.03

**Have you thought about upgrading to a roll towel system?**

**See pages 24 - 27 for pictures, information and full range.**



**ANDARTA 1PLY V-FOLD**

- Basic performance and good value for money
- Embossed to improve performance
- Sheet size: 23 x 25cm

<b>02-019</b>	5000 Towels	Blue	<b>£27.99</b>
<b>02-020</b>	5000 Towels	Green	<b>£27.99</b>

Cost per 1000 towels £5.60



Polythene packaging is 80% less volume of waste than cardboard cartons

**KATRIN CLASSIC 2PLY WHITE V-FOLD**

- Easier to handle than cardboard cartons
- Packaging is completely recyclable
- Sheet size: 22.4 x 23cm

<b>02-077</b>	3150 Towels	<b>£35.99</b>
---------------	-------------	---------------

Cost per 1000 towels £11.43



**TORK PREMIUM 1PLY WHITE V-FOLD**

- Premium quality, soft and luxurious
- Through-Air-Dried (TAD) technology provides superior absorbent qualities
- Sheet size: 23 x 23cm

<b>02-071</b>	3000 Towels	<b>£49.99</b>
---------------	-------------	---------------

Cost per 1000 towels £16.66

**Did you know  
80% of common  
infectious  
diseases are  
spread by our  
hands?**

**Effective hand washing  
and drying remains the  
best defence.**



**SCOTT EXTRA 1PLY WHITE V-FOLD**

- Small economy hand towel providing basic performance
- Airflex technology gives towel a quality feel

<b>02-066</b>	4000 Towels	<b>£41.56</b>
---------------	-------------	---------------

Cost per 1000 towels £10.39



**TORK ADVANCED 2PLY WHITE V-FOLD**

- Quality embossed towel
- Soft and absorbent - effective balance between cost and performance
- Sheet size: 23 x 25cm

<b>02-070</b>	3750 Towels	<b>£50.50</b>
---------------	-------------	---------------

Cost per 1000 towels £13.47

## W FOLD

As Z fold but larger i.e 4 panels instead of 3, giving 25% more drying surface per towel.

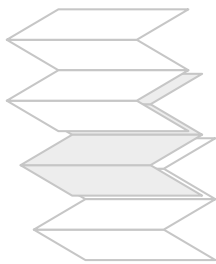

## Z FOLD

Self-presenting towel – the Z fold towel is always ready, clean and untouched.

On dispensing towels are fully open.

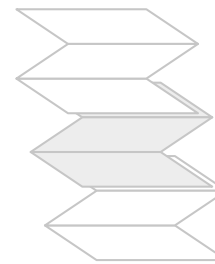

## V FOLD

Self-presenting towel – the V fold towel is always ready, clean and untouched.

On dispensing towels are fully open.

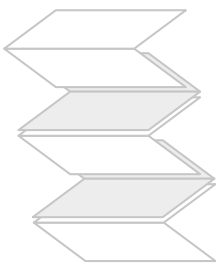

## C FOLD

Towels are dispensed folded and need to be opened before use.

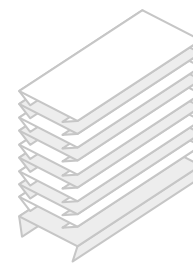
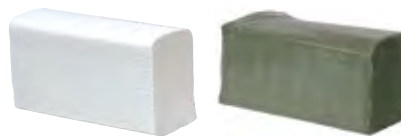

Code	Description	Ply	Sheet	Pack price	Price/1000 Towels
<b>W FOLD</b>					
02-057	Andarta	3ply	1890	£32.99	£17.46
02-060	Kleenex	3ply	2880	£85.50	£29.69
02-035	Tork	2ply	2100	£57.18	£27.23
02-069	Scott	1ply	3180	£57.63	£18.12
02-023	Katrin	2ply	2310	£49.99	£21.64
02-003	Compact Towel	1ply	2400	£37.99	£15.83
<b>Z FOLD</b>					
02-043	Andarta	2ply	3000	£29.99	£9.99
02-008	Andarta	1ply	3000	£24.99	£8.33
02-027	Tork	2ply	3150	£70.49	£22.38
02-001	Katrin Flushable	2ply	3045	£41.99	£13.79
02-076	Katrin	2ply	2025	£24.50	£12.10
02-085	Scott	1ply	4000	£41.88	£10.47
02-015	Katrin	2ply	3360	£26.99	£8.03
<b>V FOLD</b>					
02-045	Andarta	2ply	3200	£39.99	£12.50
02-019/02-020	Andarta	1ply	5000	£27.99	£5.60
02-056	Andarta	1ply	7200	£26.99	£3.75
02-070	Tork	2ply	3750	£50.50	£13.47
02-071	Tork	1ply	3000	£49.99	£16.66
02-077	Katrin	2ply	3150	£35.99	£11.43
02-066	Scott	1ply	4000	£41.56	£10.39
02-025	Katrin	1ply	5000	£35.99	£7.20
<b>C FOLD</b>					
02-002	Andarta Flushable	2ply	2400	£27.99	£11.66
02-011	Andarta	2ply	2430	£26.99	£11.11
02-004/02-005	Andarta	1ply	2880	£20.55	£7.14

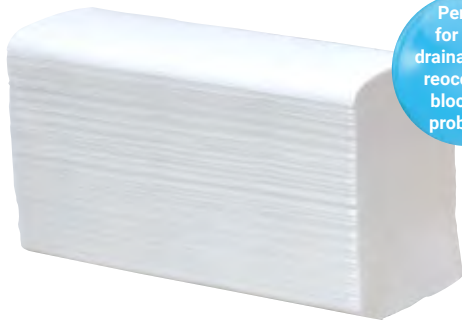

Perfect for poor drainage and reoccurring blockage problems

**2PLY WHITE C-FOLD FLUSHABLE**

- Soft and absorbent
- Will not break up when drying
- Sheet size: 24 x 33cm

**02-002** | 2400 Towels | **£27.99**  
 Cost per 1000 towels £11.66



**ANDARTA 2PLY WHITE C-FOLD**

- Embossed paper maximises absorbency
- Sheet size: 23 x 33cm

**02-011** | 2430 Towels | **£26.99**  
 Cost per 1000 towels £11.11



**ANDARTA 1PLY C-FOLD**

- 43gsm paper provides superior wet strength
- Sheet size: 23 x 33cm

**02-004** | Colour: Green | 2880 Towels | **£20.55**  
**02-005** | 2880 Towels | **£20.55**  
 Cost per 1000 towels £7.14

ALL ANDARTA HAND TOWELS ARE COMPATIBLE WITH THESE THREE DISPENSERS



**STAINLESS STEEL HAND TOWEL DISPENSER**

**06-006** | 1 | **£99.99**



**WHITE METAL HAND TOWEL DISPENSER**

**06-007** | 1 | **£39.99**



**ANDARTA PLASTIC LOCKABLE HAND TOWEL DISPENSER**

**06-025** | 1 | **£19.49**



**ANDARTA SYSTEM 500 ROLL TOWEL DISPENSER**

- Smart Stylish design
- Smooth, discreet dispenser
- Simple to load

06-130 | 1 | £39.99



**KATRIN SYSTEM ROLL TOWEL DISPENSER**

- Smart, stylish design
- Fully upward opening cover makes accessing, refilling and maintenance easy
- Empty cores can be pulled out sideways from the back of the dispenser and recycled
- Transparent housing makes installation simple
- Available in Black or White

06-124 | 1 | White Roll Towel System | £59.95  
 06-122 | 1 | Black Roll Towel System | £59.95



**ANDARTA SYSTEM 500 AUTOCUT 2PLY ROLL**

- 2 ply laminated embossed roll
- ISO 14001 and European Ecolabel accreditation
- Soft and absorbent

04-037 | 160m per roll | 6 Rolls | £61.99



**KATRIN PLUS 2PLY WHITE**

- First-class hand drying performance
- Soft, textile-like feel and appearance
- 100m roll

04-008 | 425 sheets per roll | 6 Rolls | £47.99  
 Cost per 1000 sheets £18.82



**KATRIN CLASSIC 2PLY BLUE**

- Superior wet strength compared to TAD or Airflex alternatives
- Provides outstanding drying performance
- 130m roll

04-011 | 565 sheets per roll | 6 Rolls | £51.44  
 Cost per 1000 sheets £15.17



**KATRIN CLASSIC 2PLY WHITE**

- Superior wet strength compared to TAD or Airflex alternatives
- Provides outstanding drying performance
- 160m roll

04-009 | 680 sheets per roll | 6 Rolls | £61.89  
 Cost per 1000 sheets £15.17



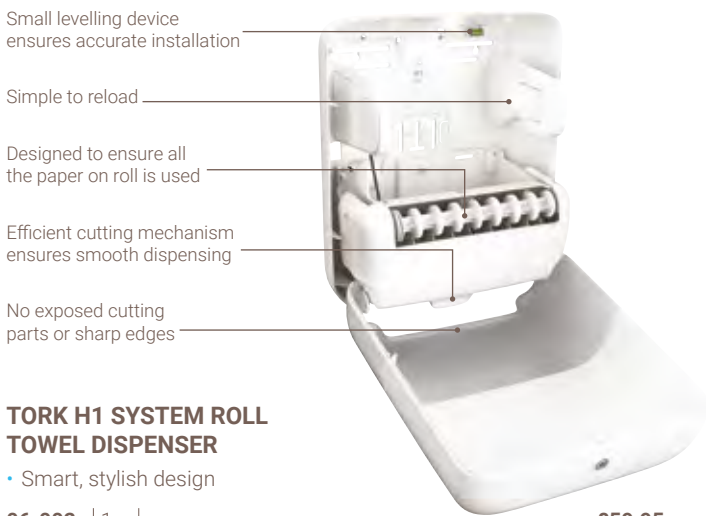

Small levelling device ensures accurate installation

Simple to reload

Designed to ensure all the paper on roll is used

Efficient cutting mechanism ensures smooth dispensing

No exposed cutting parts or sharp edges

**TORK H1 SYSTEM ROLL TOWEL DISPENSER**

- Smart, stylish design

**06-002** | 1 |

**£59.95**

**TORK ADVANCED 2PLY WHITE**

- 2ply Through-Air-Dried (TAD) technology provides superior absorbent qualities
- Provides outstanding drying performance
- 150m roll

**04-013** | 625 sheets per roll | 6 Rolls |

**£89.99**

Cost per 1000 sheets £24.00



**TORK PREMIUM 2PLY WHITE**

- 2ply Through-Air-Dried (TAD) technology provides superior absorbent qualities
- Towel has a thick feel and is highly absorbent
- 100m roll

**04-012** | 408 sheets per roll | 6 Rolls |

**£65.99**

Cost per 1000 sheets £26.96



Extra long roll reduces service frequency

**TORK UNIVERSAL 1PLY WHITE**

- 1 ply Airflex technology gives towel a quality feel
- 280m roll

**04-032** | 1143 sheets per roll | 6 Rolls |

**£69.99**

Cost per 1000 sheets £10.21

**TORK ADVANCED 2PLY BLUE**

- 2ply Through-Air-Dried (TAD) technology provides superior absorbent qualities
- Soft, quality embossed towel
- 150m roll

**04-014** | 625 sheets per roll | 6 Rolls |

**£56.00**

Cost per 1000 sheets £14.93





#### LEONARDO MECHANICAL ROLL TOWEL DISPENSER

- Functional and reliable dispenser

06-083 | 1 |

£59.95



#### LEONARDO COMFORT 2PLY BLUE

- Basic performance and good value for money
- 175m roll

04-021 | 625 sheets per roll | 6 Rolls | £42.99  
Cost per 1000 sheets £11.46

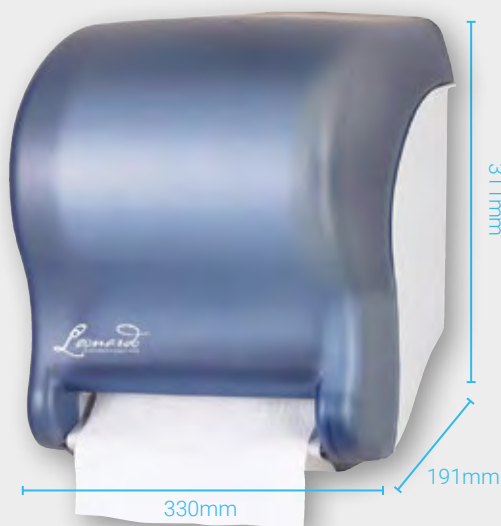

#### LEONARDO COMPACT TEAR & DRY ROLL TOWEL DISPENSER

- Small, compact, space saving towel dispenser
- Battery operated overcomes issues of wet tabbing sometimes associated with mechanical units

06-110 | 1 |

£69.95



#### LEONARDO WORKPLACE 1PLY

- Provides basic drying performance
- 200m roll

04-024 | 715 sheets per roll | 6 Rolls | Colour: Blue | £40.99  
Cost per 1000 sheets £9.55

04-022 | 715 sheets per roll | 6 Rolls | Colour: White | £43.99  
Cost per 1000 sheets £10.25

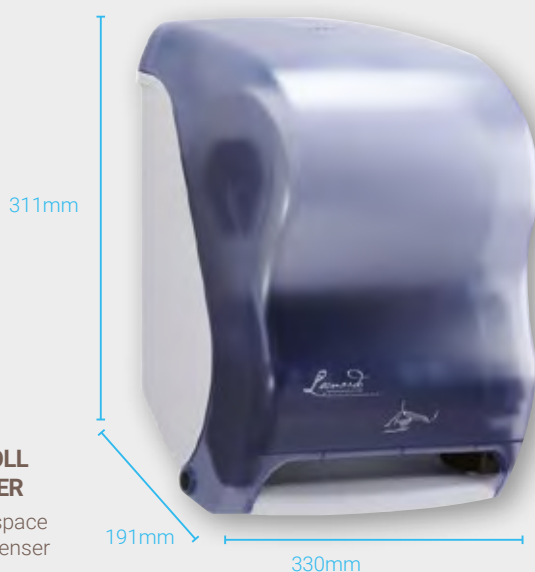

#### LEONARDO COMPACT MECHANICAL ROLL TOWEL DISPENSER

- Small, compact, space saving towel dispenser

06-107 | 1 |

£49.95



#### LEONARDO WORKPLACE 1PLY BLUE

- Provides basic drying performance
- 150m roll
- Fits with 06-110 and 06-107

04-003 | 535 sheets per roll | 6 | £30.75  
Cost per 1000 sheets £9.58



**SCOTT SLIMROLL TOWEL DISPENSER**

- Small, compact, space saving towel dispenser

**1** 06-085 | 1 | **£59.95**

**SCOTT SLIMROLL**

- 1 ply Airflex technology gives towel a quality feel
- 165m roll

<b>2</b> 04-030-BL	700 sheets per roll	6 Rolls	Colour: Blue	<b>£57.70</b>
04-030-WH	700 sheets per roll	6 Rolls	Colour: White	<b>£57.70</b>
Cost per 1000 sheets £13.74				

High capacity for a compact dispenser



HAND DRYERS



**DOLPHIN VELOCITY HAND DRYER SATIN FINISH**

- Quality stainless steel body
- Vandal resistant

05-001 | 1 | £369.00



**AIR FURY HIGH SPEED HAND DRYER SATIN FINISH**

- Ultimate drying solution
- Uses 70% less energy than conventional dryers

05-004 | 1 | £399.00



**FACIAL TISSUE DISPENSER**

- Holds 100 tissues
- Light and simple to load

06-060 | 1 | £19.99



**KLEENEX 100 SHEET FACIAL TISSUES**

- Facial tissues that everybody loves and trusts
- FSC Certified
- Sheet size: 21.5 x 18.6cm

07-014 | 21 Skilletts | £39.99  
Cost per skillet £1.90



**2PLY WHITE 100 SHEET MANSIZE FACIAL TISSUE**

- Soft and luxurious
- Sheet size: 25 x 20cm

07-001 | 24 Skilletts | £33.15  
Cost per skillet £1.38



**ANDARTA LUXURY FACIAL TISSUE 100 SHEET**

- Strong and absorbent tissue
- Sheet size: 20 x 21cm

07-006 | 36 Skilletts | £28.95  
Cost per skillet £0.79



**ANDARTA 2 PLY WHITE 70 SHEET CUBED TISSUE**

- Excellent for preventing the spreading of germs
- Sheet size: 20 x 21cm

07-005 | 24 Skilletts | £18.95  
Cost per skillet £1.38



**2 PLY WHITE 76 SHEET MEDICAL WIPE**

- Soft, strong and absorbent
- Sheet size: 12 x 17.5cm

07-007 | 72 Skilletts | £29.99  
Cost per skillet £0.80

# SKINCARE

Products included in this category...



**Dispensers**



**Hand Soap**



**Barrier Creams**



**Hand Wipes**



**Hand Sanitisers**



**SKINCARE**

A man with short brown hair, wearing a dark suit jacket over a white collared shirt, is sitting at a desk. He is smiling and looking towards the camera. In front of him is a large, professional microphone on a stand. The background is slightly blurred, showing what appears to be an office or conference room setting with a window and some equipment.

**At Arrow we look at the same problems but think differently.**

Our innovation culture brings a fresh perspective to identify new solutions. We don't pretend to always know what the answer is but we do know how to find it. Our structured **'Innovation in Action' programme** helps cleaning professionals deliver excellence in an increasingly challenging environment.

To find out more go and take a look at [www.arrowcounty.com/harness-innovation](http://www.arrowcounty.com/harness-innovation)



**PURELL 350ML LIQUID HAND SANITISER PUMP BOTTLE**

- Promotes infection control by maximising compliance
- Clinically proven to maintain skin health
- Accredited to: EN1500, EN 12791, EN1040, EN 1276, EN 13727, EN 14476, EN1275, and EN14348

08-013 | 1 | **£5.91**



**DEB CUTAN 400ML LIQUID HAND SANITISER PUMP BOTTLE**

- Instant Action
- Disinfects Skin
- Can be used prior to applying gloves
- Accredited to: EN1500, EN1275 and E N 1276

08-069 | 12 | **£84.70**



**TRUST S 450ML ALCOHOL LIQUID HAND SANITISER**

- Non-tainting and food safe
- Built in skin conditioners
- Suitable for use in medical and care services
- Accredited to: EN1276 and EN1500

08-039-450 | 6 | **£29.99**



**PURELL 59ML LIQUID HAND SANITISER PERSONAL ISSUE BOTTLE**

- Promotes infection control by maximising compliance
- Clinically proven to maintain skin health
- Accredited to: EN1500, EN 12791, EN1040, EN 1276, EN 13727, EN 14476, EN1275, and EN14348

08-006 | 1 | **£2.22**



**INSTANT FOAM 47ML PERSONAL ISSUE BOTTLE**

- Instant sanitising action
- Built in skin conditioners

08-021 | 12 | **£35.44**



**SHORT CLIP/COLLAR FOR 59ML BOTTLE**

08-008 | 24 | **£24.99**



**ATTACHING CLIP FOR PURELL BOTTLE**

08-007 | 24 | **£29.99**



**PURELL HOLDER WALL BRACKET**

- Holds 350ml pump bottle (bottle not included)
- Perfect for high-traffic, high-volume applications

15-061 | 1 | **£2.99**



**PURELL METALLIC SANITISING STATION**

- Free standing, movable unit
- Easy to assemble
- Highly visible signage
- Ideal for cafeterias/receptions/restaurants

08-016 | 1 | **£89.99**



Smart, dependable, easy to service

**LTX TOUCH FREE DISPENSER 1200ML**

- Refills are engineered to hold their shape while emptying, for a more attractive appearance
- Recyclable PET cartridge uses 30% less material than standard HDPE
- Large sight window and skylight allow at a glance monitoring
- Lifetime guarantee on dispenser and batteries

15-098	1	Colour: Grey/White	For soap	£25.99
15-099	1	Colour: Grey/White	For Purell	£25.99
15-109	1	Colour: Chrome/Black	For Purell	£25.99
15-115	1	Colour: Chrome/Black	For soap	£25.99

**LTX PURELL FOAM SANITISER**

- Luxurious lather
- Contains moisturisers, natural extracts and conditioners
- Ecolabel Accredited

**08-058** | 2x1.2Ltr | **£47.99**  
 Cost per 100 shots £1.70  
 Doses per cartridge: 1000  
 Dispenser code: 15-099



**LTX FRESHBERRY FOAM HANDWASH**

- Luxurious lather
- Contains moisturisers, natural extracts and conditioners
- Ecolabel Accredited

**10-045** | 2x1.2Ltr | **£30.86**  
 Cost per 100 shots £1.12  
 Doses per cartridge: 1333  
 Dispenser code: 15-098



**LTX ANTIBACTERIAL FOAM HANDWASH**

- Foaming handwash with germ killing power
- Fragrance free
- Accredited to: EN 1499, EN 1276, EN 1040 and EN 13727

**12-026** | 2x1.2Ltr | **£44.99**  
 Cost per 100 shots £1.35  
 Doses per cartridge: 1333  
 Dispenser code: 15-098



**LTX MILD FRAGRANCE FREE FOAM HANDWASH**

- Contains no fragrance or dyes
- Extremely gentle to the skin
- Mild enough for high frequency washing
- Ecolabel Accredited

**11-012** | 2x1.2Ltr | **£39.99**  
 Cost per 100 shots £1.12  
 Doses per cartridge: 1333  
 Dispenser code: 15-098



**LTX PURELL ADVANCED HYGIENIC HAND SANITISER**

- Promotes infection control by maximising compliance
- Clinically proven to maintain skin health
- Accredited to: EN1500, EN 12791, EN1040, EN 1276, EN 13727, EN 14476, EN1275, and EN14348

**08-062** | 2x1.2Ltr | **£47.99**  
 Cost per 100 shots £1.70  
 Doses per cartridge: 1000  
 Dispenser code: 15-099





**EXTREMELY EFFECTIVE IN KILLING A BROAD SPECTRUM OF BACTERIA, FUNGI AND MANY VIRUSES**



**DEB OXYBAC 1LTR TOUCHFREE DISPENSER**

- Ideal for offices/healthcare/food
- Dispensed as a foam, preventing the dripping and splashing associated with using liquid alcohol sanitisers

15-110 | 1 |

£51.94



**DEB OXYBAC 1LTR MANUAL DISPENSER**

- 1 litre capacity
- Push action pump
- Dispensed as a foam, preventing the dripping and splashing associated with using liquid alcohol sanitisers

15-097 | 1 |

£21.67



**DEB INSTANT FOAM SANITISER 1LTR DISPENSER**

- Dispensed as a foam, preventing the dripping and splashing associated with using liquid alcohol sanitisers

08-019 | 1 |

£19.98



**DEB OXYBAC ANTIBACTERIAL FOAM HANDWASH**

- Fast acting
- Reduces cost-in-use through a controlled dosage system
- Meets current national regulations for Biocidal products

11-011 | 6x1Ltr |

£79.13

Cost per 100 shots £0.88  
Doses per cartridge: 1429  
Dispenser code: 15-097



**DEB OXYBAC FOAM WASH**

- Contains accelerated Hydrogen Peroxide, extremely effective on a broad spectrum of bacteria and fungi
- Food safe and fast acting
- Conditions skin

11-014 | 3x1.2Ltr |

£42.88

Cost per 100 shots £0.77  
Doses per cartridge: 1714  
Dispenser code: 15-110



**DEB INSTANT FOAM HAND SANITISER**

- Kills 99.999% of many common germs
- Non-tainting to food
- Does not clog pumps or splash and drip
- Accredited to: EN1500, EN12791, EN1276, EN1275, EN14476 and EN14348:2005

08-020 | 6x1Ltr |

£85.46

Cost per 100 shots £0.83  
Doses per cartridge: 1587  
Dispenser code: 08-019



**DEB 1000 1LTR DISPENSER**

- Large push button
- Measured doses which prevents wastage
- Lockable

15-048 | 1 |

£21.99



**DEB REFRESH RELAX FOAM HANDWASH**

- Luxurious Cedar wood and Patchouli fragrant foam with rich blend of pure essential oils - installs a sense of calm and relaxation
- Contains glycerine skin conditioner to help leave hands soft and supple

10-014 | 6x1Ltr |

£63.20

Cost per 100 shots £0.69

Doses per cartridge: 1429

Dispenser code: 15-048



**DEB REFRESH ENERGIE FOAM HANDWASH**

- Luxurious Citrus and Spice fragrant foam with rich blend of pure essential oils - installs a sense of calm and relaxation
- Contains glycerine skin conditioner to help leave hands soft and supple

10-015 | 6x1Ltr |

£63.20

Cost per 100 shots £0.69

Doses per cartridge: 1429

Dispenser code: 15-048



**FMX MILD FOAM HAND SOAP**

- Contains no fragrance or dyes
- Gentle to the skin
- Mild enough for high frequency washing

11-003 | 3x1.25Ltr |

£33.49

Cost per 100 shots £0.62  
Doses per cartridge: 1785  
Dispenser code: 15-034



**FMX ULTRA SOFT FOAM SOAP**

- Rich, gentle luxury foam handwash
- For general, light duty cleaning
- Pleasant fragrance and colour

10-016 | 3x1.25Ltr |

£34.99

Cost per 100 shots £0.65  
Doses per cartridge: 1785  
Dispenser code: 15-034



**FMX FOAM SOAP DISPENSER**

- Provides more handwashes than liquid soap dispensers
- One hand push operation
- Holds a 1250ml refill for GOJO foam soaps

15-034 | 1 |

£15.49



**FMX ANTI-BAC FOAM HANDWASH**

- Soft, luxurious lather
- Gentle antibacterial formula
- Foaming handwash with germ killing power
- Accredited to: EN 1499, EN 1276, EN 1040 and EN 13727

12-002 | 3x1.25Ltr |

£44.99

Cost per 100 shots £0.72  
Doses per cartridge: 1785  
Dispenser code: 15-034



**FMX PURELL HAND SANITISING FOAM**

- A breakthrough foam formulation
- Enriched with skin conditioners
- Kills 99.99% of most common germs
- Accredited to: EN 1500, EN 14476, EN 1040, EN 13727, EN 1276, EN 1275, EN 1650 and EN 13624

08-047 | 3x1.2Ltr |

£52.49

Cost per 100 shots £1.45  
Doses per cartridge: 1200  
Dispenser Code: 15-034



**LUXURY FOAM HAND WASH**

- Conditions the skin and has a pleasant fragrance
- Contains Aromatherapy extracts

**10-030** | 6x800ml | **£42.99**  
 Cost per 100 shots £0.59  
 Doses per cartridge: 1330  
 Dispenser code: 15-062



**ANTI-BAC FOAM HANDWASH**

- Foam is foodsafe and fragrance free
- No water required, no need for towels
- Kills 99.99% of most common germs
- Alcohol free - effective for longer
- Made to meet food hygiene standards

**12-011** | 6x800ml | **£46.99**  
 Cost per 100 shots £0.59  
 Doses per cartridge: 1330  
 Dispenser code: 15-062



**ANTI-BAC LIQUID SOAP**

- Fragrance free
- Gentle antibacterial formula
- Smooth handwash with germ killing power

**12-022** | 6x800ml | **£46.99**  
 Cost per 100 shots £0.59  
 Doses per cartridge: 1330  
 Dispenser code: 15-062



**INSTANT HAND SANITISER FOAM**

- Foam is foodsafe and fragrance free
- No water required, no need for towels
- Kills 99.99% of most common germs
- Made to meet food hygiene standards
- Alcohol free - effective for longer

**08-035** | 6x800ml | **£54.99**  
 Cost per 100 shots £0.63  
 Doses per cartridge: 1330  
 Dispenser code: 15-066



**INSTANT HAND SANITISER GEL**

- Clinically proven to maintain skin health
- Formula contains skin conditioners

**08-028** | 6x800ml | **£54.99**  
 Cost per 100 shots £1.72  
 Doses per cartridge: 400  
 Dispenser code: 15-063



**SKIN HYGIENE CENTRE BOARD**

- Everything available in the most appropriate location
- Encourages compliance with clear instructions
- 3 Step board - W765 x H500 x D10mm (ex. dispensers)
- Light-weight
- Ideal for busy environments

**15-068** | Each | **£77.49**



**FOAM HANDWASH DISPENSER**

- Install with adhesive or screws
- Made from strong ABS plastic
- Keyless or lockable

**15-062** | 1 x 800ml Dispenser | **£20.99**



**FOAMING HAND SANITISER DISPENSER**

- Install with adhesive or screws
- Made from strong ABS plastic
- Keyless or lockable

**15-066** | 1 X 800ml Dispenser | **£20.99**



**LIQUID HAND SANITISER DISPENSER**

- Install with adhesive or screws
- Made from strong ABS plastic
- Keyless or lockable

**15-063** | 1 | **£20.99**



**DEB 3-STEP SMALL SKIN CARE BOARD PROTECT/RESTORE/LIME**

- Reduces cross contamination and encourages compliance
- Wipe clean surface
- Simple to install
- Size of boards: W1000 x H600 x D10mm (ex. dispensers)

15-015 | 1 | **£52.49**

**DEB 1000 1 LTR DISPENSER - PROTECT**

- Lockable
- Reduces risk of cross-contamination
- Measured dosage every time

15-002 | 1 |



**£28.90**

**DEB 1000 1LTR DISPENSER - RESTORE**

- Lockable
- Measured dosage every time

15-105 | 1 |



**£28.90**

**DEB UNIVERSAL PROTECT SKIN CREAM**

- Proven universal action
- Non-tainting
- Neutral pH formula

09-001 | 6x1Ltr |



**£99.14**

Dispenser code: 15-002

**DEB PURE RESTORE SKIN CREAM**

- Non-greasy formula
- Anti-irritant properties
- Latex and nitrile glove compatible

14-001 | 6x1Ltr |



**£108.13**

Dispenser Code: 15-105

**DEB 2000 2LTR CLEANSE DISPENSER**

- Large push button
- Measured doses which prevents wastage
- Lockable

15-104 | 1 |

**£42.57**



**DEB 4000 4 LTR INDUSTRIAL SOAP DISPENSER**

- Wall-mounted
- Reduces risk of cross-contamination
- Measured dosage
- Lockable

15-010 | 1 |

**£58.50**



**DEB PURE HAND CLEANER**

- Able for use in many areas, including offices, healthcare and food

13-010 | 4x4Ltr |

**£72.68**

13-036 | 4x2Ltr |

**£38.26**

2Ltr Dispenser code: 15-104  
4Ltr Dispenser code: 15-010



**DEB LIME WASH HAND CLEANER**

- Gives a deep-down clean
- Fully biodegradable formula
- Dermatologically tested

13-006 | 4x4Ltr |

**£96.19**

13-033 | 4x2Ltr |

**£50.64**

Dispenser code: 15-010

Dispenser code: 15-104



**DEB CITRUS NATURAL POWER WASH**

- Powerful and versatile action
- Helps prevent water loss from the skin
- The cartridge is sealed during the manufacturing process to protect the product

13-008 | 4x4Ltr |

**£122.99**

Dispenser Code: 15-010



**GOJO HAND MEDIC 150ML**

- Effective in conditioning, protecting and restoring
- Proven results in 14 days
- Can be used under latex gloves
- Non-greasy

14-003 | 12x150ml |

**£48.06**



**GOJO HAND MEDIC CREAM**

- Effective in conditioning, protecting and restoring
- Cartridge can be slotted into the dispenser in seconds
- Non-greasy

14-004 | 6x500ml |

**£40.22**



Dispenser code: 15-037

**IMPERIAL LEATHER  
300ML HAND SOAP PUMP  
BOTTLE**

- Gently cleanses your hands
- Hypoallergenic
- Can be used as a disinfectant and detergent wipe

10-006 | 6x300ml | £20.80



**CAREX 250ML  
ORIGINAL ANTI-  
BAC HAND SOAP  
PUMP BOTTLE**

- Contains a moisturising formulation
- Suitable for all skin types
- Proven to kill 99.999% of bacteria

12-009 | 6 x 250ml | £14.49



**1 LTR STAINLESS  
STEEL BULKFILL  
SOAP DISPENSER**

- Lockable, preventing pilferage
- All steel construction
- Ideal in all public areas, schools and shopping centres
- Compact design

15-040 | 1 x 1Ltr Dispenser | £69.99



**ANDARTA PINK  
PEARL HAND  
SOAP**

- Gives a bountiful lather
- Fresh bouquet fragrance
- Effective as a toilet soap whilst mild enough for general use

10-012 | 5Ltr | £9.67  
Dispenser code: 15-040/15-040



**ANDARTA 250ML  
ANTI-BAC HAND  
SOAP PUMP  
BOTTLE**

- Effectively removes grime and dirt
- Leaves skin feeling soft
- Proven to kill 99.999% of bacteria
- Suitable for all skin types

12-012 | 6x250ml | £7.49



**1 LTR BULKFILL  
SOAP DISPENSER**

- Large push bar allows for easy dispensing
- Easy to mount

15-045 | 1 x 1Ltr Dispenser | £16.45



**ANDARTA  
PEACH HAND  
SOAP**

- Powerful cleaning agent
- Fresh peach fragrance

10-041-2 | 2x5Ltr | £21.75  
Dispenser code: 15-045/15-040



**ANDARTA  
ANTI-BAC  
HAND SOAP**

- Effectively removes grime and dirt
- Leaves skin feeling soft

12-008 | 4x5Ltr | £43.50  
Dispenser code: 15-040/15-045



**BAR SOAP**

- Kind and gentle to the skin

17-001 | 72 Pack | £22.40



**15G GUEST  
SOAP  
BUTTERMILK**

- Kind and gentle to the skin

17-002 | 144 | £15.35



**PILLOW PACK CLEANSING WIPE**

- Re-sealable, handy pouch
- Skin-friendly, solvent free
- Dispenses one wipe at a time

19-015 | 80 per pack | £4.49

**PAL CLEANING AND  
DE-GREASING  
WIPES**

- Quickly removes grease, dirt and grime from hands and surfaces
- Portable resealable tub
- Low alcohol content

19-014 | Tub 200 | £10.85



# INDUSTRIAL WIPING

Products included in this category...



**Centrefeed Rolls**



**Folded Wipes**

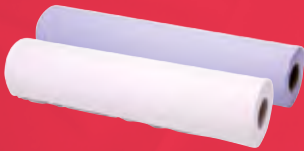

**Wiper Rolls**



**Floorstand Rolls**



**Lockable Dispensers**



**INDUSTRIAL  
WIPING**



**We aim to inspire cleaning professionals** to rethink traditional approaches to improve results and make the most of the budgets available and to ensure you deliver the required standards for hygiene, compliance and sustainability

**Sam Blackledge**  
Customer Insight Director



Perforated roll to help control usage



**WYPALL L10 1PLY AIRFLEX CENTRE FEED**

- Airflex paper which is layered fabric making a strong, thick and highly absorbent product
- Roll width 185mm
- Length: 266m
- Colour: Blue

21-081 | 700 Sheet | 6 Rolls |

**£34.99**

Dispenser Code: 06-101



**ANDARTA 2PLY CENTRE FEED ROLL**

- Embossed with greater surface area for improved absorbency and bulk in the hand
- Roll width 195mm
- Length: 150m

21-007 | White | 6 Rolls

**£23.29**

21-008 | Blue | 6 Rolls

**£23.29**

Dispenser Code: 06-027



**1PLY EXTRA STRONG CENTRE FEED ROLL**

- Extra strong paper provides superior wet strength
- Roll width 180mm
- Length: 150m
- Colour: Blue

21-083 | 6 Rolls |

**£19.99**

Dispenser Code: 06-027



**ANDARTA 1PLY CENTRE FEED ROLL**

- Provides basic performance at low cost
- Roll width 195mm
- Length: 300m

21-002 | Blue | 6 Rolls

**£23.29**

21-004 | White | 6 Rolls

**£23.29**

Dispenser Code: 06-027



**2PLY 65M MINI CENTRE FEED ROLL**

- Embossed with greater surface area for improved absorbency and bulk in the hand
- Roll width 200mm
- Length: 65m
- White

21-005 | 12 Rolls |

**£21.99**

Dispenser Code: 06-026



**ANDARTA PLASTIC CENTRE FEED DISPENSER**

- |        |   |                              |  |
|--------|---|------------------------------|--|
| 06-026 | 1 | For Mini Centrefeed Roll     |  |
| 06-027 | 1 | For Standard Centrefeed Roll |  |
| 06-101 | 1 | For Wypall 21-081            |  |

**£19.99**

**£19.99**

**£44.99**

Can be installed using magnets - ideal for Kitchens



#### TORK PERFORMANCE FOLDED WIPE DISPENSER TURQUOISE

- Holds up to 300 cloths
- Dispenses one sheet at a time
- Semi-transparent window
- Lockable or push button opening

06-080 | 1 |

£30.99



Good oil and water absorption

#### TORK HEAVY DUTY CLEANING CLOTH

- Can be used on multiple surfaces
- Heat Resistant up to 250°C
- Double sided wiper
- Sheet size: 38 x 42cm

24-032 | Blue | 100 Towels |

£43.11

Cost per 100: £0.43  
Dispenser Code: 06-080



Food Contact Approved

#### TORK WIPING PAPER PLUS

- Great for use in kitchens and cafeterias
- 27% Stronger than standard paper, wet or dry
- 2 ply
- Sheet size: 39 x 32cm

24-033 | White | 200 Towels |

£17.99

Cost per 100 sheets £8.99  
Dispenser Code: 06-080



#### TORK PREMIUM HANDY BOX HEAVY DUTY MULTIPURPOSE CLOTH

- Multipurpose cloth for heavier cleaning tasks
- Works with most solvents
- Protects hands from heat and metal scraps
- Sheet size: 38 x 64cm

24-024 | 200 Towels |

£41.60

Cost per 100 £20.80



#### PROFITEXTRA HANDYBOX EMBOSSED CLOTH

- Multipurpose cloth for heavier cleaning tasks
- Works with most solvents
- High wet strength
- Sheet size 41.5x31cm

24-035 | 10x90 Towels |

£149.90

Cost per 100 £16.66



**FLOORSTAND ROLL DISPENSER FOR 27-33CM ROLLS**

- For use with 270 - 330mm roll width

**06-045** | 1 Wallstand | **£49.99**

**ANDARTA 3PLY EMBOSSED FLOORSTAND ROLL**

- Suited for heavier tasks
- Efficient absorption of oil and water
- High wet strength
- Size - W370 x L380mm



**21-022** | 1000 Sheet | 1 Roll | Blue | **£39.99**  
Cost per 1000 sheets £39.99

**ANDARTA 2PLY EMBOSSED FLOORSTAND ROLL**

- Embossed with greater surface area for improved absorbency and bulk in the hand
- Roll width 280mm
- Length: 400m



**21-023** | 1000 sheets per roll | 2 Rolls | Blue | **£37.99**  
**21-049** | 1000 sheets per roll | 2 Rolls | White | **£37.99**  
Cost per 1000 sheets £19.00

**2PLY BLUE FLOORSTAND ROLL**

- Provides basic performance at low cost
- Roll width 280mm
- Length: 400m



**21-021** | 1000 sheets per roll | 2 Rolls | **£26.50**  
Cost per 1000 sheets £13.25

**ANDARTA 2PLY 20" COUCH ROLL**

- Easy tear perforations
- Individually wrapped for improved hygiene

**21-035** | 9 Rolls | 50m | 135 sheets per roll | White | **£33.99**  
**21-037** | 12 Rolls | 40m | 108 sheets per roll | Blue | **£39.99**

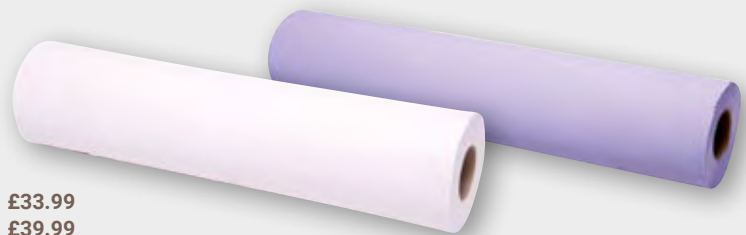

**ANDARTA 2PLY 10" HYGIENE ROLL**

- Easy tear perforations
- Individually wrapped for improved hygiene

**21-031** | 24 Rolls | 40m | 108 sheets per roll | Blue | **£36.25**  
**21-034** | 18 Rolls | 50m | 135 sheets per roll | White | **£33.99**



**METAL ROLL TOWEL DISPENSER**

**06-043** | For 10" Hygiene Roll | 1 | **£25.70**  
**06-047** | For 20" Hygiene Roll | 1 | **£47.99**





**Our innovative thinking will help you unlock operational improvements to increase efficiency, improve standards and improve the return on your cleaning budgets**

# CLEANING CHEMICALS

Products included in this category...



Washroom



Housekeeping



Industrial



Catering



Laundry



CLEANING  
CHEMICALS



**You can depend on us**  
to listen to you and take  
ownership to make sure  
you get the answers and  
solutions you need



# CHOOSING THE RIGHT CLEANING SOLUTION FOR YOU

The huge variety of cleaning chemicals available can make the decision as to which product to use a complicated one. At Arrow, we aim to prioritise your needs - reviewing our portfolio in response to your feedback - to ensure we give you the best range of products. We are excited to demonstrate the new ranges of dose-controlled and concentrated dosing systems that can give you cost-benefits and time-savings, and a whole host of other benefits – Please see below a quick summary and guide to the products within our cleaning chemical category:

## DOSE CONTROL

The best choice for economical, user-friendly multi-surface cleaning



Ultimate dose-controlled cleaning chemical product, reducing wastage and eliminating over-dosing



Greencare® PROFESSIONAL provides unrivalled environmental benefits



Product consolidation options and foam spray action optimise product usage and save money



Ready-dosed, minimal user requirement and controlling dosing



No set-up and convenient belt carrying system improves time management



Foam spray dramatically reduces inhaled chemical fumes

See pages 50 & 51 for the EXCLUSIVE Quick & Easy® range

## CONCENTRATED DOSING

The best choice for large area floor cleaning



Available in 1ltr and 5ltr presentations



All aspects of surface cleaning



Greencare® PROFESSIONAL provides unrivalled environmental benefits



Consolidation to reduce cost



Simple dosing systems allow easy and effective dosing

See pages 48 & 49 for 1-litre and 5-litre concentrate dosing system products

## READY-TO-USE

For all your specialist cleaning needs



Wide range of standard products and specialist solutions



Unique products such as SlipStop® are consumer-lead innovations



The Andarta Eliminator® and tana® PROFESSIONAL products offer specialist cleaning



Greencare® PROFESSIONAL provides unrivalled environmental benefits

See pages 52 - 70 for the wide range of ready-to-use products supplied by Arrow County Supplies

Arrow County Supplies are proud to be the chosen UK Distribution of the pioneering Werner & Mertz Group's tana® and greencare® brands.

*"Each of our brands has its own heritage and personality but they both have sustainable origin as a common basis and embody high performance"*

**Werner and Mertz**



**PROFESSIONAL products ensure reliable, proven performances and are dedicated solution providers**

### Why tana® PROFESSIONAL?

- Proven cleaning performance
- Sustainable roots
- Provides excellent solutions to common cleaning problems
- Safe to use and highly sustainable
- Reliable and highly efficient cleaning products

### Why greencare® PROFESSIONAL?

- Safe for the environment and end user
- Innovations to be become the best in any class
- Top cleaning performance
- Competitively priced
- Full Cradle to Cradle accreditation



#### SANET ZITROTAN

- Sanitary Cleaner
- High Performance
- Natural power of lemon
- Cost effective
- Effectively removes lime scale, soap deposits, water stains and dirt. Provides exceptional cleaning results leaving surfaces free of streaks and clouding and a fresh lemon scent
- Environmentally friendly

33-610 | 1 Ltr | £19.99



#### APESIN KDR FOOD

- The ideal solution for cleaning and disinfection in one step in food processing areas
- Special acidic combination effectively removes grease, protein and dirt
- Effortless removal of limescale, soap deposits as well as all other food processing areas
- Leaves no residues

33-624 | 1 Ltr | £19.99



#### TANET SR15

- Powerful maintenance floor and surface cleaner
- Low use concentration with outstanding cleaning performance with minimal efforts and costs
- Easy, thorough removal of dirt and grease, leaving no streaks
- Environmentally Friendly

33-605 | 1 Ltr | £19.99



#### MANUDISH NEOSMART

- Gentle on the skin and strong degreasing power
- SMART combi power feature combines skin friendliness with strong degreasing power
- Low dosage but achieves uniform results thanks to its high concentration formula
- Easy to rinse
- Integrated SMART dosing system allows flexible and convenient dosing while avoiding direct contact with the product
- Environmentally friendly

33-618 | 1 Ltr | £19.99

#### 5ML DOSING CAP

- Screw on dosing cap for an easy, quick and exact dosing from the 1 Ltr bottle

33-593 | 1 | £2.29







**TANET SR15**

- Powerful maintenance floor and surface cleaner
- Low use concentration with outstanding cleaning performance with minimal efforts and costs
- Easy and thorough removal of dirt and grease, leaving no streaks
- Environmentally Friendly

33-606 | 5 Ltr

£39.99



**SANET ZITROTAN**

- Sanitary Cleaner
- High Performance
- Natural power of lemon
- Cost effective
- Effectively removes limescale, soap deposits, water stains and dirt. Provides exceptional cleaning results leaving surfaces free of streaks and clouding and a fresh lemon scent
- Environmentally friendly

33-611 | 5 Ltr

£39.99



**MANUDISH EXTRALEMOM**

- Cleans and degreases all cookware, cutlery and crockery
- A low dosage achieves uniform results thanks to the high concentrated formula
- Pleasant to use and easy to rinse
- PH Neutral formula is kind to skin

33-641 | 5Ltr

£39.99



**APESIN COMBI DR**

- Disinfects and cleans at the same time
- Quickly and reliably removes all kinds of grease and dirt including high levels of protein even at low temperatures
- Ideal for use in all kitchen and food preparation areas.

33-642 | 5Ltr

£39.99

# PROFESSIONAL CLEANING WITHOUT COMPROMISE

# QUICK & EASY

DISTRIBUTED BY  **Arrow**  
COUNTY SUPPLIES



Automatic dilution activated by product application

Water cartridge refillable everywhere

Large application field



Cradle to Cradle™ is a certification mark licensed by the Cradle to Cradle Products Innovation Institute. Packaging: Silver-Level pending, spray head meets banned list requirements.



DISTRIBUTED BY **Arrow**  
COUNTY SUPPLIES



**TANET INTERIOR QUICK AND EASY**

- The foaming TANET interior Quick and Easy is ideally suitable for cleaning of all water resistant surfaces. This materials friendly universal surface cleaner performs with exceptional cleaning performance. Leaving no streaks, it is also ideally suitable for window cleaning. The product is pleasantly scented.

33-533 | 1 Bottle | **£24.95**



**SANET DAILY QUICK AND EASY**

- SANET daily Quick and Easy is suitable for maintenance cleaning on all acid-resistant surfaces in sanitary areas and bathrooms. The product is particularly suitable for the removal of lime soap and water stains. Thanks to its foaming properties it adheres well to surfaces and leaves a pleasant scent.

33-535 | 1 Bottle | **£24.95**



**APESIN KITCHEN QUICK AND EASY**

- A disinfectant kitchen cleaner to combat bacteria, yeast, enveloped viruses, rotavirus and noravirus in the food area, this highly concentrated formulation is effective at disinfecting and cleaning results is one step. APESIN kitchen Quick and Easy is suitable for hard surfaces in the food area and being CLP-free in application it offers maximum user safety.

33-645 | 1 Bottle | **£24.99**



**TANEX PERFORMA QUICK AND EASY**

- TANEX performa Quick and Easy is ideally suited for use on all plastics and plastic-coated surfaces indoors and out. With its outstanding cleaning performance the foaming power cleaner is the ideal stain remover for all types of adhesive soilings. TANEX performa Quick and Easy is based on biological solvents and leaves a pleasant scent.

33-534 | 1 bottle | **£39.60**



**GREASE OFF**

- The foaming GREASE off Quick & Easy is ideally suitable for cleaning of all water resistant surfaces in food processing areas. With its exceptional cleaning and degreasing performance, it is the ideal universal cleaning solution for all greasy residues. At the same time the product is gentle to surfaces and pleasantly scented.

33-536 | 1 bottle | **£24.95**



**QUICK AND EASY SPRAYHEAD SYSTEM**

- Automatically dilutes Quick and Easy concentrates
- Easy, exact and safe dosing system
- Water cartridge refillable everywhere
- Creates foam so easy to use to ensure improved product utilisation
- No spill lock-and-key system for the attachment of concentrate cartridges

33-539 | **£24.99**

**Find the Quick & Easy belt on page 82**



**MR MUSCLE MULTI TASK BATHROOM CLEANER**

- Cleans effectively
- Streak free shine
- Leaves surfaces sparkling clean

33-445 | 12x500ml

£29.99



**ANDARTA FOAMING BATHROOM CLEANER AND SANITISER**

- Use on baths, sinks, ceramics and enamelled surfaces
- Removes bodyfats and scum
- Clings to vertical surfaces
- Accredited to: EN 1276

33-175 | 6x750ml

£20.99



**FLASH SPRAY CLEAN & BLEACH**

- Cleans away grease and stains
- Highly effectual cleaning action

33-331 | 10x750ml

£44.99



**ANDARTA HARD SURFACE BACTERICIDAL CLEANER (WITH BLEACH)**

- Use on sinks, basins, worktops and ceramics
- Effective sanitiser against bacteria
- Removes mould and soap scum
- Ready to use

33-187 | 750ml

£3.55



**ANDARTA HARD SURFACE BACTERICIDAL CLEANER**

- Used on a variety of surfaces
- Removes grease and grime
- Pleasant smelling
- Accredited to: EN 1276

33-173 | 6x750ml

£19.99



**SANET BR75**

- Swimming Pool and Sanitary Cleaner
- Actively dissolves lime scale deposits, soap, limescale, urine, incrustations, rust and cement residues.
- Safe to use on chrome surfaces.
- Highly effective and very versatile.

**33-613** | 5 Ltr | **£39.99**



**ANDARTA CREAM CLEANER**

- Use on vitreous enamel, stainless steel, chrome, aluminium and laminates
- Removes ingrained dirt
- Cleans and fragrances
- Non-abrasive

**33-111** | 12x500ml | **£19.99**



**ANDARTA 3 IN 1 LEMON SANITISER, DEODOURISER, CLEANER**

- For ceramics, stainless steel, painted, laminated and non-porous surfaces
- Kills odour producing bacteria at source
- Prevents hard water scale accumulation
- Accredited to: BS 6471

**33-120** | 5Ltr | **£14.99**



**SPRINT CREAM CLEANER**

- Lemon rejuvenating cleaning cream
- Effectively removes dirt
- Delivers beautiful shiny results

**33-064** | 12x500ml | **£49.99**

Does not interfere with ph levels in swimming pools



**ANDARTA HEAVY DUTY POOLSIDE CLEANER AND DESCALER**

- Can be used as a maintenance cleaner or a deep clean
- Prevents build up of scale, body fat and scum

33-280 | 5Ltr | £14.99



**ANDARTA SUPERIOR BACTERICIDAL CLEANER AND SANITISER**

- Sanitises and cleans all washable surfaces
- Extremely low hazard rating
- Non-corrosive
- Accredited to: EN1276, EN13704, EN1650, EN14476 and EN14675

33-102 | 5Ltr | £14.79



**ANDARTA SUPERIOR BACTERICIDAL CLEANER AND SANITISER**

- Sanitises and cleans all washable surfaces
- Extremely low hazard rating
- Non-corrosive
- Accredited to: EN 1276, EN13704, EN14476 and EN14675

33-180 | 750ml | £4.41



**FLASH ALL PURPOSE CLEANER**

- Use on sinks, basins, workstops and ceramics
- Effective against bacteria
- May discolour painted and metal surfaces

33-028 | 3x5Ltr | £44.14



**5LTR PELICAN PUMP 20ML DOSE**

33-208 | 1 x Single | £3.99



**25 LTR PELICAN PUMP**

33-204 | 1 | £4.35



**600ML TRIGGER SPRAY BOTTLE**

- Available in colours: BL/-RD/-YL/-WH

33-206 | 1 | £3.99



**1 LTR MEASURING JUG**

33-211 | 1 | £3.99



**ANDARTA APPLE DAILY USE TOILET CLEANER**

- Deodourises stale toilet smells
- Clings longer around the bowl for more thorough action
- Phosphate free

**33-407** | 1Ltr | **£1.80**



**TOILET DUCK FRESH**

- Prevents build up of bacteria
- Powerful foaming and cleaning action
- Phosphate free

**33-341** | 12x750ml | **£39.99**



**ANDARTA EXTRA STRENGTH TOILET CLEANER AND DESCALER**

- Use neat in urinals and toilet bowls
- Removes organics and scale without brushing
- Kills odours at source
- Phosphate free

**33-406** | 1Ltr | **£2.03**



**ANDARTA EXTRA STRENGTH TOILET CLEANER AND DESCALER**

- Stainless steel safe
- Removes limescale and organics without brushing
- Clings longer
- Pleasant floral fragrance

**33-134-2** | 2x5Ltr | **£21.05**



**ANDARTA LEMON FRESH CHANNEL BLOCKS**

- Lasts up to 28 days
- Water soluble - won't block outlets
- Neutralises odours
- Helps control limescale

**33-077** | Tub 3Kg | **£24.99**



**TOILET BRUSH & HOLDER**

<b>1</b>	<b>33-213</b>	1	Enclosed brush	<b>£8.50</b>
<b>2</b>	<b>33-218</b>	1	Open brush	<b>£4.49</b>



**WC GEL**

- Toilet bowl descaler
- Fast and powerful descaler leaving a methol scent after cleaning
- Dissolves persistant deposits and incrustations
- Viscous formulation allows an improved contact time and safe on septic tanks
- Ergonomic bottle ensures fast, direct, easy and safe application

**33-612** | 1Ltr | **£9.99**

**EKOSCREEN URINAL SCREENS**

- Anti-splash urinal screen
- Infused with proprietary resin which times deodorant release technology
- Unique colours and scents
- Lasts up to 60 days
- Ideal for heavy traffic washrooms
- Perfect for waterfree urinals
- VOC compliant

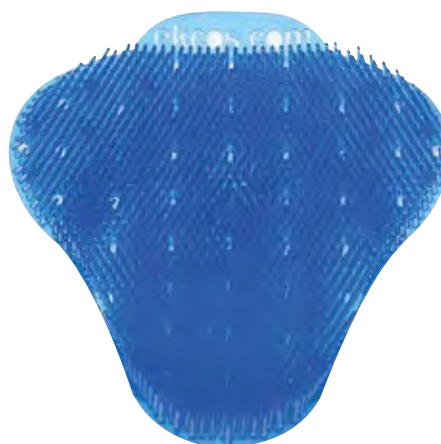

<b>33-603-CL-TF</b>	Tropical Fruit	Pack of 2	Clear	<b>£12.99</b>
<b>33-603-GN-SA</b>	Spiced Apple	Pack of 2	Green	<b>£12.99</b>
<b>33-603-OR-TF</b>	Tropical Fruit	Pack of 2	Orange	<b>£12.99</b>
<b>33-603-PU-BE</b>	Berry	Pack of 2	Purple	<b>£12.99</b>
<b>33-603-PU-LV</b>	Lavender	Pack of 2	Purple	<b>£12.99</b>

# ANDARTA ELIMINATOR®

## How it works

- When the cleaning chemical comes into contact with uric acid (which is what causes bad odours) the **GOOD MICROORGANISMS** are activated, producing enzymes that feed on the offending organic matter present in the pipes and sewerage system.
- These microorganisms reproduce **EXPONENTIALLY** and **INTENSIFY THEIR ACTION** – even where it is not possible to intervene chemically or mechanically.
- The good microorganisms contribute to reducing the bad microorganisms by consuming their food and also contribute to reducing the surfactants released by detergents in drainage pipes.
- Once their action is finished, the **GOOD MICROORGANISMS BIODEGRADE** without leaving residues.

This product can be used to keep pipes clean, and also fight bacteria on washroom surfaces. It does not mask the odours but removes the cause of odours.

Significant results can be seen in an average of 4 weeks.

Consistent use will maintain the results constant in time.

## BIOLOGICAL WASHROOM ODOUR REMOVER AND CLEANER

- Use on porous washroom surfaces
- Non-aggressive chemical
- Degrades organic soiling
- Completely eradicates stains and odours

33-521 | 2x5Ltr |



£33.99

## BIOLOGICAL URINAL BLOCKS

- Removes cause of blockages and odours at source
- Maintains clear odourless pipework
- Creates a pleasant washroom environment
- Degrades organic soiling
- Completely eradicates stains and odours

33-522 | 1.1Kg |



£18.99

## DEODOURISER AND STAIN REMOVER

- Removes stains and odours on carpets, upholstery, clothing and concrete
- Natural enzymes dissolve smell
- Vanilla fragrance

33-523 | 750ml |



£7.29

## BIOLOGICAL WASHROOM ODOUR REMOVER AND CLEANER

- Use on porous washroom surfaces
- Non-aggressive chemical
- Degrades organic soiling
- Completely eradicates stains and odours

33-524 | 6x750ml |



£38.99



**T-CELL AIR FRESHENER**

- Air care system to create a fresh environment
- Ideal for washrooms, restaurants, offices etc
- Delivers fresh fragrance continuously for 60 - 90 days

<b>33-950</b>	Sweet Lavender & Mandarin	1x Starter Kit	<b>£30.90</b>
<b>33-655</b>	Polar Mist	6x Fragrance Re-fills	<b>£53.46</b>
<b>33-656</b>	Blue Splash	6x Fragrance Re-fills	<b>£53.46</b>



**ANDARTA SYSTEM 100 AUTO AIR FRESHENER UNIT**

- Timed and controlled spray frequency
- Day/night operation options
- Use with refill fragrance cans

<b>33-168</b>	Starter Kit	1	<b>£54.95</b>
<b>33-172</b>	Unit Only	1	<b>£43.12</b>



Starter Kit includes:  
 1 x Dispenser  
 4 x Aerosols  
 2 x D Batteries  
 Lasts up to 4 months

**ANDARTA SYSTEM 100 AIR FRESHENER REFILL**

<b>33-270</b>	Vanilla	280ml	<b>£4.75</b>
<b>33-270-LV</b>	Lavender	280ml	<b>£4.75</b>
<b>33-270-FF</b>	Forest Fruits	280ml	<b>£4.75</b>
<b>33-270-CT</b>	Citrus	280ml	<b>£4.75</b>



**FEBREZE AIR FRESHENER SPRAY COTTON FRESH**

- Eliminates tough odours

<b>33-416</b>	6x300ml	<b>£29.99</b>
---------------	---------	---------------



**ANDARTA AIR FRESHENER AEROSOL**

- Re-odourises and freshens
- Will not stain fabrics

<b>33-149</b>	Springtime	12x400ml	<b>£24.99</b>
<b>33-150</b>	Alpine Air	12x400ml	<b>£24.99</b>



**SHADES SOLID GEL AIR FRESHENER**

- 2 in 1 fragrance and odour neutraliser
- Provides continuous freshness and fragrance

<b>33-088</b>	12x190g	<b>£18.30</b>
---------------	---------	---------------



**ANDARTA CITRUS HIGH POWER AIR FRESHENER AEROSOL**

- Eliminates odours, rather than masking them

<b>33-165</b>	6x750ml	<b>£41.05</b>
---------------	---------	---------------



**BLEACH**



**DOMESTOS BLEACH**

- Prevents limescale
- Kills germs including Salmonella, Listeria and E.Coli
- Thick formulation clings for lasting protection

33-029-2	8x 2Ltr	£36.78
33-095	9x750ml	£23.12



**ANDARTA 5% BLEACH**

- Unique patented formula that kills bacteria in normal use at normal dilution rates
- An innovative blend of surfactants incorporating a viscosity modifier and bactericidal agent
- Kills odours at source

33-113	5Ltr	£3.50
--------	------	-------



**ANDARTA FRAGRANCED THICK BLEACH**

- Removes slime and mould
- Kills odours at source
- Pot pourri fragrance

33-117	2x5Ltr	£15.00
33-118	6x750ml	£12.99



**THICK BLEACH**

- Thick formulation
- Kills odours at source

33-432	4x5Ltr	£18.46
--------	--------	--------

**CHLORINE TABLETS**



**ANDARTA CHLORIDE CLEAN TABLETS**

- Active ingredient: Troclosene Sodium (NaDCC)
- Accredited to: EN1276:2009
- Tablet also contains a foaming Anionic Surfactant
- Available chlorine per tablet: 1grm

33-001	Tub 200	£14.45
--------	---------	--------

**DISINFECTANT**



**MILTON DISINFECTANT**

- Can be used in multiple areas
- Kills bacteria, fungi and viruses in 15 minutes
- Accredited to: EN1275, EN1276, EN13697 and NFT72180

33-024	2x5Ltr	£43.65
--------	--------	--------



**ANDARTA PINE DISINFECTANT AND DEODOURISER EMULSION**

- Ideal for sick rooms and nursing homes
- Effective against MRSA
- Kills odours at source

33-115	2x5Ltr	£22.45
--------	--------	--------



**ANDARTA PINE DISINFECTANT**

- Use on floors, walls and drains
- Kills odours
- Effective against a number of diseases
- Conforms to BS6471 & QAP 30

33-114	5Ltr	£3.99
--------	------	-------



### PLEDGE FURNITURE POLISH NATURAL

- For sealed wood surfaces

33-063 | 12x400ml |

£40.75



### ANDARTA MULTI PURPOSE POLISH AEROSOL

- Long lasting water repellent formula protects surface
- Builds deep gloss on all furniture

33-143 | 480ml |

£3.05



### BRASSO BRASS POLISH

- For use on brass, copper, pewter and chrome

33-099 | 8x175ml |

£36.60



### ANDARTA MULTI PURPOSE POLISH

- Builds deep gloss
- Water repellent formula protects surface.

33-178 | 750ml |

£7.49



### INOXOL PROTECT

- Protection spray for stainless steel
- Cleans stainless steel to bring back its shine and remove watermarks, dust, finger marks etc
- Creates a hydrophobic film to repel water splashes
- Only a small amount of product is needed per application

33-639 | 500ml |

£14.99



### MR MUSCLE MULTI SURFACE CLEANER

- Kills 99.9% of bacteria
- High capacity and versatile

33-258 | 6x750ml |

£39.99



### ANDARTA ELIMINATOR® GLASS, MIRROR AND VDU CLEANER

33-110 | 2x5Ltr

£29.99

33-179 | 750ml |

£3.49



### INOXOL CLEAN

- Stainless steel cleaner
- Exceptional cleaning due to the highly efficient formula
- Dissolves lime, incrustated soil, rust, grease and oily soiling
- For use on metal surfaces

33-640 | 1Ltr |

£19.99

# ANDARTA **ELIMINATOR**®

- Multi-purpose cleaner that lifts and removes greasy soils.
- Works by softening and solubilising oils and hardened fats.
- Breaks through the performance barrier whilst still utilising naturally derived ingredients.



### Where can I use this product?

- Cuts through general dirt, grime and vegetable matter found in places such as kitchens.
- Can be used as a floor cleaning solution, laundry prewash, carpet spotter and vinyl cleaner.
- Safe to use on granite, limestone and marble when diluted according to directions.
- Removes baked on food deposits that normally require caustics or solvent based cleaners.
- Finger marks on walls or painted surfaces – wipe it, brush it or foam apply it.



### Environmentally friendly

Have you ever used a strong degreasing cleaner or spray and wipe cleaner and nearly been bowled over with the fumes? These fumes are usually "glycol ether" or "petroleum distillate" solvents or fumes from free caustic.

This can never happen with **ELIMINATOR** because all the natural ingredients are safe from harsh irritants to the skin, as well as being more biodegradable than petroleum products.

**ELIMINATOR** contains no artificial preservatives, colouring or perfume that would slow biodegradability.

*It is a neutral ph cleaner.*

### How it works

Orange oil solvent (D-Limonene), pine and sugar alcohol softens and solubilises oily soils; even hardened fats are lifted effectively.

General dirt, grime and vegetable matter are dislodged from surfaces by detergent when assisted by mopping or wiping.

Water softening properties help the detergent work better by keeping oil in suspension, to make easy rinse clean away - no phosphates, EDTA's or NTA's are used.



### ELIMINATOR SPOT & STAIN REMOVER DEGREASER

- Powerful and amazingly versatile for all tough spot cleaning tasks

33-386 | 750ml |

£7.49



### ELIMINATOR MULTI PURPOSE CLEANER & DEGREASER

- A powerful dilutable cleaner and degreaser
- Ideal for carpet stain removal and hard surface cleaner
- Powerful degreasing agents, ideal for kitchen cleaning
- All natural ingredients, breaks down deposits

33-428 | 2x5Ltr |

£33.99



**ANDARTA CARPET DEFOAMER**

- Approval of: EU Detergent Directive 2005 D 2004/648/EC.
- For carpet hot water extraction machine recovery tanks
- Prevents pumps and pipelines from clogging with foam

33-107 | 2x5Ltr |

£49.99

**ANDARTA CARPET CLEANER DETERGENT**

- Pleasant fragrance
- Use in hot water extraction machines
- Use on woven or non-woven carpets of natural or synthetic fibres and upholstery fabrics

33-109 | 5Ltr |

£9.17



**SELFREEZE GUM REMOVER AEROSOL**

- Use on carpets fabrics and hard floors
- Performance is best on sticky residues rather than hardened deposits
- Rapidly freezes deposits which can then be scraped off

33-141 | 300ml |

£9.60



**LIQUID CHEWING GUM REMOVER**

- Use on all types of carpets and soft furnishings
- Removes Blu-tack
- Pocket size bottle
- Approvals: British Coal Industry Assessment No: 8155, Scientifics Approved UK Rail Cat No: 007/5000059

33-005 | 12x100ml |

£39.75



**CARPET SPOT AND STAIN REMOVER**

- Use on carpets, upholstery, and all coloursafe, washable fabrics including wool
- Apply as a single solution or use as pre-spray prior to extraction cleaning

33-183 | 6x750ml |

£23.99



**ANDARTA HARD SURFACE CLEANER**

- Cleans walls and floors
- Removes grime and dirt
- Controlled foam

33-219 | 5Ltr | £19.99



**FORCE CITRUS HEAVY DUTY MULTI-PURPOSE CLEANER**

- Powerful and versatile
- Suitable for most washable hard surfaces
- Citrus fragrance

33-344 | 2x5Ltr | £26.92



**ANDARTA INDUSTRIAL MAINTENANCE CLEANER**

- Powerful cleaning action
- Dissolves fats, blood stains and shortenings
- Highly concentrated and economical in use

33-128 | 2x5Ltr | £22.99



**PLASTIC SAFE GRAFFITI REMOVER**

- For solvent sensitive surfaces - plastics, laminates
- Can be used on porous and non-porous surfaces

33-147 | 500ml | £5.45



**FULL POWER GRAFFITI REMOVER**

- Not for solvent sensitive surfaces, - metal, brick, concrete, stone
- Breaks up graffiti

33-148 | 500ml | £8.50



**VIVACERAM**

- Very powerful cleaner for ceramic tiles
- Alkaline based solution
- Manufactured specifically for use on fine stoneware and ceramic tiles
- Removes deep and stubborn spoiling
- Emulsifying properties
- Will remove incrustations and greases

33-597 | 5Ltr | £38.50



**GRAFFITI REMOVER TRIGGER SPRAY**

- New solvent blend
- Surfactant system allows a unique 'wash off, rinse away' property
- Low viscosity

33-186 | 6x750ml | £45.72



**ANDARTA GRAFFITI WIPE**

- For smooth, non-porous flat surfaces
- Absorbs and holds residue without redepositing
- Dissolves paint, inks and adhesives

19-012 | 150 | £14.85

## DETERGENT

**ANDARTA MACHINE DETERGENT**

- Fully formulated concentrated detergent
- Can be used in automatic dishwashers, cabinet glass washers and combi-ovens

33-036		25Ltr	£52.49
33-037		4x5Ltr	£41.99
33-410	Chlorinated	2x5Ltr	£20.99

**SUMA RINSE A5 MACHINE DETERGENT**

- Low foaming rinse aid
- Formulated to give a spot and streak free finish
- Ensures quick drying

33-512		2x5Ltr	£79.99
--------	--	--------	--------

**BRILLIANT PERFECT RINSE AID**

- Very High Shine
- All water types
- Economical
- Excellent rinsing performance.
- Provides high shine on glasses, cutlery and dishes.
- Accelerates drying time.
- Prevents lime scale

33-629		5 Ltr	£34.99
--------	--	-------	--------

**ANDARTA LOW FOAM RINSE AID**

- Effective in hard and soft water
- Use in dish/glass washing machines with automatic pumps
- Eliminates need for towel drying

33-038		25Ltr	£49.99
33-039		4x5Ltr	£39.99

**SUMA STAT D1.4 MACHINE DETERGENT**

- Manual dishwashing with extra hygiene
- Prevents growth of bacteria on the applicator and reduces the risk of cross contamination

33-513		2x5Ltr	£59.99
--------	--	--------	--------

**ENERGY PERFECT DISHWASHER DETERGENT**

- High performing dishwashing detergent
- Highly degreasing
- An innovative sustainable complex system preventing limescale deposits.
- Ideal for use in soft to middle hard water.
- Intensive and powerful cleaning.
- Highly concentrated formula for low dosing

33-616		5 Ltr	£34.99
--------	--	-------	--------

**TANSOLVE DESTAINING POWDER**

- Can be used as a pre-soak solution or added to the wash
- Provides stain removal
- Safe on all wash ware and will not fade fabric

33-203		10Kg	£44.99
--------	--	------	--------

**SUMA SOAK K7 DE-STAINING POWDER**

- Powdered pre-soaker formulated to provide excellent removal of stubborn stains

33-517		10kg	£51.42
--------	--	------	--------



**FINISH DISHWASH GRANULAR SALT**

- Guaranteed free from residues
- Utilises a dishwasher's built-in water softening unit effectively

33-338 | 4x5Kg |

£27.32



**ANDARTA DISHWASHER POWDER**

- For industrial and kitchen equipment
- Odourless, colourless and non-tainting
- Do not use on magnesium alloy or anodised surfaces

33-045 | 10Kg |

£39.99



**DISHWASHER GRANULAR SALT**

- Engineered to work in all commercial or industrial dishwashing and water softening units
- Small grain size

33-071 | 25Kg |

£13.49



**FINISH POWERBALL DISHWASHER TABLETS**

- Contains unique stain soakers
- Powerful detergents lift off and wash away all traces of food

33-096 | Box 110 |

£27.49



**DISHWASHER SALT TABLETS**

- Engineered to work in all commercial or industrial dishwashing and water softening units

33-072 | 25Kg |

£15.49





**FAIRY LIQUID ORIGINAL**

- Heavy duty descaler
- Dermatologically tested pH neutral formula
- Used for maintenance/deep cleaning

33-285 | 2x5Ltr | £39.99  
 33-263 | 6x900ml | £29.87



**BRILLO 15% WASHING UP LIQUID**

- Streak-free and easy rinsing for sparkling results
- Strong degreasing properties at low dosage

33-327 | 12x1Ltr | £30.87



**ANDARTA 20% LEMON DETERGENT**

- Highly concentrated
- Cleans walls, floors, cutlery, glassware, worktops and upholstery
- Streak-free drying
- Controlled foam, for damp mopping

33-103 | 1Ltr | £2.60  
 33-104 | 5Ltr | £8.17



**MANUDISH ORIGINAL**

- Hand Dishwashing Liquid
- Skin Friendly
- Ecological, intensive cleaning dishwashing detergent.
- No fragrance added.
- Effective at low doses.

33-617 | 1 Ltr | £9.99



**ANDARTA BACTERICIDAL WASHING UP LIQUID**

- Mild, long lasting foam - perfect for dishwashing by hand

33-363 | 4x5Ltr | £34.89



**MANUDISH ORIGINAL**

- Hand Dishwashing Liquid
- Skin Friendly
- Ecological, intensive cleaning dishwashing detergent
- No fragrance added
- Effective at low doses

33-630 | 5 Ltr | £29.99



**ANDARTA 15% DETERGENT**

- Cleans walls, floors, cutlery, glassware, worktops and upholstery
- Mild and long lasting
- Streak-free drying

33-100 | 25Ltr | £46.89  
 33-101 | 4x5Ltr | £36.89

**ANDARTA 10% DETERGENT**

- Suitable for cleaning floors, walls, cutlery, worktops, vinyl and cloth upholstery and vehicles
- Streak-free drying

33-112 | 5Ltr | £4.80





**SUMA BREAK UP D3.5 DEGREASER CONCENTRATE**

- Cleans heavily soiled surfaces
- Powerful formulation
- Safe on aluminum

33-515 | 2x5Ltr | £54.99



**ANDARTA YELLOW DEGREASING POWDER**

- Removes fat, grease, animal oils and dough
- Quickly dissolve in water
- Economical in application

33-033 | 10Kg | £29.46



**BEER LINE CLEANER**

- Suitable for both pressurised dispensing equipment and hand beer pumps

33-354 | 1x 5Ltr | £39.60



**ANDARTA ALUMINIUM CLEANER AND DESCALER**

- For industrial and kitchen equipment
- Odourless, colourless and non-tainting
- Do not use on magnesium alloy or anodised surfaces

33-132 | 5Ltr | £11.26



**DETTOL PROFESSIONAL SURFACE CLEANER**

- Anti bacterial disinfectant
- Odourless
- Ideal for areas of food prep
- Kills 99.9% of bacteria

33-097 | 6x750ml | **£34.89**



**MR MUSCLE MULTI TASK KITCHEN CLEANER**

- Streak-free shine
- Removes grease and dirt

33-446 | 12x500ml | **£33.00**



**ANDARTA EXTREME BACTERICIDAL SURFACE CLEANER**

- Cleans and sanitises
- Bleach free, non-hazardous, non-toxic, and non-tainting
- Accredited to: EN 1276, 13704, 1650, 14476 & 14675

33-455 | 6x750ml | **£29.18**  
33-455-5L | 2x5Ltr | **£33.31**



**ANDARTA BACTERICIDAL SURFACE CLEANER**

- For walls, worktops and all food-prep areas
- Superior antibacterial and cleaning performance
- Foodsafe and non-tainting
- Accredited to EN1276

33-108 | 5Ltr | **£12.90**  
33-176 | 750ml | **£3.77**



**GREASE PERFECT**

- Fast and efficient kitchen degreaser
- Desolves oil and greasy stains on all water and alkali-resistant surfaces and flooring
- Perfume free
- Suitable for all areas of the kitchen

33-619 | 750ml | **£6.99**  
33-620 | 5Ltr | **£27.99**



**GREASE POWER**

- High performance kitchen degreaser
- For use in food processing and kitchen areas
- Not suitable for use on aluminum, enamel and non-alkaline resistant surfaces

33-631 | 750ml | **£9.99**



**PRORAX**

- High performance drain cleaner
- Efficiently removes persistent blockages in all common drains.
- Fast acting and dissolves greasy blockages and hair in only 5 minutes.
- Easy and safe to use.
- One shot bottle

33-644 | 500ml |

£9.99



**GLADIATOR DRAIN CLEANER**

- Ideal for use in grease traps and waste pipes
- Controls odours and prevents solidifying
- Essential in catering environments

33-006 | 5Ltr |

£47.99

**Our goal is on time and in full**

We go the extra mile to understand how, when and where every order needs to be to keep you fully supplied.

Deliveries are made by our own company operated vehicles or by carefully selected hauliers.



**HORIZON  
AUTO  
LAUNDRY  
POWDER BIO**

- Biological automatic washing powder
- Free flowing to prevent clogging

33-066 | 90 Wash |

£36.83



**DAZ  
PROFESSIONAL  
LAUNDRY POWDER**

- Surfactant system delivers excellent performance at low temperature
- Activated oxygen bleach system
- Helps prevent tough stains

33-378 | 85 Wash |

£29.24



**PERSIL  
PROFESSIONAL  
LAUNDRY POWDER  
120 WASH**

- Best-ever stain removal with wash booster technology
- Works well on quicker and cooler programmes

33-429 | Biological | 1 |  
33-430 | Non-Bio | 1 |

£39.55  
£39.55



**ANDARTA AUTO  
LAUNDRY POWDER**

- Low foam
- Use for machine or hand washing
- Biodegradable in line with the requirements of EU Directives 73/404/EEC and 73/405/EEC
- Approx. 90 wash

33-047 | Biological | 10Kg |  
33-046 | Non-Bio | 10Kg |

£24.99  
£24.99



**PERSIL LAUNDRY LIQUID  
NON-BIO**

- Designed for sensitive skin
- Measures exact dosage
- Effective in all water conditions

33-067 | 5Ltr |

£26.15



**ANDARTA FABRIC  
CONDITIONER  
CONCENTRATE**

- Leaves fabrics fragrant and soft
- Helps reduce static build up
- Contains optical brightener

33-082 | 2x5Ltr |

£17.42

# SlipStop.

Leaks in public spaces can create many health and safety risks for your visitors.



That's why we have created SlipStop. This simplifies the process of collecting dripping liquids and securing the affected area.

This innovative device simultaneously defines a hazardous area, while mitigating the slip hazard.



- ▶ **Keeps visitors safe**  
Acts as a hazard control collecting water efficiently and out of sight.
- ▶ **Superior coverage**  
Product can cover a wide area when used in conjunction with another.
- ▶ **Obstacle removal**  
No need for additional signage or equipment to be used further to reducing trip hazards and cost.
- ▶ **High visibility**  
Product is easy to spot in comparison to traditional methods, further improving visitor safety.
- ▶ **Reduced manual handling**  
Fewer items reduces lifting requirements which therefore improves efficiency.
- ▶ **Improved response Time**  
Substantially reduced set up time means that the user can respond quickly to hazard.
- ▶ **Visually more attractive**  
Projects a more professional appearance within the centre. The **Slip Stop** comes with the option of branded panels, allowing companies to maximise their corporate identity.

# CLEANING EQUIPMENT

Products included in this category...



**Scourers, Cloths  
and Wipes**



**Janitorial Trolleys  
and Caution Signs**



**Window Cleaning  
and Vehicle Cleaning**



**Hygiene Brushware,  
Brooms, Squeegees  
and Shovels**



**Snow and Ice Control**



**CLEANING  
EQUIPMENT**



**Arrow**  
COUNTY SUPPLIES

Experts in  
**hygiene and  
cleanliness**  
solutions.



## Ask Arrow

Want to find out if  
there are products  
and processes that  
could reduce cost in  
use and improve results?

**We're here to help**

➤ [arrowcounty.com](https://arrowcounty.com)





**ANDARTA POLISHING GLASS CLOTH**

- For polishing glass, ceramics and stainless steel to a smear free shine
- No chemicals needed - just water
- Can be used wet, damp or dry to remove dirt, grease and dust
- Available in BL/GN/RD/YL

**34-081** | 1 Cloth | Cloth size: 60 x 80cm | **£4.74**  
 Cost per cloth: £4.74



**LUSTRE GREY MICROFIBRE CLOTHS**

- Ideal for cleaning windows, mirrors and hard polished surfaces
- Can be used dry or damp with water and no chemicals
- Lint and streak free

**34-096** | 1 Cloth | Cloth size: 40 x 40cm | **£3.99**  
 Cost per cloth: £3.99



**PVA MICROCLOTH**

- Unique PVA coating combined with knitted microfibre
- Smear free finish
- Enhances rinsability and overall cleaning result
- Allows trapped dirt to escape when rinsing
- Available in BL/GN/RD/YL
- Can be washed 400 times

**34-108** | 5 Cloths | Cloth Size: 38x35cm | **£13.20**  
 Cost per cloth: £2.64



**ANDARTA MICROFIBRE CLOTH**

- Versatile and can be used both wet and dry
- Offers a high absorption capacity and speed
- Easily clean glass and stainless steel surfaces, as well as collecting dust, dirt and food
- Machine washable and re-usable for a longer life-span
- Available in BL/GN/RD/YL

**34-017** | 10 Cloths | Cloth size: 40 x 40cm | **£10.50**  
 Cost per cloth: £1.05



### VILEDA MEDIUMWEIGHT CLOTH

- Machine washable
- High wet and dry strength
- Closed structure resists tearing and snagging
- Available in BL/GN/RD/YL

**34-054** | 10 Cloths | Cloth size: 43 x 35cm | **£8.17**  
Cost per cloth: £0.82

Super  
Absorbent



### FELTEC 1/4 FOLDED CLOTH

- Exceptionally durable and can be repeatedly washed
- Absorbs up to 10 times its own weight in water
- Available in BL/GN/RD/YL

**34-094** | 10 Cloth | Cloth size: 38 x 38cm | **£5.89**  
Cost per cloth: £0.59



### LAVETTE SUPER CLOTHS

- Open structure enhances dirt pick up
- Unique composition resists growth of anti-bacteria
- Fibre properties enable fast drying
- Available in BL/GN/RD/YL

**34-044** | 6x25 Cloths | Cloth size: 51 x 36cm | 75 gsm | **£54.85**  
Cost per cloth: £0.37



### ANDARTA HEAVY DUTY ANTIBACTERIAL MULTI PURPOSE CLOTH

- Excellent dirt pick up
- Resists growth of micro-organisms
- Dries rapidly, stays fresh
- Available in BL/GN/RD/YL

**34-027** | 6x25 Cloths | Cloth size: 51 x 36cm | 75 gsm | **£37.42**  
Cost per cloth: £0.25



### MEDIUM DUTY MULTIPURPOSE CLOTH

- Excellent dirt and dust pick up
- Offers a segregated cleaning solution
- Machine washable and reusable
- Available in BL/GN/RD/YL

**34-033** | 50 Cloths | Cloth size: 49 x 38cm | **£4.49**  
Cost per cloth: £0.23

Heavyweight  
plus



### HEAVYWEIGHT PLUS CLOTH

- Absorbs up to 5 times its own weight in water
- Incredible tear resistance
- Available in BL/GN/RD/YL

**34-088** | 25 Cloths | Cloth size: 43 x 36cm | 75 gsm | **£4.22**  
Cost per cloth: £0.17

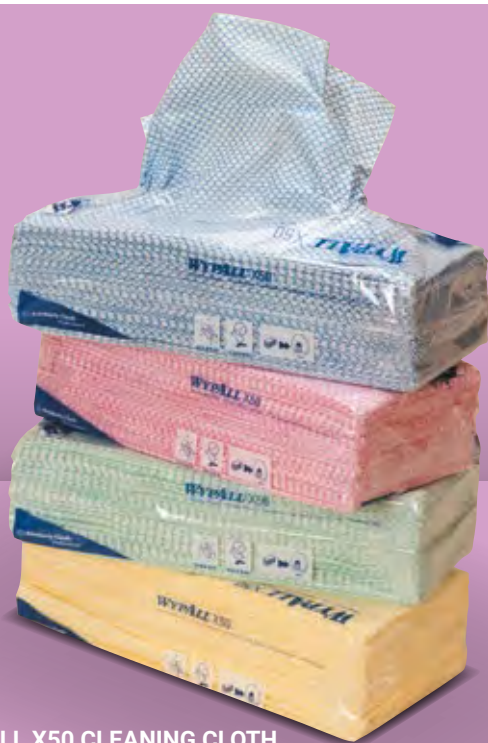
**WYPALL X50 CLEANING CLOTH**

- Made with hydroknit fast absorbing material
- Soft, but tear resistant
- Wipes automatically pull out the next sheet ready for use
- On dispensing, sheets are fully open
- Available in BL/GN/RD/YL

**34-022** | 6x50 Cloths | Cloth size: 25 x 42.5cm | 54gsm | **£45.13**  
Cost per 50 cloths: £7.52

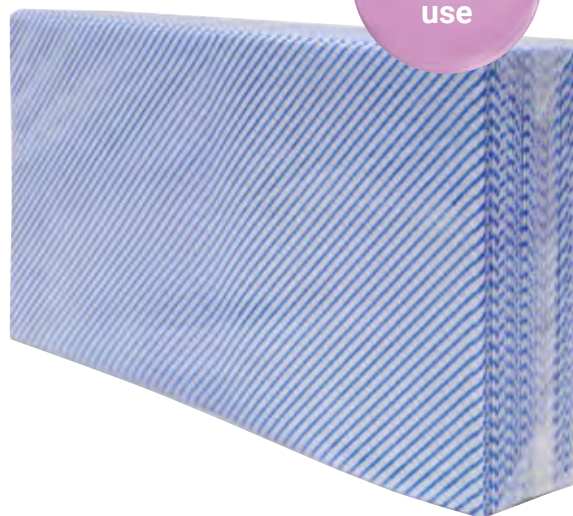
**ANDARTA GENERAL PURPOSE NON-WOVEN CLOTH**

- Ideal for light duty tasks
- Supple and flexible
- Simply use and dispose
- Available in BL/GN/RD/YL

**34-092** | 50 Cloths | Cloth size: 30 x 58 cm | 35gsm | **£4.49**  
Cost per 50 cloths: £4.49

**ANDARTA GENERAL PURPOSE CONTRACT NON-WOVEN CLOTH**

- Offers basic performance at good value for money
- Simply use and dispose
- Available in BL/GN/RD/YL

**34-082** | 50 Cloths | Cloth size: 35 x 33cm | 35gsm | **£3.49**  
Cost per 50 cloths: £3.49

**ANDARTA GENERAL PURPOSE NON-WOVEN CENTRE FEED ROLL**

- Supple and flexible
- Perfect at performing light duty tasks
- Dirt particles are easily rinsed away
- 500 cloths per roll
- Available in BL/GN/RD/YL

**34-020** | 2 Rolls | Cloth size: 25 x 25cm | 35gsm | **£35.53**  
Cost per 50 sheets: £1.78

Traps and holds 99.998% of bacteria



**ANDARTA DISPOSABLE MICROFIBRE CLOTH**

- Dispenser boxes reduce germ transfer and improve storage hygiene
- Dispenses one sheet at a time, next sheet automatically ready to use
- Virtually lint free
- Streak free cleaning
- Available in BL/RD/WH/YL

34-080 | 100 Cloths | Cloth size: 34 x 40cm | 70gsm | **£27.50**  
 Cost per 100 cloths £27.50



**VILED A DISPOSABLE MICROFIBRE CLOTHS**

- Makes 1-step cleaning possible
- Low lint
- Single use, therefore less possibility of cross-contamination
- 200 cloths per roll
- Available in BL/GN/YL

34-095 | 1 Roll | Cloth size: 30 x 27cm | 50gsm | **£24.99**  
 Cost per 100 cloths £12.49



**TORK PERFORMANCE FOLDED WIPE DISPENSER TURQOISE**

- Holds up to 400 cloths
- Dispenses one sheet at a time
- Semi-transparent window
- Lockable or push button opening

06-080 | 1 | **£30.99**



**TORK WIPING PAPER PLUS**

- Can be used on multiple surfaces
- 27% stronger than standard paper, wet or dry
- Cloth size: 39 x 32cm
- 2 Ply

24-033 | White | 200 Cloths | **£17.99**  
 Cost per 100 towels £7.47

**STANDARD YELLOW DUSTERS**

- 100% cotton with dust holding fibres
- Launderable with stitched edges to prevent fraying
- Available in BL/GN/RD/YL

**34-025** | 10 Cloths | Cloth size: 50 x 40.5cm | **£4.99**

**12"x16" STOCKINETTE DISHCLOTHS**

- Easy to segregate cleaning tasks
- Competent all-round cleaning cloth
- Edge colours available in BL/GN/RD/YL

**34-031** | 10 Cloths | Cloth size: 30 x 35.5cm | **£4.31**

**MEDIUM DUTY FLOORCLOTHS**

- High absorbency
- Launderable medium duty cloth

**34-037** | 10 Cloths | Cloth size: 48 x 35.5cm | **£9.87**

**STAINLESS STEEL SPIRAL SCOURERS**

- Great for removing tough messes

**34-028** | 40gsm | 10 Scourers | **£9.89**

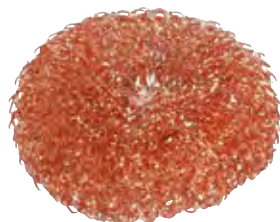
**COPPER SCOURERS**

- Removes tough grease and other foodstuffs

**34-016** | 25 Scourers | **£9.89**

**SOAP FILLED PADS**

- For tough cleaning and sparkling results

**34-109** | 16 Pads | **£5.49**

**PLAIN OVEN CLOTHS**

- High heat resistance

**34-057** | 10 Cloths | 19 x 30cm | **£48.94**

**OVEN GLOVES**

- Withstands high temperatures
- Generous size to protect from oven heat

**34-058** | Pair | Glove size: 23 x 17cm | **£4.20**

**BAKERS MITT**

- Perfect for removing hot pans and trays
- Washable

**34-059** | 1 Mitt | Mitt Size: 38 x 23.5cm | **£3.90**

**TEA TOWELS**

- High quality cotton

**34-061** | 10 Towels | Towel size: 48 x 71cm | **£10.87**

## Are you interested in e-Procurement?

Take advantage of our E-procurement expertise.

Contact us to talk about a punch-out catalogue or integrated e-ordering or e-invoicing solution.

**PAL-O-MINE CLEANING TOOLS**

- Cleans effortlessly, removing dirt that is difficult to reach with ease
- Pad technology works best when wet
- Can be used for all of your cleaning needs in a multitude of areas

<b>1</b>	<b>34-114</b>	Floor Sponge Tool	1	<b>£12.99</b>
	<b>34-115</b>	Cove Cleaner Tool	1	<b>£10.85</b>
<b>2</b>	<b>34-116</b>	Edging Tool	1	<b>£14.99</b>
<b>3</b>	<b>34-117</b>	Grout Cleaner Tool	1	<b>£5.99</b>
<b>4</b>	<b>34-118</b>	All Round Cleaning Tool	1	<b>£3.30</b>
<b>5</b>	<b>34-119</b>	All Square Cleaning Tool	1	<b>£4.99</b>
<b>6</b>	<b>40-490</b>	Floor Sponge	10 Sponges	<b>£21.45</b>
	<b>40-491</b>	Cove Cleaner Sponge	10 Sponges	<b>£59.15</b>
<b>7</b>	<b>40-492</b>	Edging Sponge	10 Sponges	<b>£29.15</b>
<b>8</b>	<b>40-493</b>	Grout Cleaner Sponge	10 Sponges	<b>£13.55</b>
<b>9</b>	<b>40-494</b>	All Round Cleaning Sponge	10 Sponges	<b>£12.38</b>
<b>10</b>	<b>40-495</b>	All Square Cleaning Sponge	10 Sponges	<b>£12.38</b>

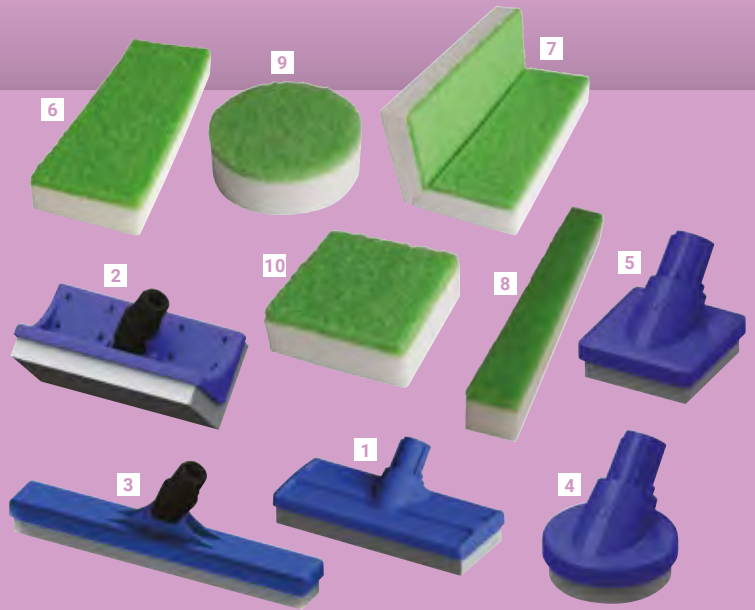

**ANDARTA MIRACLE SCOURER**

- Cleans general dirt and marks
- Just damp the pad with water and rub the mark away



**34-053** | 12 Pads | **£14.85**

**PUR-ACTIVE FOAM BACKED SCOURER**

- Unique PU coating lifts dirt without scratching surface
- Will not shed particles
- Ergonomic shape
- Available in BL/GN/RD/YL

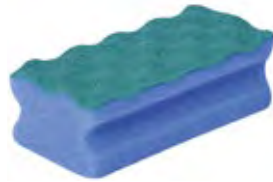

**34-055** | 10 Pads | **£13.89**

**ANDARTA GRIDDLE PAD HOLDER AND EXTENDABLE HANDLE**

- Griddle pad holder
- Extendable handle allows access to hard to reach areas
- Griddle pad not included



**34-127** | 1 | **£23.31**

**Griddle Pad Scourer**



**34-051** | 1 | **£7.62**

Superior Performance

**9"x6" VILEDA H/DUTY GREEN SCOURERS**

- Manufactured from Nylon which does not rust, splinter, clog and are easier to rinse out.
- Available in BL/GN/RD/YL



**34-048** | 10 Pads | **£23.34**

**6"x4" SPONGE BACKED SCOURER**

- Abrasive, with easy grip foam backing
- Ideal for general washing up



**34-087** | 6 Pads | **£12.49**

**9"x6" SCOURERS**

- Ideal for stubborn dirt
- Long lasting

**34-029** | 10 Pads | **£4.49**

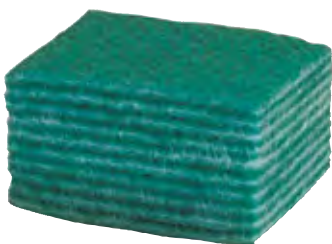

**PAD SCOURER, GRIPPER AND HOLDER**

- Use with 41-011 handle
- Pad Size: 23 x 10cm

<b>34-001</b>	Black Scourer	1	<b>£1.49</b>
<b>34-002</b>	Hand Held Pad Gripper	1	<b>£11.00</b>
<b>34-003</b>	Swivel Socket Pad Holder	1	<b>£11.79</b>





**DISINFECTANT WIPER REFILL PLASTIC DISPENSER**

- Substantial cost-in-use savings when compared to bucket wipes
- Single sheet dispensing
- Fully lockable which prevents pilferage
- For blue disinfectant wipe refill 19-066

19-019 | 1 |

£33.95



**PAL TX BLUE SURFACE DISINFECTANT WIPE**

- Contains an alcohol, QUAT and PHMB free disinfectant solution
- Accredited to: EN1276, EN13727, EN13697, EN14561, EN14348, EN13704 and EN14562

19-062 | 1500 Wipes |

£40.39

Effective against 99.9% of gram-positive and gram-negative bacteria



**PAL TX WHITE SANITISING SURFACE WIPE**

- Predosed with a dual active formulation
- Food Safe
- Accredited to: EN1276, EN13727, EN13697, EN14561, EN14348, EN13704 and EN14562

19-064 | 200 Wipes |

£9.50



**PAL TX SURFACE DISINFECTANT REFILL WIPE**

- Use as refill for 19-062 bucket or with 19-019 dispenser
- Reduces costs and assists environmental issues
- Contains an alcohol, QUAT and PHMB free disinfectant solution
- Accredited to: EN1276, EN13727, EN13697, EN14561, EN14348, EN13704 and EN14562

19-066 | Sheet Size 19.5cm x 19.5cm | 2 boxes x1500 Wipes | £ 51.66



**ANDARTA POCKET SIZED PROBE SANITISING WIPE**

- Sanitises hands and surfaces

19-002 | 70 Wipes | Sheet size: 7 x 13cm | £2.99



**ANDARTA WET WIPE DISPENSER**

19-033 | 1 |

£29.99



**SURFACE SANITISER WIPE REFILL**

- Perforated wipe ensures only a single wipe is dispensed at a time which reduces consumption and cost
- Low lint material
- Effective against bacteria and viruses such as Salmonella, V-Diff, E-Coli, HepatitisB and MRSA

19-034 | 225 Wipes | Sheet Size: 18.5 x 20cm | £11.50



**SPIXLEX SUPER ABSORBENT PAD**

• Pad size: 56x40x19cm

46-011 | 20 Pads | **£29.99**

**ANDARTA BODY FLUID SPILL KIT**

- 5 Spill Kits, each including;
- Plastic Scoop and Spatula
- Valved Respiratory Mask
- Disposable Apron and Gloves
- Biohazard Disposal Bag
- Absorbent Pad
- 10 x Perforated Wipes
- 400g absorbent powder
- 750ml surface sanitiser is food safe and effective against a wide range of bacteria.



46-003 | 1 Kit | **£114.00**

**ANDARTA BODY FLUID SPILL KIT REFILL**

• 5 Refills/Unit.



46-004 | 5 Refills | **£84.00**

**ANDARTA ABSORBENT POWDER**

- Absorbs urine, vomit, foodspills and water.
- Transforms messy liquid into semi-solid gel within 30 secs.
- Absorbs 100 times it's own weight
- Effective against HIV and other common bacteria and viruses
- Fragranced



46-005-400G | 400G | **£20.77**



**CLEANING SIGNS**

40-154	Wet Floor Warning Cone L27cm x W27cm x H67cm	1	<b>£14.29</b>
40-194	Cleaning in Progress Sign L30cm x W3cm x H69cm	1	<b>£18.00</b>

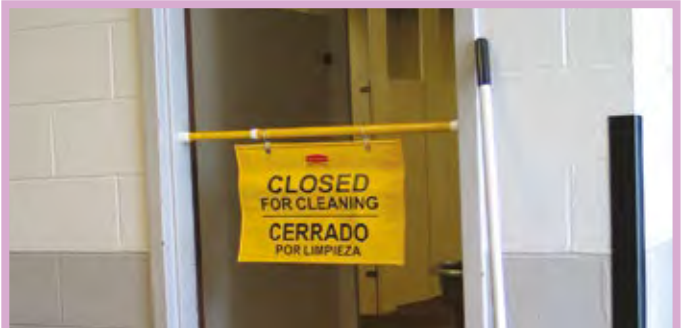

**SITE SAFETY HANGING SIGN**

- Expands to 1200mm wide

48-104 | 1 | **£29.49**

**DOOR STOPPER WITH HOOK**

- Ideal tool to keep open any kind of doors during daily cleaning operations
- Can be placed without bending down
- Large slip resistant base



43-316 | 1 | **£17.50**

**MOBILE BARRICADE SYSTEM**

- 4m length with articulating panels
- Easy to see and store
- Weighs 15kg



48-105 | 1 | **£311.94**



**CLEANING SIGN**

40-007 | Wet Floor Warning 'A' Sign | 1 | Size: 26-inch | £8.65

**Slip Stop**

- Slip Stop simplifies the process of collecting dripping liquids
- Secures the affected area
- Innovative device
- Mitigates the slip hazard

40-023-MED  
46-024-LRG

Slip Stop 65  
Slip Stop 95

£69.95  
£124.95

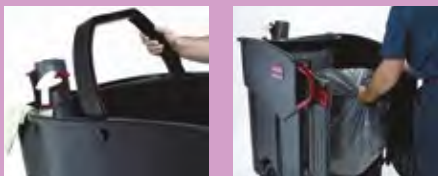

#### MEGA BRUTE MOBILE COLLECTOR

- Highly manoeuvrable
- Has a versatile waste and linen collection and sorting system
- Innovative design delivers improved productivity and ease of use
- Comfort grip handle provides easy manoeuvrability

40-166 | 1 |

£534.64



#### HIGH CAPACITY CLEANING CART

- Rubber tool grips hold handles upright
- Non-rusting, easy to clean aluminium and structural web plastic construction.
- Hooks hold up to four safety signs
- Lock onto connection for Wavebrake or pedal wring bucket

40-327 | 1 |

£396.29



#### RUBBERMAID CLEANING CART

- Large 7.25 cu ft. of locking cabinet area
- 5 cu. Ft. of storage space
- Features Lock N Go bucket attachment
- Locking cabinet doors on both side of the cart
- Includes 2 removable 10 Quart disinfecting caddies
- Non-rusting and easy to clean

40-461 | 1 |

£728.91



#### QUICK AND EASY BELT

- Compatible exclusively with the Quick and Easy System
- Four pouches to allow easy transportation of cleaning chemicals
- Contents not included

40-517 | 1 |

£34.99



#### JANITORIAL TROLLEY C/W BAG

- Lightweight
- User friendly
- Complete with yellow flame resistant waste bag
- H980 x W470 x D1220mm

40-153 | 1 | Accessories not included | £108.60



#### XTRA COMPACT JANITORIAL TROLLEY

- Ideal for where space is at a premium, but cleaning is a necessity
- Unique Structofoam chassis
- Manoeuvrable
- H840 x W570 x D1060mm

40-506 | 1 | Accessories not included | £249.99

#### 400MM PLASTIC TIDY TRAY

- 400 x 300 x 135mm

41-089 | 1 |

£6.49



#### NC4 CAROUSEL CLEANING CADDY

- Colour coded sections enable a systematised cleaning approach
- Each compartment is detachable as required
- Simple, yet versatile

40-150 | 1 | H870 x W545 x D500mm | £92.35



**EASY HI DUST KIT**

- Ideal for high level cleaning up to 3 metres
- Works using electrostatic charged head
- Head can be flexed for cleaning ledges and pipes
- Kit includes:
  - Extendable handle
  - Flexi frame head
  - 3x microfibre sleeves
  - 3x microfibre gloves

41-267 | 1 | £65.20



**COBWEB BRUSH**

- Soft PVC twisted-in-wire
- To fit 41-102 and 41-096 handle sold separately
- Size: 14"

34-004 | 1 | £11.90



**LAMBSWOOL DUSTER**

- Ideal for removing dust from smooth surfaces
- Size 50"

34-006 | 1 | £6.72



**VENETIAN BLIND DUSTER**

- Split head dust mop and is ideal for cleaning Venetian blinds
- Size: 41cm

34-089 | 1 | £8.90



**DOMED COBWEB BRUSH WITH TELESCOPIC HANDLE**

- Very soft domed cobweb brush with handle
- Size: 15cm
- Length 196cm

34-106 | 1 | £12.49



**1.3-4M EXTENDING HANDLE**

41-096 | 1 | £37.10



**3.2 - 5.3M EXTENDING HANDLE**

41-317 | 1 | £212.34



**EASY SHINE GLASS AND STAINLESS STEEL CLEANING KIT**

- Perfect for cleaning where demands on cleaning efficiency and hygiene are high
- Contains 5 x window mops, 5 x lustre cloth, 1 x spray bottle, 1 x mop frame and 1 x telescopic handle

41-249 | 1 | £90.49



**SQUEEGEE HANDLES AND BLADES**

37-001	Stainless Steel Squeegee Handle	1	35cm	£9.99
37-003	Stainless Steel Channel and Blade	1	35cm	£6.99
37-004	Replacement Rubber Blade	1	35cm	£4.99



**T-HANDLE AND SLEEVE**

37-006	Plastic T-Handle	1		£6.99
37-007	Sleeve for T-Handle	1		£6.40



**3M WINDOW CLEANING TELESCOPIC HANDLE**

41-006 | 1 | £46.99



**5M WINDOW CLEANING TELESCOPIC HANDLE**

41-012 | 1 | £53.99



**OVERMOULDED PROFESSIONAL WALL BRACKET SYSTEM BLUE**

- Available colours: BK/BL/GN/RD/WH/YL

41-255 | 1 |

£13.92



**5-BRUSH HANGER**

- 515mm long
- Anodised aluminium rail
- Hangers can be removed for cleaning
- Available colours: BK/BL/GN/RD/WH/YL

41-099 | 1 |

£27.49



**3-SHOVEL HANGER**

- 515mm long
- Anodised aluminium rail
- Hangers can be removed for cleaning
- Available colours: WH/BK/BL/GN/RD/YL

41-100 | 1 |

£21.49



**20-30MM MEDIUM BRUSH HANGER**

- For 41-099 Available colours: BK/BL/GN/RD/WH/YL

41-103 | 1 |

£4.49



**ALUMINIUM RAIL**

- Size: 500mm
- Available colours: BK/BL/GN/RD/WH/YL

41-097 | 1 |

£16.49



**30-40MM LARGE SHOVEL HANGER**

- For 41-099 Available colours: BK/BL/GN/RD/WH/YL

41-104 | 1 |

£4.49



**HOOK FOR 41-097 RAIL**

- Available colours: BL/GN/WH/YL/RD

41-105 | 1 |

£1.49

**Ask about our bespoke shadow boards**

- Keep equipment secure
- Reduce cross contamination by having zone specific boards
- Keep tools off the floor
- Freestanding or wall mounted
- Call us to discuss your requirements

## BRUSHWARE TYPES



## RESIN SET

### FOR FOOD SAFETY IMPROVEMENTS

- Can help dramatically reduce biological hazards (accumulation of organic matter/pathogens) and physical hazards (loss of brush filaments)
- Recognised as a **'Standard Requirement for the Food Industry'**
- Resin contains silver based technology that prevents in excess of 99% of bacterial contamination including MRSA and E-Coli
- Available in up to 6 colours for segregation, prevent cross contamination and aid HACCP compliance



## PROFESSIONAL

### COLOUR CODED HYGIENE BRUSHWARE

- Supreme quality and durability
- Innovative tools for problem areas
- Withstands high temperatures: 134°C/273°F
- Total colour-coding with a choice of 6 colours for prevention of cross contamination, segregation and HACCP compliance



## PREMIER

### COLOUR CODED HYGIENE BRUSHWARE

- Ergonomic products that are extremely easy to clean
- Total colour-coding with a choice of 6 colours to help avoid cross contamination, segregation and HACCP compliance
- Withstands high temperatures: 134°C/273°F

Inhibits the growth of bacteria  
(Anti-Microbial Resin)



No accumulation  
of moisture and  
dirt (Resin-Set)

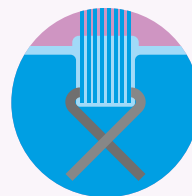

No loss of brush filaments  
(DRS – Dual Retention System)



**MEDIUM BRISTLE BROOM**

41-061	1	Width: 610mm	Trim: 75mm	Professional	£34.49
41-062	1	Width: 610mm	Trim: 75mm	Resin Set	£40.49



**STIFF BRISTLE BROOM**

41-073	1	Width: 457mm	Trim: 75mm	Resin Set	£30.99
41-072	1	Width: 457mm	Trim: 75mm	Professional	£25.99



**SOFT BRISTLE BROOM**

41-055	1	Width: 305mm	Trim: 75mm	Professional	£18.99
41-056	1	Width: 305mm	Trim: 75mm	Resin Set	£22.49



**MEDIUM STIFF BRISTLE BROOM**

41-251	1	Width: 500mm	Trim: 58mm	Premier	£15.99
41-053	1	Width: 457mm	Trim: 75mm	Professional	£25.99
41-054	1	Width: 457mm	Trim: 75mm	Resin Set	£30.99



**NARROW SOFT BRISTLE BROOM**

41-026	1	Width: 390mm	Trim: 50mm	Professional	£21.49
41-027	1	Width: 390mm	Trim: 50mm	Resin Set	£25.99



**STIFF BRISTLE BROOM**

41-247	1	Width: 280mm	Trim: 58mm	Premier	£10.40
41-070	1	Width: 305mm	Trim: 75mm	Professional	£18.99
41-071	1	Width: 305mm	Trim: 75mm	Resin Set	£22.49



**MEDIUM BRISTLE BROOM**

41-048	1	Width: 305mm	Trim: 75mm	Resin Set	£22.49
41-047	1	Width: 305mm	Trim: 75mm	Professional	£18.99



**STIFF DECK SCRUB**

41-253	1	230mm Width	Trim: 58mm	Premier	£10.99
41-067	1	230mm Width	Trim: 50mm	Professional	£12.99
41-068	1	280mm Width	Trim: 50mm	Resin Set	£14.99



**SOFT BRISTLE INDOOR BROOM & HANDLE**

40-121	1				£7.49
--------	---	--	--	--	-------



**1400MM FIBREGLASS HANDLE**

41-090	1				£11.49
--------	---	--	--	--	--------



**1360MM THREADED ALUMINIUM HANDLE**

41-011	1				£7.99
--------	---	--	--	--	-------



**1350MM LIGHTWEIGHT THREADED ALUMINIUM HANDLE**

41-007	1				£5.49
--------	---	--	--	--	-------

All Brushware is available in ■ ■ ■ ■ ■ ■ ■ unless stated otherwise.



**STIFF BRISTLE  
LONG HAND BRUSH**

41-082	1	Length: 406mm	Trim: 50mm	Resin Set	£16.99
41-081	1	Length: 406mm	Trim: 50mm	Professional	£9.99



**MEDIUM BRISTLE  
UTILITY BRUSH**

41-064	Length: 260mm	Trim: 48mm	Resin Set	£ 5.99
41-063	Length: 260mm	Trim: 48mm	Professional	£4.49



**STIFF BRISTLE DETAIL BRUSH**

41-038	Length: 225mm	Trim: 21mm	Professional	£2.49
--------	---------------	------------	--------------	-------



**NICHE BRUSH**

41-196	Length: 180mm	Trim: 10mm	S/Steel Bristle	£3.40
41-033	Length: 180mm	Trim: 10mm	Professional	£2.49



**HAND BRUSH**

41-058	1	Trim: 36mm	Length: 317mm	Soft Bristle	Resin Set	£7.49
41-060	1	Trim: 36mm	Length: 317mm	Stiff Bristle	Resin Set	£7.49
41-057	1	Trim: 36mm	Length: 317mm	Soft Bristle	Professional	£5.99
41-059	1	Trim: 36mm	Length: 317mm	Stiff Bristle	Professional	£5.99



**WIRE SCRATCH BRUSH**

• Stainless steel fill

41-164	Length: 279mm	Trim: 35mm	Resin Set	£12.99
41-163	Length: 279mm	Trim: 35mm	Professional	£10.49



**GRIPPY SCRUB BRUSH**

• 28mm trim

41-148	Length: 152mm	Trim: 50mm	Professional	£5.99
--------	---------------	------------	--------------	-------



**DOUBLE WING SPREAD**

41-147	1	Length: 210mm	Trim: 65mm	Resin Set	£10.99
41-146	1	Length: 210mm	Trim: 65mm	Professional	£7.99

**Ask about the Workplace Hygiene Assessment Program.**

We help to:

- Support staff to achieve higher standards
  - Improve workplace environment to attract and retain quality staff
- Achieve measurable cost reductions

All Brushware is available in ■ ■ ■ ■ ■ ■ ■ unless stated otherwise.





**TANK BRUSH**

41-080	1	Trim: 59mm Width: 216mm	Soft Bristle	Resin Set	£41.49
41-162	1	Trim: 59mm Width: 216mm	Stiff Bristle	Resin Set	£41.49
41-078	1	Trim: 59mm Width: 216mm	Soft Bristle	Professional	£17.99
41-079	1	Trim: 59mm Width: 216mm	Stiff Bristle	Professional	£17.99



**MEDIUM BRISTLE WIRE TUBE BRUSH**

• Available colours: GN/YL/RD/BL/WH

41-149	1	Length: 400mm	Trim: 13mm	£6.60
41-150	1	Length: 400mm	Trim: 25mm	£6.99
41-224	1	Length: 400mm	Trim: 64mm	£7.56
41-153	1	Length: 400mm	Trim: 75mm	£7.99



**SOFT BRISTLE GLAZING BRUSH**

41-093	1	Trim: 50mm	Resin Set	£5.99
41-094	1	Trim: 75mm	Resin Set	£8.40



**NAIL BRUSH**

- Assorted colours
- Trim: 34mm
- Length: 102mm

41-117 | 1 | £0.99



**MEDIUM BRISTLE GRIPPY NAIL BRUSH**

- Available colours: GN/YL/RD/BL/WH
- Trim: 34mm
- Length: 102mm

41-115 | 1 | £1.99



**STIFF BRISTLE NAIL BRUSH**

- Trim: 44mm
- Length: 122mm

41-116 | 1 | £3.49



**EXTRA STIFF BRISTLE GROUT SCRUB BRUSH**

- Available Colours: GN/RD/BL
- Trim: 34mm
- Width: 240mm
- Fits Handle: 41-090, 41-011 & 41-007

41-144 | £6.99



**EXTRA STIFF BRISTLE TILE SCRUB BRUSH**

- Available colours: BL/GN/RD
- Trim: 78mm
- Width: 197mm
- Fits Handle: 41-090, 41-011 & 41-007

41-145 | 1 | £9.49



**270MM MEDIUM BRISTLE DISHWASH BRUSH**

- Available colours: BL/RD/WH/YL

41-087 | 1 | £2.49

All Brushware is available in unless stated otherwise.



**OPEN DUSTPAN**

- Moulded grip on handle
- Made from impact resistant plastic for tough environments
- 325 x 315mm

41-179 | 1 | £4.49



**METAL ENCLOSED DUSTPAN**

41-221 | 1 | £8.70



**DUSTPAN & SOFT BRUSH**

- Available colours: BL/GN/RD/YL
- 330 x 203mm

41-165 | 1 | £2.55



**HANDLE AND BROOMS**

41-007	1	1350mm Lightweight Aluminium Handle	£5.49
41-022	1	11" Stiff Bristle Lightweight Broom	£6.99
41-021	1	11" Soft Bristle Lightweight Broom	£6.99



**HAND BRUSH**

- For use with all dustpans

41-024 | 1 | Soft Hand Brush | £2.99  
 41-025 | 1 | Stiff Hand Brush | £2.99



**ENCLOSED DUSTPAN**

- Available colours: BL/GN/RD/YL
- Use 41-024 or 41-025 brush

41-083 | 1 | £8.40



**STAINLESS STEEL HAND SCRAPER**

41-114 | 1 | £7.49



**LONG HANDLED SCRAPER**

41-113 | 1 | £24.99



**10" LOBBY DUSTPAN AND BRUSH SET**

- Lightweight
- Ideal for cleaning small areas

41-204 | 1 | £9.81



**PLASTIC HAND SCRAPER**

41-123 | 1 | 76mm blade | £1.99  
 41-124 | 1 | 110mm blade | £2.99



**FLPSC3 FLEXIBLE PLASTIC SCRAPER**

41-327 | £2.49

All Brushware is available in ■ ■ ■ ■ ■ ■ ■  unless stated otherwise.

For handles  
see page 84 and 87

Swivel head mechanism for added manoeuvrability



**600MM SWIVEL HEAD SQUEEGEE**

- For intricate cleaning, such as spillages underneath tables and workstations
- Overmoulded construction reduces bacterial hotspots
- Angled blade is stress tolerant to withstand vigorous cleaning
- All components are FDA/EU approved
- Fits Handle 41-090 & 41-011

41-328 | 1 |

£23.49



**DOUBLE BLADE PLASTIC SQUEEGEE**

- Dura-Flex™ natural mousse rubber with closed cell technology to prevent moisture penetration and increase longevity
- Less pressure required with single blade squeegee
- All components are FDA/EU approved
- Fits Handle 41-090 & 41-011

41-120 | 1 | Width: 400mm  
41-122 | 1 | Width: 600mm

£17.49  
£19.49

**ULTRA HYGIENIC OVERMOULDED SQUEEGEE**

- Overmoulded construction reduces bacterial hotspots
- Angled blade is stress tolerant to withstand vigorous cleaning
- All components are FDA/EU approved Fits Handle 41-090 & 41-011

41-118 | 1 | Width: 400mm  
41-119 | 1 | Width: 600mm

£14.49  
£15.99

**300MM ULTRA HYGIENIC SQUEEGEE AND HANDLE**

- Overmoulded construction reduces bacterial hotspots
- Angled blade is stress tolerant to withstand vigorous cleaning
- All components are FDA/EU approved

41-329 | 1 |

£16.59

All Brushware is available in ■ ■ ■ ■ ■ ■ ■  unless stated otherwise.

**SMALL SCOOP**

- Scoop size: 60 x 110 x 145mm

41-137 | 1 |

£2.99

**LARGE SCOOP**

- Scoop size: 90 x 170 x 260mm

41-139 | 1 |

£4.49

**117CM LONG HEAVY DUTY D GRIP SHOVEL**

- Scoop size: 330 x 310mm

41-130 | 1 |

£23.99

**120CM LONG HEAVY DUTY D-GRIP SHOVEL**

- Scoop size: 320 x 260mm

41-126 | 1 |

£21.99

**115CM LONG T GRIP SHOVEL**

- Scoop size: 320 x 260mm

41-128 | 1 |

£19.49

**LIGHTWEIGHT SHOVEL**

- 1100mm long
- Scoop size: 320 x 260mm
- D Grip handle

41-132 | 1 |

£15.70

**SOFT GRIP HAND SHOVEL**

- Scoop size: 320 x 260mm

41-131 | 1 |

£10.49

**LONG WOODEN HANDLE SHOVEL**

- 1050mm long
- 'D' grip

48-033 | 1 |

£11.55

**SHORT WOODEN HANDLED SHOVEL**

48-034 | 1 |

£3.50

All Brushware is available in         unless stated otherwise.



**TRAFFIC FILM REMOVER**

- Versatile formula for removing traffic film and heavy degreasing
- Suitable for use with both hard and soft water

36-011 | 25Ltr | £54.60



**ANDARTA CAR SHAMPOO**

- High Performance vehicle shampoo
- Tough on grease and dirt yet gentle on glass and paintwork
- Kind to the environment
- Outstanding cleaning performance made to leave a beautiful shine
- Can be used with a variety of car cleaning tools

36-064 | 2x5Ltr | £34.99



**SUPERFLOW WATERFLOW BRUSH WITH TELESCOPIC HANDLE**

- Comfortable foam grip
- 2.4 metres long
- Ideal for heavy duty cleaning of vehicles

36-066 | 1 | £34.99



**PUR-ACTIVE FOAM BACKED SCOURER**

- Unique PU coating lifts dirt without scratching surface
- Will not shed particles
- Ergonomic shape
- Available colours: BL/GN/RD/YL

34-055 | 10 Pads | £13.89



**JUMBO SPONGE**

36-004 | 1 | £1.15



**PVA MICROCLOTH**

- Unique PVA coating combined with knitted microfibre
- Enhances rinsability and overall cleaning result
- Allows trapped dirt to escape when rinsing
- Available in BL/GN/RD/YL

34-108 | 5 Cloths | £13.20



**SYNTHETIC CHAMOIS LEATHER**

- Synthetic
- Size 18" x 15"

36-005 | 10 | £11.20



**10 LTR PRESSURE SPRAYER**

- Carrying strap
- Viton seals

40-004 | 1 | £63.70



**SCREEN WASH**

- Cleans without smearing
- Powerful formula

36-008 | 5Ltr | £4.49

**BASSINE BROOM**

<b>40-022</b>	36"	1	Handle Code: 40-024	<b>£15.99</b>
<b>40-021</b>	24"	1	Handle Code: 40-024	<b>£7.49</b>
<b>40-020</b>	18"	1	Handle Code: 40-024	<b>£6.49</b>
<b>40-010</b>	12"	1	Handle Code: 40-023	<b>£3.30</b>

**NATURAL COCO BROOM**

<b>40-196</b>	36"	1	Handle Code: 40-024	<b>£16.79</b>
<b>40-251</b>	24"	1	Handle Code: 40-024	<b>£12.20</b>
<b>40-018</b>	18"	1	Handle Code: 40-024	<b>£5.99</b>
<b>40-013</b>	12"	1	Handle Code: 40-023	<b>£2.99</b>

**HAND BRUSHES**

• 68mm trim

<b>40-025</b>	12" Bassine	1	<b>£1.99</b>
<b>40-026</b>	12" Coco	1	<b>£1.99</b>

**UNION MIX SCRUBBING BRUSH**

<b>40-037</b>	1	<b>£1.99</b>
---------------	---	--------------

**HANDLES AND STAY**

<b>40-023</b>	Length: 4'	1	Diameter: 15/16"	<b>£1.52</b>
<b>40-024</b>	Length: 5'	1	Diameter: 1 1/8"	<b>£3.88</b>
<b>40-038</b>	Ungalvanised Stay	1		<b>£1.49</b>

**WOODEN HANDLE 3-ROW WIRE HAND BRUSH**

<b>40-044</b>	1	<b>£2.99</b>
---------------	---	--------------

**13" POLYPROP YARD BROOM**

- 114mm trim
- Hard wearing
- To fit 40-163 handle

<b>40-164</b>	1	<b>£10.80</b>
---------------	---	---------------

**Quick, clean  
and simple**

**We take ownership  
of making things  
simple for you,  
from finding  
products and  
ordering to delivery  
and invoicing**



**HEAVY DUTY ROCK SALT SPREADER**

- Holds up to 36kg of rock salt
- Upright ergonomic design
- 13" stud tread pneumatic tyres
- Rate setting control on handle
- Up to 4.5m spread pattern

42-011 | 1 | £399.99



**SALT SPREADER**

- Spreads evenly and consistently
- Robust construction
- Holds 15kg of rock salt

42-012 | 1 | £199.95



**1 7 CU.FT GRIT BIN**

- H787 x W787 x D482mm
- Holds 8 x 25kg bags

42-005 | 1 | £167.50

**2 14 CU.FT GRIT BIN**

- H965 x W1100 x D725mm
- Holds 16 x 25kg bags

42-006 | 1 | £260.00



**WINTER WIZARD FAST DE-ICER 5KG TUB**

- Winter Wizard high performance de-icers
- Easy to use
- 5kg tub is easy to store
- Contains BS3247 certified quality white marine de-icing salt

42-021 | 5kg tub | £24.14



**DE-ICER TRIGGER SPRAY**

- Designed to melt ice fast
- Works in sub-zero temperatures
- Use with an ice scraper for extra stubborn areas

36-009 | 6 x 750ml | £17.10



**BROWN ROCK SALT**

42-002 | 25Kg | £9.95



**WHITE ROCK SALT**

42-001 | 25Kg | £10.25



**SNOW SHOVEL WITH STEEL ICE CUTTER**

42-023 | 1 | £21.50



**SNOW SCOOP COMPLETE WITH HANDLE**

• 48" wooden handle  
42-004 | 1 | £18.30



**ARROW**  
COUNTY SUPPLIES

Experts in  
**hygiene** and  
**cleanliness**  
solutions.



## Advise

You can rely on us  
for quality advice and  
expertise that will  
help you deliver  
outstanding results

 [arrowcounty.com](http://arrowcounty.com)



# FLOORCARE

Products included in this category...



**Vacuums and Sweepers**



**Scrubber Dryers, Steam Cleaners and Rotary Floorcare Machines**



**Dust Control**



**Floorcare Chemicals**



**Buckets and Mopping Systems**

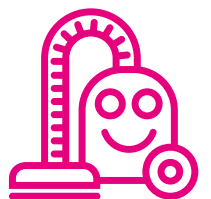

**FLOORCARE**



**Arrow**  
COUNTY SUPPLIES

Experts in  
**hygiene and  
cleanliness**  
solutions.



# Workplace Assessment

Want to find out how  
you could reduce costs  
of up to 20% of your  
total cleaning budget?

**Book your assessment today**

➤ [arrowcounty.com](https://arrowcounty.com)



Accessory kit included.



Accessory kit included.



Accessory kit included.

Technical	Data
Motor (Watt)	1100
Sound Pressure (db)	69.9
Power (Volt)	230
Airflow (Litres/Sec)	40
Suction (mm)	2400
Capacity (Ltr)	9
Range (m)	26.8
Weight (kg)	5.3
Dimensions (mm)	340 x 340 x 370
Gaurantee (Years)	2

**NUMATIC PROFESSIONAL VACUUM**

- Compact, lightweight, easy to carry
- Can be used on capets upholstery curtains and bare floors

39-026 | 1 |

£178.93

Technical	Data
Motor (Watt)	620
Sound Pressure (db)	72
Power (Volt)	230
Airflow (Litres/Sec)	30
Suction (mm)	2300
Capacity (Ltr)	8
Range (m)	26.8
Weight (kg)	7.6
Dimensions (mm)	340 x 340 x 340
Gaurantee (Years)	2

**DRY VACUUM**

- A-Rated energy efficiency
- TriTex filtration system improves filtration, cleanliness and capacity
- On board wand and tool storage for convenience

39-084 | 1 | PSP180 |

£174.99

Technical	Data
Motor (Watt)	1200/600
Sound Pressure (db)	68.6
Power (Volt)	230
Airflow (Litres/Sec)	45
Suction (mm)	2600/1750 Hi/Lo
Capacity (Ltr)	9
Range (m)	26.8
Weight (kg)	6.9
Dimensions (mm)	355 x 355 x 415
Gaurantee (Years)	2

**NUMATIC HENRY VACUUM CLEANER**

- Cable storage and rewind system keeps cable tidy and reduces risk of cable damage
- Hi-Lo functions give alternative power range for different surfaces and applications. Also reduces sound levels for sensitive areas.

39-024 | 1 | NRV200 |

£203.32



Accessory kit included.

Technical	Data
Motor (Watt)	1200
Sound Level (db)	78.1
Power (Volt)	230
Airflow (Litres/Sec)	40
Suction (mm)	2500
Capacity (Ltr)	15 dry/9 wet
Range (m)	28
Weight (kg)	7.1
Dimensions (mm)	355 x 355 x 510
Gaurantee (Years)	2

**CHARLES WET & DRY VACUUM CLEANER**

- Removes dust dirt unblocks sinks and dries floors
- Lightweight aluminium tubes that will not corrode
- HepaFlo filtration raises cleaning standards and provides for clean and convenient emptying when full

39-018 | 1 | CVC370 | £249.99



Technical	Data
Motor (Watt)	875
Brush Speed	N/A
Sound Pressure (db)	79
Bag Capacity (Ltr)	N/A
Cable Range (m)	10
Weight (kg)	7.9
Width (cm)	36

**SEBO BS360 UPRIGHT VACUUM CLEANER**

- premium performance and quality combined with efficiency and economy.
- Designed to be used for extended periods in comfort
- Easy to maintain, with features such as replaceable brush strips and convenient unblocking access points.
- Cleans a wide range of facilities
- Able to clean flat to the floor, it can reach under furniture and its L-shaped head lets it clean under radiators.

39-355 | 1 | £449.99



Accessory kit included.

Technical	Data
Motor (Watt)	1100
Power (Volt)	230
Airflow (Litres/Sec)	40
Suction (mm)	2400
Capacity (Ltr)	6
Range (m)	31.4
Weight (kg)	6.4
Dimensions (mm)	440 x 360 x 250
Gaurantee (Years)	2

**RUC-SAC VACUUM**

- Easy change HepaFlow bags
- Extra large filter system
- Large cleaning range
- Energy efficiency Class A

39-028 | 1 | RSV130 | £323.20



Accessory kit included.

Technical	Data
Motor (Watt)	250
Power (Volt)	36
Airflow (Litres/Sec)	20
Suction (mm)	1000
Capacity (Ltr)	6
Run Time (Mins)	30
Charge Time (Hours)	3.5
Weight (kg)	7.3
Dimensions (mm)	250 x 360 x 550
Gaurantee (Years)	2

**CORDLESS RUC SAC VACUUM**

- Fast and easy recharging minimises downtime
- Accessory kit included
- Supplied with a single battery

39-141 | 1 | RSB140 | **£749.99**



Accessory kit included.

Technical	Data
Motor (Watt)	250
Power (Volt)	36
Airflow (Litres/Sec)	20
Suction (mm)	1000
Capacity (Ltr)	8
Run Time (Mins)	30
Charge Time (Hours)	3.5
Weight (kg)	6.38
Dimensions (mm)	340 x 340 x 340
Gaurantee (Years)	2

**CORDLESS TUB VACUUM**

- Fast and easy recharging minimises downtime
- Incorporates a hand control modue to allow instant on/off operation to save maximum power
- Accessory kit included
- Supplied with a single battery

39-140 | 1 | NBV190 | **£529.99**



Technical	Data
Working Width with Side Brushes (cm)	37.5
Debris Hopper Capacity (L)	2
Battery Power (V)	10.8
Machine Weight with Battery (kg)	2.8v
Dimensions (mm)	310 x 137 x 370
Battery Autonomy (up to min)	40
Charge Time (Hours)	1
Handle Height (max mm)	11

**MEDUSA RECHARGEABLE VACUUM**

- Lightweight and robust
- Flexible handle joint to clean in all directions
- Compact design to clean hard to reach areas
- Clean all types of floors
- Long life, fast charge battery

**1** 39-180 | 1 | **£239.99**  
**2** 39-181 | 1 | Replacement batteries | **£99.99**



**VACUUM BAGS FOR SEBO BS36**

39-034 | 10 |

£8.65



**300MM FLOOR NOZZLE**

• For 39-026, 39-024, 39-028, 39-140 and 39-141

39-045 | 1 |

£21.45



**290MM EASY RIDE AIRO BRUSH 32MM**

- Allows powerbrush results with a tub vacuum
- Quicker and more efficient carpet care
- Removes threads and animal hair effectively
- For 39-026, 39-024, 39-028, 39-140 and 39-141

39-010 | 1 | Colour: Red  
39-011 | 1 | Colour: Black

£48.66  
£56.81



**NVM-1CH HEPAFLO VACUUM BAGS**

- Hepa-flo filtration raises cleaning standards
- 30% improved filtration efficiency
- Provides for clean and convenient emptying when full

39-012 | 10 |

£9.62



**NVM-2BH HEPAFLO VACUUM BAGS**

- Hepa-flo filtration raises cleaning standards
- 30% improved filtration efficiency
- Provides for clean and convenient emptying when full

39-013 | 10 |

£12.99

**Contact us for more details on our wider range of machine accessories.**

**We can provide you with service options to give you peace of mind that your machines are correctly maintained.**

Technical	Data
Vacuum Motor (Watt)	1000
Brush Speed (RPM)	1000
Brush Motor (Watt)	400
Capacity (Ltr)	40
Working Width (mm)	450
Range (m)	42
Weight (kg)	40
Dimensions (mm)	750 x 740 x 480
Gaurantee (Years)	1



**TWINTEC COMPACT SCRUBBER DRYER**

- Compact, easy to operate and manoeuvrable
- Cylindrical power brush ensures deep cleaning
- Swing steering system improves versatility
- Forward and backward cleaning

39-030 | 1 | Single tank | TT1535S | Corded | **£1437.51**

39-031

Technical	Data
Vacuum Motor (Watt)	1000
Brush Speed (RPM)	150
Brush Motor (Watt)	1500
Sound Pressure (db)	79.6
Dimensions (mm)	470 x 890 x 1180
Capacity (Ltr)	15
Working Width (mm)	10
Range (m)	42
Weight (kg)	57
Gurantee (Years)	1



39-049

Technical	Data
Vacuum Motor (Watt)	400
Brush Speed (RPM)	120
Run Time	2hrs 24mins
Brush Motor (Watt)	400
Sound Pressure (db)	73
Dimensions (mm)	470 x 1130 x 1180
Capacity (Ltr)	40
Working Width (mm)	450
Weight (kg)	122
Gurantee (Years)	1

**TWINTEC SCRUBBER DRYER**

- Deck tilt system making brush changes quick and simple
- Fully welded superbly strong steel chassis

39-031 | 1 | Twin tank | TT4045T | Corded | **£2084.24**  
 39-049 | 1 | Twin tank | TTB4045T | Battery | **£3243.99**

Scrubs and dries in a single pass

Technical	Data
Squeegee Width (mm)	590
Working Width (mm)	460
Clean Watertank (L)	4
Recovery Tank (L)	8
Brush (RPM)	350
Brush Pressure (kg)	22
Battery Power (V)	24
Machine Weight with Battery (kg)	21.5
Dimensions (mm)	380 x 1200 x 500
Working Capacity (up to sq.m/h)	1000-1300
Operation Time (Hrs)	1
1 Hour Charging Time	80%
4 Hours Charging Time	100%



**I-MOP**

- Compact design to clean hard to reach areas
- Flexibility of a floor mop with the power and speed of a scrubber drier
- Easily remove solutions tanks for emptying and refill
- Eco mode to save water
- Compact to store

39-175 | 1 | **£3499.99**

Technical	Data
Squeegee Width (mm)	325
Working Width (mm)	280
Solution Tank (L)	3
Recovery Tank (L)	4
Brush Motor (W)	90
Brush (RPM)	150
Brush Pressure (kg)	10
Suction Motor (W)	150
Battery Power (V)	36
Machine Weight with Battery (kg)	20
Dimensions - LxHxW (mm)	555 x 1050 x 375
Suction Motor (V)	36
Forward Speed (km/h)	3.2
Working Capacity (up to sq.m/h)	900
Operation Time	1 Hour
Charging Time	3 Hours



Scrubs and dries in a single pass

**GENIE XS**

- Compact design to clean hard to reach areas
- Flexibility of a floor mop with the power and speed of a scrubber drier
- Easily remove solutions tank for emptying and refill
- Eco mode to save water
- Compact to store
- Forward and backward cleaning
- Simple and intuitive controls

39-194 | 1 | **£1999.99**



Scrubs and dries in a single pass

Technical	Data
Squeegee Width (mm)	395
Working Width (mm)	340
Clean Watertank (L)	1.2
Dirty Water Recovery Tank (L)	1
Brush Motor (W)	24
Vacuum Motor (W)	50
Machine Weight with Battery (kg)	10
Dimensions - L x H x W (mm)	385 x 1295 x 445
Working Capacity (sq.m)	300

**FIMOP BATTERY COMPACT SCRUBBER DRIER**

- Cleans right up to skirting boards and gets into narrow areas
- The vacuum carries the dirty water to the dedicated container
- Fitted with a convenient handle for easy carrying
- Perfect manoeuvrability for scrubbing and drying in all directions

39-200 | 1 |

£1399.99



Technical	Data 420	Data 340
Motor (Watt)	1000	1000
Brush Speed (Mtr/Sec)	4	4
Power (V)	230	230
Sound Pressure (db)	64	64
Brush Pressure (kg)	32	32
Clean Solution Capacity (Ltr)	6	6
Recovery Tank Capacity (Ltr)	3.5	3.5
Weight (kg)	26	26
Dimensions (mm)	420 x 240 x 430	340 x 240 x 430
Guarantee (Years)	1	1

**DUPLEX FLOOR MACHINE**

- Scrubs and dries in a single pass
- Compact design to clean hard to reach areas
- Eco mode to save water
- Compact to store

39-082	Steam kit	1	420 Width	£3175.00
39-005	Standard Kit	1	420 Width	£2750.00
39-089	Steam kit	1	340 Width	£2650.00
39-097	Trolley for Duplex Machine	1		£99.99





Technical	Data
Motor (Watt)	400
Brush Speed (RPM)	150
Power (V)	230
Deck (mm)	330
Pad (mm)	330
Sound Pressure (db)	66.3 brush/57.2 pad
Range (m)	32
Weight (kg)	18
Dimensions (mm)	1145 x 330 x 540
Guarantee (Years)	1

**LOLINE FLOORCARE MACHINE**

- For use on hard floors not carpets
- Includes pad drive for scrubbing, cleaning and polishing
- Full range of brushes and pads allows machine to be used for all the primary floorcare functions
- Extremely low profile enables effective cleaning under furniture

39-015 | 1 | NLL332 |

**£737.64**



**1**



**2**

Technical	Data
Motor (Watt)	1000
Brush Speed (RPM)	S-150, M-230
Power (V)	230
Brush (mm)	450
Pad (mm)	400
Sound Pressure (db)	77
Range (m)	32
Weight (kg)	26
Dimensions (mm)	1250 x 560 x 460
Guarantee (Years)	1
Accessories Included	18" drive board and brush

**HURRICANE STANDARD SPEED FLOOR BUFFING MACHINE WITH DRIVE BOARD**

- Three brush options available for either scrubbing, shampooing or stripping (please specify)
- Quality well engineered tried and tested machine

<b>1</b>	<b>39-068</b>	330RPM	1	High Speed	<b>£969.98</b>
<b>2</b>	<b>39-069</b>	150RPM	1	Standard Speed	<b>£741.30</b>



Open web design promotes self-cleaning, minimise loading on machinery and easier maintenance.

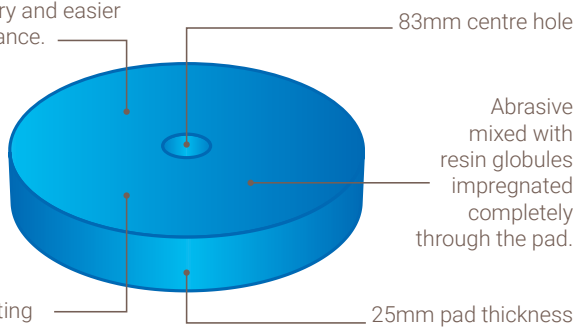

Long lasting layered design allows pad fibres to lie roughly parallel to the floor for improved performance.

**FLOOR PADS**

40-124	5	12"	£15.49
40-125	5	13"	£16.19
40-126	5	14"	£17.49
40-127	5	15"	£19.49
40-128	5	16"	£22.49
40-129	5	17"	£24.49
40-130	5	18"	£28.49
40-131	5	19"	£32.20
40-132	5	20"	£34.49



**Black**

Heavy duty stripping, with standard speed machine. Use on rough and reinforced concrete, tiled floors and natural stone.

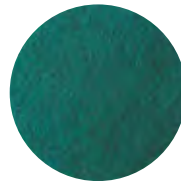

**Green**

Light stripping, heavy scrubbing, with standard speed machine. Use on thermoplastics, rough and reinforced concrete, tiles and stone.



**Blue**

Light scrubbing, spray cleaning, with standard speed machine. Use on thermoplastics, concrete, tiled floors and natural stone.



**Red**

Spray cleaning method with high speed machine. Use on thermoplastics, concrete, tiled floors and natural stone.



**White**

Polishing, with spray brushing method with high speed machine. Use on thermoplastics and protected floors.



**Tan**

Dry polishing and buffing with high speed machine. Use on rough and reinforced concrete, tiled floors and natural stone.

**Our Customer Insight Specialists are available to help and guide you to the appropriate floorcare program for your specific needs.**

**We can provide you with expertise and recommend the best solution to ensure your floor is looked after correctly.**

## TWISTER DIAMOND PADS

This unique new range of floor cleaning pads holds its secret of success in containing millions of tiny diamonds within the pad material. This enables the twister pads to follow the floors contours and mechanically clean and polish the surface. No chemicals are needed for this product, just normal tap water.

They are compatible with all types of floor and are available with most commonly used floor cleaning machines

Available in red, for heavy duty surface renovation, white, for occasional deep cleaning, yellow, for daily polishing and cleaning and green for a high shine

*To rediscover your shine, use the new Twister pads.*

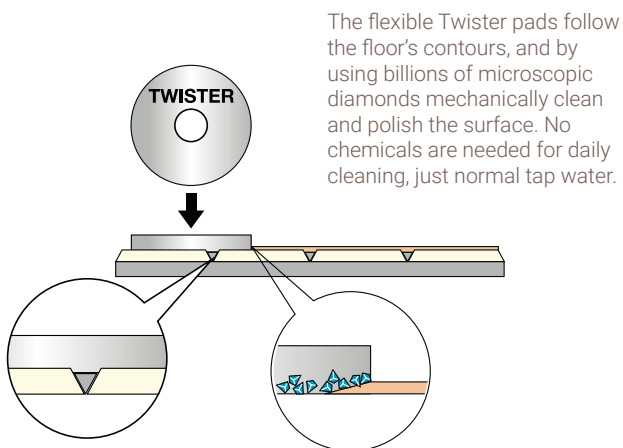

### TWISTER DIAMOND CLEANING SYSTEM

40-479-RD	2	16"	Red	£69.99	40-479-YL	2	16"	Yellow	£41.00
40-480-RD	2	17"	Red	£72.99	40-480-YL	2	17"	Yellow	£66.99
40-481-RD	2	20"	Red	£79.99	40-481-YL	2	20"	Yellow	£72.99
40-479-WH	2	16"	White	£41.00	40-479-GN	2	16"	Green	£41.00
40-480-WH	2	17"	White	£66.99	40-480-GN	2	17"	Green	£65.99
40-481-WH	2	20"	White	£72.99	40-481-GN	1	20"	Green	£72.99

### Advantages

- Clean, shiny floors every day
- Environmentally friendly cleaning method
- Removes up to 80% more bacteria than conventional methods
- Simple implementation – no change in the machines and procedures used
- Diamond pads last 3 times longer than conventional pads, the process is quicker and no chemicals are required, which means drastically reduced cleaning costs

### Reduced Environmental Impact

The focus from organisations and companies on environmental issues has never been greater.

Twister **does not require any chemicals** in daily cleaning to keep the floors clean and shiny. For floors that require floor finish, Twister will reduce the frequency of the periodic maintenance. In addition, using Twister reduces the amount and management of waste and residues. Twister pads are made from recycled PET for minimum environmental impact.

By choosing Twister as your standard method for floor maintenance you will actively, **easily and effectively reduce your business environmental impact.**

### Where can Twister™ be used?

- Natural stone
- Terrazzo
- Vinyl
- Linoleum
- Ceramic Slabs
- VCT
- Rubber
- Wood
- HTC Superfloor™ – Polished Concrete



**V-SWEEPER DUST MOP FRAME & HANDLE**

- 1320mm chrome handles
- Excellent floor coverage ideal for large hallways receptions sports halls
- Synthetic fibre heads attract and trap dust through static charge

40-053	1	V-Sweeper Dust Mop Frame and handle	£72.99
40-054	Pair	V-Sweeper Dust Mop Head Available Colours: BL/RD/WH	£24.00



**DUST MOP**

1	40-072	1	400mm Frame	£6.99
2	40-073	1	600mm Frame	£7.99
3	40-074	1	800mm Frame	£8.49
4	40-080	1	400mm Head	£6.99
5	40-081	1	600mm Head	£7.49
6	40-082	1	800mm Head	£8.49
	41-011	1	Aluminium Handle	£7.99



**STRETCH 'N DUST OIL IMPREGNATED DISPOSABLE FLOOR CLOTH 50PK**

- Oil impregnated wipe ensures optimal pick-up of dust and dirt.
- Perfect for cleaning larger floor areas found in hotels, restaurants and food processing companies.
- Unlike 'wet' cleaning, which provides the perfect moist warm breeding ground for bacteria and micro-organisms, including MRSA, Stretch 'n Dust wipes are the best solution for optimal hygiene using a dry dusting method
- See 40-501 and 40-144 for frame and handle

34-090	12x50	Sheet size: 61 x 30cm	£84.99
40-501	1	Frame	£39.85
40-144	1	Telescopic Handle	£19.99

Cost per 100 sheets: £12.40



**DISPOSABLE HYGIENE MOP ROLL**

- 100 Sheets
- Simply pull off perforated sheets from roll and attach to holder
- Single use sheets are easily removed for disposal

40-059	1	Sheet size: 61 x 21cm	£38.99
40-501	1	Frame	£39.85
40-144	1	Telescopic Handle	£19.99

Cost per 100 sheets: £38.99



**ANDARTA FLOOR POLISH MAINTAINER**

- Use on linoleum, PVC, rubber, terrazzo, wood and thermoplastic floors
- Removes dirt and heel marks
- Will not remove or dull polish
- Excellent for spray cleaning
- Easy to use - no burnishing required
- Highly efficient cleaner
- Pleasant fragrance

40-105 | 5Ltr |

£11.99



**ANDARTA LEMON CITRUS FLOOR JELL**

- For the regular cleaning and maintenance of linoleum, PVC, rubber, sealed cork, sealed wood, terrazzo and thermoplastic floors
- Will not remove or dull polish
- Made from natural citrus oils and vegetable oil derived emulsifiers to be environmentally friendly
- Perfect for spray cleaning, removes dirt and heel marks with ease

40-104 | 5Ltr |

£9.97



**ANDARTA PINE FLOOR JELL**

- Use on linoleum, PVC, rubber, terrazzo, wood and thermoplastic floors
- Removes dirt and heel marks
- Will not remove or dull polish
- Excellent for spray cleaning
- Easy to use - no burnishing required

40-103 | 5Ltr |

£8.22



**ANDARTA MULTI PURPOSE HARD SURFACE CLEANER**

- Use for linoleum, PVC, sealed cork, wood and thermoplastic floors
- Removes soil grease and heel marks

40-107 | 5Ltr |

£6.47



**ANDARTA HEAVY DUTY SCRUBBER DRYER DETERGENT**

- Specially formulated for scrubber drier use
- Rapid action - cleans in one pass
- Controlled foam - will not block suction drier
- Ammoniated for rapid grease cut
- Fully biodegradable and phosphate free

40-109-2 | 2x5Ltr |

£30.65

**DIVERSEY ETERNUM CAREFREE FLOOR POLISH**

- Long lasting high gloss finish for all floor types
- Unique triple polymer technology gives outstanding wear which reduces maintenance time
- Superior resistance to scuffs, marks and dirt, even in high traffic areas
- Extremely easy to apply with mop or applicator



40-220 | 5Ltr |

£42.54

**ANDARTA WET LOOK FLOOR POLISH**

- Use for linoleum, PVC, sealed cork, sealed wood, terrazzo and thermoplastic floors
- Not suitable for unsealed or laminate floors
- Dries to give 'wet look'
- Low maintenance requirement
- Easy to use - no burnishing required
- Maximum scuff resistance



40-100 | 5Ltr | Coverage: 60 metres per litre |

£24.95

**JOHNSON CAREFREE EMULSION**

- Use on vinyl, linoleum, sealed wood, marble and terrazzo floors
- Metalised for longer life
- Long lasting gloss finish
- Spreads evenly without streaks or bubble
- Excellent resistance to scuff marks and dirt



40-050 | 5Ltr |

£40.27

**ANDARTA HIGH SHINE FLOOR POLISH**

- Use for spray burnishing on linoleum, PVC, sealed cork, sealed wood, terrazzo and thermoplastic floors
- 18% solids
- Not suitable for unsealed or laminate floors
- Produces deep shine with excellent slip resistance



40-093 | 5Ltr | Coverage: 60 metres per litre |

£17.85

**JOHNSON BOURNE TRAFFIC LIQUID WAX**

- Use on wood, cork, granwood and terracotta floors
- Cleans and polishes in one application
- Regular buffing with rotary floor machine maintains high standard of appearance



40-049 | 5Ltr |

£51.24

**WOOD WAX POLISH**

- Use on Cork, magnesite and wood
- Not suitable for sealed floors
- Ideal for dance floors
- Produces tough, lustrous finish



40-098 | 5Ltr |

£31.10

**JOHNSON CAREFREE SPEED STRIPPER**

- Powerful fast acting emulsion polish stripper
- No rinse formula can be used for manual or machine applications
- Penetrates through multiple coats of floor polish



40-052 | 5Ltr |

£28.37

**ANDARTA FLOOR POLISH STRIPPER**

- Strips metalised or non-metalised polish from rubber, sealed wood, terrazzo and thermoplastic floors.
- Removes impacted dirt from concrete and non-porous surfaces
- Fresh pine aroma
- No ammonia fumes
- Controlled foam for machine use



40-111 | 5Ltr | Coverage: 40 metres per litre |

£9.08

**ANDARTA RINSE FREE FLOOR STRIPPER**

- Strips metallised or non-metallised polish from concrete, terrazzo, sealed wood and cork floors
- Highly concentrated - no rinsing required
- Low foaming
- Quicker stripping of floors in confined spaces
- Non-caustic



40-108 | 5Ltr | Coverage: 40 metres per litre |

£14.61

**CLEAR VARNISH RESINOUS FLOOR SEALER**

- Use on wood, cork and concrete floors.
- Quick drying clear gloss finish
- Protects and enhances wooden floors
- Prevents break up and dusting of concrete floors



40-113 | 5Ltr | Coverage: 14 metres per litre |

£54.44

**ANDARTA ACRYLIC BASE COAT SEALER**

- Use for spray burnishing on linoleum, PVC, rubber, terrazzo and thermoplastic floors
- Seals porous floors providing base for emulsion
- Non-yellowing film - will not discolour light floors
- Resistant to polish strippers
- Has no resistance to wear
- Finish with emulsion e.g 40-050



40-097 | 4x5Ltr | Coverage: 50 metres per litre |

£25.63

**SHEEPS WOOL FLOOR POLISH APPLICATOR**

- Length: 305mm



40-248	1	Frame	£19.99
40-249	1	Applicator	£11.10
40-024		Wooden Handle	£3.88

- Reduces chemical consumption up to 95% vs. traditional mopping
- Reduces water consumption up to 90% vs. traditional mopping
- Cleans floors more than 3 times faster than traditional string mops



**SWISPO DISPOSABLE MICROFIBRE MOPPING SYSTEM**

- For use in hygiene critical areas such as Isolation and Operating Theatres
- Removes soil, dust and micro-organisms in one operation
- Single use removes the risk of spores surviving the washing problem of standard fit mop systems
- Available colours: BL/GN/RD/YL

Use pre-soaked damp mops to save time and money

- No refilling of buckets
- No wringing of mops
- Reduced water and chemical use

1	41-246	Swispo Mop Pad	50	Available colours: BL/RD/YL	£29.99
2	40-507	Barrier Pad	1		£11.99
3	40-144	Telescopic Handle	1		£19.99
4	41-368	Swispo Mop Frame	1		£27.99



**PULSE MICROFIBRE FLAT MOP**

- Perfect for fast response cleaning
- Weighs only 1.7kg
- User controlled release of solution
- Holds enough water to clean 80sq.m
- Combine with Caddy to clean 930sq.m
- Use with 40-285 head to clean safety floors

Mop Heads can be laundered over 500 times

1	40-282	1	Mopping Frame and Handle	£95.00
2	40-283	1	Portable Caddy	£55.00
3	40-284-BL	1	Microfibre Velcro Mop	£8.22
4	40-285-YL	1	Microfibre Velcro Safety Floor Mop	£10.50



**ULTRASPEED FLAT MOP SYSTEM**

- For all general floor cleaning
- Clean up to 750sq.m per hour
- Easy to use - no training required
- Ergonomic - lightweight, no bending down to wring
- Kit includes: Bucket, Wringer, Dolly-mop frame, Pad and Handle

1	40-147	Ultraspeed Flat Mop Kit	1	£89.49
2	40-145	Ultraspeed Flat Mop Frame	1	£9.99
3	40-146	Ultraspeed Microfibre Pad	1	£8.49
4	40-148	Ultraspeed Safety Floor Mop Pad	1	£12.79
5	40-144	Ultraspeed Telescopic Aluminium Handle	1	£19.99



Clean water mopping

**HI-BAK 1812 MOPPING SYSTEM BLUE**

- Unique separator allowing 18L clean water and 12L dirty water
- Allows larger areas to be cleaned before emptying and refilling
- Suitable for either Kentucky or Flat mops
- 75mm non-marking castors ensure excellent movement
- Available colours: BL/GN/RD/YL

39-076	1	£130.99
--------	---	---------



**VIKAN COMPACT CLEANING TROLLEY PLUS 60**

- Each trolley can be equipped with pre-prepared washable mops and cloths that can be deployed for use on a specific task, on a specific ward or in a designated clinical area
- A simple click system enables contact-free mop head changes, removing cross-contamination risk
- The unique trolley system provides for well-organised and hygienic movement of pre-prepared mops and cloths

40-334 | 1 |

£454.99

**VIKAN TELESCOPIC HANDLE 1160-1800MM**

- Ergonomic handle with patented adjustable system to facilitate better working positions

40-337 | 1 |

£20.19

500 Wash  
guarantee**VIKAN DAMP 42 40CM MICROFIBRE POCKET FLAT MOP**

- Microfibre avoid build up of sticky chemical residue on which bacteria can thrive
- Super absorbent
- Proven to be more effective at removing bacteria from smooth floors

40-336 | 5 |

£45.55

**VIKAN 40CM FLAT MOP FRAME PLATE**

- Highly manoeuvrable to get to hard to reach areas where bacteria can thrive

40-335 | 1 |

£14.99



**SYNTEX MOP HEAD WITH SCOURER**

- Long lasting
- Looped stay-flat band
- Built in scourer to tackle stubborn stains
- Available colours: BL/GN/RD/YL

40-115	1		£8.49
41-158	1	Handle	£9.99



**450G HYGIEMIX KENTUCKY MOP**

- Made from a mix of cotton and synthetic yarn for high strength and superior absorbancy
- Does not rot or smell
- Launderable
- Looped ends give greater water retention and avoid linting
- Stay flat band retains mop shape
- Abrasive centre pad to remove stubborn stains
- Available colours: BL/GN/RD/WH/YL

40-090	1		£7.99
41-001	1	Handle	£13.49



**250G AQUASORB SOCKET MOP**

- Made from a mix of cotton and synthetic yarn for high strength and superior absorbancy
- Does not rot or smell
- Launderable
- Looped ends give greater water retention and avoid linting
- Stay flat band retains mop shape
- Heavier and longer lasting compared to standard mops
- Available colours: BL/GN/RD/RD/YL

40-092	1		£4.99
41-264	1	Handle	£8.49



**PY KENTUCKY MOP**

- Low cost
- High strength and absorbancy
- Thick absorbant yarn for everyday use

40-116	10	12oz	£20.99
40-118	10	16oz	£26.49
41-001	1	Handle	£13.49
40-043	1	Handle	£11.99



**200G SOCKET MOP**

- Low cost
- High strength and absorbancy
- Thick absorbant yarn for everyday use
- Simple to fit and remove heads
- Available colours: BL/GN/RD/WH/YL

40-078	1	Twine Yarn	£1.99
40-079	1	PY Yarn	£1.99
41-264	1	Handle	£8.49



**HEAVY CORDED SOCKET MOP**

- Low cost
- 100% cotton in PY or Twine
- CHSA approved

40-084	10	12oz	£16.99
40-085	10	16oz	£23.99
40-023	1	Handle	£1.52
40-024	1	Handle	£3.88

**MOP HANDLE**

- Handle colours: BL/GN/RD/YL

1	41-011	1	1360mm Threaded Aluminium Handle	£7.99
2	41-001	1	Aluminium Handle with Galvanised Kentucky Clip	£13.49
3	41-002	1	Aluminium Handel with Plastic Kentucky Clip	£12.64
4	41-264	1	Excel Handle	£8.49
5	41-158	1	Interchange Handle	£9.99

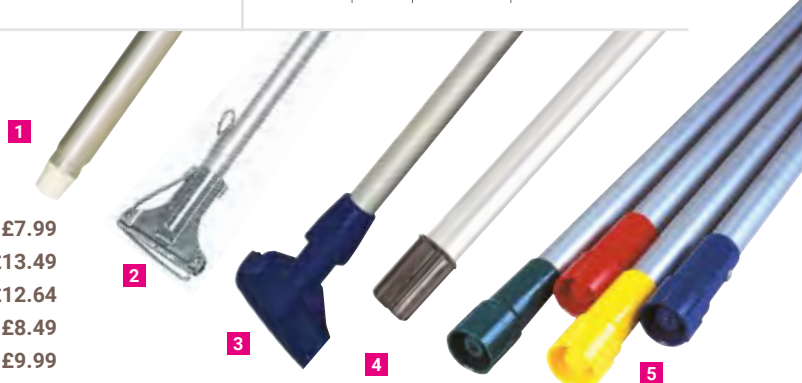



**DISPOSABLE KENTUCKY MOP**

- Lint free
- Absorbs 75% more water than cotton
- Doesn't rot or smell
- Autoclavable
- Floors dry quicker and areas are back in use quicker
- 50% lighter than cotton
- Picks up and releases 30% more dirt than ordinary cotton mops
- Abrasive centre pad to help remove stubborn stains

<b>40-065</b>	10			<b>£30.86</b>
<b>41-001</b>	1	Handle		<b>£13.49</b>



**DISPOSABLE KENTUCKY SOCKET MOP**

- Absorbs 75% more water than a cotton mop
- Easy to wring out
- Machine washable
- Lighter than a cotton Kentucky mop
- Available colours: BL/GN/RD/YL

<b>40-257</b>	1			<b>£3.30</b>
<b>41-264</b>	1	Handle		<b>£8.49</b>



**DISPOSABLE SOCKET MOP**

- Doesn't rot or smell
- Picks up and releases 30% more dirt than ordinary cotton mops
- Available colours: BL/GN/RD/WH/YL

<b>40-206</b>	10			<b>£14.05</b>
<b>41-264</b>	1	Handle		<b>£8.49</b>



**DISPOSABLE LOOPED STAYFLAT SYRSORB MIDI MOP**

- Stay flat band retains mop shape
- Doesn't rot or smell
- Picks up and releases 30% more dirt than ordinary cotton mops
- Looped ends give greater water retention and avoid linting
- Available colours: BI/RD/YL

<b>40-143</b>	10			<b>£28.55</b>
<b>41-158</b>	1	Handle		<b>£9.99</b>



**KENTUCKY MOP HOLDER**

<b>1 40-043</b>	Kentucky Mop Holder and Stale	1	<b>£11.99</b>
<b>2 41-109</b>	Plastic Clip	1	<b>£3.49</b>

**20 LTR MOP BUCKET & WRINGER**

- Colours: BL/GN/RD/YL

40-120 | 1 |

£69.49

**15 LTR GALVANISED MOP BUCKET**

40-077 | 1 |

£23.99

**12 LTR MOP BUCKET**

- Colours: BL/GN/RD/YL

40-087 | 1 |

£5.99

**10 LTR STAINLESS STEEL BUCKET**

40-029 | 1 |

£90.25

**12 LTR GALVANISED BUCKET**

40-076 | 1 |

£10.99

**14 LTR ROUND BUCKET**

- Colours: BL/YL/GN/RD

40-028 | 1 |

£9.99

**15 LTR PLASTIC BUCKET BLACK**

40-089 | 1 |

£9.99

**10 LTR PLASTIC BUCKET**

- Colours: BL/GN/GY/RD/WH/YL

40-088 | 1 |

£4.40

**25 LTR PLASTIC BUCKET**

- Available colours: BL/GN/RD

40-027 | 1 |

£24.99

**WATER FILLING DEVICE**

- Use the water filling device for quick, simple and ergonomic filling of buckets and other containers at any tap
- Simply put the rubber attachment over the tap, attach the other end to the bucket and fill with water
- Compatible with most standard taps

39-115 | 1 |

£33.94



See page 81  
for our  
anti-slip and  
hazard warning  
products

# WASTE MANAGEMENT

Products included in this category...



**Bin Liners**



**Clinical Waste Sacks**



**Litter Control**



**Outdoor and  
Indoor Litter Bins**



**WASTE  
MANAGEMENT**



**ARROW**  
COUNTY SUPPLIES

Experts in  
**hygiene and  
cleanliness**  
solutions.



## Support

You can depend  
on us to listen to you  
and take ownership  
of things to make sure  
you get the answer and  
solutions you need

 [arrowcounty.com](https://arrowcounty.com)



### ANDARTA 29x34 HEAVY DUTY BLACK SACK IN DISPENSER CARTON

- Convenient size and portable - weighs only 2.8kg
- Dispenses one sack a time
- Sack is on a roll, providing easy, trouble free dispensing
- Strong cardboard carton
- 686mm x 1168mm x 1320mm

**35-025** | 100 | **£12.99**  
Cost per 100 bags: £12.99



### ANDARTA 30x46x54 90G WHEELIE BIN LINER

- Made from 100% recycled polythene taken from post consumer waste
- Provides a superior tear and puncture resistant bag
- Bag is designed to stretch rather than tear

**35-016** | 100 | Black | Light Duty / 90G | **£17.20**  
Cost per 100 bags: £17.20



### 22x33x47 COMPACTOR SACK

- Made from 100% recycled polythene taken from post consumer waste
- Provides a superior tear and puncture resistant bag
- Bag is designed to stretch rather than tear

**35-018** | 100 | Black | Extra Heavy Duty / 300G | **£31.60**  
Cost per 100 bags: £31.60

**35-012** | 100 | Clear | Extra Heavy Duty / 250G | **£34.68**  
Cost per 100 bags: £34.68



### 19x35x38 REFUSE SACK

- Made from 100% recycled polythene taken from post consumer waste
- Provides a superior tear and puncture resistant bag
- Bag is designed to stretch rather than tear

**35-006** | 1 | Black | Heavy Duty / 200G | **£41.20**  
Cost per 100 bags: £6.72



### ANDARTA 18x29x39 REFUSE SACK

- Made from 100% recycled polythene taken from post consumer waste
- Provides a superior tear and puncture resistant bag
- Bag is designed to stretch rather than tear
- 18 x 29 x 39

**35-040** | 200 | Black | Heavy Duty / 160G | **£29.46**  
Cost per 100 bags: £14.73



### ANDARTA 18x29x39 HIGH PERFORMANCE CLEAR SACK

- Made from 100% recycled polythene taken from post consumer waste
- Provides a superior tear and puncture resistant bag
- Bag is designed to stretch rather than tear

**35-029** | Clear | 400 | Medium Duty | **£53.05**  
Cost per 100 bags: £13.26



**ANDARTA 18x29x39 STANDARD REFUSE SACK**

- Made from 100% recycled polythene taken from post consumer waste
- Provides a superior tear and puncture resistant bag
- Bag is designed to stretch rather than tear

<b>35-023</b>	200	Black	Extra Heavy Duty / 180G	<b>£29.10</b>
			Cost per 100 bags: £14.55	
<b>35-022</b>	200	Black	Heavy Duty / 160G	<b>£24.67</b>
			Cost per 100 bags: £12.34	
<b>35-008</b>	200		Heavy Duty / 160G	<b>£36.57</b>
			Cost per 100 bags: £18.28	
<b>35-005</b>	200	Black	Medium Duty / 140G	<b>£21.42</b>
			Cost per 100 bags: £10.71	
<b>35-032</b>	200	Black	Medium Duty / 120G	<b>£13.27</b>
			Cost per 100 bags: £6.64	

**WHITE SWING BIN LINER**

<b>1</b>	<b>35-007</b>	13x23x30	Flat Pack	500	Heavy Duty / 80G	<b>£32.99</b>
					Cost per 100 bags: £6.60	
<b>2</b>	<b>35-014</b>	13x23x30	5 Rolls x 100	Medium Duty / 60G	<b>£37.08</b>	
					Cost per 100 bags: £7.42	
<b>3</b>	<b>35-010</b>	15x24x24	Square	1000	Light Duty / 7MU	<b>£18.94</b>
					Cost per 100 bags: £1.89	
<b>4</b>	<b>35-011</b>	13x23x30		1000	Light Duty / 7MU	<b>£28.90</b>
					Cost per 100 bags: £2.89	



**11x17x18 PEDAL BIN LINER WHITE**

<b>1</b>	<b>35-013</b>	5 Rolls x 100	Medium Duty / 7MU	<b>£14.95</b>
				Cost per 100 bags: £1.50
<b>2</b>	<b>35-009</b>	1000	Light duty / 7MU	<b>£12.50</b>
				Cost per 100 bags: £1.25



**YELLOW CLINICAL WASTE SACK ROLL**

• Star Weld Seal on all gusseted sacks

<b>35-034</b>	25 Sacks per roll	360 x 711 x 990mm	11KG / Extra Heavy Duty	<b>£9.00</b> Cost per 100 bags: £36.00
<b>35-081</b>	25 Sacks per roll	360 x 711 x 990mm	8kg / Heavy Duty	<b>£3.60</b> Cost per 100 bags: £14.40
<b>35-036</b>	50 Sacks per roll	711 x 990mm	5kg / Medium Duty	<b>£6.36</b> Cost per 100 bags: £12.73
<b>35-062</b>	8 Rolls x 25 Sacks	345 x 180 x 125mm	5kg / Medium Duty	<b>£16.50</b> Cost per 100 bags: £12.73
<b>35-035</b>	50 Sacks per roll	220 x 430 x 660mm	3kg / Medium Duty	<b>£2.55</b> Cost per 100 bags: £5.09



**ORANGE CLINICAL WASTE SACK ON ROLL**

• Star Weld Seal on all gusseted sacks

<b>35-090</b>	25 Sacks per roll	360 x 711 x 990mm	10KG / Extra Heavy Duty	<b>£9.00</b> Cost per 100 bags: £36.00
<b>35-072</b>	25 Sacks per roll	711 x 990mm	5kg / Medium Duty	<b>£3.18</b> Cost per 100 bags: £12.72
<b>35-096</b>	6 Rolls x 25 Sacks	279 x 432 x 660mm	11KG / Extra Heavy Duty	<b>£44.85</b> Cost per 100 bags: £29.90
<b>35-120</b>	50 Sacks per roll	559 x 635mm	8kg / Heavy Duty	<b>£5.28</b> Cost per 100 bags: £10.56
<b>35-059</b>	50 Sacks per roll	279 x 430 x 660	5kg / Medium Duty	<b>£4.13</b> Cost per 100 bags: £8.26
<b>35-078</b>	50 Sacks per roll	220 x 430 x 660mm	3kg / Medium Duty	<b>£2.55</b> Cost per 100 bags: £5.09



**YELLOW TIGER STRIPE SACK ON ROLL**

• Star Weld Seal on all gusseted sacks

<b>35-103</b>	6 Rolls x 25 Sacks	380 x 711 x 990mm	Heavy Duty	<b>£37.47</b> Cost per 100 bags: £24.98
<b>35-117</b>	25 Sacks per roll	711 x 990mm	Heavy Duty	<b>£3.26</b> Cost per 100 bags: £13.02
<b>35-077</b>	50 Sacks per roll	220 x 430 x 660mm	3kg	<b>£2.72</b> Cost per 100 bags: £5.44



**CLEAR NHS PRINTED SACK ON ROLL**

• Star Weld Seal

<b>35-091</b>	50 Sacks per roll	381 x 711 x 990mm	Heavy Duty	<b>£7.29</b> Cost per 100 bags: £14.57
<b>35-080</b>	50 Sacks per roll	330 x 533 x 609mm	Light Duty / 120G	<b>£2.75</b> Cost per 100 bags: £8.48



**BLACK NHS PRINTED SACK ON ROLL**

• Star Weld Seal

<b>35-116</b>	50 Sacks per roll	736 x 990mm	Heavy Duty	<b>£5.00</b> Cost per 100 bags: £10.00
<b>35-149</b>	50 Sacks per roll	380 x 711 x 990mm	Light Duty / 120G	<b>£0.67</b> Cost per 100 bags: £0.01
<b>35-088</b>	50 Sacks per roll	300 x 560 x 635mm	Light Duty / 120G	<b>£2.75</b> Cost per 100 bags: £5.50



## TUBESAC BIN LINERS

- Bin liner cassette up to 100m long which reduces maintenance time
- Incredibly strong and durable polythene reduces likelihood of bags splitting and contents spilling
- No contact with waste improves hygiene
- Safe and watertight. Seal by either cable tie or knotting ensures the bag won't split
- Change bag from the side
- An endless bag
- Close, empty and load a new bag in 15-25 seconds

### Helps the Planet:

- Reduced amount of polythene used
- 15 times lower CO<sub>2</sub> emission than ordinary bags because they are always filled to 100% capacity
- Lower weight and compact packaging results in reduced transport costs



## Here's how TubeSac cuts your bag replacements to 15-25 seconds...



**05** Lift the bag out to the side

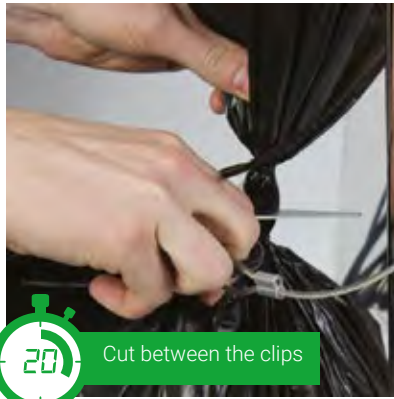

**20** Cut between the clips



**10** Gather the bag



**25**

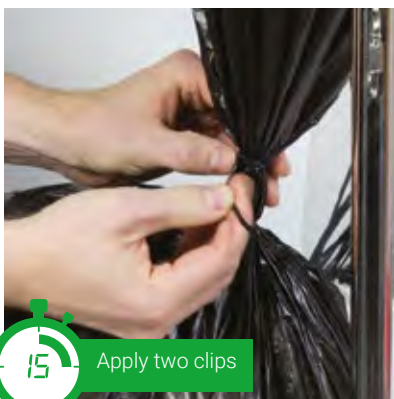

**15** Apply two clips



### TUBESAC CASSETTE POLYTHENE LINER

35-132	Small	Black		£21.75
35-134	Small	Clear		£24.75
35-133	Large	Clear		£52.75
35-135	Large	Black		£57.75
35-136	Small	Tubesac Frame Stainless Steel	Size: H840mm x W390	£116.00
35-137	Large	Tubesac Frame Stainless Steel	Size: H1060mm x W600mm	£135.00
35-138	Small	Tubesac Frame Grey Metal	Size: H840mm x W390	£55.80
35-139	Large	Tubesac Frame Grey Metal	Size: H1060mm x W600mm	£76.50



**LOBBY DUSTPAN SET**

- Container and brush with long handle make ergonomic sweeping possible without bending
- With the adjustable hooks, the set can be variably attached to the cleaning trolley, the brush is stowed hygienically in the closed container

41-323-BL | 1 |

£33.00



**LOBBY BRUSH**

- This product is ideal for sweeping lobby areas

41-084 | 1 |

Lobby Dustpan

£20.70

41-110 | 1 |

Lobby Brush

£10.50



**LITTER PICKER**

- 810mm
- Ideal for picking up bottles and litter without bending over
- Can pick up objects as small as matchsticks or needles

42-003 | 1 |

£16.95



**90CM NIFTY NABBER**

- 900mm
- Indoor or outdoor use
- Rust proof
- Rubberised jaws for secure pickup

42-010 | 1 |

£12.85

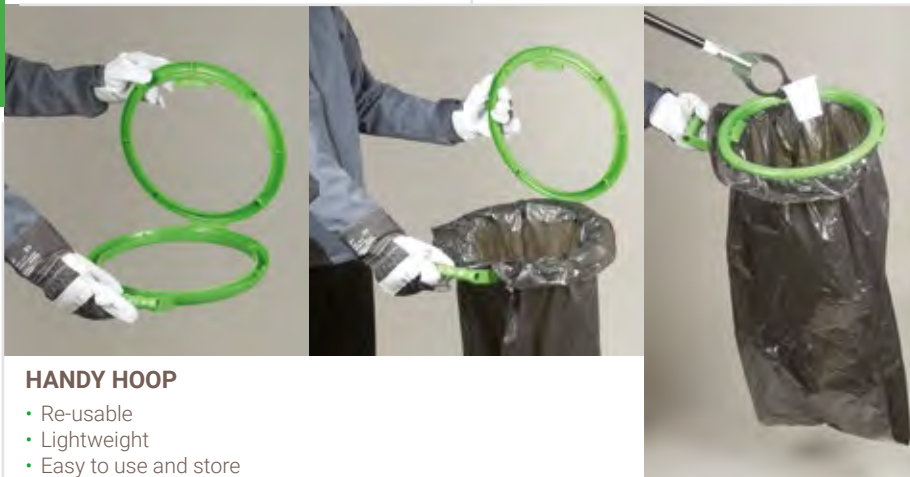

**HANDY HOOP**

- Re-usable
- Lightweight
- Easy to use and store

43-014 | 1 |



Available colours: BL/GN/RD/YL

£8.49



**FREE STANDING PEDAL OPERATED SACKHOLDER**

- H860 x W440 x D370mm
- Epoxy coated finish
- Wide base plate and 4 legs for stability

43-002 | 1 |

£142.85



**WALL MOUNTED SACK HOLDER WITH LID**

- H120 x W440 x D360mm

43-006 | 1 |

£59.69



### 140 LTR WHEELIE BIN

- H930 x W480 x D555mm
- 200mm solid rubber tyre on plastic rim
- Solid steel plated axle
- Available colours: BL/GN/GY/YL

43-020 | 1 |

£49.99



### 240 LTR WHEELIE BIN

- H1070 x W580 x D740mm
- 200mm solid rubber tyre on plastic rim
- Solid steel plated axle
- Available colours: GN/RD/YL

43-021 | 1 |

£54.99



### 80 LTR BLACK DUSTBIN & LID

- H620 x D500mm
- Moulded handles for extra strength
- Tough and hygienic
- Fully stackable

43-022 | 1 |

£16.75

### 54 LTR RECYCLING BIN KIT

- Kit contains 3 x 54ltr top bins including colour coded lids and labels
- Choice of four labels for contents - paper, card, aluminium cans and plastics - cover most common requirements
- Durable - will not rust, dent, chip or peel
- Swing top ensures waste is kept out of sight
- Maintenance free
- Complies with WRAP and "Recycle Now" accreditations

43-035 | 3 |



£61.93



### 50 LTR SWING TOP BIN C/W LID

- H710 x W330 x D330mm
- Simple yet solid design
- Available colours: BK/BL/GN/GY/RD/WH/YL

43-023 | 1 |

£17.49



### 15 LTR METAL WASTE BIN

- H279 x D305mm

43-007 | 1 |

£9.65



### 3 LTR METAL PEDAL BIN WHITE

- H270 x D170mm
- Supplied with plastic liner

43-011 | 1 |

£17.20



**90LTR 2 WAY HOODED OUTDOOR LITTER BIN**

- Chamfered edges to litter posting apertures ensures the rubbish is directed in to the liner without overspill between the liner and the outer case.
- Inner steel reinforcing frame prevents removal or overturning.
- Key-lock secures outer case to steel liner.
- Removable outer case and liner allow for cleaning around and beneath bin.
- Made of 90% recyclable materials.
- An economic alternative to steel or stainless steel.
- Colour options: Blue, Green, Red, Yellow

43-046 |

£269.95

Chamfered edge to litter posting aperture ensures rubbish is directed into the liner without overspill between liner and outer case.

Made of 90% recycled materials.

Removal of lockable outer case and liner allows cleaning of area beneath and around location of bin.

Key-lock secures outer case of steel liner.



The only plastic litter bin in the UK with an inner steel reinforced frame designed to prevent removal or overturning by vandals.



“We are more than just the supplier of a product; our service provision embraces a larger customer journey..”

# CATERING

Products included in this category...



**Disposable Cups  
and Glasses**



**Disposable  
Food Containers**

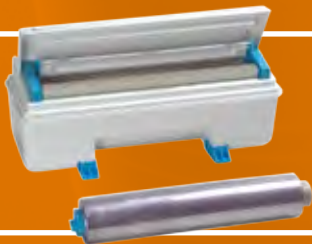

**Clingfilm, Foil  
and Food Papers**



**Napkins and  
Napkin Systems**



**Disposable Tableware,  
Bags and Kitchen Roll**



**CATERING**



**We help our customers improve efficiency** by operating a responsive ordering and logistics system to ensure they can continue working effectively and minimise their own stockholding





**MONO SQUAT CUP HOLDERS BLUE**

- Sturdy design
- Holds plastic 7oz or 9oz squat vending cups
- Made from recycled plastic

27-072 | 1 | £3.00



**9OZ SPECIALITY HOT CUP**

27-004 | 1000 | £115.14



**7OZ WHIZZ PAPER CUP**

27-003 | 2000 | £135.45



**FLEXI STRAWS IN DISP PACK**

- Convenient dispensing box

27-102 | 250 | £2.95



**7OZ INSULATED CUP**

27-007	10oz Lid	1000	£43.99
27-012	10oz	1000	£47.50
27-014	7oz	1000	£31.45



**7OZ VENDING CUP**

- Ideal for dispensing

27-017	Squat	2000	£36.95
27-018	Tall	2000	£36.95



**CLEAR PLASTIC GLASSES**

27-021	8oz	1000	£85.10
27-025	Lids	1000	£45.50

**Clarity**

We can provide clear and simple communications to keep you updated on product and legislation changes, ensuring you remain safe, legal and compliant



**PAPER PLATE**

27-035	1000	21cm
27-036	1000	18cm
27-037	1000	14cm

£48.99
£39.99
£31.49



**SANDWICH WEDGE**

27-076	500	Deep Fill
27-077	500	Standard Single

£49.99
£32.99



**HB10 BURGER & FRIES BOX**

• 229 x 127 x 76mm

27-068	250
--------	-----

£27.99



**HB9 FAST FOOD BOX**

• 178 x 127 x 76mm

27-071	250
--------	-----

£24.49



**HB6 LARGE BURGER BOX**

• 127 x 127 x 76mm

27-067	500
--------	-----

£33.49

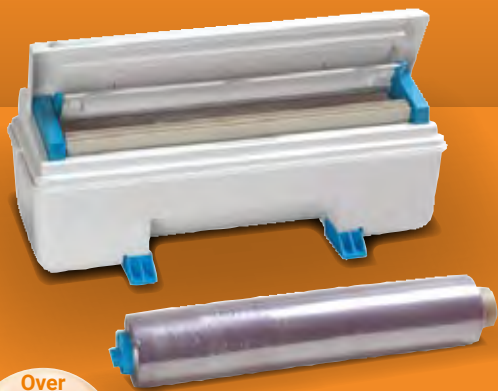

Over 500,000 dispensers in use worldwide



**WRAPMASTER 3000**

- 30cm Wide
- Dispenses product intact and tangle free every time
- Proven to reduce waste by up to 35%
- Protected cutting systems

28-005	3	30cm Film Refill Roll	£29.49
28-009	1	Wrapmaster Dispenser	£41.49



Over 500,000 dispensers in use worldwide



**WRAPMASTER 4500**

- 45cm Wide - Dispenses film or foil
- Dispenses product intact and tangle free every time
- Proven to reduce waste by up to 35%
- Protected cutting systems

28-003	3	45cm x 90m Foil Refill Roll	£44.85
28-006	3	45cm x 300m Film Refill Roll	£44.49
28-010	1	Wrapmaster 4500 Dispenser	£41.49

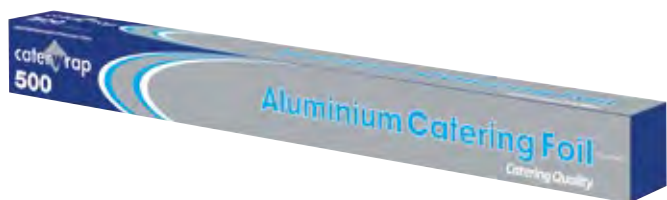

**20" FOIL IN CUTTER BOX**

- 50x 75m long
- High volume roll in neat compact box

28-011	1		£12.99
--------	---	--	--------



**CLINGFILM CUTTER BOX**

- 300m long
- Soft flexible film with high cling properties

28-014	1	30cm	£7.99
28-015	1	45cm	£10.99



**45CM ROASTING FILM**

- 45cm wide x 90m long
- Withstands temperatures up to 200°C
- Strong and crystal clear film

28-016	1		£11.99
--------	---	--	--------



**CATERWRAP BAKING PARCHMENT**

- 45cm wide by 75m long
- Wipe clean dispenser box with cutter
- For use in conventional and microwave ovens

28-027	1		£13.49
--------	---	--	--------



**TORK INTERFOLD NAPKINS 1PLY**

1	29-053	6000	2 Ply Premium	£97.99
2	29-055	1	Dispenser	£47.99
3	29-056	9000	1 Ply Universal	£89.99

**PAPER NAPKINS WHITE**

1	29-036-WH	White	40cm	1000	3 Ply	£48.50
2	29-035-WH	White	40cm	2000	2 Ply	£64.70
3	29-034	■ ■ ■ ■	33cm	2000	2 Ply	£55.60
4	29-005-WH	White	33cm	5000	1 Ply	£38.49
5	29-004	White	Fast Fold	6000	1 Ply	£57.99



**115CMx100M PAPER BANQUET ROLL**

- 115cm x 100m long

29-009 | 1 |

£31.30



**KATRIN 2PLY WHITE KITCHEN ROLL**

- 32 rolls x 76 sheets
- Soft and absorbant
- Approved for direct contact with food
- Certified under the Nordic Swan Eco Label

29-023 | 32 |

£46.20



**PLASTIC CUTLERY**

29-028	5000	Stirrers
29-029	1000	Knives
29-030	1000	Forks
29-031	1000	Dessert Spoons
29-032	1000	Teaspoons

£21.99

£17.49

£17.49

£17.49

£17.49



**FILM FRONT BAGS**

30-029-08	1000	8.5" x 8.5"
30-030-10	1000	10" x 10"

£17.95

£22.20



**8.5"x8.5" WHITE PAPER BAGS**

30-026 | 1000 |

£10.35

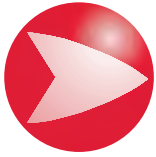

**Arrow**  
COUNTY SUPPLIES

Experts in  
**hygiene and  
cleanliness**  
solutions.

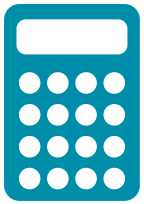

## Quick Quote

Want a comparative price fast?  
Then our **Quick Quote** system  
could be perfect for you. Get  
access to personalised advice,  
a huge range of great products  
with a quick response

**Ask about our Andarta range  
for even more savings**

➤ [arrowcounty.com](https://arrowcounty.com)

# PPE

Products included in this category...



**Disposable PPE**



**Gloves**



**Ear, Face and  
Head Protection**



**Safety Footwear**



**Hi-visibility Clothing**



**PPE**



**ARROW**  
COUNTY SUPPLIES

Experts in  
**hygiene and  
cleanliness**  
solutions.



**Supply**

You can trust us  
to keep our promises  
so you can keep yours

 [arrowcounty.com](http://arrowcounty.com)





**HAIRTITE HAIRNET**

- 2 x better hair containment than traditional 5mm mesh hairnets
- 4 x better hair containment when worn under a mob cap

<b>49-098</b>	Detectable	3x48	<b>£20.46</b>
<b>49-100</b>	Non-Detectable	2x50	<b>£19.49</b>



**STANDARD HAIRNETS**

- Close mesh. Double elasticated headband

<b>49-041</b>	144	Knotted	<b>£19.55</b>
<b>49-042</b>	2x50	Knotted	<b>£17.49</b>
<b>49-027</b>	2x50	Stapled	<b>£20.25</b>



**PLEATED MOB CAP**

- 12gsm
- Latex free
- Double stapled for extra strength and durability
- Available colours: BL/GN/RD/WH/YL

<b>49-019</b>	10x100	<b>£31.49</b>
---------------	--------	---------------



**WHITE NON WOVEN SNOOD CAPS**

<b>49-023</b>	50	<b>£6.50</b>
---------------	----	--------------



**NON-WOVEN BEARD MASKS**

<b>49-025</b>	100	Available colours: BL/WH	<b>£4.25</b>
---------------	-----	--------------------------	--------------



**BEARD SNOODS BLUE**

<b>49-029-BL</b>	36	<b>£9.49</b>
------------------	----	--------------



**PVC NYLON APRON**

• 380gsm.

49-008 | 1 |

£6.60



**APRON TIES**

49-010 | 1 |

£0.99

**NYLON BUTCHERS APRON**

• 380gsm.

49-003 | 1 |

£6.49



**NON WOVEN VISITORS COATS**

49-016 | 50 | Available sizes: Medium/Large/XL/2XL/XXXL | £48.30



**HEAVY WEIGHT PVC APRON WHITE**

49-005 | 1 |

£3.25



**TYVEK PROTECH HOODED COVERALL**

49-001 | Each | Available sizes: Medium/Large/XL/2XL | £8.15

**POLYPROP COVERALL**

• 380gsm.

49-002 | Each | Available colours: NA/WH | Available sizes: Medium/Large/XL |

£1.85





**VINYL GLOVES**

• Available sizes: Small/Medium/Large/XL

50-027	100	Blue	£5.95
50-028	100	Clear	£5.95
50-026	100	Clear Powderfree	£5.95

**LATEX GLOVES**

• Available sizes: Small/Medium/Large/XL

50-054	100	Blue	£6.30
50-025	100	Clear Powderfree	£7.15
50-029	100	Clear	£6.30



**BLUE NITRILE POWDERFREE GLOVES**

• Available sizes: Small/Medium/Large/XL  
• 5 gram

50-053	100	£9.84
--------	-----	-------

**MICRON POWDERFREE NITRILE GLOVES**

• Available sizes: Small/Medium/Large/XL  
• 3.6 gram

50-046	200	£15.78
--------	-----	--------



**APRON ROLL DISPENSER**

- Efficient dispensing of a single apron reducing waste

49-033 | 1 | £29.29

**27x42 POLYTHENE APRONS**

49-053-BL	5 Rollsx100	50mu - Heavy Duty	Blue	£59.95
49-013	5 Rollsx200	16mu - Standard		£44.99
49-014	1000	Bulk Aprons		£41.49



**16" DELUXE OVERSHOE WHITE**

49-039 | 400 | £76.51



**ANDARTA 16" PVC OVERSHOES**

- Made from embossed CPE
- Elasticated edges

49-035 | 2000 | Available colours: BL/GN/RD/YL | £61.30



**PVC OVERSLEEVES**

49-021 | Pair | £1.20



**ANDARTA POLYTHENE OVERSLEEVES BLUE**

- Elasticated Edges
- Suitable for minimal risk protection offering high levels of hygiene

49-020 | 2000 | Available colours: BL/RD/YL | £60.36



**CLEAR POLYTHENE GLOVES LARGE**

50-031-03 | 10x100 | £7.90



**KEVLAR LATEX GLOVES MEDIUM**

- Available sizes: Medium/Large/XL
- Premium cut resistance
- 100% Kevlar knitted liner
- Latex coating enhances grip in wet or dry
- Excellent dexterity

**50-010** | 10 Pairs | **£91.49**  
Cost per Pair: £9.15



**FREEZER/DRIVER GLOVES**

- Soft flexible premium leather
- Thick felt lining for insulation and comfort
- Elasticated back for snug fit
- Size: Large

**50-022** | Pair | **£6.99**  
Cost per Pair £6.99



**PVC 45CM GAUNTLETS RED**

- Tough PVC coating
- Flared for easy donning and removal
- Soft cotton liner
- Two lengths available
- Size: universal

**50-021** | 12 Pairs | **£38.99**  
Cost per Pair: £1.71



**GRISTLE KNIT WRIST GLOVES YELLOW**

- Economic protection for all low risk applications
- Crinkled finish for enhanced wet/dry grip
- Waterproof latex keeps hands dry
- Size: universal

**50-013** | 12 Pairs | **£27.29**  
Cost per Pair: £1.40



**FURNITURE HIDE RIGGER GLOVES RAINBOW**

- Elastic tensioner
- Knuckle strap
- Size: universal

**50-004** | 10 Pairs | **£17.99**  
Cost per Pair: £1.25



**CRISS-CROSS GLOVES YELLOW**

- Extremely tough and difficult to tear
- Webbed PVC criss cross pattern for improved wet/dry grip
- Open construction allows hands to breathe
- Size: universal

**50-024** | 10 Pairs | **£11.00**  
Cost per Pair: £1.10



**RED PVC F/C KNIT WRIST GLOVES SZ 09**

- Available sizes: 9/10
- Knitted wrist helps prevent ingress of foreign material
- Fully REACH compliant

**50-102** | 12 Pairs | **£11.49**  
Cost per Pair: £0.96



**LATEX PALM COATED BLUE GLOVE**

- Available sizes: Medium/Large/XL
- Excellent wet or dry grip
- Light and flexible for maximum dexterity
- Comfortable, seamless knitted liner

**50-002** | 10 Pairs | **£8.99**  
Cost per Pair: £0.89



**COTTON STOCKINETTE KNITWRIST GLOVE**

- Very comfortable
- Can be used to provide additional protection when handling delicate products
- Size: universal

**50-023** | 10 Pairs | **£2.99**  
Cost per Pair: £0.30



### LONG NITRILE GAUNTLETS

- For protection against oil, grease and strong detergents
- Length: 640mm
- Comfortable cotton liner

50-040 | Pair |

£25.99



### HEAVY WEIGHT 45CM BLACK GAUNTLET

- Flared cuff makes removal easier
- Gauntlet style adds more protection
- REACH Compliant
- Available sizes: 8/9/10

50-006 | Pair |

£7.99



### MEDIUM WEIGHT 45CM BLACK GAUNTLET

- Flared cuff makes removal easier
- Gauntlet style adds more protection
- REACH Compliant
- Available sizes: 9/10

50-007 | Pair |

£14.59



### NITRILE GLOVES

- Slip resistant pattern on palm
- Flock lined
- 310mm length
- Protects against most solvents inc. petroleum
- Available sizes: Small/Medium/Large/XL
- Available colours: BL/GN

50-035 | 12 Pairs |

£25.70



### HEAVY WEIGHT RUBBER GLOVES BLACK

- Slip resistant pattern on palm
- 320mm length
- Flock lined
- Available sizes: Medium/Large/XL

50-056 | 10 Pairs |

£17.99



### MEDIUM WEIGHT RUBBER GLOVES

- Slip resistant pattern on plant
- Lightweight and flexible
- Flock lined
- Available sizes: Small/Medium/Large/XL
- Available colours: BL/GN/RD/YL

50-030 | 12 Pairs |

£10.20

**WHISPER PLUS DETECT  
CORDED EAR PLUG**

- Highly visible and metal detectable

51-009 | 50 Pairs | £94.50

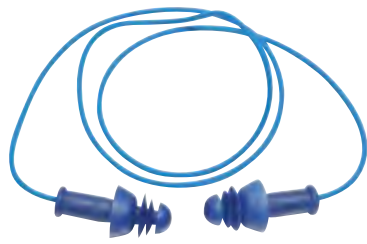
**METAL DETECTABLE  
THREE FLANGE CORDED  
EAR PLUG**

51-047 | 200 | £189.99

**X-FIT CORDED  
DETECT EAR PLUGS**

- Highly visible and metal detectable

51-013 | 100 | £72.40

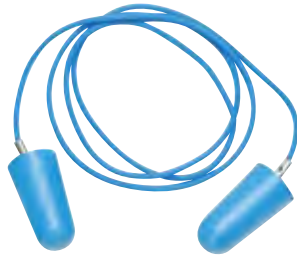
**BLUE DISPOSABLE PU  
FOAM DETECTABLE  
CORDED EAR PLUGS**

51-019 | 200 | £84.45

**P3 VALVED DUST MASK**

- Reliable and cost effective

53-011 | 5 | £16.49

**P2 VALVED DUST MASK**

- Reliable and cost effective

53-010 | 10 | £11.49

**P2 DUST MASK**

- Reliable and cost effective

53-009 | 20 | £17.49

**P1 VALVED DUST MASK**

- Reliable and cost effective

53-008 | 10 | £8.99

**P1 DUST MASK**

- Reliable and cost effective

53-007 | 20 | £15.49

**NUISANCE DUST MASKS**

- Reliable and cost effective

53-006 | 50 | £6.99





**DIEGO SAFETY SPECS**

• Ultra lightweight

54-014 | 1 |

£3.49



**BUDGET GOGGLES**

• Comfortable and lightweight

54-015 | 1 |

£1.49



**ECONOMY EAR DEFENDER**

• SNR 27dB

51-030 | 1 |

£5.49



**WHITE SAFETY LACE UP SHOE**

• Available sizes: 4-12

52-003 | Pair |

£37.00



**WHITE SLIP ON SAFETY BOOT**

• Available sizes: 4-12

52-006 | Pair | £37.00



**BLACK SAFETY BOOT & MIDSOLE**

• Available sizes: 4-13

52-035 | Pair | £21.45



**BLACK SMOOTH TIE SAFETY SHOE**

• Available sizes: 6-13

52-036 | Pair | £29.85



**SAFETY SHOE BLACK**

• Available sizes: 4-13

52-026 | Pair | £20.95





### PUROFORT SAFETY WELLINGTONS

- Available sizes: 6-12
- 35% lighter than conventional boots
- Flexible and supple, even at low temperatures
- Lasts two or three times longer than conventional boots
- Extremely comfortable, warm in winter and cool in summer
- Chemical, oil and fat resistant
- shock absorbing

<b>52-017</b>	White	Pair	<b>£81.60</b>
<b>52-018</b>	Green	Pair	<b>£81.60</b>



### WHITE PVC WELLINGTONS

- High grade PVC/nitrile formulation provides improved chemical and wear resistance
- Strong
- Watertight
- Good grip
- Available sizes: 4-13

<b>52-033</b>	Safety	Pair	<b>£23.85</b>
<b>52-034</b>	Non-Safety	Pair	<b>£17.85</b>



### GREEN PVC WELLINGTONS

- Strong
- Watertight
- Good grip
- Available sizes: 6-13

<b>52-030</b>	Non-Safety	Pair	<b>£13.05</b>
<b>52-032</b>	Safety	Pair	<b>£20.65</b>



### DUNLOP BLACK SAFETY WELLINGTONS

- Available sizes: 6-12
- Strong
- Watertight
- Good Grip

<b>52-025</b>	Pair	<b>£23.85</b>
---------------	------	---------------



**HI-VIS JACKET YELLOW**

- EN471 class 3 and EN343
- PU coated polyester
- Inside breast pocket
- Available sizes: Small/Medium/Large/XL/2XL

59-001-YL | 1 |

£31.30



**HI-VIS WAISTCOAT**

- EN471 class 2
- 100% polyester
- Velcro fastener
- Content piping
- Available sizes: Small/Medium/Large/XL/2XL/3XL/4XL

59-005-YL | 1 |

£5.10









Code	Page	Code	Page	Code	Page	Code	Page	Code	Page	Code	Page	Code	Page	Code	Page
01-002	12	08-028	36	28-003	131	33-354	66	35-018	119	40-080	108	41-058	88	46-011	80
01-005	12	08-035	36	28-005	131	33-363	65	35-022	120	40-081	108	41-059	88	46-024-LRG	81
01-012	13	08-039-450	31	28-006	131	33-378	69	35-023	120	40-082	108	41-060	88		
01-014	12	08-047	35	28-009	131	33-386	60	35-025	119	40-084	114	41-061	87	48-033	92
01-016	13	08-058	32	28-010	131	33-406	55	35-029	119	40-085	114	41-062	87	48-034	92
01-017	13	08-062	32	28-011	131	33-407	55	35-032	120	40-087	116	41-063	88	48-104	80
01-018	13	08-069	31	28-014	131	33-410	63	35-034	121	40-088	116	41-064	88	48-105	80
01-019	13			28-015	131	33-416	57	35-035	121	40-089	116	41-067	87		
01-020	13	09-001	37	28-016	131	33-428	60	35-036	121	40-090	114	41-068	87	49-001	138
01-022	13			28-027	131	33-429	69	35-149	121	40-092	114	41-070	87	49-002	138
01-023	13	10-006	38			33-430	69	35-040	119	40-093	110	41-071	87	49-003	138
01-025	13	10-012	38	29-004	132	33-432	58	35-059	121	40-097	111	41-072	87	49-005	138
01-026	13	10-014	34	29-005-WH	132	33-445	52	35-062	121	40-098	110	41-073	87	49-008	138
01-029	14	10-015	34	29-009	133	33-446	67	35-072	121	40-100	110	41-078	89	49-010	138
01-031	14	10-016	35	29-023	133	33-455	67	35-077	121	40-103	109	41-079	89	49-013	140
01-033	16	10-030	36	29-028	133	33-455-5L	67	35-078	121	40-104	109	41-080	89	49-014	140
01-034	12	10-041-2	38	29-029	133	33-512	63	35-080	121	40-105	109	41-081	88	49-016	138
01-041	16	10-045	32	29-030	133	33-513	63	35-081	121	40-107	109	41-082	88	49-019	137
01-050	17			29-031	133	33-515	66	35-088	121	40-108	111	41-083	90	49-020	140
01-058	13	11-003	35	29-032	133	33-516	66	35-090	121	40-109-2	109	41-084	123	49-021	140
01-059	13	11-011	33	29-034	132	33-517	63	35-091	121	40-111	111	41-087	89	49-023	137
01-063	15	11-012	32	29-035-WH	132	33-521	56	35-096	121	40-113	111	41-089	82	49-025	137
01-066	15	11-014	33	29-036-WH	132	33-522	56	35-103	121	40-115	114	41-090	87	49-027	137
01-071	16			29-053	132	33-523	56	35-116	121	40-116	114	41-093	89	49-029-BL	137
01-074	12	12-002	35	29-055	132	33-524	56	35-117	121	40-118	114	41-094	89	49-033	140
		12-008	38	29-056	132	33-533	51	35-120	121	40-120	116	41-096	83	49-035	140
02-001	20	12-009	38			33-535	51	35-132	122	40-121	87	41-097	85	49-039	140
02-002	23	12-011	36	30-026	133	33-536	51	35-133	122	40-124	106	41-099	85	49-041	137
02-003	19	12-012	38	30-029-08	133	33-539	51	35-134	122	40-125	106	41-100	85	49-042	137
02-004	23	12-022	36	30-030-10	133	33-593	48	35-135	122	40-126	106	41-103	85	49-053-BL	140
02-005	23	12-026	32			33-597	62	35-136	122	40-127	106	41-104	85	49-098	137
02-008	20			33-001	58	33-606	49	35-137	122	40-128	106	41-105	85	49-100	137
02-011	23	13-006	37	33-005	61	33-603-CL-TF	55	35-138	122	40-129	106	41-109	115		
02-015	20	13-008	37	33-006	68	33-603-GN-SA	55	35-139	122	40-130	106	41-110	123	50-002	141
02-019	21	13-010	37	33-024	58	33-603-OR-TF	55			40-131	106	41-113	90	50-004	141
02-020	21	13-033	37	33-028	54	33-603-PU-BE	55	36-004	93	40-132	106	41-114	90	50-006	142
02-023	19	13-036	37	33-033	66	33-603-PU-LV	55	36-005	93	40-143	115	41-115	89	50-007	142
02-027	20			33-036	63	33-605	48	36-008	93	40-144	108	41-116	89	50-010	141
02-035	19	14-001	37	33-037	63	33-610	48	36-009	95	40-144	108	41-117	89	50-013	141
02-043	20	14-003	37	33-038	63	33-611	49	36-011	93	40-144	112	41-118	91	50-021	141
02-045	18	14-004	37	33-039	63	33-612	55	36-064	93	40-144	112	41-119	91	50-022	141
02-057	19			33-045	64	33-613	53	36-066	93	40-145	112	41-120	91	50-023	141
02-060	19	15-002	37	33-046	69	33-616	63			40-146	112	41-122	91	50-024	141
02-066	21	15-010	37	33-047	69	33-617	65	37-001	84	40-147	112	41-123	90	50-025	139
02-069	19	15-015	37	33-063	59	33-618	48	37-003	84	40-148	112	41-124	90	50-026	139
02-070	21	15-034	35	33-064	53	33-619	67	37-004	84	40-150	82	41-126	92	50-027	139
02-071	21	15-040	38	33-066	69	33-620	66	37-006	84	40-153	82	41-128	92	50-028	139
02-076	20	15-045	38	33-067	69	33-623	66	37-007	84	40-154	80	41-130	92	50-029	139
02-077	21	15-048	34	33-029-2	58	33-624	48			40-164	94	41-131	92	50-030	142
02-085	20	15-061	31	33-071	64	33-629	63	39-005	104	40-166	82	41-132	92	50-031-03	140
		15-062	36	33-072	64	33-630	65	39-010	102	40-194	80	41-137	92	50-035	142
04-003	26	15-063	36	33-077	55	33-631	67	39-011	102	40-196	94	41-139	92	50-040	142
04-008	24	15-066	36	33-082	69	33-639	59	39-012	102	40-206	115	41-144	89	50-046	139
04-009	24	15-068	36	33-088	57	33-640	59	39-013	102	40-220	110	41-145	89	50-053	139
04-011	24	15-097	33	33-095	58	33-641	49	39-015	105	40-248	111	41-146	88	50-054	139
04-012	25	15-098	32	33-096	64	33-642	49	39-018	100	40-249	111	41-147	88	50-056	142
04-013	25	15-099	32	33-097	67	33-644	68	39-024	99	40-251	94	41-148	88	50-102	141
04-014	25	15-104	37	33-099	59	33-645	51	39-026	99	40-257	115	41-149	89		
04-021	26	15-105	37	33-100	65			39-028	100	40-282	112	41-150	89	51-009	143
04-022	26	15-109	32	33-101	65	34-001	78	39-030	103	40-283	112	41-153	89	51-013	143
04-024	26	15-110	33	33-102	54	34-002	78	39-031	103	40-284-BL	112	41-158	114	51-019	143
04-030-BL	27	15-115	32	33-103	65	34-003	78	39-355	100	40-285-YL	112	41-158	114	51-030	144
04-030-WH	27			33-104	65	34-004	83	39-034	102	40-327	82	41-158	115	51-047	143
04-032	25	17-001	38	33-107	61	34-006	83	39-045	102	40-334	113	41-162	89		
04-037	24	17-002	38	33-108	67	34-016	77	39-049	103	40-335	113	41-163	88	52-003	144
				33-109	61	34-017	73	39-068	105	40-336	113	41-164	88	52-006	144
05-001	28	19-002	79	33-110	59	34-020	75	39-069	105	40-337	113	41-165	90	52-017	145
05-004	28	19-012	62	33-111	53	34-022	75	39-076	112	40-461	82	41-179	90	52-018	145
		19-014	38	33-112	65	34-025	77	39-082	104	40-479-GN	107	41-196	88	52-025	145
06-002	25	19-015	38	33-113	58	34-027	74	39-084	99	40-479-RD	107	41-204	90	52-026	144
06-004	12	19-019	79	33-114	58	34-028	77	39-089	104	40-479-WH	107	41-221	90	52-030	145
06-006	23	19-033	79	33-115	58	34-029	78	39-097	104	40-479-YL	107	41-224	89	52-032	145
06-007	23	19-034	79	33-117	58	34-031	77	39-115	116	40-480-GN	107	41-246	112	52-033	145
06-010	13	19-062	79	33-118	58	34-033	74	39-140	101	40-480-RD	107	41-247	87	52-034	145
06-011	13	19-064	79	33-120	53	34-037	77	39-141	101	40-480-WH	107	41-249	84	52-035	144
06-014	13	19-066	79	33-128	62	34-044	74	39-175	103	40-480-YL	107	41-251	87	52-036	144
06-019	14			33-132	66	34-048	78	39-180	101	40-481-GN	107	41-253	87		
06-025	23	21-002	41	33-134-2	55	34-053	78	39-181	101	40-481-RD	107	41-255	85	53-006	143
06-026	41	21-004	41	33-141	61	34-054	74	39-194	103	40-481-WH	107	41-264	114	53-007	143
06-027	41	21-005	41	33-143	59	34-055	78	39-200	104	40-481-YL	107	41-264	114	53-008	143
06-028	13	21-007	41	33-147	62	34-055	93			40-490	78	41-264	114	53-009	143
06-029	13	21-008	41	33-148	62	34-057	77	40-004							

<b>A</b>			
Absorbent Products	74-76		
Acrylic Floor Seal	111		
Air Fresheners	57		
Andarta			
- Centrefeed Rolls	41		
- Cleaning Chemicals	45-69		
- Floorcare Chemicals	97-116		
- Hand Towels	18-27		
- Hand Soap	32-38		
- Refuse Sacks	119-122		
- Toilet Tissue	12-17		
- Wet Wipes	38, 62, 79		
Aprons			
- Disposable	140		
- Durable	138		
Automatic Air Freshener	57		
Autocut System Hand Towel	24-27		
<b>B</b>			
Bags - Paper, Poly, Film Front & Carrier	133		
Baking Parchment	131		
Banquet Roll	133		
Barrier Creams	37		
Bathroom Cleaner	52		
Battery Operated Machines - Scrubber Dryer	103		
Beard Masks/Snoods	137		
Binbags	119-123		
Bins	124, 125		
Bio-hazard Spill Kit	80		
Biological Urinal Blocks	56		
Biological Washroom Cleaner	56		
Bleach	58		
Brush Hangers	85		
Brushware			
- Hygiene	86-90		
- Wooden	94		
Buckets	112, 116		
Buckets - Window Cleaning	112		
Buffing Machine	105		
Bulk Pack Toilet Tissue	13		
Butchers Apron	140		
<b>C</b>			
Car Cleaning Products	93		
Carpet Cleaning Machines	99-101, 104		
Carpet Shampoo	61		
Catering Disposables	129-133		
Centrefeed Rolls	41		
Chamois Leather	93		
Channel Blocks	55, 56		
Chewing Gum Remover	61		
Chlorine Tablets	58		
Cleaning Cloths	73-77		
Cleaning Machines	99-101, 103-105		
Cleaning Trolleys	82		
Clingfilm	131		
Clinical Waste Sacks	121		
Clothing	146		
Coats	138, 146		
Cobweb Brush	83		
Colour Coded			
- Brushware	87-89		
- Cloths	74-76		
- Mops	114, 115		
- Scourers	77, 78		
Coloured Refuse Sacks	120		
Compact Hand Towel	19		
Compactor Sacks	119		
Cooking Film	131		
Cordless Vacuums	101		
Coreless Toilet Roll	14		
Coveralls	138		
Coverspecs	114		
Cream Cleaner	53		
Cups - Plastic, Paper, Polystyrene	129		
Cutlery - Plastic	133		
<b>D</b>			
Deb Handcare Products	31, 33, 34, 37		
Defoamer	61		
Degreasers			
- Food Areas	66, 67		
- Industrial	60, 66		
Dettol surface cleaner	67		
Deodoscreens	55		
Descaler	66		
Detectable			
- Earplugs	143		
- Hairnets	137		
Detergents	61, 63, 65		
Dishcloths	77		
Dishwasher Powder	64		
Dishwashing Detergents	63		
Disinfectant Wipes	79		
Disinfectants	58		
Dispensers			
- Aprons	140		
- Gloves	139		
- Napkins	132		
- Paper Towels	18-28		
- Roll Towels	24-27		
- Soap	31-38		
- Toilet Paper	12-17		
- Wet Wipes	79		
Disposable			
- Aprons	140		
- Clothing	138, 140		
- Coveralls	138		
- Drinking Glasses	129		
- Gloves	139, 140		
- Mops	108		
- Wipes	79		
Domestos	58		
Dosing System	48, 49, 51		
Drain Cleaners	68		
Drink Straws	129		
Duplex Floor Cleaning Machine	104		
Dustbins	124		
Dusters	77		
Dustmasks	143		
Dustpans	90		
<b>E</b>			
Ear Plugs & Defenders	143		
Eliminator Cleaning Products	56, 60		
Eye Protection	144		
<b>F</b>			
Fabric Conditioners	69		
Facial Tissues	28		
Film Front Bags	133		
Flash Liquid	54		
Flat Mopping System	112, 113		
Flat Pack Tissues	28		
Flexi Duster	83		
Floor Cleaning Chemicals	60, 61, 65, 66, 67, 109-110		
Floor Machines	99-105		
Floor Pads	106-107		
Floor Seal	111		
Floorcare Chemicals	109-110		
Floorcloths	77		
Floorstand			
- Rolls	43		
- Dispensers	43		
Flushable Paper Products	23		
Foam Soap System	32-36		
Foaming Sanitiser	32, 33, 35, 56		
Foil			
- Cooking	131		
Food Area Sanitiser	67		
Food Containers	130		
Food Papers	131		
Food Trays	130		
Footwear	144, 145		
Forage Hats	137		
Furniture Polish	59		
<b>G</b>			
Glass Cleaner	59		
Glass Cleaning Cloth	52, 73		
Gloves	139, 141, 142		
Goggles	144		
Gojo Hand Soap Systems	37, 32		
Graffiti Removers	62		
Graffiti Wipes	62		
Granular Salt	64		
Greaseproof Paper	131		
Grit Bins	95		
Grit Spreaders	95		
<b>H</b>			
Hairnets	137		
Hand Cleaners Industrial	37		
Hand Protection	141, 142		
Hand Sanitisers	31, 32, 35, 36		
Hand Shovels	92		
Hand Soap	32-38		
Hand Towels - Paper	18-27		
Handles	83, 84, 87, 94		
Hand Wipes	38		
Hard Surface Cleaner	48-54, 59, 60, 62, 67		
Headwear - Disposable	137		
Hearing Protection	143		
Henry Vacuum	99		
Hi-Visibility Garments	146		
Horizon Washing Powder	69		
Hygiene Brushware	86-89		
Hygiene Rolls	43		
<b>I</b>			
Industrial Skin Care	33, 37		
<b>J</b>			
Janitorial Trolleys	82		
Jumbo Toilet Rolls	13		
<b>K</b>			
Katrin System Dispenser	16, 24		
Kentucky Mops	114, 115		
Kevlar Gloves	141		
Kitchen Rolls	133		



<b>L</b>			
Latex Gloves		141	
Laundry Chemicals		69	
Limescale Removal	49, 53, 54, 55, 59, 66		
Liquid Hand Soap	32, 36, 37, 38		
Litter Bins		124, 125	
Litter Picker		123	
<b>M</b>			
Machine Dishwashing	63, 64		
Mansize Tissues	28		
Medical Wipes	28		
Metal Polish	59		
Microfibre Cloth	73, 76		
Microfibre Mopping System	112, 113		
Mini Jumbo Toilet Rolls	13		
Miracle Scourer	78		
Mob Caps	137		
Mobile Barrier	80		
Mops	112-115		
Mop Buckets	116		
<b>N</b>			
Nail Brushes	89		
Napkins	132		
NHS Bin Bags	121		
Nitrile Gloves	139, 142		
Non Woven Cloths	75		
Numatic Machines	99-101, 105		
<b>O</b>			
Odour Control	56-58		
Outdoor Litter Bins	124, 125		
Oven Cleaner	66		
Oven Gloves	77		
Overshoes	140		
Oversleeves	140		
<b>P</b>			
Paper Bags	133		
Paper Hand Towels	18-27		
Paper Wipers	41-43		
Pedal Bin Liners	120		
Pedal Bins	124		
Pelican Pumps	54		
Persil	69		
Pine Jell	109		
Plates - Paper	130		
Pledge Polish	59		
Polishes - Floor	109, 110		
Polishes - Furniture	59		
Polycotton Snood Caps	137		
Polypropylene Coverall	138		
Polystyrene - Cups	129		
- Food Containers	130		
- Trays	130		
Poolside Cleaner	53		
Probe Wipes	79		
Pulse Mopping System	112		
Puractive Scourers	78		
Purell Instant Hand Sanitisers	31, 32, 35		
PVC Aprons	138		
PVC Overshoes/Sleeves	140		
<b>Q</b>			
Quilted Jackets	146		
Quick & Easy	50, 51		
Quick & Easy belt	82		
<b>R</b>			
Recycling Bins	124		
Refuse Sacks	119-122		
Resin Set Brushware	86-89		
Respiratory Protection	143		
Rigger Gloves	141		
Rinse Aid	63		
Rock Salt	95		
Rock Salt Spreaders	95		
Roll Towels	24-27		
Rubber Gloves	142		
Ruc Sac Vacuum	100, 101		
<b>S</b>			
Sack Holders	123		
Sacks	119-122		
Safety Footwear	144		
Sandwich Wedges	130		
Sanitisers - Hand	31, 32, 35, 36		
Sanitising Station	31		
Scoops	92		
Scouring Pads	78		
Scrapers	90		
Scrubber Dryers	103, 104		
Scrubbing Brushes	88, 89		
Sebo Upright Vacuum	100		
Shampoo - Carpet	61		
Shoes - Safety	144		
Shovels	92		
Signs - Caution	80, 81		
SlipStop	70, 81		
Snood Caps	137		
Snow Scoop	92		
Soap Bars	38		
Soap Pads	77		
Specialist Wipers	42, 43		
Soap Systems	32-38		
Solid Air Freshener	57		
Spectacles - Safety	144		
Spill Control Kit	80		
Sponges	78		
Sponge Scourers	78		
Spot 'n' Stain Remover	60, 61, 63		
Squeegee - Window	84		
Squeegees - Floor	112		
Stainless Steel Cleaner	59, 73, 77		
Steam Cleaner	103, 104		
Stirrers	133		
Stockinette Gloves	141		
Stockinette Dish Cloths	77		
Straws - Drinking	129		
Strippers - Floor	111		
Swing Bin Liners	120		
Swing Bins	124		
Syntex Mops	114		
SYR Mops	114, 115		
<b>T</b>			
Take Away Food Boxes	130		
Tea Towels	77		
Tear and Dry Hands Free Dispenser	26		
Telescopic Handles	83, 84, 113		
Thermal Gloves	141		
Toilet Brushes	55		
Toilet Cleaners	55, 56		
Toilet Rolls	11-17		
Tork - H1 Hand Towel Roll	25		
Tork - N1 Napkin System	132		
Tork - T6 Toilet Roll	17		
Tork - W4 Folded Wipe	42, 76		
Touch Free Soap Dispenser	32		
Traffic Film Remover	93		
Tray Tidy	82		
Trigger Spray Bottles	51, 54		
Trilbies	137		
Trolleys Cleaning	82, 113		
Tyvek Coveralls	138		
<b>U</b>			
Upright Scrubber Dryer	103, 104		
Upright Vacuum	100		
Urinal Blocks	55		
Urinal Screens	55		
<b>V</b>			
V- Sweeper	108		
Vacuums	99-102		
Vehicle Cleaning Products	93		
Vending Cups	129		
Versatwin Toilet Rolls	14		
Vikan Microfibre System	113		
Vileda Cloths	74, 76		
Vileda Scouring Pads	78		
Vinyl Gloves	139		
Visitors' Coats	138		
Vomit Powder	80		
<b>W</b>			
Washing Powder	69		
Washing Up Liquid	65		
Washroom Cleaners	52, 53		
Waste Bins	124, 125		
Water Soluble Handtowels	20, 23		
Wax Floor Polish	110		
Wellington Boots	145		
Wet Floor Signs	81		
Wet Wipes	38, 79		
Wheeled Bins	124		
Wheelie Bin Liners	119		
Window Cleaning Products	51, 59, 73		
Wipers - Low Lint	43		
- Non Woven	75		
- Paper	42, 43		
Wire Brush	88		
Wrapmaster System	131		
Beer Line Cleaner	66		
Plastic Cutlery	133		
Brackets, Hangers and Rails	85		
Ceramic Tile Cleaner	62		
Salt and Grit Bin	95		
Tube Sac Bin Liners	122		

**STANDARD TERMS AND CONDITIONS OF SALE**

**1. Interpretation**

1.1 The definitions and rules of interpretation in this condition apply in these conditions.

**Business Day:** a day (other than a Saturday, Sunday or public holiday) when banks in London are open for business;

**Buyer:** the person, firm or company who purchases the Goods from the Company;

**Company:** Arrow County Supplies Ltd; Contract: any contract between the Company and the Buyer for the sale and purchase of the Goods;

**Delivery Point:** the place where delivery of the Goods is to take place under condition 4;

**Goods:** any goods agreed in the Contract to be supplied to the Buyer by the Company (including any part(s) of them);

**Limit of Indemnity:** currently the maximum amount of £5,000,000 for all occurrences during any one period of insurance;

**VAT:** value added tax chargeable under English law for the time being and any similar additional tax;

Reference to a law is reference to it as it is in force for the time being taking account of any amendment, extension, application or re-enactment and includes any subordinate legislation for the time being in force made under it.

Words in the singular include the plural and in the plural include the singular.

Reference to one gender includes reference to the other.

Condition headings do not affect the interpretation of these conditions.

**2. Application of Terms**

2.1 Subject to any variation under condition 2.3 the Contract shall be on these conditions to the exclusion of all other terms and conditions (including any terms or conditions which the Buyer purports to apply under any purchase order, confirmation of order, specification or other document).

2.2 No terms or conditions endorsed on, delivered with or contained in the Buyer's purchase order, confirmation of order, specification or other document shall form part of the Contract as a result of such document being referred to in the Contract.

2.3 These conditions apply to all the Company's sales and any variation to these conditions and representations about the Goods shall have no effect unless expressly agreed in writing and signed by a director of the Company. The Company's sales representatives have no authority to accept, vary or amend any of these conditions. The Buyer acknowledges that it has not relied on any statement, promise or representation made or given by or on behalf of the Company which is not set out in the Contract. Nothing in this condition shall exclude or limit the Company's liability for fraudulent misrepresentation.

2.4 Each order or acceptance of a quotation for Goods by the Buyer from the Company shall be deemed to be an offer by the Buyer to buy Goods subject to these conditions.

2.5 No order placed by the Buyer shall be deemed to be accepted by the Company until a written acknowledgement of order is issued by the Company or (if earlier) the Company delivers the Goods to the Buyer.

2.6 The Buyer shall ensure that the terms of its order and any applicable specification are complete and accurate.

2.7 Any quotation is given on the basis that no Contract shall come into existence until the Company despatches an acknowledgement of order to the Buyer. Any quotation is valid for the period set out on the quotation or, in the absence thereof for 30 days, provided that the Company has not previously withdrawn it.

**3. Description**

3.1 The quantity and description of the Goods shall be as set out in the Company's quotation or acknowledgement of order.

3.2 All samples, drawings, descriptive matter, specifications and advertising issued by the Company and any descriptions or illustrations contained in the Company's catalogues or brochures are issued or published for the sole purpose of giving an approximate idea of the Goods described in them. They shall not form part of the Contract and this is not a sale by sample.

**4. Delivery**

4.1 Unless otherwise agreed in writing, delivery of the Goods shall take place at the Buyer's usual place of business. The costs of delivery are included in the Price of the Goods. However, the Company reserves the right to make a reasonable charge associated with any additional costs of carriage where the Buyer's usual place of business or the agreed place of delivery is more than 50 miles from the Company's premises and an additional administration charge of £10 in respect of orders with a total value of less than £50.

4.2 Any dates specified by the Company for delivery of the Goods are an estimate and time for delivery shall not be made of the essence by notice. If no dates are specified, delivery shall be within a reasonable time.

4.3 Subject to the other provisions of these conditions the Company shall not be liable for any direct, indirect or consequential loss (all three of which terms include, without limitation, pure economic loss, loss of profits, loss of business, depletion of goodwill and similar loss), costs, damages, charges or expenses caused directly or indirectly by any delay in the delivery of the Goods (even if caused by the Company's negligence), nor shall any delay entitle the Buyer to terminate or rescind the Contract unless such delay exceeds three months.

4.4 If for any reason the Buyer fails to accept delivery of any of the

Goods, or the Company is unable to deliver the Goods on time because the Buyer has not provided appropriate instructions, documents, licences or authorisations:

- (a) risk in the Goods shall pass to the Buyer (including for loss or damage caused by the Company's negligence); and
- (b) the Goods shall be deemed to have been delivered; or
- (c) the Company may store the Goods until delivery, whereupon the Buyer shall be liable for all related costs and expenses (including, without limitation, storage and insurance).

4.5 The Buyer shall provide at the Delivery Point and at its expense adequate and appropriate equipment and manual labour for loading or unloading of the Goods.

4.6 The Company may cancel delivery if the Company believes it would be unsafe/unlawful, unnecessarily or difficult to deliver to the Delivery Point and delivery shall take place upon the return of the Goods to the Company's place of business.

4.8 The Company may deliver the Goods by separate instalments. Each separate instalment shall, subject to condition

4.9 Be invoiced and paid for in accordance with the provisions of the Contract.

4.9 Each instalment shall be a separate Contract and no cancellation or termination of any one Contract relating to an instalment shall entitle the Buyer to repudiate or cancel any other Contract or instalment.

**5. Non-Delivery**

5.1 The quantity of any consignment of Goods as recorded on despatch from the Company's place of business shall be conclusive evidence of the quantity received on delivery unless the Buyer can provide conclusive evidence proving the contrary.

5.2 The Company shall not be liable for any non-delivery of Goods (even if caused by the Company's negligence) unless the Buyer gives written notice to the Company of the non-delivery within 7 days of the date when the Goods would in the ordinary course of events have been delivered.

5.3 Any liability of the Company for non-delivery of the Goods shall be limited to replacing the Goods within a reasonable time or issuing a credit note at the pro rata Contract rate against any invoice raised for such Goods.

**6. Risk/Title**

6.1 The Goods are at the risk of the Buyer from the time of delivery.

6.2 Where applicable, risk in transit shall remain with the Company until delivery at the Delivery Point provided that in the event of any damage to the Goods during transit the Company will replace any goods proved to the Company's satisfaction to have been damaged in transit subject to having received from the Buyer within 48 hours after delivery notification in writing of the occurrence of the damage and also, if and so far as practicable, of its nature and extent.

6.3 Ownership of the Goods shall not pass to the Buyer until the Company has received in full (in cash or cleared funds) all sums due to it in respect of:  
(a) the Goods; and  
(b) all other sums which are or become due to the Company from the Buyer.

6.4 Until ownership of the Goods has passed to the Buyer, the Buyer shall:  
(a) hold the Goods on a fiduciary basis as the Company's bailee;  
(b) store the Goods (at no cost to the Company) separately from all other goods of the Buyer or any third party in such a way that they remain readily identifiable as the Company's property;  
(c) not destroy, deface or obscure any identifying mark or packaging on or relating to the Goods; and  
(d) maintain the Goods in satisfactory condition and keep them insured on the Company's behalf for their full price against all risks to the reasonable satisfaction of the Company. On request the Buyer shall produce the policy of insurance to the Company.

6.5 The Buyer may resell the Goods before ownership has passed to it solely on the following conditions:

- (a) any sale shall be effected in the ordinary course of the Buyer's business at full market value; and
- (b) shall be a sale of the Company's property on the Buyer's own behalf and the Buyer shall deal as principal when making such a sale.

6.6 The Buyer's right to possession of the Goods shall terminate immediately if:  
(a) any of the matters set out in condition 11.1 (a) to (c) occur; or  
(b) the Buyer encumbers or in any way charges any of the Goods.

6.7 The Company shall be entitled to recover payment for the Goods notwithstanding that ownership of any of the Goods has not passed from the Company.

6.8 The Buyer grants the Company its agents and employees an irrevocable licence at any time to enter any premises where the Goods are or may be stored in order to inspect them or where the Buyer's right to possession has terminated, to recover them.

6.9 Where the Company is unable to determine whether any Goods are the goods in respect of which the Buyer's right to possession has terminated, the Buyer shall be deemed to have sold all goods of the kind sold by the Company to the Buyer in the order in which they were invoiced to the Buyer.

6.10 On termination of the Contract the Company's (but not the Buyer's) rights in this condition 6 shall remain in effect.

**7. Price**

7.1 Unless otherwise agreed by the Company in writing, the price for the Goods shall be the price set out in the Company's price list published on the date of delivery or deemed delivery.

7.2 The price for the Goods shall be exclusive of any VAT which the Buyer shall pay when it is due to pay for the Goods.

7.3 The Company reserves the right, by giving written notice to the Buyer at anytime before delivery, to increase the price of the Goods to reflect any increase in the cost to the Company which is due to any factor beyond the reasonable control of the Company (including without limitation, any increase in packaging, insurance, transportation costs, costs of labour, materials or other costs of manufacture, taxes, tariffs or import duties (where applicable) or changes in legislation or regulations) or any changes in delivery dates, quantities or specifications for the Goods which are requested by the Buyer or any delay caused by failure of the Buyer to give the Company adequate information or instructions.

7.4 The Buyer agrees and acknowledges that the price for the Goods is based upon the limitations of liability set out in conditions 3 and 10 and upon the limited warranties given in condition 9.

**8. Payment**

8.1 Subject to condition 8.4 and unless otherwise agreed by the Company in writing, payment of the price for the Goods is due in pounds sterling 28 days from the day on which the Goods are delivered or deemed to be delivered.

8.2 Time for payment shall be of the essence.

8.3 No payment shall be deemed to have been received until the Company has received cleared funds.

8.4 All payments payable to the Company under the Contract shall become due immediately on its termination.

8.5 The Buyer shall make all payments due under the Contract in full without any deduction whether by way of set-off, counterclaim, discount, abatement or otherwise unless the Buyer has a valid court order requiring an amount equal to such deduction to be paid by the Company to the Buyer. The Buyer shall not be entitled to withhold any payments due under the Contract because of a disputed claim of any nature.

8.6 If the Buyer fails to pay the Company any sum due pursuant to the Contract:

- 8.6.1 the Buyer shall be liable to pay interest to the Company on such sum from the due date for payment at the annual rate of 4% above the base lending rate from time to time of the Royal Bank of Scotland, accruing on a daily basis until payment, before or after any judgment but the Company reserves the right to interest under the Late Payment of Commercial Debts (Interest) Act 1998; and
- 8.6.2 the Company shall be entitled to suspend or cancel all future deliveries of Goods to the Buyer.

8.7 In the event that any variation is agreed between the Company and the Buyer regarding payment terms, which results in credit terms being extended to the Buyer, any such variation will cease and the amount of any debt owed will be payable forthwith on the occurrence of any of the matters set out in condition 11.1 (a) to (c).

8.8 Without prejudice to any other right or remedy of the Company any payment by the Buyer, which results in a cheque being referred to the drawer for whatever reason, will incur a charge of £50.00 plus VAT per cheque payable by the Buyer.

8.9 The Company may apply all or any part of any sum owing by the Company its subsidiaries or associates to the Buyer in relation to any matter in or towards payment of any sum owing to the Company. For this purpose references to the Company or the Buyer include any company which is a holding company, subsidiary or associate of the Company or the Buyer respectively.

8.10 The Company may appropriate any payment made by the Buyer to the Company against amounts that are owed by the Buyer to the Company for the longest period not withstanding any prior appropriation of that payment by the Buyer.

**9. Quality**

9.1 The Company warrants that (subject to the other provisions of these conditions) on delivery the Goods shall:

- (a) be of satisfactory quality within the meaning of the Sale of Goods Act 1979;
- (b) be reasonably fit for any particular purpose for which the Goods are being bought if the Buyer had made known that purpose to the Company in writing and the Company has confirmed in writing that it is reasonable for the Buyer to rely on the skill and judgement of the Company. For the avoidance of doubt, the warranties given in this condition 10.1 are given in lieu and exclude the operation of the implied terms as to satisfactory quality and fitness for purpose in the Sale of Goods Act 1979, to the fullest extent permitted by law.

9.2 The Company shall not be liable for a breach of any of the warranties in condition 9.1 unless:

- (a) the Buyer gives written notice of the defect to the Company within 14 days of the time when the Buyer discovers or ought to have discovered the defect, whichever is the earlier; and
- (b) the Company is given a reasonable opportunity after receiving the notice of the defect from the Buyer of examining such Goods and the Buyer (if asked to do so by the Company) returns such Goods to the Company's place of business for the examination to take place there.

9.3 The Company shall not be liable for a breach of any of the warranties in condition 9.1 if:

- (a) the Buyer makes any further use of such Goods after giving such notice; or
- (b) the defect arises because the Buyer failed to follow the Company's oral or written instructions as to the storage, installation, commissioning, use or maintenance of the Goods or (if there are none) good trade practice; or

- (c) the Buyer carries out, repairs itself or brings about changes in the nature, composition or packaging of the Goods delivered, or has these carried out or brought about by third parties, or if the Goods delivered are used improperly or for any purpose other than that for which they are meant or are marinated and/or stored improperly or contrary to any agreed or legal regulations or if the defect of the Goods can be ascribed to the other party in any way.
- 9.4 Subject to condition 9.2 and 9.3, if any of the Goods do not conform with any warranties in condition 9.1 the Company shall at its option replace such Goods (or the defective part) or refund the price of such Goods at the pro rata Contract rate provided that, if requested, the Buyer shall return the Goods or the part of such Goods which is defective to the Company.
- 9.5 If the Company complies with condition 9.4 it shall have no further liability for a breach of any of the warranties in condition 9.1 in respect of such Goods and any Goods replaced shall belong to the Company.

**10. Limitation of Liability**

- 10.1 Subject to conditions 4, 5 and 9, the following provisions set out the entire financial liability of the Company (including any liability for the acts or omissions of its employees, agents and sub-contractors) to the Buyer in respect of:
  - (a) any breach of these conditions;
  - (b) any use made or resale by the Buyer of any of the Goods, or of any product incorporating any of the Goods; and
  - (c) any representation, statement or tortious act or omission including negligence arising under or in connection with the Contract.
- 10.2 All warranties, conditions and other terms implied by statute or common law (save for the conditions implied by section 12 of the Sale of Goods Act 1979 or section 2(3) of the Supply of Goods and Services Act 1982, whichever Act applies to the Contract) are, to the fullest extent permitted by law, excluded from the Contract.
- 10.3 Nothing in these conditions excludes or limits the liability of the Company.
  - (a) for death or personal injury caused by the Company's negligence; or
  - (b) under section 2(3) Consumer Protection Act 1987; or
  - (c) for any matter which it would be illegal to attempt to exclude its liability; or
  - (d) for fraud or fraudulent misrepresentation.
- 10.4 Subject to condition 10.2 and condition 10.3 the Company's total liability in contract, tort (including negligence or breach of statutory duty), misrepresentation, restitution or otherwise, arising in connection with the performance or contemplated performance of the Contract shall be limited to the Contract price plus 100% or the sum of £50, 000 (whichever is the greater).
- 10.5 In the event that the limitation on liability set out in condition 10.4 is found by any court, tribunal or administrative body of competent jurisdiction to be illegal, invalid, void, voidable, unenforceable or unreasonable then subject to condition 10.2 and condition 10.3 the Company's total liability in contract, tort (including negligence or breach of statutory duty), misrepresentation, restitution or otherwise, arising in connection with the performance or contemplated performance of the Contract shall be limited to the Limit of Indemnity remaining from time to time in accordance with the Company's public/products liability insurance (policy number 005273243 or such other limit of indemnity as may apply to any replacement or amended public/products liability insurance effected by the Company from time to time, in either case a copy of which shall be provided to the Buyer on request).
- 10.6 Subject to condition 10.2 and 10.3 the Company shall not be liable to the Buyer for loss of profit, loss of business, or depletion of goodwill in each case whether direct, indirect or consequential, or any claims for consequential compensation whatsoever (howsoever caused) which arise out of or in connection with the Contract.

**11. Termination**

- 11.1 The Company may terminate the Contract without liability to the Buyer immediately (or following such period as it sees fit) by giving notice to the Buyer if:
  - (a) the Buyer fails to pay any amount due under the Contract on the date for payment and remains in default for more than 7 days; or
  - (b) the Buyer commits a breach of any term of the Contract and (if remediable) fails to remedy that breach in 14 days; or
  - (c) the Buyer repeatedly breaches any of the Contract in such a manner as to reasonably justify the opinion that its conduct is inconsistent with having the intention or ability to give effect to the terms of the Contract; or
  - (d) the Buyer suspends or threatens to suspend payment of its debts or is unable to pay its debts as they fall due or admits inability to pay its debts or is deemed either unable to pay its debts (being a company within the meaning of section 123 of the Insolvency Act 1986) or as having no reasonable prospect of so doing within the meaning of section 268 of the Insolvency Act 1986 or in the case of a partnership has any partner to whom foregoing applies; or
  - (e) the Buyer commences negotiations with any of its creditors with a view to rescheduling any of its debts, or makes a proposal for or enters into any compromise or arrangement with its creditors; or
  - (f) a petition is filed, a notice is given, a resolution is passed, or an order is made, for or in connection with the winding up of the Buyer; or
  - (g) an application is made to court, or an order is made, for the appointment of an administrator or if a notice of intention to appoint an administrator is given or if an administrator is appointed over the Buyer; or
  - (h) a floating charge holder over the assets of the Buyer has become entitled to appoint or has appointed an administrative receiver, or

- (i) a person becomes entitled to appoint a receiver over the assets of the Buyer or a receiver is appointed over the assets of the Buyer; or
  - (j) the Buyer, being an individual, is the subject of a bankruptcy petition or order; or
  - (k) a creditor or encumbrancer of the Buyer attaches or takes possession of, or a distress, execution, sequestration or other such process is levied or enforced on or sued against, the whole or any part of its assets and such attachment or process is not discharged within 14 days; or
  - (l) any event occurs, or proceeding is taken, with respect to the Buyer in any jurisdiction to which it is subject that has an effect equivalent or similar to any of the events mentioned in condition 11.1
- 11.1 (d) to condition 11.1  
(k) (inclusive); or  
(m) the Buyer suspends or ceases, or threatens to suspend or cease, to carry on all or a substantial part of its business; or  
(n) the Buyer, being labour disputes (whether or not relating to either party's workforce), failure of sub-contractors or restraints or delays affecting carriers or inability or delay in obtaining supplies of adequate or suitable materials, provided that, if the event in question continues for a continuous period in excess of six months, the Buyer shall be entitled to give notice in writing to the Company to terminate the Contract, an individual, dies or, by reason of illness or incapacity (whether mental or physical), is incapable of managing his or her own affairs or becomes a patient under any mental health legislation; or  
(o) there is a change of control of the Buyer.
- 11.2 In the event of termination in accordance with condition 11.1 or of any order being cancelled by the Buyer, the Buyer shall indemnify the Company against all loss (including profits) costs (including labour and overheads) and all other expenses and damages reasonably and properly incurred by the Company in connection with the Contract and its termination.

**12. Assignment**

- 12.1 The Company may assign the Contract or any part of it to any person, firm or company.
- 12.2 The Buyer shall not be entitled to assign the Contract without the prior written consent of the Company. The Company shall not be deemed to have accepted an assignment of the Contract due to any circumstance or pursuant to any act or omission of the Company including, without limitation, the acceptance of payments or obligations under the Contract from a third party.

**13. Force Majeure**

The Company reserves the right to defer the date of delivery or to cancel the Contract or reduce the volume of the Goods ordered by the Buyer (without liability to the Buyer) if it is materially prevented from or delayed in the carrying on of its business due to circumstances beyond the reasonable control of the Company including, without limitation, acts of God, governmental or regulatory actions (including orders preventing the movement of Goods), changes in legislation or codes of practice, war or national emergency, acts of terrorism, protests, riot, civil commotion, fire, explosion, flood, epidemic, lock-outs, strikes or other labour disputes (whether or not relating to either party's workforce), failure of sub-contractors or restraints or delays affecting carriers or inability or delay in obtaining supplies of adequate or suitable materials, provided that, if the event in question continues for a continuous period in excess of six months, the Buyer shall be entitled to give notice in writing to the Company to terminate the Contract.

**14. Returns Policy**

- 14.1 Without prejudice to clauses 4, 5, 9 and 10, or the statutory rights of the Buyer:
  - (a) any Goods returned which are not included in the Company's catalogue and have been obtained by the Company at the request of the Buyer will only be refunded in the absolute discretion of the Company;
  - (b) in respect of any Goods returned where Orders are placed via mail, phone, fax or the internet, which have been cancelled within seven days of receiving the Goods, the Company will refund the price of the Goods in full;
  - (c) where an Order has been cancelled within 28 days of receiving the Goods, the Company will examine the returned Goods within a reasonable time. Where Goods are found to be defective, the price of the Goods will be refunded in full
  - (d) where Goods returned in accordance with clause 14.1 (c) are found not to be defective, the Company reserves the right to deduct a re-stocking charge of 20% of the Price of the Goods from any refund to the Buyer.
- 14.2 All Goods must be returned unused, in their original packaging and in a re-saleable condition (to be determined in the Company's absolute discretion) and that the Buyer will be responsible for the costs of returning the Goods to the Company. Costs of delivery to the Buyer (if any) will not be refunded.

**15. General**

- 15.1 Each right or remedy of the Company under the Contract is without prejudice to any other right or remedy of the Company.
- 15.2 If any provision of the Contract is found by any court, tribunal or administrative body of competent jurisdiction to be wholly or partly illegal, invalid, void, voidable, unenforceable or unreasonable it shall to the extent of such illegality, invalidity, voidness, voidability, unenforceability or unreasonableness be deemed severable and the remaining provisions of the Contract and the remainder of such provision shall continue in full force and effect.

- 15.3 Failure or delay by the Company in enforcing or partially enforcing any provision of the Contract shall not be construed as a waiver of any of its rights under the Contract.
- 15.4 Any waiver by the Company of any breach of, or any default under, any provision of the Contract by the Buyer shall not be deemed a waiver of any subsequent breach or default and shall in no way affect the other terms of the Contract.
- 15.5 The parties to the Contract do not intend that any term of the Contract shall be enforceable by virtue of the Contracts (Rights of Third Parties) Act 1999 by any person that is not a party to it.
- 15.6 The formation, existence, construction, performance, validity and all aspects of the Contract shall be governed by English law and the parties submit to the exclusive jurisdiction of the English courts.

**16. Communications**

- 16.1 All communications between the parties about the Contract shall be in writing and delivered by hand or sent by pre-paid first class post or sent by fax:
  - (a) (in case of communications to the Company) to its registered office or such changed address as shall be notified to the Buyer by the Company; or
  - (b) (in the case of the communications to the Buyer) to the registered office of the addressee (if it is a company) or (in any other case) to any address of the Buyer set out in any document which forms part of the Contract or such other address as shall be notified to the Company by the Buyer.
- 16.2 Communications shall be deemed to have been received:
  - (a) if sent by pre-paid first class post, two days (excluding Saturdays, Sundays and holidays) after posting (exclusive of the day of posting); or
  - (b) if delivered by hand, on the day of delivery; or
  - (c) if sent by fax on a working day prior to 4.00 pm, at the time of transmission, otherwise the next working day.
- 16.3 Communications addressed to the Company shall be marked for the attention of a director or the directors of the Company.

**17. Confidentiality**

The Buyer shall each keep confidential and shall not without the prior consent in writing of the other disclose to any third-party any technical or commercial information which it has acquired from the other as a result of discussions, negotiations and other communications between them relating to the Goods and the Contract.

# ADVISE SUPPLY SUPPORT

We inspire cleaning professionals to rethink traditional approaches to deliver higher standards, improved team performance, regulatory compliance and sustainable working.



**ARROW**  
COUNTY SUPPLIES

**01743 283 600**

➤ [response@arrowcounty.com](mailto:response@arrowcounty.com)  
➤ [arrowcounty.com](http://arrowcounty.com)

Arrow County Supplies  
Arrow House  
Longden Road  
Shrewsbury SY3 9AE



Distributed  
throughout  
the UK



Experts in **hygiene** and  
**cleanliness** solutions.