



Power Distribution Panel

CK-PDP-16

16 Tactile Pushbutton operated Channels

8 Selectable Functions per Channel

7 Selectable Current Settings per Channel

Fully electronic with status LEDs and back illumination

Pushbutton Labelling Sheets included

USER GUIDE and INSTRUCTIONS



CONTENTS

Specification	Page 1
Pin Out Diagram	Page 2
Pin Out Description	Page 3
Introduction	Page 4
System Overview	Page 5
Outputs and Inputs	Page 6
Battery Isolator Connection	Page 7
Mounting	Page 8
Wiring	Page 9
Wiper Motor Control	Page 10
Function Choice	Page 11
Special Functions	Page 12
Channel Amperage Adjustment	Page 13
Channel Function Adjustment	Page 15
User Configuration Notes	Page 16

CONTACT INFORMATION

CARTEK AUTOMOTIVE ELECTRONICS LTD

Unit 25, Mitchell Point
Ensign Way, Hamble
Southampton
SO31 4RF
UNITED KINGDOM

+44(0)2380 457747
info@cartekmotorsport.com

For the very latest technical advice always go to our website:

www.CARTEKMOTORSPORT.com

SPECIFICATION

Dimensions

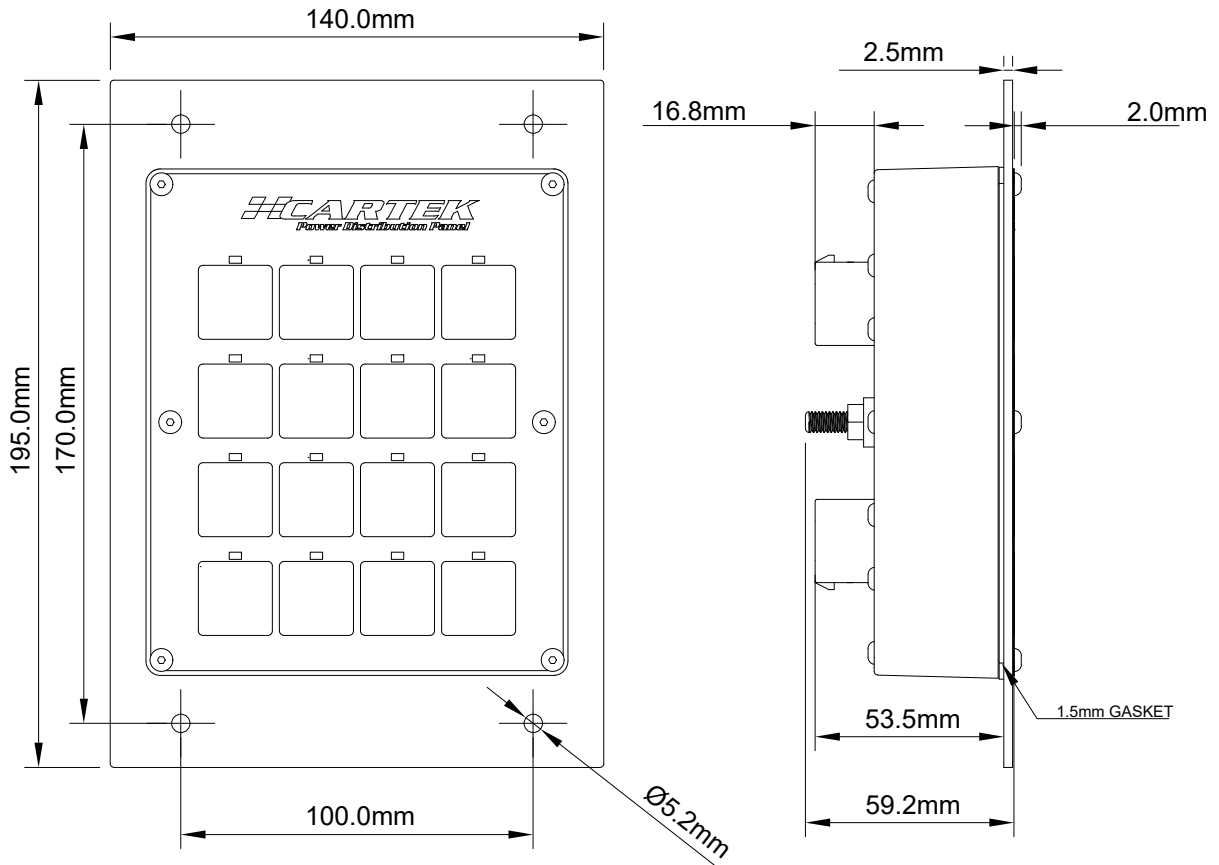

Technical Details

Size:	L = 195mm, W = 140mm.
Weight:	600g.
Battery positive terminal:	M6 stud.
Mating Connectors:	AMPSEAL 776164-1 (Black) AMPSEAL 776164-5 (Blue)
Total Output Current	160A Continuous
Outputs	16
Switch Inputs/Outputs	16
ECU Inputs	16
Battery Isolator XR Ignition Input	2
Dedicated Wiper Park Position Input	1
Operating temperature:	-10°C - +85°C.
Storage temperature:	-40°C - +125°C

PIN OUT DIAGRAM

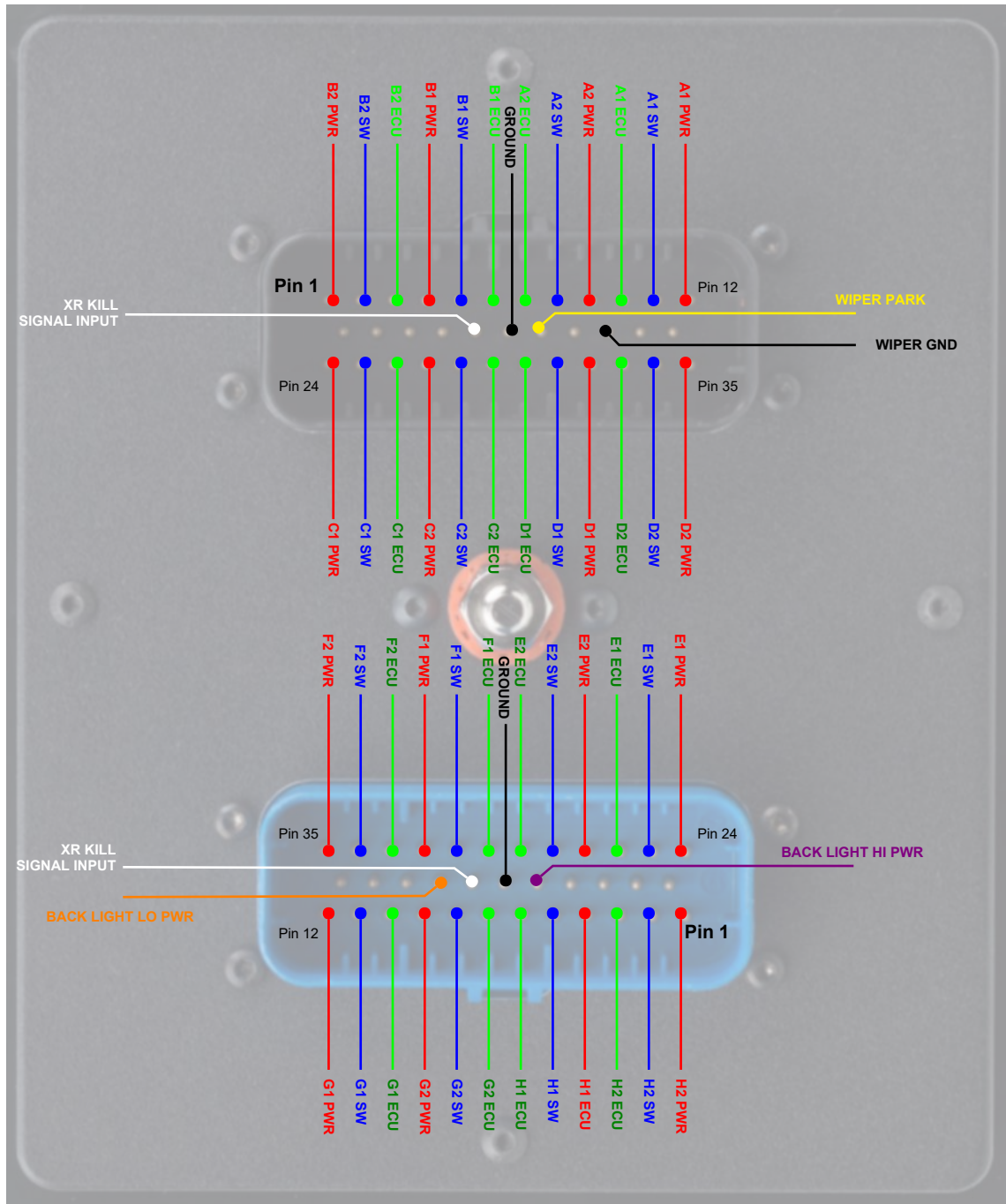



PIN OUT DESCRIPTION

Pin no:	Connector A (BLACK)	Pin no:	Connector B (BLUE)
1	Channel B2 Power Output	35	Channel F2 Power Output
2	Channel B2 Switch Input/Output	34	Channel F2 Switch Input/Output
3	Channel B2 ECU Input	33	Channel F2 ECU Input
4	Channel B1 Power Output	32	Channel F1 Power Output
5	Channel B1 Switch Input/Output	31	Channel F1 Switch Input/Output
6	Channel B1 ECU Input	30	Channel F1 ECU Input
7	Channel A2 ECU Input	29	Channel E2 ECU Input
8	Channel A2 Switch Input/Output	28	Channel E2 Switch Input/Output
9	Channel A2 Power Output	27	Channel E2 Power Output
10	Channel A1 ECU Input	26	Channel E1 ECU Input
11	Channel A1 Switch Input/Output	25	Channel E1 Switch Input/Output
12	Channel A1 Power Output	24	Channel E1 Power Output
13	N/C	23	N/C
14	N/C	22	N/C
15	N/C	21	N/C
16	N/C	20	Back-light (Low) Power Input
17	Battery Isolator XR Ignition Signal Input	19	XR Signal Input
18	Ground	18	Ground
19	Wiper Park Position Input	17	Back-light (Hi) Power Input
20	N/C	16	N/C
21	Ground	15	N/C
22	N/C	14	N/C
23	N/C	13	N/C
24	Channel C1 Power Output	12	Channel G1 Power Output
25	Channel C1 Switch Input/Output	11	Channel G1 Switch Input/Output
26	Channel C1 ECU Input	10	Channel G1 ECU Input
27	Channel C2 Power Output	9	Channel G2 Power Output
28	Channel C2 Switch Input/Output	8	Channel G2 Switch Input/Output
29	Channel C2 ECU Input	7	Channel G2 ECU Input
30	Channel D1 ECU Input	6	Channel H1 ECU Input
31	Channel D1 Switch Input/Output	5	Channel H1 Switch Input/Output
32	Channel D1 Power Output	4	Channel H1 Power Output
33	Channel D2 ECU Input	3	Channel H2 ECU Input
34	Channel D2 Switch Input/Output	2	Channel H2 Switch Input/Output
35	Channel D2 Power Output	1	Channel H2 Power Output



INTRODUCTION

The CARTEK Power Distribution Panel is a fully integrated, fully electronic solution to power distribution in race and rally cars. Designed to replace 16 Fuses, Relays and Switches as well as a variety of control systems, these units therefore greatly simplify the wiring, reducing build time, saving weight and maximising reliability.

HOW IT WORKS

The Power Distribution Panel takes +12V power directly from the Battery then distributes this to all of the electrical systems around the car. All 16 power outputs from the Power Distribution Panel are controlled from the front panel Pushbuttons or from external switches and inputs. All 16 Power Outputs are fully protected with 6 selectable current settings thereby completely removing the need for fuses or circuit breakers. The Function of each Channel is also selectable from a choice of 8 different Functions.

OPERATION

After configuring the Power Distribution Panel each Channel is operated by pressing the relevant front panel Pushbutton or by external signals such as from ECU or separate external switches (See details later).

Above each pushbutton is a Status LED :

No LED = Channel OFF. - LED on = Channel ON. - LED flashing = Over-current or short-circuit detected.
On power up all channels perform a system reset which is indicated by all 16 LEDs flashing twice.

ERROR DETECTION

When a short-circuit or over current fault is detected, the Power Distribution Panel will switch the relevant output OFF to protect the car's wiring system. How quickly the output is switched off will depend on the severity of fault detected thereby eliminating false detections caused by normal current surges.

If the Power Distribution Panel does detect a fault, causing it to switch the relevant Channel OFF, then the corresponding LED will begin to flash to indicate this. To reset the error, switch the Channel OFF then ON again. A full power cycle / system reset is not required.

Over Current

If too much current is detected on any Channel then the relevant Status LED will initially begin flashing at a fast rate to indicate that a fault situation has been detected. A fault situation only occurs when the current exceeds 15% of the rated setting. If the maximum current is exceeded by only a small amount and only for a short time then the fault situation will cease, the LED will stop flashing and the channel will remain ON. This provides users with an early warning if the current flowing through a Channel is close to the maximum current (as set in the configuration). If the over-current increases further, or continues for a longer period of time, then the Channel will shut down and indicate a double-flashing error status on the relevant LED.

Short Circuit

If a short-circuit fault is detected on any channel then it will immediately switch the relevant channel OFF and indicate a double-flashing error status on the relevant LED.

Over Temperature

If the internal temperature gets too hot then any, or all, of the status LEDs will begin flashing around 10°C below the maximum safe temperature. This provides users with an early warning. If the temperature continues to increase and exceeds the maximum safe limit then the channels will begin switching OFF.

SYSTEM OVERVIEW

Internally, the Power Distribution Panel is constructed using 8 independent Power Control Modules where each Module controls 2 Channels. Each Power Distribution Panel contains 7 Full Power Modules, which can handle any current from 5A to 30A and 1 Low Current Module which has a fixed current setting of 7.5A per Channel. The Low Current Module also contains the necessary functionality and electronics for controlling a 1 or 2 speed windscreen wiper motor and is located in position A1/A2.

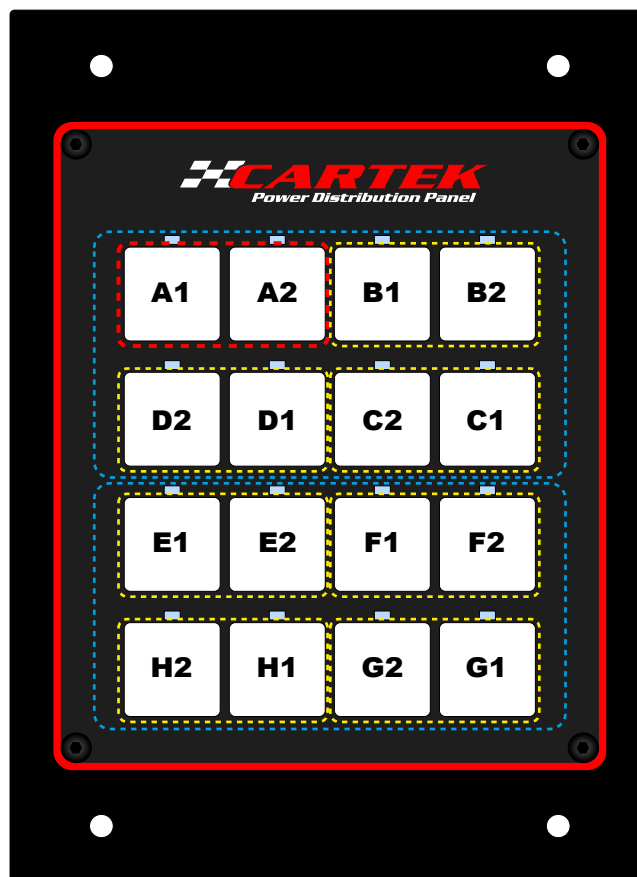

Each Channel on each Module can be set to any 1 of 8 selectable functions. However, when both Channels on a Module are set to the same function then extra functionality becomes available such as 'toggling' between Channels or synchronised flashing. Please refer to the Function descriptions later for more detailed information.



OUTPUTS and INPUTS

Power Outputs

Each Channel has 1 Power Output. The Power Outputs on the Full Power Modules can be configured to 0,5,10 or 15 Amp while to Low Power Module can be configured to 0 or 7.5 Amp only.

If Amperage higher than 15 Amp is required then this can be achieved by combining two Channels but these must be on the same internal Module. By combining two Channels so Amperage settings of 20, 25 and 30 Amp become available. (e.g. B1 +B2 could be set to output 30 Amps but not B1 + C1).

When a Module is set to a high current then the Power Output will be controlled by just 1 of the 2 Pushbuttons. The other Pushbutton will have no affect on the Power Output but can still be used as a 0v momentary switch output (see **Switch Outputs**).

ECU Inputs

Every Channel has an ECU Input allocated to it. These ECU Inputs are active-low, i.e. the input signal needs to be switched to 0V to have an effect. How the ECU Input affects the associated power output will depend on the Channel Function selected. In most cases, the ECU Input signal will simply cause the Channel to switch ON overriding the pushbutton on the front panel. Therefore, the ECU Input has priority.

Example: Channel B2 is set to Function 2 (LATCHING without memory) and the output is connected to a Fuel Pump. The ECU will then turn the Fuel Pump ON and OFF when required. However, when the ECU turns the Fuel Pump OFF the driver can then manually operate it by using the pushbutton on the front panel, perhaps to test the pump or empty the fuel tank. Most motorsport ECUs can be programmed with this type of output signal.

Note: The Power Distribution Panel does not accept PWM signals or CAN-BUS data.

Switch Inputs

Every Channel has an external Switch Input allocated to it. These External Switch Inputs are active-low, i.e. the input signal needs to be switched to 0V to have an effect. These External Switch Inputs directly replicate the operation of the pushbuttons on the front panel. This allows Channels to be operated remotely such as with steering wheel mounted pushbuttons.

Switch Outputs

Every pushbutton has an output signal allocated to it. These Switch Outputs are active-low, i.e. the output signal switches to 0V when the pushbutton is pressed. These Switch Outputs can be used to operate other Channels such as Hazard Button for indicator or perhaps activate external systems such as pit limiter or dashboards menus.

BATTERY ISOLATOR CONNECTION

Battery Isolator XR Input

The Power Distribution Panel has two dedicated pins that can accept the Kill Signal from a CARTEK Battery Isolator XR. This input signal is active-low, i.e. when the input signal is switched to 0V all Channels will instantly switch OFF and remain OFF until the signal is released. If any of the Channels are used to supply power to ECU or ignition system then this Kill Signal will make the engine to stop.

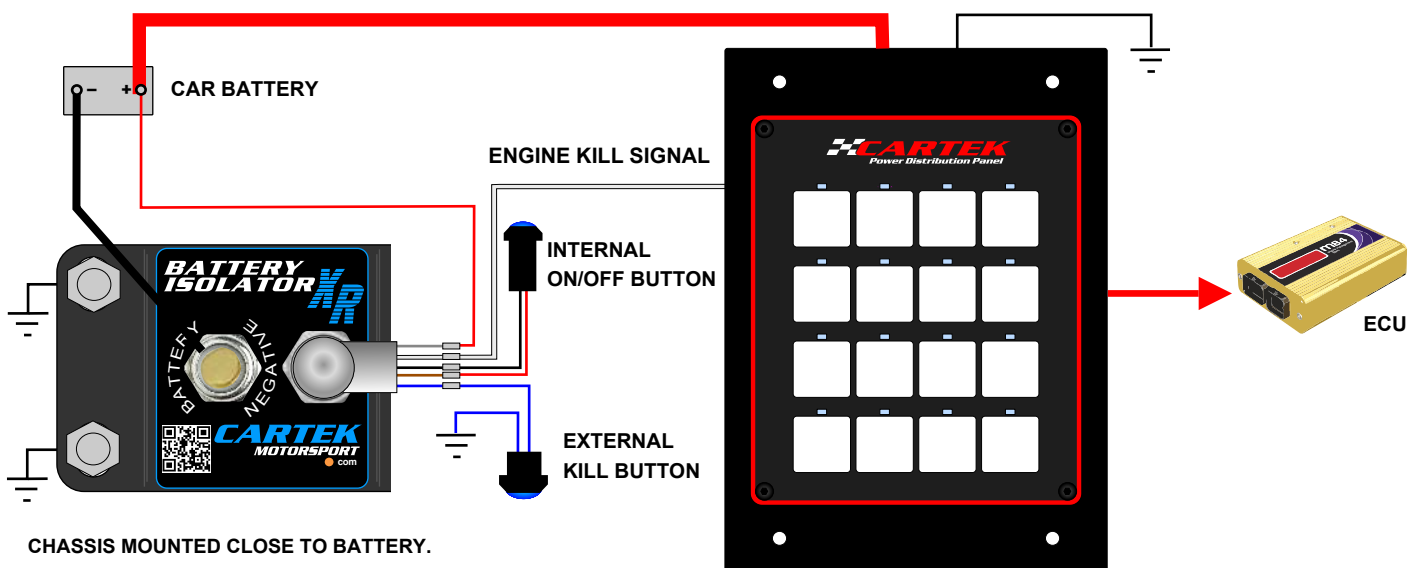

Battery Isolator GT

If you need to free up channels on the Power Distribution Panel then you can use the output of the Battery Isolator GT to power your Ignition/ECU as the Battery Isolator GT comes with a 30A protected output. This way the Battery Isolator will not only act as a master switch, but as an Ignition switch also.

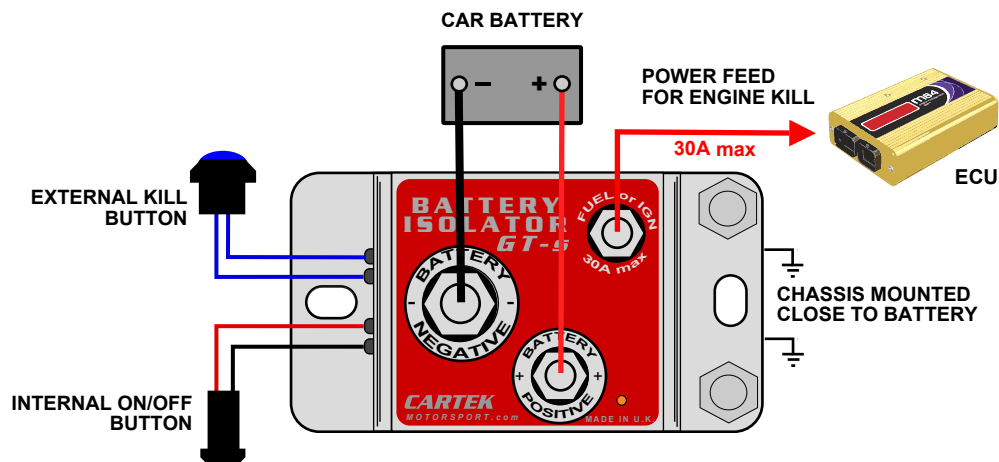

MOUNTING

The Power Distribution Panel should either be mounted away from any heat sources (such as exhaust tunnel) and should have sufficient ventilation to allow the Power Distribution Panel to dissipate its heat.

If the Power Distribution gets too hot from its environment then it will shut down. If the Power Distribution Panel is mounted on top of the exhaust tunnel then make sure it is well insulated from the heat.

Mounting should be through the 4 holes of the Power Distribution Panel. It is also possible to drill extra holes for mounting or additional switches through the Front Panel, e.g. Battery Isolator or Fire Extinguisher pushbuttons. Alignment holes have been included on the rear of the Power Distribution Panel to assist with this. **Do not drill into the metal enclosure.**

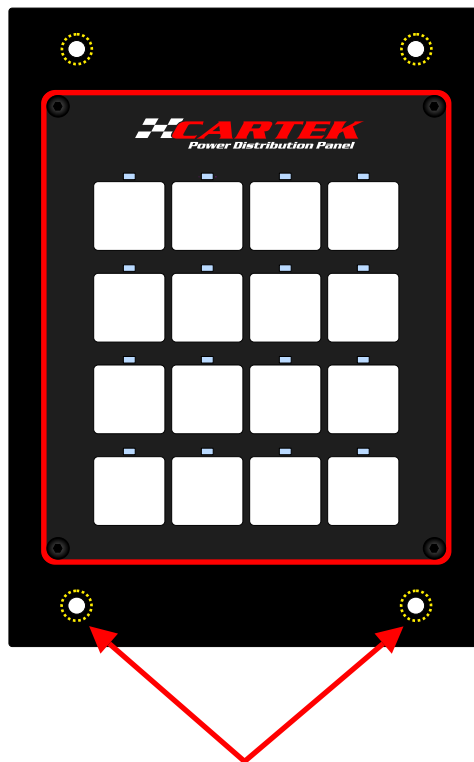

Mount through 4 predrilled holes

WIRING

Power Input

The Power Distribution Panel has one M6 stud which must be connected directly to Battery Positive(+). The wire size should be chosen according to the wire temperature limit and acceptable volt drop, however we recommend a minimum of 2 AWG. The Power Cable must be securely fastened onto the M6 stud using a Nyloc nut (tightened to 15Nm).

Power Outputs

It is recommended that 20 AWG wire is used for channels rated to 5-7.5 Amp. Channels rated to 15 Amp must use 16 AWG wire. Where channels are combined for a 25 or 30 Amp channel then both power output pins must use 16 AWG wire. If crimping into main connectors then wire outside diameter should not exceed 2.7mm.

Many electrical devices will draw much less current than you think, however it is important that you find out the maximum current draw of each item to give the wiring and electrical device as much protection as possible. You can obtain the Amperage information from data sheets on your electrical device, or by using a clamp type Ammeter.

The Power Distribution Panel can also handle short inrush currents that is common from solenoids, motors, etc.

Ground

There are 3 Ground inputs on the Power Distribution Panel, all 3 must be connected to ground using 20 AWG Wire.

ECU Inputs / Switch Inputs / Switch Outputs / XR Signal Inputs

Although these signals are all low current, 20 AWG wire is the minimum the crimp contacts can accept to form a reliable electrical crimp connection. However, you can use 22-24 AWG providing it is crimped correctly by stripping a larger amount of wire and “doubling” over itself inside the crimp barrel.

Back-light Power Inputs

The Power Distribution Panel is equipped with 2 levels of Back Lighting, Low Level Illumination and Hi Level Illumination. The preferred level of illumination is selected by applying +12V power to either, or both of these inputs, 20 AWG wire should be sufficient.



WIPER MOTOR CONTROL

Wiper Motor Control

The Power Distribution Panel can control a 1 or 2 speed Windscreen Wiper Motor via the Low Power Module located in position A1/A2. The 2 Channels in this module can be independently set to any of the 8 selectable Functions. If the Low Power Module is set to Function 8 (TOGGLE) then it will enable the dedicated Wiper Motor control electronics including accepting a Wiper Park Position Signal Input and providing Wiper Motor Braking. This allows the wipers to fully finish a cycle and stop in the correct position when turned OFF. The power outputs of the Low Power Module are fixed at 7.5 Amps which is sufficient for most Wiper Motors. This Low Power Module also has 2 additional inputs:

- 1) Allows the user to toggle between Low and High Speeds using a button on a steering wheel.
- 2) Allows the wipers to activate when a momentary 0v input is received, such as that controlling the Washer Pump.

If just 1 of the 2 Channels is configured to control a Single Speed Wiper Motor then the other Channel can be configured to any of the remaining 7 Functions. **Please see Set-Up section for more details.**

Here is a typical installation for a 2 speed Wiper Motor and Front and Rear Lights.

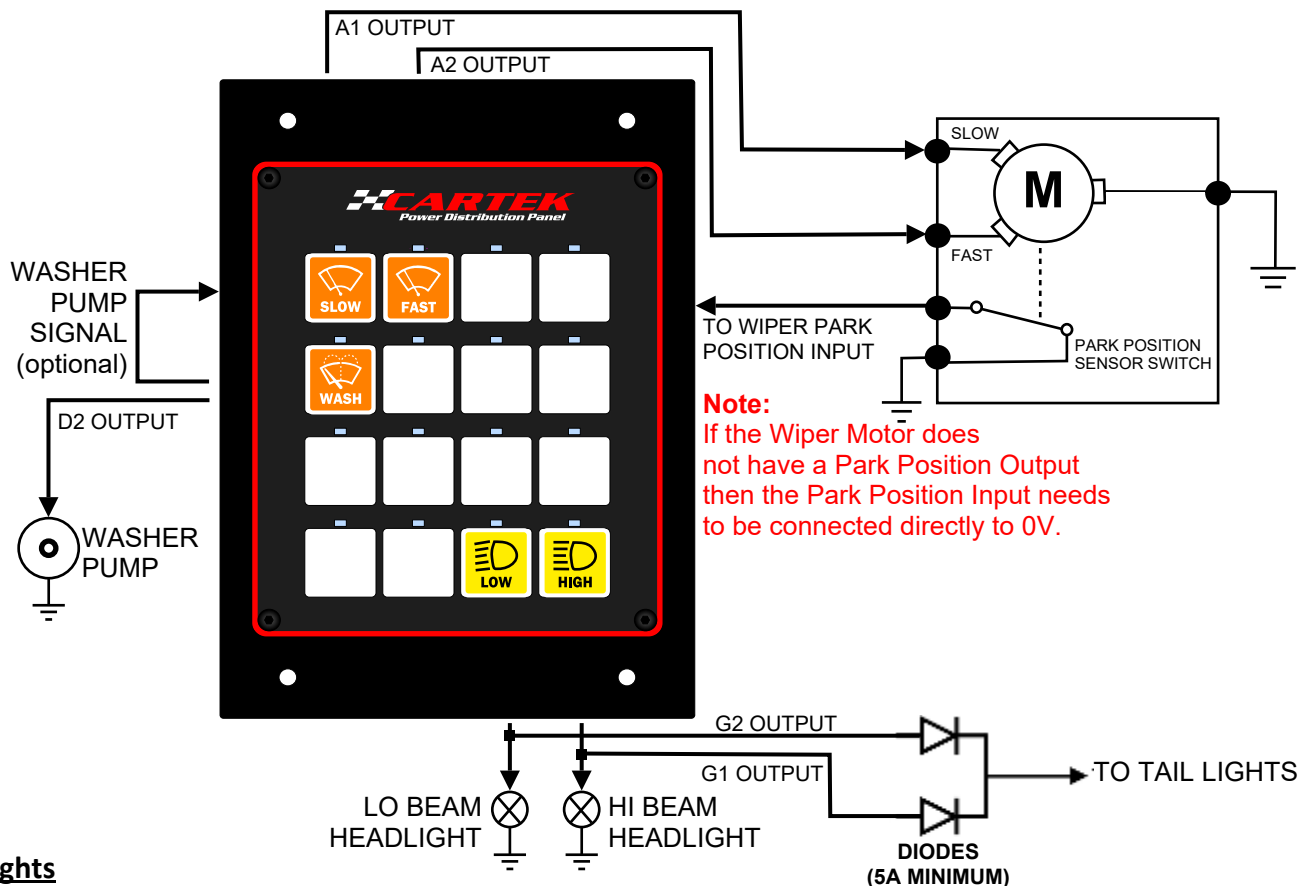

Tail Lights

To make sure your Tail Lights operate when either Lo Beam or Hi Beam Headlights are used then please refer to the diagram above which utilises 2 Diodes.



FUNCTION CHOICE

Each of the 16 Channels can be configured to operate in any 1 of 8 selectable Functions. These Functions allow the user to control how the outputs in a variety of ways.

FUNCTION 1: Latching with Memory (DEFAULT)

Press the front panel Pushbutton once to make the associated output switch ON, press again to switch the output OFF. 'With Memory' means when power to the Power Control Panel is removed then it will remember it's state, ON or OFF, so when power is re-applied again then this Channel will return to it's remembered state i.e. ON or OFF. **Note: ECU Input is disabled** Example of use: Dash Display.

FUNCTION 2: Latching without Memory

Same as above except when power is applied to the Power Control Panel so this Channel will always power up in the OFF state. Use this function if you require the ECU to activate the channel. Example of use: Rad Fan.

FUNCTION 3: Momentary

The output will only switch ON while the Pushbutton is being pressed. Example of use: Starter.

FUNCTION 4: Latching with 30 Second Timer

Press the front panel Pushbutton once to make the associated output switch ON, press again to switch the output OFF. '30 Second Timer' means it will automatically switch OFF after 30 seconds.

FUNCTION 5: Latching with 5 Minute Timer - As above but for 5 minutes. Example of use: Screen Demist.

FUNCTION 6: Latching with 10 Minute Timer - As above for but 10 minutes.

FUNCTION 7: Flashing (Indicators)

This function is a constant Flash to be used for Turn Signal Indicators. Press the front panel Pushbutton once to make the associated output flash, press again to switch the output OFF. If both buttons are pressed in the same module then they will both flash for a Hazard Warning function. Alternatively you can use an additional switch to activate the Hazard Warning function by wiring both ECU inputs to a Latching Switch. A momentary switch can also be used if wired to the switch inputs via two diodes.

FUNCTION 8: Toggling (Headlights or Wipers)

This function is dedicated for use with Wipers using the Low Power Module only or Headlights using any of the Full Power Modules. If both Channels in the same module are set to this Function then it will toggle between the two Channels, i.e. press one Pushbutton to switch one Channel ON, press the other Pushbutton and the first Channel will switch OFF while the second Channel will Switch ON and visa-versa. To Switch the Function OFF then simply press the active Channel one more time.

Note: When controlling a Wiper Motor, only the Low Power Module and Function 8 should be used. Only when using Function 8 will the Wiper Motor Park Input Signal become active along with Wiper Parking Brake facility.

SPECIAL FUNCTIONS

External Toggling (Function 8) All Modules

If both Channels on a Module have been assigned to Function 8 then ECU2 Input Signal can be used to remotely toggle between the two Channels using a single Steering Wheel mounted Pushbutton. This includes Wiper operation using the Low Power Module. Here is an example of the remote toggling operation:

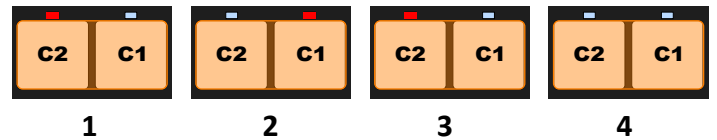

- 1) Operate ECU2 input – Channel C2 switches ON
- 2) Operate ECU2 input again – Channel C2 switches OFF, Channel C1 switches ON
- 3) Operate ECU2 input again – Channel C1 switches OFF, Channel C2 switches ON
- 4) Operate ECU2 input continuously for 2 seconds - Both Channels will switch OFF

Note: Module C has been used as an example, the Toggle Function will work on any Module.

Flashing Headlights (Function 8) Full Power Modules only

When Function 8, TOGGLING, is selected on any Full Power Module it will also allow remote flashing of the Headlights by using a Steering Wheel Pushbutton connected to an ECU Input Signal for that Channel/Module.

If just one Channel on a Module is set to Function 8 then it will operate in the same way as Function 1 (Latching with Memory), however activating the associated ECU Input Signal will cause this Channel to flash.

One quick press of the steering wheel pushbutton will cause this Channel to flash 3 times. Holding the Pushbutton will make the Channel flash continuously until released. If both Channels on a Module are set to Function 8 then it is the ECU1 Input Signal only which will cause both Channels to flash.

Wash / Wipe (Function 8) Low Power Module only

When Function 8, TOGGLING, is selected on the Low Power Module it will also allow Channel 2, Hi Speed Wipe, to operate when the ECU2 Input Signal is activated. This is to facilitate automatic operation of the Wipers when a Washer Pump is operated. The Hi Speed Wiper Channel will also continue to operate for 2 seconds after the Wash Input Signal is released to allow several extra dry wipes of the screen.

Low Power Module use

Either Channel of the Low Power Module can be set to any of the 8 Functions in the same way as the Full Power Modules, however the Current can only be set to 0A or 7.5 A. This can come in useful if:

- The Wiper Motor only has a single speed setting.
- You do not have a Wiper Motor and therefore do not require the wiper functions.

If one Channel in the Low Power Module is still set to the Function 8 then it will still retain the use of its dedicated Wiper inputs – The Park Position Input and Wash Input.



CHANNEL AMPERAGE ADJUSTMENT

The Amperage setting of all Channels can be independently set to:

Low Power Module: 0A or 7.5A only

Full Power Modules: 0A, 5A, 10A, 15A (Single Channel) 20A, 25A or 30A (Two Channels combined)

To check or change the Amperage:

- 1) Turn Power OFF to the Power Distribution Panel
- 2) Press and hold the Pushbutton of the Channel you wish to check or adjust.
- 3) Turn Power ON and continue to press the Pushbutton.
- 4) After about 2 seconds the Status LED of the Channel will illuminate. Once illuminated release the Pushbutton. You are now in Amperage Adjustment Mode.

The LED will now begin to flash to indicate the Amperage setting.

Setting No	Amperage	Flashes
1	0 Amps (Disabled)	1 Flash, pause, 1 Flash...
2	5 Amps (Full Power Module) 7.5 Amps (Low Power Module-DEFAULT)	2 Flashes, pause, 2 Flashes...
3	10 Amps	3 Flashes, pause, 3 Flashes...
4	15 Amps (Full Power Module-DEFAULT)	4 Flashes, pause, 4 Flashes...
5	20 Amps (Two Channels combined)	5 Flashes, pause, 5 Flashes...
6	25 Amps (Two Channels combined)	6 Flashes, pause, 6 Flashes...
7	30 Amps (Two Channels combined)	7 Flashes, pause, 7 Flashes...

If the Amperage setting is correct and no adjustment is required then turn power OFF to Power Distribution Panel to exit Amperage Adjustment Mode.

To make an adjustment simply press the button once and the Amperage setting will increment to the next available setting. Pressing the button repeatedly will cycle through all available settings. When the preferred Amperage setting is correct then turn power OFF to the Power Distribution Panel to exit Amperage Adjustment Mode. The new Amperage setting will be saved automatically.

FULL RESET

A full reset of the Amperage and Function settings on each Module can be performed as follows:

- 1) Turn Power OFF to the Power Distribution Panel
- 2) Press and hold the both Pushbuttons of the Module you wish to reset.
- 3) Turn Power ON and continue to press the Pushbutton.
- 4) After about 2 seconds the Status LEDs of both Channels will begin to flash rapidly. Now release both Pushbuttons.

After resetting a Module the Amperage and Function settings on each Channel will set to the default.

CHANNEL AMPERAGE ADJUSTMENT

When a Channel is set to a high current such as 20, 25 or 30 Amp then it will achieve this by combining both Channels on the same Module. Once a Channel has been programmed for 20, 25 or 30 Amp then the adjacent Channel will be automatically disabled and set to 0 Amp.

If you need to step down from 1 High Power channel to 2 Low Power Channels then perform a full reset on the module.

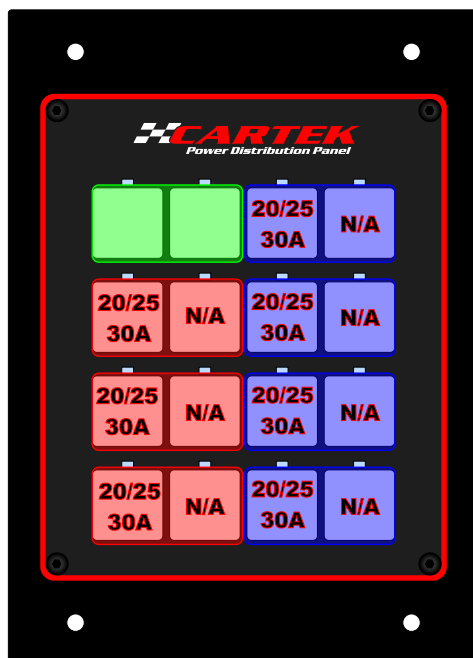

OR

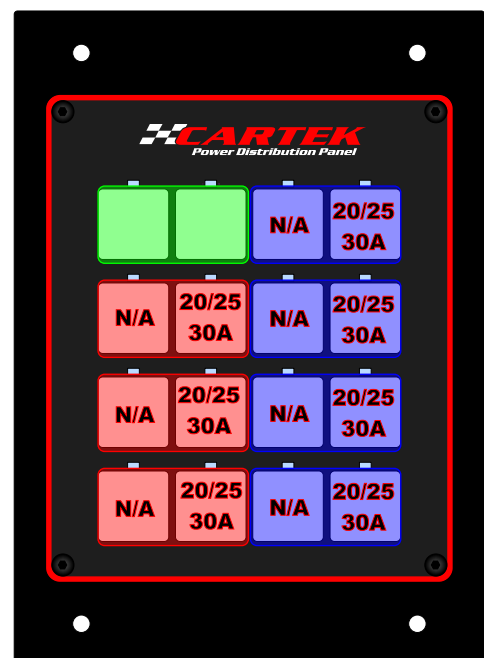

Both Power Output pins for combined 20, 25 or 30 Amp channels must be used to distribute the current flow evenly between the two Channels.

The Disabled channel can still be used as a momentary 0V switch via the associated Switch Input/Output pin. This can be used to trigger an Input on another Channel, or perhaps an input to ECU or Dash Display.

The Status LED on a disabled Channel will continue to indicate when the Pushbutton on the Front Panel is pressed or if it receives an external Switch Input.



CHANNEL FUNCTION ADJUSTMENT

The Function setting of all Channels can be independently set to any 1 of 8 Functions available.

To check or change the Function:

- 1) Turn Power OFF to the Power Distribution Panel
- 2) Press and hold the Pushbutton of the Channel you wish to check or adjust.
- 3) Turn Power ON and continue to press the Pushbutton.
- 4) After 2 seconds the Status LED of the Channel will illuminate, continue to press the Pushbutton.
- 5) After 1 second the Status LED of the Channel will extinguish. Once extinguished release the Pushbutton. You are now in Function Adjustment Mode.

The LED will now begin to flash to indicate the Amperage setting.

Function no	Function description	Flashes
1	Latching with memory (DEFAULT)	1 Flash, pause, 1 Flash...
2	Latching without memory	2 Flashes, pause, 2 Flashes...
3	Momentary	3 Flashes, pause, 3 Flashes...
4	Latching with 30 sec delay	4 Flashes, pause, 4 Flashes...
5	Latching with 5 min delay	5 Flashes, pause, 5 Flashes...
6	Latching with 10 min delay	6 Flashes, pause, 6 Flashes...
7	Flashing for Indicators	7 Flashes, pause, 7 Flashes...
8	Toggling Function: Low Power Module has additional Wiper functionality Full Power Modules have additional Headlight functionality	8 Flashes, pause, 8 Flashes...

If the Function setting is correct and no adjustment is required then turn power OFF to Power Distribution Panel to exit Function Adjustment Mode.

To make an adjustment simply press the button once and the Function setting will increment to the next available setting. Pressing the button repeatedly will cycle through all available settings. When the preferred Function setting is correct then turn power OFF to the Power Distribution Panel to exit Function Adjustment Mode. The new Function setting will be saved automatically.

To go back to the default settings please refer to page 13.

USER CONFIGURATION NOTES

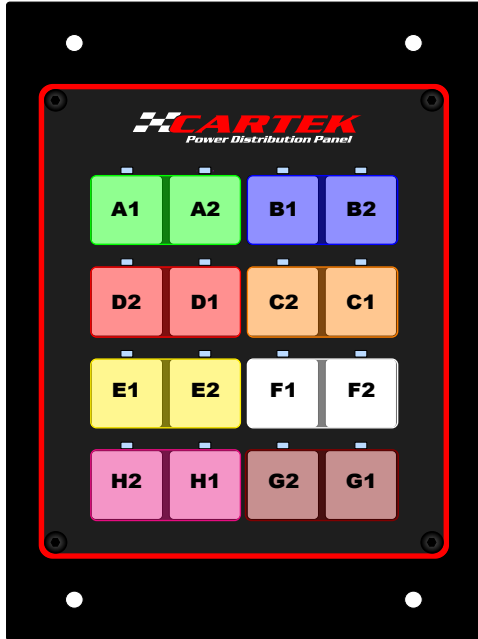

Channel	Amperage Rating	Amperage Setting No.	Function	Function Setting No.
A1				
A2				
B1				
B2				
C1				
C2				
D1				
D2				
E1				
E2				
F1				
F2				
G1				
G2				
H1				
H2				

USER CONFIGURATION NOTES (Example)

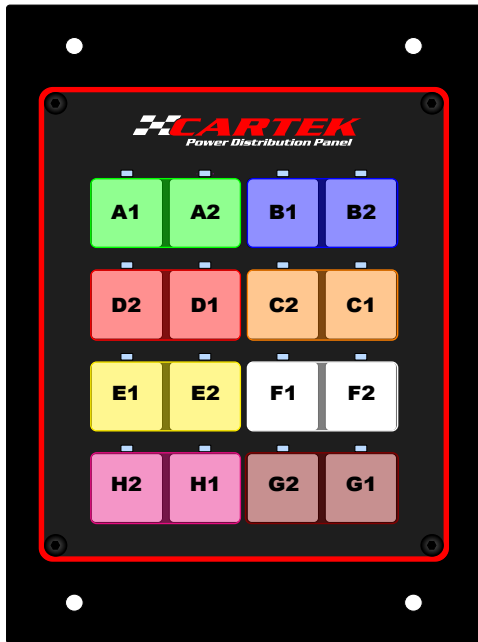

Channel	Amperage Rating	Amperage Setting No.	Function	Function Setting No.
A1	7.5A	2	Toggling	8
A2	7.5A	2	Toggling	8
B1	15A	4	Latching with Memory	1
B2	15A	4	Momentary	3
C1	10A	3	Flashing	7
C2	10A	3	Flashing	7
D1	15A	4	Toggling	8
D2	15A	4	Toggling	8
E1	15A	4	Latching without memory	2
E2	15A	4	Latching without memory	2
F1	25A	6	Latching without memory	2
F2	0A	0	N/A	N/A
G1	15A	3	Latching with memory	1
G2	15A	3	Latching with memory	1
H1	5A	2	Latching with memory	1
H2	10A	2	Momentary	3

CARTEK **MOTORSPORT ELECTRONICS**

INNOVATION
SAFETY
RELIABILITY
QUALITY
PERFORMANCE



Manufacturers of quality and innovative
products for the motorsport
industry since 1999

www.CARTEKMOTORSPORT.com