



Commercial Networking – Optical Fiber



Table of Contents

Commercial Networking – Optical Fiber	Page No.
Introduction	16.2 – 16.3
Optical Fiber Connectivity Products	16.4 – 16.17
FiberExpress Connectors	16.4 – 16.5
Pre-Connectorized Assemblies	16.6 – 16.8
FiberExpress Secure/Keyed LC System	16.9 – 16.10
FiberExpress Manager	16.11
FiberExpress Patch Panels	16.12 – 16.13
FiberExpress Patch Panels Accessories	16.14
FiberExpress Outlets	16.15 – 16.16
Network Connectivity Products	16.17
Introduction Cables	16.18 – 16.24
Guide to Installation and Handling	16.20
Cable Finder Optical Fibers	16.22
Color Codes	16.23
Cable Selection Guide: Plenum	16.24
Optical Fiber Cables	16.25 – 16.58
Interconnect Cables	16.25 – 16.27
Breakout Cables	16.28
Mini Breakout Cables (Distribution)	16.29 – 16.32
Breakout Kit Cables	16.32
Central Loose Tube Cables	16.33 – 16.40
Multi Loose Tube Cables	16.41 – 16.58
Plenum Optical Fiber Cables	16.59 – 16.64
Interconnect Cables	16.59
Distribution Cables	16.60 – 16.61
Breakout Style Cables	16.62
Industrial Armored Cables	16.63
Central Loose Tube Cables	16.64

Please refer to "Terms of Use of Master Catalog" on page 23.22.

Introduction

Fiber Solutions for Even Faster Performance

Belden IBDN FiberExpress systems offer many benefits: high bandwidth and transmission speed, the potential for network growth, extended reach, fault tolerance, greater data security and support for Gigabit and multi-Gigabit protocols and networked applications. Beyond these traditional benefits, however, Belden offers the FiberExpress solution, a complete end-to-end cabling system supporting both centralized and fiber-to-the-desk topologies, as well as backbone and campus cabling configurations. Our FiberExpress solutions meet or exceed all applicable TIA/EIA, ISO/IEC and IEEE standards and offer:

- Reduced design complexities
- Greater deployment facility
- Quick installation
- Increased flexibility
- Cost effective pricing

Primary FiberExpress System Components

Key components of the FiberExpress systems are summarized below and are found on the catalog pages that follow.

• Optimax® Connectors

Optimax® connectors are a revolutionary field-installable optical fiber connector. The unique design of the patented mechanical splice body of Optimax® incorporates a factory mounted fiber stub and a pre-polished ceramic ferrule. This technology consistently provides a fast, secure and reliable LC, SC or ST compatible optical fiber termination for multimode or single-mode cable. All critical steps are performed in the factory, ensuring a superior quality connection every time.



• The FiberExpress Manager

The FiberExpress manager makes fiber management easier than ever before. Designed to streamline termination, connection and maintenance activities, the FiberExpress manager uses a scalable, modular approach to adapt to a wide variety of situations. The total system provides extra high connection density while facilitating cable routing and patch cord management. The FiberExpress manager is adaptable for almost all situations, traditional field termination or pre-terminated modules, which reduces design complexity and increases deployment efficiency.

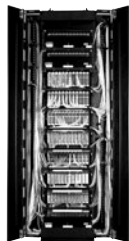

• Extended Reach Optical Fiber Cables

Extended Reach Optical Fiber Cables propel your network into the future of cable technology with our multimode FiberExpress FX300, FX600 or FX2000 series. These series were developed to meet the existing needs of networks at 1 Gb/s (ethernet, 1000Base-SX and 1000Base-LX) and new networks at 10 Gb/s (ethernet, 10GBase-S and 10GBase-LX4). These series offer better reach for laser-based systems. For 1 Gb/s Ethernet at 850 nm (VCSEL), the FX300 and FX600 series provide a range of 984 ft. (300 m) and 1968 ft. (600 m), respectively. For 10 Gb/s ethernet at 850 nm (VCSEL), the FX2000 series provide a range of 984 ft. (300 m) for 10GBase-S where all of multimode series can offer a 984 ft. (300 m) range at 1300 nm (laser) for 10GBase-LX4. All of this while assuring total compatibility with LED systems and FDDI fiber installation cables. Our single-mode cable offering enhances the options for longer distance support up to 40 km – for any of the Gigabit ethernet applications.



• The FiberExpress Bar

The FiberExpress bar is an extremely compact, modular and resilient linking panel. Resembling a power bar, it offers 6 or 12 fibers, pre-terminated with an SC, SC duplex, ST-compatible, LC, MT-RJ or FC connectors and a cord terminated with a multi-fiber MPO connector – all of which are factory verified. The FiberExpress bar can adapt to all kinds of properties or developments, and can serve as a consolidation or linking point. It's available in both single-mode and multimode media.



For the ultimate in quick, easy and reliable optical networking we also offer the FiberExpress pre-connectorized system. Based on the concept of building blocks, the complete range of pre-terminated FiberExpress components bring flexibility to the design stage. The in-factory fabrication and verification of pre-terminated connections ensures the high-performance and high-quality of the product. These products are “plug and go” and their deployment requires no specialized tools – you can deploy 12 fibers in the same amount of time it takes to connect a power cord to a standard electrical plug. This pre-terminated technology will help to preserve the initial investment by its ability to be re-deployed while always ensuring quality results.

Quality Installation and Service

All Belden IBDN systems are designed, installed and field-tested by fully-trained and certified system contractors and integrators to further assure superior systems performance. They are also backed by a strict system certification and warranty program.

System Certification and Warranty Program

The Belden IBDN Certification Program is a rigorous process that ensures that your Belden IBDN ‘Certified’ System is composed of Belden IBDN components, designed and installed by a factory-trained Certified System Vendor. Belden IBDN ‘certified’ systems are supported by a series of warranties that surpass conventional product warranties. Certification adds important end-to-end system performance guarantees and ensures full compliance with cabling industry standard specifications – even after system installation (Installable Performance®). A 25-year product warranty and a lifetime application assurance program accompany each Belden IBDN ‘certified’ system installation. These warranty programs include coverage for both parts and labor.

Introduction

Fiber Channel Topology

FiberExpress System Matrix	Page No.	Fiber-to-the-Desk (FTTD) and Centralized Fiber	Fiber Backbone (In-Building)	Fiber Backbone (Campus)	FiberExpress Pre-Terminated Solutions*
FiberExpress Cables					
Distribution & Breakout Cable Series Multimode and Single-mode	16.28 – 16.32	•			•
Interconnect Cable Series Multimode and Single-mode	16.25 – 16.27	•			
Loose Tube (Campus) Cable Series MM, SM, Composite MM/SM	16.33 – 16.58			•	•
Cross-Connect Hardware in the Telecom Room					
FiberExpress Manager with FiberExpress Manager Connector Modules Multimode and Single-mode	16.11	•	•	•	•
FiberExpress Rack Mount Patch Panel with Universal Adapter Strips Multimode and Single-mode	16.12	•		•	•
FiberExpress Wall Mount Patch Panel with Universal Adapter Strips Multimode and Single-mode	16.13	•		•	•
FiberExpress Bar: Multimode and Single-mode	16.8	•	•	•	•
Patch Cords in the Telecom Room and at the Work Area					
FiberExpress Patch Cords: Multimode and Single-mode	16.6	•	•	•	•
Outlets at the Work Area					
MDVO® Multimedia Outlets with MDVO Multimedia Modules	16.16	•			
MediaFlex® Outlets with MediaFlex Multimedia Inserts	16.15	•			
FiberExpress Bar Multimode and Single-mode (as MUTOA)	16.8	•	•		
Fiber Connectivity					
Optimax® Connectors Multimode and Single-mode	16.4	•		•	•
Epoxy Field Mountable Connectors Multimode and Single-mode	16.5	•		•	•
Fiber Pigtails Multimode and Single-mode	16.9	•		•	•

MM = Multimode • SM = Single-mode

* FiberExpress pre-terminated solutions provide simple-to-install, high-performance fiber channels through custom length, high precision factory terminated cables and matching optical connectivity components.

FiberExpress Connectors

Optimax® Field Installable Connectors and Installation Tool Kits

AX101982 Optimax® LC connector



AX100029 with AX101794 Optimax® SC connector



A0408835 with AX101793 Optimax® ST compatible connector



AX100947 Optimax® tool kit



These products are in the process of being assessed for RoHS compliance. Please check our website for the most current RoHS status.

* For 900 µm buffered fiber only. For Optimax® single-mode termination on jacketed fiber, please use the appropriate Accessory Kit.

Optimax® Field Installable Connector

The Optimax® connectors are reliable field installable optical fiber connectors that are easy to install. They do not require epoxy, curing or polishing. Their unique design incorporates a factory polished fiber stub in a splice mechanism which provides a fast, secure, and reliable termination on optical fiber cables. All critical steps are performed in the factory, ensuring a superior-quality connection every time. Only simple tools are required for installation, making Optimax® a cost effective field termination.

Optimax® connectors are high-quality LC, SC and ST compatible connectors that use a ceramic ferrule with a physical contact (PC) polish for multimode and super physical contact (SPC) polish for single-mode that ensures the best possible mating of optical fibers. Connectors are available for 62.5 or 50/125 µm multimode fiber and single-mode fiber installations.

Optimax® Installation Tool Kit

The Optimax® installation tool kit is packaged in a small convenient carrying case and includes an Optimax® LC, SC and ST compatible installation and training video, installation instructions and all the tools required to terminate 900 µm buffered optical fiber and jacketed optical fiber.

The Optimax® installation tool kit has all the tools and supplies required to install both the Optimax® LC, SC or ST compatible multimode and single-mode connectors. Certain tool kit items can be purchased separately to accommodate installers already possessing basic optical fiber installation tools.

Description	Belden Part Number
FiberExpress Connectors	
Optimax® Field Installable Connector	
LC 62.5 µm, Multimode*	AX101981
LC 50 µm, Multimode*	AX101982
LC Single-mode*	AX101983
SC 62.5 µm, Multimode*	AX100029
SC 50 µm, Multimode*	AX101077
SC Single-mode*	AX101792
ST Compatible 62.5 µm, Multimode*	A0408835
ST Compatible 50 µm, Multimode*	AX101075
ST Compatible Single-mode*	AX101791
LC Accessory Kit for jacketed fiber (2 mm boot and a crimp sleeve)	AX101984
SC Accessory Kit for jacketed fiber (3 mm boot, crimp sleeves, cord adapter)	AX101794
ST Accessory Kit for jacketed fiber (3 mm boot, crimp sleeves)	AX101793
Optimax® Installation Tool Kit	
LC/SC/ST Compatible (includes installation tools, fiber cleaver, crimping tool, instruction manual, microscope, tweezers, alcohol wipes, marker, scissors, waste bottle, fiber stripper, cable stripper and training video)	AX100947
Basic (excludes fiber stripper & cleaver)	AX100949
Optimax® LC Tool Kit Upgrade (includes LC installation tool, instructions manual, foam for the case)	AX102061
Optimax® Individual Components	
Fiber Cleaver	A0408829
Installation Tool LC (does not include tool-clamp)	AX102062
Installation Tools ST Compatible and SC (includes tool-clamp)	A0403634
Microscope	AX100910
Refurbishing Materials (80 alcohol wipes and a black felt tip marker)	AX100951
Installation Instruction Manual, LC	AX102063
Installation Instruction Manual, SC	PX101318
Installation Instruction Manual, ST Compatible	PX101317
Installation & Training Video, CD (see literature ordering form on the web)	NOT0651
Crimp Tool complete with die	A0403641

FiberExpress Connectors

Epoxy Field Installable Connectors

A0390851 Optical Fiber Field Installable Epoxy connector, ST compatible



Epoxy Field Installable Connector

Epoxy field installable connectors are available as multimode and single-mode ST compatible and SC field installable connectors. They require heat-cured epoxy and polishing. Both types have a ceramic ferrule. Each connector comes complete with all the parts necessary for termination of tight-buffered fibers as well as jacketed fibers. Parts include crimp sleeves, boots, cord adapter and dust cap.

Description	Belden Part Number	
	Multimode	Single-Mode

FiberExpress Connectors

Epoxy Field Installable Connector		
ST Compatible	A0390851	AX101412
SC Simplex	AX100919	AX101411
SC Duplex	AX100929	–

These products are in the process of being assessed for RoHS compliance. Please check our website for the most current RoHS status.

Pre-Connectorized Assemblies

FiberExpress Patch Cords

AX200057 Patch Cord Multimode SC Duplex (568SC)



FiberExpress Patch Cords

FiberExpress duplex patch cord assemblies are of the highest quality available. They are assembled and 100% optically tested in our factory prior to shipment. All patch cords are built with high-quality connectors and cables which guarantees superior performance and excellent reliability.

Description	Belden Part Number			
	Multimode, FX300, 62.5 μm	Multimode, FX600, 50.0 μm	Multimode, FX2000, 50.0 μm	Single-Mode SPC

FiberExpress Pre-Connectorized Assemblies

Duplex Patch Cord				
ST-ST, 2 m (6 ft.)	70102419	AX200341	AX200799	AX200090
ST-ST, 3 m (10 ft.)	70102420	AX200459	AX200795	AX200091
ST-ST, 5 m (16 ft.)	70102447	AX200413	AX200800	AX200092
568SC-568SC, 2 m (6 ft.)	AX200056	AX200084	AX200603	AX200094
568SC-568SC, 3 m (10 ft.)	AX200057	AX200082	AX200589	AX200095
568SC-568SC, 5 m (16 ft.)	AX200058	AX200280	AX200624	AX200096
LC duplex-LC duplex, 2 m (6 ft.)	AX200517	AX200527	AX200664	AX200507
LC duplex-LC duplex, 3 m (10 ft.)	AX200518	AX200528	AX200665	AX200508
LC duplex-LC duplex, 5 m (16 ft.)	AX200519	AX200529	AX200666	AX200509
MTRJ-MTRJ, 2 m (6 ft.)	AX101122	AX101139	AX200801	AX101157
MTRJ-MTRJ, 3 m (10 ft.)	AX101123	AX101138	AX200802	AX101156
MTRJ-MTRJ, 5 m (16 ft.)	AX101125	AX101137	AX200803	AX101155
Hybrid Patch Cord				
568SC-ST, 3 m (10 ft.)	AX200060	AX200196	AX200900	AX200421
LC duplex-ST, 3 m (10 ft.)	AX200699	AX200695	AX200809	AX200698
LC duplex-568SC, 3 m (10 ft.)	AX200580	AX200581	AX200668	AX200667
MTRJ-ST, 3 m (10 ft.)	AX101133	AX101151	AX200810	AX101166
MTRJ-568SC, 3 m (10 ft.)	AX101128	AX101143	AX200797	AX101161
Single-Ended (pigtails)				
ST-open, 2 m (6 ft.)	70100390	AX200458	AX200811	AX200097
SC-open, 2 m (6 ft.)	70101714	AX200192	AX200653	AX200098
LC-open, 2 m (6 ft.)	AX200657	AX200658	AX200660	AX200659
MTRJ (m)-open, 3 m (10 ft.)	AX101366	AX101367	AX200812	AX101368

Also available as Simplex Patch Cords or custom assemblies, please contact customer service for more details. These products are in the process of being assessed for RoHS compliance. Please check our website for the most current RoHS status.

FiberExpress Pre-Connectorized Assemblies

Cable Assemblies

AX250105 MPO Cable Assembly



Multi-fiber Cable Assembly

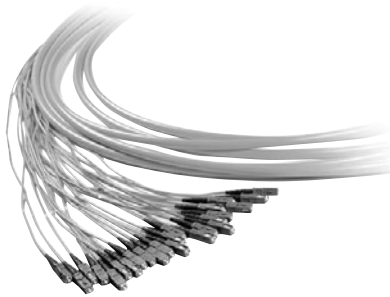

900 µm Fan-out Assembly

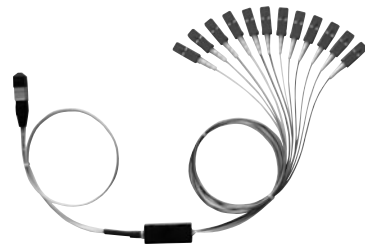

These products are in the process of being assessed for RoHS compliance. Please check our website for the most current RoHS status.

MPO Cable Assembly

MPO cable assemblies are multi-fiber cables using single MPO connectors 6, 8 and 12-fiber that are used to interconnect pre-terminated devices such as FiberExpress pre-terminated modules and FiberExpress bars. Depending on the application, MPO cable assemblies can use ribbon cables or loose tube cables. MPO cables are available in lengths of up to 500 meters with a pulling-eye for ease of deployment.

Multi-Fiber Cable Assembly

Multi-fiber cable assemblies are factory-terminated fiber cables of various constructions (distribution, breakout or ribbon) using simplex, duplex or multi-fiber connectors. They are available in configurations from 2-fiber up to 144-fiber with various kinds of fan-out constructions, lengths and geometry to suit virtually any application.

Description	Belden Part Number	
	Multimode	Single-Mode

FiberExpress Pre-Connectorized Assemblies

MPO Cable Assembly, FOMC, MPO(f)-MPO(f)		
1 pulling eye, OFNP, 12 fibers, 10 m (33 ft.)	AX250021	AX250345
1 pulling eye, OFNP, 12 fibers, 20 m (66 ft.)	AX250105	AX250376
1 pulling eye, OFNP, 12 fibers, 50 m (164 ft.)	AX250349	AX250065
1 pulling eye, OFNP, 12 fibers, 75 m (246 ft.)	AX250060	AX250066
1 pulling eye, OFNP, 12 fibers, 100 m (328 ft.)	AX250061	AX250067
	Multimode	Single-Mode
1 pulling eye, OFNP, 12 fibers, 10 m (33 ft.)	AX250457	AX250224
1 pulling eye, OFNP, 12 fibers, 20 m (66 ft.)	AX250412	AX250106
1 pulling eye, OFNP, 12 fibers, 50 m (164 ft.)	AX250387	AX250071
1 pulling eye, OFNP, 12 fibers, 75 m (246 ft.)	AX250413	AX250072
1 pulling eye, OFNP, 12 fibers, 100 m (328 ft.)	AX250458	AX250073

Also available in 6 or 8-fiber MPO Cable Assemblies, please contact customer service for more details.

Description	Belden Part Number
Multi-Fiber Cable Assembly, MPO(m)-ST	
Multimode FX300, 62.5 µm, 12 fibers	NXC-RPML-PGPNNN-STPFBN-N-01.5
Multimode FX600, 50 µm, 12 fibers	NXC-RPNL-PGPNNN-STPFBN-N-01.5
Multimode FX2000, 50 µm, 12 fibers	NXC-RPFL-PGPNNN-STPFBN-N-01.5
Single-mode, 12 fibers	NXC-RPSL-PGANNN-STSFBN-N-01.5
Multi-Fiber Cable Assembly, MPO(m)-SC	
Multimode FX300, 62.5 µm, 12 fibers	NXC-RPML-PGPNNN-SCPFBN-N-01.5
Multimode FX600, 50 µm, 12 fibers	NXC-RPNL-PGPNNN-SCPFBN-N-01.5
Multimode FX2000, 50 µm, 12 fibers	NXC-RPFL-PGPNNN-SCPFBN-N-01.5
Single-mode, 12 fibers	NXC-RPSL-PGANNN-SCSFBN-N-01.5
Multi-Fiber Cable Assembly, MPO(m)-LC	
Multimode, FX300, 62.5 µm, 12 fibers	NXC-RPML-PGPNNN-LCPFBN-N-01.5
Multimode FX600, 50 µm, 12 fibers	NXC-RPNL-PGPNNN-LCPFBN-N-01.5
Multimode FX2000, 50 µm, 12 fibers	NXC-RPFL-PGPNNN-LCPFBN-N-01.5
Single-mode, 12 fibers	NXC-RPSL-PGANNN-LCSFBN-N-01.5
Multi-Fiber Cable Assembly, MPO(m)-MTRJ(m)	
Multimode FX300, 62.5 µm, 12 fibers	NXC-RPML-PGPNNN-JBPFBN-N-01.5
Multimode FX600, 50 µm, 12 fibers	NXC-RPNL-PGPNNN-JBPFBN-N-01.5
Multimode FX2000, 50 µm, 12 fibers	NXC-RPFL-PGPNNN-JBPFBN-N-01.5
Single-mode, 12 fibers	NXC-RPSL-PGANNN-JBSFBN-N-01.5

FiberExpress Pre-Connectorized Assemblies

FiberExpress Bar

AX250001 FiberExpress Bar 12ST



MX100154 FiberExpress MPO Adapter



FiberExpress Bar

The FiberExpress bar consists of a custom length fiber cable with, at one end, a factory pre-terminated rugged mini patch panel and, at the other end, a factory installed multi-fiber MPO connector. The very compact fiber patch panel contains 6 or 12 factory-terminated and tested connectors in a variety of styles. The ruggedness of the FiberExpress bar makes it an ideal candidate for disaster recovery, industrial applications and other fiber deployment in harsh environment.

FiberExpress Bar Accessories

The MPO adapter is the sleeve that provides primary alignment and locking when connecting the two MPO connectors (male to female). It has a flange and a metal clip for panel mounting and it is included with each FiberExpress bar (1m with male connector).

The 19" (0.48 m) rack mount housing is a 1U metal panel that holds one FiberExpress bar. It has a live hinge on the left-hand side and swings out giving access to the MPO connection and facilitate cable management and slack storage when used with the slack storage tray.

The front cover is a smoked plexiglas cover that protects the fiber cords connected to the FiberExpress bar. It has 2 push rivets for positive locking and easy handling.

The slack storage tray attaches to the back of the 19" (0.48 m) rack mount housing to facilitate cable management and slack storage. It has a storage capacity of 5 meters of 12-fiber ribbon cable. The wall mount enclosure can contain one FiberExpress bar. It is made of heavy gage steel and has a locking cover.

Description	Belden Part Number	
	Multimode, FX300, 62.5 μm	Multimode, FX600, 50.0 μm

FiberExpress Pre-Connectorized Assemblies

FiberExpress Bar		
12 ST type, MPO (m), 1 m	AX250001	AX250052
6 SC duplex, MPO (m), 12 fibers, 1 m	AX250005	AX250054
6 MT-RJ, MPO (m), 12 fibers, 1 m	AX250178	AX250179
12 LC, MPO (m), 1 m	AX250539	AX250540
	Multimode, FX2000, 50.0 μm	Single-Mode
12 ST type, MPO (m), 1 m	AX250459	AX250009
6 SC duplex, MPO (m), 12 fibers, 1 m	AX250460	AX250011
6 MT-RJ, MPO (m), 12 fibers, 1 m	AX250461	AX250180
12 LC, MPO (m), 1 m	AX250541	AX250542

Also available for 6 fibers, please contact customer service for more details.

Description	Belden Part Number
FiberExpress Bar Accessories	
MPO Adapter (6 or 12 fibers) included with each FiberExpress Bar (1 m - male)	MX100154
19" (0.48 m) Rack Mount Housing for FiberExpress Bar, Grey	AX100331
19" (0.48 m) Rack Mount Housing for FiberExpress Bar, Black	AX100330
Front Cover for FiberExpress Rack Mount Housing	AX100332
Slack Storage Tray for FiberExpress Bar, (capacity: 5 meters) including top cover, Grey	AX100329
Slack Storage Tray for FiberExpress Bar, (capacity: 5 meters) including top cover, Black	AX100328
Wall Mount Enclosure, can contain one bar, Black	AC200004

These products are in the process of being assessed for RoHS compliance. Please check our website for the most current RoHS status.

FiberExpress Secure/Keyed LC System

Optimax® Field Installable Connectors and Patch Cords & Pigtails

AX102197 Secure/keyed LC Optimax®



Secure/keyed LC System



FiberExpress Secure/Keyed LC System

The FiberExpress secure/keyed LC system allows for physical segregation of network segments in secure fiber cabling infrastructures. All secure/keyed LC products are available with 6 different keying options each carrying a different color to facilitate network administration. The keying detail inside the connector is totally tamper-resistant and cannot be re-produced inside a standard LC connector to violate the network security. All products comply with the FOCIS 10 standard and optical performance exceeds all industry standards for SFF connectors.

The secure/keyed LC Optimax® field installable connectors are available in multimode 50 µm laser-optimized and 62.5 µm fiber versions. They are high-quality connectors that use a ceramic ferrule with a physical contact (PC) polish for multimode connectors.

The secure/keyed LC patch cords and pigtails are offered in multimode 62.5 µm (FX300), 50/125 µm (FX600) and laser-optimized 50/125 µm (FX2000) for the most demanding network performance.

Description	Belden Part Number					
	K1, Red	K2, Green	K3, Yellow	K4, Black	K5, Orange	K6, Blue
FiberExpress Secure/Keyed LC System						
Secure/Keyed LC Optimax**						
Multimode 62.5 µm**	AX102203	AX102204	AX102205	AX102206	AX102207	AX102208
Multimode 50 µm**	AX102197	AX102198	AX102199	AX102200	AX102201	AX102202
Secure/Keyed LC Duplex Patch Cord, KEYx-KEYx*						
2 m (6 ft.), Multimode FX300, 62.5 µm	AX201365	AX201366	AX201367	AX201368	AX201369	AX201370
2 m (6 ft.), Multimode FX600, 50 µm	AX201383	AX201384	AX201385	AX201386	AX201387	AX201388
2 m (6 ft.), Multimode FX2000, 50 µm	AX201401	AX201402	AX201403	AX201404	AX201405	AX201406
3 m (10 ft.), Multimode FX300, 62.5 µm	AX201371	AX201372	AX201373	AX201374	AX201375	AX201376
3 m (10 ft.), Multimode FX600, 50 µm	AX201389	AX201390	AX201391	AX201392	AX201393	AX201394
3 m (10 ft.), Multimode FX2000, 50 µm	AX201407	AX201408	AX201409	AX201410	AX201411	AX201412
5 m (16 ft.), Multimode FX300, 62.5 µm	AX201377	AX201378	AX201379	AX201380	AX201381	AX201382
5 m (16 ft.), Multimode FX600, 50 µm	AX201395	AX201396	AX201397	AX201398	AX201399	AX201400
5 m (16 ft.), Multimode FX2000, 50 µm	AX201413	AX201414	AX201415	AX201416	AX201417	AX201418
Secure/Keyed LC Duplex Hybrid Patch Cord, KEYx-LCD*						
2 m (6 ft.), Multimode FX300, 62.5 µm	AX201419	AX201420	AX201421	AX201422	AX201423	AX201424
2 m (6 ft.), Multimode FX600, 50 µm	AX201437	AX201438	AX201439	AX201440	AX201441	AX201442
2 m (6 ft.), Multimode FX2000, 50 µm	AX201455	AX201456	AX201457	AX201458	AX201459	AX201460
3 m (10 ft.), Multimode FX300, 62.5 µm	AX201425	AX201426	AX201427	AX201428	AX201429	AX201430
3 m (10 ft.), Multimode FX600, 50 µm	AX201443	AX201444	AX201445	AX201446	AX201447	AX201448
3 m (10 ft.), Multimode FX2000, 50 µm	AX201461	AX201462	AX201463	AX201464	AX201465	AX201466
5 m (16 ft.), Multimode FX300, 62.5 µm	AX201431	AX201432	AX201433	AX201434	AX201435	AX201436
5 m (16 ft.), Multimode FX600, 50 µm	AX201449	AX201450	AX201451	AX201452	AX201453	AX201454
5 m (16 ft.), Multimode FX2000, 50 µm	AX201467	AX201468	AX201469	AX201470	AX201471	AX201472
Secure/Keyed LC Duplex Hybrid Patch Cord, KEYx-SCD*						
2 m (6 ft.), Multimode FX300, 62.5 µm	AX201473	AX201474	AX201475	AX201476	AX201477	AX201478
2 m (6 ft.), Multimode FX600, 50 µm	AX201491	AX201492	AX201493	AX201494	AX201495	AX201496
2 m (6 ft.), Multimode FX2000, 50 µm	AX201509	AX201510	AX201511	AX201512	AX201513	AX201514
3 m (10 ft.), Multimode FX300, 62.5 µm	AX201479	AX201480	AX201481	AX201482	AX201483	AX201484
3 m (10 ft.), Multimode FX600, 50 µm	AX201497	AX201498	AX201499	AX201500	AX201501	AX201502
3 m (10 ft.), Multimode FX2000, 50 µm	AX201515	AX201516	AX201517	AX201518	AX201519	AX201520
5 m (16 ft.), Multimode FX300, 62.5 µm	AX201485	AX201486	AX201487	AX201488	AX201489	AX201490
5 m (16 ft.), Multimode FX600, 50 µm	AX201503	AX201504	AX201505	AX201506	AX201507	AX201508
5 m (16 ft.), Multimode FX2000, 50 µm	AX201521	AX201522	AX201523	AX201524	AX201525	AX201526
Secure/Keyed LC Pigtail, KEYx-open*						
2 m (6 ft.), Multimode FX300, 62.5 µm	AX201527	AX201528	AX201529	AX201530	AX201531	AX201532
2 m (6 ft.), Multimode FX600, 50 µm	AX201533	AX201534	AX201535	AX201536	AX201537	AX201538
2 m (6 ft.), Multimode FX2000, 50 µm	AX201539	AX201540	AX201541	AX201542	AX201543	AX201544

These products are in the process of being assessed for RoHS compliance. Please check our website for the most current RoHS status.

* Patent pending. • ** For 900 µm buffered fiber only. The same accessory kit (AX101984) is used for 2 mm jacketed cable connector termination as for our regular Optimax® LC offering.

FiberExpress Secure/Keyed LC System

Adapter Modules, Adapter Strips and FiberExpress Manager Modules

AX102098 Secure/keyed LC Adapter Module



FiberExpress Secure/Keyed LC System

The FiberExpress secure/keyed LC System allows for physical segregation of network segments in secure fiber cabling infrastructures. All secure/keyed LC products are available with 6 different keying options each carrying a different color to facilitate network administration. The keying detail inside the connector is totally tamper-resistant and cannot be re-produced inside a standard LC connector to violate the network security. All products comply with the FOCIS 10 standard and optical performance exceeds all industry standards for SFF connectors.

The secure/keyed LC adapter modules and adapter strips can be used in all mounting hardware for workstation area, consolidation point or Telecom room applications.

AX102124 Secure/keyed LC Adapter Strip



The secure/keyed LC FiberExpress manager modules can be used in 19" (0.48 m) and 23" (0.58 m) FiberExpress manager shelves to provide a high-density management system of up to 1920 terminated fibers per rack.

AX102114 Secure/keyed LC FiberExpress Manager Module



Description	Belden Part Number					
	K1, Red	K2, Green	K3, Yellow	K4, Black	K5, Orange	K6, Blue
FiberExpress Secure/Keyed LC System						
Secure/Keyed LC Adapter Module*						
Grey holder	AX102089	AX102090	AX102091	AX102092	AX102093	AX102094
Almond holder	AX102095	AX102096	AX102097	AX102098	AX102099	AX102100
White holder	AX102101	AX102102	AX102103	AX102104	AX102105	AX102106
Black holder	AX102107	AX102108	AX102109	AX102110	AX102111	AX102112
Secure/Keyed LC FiberExpress Adapter Strip*						
12 fibers	AX102119	AX102120	AX102121	AX102122	AX102123	AX102124
24 fibers	AX102125	AX102126	AX102127	AX102128	AX102129	AX102130
Secure/Keyed LC FiberExpress Manager Module*						
12 fibers	AX102113	AX102114	AX102115	AX102116	AX102117	AX102118
24 fibers	AX102310	AX102311	AX102312	AX102313	AX102314	AX102315

* Patent pending.
These products are in the process of being assessed for RoHS compliance. Please check our website for the most current RoHS status.

FiberExpress Manager

Rack Components and Modules

AX100934
FiberExpress
Manager Shelf



FiberExpress Manager Shelf

FiberExpress modules are rack-mounted using FiberExpress manager shelves. The shelves provide the total system with extra high connection density while facilitating cable routing and patch cord management. For 19" (0.48 m) or 23" (0.58 m) h rack: 19" (0.48 m) shelf holds up to 12 modules; 23" (0.58 m) shelf holds up to 16 modules.

AX101943 FiberExpress
Manager 1U Rack Mount
Patch Panel



FiberExpress Manager 1U

The FiberExpress manager 1U rack mount patch panel is a low-cost, compact assembly designed for interconnection or splicing of optical fiber cables, using up to three FiberExpress manager modules. The low-profile design minimizes rack space to only 45 mm (1.75"). An optional FiberExpress manager 1U cable management accessory is also available.

AX102032 FiberExpress
Manager 1U Cable
Management
Accessory

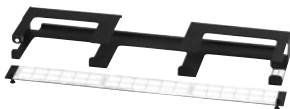

FiberExpress Manager Connector Module

The connector module is the basic building block of the FiberExpress manager. It is designed with a unique release mechanism that allows it to slide from the shelf like a PC card, easing management of patch cords.

AX101525 Connector Module
Pre-terminated
MPO-MT-RJ

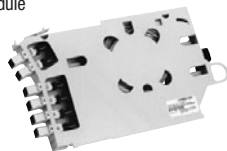

Description	Belden Part Number	
	Grey	Black

FiberExpress Manager

FiberExpress Manager		
Shelf, 23" (0.58 m), 10.9 kg (24 lbs.)	AX100934	AX100935
Shelf, 19" (0.48 m), 8.2 kg (18 lbs.)	AX101084	AX101085
1U, Rack Mount Patch Panel, 19" (0.48 m), 5 kg (11 lbs.)	AX101944	AX101943
1U, Cable Management Accessory, 19" (0.48 m), 1 kg (2 lbs.)	AX102033	AX102032

Description	Belden Part Number					
	ST Type	SC Simplex	SC Duplex	SC Duplex (ST in)	LC	FC

FiberExpress Manager

FiberExpress Manager Connector Module						
Metal Sleeve, Multimode, 6 fibers	AX101089	-	AX101092	-	-	-
Zirconia Ceramic, Single-mode, 6 fibers	AX100936	AX100943	AX100944	-	-	-
Metal Sleeve, Multimode, 12 fibers	AX101187	-	AX101714	AX101120	AX101528	-
Zirconia Ceramic, Single-mode, 12 fibers	AX101186	-	AX101713	AX101119	AX101527	-
Zirconia Ceramic, Single-mode, 12 UPC pigtails	-	-	AX101715	-	-	-
Metal Sleeve, Multimode, 24 fibers	-	-	-	-	AX102306	-
Zirconia Ceramic, Single-mode, 24 fibers	-	-	-	-	AX102305	-
Zirconia Ceramic, Single-mode/Multimode, 6 fibers	-	-	-	-	-	AX100937

Description	Belden Part Number			
	Multimode 62.5 µm	Multimode 50.0 µm	Single-Mode	-
MPO(m)-ST type, 12 pre-terminated	AX101189	AX101190	AX101188	-
MPO(m)-SC Duplex, 12 pre-terminated	AX101091	AX101114	AX101090	-
MPO(m)-MT-RJ(m), 12 pre-terminated	AX101525	AX101526	AX101524	-
MPO(m)-LC, 12 pre-terminated	AX101530	AX101531	AX101529	-
MPO(m)-LC, 24 pre-terminated	AX102309	AX102308	AX102307	-
MT-RJ, Beige, Multimode, 12 fibers	-	-	-	AX101096
MT-RJ, Blue, Single-mode, 12 fibers	-	-	-	AX101581

These products are in the process of being assessed for RoHS compliance. Please check our website for the most current RoHS status.



FiberExpress Patch Panels

Rack Mount Patch Panels

AX100041 FiberExpress, 12/24 Port (1U) Rack Mount Patch Panel



AX100069 FiberExpress, 24/48 Port (2U) Rack Mount Patch Panel

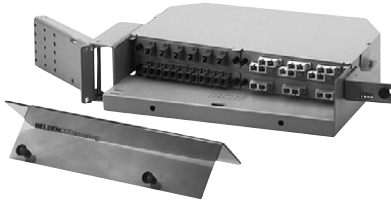

AX100078 FiberExpress (3U) Rack Mount Patch Panel



AX100115 FiberExpress, 48/96 Port (4U) Rack Mount Patch Panel



If single-ended patch cords are to be spliced to the fiber cable, don't forget to order splice organizer trays or kits. Both these, and the universal adapter strips can be ordered in the FiberExpress accessories section.

* IMPORTANT: The FiberExpress 1U accepts two (2) 203 mm (8") splice trays. The 2U accepts four (4) 203 mm (8") splice trays.

These products are in the process of being assessed for RoHS compliance. Please check our website for the most current RoHS status.

FiberExpress Rack Mount Patch Panel 1U and 2U

The FiberExpress 1U and 2U rack mount patch panels are equipped with a special hinge that allows easy access to the rear of the patch panel without disturbing the optical fiber cable. A specially designed front panel allows connector protection and easy routing of optical fiber patch cords. The FiberExpress rack mount patch panels are also compatible with our 203 mm (8") splice organizer trays. This allows the optical fiber cable to be either terminated with fiber single-ended patch cords or field-installable connectors. The patch panels can be used with ST Compatible, SC, 568SC, FC, LC or MT-RJ adapters strips (ordered separately).

The FiberExpress 1U rack mount patch panel is a low-cost, compact assembly designed for interconnection or splicing of optical fiber cables, from 12 up to 48 fibers if MT-RJ or LC double density adapter strips are used. The low-profile design minimizes rack space to only 45 mm (1.75"). An optional smoked plexiglass front cover is also available.

The FiberExpress 2U rack mount patch panel offers a high fiber capacity, 96 fibers if using double density MT-RJ or LC adapter strips. The FiberExpress 2U comes equipped with a smoked plexiglass front cover that protects fiber connections while allowing for quick visual inspection.

FiberExpress Rack Mount Patch Panel 3U

The FiberExpress 3U rack mount patch panel can accommodate up to 96 optical fiber connections using MT-RJ or LC connectors. The connector panel is mounted on a sliding drawer for easy access to the back side (cable side) of the panel. The FiberExpress 3U rack mount patch panel can be used with either optical fiber single-ended patch cords or field-installable connectors. If optical single-ended patch cords are to be used, organizer trays are easily accessible via the removable front access pull-out drawer. (Trays must be ordered separately.)

The FiberExpress 3U rack mount patch panel is a compact cross-connect assembly for the termination of optical fiber cables. The low-profile design minimizes required rack space to 127 mm (5"). It is compatible with ST compatible, SC, 568SC, MT-RJ, LC and FC adapters strips (ordered separately).

FiberExpress Rack Mount Patch Panel 4U

The FiberExpress 4U rack mount patch panel is an economical solution for the protection of optical fiber terminations and splices, up to 192 optical fibers if using MT-RJ or LC connectors. The connector panel, accepting the universal adapter strips, is located inside the enclosure and swings out (left or right) to give easy access to the cable and splices.

The FiberExpress 4U rack mount patch panel is a compact cross-connect enclosure for the cross-connection, interconnection or splicing of optical fiber cables. The low-profile design minimizes required rack space to 178 mm (7"). It can be used with ST Compatible, SC, 568SC, MT-RJ, LC and FC adapters strips (ordered separately).

Description	Belden Part Number
FiberExpress Patch Panels	
FiberExpress Rack Mount Patch Panel 1U*	
Grey	AX100042
Black	AX100041
FiberExpress Rack Mount Patch Panel 2U*	
Grey	AX100069
Black	AX100068
FiberExpress Rack Mount Patch Panel 3U	
Grey	AX100078
Black	AX100077
FiberExpress Rack Mount Patch Panel 4U	
Grey	AX100115
Black	AX100116

FiberExpress Patch Panels

Rack Mount Accessories and Wall Mount Patch Panels

AX101800 127 mm (5") Universal Offset Bracket Kit, for 19" (0.48 m) and 23" (0.58 m) Racks 1U



AX101802 23" (0.58 m) Rack Universal Extension Bracket for 1U and 2U



AX100047 Right Side Cable Entry Bracket for 1U



AX100045 Front Cover for 1U



AX100543 Large Wall Mount



FiberExpress Rack Mount Patch Panels 1U and 2U Accessories

The accessories provide additional panel mounting flexibility for racks, cabinets and cable entry.

Description	Belden Part Number
FiberExpress Patch Panels	
Rack Mount Accessories (1U and 2U)	
127 mm (5") Universal Offset Bracket Kit:	
for 19" (0.48 m) and 23" (0.58 m) racks (1U), Black	AX101799
for 19" (0.48 m) and 23" (0.58 m) racks (1U), Grey	AX101800
for 19" (0.48 m) and 23" (0.58 m) racks (2U), Black	AX101797
for 19" (0.48 m) and 23" (0.58 m) racks (2U), Grey	AX101798
23" (0.58 m) Universal extension bracket, Black	AX101801
23" (0.58 m) Universal extension bracket, Grey	AX101802
Right side cable entry bracket (1U), Black	AX100046
Right side cable entry bracket (1U), Grey	AX100047
Right side cable entry bracket (2U), Black	AX100073
Right side cable entry bracket (2U), Grey	AX100074
Front Cover (1U), Smoked Plexiglass	AX100045

FiberExpress Wall Mount Patch Panel

The FiberExpress wall mount patch panel series is an economical solution for the protection of optical fiber terminations and splices in hostile environments. Using the FiberExpress universal adapter strips (ordered separately), the wall mount patch panels allow for flexible and customized patch panel design. They are compatible with most industry standard connections: ST compatible, SC, 568SC, MT-RJ, LC and FC.

Available in grey and black, the FiberExpress wall mount patch panels have an ergonomic design, rugged construction and compact assemblies to effectively protect your optical fiber terminations and splices.

Description	Belden Part Number
FiberExpress Patch Panels	
Wall Mount	
Small, Grey	AX100496
Small, Black	AX100495
Medium, Grey	AX100541
Medium, Black	AX100540
Large, Grey	AX100543
Large, Black	AX100542

If optical single-ended patch cords are to be spliced to the fiber cable, don't forget to order splice organizer trays or kits in FiberExpress accessories section. Universal adapter strips can be ordered in FiberExpress patch panels section. These products are in the process of being assessed for RoHS compliance. Please check our website for the most current RoHS status.

AX100541 Medium Wall Mount



AX100495 Small Wall Mount



FiberExpress Patch Panels Accessories

Universal Optical Fiber Adapter Strips and Accessories

AX101729 Adapters
loaded with 6 LC Duplex



AX100094 Adapters
loaded with 3 SC Duplex

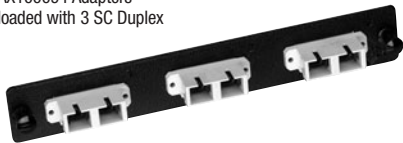

AX100066 Blank Strip



AX101100 Field Breakout Kit

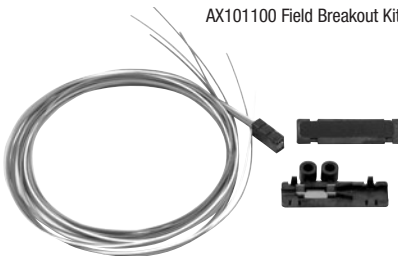

A0649869 Optical Fiber Splice Organizer Kits and Trays

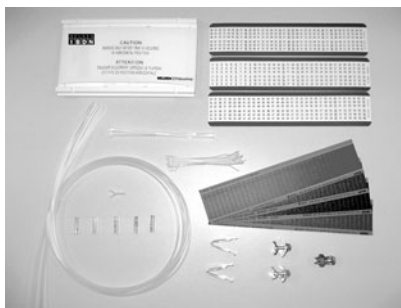

AX100945 Flex Kit



AX101098 Splice Holder Kit

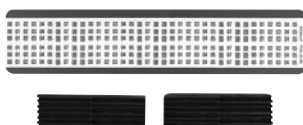

Optical Fiber Adapter Strips

Universal optical fiber adapter strips are pre-loaded with six (single density) or 12 (double density) adapter sleeves. Two types of adapter sleeves are available: phosphor bronze and zirconia ceramic. Adapter sleeves are used as the connecting interface between two optical fiber connectors. A blank adapter strip is also available and can be used with any FiberExpress patch panel to fill in unused adapter strip openings.

Optical Fiber Accessories

The field breakout kit is designed to attach to one tube of a loose-tube cable. Each kit has either six or twelve 900 µm tubes that hold each of the coated fibers. For each end of the cable, one kit is needed for every tube. For example, a 12-fiber 62.5 µm cable contains two 6-fiber tubes. This cable would require four kits, two for each end. Optical fiber splice organizer kits provide the accessories necessary for installing the FiberExpress fiber patch panels, as well as other fiber terminals that accommodate the standard Belden organizer tray. The Flex Kit contains tubes and manifolds designed to split cables into individual fiber strands, and is suitable for 6 fibers up to 12 fibers. It is necessary for use with loose tube cables or when the fiber cable count does not match the number of connections in the FiberExpress manager connector module. The Flex Kit tubes help to maintain proper fiber bend radius. One kit is required per 12 modules (one 19"/0.48 m shelf). A splice holder kit can be used to hold fusion or mechanical splices. Each splice holder can handle up to 6 splices.

Description	Belden Part Number	
	Phosphor Bronze, Multimode	Zirconia Ceramic, Single-Mode

FiberExpress Optical Fiber Adapter Strips

Single Density, Black		
Loaded with 6 ST Compatible Adapters	AX100088	AX100534
Loaded with 3 SC Duplex Adapters	AX100094	AX101407
Loaded with 6 SC Simplex Adapters	AX100092	AX100538
Loaded with 6 FC Adapters	AX100090	AX100536
Loaded with 6 LC Duplex Adapters	AX101729	AX101731
MT-RJ, loaded with 6 MT-RJ, Multimode/Single-mode	AX101115	
Double Density, Black		
Loaded with 12 ST Compatible Adapters	AX100080	AX100528
Loaded with 6 SC Duplex Adapters	AX100098	AX101409
Loaded with 12 SC Simplex Adapters	AX100084	AX100532
Loaded with 12 FC Adapters	AX100082	AX100530
Loaded with 12 LC Duplex Adapters	AX101741	AX101743
MT-RJ, loaded with 12 MT-RJ, Multimode/Single-mode	AX101117	
Blank Strip		
Black	AX100066	

FiberExpress Accessories

Optical Fiber Field Breakout Kit	
6 fibers, 1/pack	AX101100
12 fibers, 1/pack	AX101101
Optical Fiber Splice Organizer Kit	
Splice kit, tray, 203 mm (8")	A0649869
Splice kit, tray, 305 mm (12")	A0318904
Optical Fiber Splice Tray	
Fusion, 203 mm (8")	A0335015
Fusion, 305 mm (12")	A0316446
Universal (mechanical or fusion), 203 mm (8")	AX100079
Universal (mechanical or fusion), 305 mm (12")	A0394328
Tray cover, 203 mm (8")	A0394331
Tray cover, 305 mm (12")	A0394330
Flex Kit	AX100945
Splice Holder Kit	AX101098

These products are in the process of being assessed for RoHS compliance. Please check our website for the most current RoHS status.

FiberExpress Outlets

MediaFlex Plates and Inserts

AX101869 MediaFlex Plate, Double Gang



MediaFlex Plate

MediaFlex plates are one part of the comprehensive line of plates and inserts that snap together to create a full line of modular workstation outlets. MediaFlex plates can be mounted over standard NEMA type outlet boxes and rings to provide support for a variety of MediaFlex adapters and inserts. The fully modular construction combined with the front access design provides extensive configuration flexibility for current and future network needs. MediaFlex plates are available in single gang and double gang configurations.

The double gang faceplate comes with a stand-off ring included in the package. This ring allows for easy mounting with virtually any industry electrical box or mud/adaptor rings, therefore providing added installation flexibility. Each plate has the capacity of up to 6 ports per single gang and 12 ports per double gang.

AX101874 MediaFlex Adapter Box, Double Gang

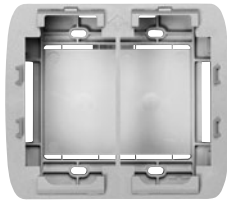

MediaFlex Adapter Box

MediaFlex surface adapter boxes are one part of the comprehensive line of plates and inserts that snap together to create a full line of modular workstation outlets.

MediaFlex surface adapter boxes can be mounted over standard NEMA type outlet boxes and rings to provide support for the MediaFlex plates. The MediaFlex surface adapter boxes are available as a double gang configuration. The double gang box allows more room for cable management and bend radius control.

AX101756 MediaFlex MDVO (style) Insert, 2-port, Angled



MediaFlex MDVO (style) Insert

MediaFlex MDVO-style Inserts are available in a 2-port configuration in both Flush and Angled versions. They are compatible with all GigaFlex and MDVO modules (EZ-MDVO and multimedia). The inserts are two units high for the flush version and three units high for the angled version. Therefore three flush inserts or two angled inserts are required to fully populate a single gang MediaFlex plate.

AX101937 MediaFlex SC Duplex Insert, Angled



MediaFlex Multimedia Insert

MediaFlex multimedia inserts provide optimum flexibility in configuring multimedia workstation outlets that respond to any present or future network needs. MediaFlex multimedia inserts along with other MediaFlex inserts allow for easy configuration of outlets. All inserts are front loaded and easily snapped in and out of the MediaFlex plates for easy installation and maintenance.

MediaFlex multimedia Inserts are available in angled versions only in order to allow for proper management of cable bend radius. The inserts are three units high, therefore two inserts are required to fully populate a single gang faceplate and four inserts will fully populate a double gang faceplate.

Description	Belden Part Number					
	K1, Red	K2, Green	K3, Yellow	K4, Black	K5, Orange	K6, Blue

FiberExpress Outlets

MediaFlex Plate						
Single Gang	AX101745	AX101746	AX101747	AX101748	AX102608	AX102569
Double Gang	AX101869	AX101870	AX101871	AX101872	AX102609	AX102570
MediaFlex Adapter Box						
Single Gang	AX102480	AX102481	AX102482	AX102483	AX102484	AX102485
Double Gang	AX101873	AX101874	AX101875	AX101876	AX102610	AX102571
MediaFlex MDVO (style) Insert						
2-port, Flush, bag of 10 units	AX101749	AX101750	AX101751	AX101752	AX102612	AX102572
2-port, Angled, bag of 10 units	AX101753	AX101754	AX101755	AX101756	AX102613	AX102573
MediaFlex SC Duplex						
SC Duplex Single-mode	AX101935	AX101936	AX101937	AX101938	AX102619	AX102649
SC Duplex Multimode	AX101939	AX101940	AX101941	AX101942	AX102620	AX102650

These products are in the process of being assessed for RoHS compliance. Please check our website for the most current RoHS status.



FiberExpress Outlets

MDVO Multimedia Outlet Boxes & Modules and Multi-User Outlet Boxes

A0643205 MDVO Multimedia Outlet Box, shown here as terminated

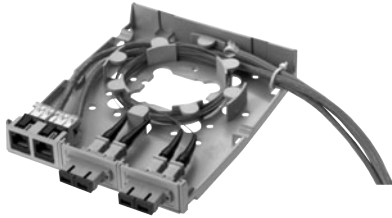

A0407005 MDVO SC Fiber Module



A0649254 SC Duplex Adapter



A0407010 MDVO ST Compatible Fiber Module



AX101467 MDVO MT-RJ Fiber Module



AX100222 Multi-User Outlet Box, shown here with modules



MDVO Multimedia Outlet Box

The MDVO multimedia outlet box brings unique versatility for multimedia work area installations. The box design provides cable management and helps maintain cable bend radius. The low-profile design and side-entry of the outlet box offer better protection for patch cords. The outlet box can accept up to six EZ-MDVO, GigaFlex or MDVO multimedia modules or three SC duplex adapters.

The MDVO multimedia outlet box can be mounted directly on the wall or attached to standard electrical boxes. Included with the MDVO multimedia box are three SC duplex mounting bezels and three MDVO adapters.

MDVO Multimedia Modules

MDVO multimedia modules address audio/video and fiber applications. Fiber modules are available for LC duplex, SC simplex, ST compatible multimode and MT-RJ multimode & single-mode connections. The SC duplex adapter is a fiber adapter sleeve with flanges that mounts into the SC duplex mounting bezel (included in the MDVO multimedia outlet box). Audio/video modules are available for SVHS, RCA, BNC and Video F connections.

Multi-User Outlet Box

The multi-user outlet box is a versatile box that can be used in many different applications. The outlet box can accommodate up to 24 connections of any type, UTP, fiber or coax. The outlet box is ideal for use as a multi-user telecommunications assembly, or simply as a high-density multimedia telecommunications outlet. The multi-user outlet box can also be used as a wall mounted patch panel in confined areas, such as shallow rooms and cabinets.

Description	Belden Part Number			
	MOVO-Style	MOVO-Style	MOVO-Style	Keystone-Style

FiberExpress Outlets

MDVO Multimedia Outlet Box				
6-port	A0643205	A0643206	A0643207	A0643208

Please note that SC Duplex adapters must be ordered separately (A0649254).

MDVO Multimedia Module				
LC Duplex Multimode	AX102209	AX102210	AX102211	AX102212
LC Duplex Single-mode	AX102213	AX102214	AX102215	AX102216
SC Simplex, Multimode, Blue insert	A0407003	A0407004	A0407005	A0407006
SC Duplex Adapter, Multimode	-	A0649254	-	-
ST Compatible, Multimode	A0407007	A0407008	A0407009	A0407010
MT-RJ, Multimode	-	AX101467	-	-
MT-RJ, Single-mode, Blue	-	AX101466	-	-

Custom multimedia connectors are also available, please contact customer service for more details.

Multi-User Outlet Box				
24-port	AX100219	AX100220	AX100221	AX100222

These products are in the process of being assessed for RoHS compliance. Please check our website for the most current RoHS status.

Network Connectivity Products

Media Converters, Transceivers & Hubs and Network Tester

Media Converters



Media Converters for Ethernet and Fast Ethernet

Media converters enable the connection of dissimilar network cabling types, while maintaining the same network speed. A legacy thinnet segment can be connected to a 10Base-T Hub or switch port with an AX-200 Converter or, link two different 10Base-T networks together over a multimode fiber optic link with a pair of AX-270s. Connect a legacy thinnet segment over fiber with the AX-280 converter. The AX-5270 can be used for interbuilding links or attached to a fiber backbone.

AX-1912 Media Converter Rack

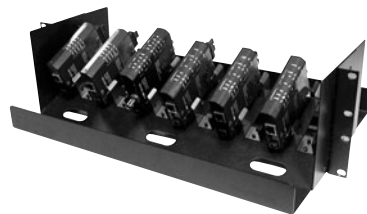

Transceivers and Ethernet Hubs

The AX-50, 70 and 80 transceivers enable the connection of a legacy AUI port to 10Base-T, Thinnet, or Fiber Optic media. The transceiver is powered from the host and requires no external power supply. The AX-509 Ethernet Hub has an AUI port which accepts UTP, Fiber Optic or BNC transceivers. Specified for use by many U.S. Government Agencies. Includes a 110v/12v power supply.

AX050, 70 and 80 Transceivers and AX-509 Ethernet Hub



Realtime 10/100 Base-TX Ethernet Network Test Unit

The AX-110BT realtime 10/100 Base-TX ethernet network test unit is a cost effective way to quickly determine a network's operating condition. Plug the unit's patch cord into the tester, then into any open RJ-45 jack in an office, cubicle or conference room. Immediately see if the jack is a live network node capable of either 100 Mb/s or 10 Mb/s. Next check patch cord continuity and polarity. Connect the downlink to a PC to check NIC card link, speed and full or half duplex capabilities. Connect the uplink to a hub or switch port to verify link and speed.

AX-110BT Realtime 10/100 Base-TX Ethernet Network Test Unit



Description	Belden Part Number
Network Connectivity Products	
Media Converter	
10Base-T/10Base2, RJ-45 to BNC	AX-200
10Base-T/10Base-FL, RJ-45 to ST-Compatible fiber connectors	AX-270
10Base2/10Base-FL, BNC to ST-Compatible fiber connectors	AX-280
100Base-TX/100Base-FX, SC-Compatible fiber connectors	AX-5270SC
100Base-TX/100Base-FX, ST-Compatible fiber connectors	AX-5270ST
Media Converter Rack	
Holds up to 12 converters and multi lead power supplies, 19" (0.48 m) rack-mount ready	AX-1912-MCR
Power Supply, 4-lead 110v/12v, powers up to 4 converters	AX-270P4U
Power Supply, 8-lead 110v/12v, powers up to 8 converters	AX-270P8U
Transceivers and Ethernet Hubs	
UTP Transceiver, 10Base-T, AUI to RJ-45, side port	AX-50
UTP Transceiver, 10Base-T, AUI to RJ-45, rear port	AX-50R
Fiber Transceiver, 10Base-FL, AUI to ST-Compatible	AX-70
Thinnet Transceiver, 10Base2, AUI to BNC	AX-80
Ethernet Hub with 8 RJ-45 10Base-T ports and 1 AUI port	AX-509
Network Tester	
Realtime 10/100 Base-TX Ethernet Network Test Unit	AX-110BT

These products are in the process of being assessed for RoHS compliance. Please check our website for the most current RoHS status.

Introduction Cables

Advanced Networks Need Advanced Technology

Today's advanced networks are diverse and very varied and almost always complex. The right way ahead is to future-proof these networks and take precautions to protect them against anything that will create problems, damage or disrupt. That means matching the right hardware with the right cabling to guarantee performance – and that means choosing fiber optic cable. This type of cable has become essential for bringing light-speed communication to hospitals, corporate campuses, educational facilities and other projects.

Key Applications

- Closed circuit television
- Network circuitry
- Factory automation
- Major commercial networks
- Video conferencing
- Medical imaging
- CAD/CAM

Special Features

• Interconnect Cables

Featuring semi-tight buffer and tight buffer technology for easy cable preparation during termination.

- Semi-tight buffered fiber cables are available in dry or jelly-filled constructions; both have excellent strippability properties (≤ 100 cm).
- Tight-buffered fiber cables are dry constructions and designed for easy stripping in cable preparation (≤ 10 cm).

• Breakout Cables (BO)

Breakout cables are the preferred choice for direct termination methods. Each numbered fiber subunit is protected by a layer of aramid yarn and encased in a FRNC/LSNH jacket. The individual subunits are cabled and then jacketed with a flame resistant FRNC/LSNH compound. Each fiber uses either the tight buffer technology or semi-tight buffer technology for excellent fiber stripping.

• Belden's Mini-Breakout

This cables offer dry constructions with semi-tight or tight buffer technology for easier fiber stripping during cable preparation. They are perfect for both indoor and indoor/outdoor use.

• Mobile Fiber Cables

Mobile fiber cable is a special cable in the range is Belden's mobile fiber cable. The semi-tight buffer technology is designed for rugged field applications and will withstand temperature extremes and vehicle traffic. Repeating bending is > 500000 times according to IEC 60794-1-2-E6. For indoor use, it has flame retardancy acc. IEC 60332-2.

• Central Loose Tube Cables (CLT)

Central loose tube cables are designed either for indoor/outdoor application or outdoor use only as direct burial, duct and outside tray. For better performance, Belden only uses (non-dripping and silicone-free) jelly-filled loose tubes. The central loose tube series has a polyethylene or halogen-free jacket. These cables have been updated with a longitudinal watertightness swellable yarn for weather-resistance.

- Standard and improved rodent protection designs are available with up to 24 fiber counts.
- Central loose tube cables are also available with Corrugated Steel Tape (CST), Steel Wire Armor (SWA) or Fiber Reinforced Plastic armor (FRP) to protect the whole cable from mechanical damage and rodents.

• Multi Loose Tube Cables (MLT)

Multi loose tube cables, with no aquagel between the tubes (dry core) or with jelly-filled cable core, are designed for direct burial, duct, outside tray and aerial applications. For better performance, Belden only uses (non dripping and silicone-free) jelly-filled loose tubes. Tubes and (when necessary) blind elements are S-Z stranded around the central element. The multi loose tube series has a High-Density-Polyethylene (HDPE) or halogen-free jacket. These cables have been updated with water-blocking aramid or glass yarn. Standard and improved rodent protection designs are available with high fiber counts up to 432 fibers.

- The multi loose tube cables are also available either with Corrugated Steel Tape armor (CST) or with galvanized Steel Wire Armor (SWA) for total protection.
- Longitudinal watertightness: to guarantee longitudinal watertightness acc. to IEC 60793-1-2-F5, Belden uses swellable yarns and/or tapes or filling compound.

Options:

- All loose tube cables with additional PA (nylon) jacket for termite/rodent protection, improved chemical resistance and reduced friction.
- Replace PE jacket by Orgalloy to improve chemical resistance.

Introduction Cables

- **Belden's Universal Cables**

Belden's universal cables provide a unique combination of construction and performance characteristics that make them ideal for both outdoor and indoor use. The advantage is that splicing is not necessary when running cable from outside to inside.

- Because all fibers show surface imperfections, Belden exclusively uses fibers with proof test-level $\geq 8.8 \text{ N} / \geq 1\%$ ($\geq 100 \text{ kpsi}$). This means the expected life of the optical fiber cable is > 30 years.

- **Belden Halogen-Free Optical Fiber Cables**

This cables meet the most important international standards. The jacketing material is suitable for outdoor use, such as direct burial. Compared with other products containing halogens (such as PVC), Belden halogen-free materials offer considerable advantages in the event of a fire:

- Better vision
- Minimal poisonous gases
- No release of highly caustic acids
- Greater safety for people, materials and the environment

Belden's halogen-free optical fiber cables are both FRNC (Flame-Retardant, Non-Corrosive) and LSNH (Low-Smoke, Non-Halogen) according to recognized standards.

- **Direct Burial Cables**

In general loose tube cables are suitable for direct burial. However, in case of rocky soil armored cables are recommended.

- **Belden Optical Fiber Cables**

All cable constructions are in accordance with IEC 60793, and have been tested according to IEC 60794.

Rodent Protection

The Belden fiber optic cable line offers two different kind of rodent protection:

- **Standard Rodent Protection**
Optical fiber cables with glass reinforced yarns for strength also provide normal protection against rodents.
- **Improved Rodent Protection**
Belden offers cables with improved rodent protection. These have extra glass reinforced yarns or an extra layer of nylon (polyamide). The idea behind this is that rodents will look for the easiest route. Rodents will bite anything in order to keep their teeth in proper shape but will only continue if they feel comfortable. With the nylon layer or "glass" yarns they will normally stop and move elsewhere.

It is important to note that non-armored cable never guarantees a 100% protection against rodents.

Armored cables (CST, SWA, FRP) are heavy rodent protected.

Introduction Cables

Guide to Installation and Handling

General

When laying and installing optical fiber cables it is vitally important not to exceed the specified values set for pulling tension, bending radii and temperature. The installation methods have to be in accordance with the common standards.

If a cable needs to be fastened, constrictions ≥ 1 mm (multi-tube cable) or ≥ 0.3 mm (central-tube cable, distribution cable) must be prevented.

Outdoor/Universal Cables

It is advisable to cap the cable-ends during outdoor storage.

- **Outdoor/Universal Loose Tube Cables**
 - To ease insertion into tubes by means of compressed air or pulling wire, certified lubricants (e.g. paraffin) may be used. The use of soap or similar substances as lubricants is strictly prohibited.
 - The jelly-filling inside the tubes can be removed using a tissue soaked in turpentine.

Indoor Cables

Indoor optical fiber cables have been designed for use inside buildings. Consequently they are not longitudinally watertight.

- **Indoor Interconnection (Simplex, Duplex) Cables**
 - In cable with jelly-filled semi-tight buffered optical fibers the primary and secondary coating are separated by means of a very thin layer of jelly. Consequently the strippability is very good. If necessary the jelly can be removed using a tissue soaked in turpentine, for example.
 - Interconnection optical fiber cables have been designed for short distance applications (tens of meters) inside buildings.
- **Pigtails**
(Semi-) Tight-buffered optical fibers have been designed for short distance (≤ 10 m) applications

Introduction Cables

Part Number Coding (except Plenum Optical Fiber)

1	2	Product	3	Type	4	Construction	5	Quality	6	Fiber Count (mm)	7	Fiber Count
G	A	Messenger figure 8	A	Aramid	A	CLT T12 [1x12]	1	62.5/125-OM1	A	Simplex Duplex 1.6 mm		
	B	Outdoor Dry MLT	B	Breakout	B	CLT T24 [1x24]	2	50/125-OM2	B	Simplex Duplex 1.8 mm		
	C	Universal Dry MLT	C	CST Single sheath	C	MLT T48 [6x8] (helical)	3	50/125-OM3	C	Simplex Duplex 2.0 mm		
	D	Outdoor Filled MLT	D	CST Double Sheath	D	MLT T72 [6x12]	4	50/125-OM2e	D	Simplex Duplex 2.4 mm		
	E	Universal Filled MLT	F	FRP	E	MLT T96 [8x12]	5	50/125-OM2	E	Simplex Duplex 2.8 mm		
	I	Indoor	L	AL/PE Sheath	F	MLT T144 [12x12]	6	50/125-OM3+	F	Simplex Duplex 3.0 mm		
	M	Mobile	M	Mini-Breakout	G	MLT T36 [6x6]	7	9/125-G655	0-9	Part of Fibercount	0-9	Part of Fibercount
	O	Outdoor Dry	O	Pigtail	H	MLT T24 [6x4]	8	9/125-G652D				
	U	Universal Dry	P	Patchcord	I	MLT T192 [8x24]	9	9/125-G652B				
			R	Improved RP	J	MLT T288 [12x24]	0	No Fiber, APF				
			S	Standard RP	K	Semi-Tight (dry)						
			X	Mini-BO+RP	L	MLT T432 [18x24]						
			W	SWA	M	MLT T216 [18x12]						
					S	Semi-Tight (Jelly-Filled)						
					T	Tight						

RP = Rodent Protection • SWA = Galvanised Steel Wire Armor • CST = Corrugated Steel Tape • FRP = Fiber Reinforced Plastic Armor

To specify Part Number

1. Example: GIBT412

1	2	3	4	5	6	7
G	I	B	T	4	1	2
Fiber	Indoor	Breakout	Tight Buffer	50/125-OM2e	12	

2. Example: GDDF744

1	2	3	4	5	6	7
G	D	D	F	7	4	4
Fiber	MLT Outdoor Filled SZ	CST Double Sheat	MLT144 (12x12)	9/125-G655	144	

Optical Characteristics

European Part Number Coding (position 5)	Fiber-Type	Mode-Field Diameter / Cladding Diameter (µm)	Wavelength (nm)	Dispersion (ps / (nm • km))	PMD (ps / √km)	Cable Cut-off Wavelength (nm)	Refractive Index	Attenuation	
								Loose Tube Cables average/max. (dB / km)	(Semi-) Tight average/max. (dB / km)
Characteristics (Cabled) Single-Mode – Matched-Cladded Optical Fibers according to ITU-G.652									
9	9/125-OS1 ITU-G.652B	9.2 ± 0.4 125 ± 1	1310 1550	≤ 3.5 ≤ 18	≤ 0.2	≤ 1260	1.467 1.467	0.32/0.4 0.21/0.3	0.35/0.5 0.21/0.3
8	9/125-OS1 ITU-G.652D	9.2 ± 0.4 125 ± 0.7	1310 1550	≤ 3.5 ≤ 18	≤ 0.2	≤ 1260	1.467 1.467	0.32/0.4 0.21/0.3	0.35/0.5 0.21/0.3
Characteristics (Cabled) Single-Mode – Matched-Cladded Optical Fibers According to ITU-G.655									
7	9/125	8.4 ± 0.6/125 ± 1	1550	3.5 - 8.5	≤ 0.1 ^A	≤ 1260	1.470	0.25/0.3	0.25/0.28

Note A: Link design value

European Part Number Coding (position 5)	Fiber-Type	Core / Cladding Diameter (µm)	Wavelength (nm)	Bandwidth (MHz • km)	Ethernet Performance (m)		Numerical Aperture (µm)	Refractive Index	Attenuation	
					1GbE	10GbE			Loose Tube Cables average/max. (dB / km)	(Semi-) Tight average/max. (dB / km)
Characteristics (Cabled) Multimode – Graded-Index Optical Fibers According to IEC 60793										
1	62.5/125 OM1	62.5 ± 2.5 125 ± 1	850 1300	≤ 200 ≤ 600	275 550	33 N.A.	0.275 ± 0.015	1.495 1.490	2.7/3.2 0.6/1.1	3.0/3.2 0.7/0.9
5	50.0/125 OM2	50.0 ± 2.5 125 ± 1	850 1300	≤ 500 ≤ 500	600 600	82 N.A.	0.200 ± 0.015	1.481 1.476	2.4/3.0 0.7/1.0	2.6/2.8 0.6/0.9
2	50.0/125 OM2	50.0 ± 2.5 125 ± 1	850 1300	≤ 600 ≤ 1200	600 600	82 N.A.	0.200 ± 0.015	1.481 1.476	2.3/2.8 0.6/0.9	2.6/2.8 0.6/0.9
4	50.0/125 OM2e	50.0 ± 2.5 125 ± 1	850 1300	≤ 600 ≤ 1200	750 2000	110 N.A.	0.200 ± 0.015	1.481 1.476	2.3/2.8 0.6/0.9	2.6/2.8 0.6/0.9
3	50.0/125 OM3	50.0 ± 2.5 125 ± 1	850 1300	≤ 1500 ≤ 500	900 550	300 N.A.	0.200 ± 0.015	1.482 1.477	2.5/3.0 0.5/1.0	2.6/2.8 0.6/0.9
6	50.0/125 OM3+	50.0 ± 2.5 125 ± 1	850 1300	≤ 3500 ≤ 500	900 550	550 N.A.	0.200 ± 0.015	1.482 1.477	2.5/3.0 0.5/1.0	2.6/2.8 0.6/0.9

Introduction Cables

Cable Finder Guide Optical Fibers

Part No.	Description	Buffer	Construction	Remarks	Fiber Size μm	Application	VDE	Page
----------	-------------	--------	--------------	---------	--------------------------	-------------	-----	------

Intex, Indoor and Mobile Cables with (Semi-) Tight-Buffered Optical Fibers

Interconnect Cables								
GIOK	Pigtails	Semi-Tight	Dry	Excellent Strippability, LSNH	245	Indoor	I-K	16.25
GIPS	Simplex	Semi-Tight	Jelly-Filled	Excellent Strippability, FRNC/LSNH	245	Indoor	I-W(ZN)H	16.25
GIPS	Simplex, furcation tube	–	Dry	Empty Tube, PUR	–	Indoor	–	16.32
GIPS	Duplex	Semi-Tight	Jelly-Filled	Excellent Strippability, FRNC/LSNH, Figure 8	245	Indoor	I-W(ZN)H	16.26
GIPK	Heavy Duplex	Semi-Tight	Dry	Excellent Strippability, FRNC/LSNH, flat	245	Indoor	I-K(ZN)HH	16.26
GIPT	Mini-Zip	Tight	Dry	FRNC/LSNH, Figure 8	280	Indoor	I-V(ZN)H	16.27
Breakout Cables								
GIBT	2-24 Fibers	Tight	Dry	FRNC/LSNH	280	Indoor	I-V(ZN)HH	16.28
GIBK	2-12 Fibers	Semi-Tight	Dry	FRNC/LSNH	245	Indoor	I-K(ZN)HH	16.28
Mini-Breakout Cables (Distribution)								
GIMT	2-24 Fibers	Tight	Dry	FRNC/LSNH	280	Indoor	I-V(ZN)H	16.29
GIMK	2-8 Fibers	Semi-Tight	Dry	FRNC/LSNH	245	Indoor	I-K(ZN)H	16.29
GUMT	4-24 Fibers	Tight	Dry	FRNC/LSNH	280	In/Outdoor	A/I-VQ(ZN)H	16.30
GUXT	4-24 Fibers	Tight	Dry	FRNC/LSNH, Improved Rodent Protection	280	In/Outdoor	A/I-VQ(ZN)BH	16.31
GMMT	4-8 Fibers	Tight	Dry	Intex Mobile, PUR	280	In/Outdoor	A/I-VQ(ZN)11Y	16.32

Universal and Outdoor Cables with Loose Tubes

Central Loose Tube Cables (CLT)								
GOSA	2-12 Fibers	–	Dry	PE, Standard Rodent Protection	250	Outdoor	A-DQ(ZN)2Y	16.33
GOSB	2-24 Fibers	–	Dry	PE, Standard Rodent Protection	250	Outdoor	A-DQ(ZN)2Y	16.33
GORA	2-12 Fibers	–	Dry	PE, Improved Rodent Protection	250	Outdoor	A-DQ(ZN)B2Y	16.34
GORB	2-24 Fibers	–	Dry	PE, Improved Rodent Protection	250	Outdoor	A-DQ(ZN)B2Y	16.34
GOFB	2-24 Fibers	–	Dry	PE, Full Rodent Protection, Armored (FRP)	250	Outdoor	A-DQB2Y (FRP1.0)	16.35
GOWB	2-24 Fibers	–	Dry	Double PE, Full Rodent Protection, Armored (SWA)	250	Outdoor	A-DQ(ZN)2YB2Y (R0.63vzk)	16.35
GOCB	2-24 Fibers	–	Dry	PE, Full Rodent Protection, Armored (CST)	250	Outdoor	A-DQ(ZN)(SR)2Y	16.36
GODA	2-12 Fibers	–	Dry	Double PE, Full Rodent Protection, Armored (CST)	250	Outdoor	A-DQ(ZN)2Y(SR)2Y	16.36
GODB	2-24 Fibers	–	Dry	Double PE, Full Rodent Protection, Armored (CST)	250	Outdoor	A-DQ(ZN)2Y(SR)2Y	16.36
GUSA	2-12 Fibers	–	Dry	FRNC/LSNH, Standard Rodent Protection	250	In/Outdoor	A/I-DQ(ZN)H	16.37
GUSB	2-24 Fibers	–	Dry	FRNC/LSNH, Standard Rodent Protection	250	In/Outdoor	A/I-DQ(ZN)H	16.37
GURA	2-12 Fibers	–	Dry	FRNC/LSNH, Improved Rodent Protection	250	In/Outdoor	A/I-DQ(ZN)BH	16.38
GURB	2-24 Fibers	–	Dry	FRNC/LSNH, Improved Rodent Protection	250	In/Outdoor	A/I-DQ(ZN)BH	16.38
GUCB	2-24 Fibers	–	Dry	FRNC/LSNH, Full Rodent Protection, Armored (CST)	250	In/Outdoor	A/I-DQ(ZN)(SR)H	16.39
GUWB	2-24 Fibers	–	Dry	Double FRNC/LSNH, Full RP, Armored (SWA)	250	In/Outdoor	A/I-DQ(ZN)HBH (R0.63vzk)	16.40
GUDA	2-12 Fibers	–	Dry	Double FRNC/LSNH, Full RP, Armored (CST)	250	In/Outdoor	A/I-DQ(ZN)H(SR)H	16.39
GUDB	2-24 Fibers	–	Dry	Double FRNC/LSNH, Full RP, Armored (CST)	250	In/Outdoor	A/I-DQ(ZN)H(SR)H	16.39
Multi Loose Tube Cables (MLT)								
GBA	4-432 Fibers	–	Dry	HDPE	250	Outdoor	A-DQ(ZN)2Y	16.41
GDA	4-432 Fibers	–	Filled	HDPE	250	Outdoor	A-DF(ZN)2Y	16.42
GBR	4-432 Fibers	–	Dry	HDPE, Improved Rodent Protection	250	Outdoor	A-DQ(ZN)B2Y	16.43
GDR	4-432 Fibers	–	Filled	HDPE, Improved Rodent Protection	250	Outdoor	A-DF(ZN)B2Y	16.44
GBD	4-432 Fibers	–	Dry	HDPE, Full Rodent Protection, Armored (CST)	250	Outdoor	A-DQ(ZN)2Y(SR)2Y	16.45
GDD	4-432 Fibers	–	Filled	HDPE, Full Rodent Protection, Armored (CST)	250	Outdoor	A-DF(ZN)2Y(SR)2Y	16.46
GBW	4-432 Fibers	–	Dry	HDPE, Full Rodent Protection, Armored (SWA)	250	Outdoor	A-DQ2YB2Y (R1.0vzk)	16.47
GDW	4-432 Fibers	–	Filled	HDPE, Full Rodent Protection, Armored (SWA)	250	Outdoor	A-DF2YB2Y (R1.0vzk)	16.48
GALH	4-24 Fibers	–	Filled	PE, Steel Wire Messenger, Figure 8	250	Aerial-Outdoor	A-DSF(L)2YT	16.49
GALD	12-72 Fibers	–	Filled	PE, Steel Wire Messenger, Figure 8	250	Aerial-Outdoor	A-DSF(L)2YT	16.49
GAAD	12-72 Fibers	–	Filled	PE, Dielectric Messenger, Figure 8	250	Aerial-Outdoor	A-DF(ZN)2YT	16.50
GCA	4-432 Fibers	–	Dry	LSZH	250	In/Outdoor	A/I-DQ(ZN)H	16.51
GEA	4-432 Fibers	–	Filled	LSZH	250	In/Outdoor	A/I-DF(ZN)H	16.52
GCR	4-432 Fibers	–	Dry	LSZH, Improved Rodent Protection	250	In/Outdoor	A/I-DQ(ZN)BH	16.53
GER	4-432 Fibers	–	Filled	LSZH, Improved Rodent Protection	250	In/Outdoor	A/I-DF(ZN)BH	16.54
GCD	4-432 Fibers	–	Dry	LSZH, Full Rodent Protection, Armored (CST)	250	In/Outdoor	A/I-DQ(ZN)H(SR)H	16.55
GED	4-432 Fibers	–	Filled	LSZH, Full Rodent Protection, Armored (CST)	250	In/Outdoor	A/I-DF(ZN)H(SR)H	16.56
GCW	4-432 Fibers	–	Dry	LSZH, Full Rodent Protection, Armored (SWA)	250	In/Outdoor	A/I-DQHBH (R1.0vzk)	16.57
GEW	4-432 Fibers	–	Filled	LSZH, Full Rodent Protection, Armored (SWA)	250	In/Outdoor	A/I-DFHBH (R1.0vzk)	16.58

Introduction Cables

Color Codes

Interconnect Cables

Fiber No.	Color (Sec. Coating)
SM 9/125	Yellow
MM 50/125	Green
MM 62.5/125	Blue

Breakout Cables

Fiber No.	Color (Sub-unit Jacket)
1-24 (MM)	Orange
1-24 (SM)	Yellow

Mini-Breakout Cables

Fiber No.	Color (Sec. Coating)
1	White
2	Red
3	Blue
4	Yellow
5	Green
6	Violet
7	Brown
8	Black
9	Orange
10	Turquoise
11	Pink
12	Grey

Fiber No.	Color (Prim. Coating*)
13	White
14	Red
15	Blue
16	Yellow
17	Green
18	Violet
19	Brown
20	Black
21	Orange
22	Turquoise
23	Pink
24	Grey

* secondary coating is transparent

Central Loose Tube Cables*

Fiber No.	Color
1	Red
2	Green
3	Blue
4	Yellow
5	White
6	Grey
7	Brown
8	Violet
9	Turquoise
10	Black
11	Orange
12	Pink

Fiber No.	Color
13	Red/Black
14	Green/Black
15	Blue/Black
16	Yellow/Black
17	White/Black
18	Grey/Black
19	Brown/Black
20	Violet/Black
21	Turquoise/Black
22	Natural/Black
23	Orange/Black
24	Pink/Black

* fiber color code according to IEC 60304; different color coding available on request

Multi Loose Tube Cables*

Fiber No.	Color
1	Red
2	Green
3	Blue
4	Yellow
5	White
6	Grey
7	Brown
8	Violet
9	Turquoise
10	Black
11	Orange
12	Pink

Fiber No.	Color
13	Red/Black
14	Green/Black
15	Blue/Black
16	Yellow/Black
17	White/Black
18	Grey/Black
19	Brown/Black
20	Violet/Black
21	Turquoise/Black
22	Natural/Black
23	Orange/Black
24	Pink/Black

* fiber color code according to IEC 60304; different color coding available on request

Color Code Tubes

Tube No.	Color
1	Red
2	Green
Rest	White

Introduction Cables

Cable Selection Guide Plenum

Optical Fiber Selection

Type	Grade	Fiber Size (μ)	Standards Compliance	Link Length (m)	Data Rate (Gb)
Multimode	6	50/125	exceeds TIA/EIA-568-B.3-1 ISO 11801 OM3	500	10
	5	50/125	TIA/EIA-568-B.3-1 ISO 11801 OM3	300	10
	4	50/125	TIA/EIA-568-B.3	600	1
	3	62.5/125	TIA/EIA-568-B.3	1000	1
	2	62.5/125	TIA/EIA-568-B.3	550	1
	1*	62.5/125	FDDI grade †	-	-
Single-mode	-	-	ITU G.652.c/d ††	-	-

* Grade 1 fibers are available upon request.

† Used in most current cable plants, but not recommended for future installations, except as patch cordage.

†† Low water peak fiber with advantages for CWDM applications.

Color Code Charts

Jacket Color Chart

Cable Type	Jacket Color
Loose Tube & Outside Plant Cables	Black
Industrial Tray Cables	Orange
Tight-Buffered Cables	
Grades 2, 3, 4	Orange
Grades 5, 6	Aqua
Single-mode	Yellow

Nonstandard jacket colors are available upon request.

Fiber Sub-Unit Color Code Chart*

Fiber/Tube No.	Color	Fiber/Tube No.	Color
1	Blue	7	Red
2	Orange	8	Black
3	Green	9	Yellow
4	Brown	10	Violet
5	Slate	11	Rose
6	White	12	Aqua

* Per EIA/TIA 598-A

Optical Specifications

Grade:	2	3	4	5	6	Single-Mode Enhanced ⁶
Glass Type:	62.5/125 μ	62.5/125 μ	50/125 μ	50/125 μ	50/125μ	
Operating Wavelength (nm)	850/1300	850/1300	850/1300	850/1300	850/1300	1310/1550
Min. OFL ¹ Bandwidth (MHz-km)	200/500	200/500	500/500	1500/500	3000/500	-
Min. Laser ² Bandwidth (MHz-km)	220/500	385/500	510/500	2000/500	4000/500	-
Max. Attenuation Loose Tube (dB/km)	3.25/1.0	3.25/1.0	3.0/1.0	3.0/1.0	3.0/1.0	0.40/0.30
Max. Attenuation Tight-Buffered ³ (dB/km)	3.50/1.25	3.50/1.25	3.50/1.25	3.50/1.25	3.50/1.25	0.80/0.50
100 Mb Fast Ethernet Min. Link Length (meters S/L ⁴)	300/2000	300/2000	300/2000	300/2000	300/2000	-/5000
1 Gb Ethernet Min. Link Length (meters S/L ⁴)	300/550	500/1000	600/600	1000 ⁵ /600	1000 ⁵ /600	-/5000
10 Gb Ethernet Min. Link Length (meters S/L ⁴)	35/300	35/300	85/300	300/300	500/300	-/10000

¹ OFL = Overfilled launch

² Effective modal bandwidth, determined by RML or DMD performance specifications

³ Max. attenuation for tight-buffered, ribbon, micro-loose tube and loose tube plenum cables

⁴ S/L = Short wavelength (850 nm)/Long wavelength (1310 nm)

⁵ > 2000 meters for engineered links

⁶ Low water peak single-mode suitable for CWDM use complies with ITU G.652.c/d

Availability

Many of these are available off the shelf from distributors. If you have a new or unusual application or you cannot find a fiber cable in this catalog section that meets your technical requirements contact technical support at +31-77-3875-414 or techsupport.venlo@belden.com.

Interconnect Cables

Indoor

De- scription	Part No.	No. of Fibers	Standard Lengths		Standard Unit Weight		Fiber Size µm	Nom. Buffer/ Tube OD		Strength Members	Nominal OD		Central Element mm	Pulling Tension N	Crush Re- sistance kN/m	Energy kJ/m	Bending radii cable (mm)	
			ft.	m	lbs.	kg		inch	mm		inch	mm					static	dyna- mic

GIOK • Pigtailed • Semi-Tight Buffer • Excellent Strippability • I-K

Dry Construction • Halogen-Free Jacket (Blue, Green, Green with Black Rings or Yellow)																		
-30/70°C	IEC 60332-2		6888	2100	3.1	1.4	Ø 245 ± 10			-			no	3	4	19		



GIOK101	1	62.5/125 OM1 in Blue										0.04	0.9	25	35
GIOK201	1	50/125 OM2 in Green										0.04	0.9	25	35
GIOK301	1	50/125 OM3 in Green with Black rings										0.04	0.9	25	35
GIOK401	1	50/125 OM2e in Green										0.04	0.9	25	35
GIOK901	1	9/125 OS1 in Yellow										0.04	0.9	25	35

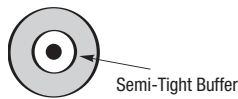

Strippability secondary coating = 100 cm

GIPS • Simplex • Semi-Tight Buffer • Excellent Strippability • I-W(ZN)H

Jelly-Filled Construction • Orange FRNC/LSNH Jacket																		
-5/55°C	IEC 60332-1		6888	2100	32.9	14.9	Ø 245 ± 10			Reinforced Aramid Yarn			no	200	10	128		



GIPSxA1																			0.06	1.6	24	32
GIPSxB1																			0.07	1.8	27	36
GIPSxC1																			0.08	2.0	30	40
GIPSxD1																			0.09	2.4	36	48
GIPSxE1																			0.11	2.8	42	56
GIPSxF1																			0.12	3.0	45	60

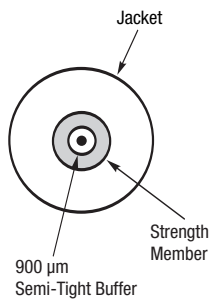

Strippability secondary coating = 100 cm
Color Code: see chart page 16.23

Optical characteristics see page 16.21.

Interconnect Cables

Indoor

De- scription	Part No.	No. of Fibers	Standard Lengths		Standard Unit Weight		Fiber Size µm	Nom. Buffer/ Tube OD		Strength Members	Nominal OD		Central Element mm	Pulling Tension N	Crush Re- sistance kN/m	Energy kJ/m	Bending Radii Cable (mm)	
			ft.	m	lbs.	kg		inch	mm		inch	mm					static	dyna- mic

GIPS • Duplex • Figure 8 • Semi-Tight Buffer • Excellent Strippability • I-W(ZN)H

Jelly-Filled Construction • Orange FRNC/LSNH Jacket																			
-5/55°C	IEC 60332-1		6888	2100	65.3	29.6	∅ 245 ± 10		Reinforced Aramid Yarn		no	400	20	256					

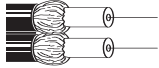

GIPSxA2											0.13	3.3					33	50
GIPSxB2											0.15	3.7					37	56
GIPSxC2											0.16	4.1					41	62
GIPSxD2											0.19	4.9					49	74
GIPSxE2											0.22	5.7					57	86
GIPSxF2											0.24	6.1					61	92

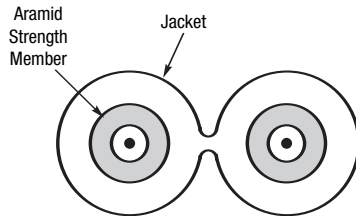

Strippability secondary coating = 100 cm
Color Code: see chart page 16.23

GIPK • Heavy Duplex • Semi-Tight Buffer • Excellent Strippability • I-K(ZN)HH

Dry Construction • Orange FRNC/LSNH Jacket																			
-5/55°C	IEC 60332-1		6888	2100	115.3	52.3	∅ 245 ± 10		Reinforced Aramid Yarn		no	400	20	256					

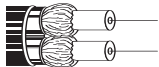

GIPKxA2											0.17	4.3					43	65
GIPKxB2											0.19	4.7					47	71
GIPKxC2											0.20	5.1					51	77
GIPKxD2											0.23	5.9					59	89
GIPKxE2											0.26	6.7					67	101
GIPKxF2											0.28	7.1					71	107

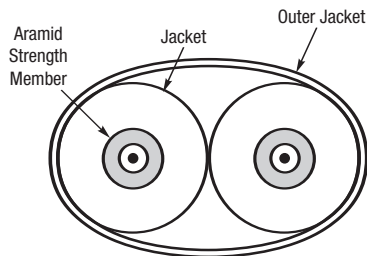

Strippability secondary coating = 100 cm
Color Code: see chart page 16.23

Optical characteristics see page 16.21.

Interconnect Cables

Indoor

De- scription	Part No.	No. of Fibers	Standard Lengths		Standard Unit Weight		Fiber Size μm	Nom. Buffer/ Tube OD		Strength Members	Nominal OD		Central Element mm	Pulling Tension N	Crush Re- sistance kN/m	Energy kJ/m	Bending Radii Cable (mm)	
			ft.	m	lbs.	kg		inch	mm		inch	mm					static	dyna- mic

GIPT • Mini-Zip • Figure 8 • Tight Buffer • I-V(ZN)H

Dry Construction • Orange FRNC/LSNH Jacket																		
-30/70°C	IEC 60332-1		6888	2100	26.4	12.0	Ø 280 ± 15			Reinforced Aramid Yarn			no	400	20	19		

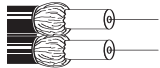

GIPTxA2											0.13	3.4					34	51
GIPTxB2											0.15	3.9					39	58

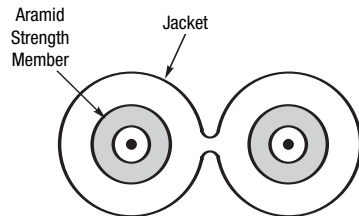

Color Code: see chart page 16.23

Optical characteristics see page 16.21.

Breakout Cables

Indoor

De- scription	Part No.	No. of Fibers	Standard Lengths		Standard Unit Weight		Fiber Size µm	Nom. Buffer/ Tube OD		Strength Members	Nominal OD		Central Element mm	Pulling Tension N	Crush Re- sistance kN/m	Energy kJ/m	Bending Radii Cable (mm)	
			ft.	m	lbs.	kg		inch	mm		inch	mm					static	dyna- mic

GIBT • Tight Buffer • With Rip Cord • I-V(ZN)HH

Dry Construction • Orange FRNC/LSNH Jacket																		
-5/55°C	IEC 60332-1		6888	2100			Ø 280 ± 15			Reinforced Aramid Yarn	0.08	2.1	Filler					



GIBT x02	2		115.7	52.5					2 + 2 BE	0.21	5.3		400	7.5	379	53	80
GIBT x04	4		143.5	65.1					CE + 4	0.24	6.2		400	7.5	507	62	93
GIBT x06	6		273.1	123.9					CE + 6	0.31	8.0		600	7.5	928	80	120
GIBT x08	8		356.5	161.7					CE + 8	0.37	9.4		800	7.5	1235	94	141
GIBT x12	12		402.8	182.7					3 + 9	0.41	10.5		1200	7.5	1424	105	158
GIBT x24	24		810.2	367.5					2 + 8 + 14	0.56	14.3		2400	7.5	2677	143	215

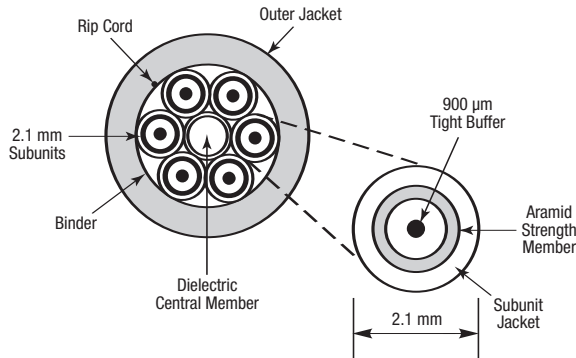

Color Code: see chart page 16.23

GIBK • Semi-Tight Buffer • With Rip Cord • Excellent Strippability • I-K(ZN)HH

Dry Construction • Orange FRNC/LSNH Jacket																		
-5/55°C	IEC 60332-1		6888	2100	115.3	52.3	Ø 245 ± 10			Reinforced Aramid Yarn	0.10	2.5	Filler					



GIBK x02	2		120.4	54.6					Flat		6.30 x 3.8		400	7.5	382	-	-
GIBK x04	4		185.2	84.0					CE + 4	0.28	7.2		400	7.5	607	72	108
GIBK x06	6		338.0	153.3					CE + 6	0.37	9.4		600	7.5	1124	94	141
GIBK x08	8		430.6	195.3					CE + 8	0.43	10.9		800	7.5	1450	109	164
GIBK x12	12		513.9	233.1					3 + 9	0.46	11.8		1200	7.5	1675	118	177

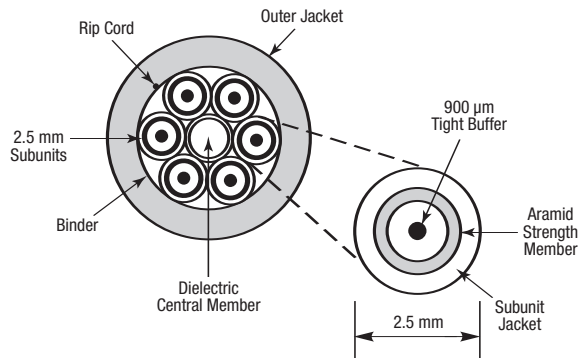

Color Code: see chart page 16.23

Optical characteristics see page 16.21.

Mini-Breakout Cables (Distribution)

Indoor

De- scription	Part No.	No. of Fibers	Standard Lengths		Standard Unit Weight		Fiber Size µm	Nom. Buffer/ Tube OD		Strength Members	Nominal OD		Central Element mm	Pulling Tension N	Crush Re- sistance kN/m	Energy kJ/m	Bending Radii Cable (mm)	
			ft.	m	lbs.	kg		inch	mm		inch	mm					static	dyna- mic

GIMT • Tight Buffer • I-V(ZN)H

Dry Construction • Orange FRNC /LSNH Jacket

-5/55°C	IEC 60332-2	6888	2100			Ø 280 ± 15			Reinforced Aramid Yarn		no				4			
---------	-------------	------	------	--	--	------------	--	--	---------------------------	--	----	--	--	--	---	--	--	--

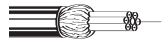

GIMT x02	2			74.1	33.5						0.16	4.0		400		227	40	60
GIMT x04	4			88.0	39.9						0.19	4.8		400		294	48	72
GIMT x06	6			106.5	48.3						0.21	5.3		450		339	53	80
GIMT x08	8			115.7	52.5						0.21	5.3		450		351	53	80
GIMT x12	12			185.2	84.0						0.28	7.0		500		619	70	105
GIMT x16	16			226.9	102.9						0.31	8.0		500		886	80	120
GIMT x24	24			263.9	119.7						0.35	9.0		600		1044	90	135

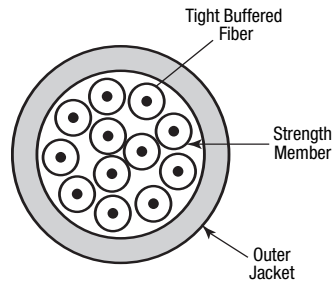

Available in multimode only.
Color Code: see chart page 16.23

GIMK • Semi-Tight Buffer • I-K(ZN)H

Dry Construction • Orange FRNC /LSNH Jacket

-5/55°C	IEC 60332-2	6888	2100			Ø 245 ± 10			Reinforced Aramid Yarn		no				4			
---------	-------------	------	------	--	--	------------	--	--	---------------------------	--	----	--	--	--	---	--	--	--



GIMK x02	2			88.0	39.9						0.16	4.0		400		235	40	60
GIMK x04	4			92.6	42.0						0.19	4.8		400		310	48	72
GIMK x06	6			106.5	48.3						0.21	5.3		450		339	53	80
GIMK x08	8			120.4	54.6						0.21	5.3		450		381	53	80

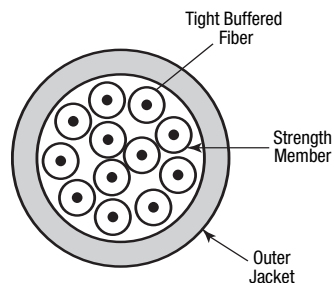

Available in multimode only.
Color Code: see chart page 16.23

Optical characteristics see page 16.21.



Mini-Breakout Cables (Distribution)

Universal – Indoor/Outdoor, Standard Rodent Protection

De- scription	Part No.	No. of Fibers	Standard Lengths		Standard Unit Weight		Fiber Size µm	Nom. Buffer/ Tube OD		Strength Members	Nominal OD		Central Element mm	Pulling Tension N	Crush Re- sistance kN/m	Energy kJ/m	Bending Radii Cable (mm)	
			ft.	m	lbs.	kg		inch	mm		inch	mm					static	dyna- mic

GUMT • Tight Buffer • A/I-VQ(ZN)H

Dry Construction • Orange FRNC/LSNH Jacket

-30/70°C	IEC 60332-2	6888	2100			∅ 280 ± 15				Longitudinal watertightness Swellable Glass Yarn (6)			no		4			
----------	-------------	------	------	--	--	------------	--	--	--	---	--	--	----	--	---	--	--	--

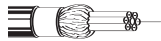

GUMTx04	4			120.4	54.6						0.21	5.4		400		296	54	81
GUMTx06	6			138.0	63.0						0.23	5.9		450		347	59	89
GUMTx08	8			148.1	67.2						0.23	5.9		450		371	59	89
GUMTx12	12			208.3	94.5						0.30	7.6		500		622	76	114
GUMTx16	16			245.4	111.3						0.34	8.6		500		845	86	129
GUMTx24	24			300.9	136.5						0.38	9.6		600		1082	96	144

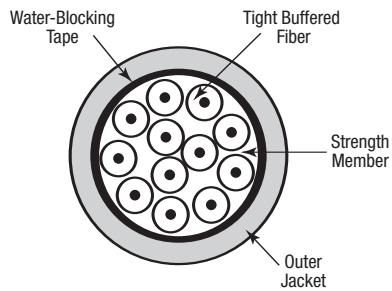

Color Code: see chart page 16.23

Optical characteristics see page 16.21.

Mini-Breakout Cables (Distribution)

Universal – Indoor/Outdoor, Improved Rodent Protection

De- scription	Part No.	No. of Fibers	Standard Lengths		Standard Unit Weight		Fiber Size µm	Nom. Buffer/ Tube OD		Strength Members	Nominal OD		Central Element mm	Pulling Tension N	Crush Re- sistance kN/m	Energy kJ/m	Bending Radii Cable (mm)	
			ft.	m	lbs.	kg		inch	mm		inch	mm					static	dyna- mic

GUXT • Tight Buffer • A/I-VQ(ZN)BH

Dry Construction • Orange FRNC/LSNH Jacket

-30/70°C IEC 60332-2	6888	2100			Ø 280 ± 15					Longitudinal watertightness Swellable Glass Yarn			no		4			
----------------------	------	------	--	--	------------	--	--	--	--	---	--	--	----	--	---	--	--	--

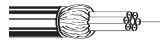

GUXTx04	4		203.7	92.4					0.28	7.0			2000		375	70	105
GUXTx06	6		236.1	107.1					0.29	7.3			2000		445	73	110
GUXTx08	8		259.3	117.6					0.29	7.3			2000		472	73	110
GUXTx12	12		351.9	159.6					0.37	9.4			3000		801	94	141
GUXTx24	24		560.2	254.1					0.42	10.6			4000		1243	106	159

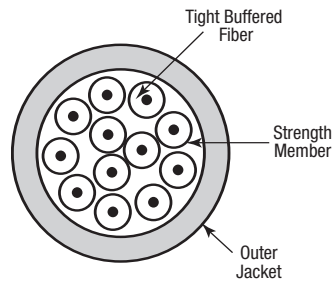

Color Code: see chart page 16.23

Optical characteristics see page 16.21.

Mini-Breakout Cables (Distribution)

Special – Indoor/Outdoor

De- scription	Part No.	No. of Fibers	Standard Lengths		Standard Unit Weight		Fiber Size µm	Nom. Buffer/ Tube OD		Strength Members	Nominal OD		Central Element mm	Pulling Tension N	Crush Re- sistance kN/m	Energy kJ/m	Bending Radii Cable (mm)	
			ft.	m	lbs.	kg		inch	mm		inch	mm					static	dyna- mic

GMMT • Intex Mobile • Tight Buffer • Designed for Despooling and Respooling • A/I-VQ(ZN)11Y

Dry Construction • PUR Jacket (Orange or Black)

-30/70°C	IEC 60332-1	6888	2100			∅ 280 ± 15				Longitudinal watertightness Swellable Glass Yarn				no				
----------	-------------	------	------	--	--	------------	--	--	--	---	--	--	--	----	--	--	--	--

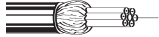

GMMTx04	4			143.5	65.1						0.23	5.8		800	4	580	58	87
GMMTx06	6			175.9	79.8						0.25	6.3		950	4	725	63	95
GMMTx08	8			217.6	98.7						0.28	7.0		1100	4	890	70	105

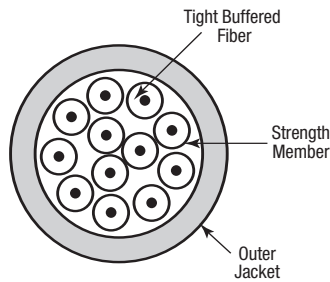

Color Code: see chart page 16.23

Optical characteristics see page 16.21.

Breakout Kit Cables

Universal – Indoor/Outdoor

De- scription	Part No.	No. of Fibers	Standard Lengths		Standard Unit Weight		Fiber Size µm	Nom. Buffer/ Tube OD		Strength Members	Nominal OD		Central Element mm	Pulling Tension N	Crush Re- sistance kN/m	Energy kJ/m	Bending radii cable (mm)	
			ft.	m	lbs.	kg		inch	mm		inch	mm					static	dyna- mic

GIPS • Simplex • With Furcation Tube (no Fiber)

Dry Construction • Orange PUR Jacket

-5/55°C	IEC 60332-2	6888	2100	42.5	19.3					Reinforced Aramid Yarn	0.11	2.8	no	110	-	128	28	42
---------	-------------	------	------	------	------	--	--	--	--	---------------------------	------	-----	----	-----	---	-----	----	----

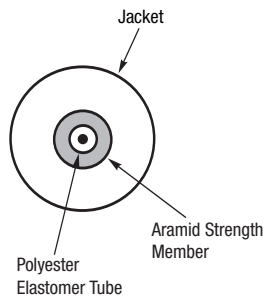

Color Code: see chart page 16.23

Central Loose Tube Cables

Outdoor – Standard Rodent Protection

De- scription	Part No.	No. of Fibers	Standard Lengths		Standard Unit Weight		Fiber Size μm	Nom. Buffer/ Tube OD		Strength Members	Nominal OD		Central Element mm	Pulling Tension N	Crush Re- sistance kN/m	Energy kJ/m	Bending Radii Cable (mm)	
			ft.	m	lbs.	kg		inch	mm		inch	mm					static	dyna- mic

GOSA • Loose Tube (Jelly-Filled, Non-Dripping and Silicone-Free) • Longitudinal Watertightness • **A-DQ(ZN)2Y**

Dry Construction • Black PE (UV-resistant) Jacket																		
-30/70°C			13448	4100	334.4	151.7	∅ 250 ± 15	0.13	3.2	Longitudinal watertightness Swellable Glass Yarn (6)	0.23	5.8	no	700	10	-	58	87



- GOSAx02 2
- GOSAx04 4
- GOSAx06 6
- GOSAx08 8
- GOSAx12 12

Color Code: see chart page 16.23

GOSB • Loose Tube (Jelly-Filled, Non-Dripping and Silicone-Free) • Longitudinal Watertightness • **A-DQ(ZN)2Y**

Dry Construction • Black PE (UV-resistant) Jacket																		
-30/70°C			6888	2100	305.6	138.6	∅ 250 ± 15	0.17	4.2	Longitudinal watertightness Swellable Glass Yarn (6)	0.34	8.7	no	1400	15	-	87	131



- GOSBx02 2
- GOSBx04 4
- GOSBx06 6
- GOSBx08 8
- GOSBx12 12
- GOSBx16 16
- GOSBx24 24

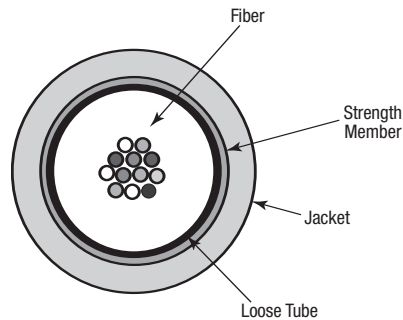

Color Code: see chart page 16.23

Optical characteristics see page 16.21.

Central Loose Tube Cables

Outdoor – Improved Rodent Protection

De- scription	Part No.	No. of Fibers	Standard Lengths		Standard Unit Weight		Fiber Size µm	Nom. Buffer/ Tube OD		Strength Members	Nominal OD		Central Element mm	Pulling Tension N	Crush Re- sistance kN/m	Energy kJ/m	Bending Radii Cable (mm)	
			ft.	m	lbs.	kg		inch	mm		inch	mm					static	dyna- mic

GORA • Loose Tube (Jelly-Filled, Non-Dripping and Silicone-Free) • Longitudinal Watertightness • A-DQ(ZN)B2Y

Dry Construction • Black PE (UV-resistant) Jacket																		
-30/70°C			13448	4100	497.1	225.5	∅ 250 ± 15	0.13	3.2	Longitudinal watertightness Swellable Glass Yarn (14)	0.28	7.1	no	1400	10	755	71	107



- GORAx02 2
- GORAx04 4
- GORAx06 6
- GORAx08 8
- GORAx12 12

Color Code: see chart page 16.23

GORB • Loose Tube (Jelly-Filled, Non-Dripping and Silicone-Free) • Longitudinal Watertightness • A-DQ(ZN)B2Y

Dry Construction • Black PE (UV-resistant) Jacket																		
-30/70°C			6888	2100	444.4	201.6	∅ 250 ± 15	0.17	4.2	Longitudinal watertightness Swellable Glass Yarn (14)	0.40	10.2	no	4000	15	2200	102	153



- GORBx02 2
- GORBx04 4
- GORBx06 6
- GORBx08 8
- GORBx12 12
- GORBx16 16
- GORBx24 24

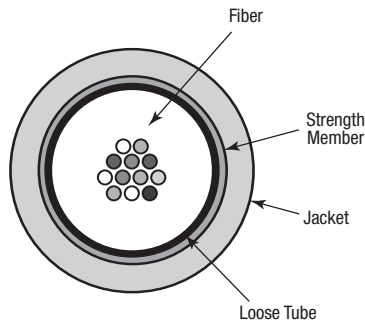

Color Code: see chart page 16.23

Optical characteristics see page 16.21.

Central Loose Tube Cables

Outdoor – Fiber Reinforced Plastic Armor (FRP), Full Rodent Protection

De- scription	Part No.	No. of Fibers	Standard Lengths		Standard Unit Weight		Fiber Size µm	Nom. Buffer/ Tube OD		Strength Members	Nominal OD		Central Element mm	Pulling Tension N	Crush Re- sistance kN/m	Energy kJ/m	Bending Radii Cable (mm)	
			ft.	m	lbs.	kg		inch	mm		inch	mm					static	dyna- mic

GOFB • Loose Tube (Jelly-Filled, Non-Dripping and Silicone-Free) • Water-Blocked • FRP • **A-DQB2Y (FRP1.0)**

Dry Construction • Single Black PE Jacket																		
-30/70°C			6888	2100	352.7	160.0	Ø 250 ± 15	0.16	4.0	FRP Rods	0.354	9.0	no	4000	40	-	90	180

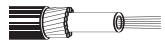

- GOFBx02 2
- GOFBx04 4
- GOFBx06 6
- GOFBx08 8
- GOFBx12 12
- GOFBx16 16
- GOFBx24 24

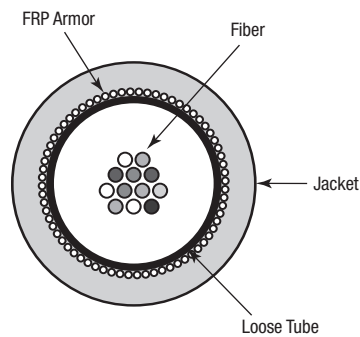

Color Code: see chart page 16.23

Outdoor – Steel Wire Armor (SWA), Full Rodent Protection

De- scription	Part No.	No. of Fibers	Standard Lengths		Standard Unit Weight		Fiber Size µm	Nom. Buffer/ Tube OD		Strength Members	Nominal OD		Central Element mm	Pulling Tension N	Crush Re- sistance kN/m	Energy kJ/m	Bending radii cable (mm)	
			ft.	m	lbs.	kg		inch	mm		inch	mm					static	dyna- mic

GOWB • Loose Tube (Jelly-Filled, Non-Dripping and Silicone-Free) • Longitudinal Watertightness • SWA • **A-DQ(ZN)2YB2Y (R0.63vzk)**

Dry Construction • Double Black PE Jacket																		
-30/70°C			6888	2100	1029.7	467.0	Ø 250 ± 15	0.16	4.0	Longitudinal watertightness Swellable Glass Yarn	0.512	13.0	no	6500	50	-	130	260

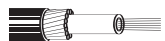

- GOWBx02 2
- GOWBx04 4
- GOWBx06 6
- GOWBx08 8
- GOWBx12 12
- GOWBx16 16
- GOWBx24 24

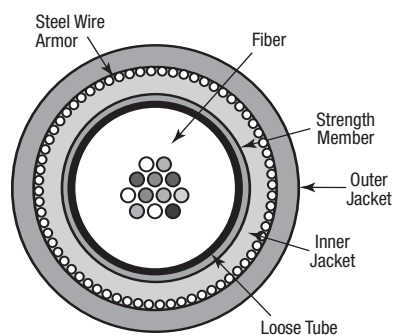

Color Code: see chart page 16.23

Optical characteristics see page 16.21.

Central Loose Tube Cables

Outdoor – Corrugated Steel Tape Armor (CST), Full Rodent Protection

De- scription	Part No.	No. of Fibers	Standard Lengths		Standard Unit Weight		Fiber Size µm	Nom. Buffer/ Tube OD		Strength Members	Nominal OD		Central Element mm	Pulling Tension N	Crush Re- sistance kN/m	Energy kJ/m	Bending Radii Cable (mm)	
			ft.	m	lbs.	kg		inch	mm		inch	mm					static	dyna- mic

GOCB • Loose Tube (Jelly-Filled, Non-Dripping and Silicone-Free) • Longitudinal Watertightness • CST • A-DQ(ZN)(SR)2Y

Dry Construction • Single Black PE Jacket																		
-30/70°C			6888	2100	518.5	235.2	∅ 250 ± 15	0.16	4.0	Longitudinal watertightness Swellable Glass Yarn	0.42	10.6	no	2000	40	-	106	212



- GOCBx02 2
- GOCBx04 4
- GOCBx06 6
- GOCBx08 8
- GOCBx12 12
- GOCBx16 16
- GOCBx24 24

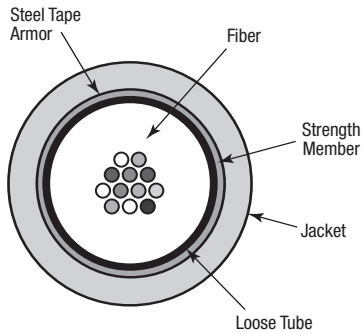

Color Code: see chart page 16.23

GOD • Loose Tube (Jelly-Filled, Non-Dripping and Silicone-Free) • Longitudinal Watertightness • CST • A-DQ(ZN)2Y(SR)2Y

Dry Construction • Double Black PE Jacket																		
-30/70°C			6888	2100			∅ 250 ± 15			Longitudinal watertightness Swellable Glass Yarn								

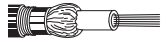

- GODAx02 2
- GODAx04 4
- GODAx06 6
- GODAx08 8
- GODAx12 12
- GODBx16 16
- GODBx24 24

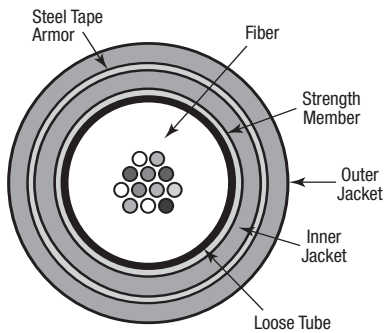

Color Code: see chart page 16.23

Optical characteristics see page 16.21.

Central Loose Tube Cables

Universal – Indoor/Outdoor, Standard Rodent Protection

De- scription	Part No.	No. of Fibers	Standard Lengths		Standard Unit Weight		Fiber Size μm	Nom. Buffer/ Tube OD		Strength Members	Nominal OD		Central Element mm	Pulling Tension N	Crush Re- sistance kN/m	Energy kJ/m	Bending Radii Cable (mm)	
			ft.	m	lbs.	kg		inch	mm		inch	mm					static	dyna- mic

GUSA • Loose Tube (Jelly-Filled, Non-Dripping and Silicone-Free) • Longitudinal Watertightness • A/I-DQ(ZN)H

Dry Construction • Orange FRNC/LSNH Jacket																		
-30/70°C	IEC 60332-3C		13448	4100	334.4	151.7	Ø 250 ± 15	0.13	3.2	Longitudinal watertightness Swellable Glass Yarn (6)	0.23	5.8	no	700	10	550	58	87



- GUSAx02 2
- GUSAx04 4
- GUSAx06 6
- GUSAx08 8
- GUSAx12 12

Color Code: see chart page 16.23

GUSB • Loose Tube (Jelly-Filled, Non-Dripping and Silicone-Free) • Longitudinal Watertightness • A/I-DQ(ZN)H

Dry Construction • Orange FRNC/LSNH Jacket																		
-30/70°C	IEC 60332-3C		6888	2100	333.3	151.2	Ø 250 ± 15	0.17	4.2	Longitudinal watertightness Swellable Glass Yarn (6)	0.34	8.7	no	1400	15	1370	87	131



- GUSBx02 2
- GUSBx04 4
- GUSBx06 6
- GUSBx08 8
- GUSBx12 12
- GUSBx16 16
- GUSBx24 24

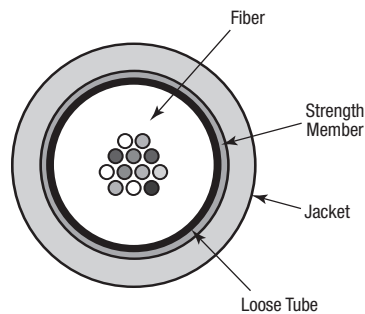

Color Code: see chart page 16.23

Optical characteristics see page 16.21.

Central Loose Tube Cables

Universal – Indoor/Outdoor, Improved Rodent Protection

De- scription	Part No.	No. of Fibers	Standard Lengths		Standard Unit Weight		Fiber Size µm	Nom. Buffer/ Tube OD		Strength Members	Nominal OD		Central Element mm	Pulling Tension N	Crush Re- sistance kN/m	Energy kJ/m	Bending Radii Cable (mm)	
			ft.	m	lbs.	kg		inch	mm		inch	mm					static	dyna- mic

GURA • Loose Tube (Jelly-Filled, Non-Dripping and Silicone-Free) • Longitudinal Watertightness • **A/I-DQ(ZN)BH**

Dry Construction • Orange FRNC/LSNH Jacket																		
-30/70°C	IEC 60332-3C		13448	4100	497.1	225.5	Ø 250 ± 15	0.13	3.2	Longitudinal watertightness Swellable Glass Yarn (14)	0.28	7.1	no	1400	10	755	71	107



- GURAx02 2
- GURAx04 4
- GURAx06 6
- GURAx08 8
- GURAx12 12

Color Code: see chart page 16.23

GURB • Loose Tube (Jelly-Filled, Non-Dripping and Silicone-Free) • Longitudinal Watertightness • **A/I-DQ(ZN)BH**

Dry Construction • Orange FRNC/LSNH Jacket																		
-30/70°C	IEC 60332-3C		6888	2100	481.5	218.4	Ø 250 ± 15	0.17	4.2	Longitudinal watertightness Swellable Glass Yarn (14)	0.40	10.2	no	4000	15	1680	102	153



- GURBx04 4
- GURBx06 6
- GURBx08 8
- GURBx12 12
- GURBx16 16
- GURBx24 24

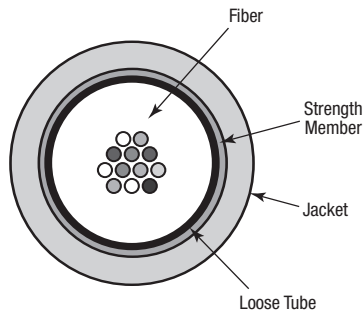

Color Code: see chart page 16.23

Optical characteristics see page 16.21.

Central Loose Tube Cables

Universal – Indoor/Outdoor, Corrugated Steel Tape Armor (CST), Full Rodent Protection

De- scription	Part No.	No. of Fibers	Standard Lengths		Standard Unit Weight		Fiber Size µm	Nom. Buffer/ Tube OD		Strength Members	Nominal OD		Central Element mm	Pulling Tension N	Crush Re- sistance kN/m	Energy kJ/m	Bending radii cable (mm)	
			ft.	m	lbs.	kg		inch	mm		inch	mm					static	dyna- mic

GUCB • Loose Tube (Jelly-Filled, Non-Dripping and Silicone-Free) • Longitudinal Watertightness • CST • **A/I-DQ(ZN)(SR)H**

Dry Construction • Single Black FRNC/LSNH Jacket																		
-30/70°C	EN 50266-2-2 EN 50267-2-2 EN 50268-2, EN 60331-25		6888	2100	685.2	310.8	∅ 250 ± 15	0.16	4.0	Longitudinal watertightness Swellable Glass Yarn	0.42	10.6	no	2000	40	-	106	212



- GUCBx02 2
- GUCBx04 4
- GUCBx06 6
- GUCBx08 8
- GUCBx12 12
- GUCBx16 16
- GUCBx24 24

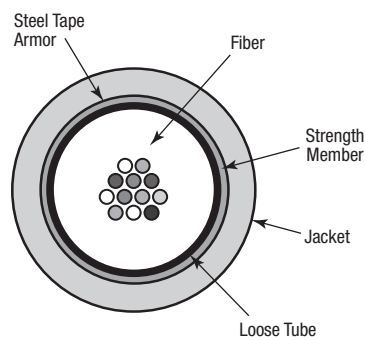

Color Code: see chart page 16.23

GUD • Loose Tube (Jelly-Filled, Non-Dripping and Silicone-Free) • Longitudinal Watertightness • CST • **A/I-DQ(ZN)H(SR)H**

Dry Construction • Double Black FRNC/LSNH Jacket																		
-30/70°C	EN 50266-2-2 EN 50267-2-2 EN 50268-2		6888	2100			∅ 250 ± 15			Longitudinal watertightness Swellable Glass Yarn								



- GUDAx02 2
- GUDAx04 4
- GUDAx06 6
- GUDAx08 8
- GUDAx10 10
- GUDAx12 12
- GUDBx16 16
- GUDBx24 24

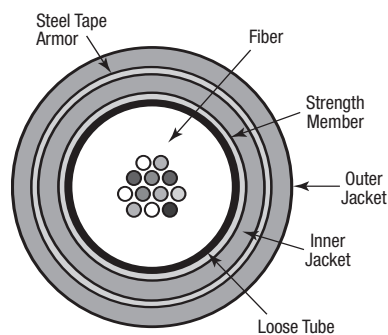

Color Code: see chart page 16.23

Optical characteristics see page 16.21.



Central Loose Tube Cables

Universal – Indoor/Outdoor, Steel Wire Armor (SWA), Full Rodent Protection

De- scription	Part No.	No. of Fibers	Standard Lengths		Standard Unit Weight		Fiber Size µm	Nom. Buffer/ Tube OD		Strength Members	Nominal OD		Central Element mm	Pulling Tension N	Crush Re- sistance kN/m	Energy kJ/m	Bending Radii Cable (mm)	
			ft.	m	lbs.	kg		inch	mm		inch	mm					static	dyna- mic

GUWB • Loose Tube (Jelly-Filled, Non-Dripping and Silicone-Free) • Longitudinal Watertightness • SWA • A/I-DQ(ZN)HBH (R0.63vzk)

Dry Construction • Double Black FRNC/LSNH Jacket

-30/70°C	6888	2100	1263.8	561.0	∅ 250 ± 15	0.16	4.0	Longitudinal watertightness Swellable Glass Yarn	0.51	13.0	no	6500	50	-	130	260
----------	------	------	--------	-------	------------	------	-----	---	------	------	----	------	----	---	-----	-----



- GUWBx02 2
- GUWBx04 4
- GUWBx06 6
- GUWBx08 8
- GUWBx12 12
- GUWBx16 16
- GUWBx24 24

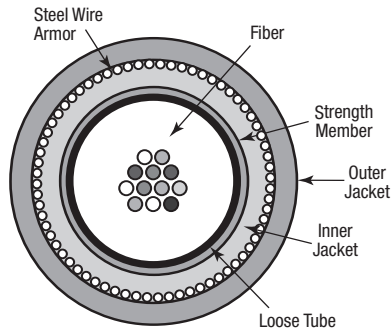

Color Code: see chart page 16.23

Optical characteristics see page 16.21.

Multi Loose Tube Cables

Outdoor

De- scription	Part No.	No. of Fibers	Standard Lengths		Standard Unit Weight		Fiber Size µm	Nom. Buffer/ Tube OD		Strength Members	Nominal OD		Central Element mm	Pulling Tension N	Crush Re- sistance kN/m	Energy kJ/m	Bending Radii Cable (mm)	
			ft.	m	lbs.	kg		inch	mm		inch	mm					static	dyna- mic

GBA • Loose Tubes*/PE Blind Elements are S-Z Stranded Around the Central Element • Water-Blocked • **A-DQ(ZN)2Y**

Dry Construction • Black PE (HDPE) Jacket

-30/70°C



GBAGx04	4 (1x4)	6888	2100	333.3	151.2	Ø 250 ± 15	0.07	1.9	Water-blocking Aramid Yarn	0.41	10.3	2.0	3000	20	-	155	206
GBAGx06	6 (1x6)	13448	4100	650.8	295.2												
GBAGx08	8 (2x4)																
GBAGx12	12 (2x6)																
GBAGx18	18 (3x6)																
GBAGx24	24 (4x6)																
GBAGx30	30 (5x6)																
GBAGx36	36 (6x6)																
GBADx24	24 (2x12)	6888	2100	458.3	207.9	Ø 250 ± 15	0.10	2.5	Water-blocking Aramid Yarn	0.48	12.2	2.7	3500	20	-	183	244
GBADx36	36 (3x12)	13448	4100	894.8	405.9												
GBADx48	48 (4x12)																
GBADx60	60 (5x12)																
GBADx72	72 (6x12)																
GBAEx84	84 (7x12)	6888	2100	588.0	266.7	Ø 250 ± 15	0.10	2.5	Water-blocking Aramid Yarn	0.54	13.8	3.0/4.3	4000	20	-	207	276
GBAEx96	96 (8x12)	13448	4100	1147.9	520.7												
GBAFx08	108 (9x12)	6888	2100	888.9	403.2	Ø 250 ± 15	0.10	2.5	Water-blocking Aramid Yarn	0.67	17.0	3.0/7.5	4000	20	-	255	340
GBAFx20	120 (10x12)	13448	4100	1735.5	787.2												
GBAFx32	132 (11x12)																
GBAFx44	144 (12x12)																
GBAMx16	216 (18x12)	6888	2100	1041.7	472.5	Ø 250 ± 15	0.10	2.5	Water-blocking Aramid Yarn	0.72	18.2	2.7	4000	20	-	273	364
		13448	4100	2033.7	922.5												
GBAlx92	192 (8x24)	6888	2100	1064.8	483.0	Ø 250 ± 15	0.14	3.5	Water-blocking Aramid Yarn	0.71	18.0	3.0/6.0	4000	20	-	270	360
		13448	4100	2078.9	943.0												
GBAJx88	288 (12x24)	6888	2100	1643.5	745.5	Ø 250 ± 15	0.14	3.5	Water-blocking Aramid Yarn	0.88	22.4	3.0/10.5	4000	20	-	336	448
GBALx32	432 (18x24)	6888	2100	1643.5	745.5	Ø 250 ± 15	0.14	3.5	Water-blocking Aramid Yarn	0.91	23.2	2.7/3.7	4000	20	-	348	464

Color Code: see chart page 16.23

Loose tubes: 1. Red, 2. Green, rest of tubes White

Blind elements: Clear

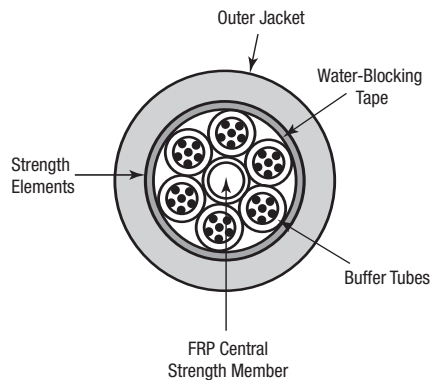

Optical characteristics see page 16.21.
* jelly-filled, non-dripping and silicone-free

Multi Loose Tube Cables

Outdoor

De- scription	Part No.	No. of Fibers	Standard Lengths		Standard Unit Weight		Fiber Size µm	Nom. Buffer/ Tube OD		Strength Members	Nominal OD		Central Element mm	Pulling Tension N	Crush Re- sistance kN/m	Energy kJ/m	Bending Radii Cable (mm)	
			ft.	m	lbs.	kg		inch	mm		inch	mm					static	dyna- mic

GDA • Loose Tubes*/PE Blind Elements are S-Z Stranded Around the Central Element • Water-Blocked • **A-DF(ZN)2Y**

Filled Construction • Black PE (HDPE) Jacket

-30/70°C



GDA Gx04	4 (1x4)	6888	2100	342.6	155.4	∅ 250 ± 15	0.07	1.9	Water-blocking Aramid Yarn	0.39	10.0	2.0	3000	20	-	150	200
GDA Gx06	6 (1x6)	13448	4100	668.9	303.4												
GDA Gx08	8 (2x4)																
GDA Gx12	12 (2x6)																
GDA Gx18	18 (3x6)																
GDA Gx24	24 (4x6)																
GDA Gx30	30 (5x6)																
GDA Gx36	36 (6x6)																
GDA Dx24	24 (2x12)	6888	2100	490.7	222.6	∅ 250 ± 15	0.10	2.5	Water-blocking Aramid Yarn	0.47	12.0	2.7	3500	20	-	180	240
GDA Dx36	36 (3x12)	13448	4100	958.1	434.6												
GDA Dx48	48 (4x12)																
GDA Dx60	60 (5x12)																
GDA Dx72	72 (6x12)																
GDA Ex84	84 (7x12)	6888	2100	629.6	285.6	∅ 250 ± 15	0.10	2.5	Water-blocking Aramid Yarn	0.54	13.6	3.0/4.3	4000	20	-	204	272
GDA Ex96	96 (8x12)	13448	4100	1229.3	557.6												
GDA Fx08	108 (9x12)	6888	2100	949.1	430.5	∅ 250 ± 15	0.10	2.5	Water-blocking Aramid Yarn	0.66	16.8	3.0/7.5	4000	20	-	252	336
GDA Fx20	120 (10x12)	13448	4100	1853.0	840.5												
GDA Fx32	132 (11x12)																
GDA Fx44	144 (12x12)																
GDA Mx16	216 (18x12)	6888 13448	2100 4100	1134.3 2214.5	514.5 1004.5	∅ 250 ± 15	0.10	2.5	Water-blocking Aramid Yarn	0.69	17.5	2.7	4000	20	-	263	350
GDA Ix92	192 (8x24)	6888 13448	2100 4100	1041.7 2033.7	472.5 922.5	∅ 250 ± 15	0.14	3.5	Water-blocking Aramid Yarn	0.69	17.6	3.0/6.0	4000	20	-	264	352
GDA Jx88	288 (12x24)	6888	2100	1736.1	787.5	∅ 250 ± 15	0.14	3.5	Water-blocking Aramid Yarn	0.87	22.1	3.0/10.5	4000	20	-	332	442
GDA Lx32	432 (18x24)	6888	2100	1851.9	840.0	∅ 250 ± 15	0.14	3.5	Water-blocking Aramid Yarn	0.89	22.5	2.7/3.7	4000	20	-	338	450

Color Code: see chart page 16.23

Loose tubes: 1. Red, 2. Green, rest of tubes White

Blind elements: Clear

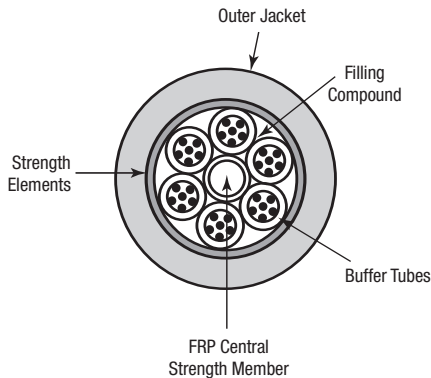

Optical characteristics see page 16.21.

* jelly-filled, non-dripping and silicone-free

Multi Loose Tube Cables

Outdoor – Improved Rodent Protection

De- scription	Part No.	No. of Fibers	Standard Lengths		Standard Unit Weight		Fiber Size µm	Nom. Buffer/ Tube OD		Strength Members	Nominal OD		Central Element mm	Pulling Tension N	Crush Re- sistance kN/m	Energy kJ/m	Bending Radii Cable (mm)	
			ft.	m	lbs.	kg		inch	mm		inch	mm					static	dyna- mic

GBR • Loose Tubes*/PE Blind Elements are S-Z Stranded Around the Central Element • Water-Blocked • A-DQ(ZN)B2Y

Dry Construction • Black PE (HDPE) Jacket

-30/70°C



GBRGx04	4 (1x4)	6888	2100	486.1	220.5	Ø 250 ± 15	0.07	1.9	Water-blocking Glass Yarn	0.46	11.8	2.0	3000	20	-	177	236	
GBRGx06	6 (1x6)	13448	4100	949.1	430.5													
GBRGx08	8 (2x4)																	
GBRGx12	12 (2x6)																	
GBRGx18	18 (3x6)																	
GBRGx24	24 (4x6)																	
GBRGx30	30 (5x6)																	
GBRGx36	36 (6x6)																	
GBRDx24	24 (2x12)	6888	2100	625.0	283.5	Ø 250 ± 15	0.10	2.5	Water-blocking Glass Yarn	0.54	13.7	2.7	3500	20	-	206	274	
GBRDx36	36 (3x12)	13448	4100	1220.2	553.5													
GBRDx48	48 (4x12)																	
GBRDx60	60 (5x12)																	
GBRDx72	72 (6x12)																	
GBREx84	84 (7x12)	6888	2100	787.0	357.0	Ø 250 ± 15	0.10	2.5	Water-blocking Glass Yarn	0.60	15.3	3.0/4.3	4000	20	-	230	306	
GBREx96	96 (8x12)	13448	4100	1536.6	697.0													
GBRFx08	108 (9x12)	6888	2100	1088.0	493.5	Ø 250 ± 15	0.10	2.5	Water-blocking Glass Yarn	0.73	18.5	3.0/7.5	4000	20	-	278	370	
GBRFx20	120 (10x12)	13448	4100	2124.1	963.5													
GBRFx32	132 (11x12)																	
GBRFx44	144 (12x12)																	
GBRMx16	216 (18x12)	6888	2100	1250.0	567.0	Ø 250 ± 15	0.10	2.5	Water-blocking Glass Yarn	0.78	19.7	2.7	4000	20	-	296	394	
		13448	4100	2440.5	1107.0													
GBRlx92	192 (8x24)	6888	2100	1296.3	588.0	Ø 250 ± 15	0.14	3.5	Water-blocking Glass Yarn	0.77	19.5	3.0/6.0	4000	20	-	293	390	
		13448	4100	2530.9	1148.0													
GBRJx88	288 (12x24)	6888	2100	1898.2	861.0	Ø 250 ± 15	0.14	3.5	Water-blocking Glass Yarn	0.94	23.9	3.0/10.5	4000	20	-	359	478	
GBRLx32	432 (18x24)	6888	2100	1898.2	861.0	Ø 250 ± 15	0.14	3.5	Water-blocking Glass Yarn	0.97	24.7	2.7/3.7	4000	20	-	371	494	

Color Code: see chart page 16.23

Loose tubes: 1. Red, 2. Green, rest of tubes White

Blind elements: Clear

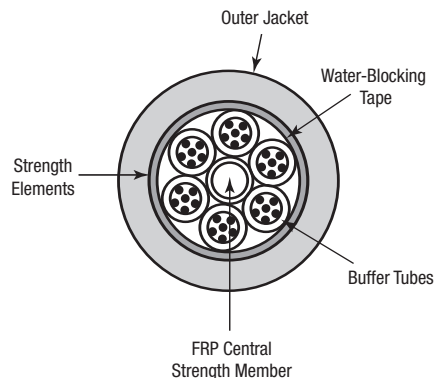

Optical characteristics see page 16.21.
* jelly-filled, non-dripping and silicone-free

Multi Loose Tube Cables

Outdoor – Improved Rodent Protection

De- scription	Part No.	No. of Fibers	Standard Lengths		Standard Unit Weight		Fiber Size µm	Nom. Buffer/ Tube OD		Strength Members	Nominal OD		Central Element mm	Pulling Tension N	Crush Re- sistance kN/m	Energy kJ/m	Bending Radii Cable (mm)	
			ft.	m	lbs.	kg		inch	mm		inch	mm					static	dyna- mic

GDR • Loose Tubes*/PE Blind Elements are S-Z Stranded Around the Central Element • Water-Blocked • **A-DF(ZN)B2Y**

Filled Construction • Black PE (HDPE) Jacket

-30/70°C



GDRGx04	4 (1x4)	6888	2100	476.9	216.3	∅ 250 ± 15	0.07	1.9	Water-blocking Glass Yarn	0.45	11.5	2.0	3000	20	-	173	230
GDRGx06	6 (1x6)	13448	4100	931.0	422.3												
GDRGx08	8 (2x4)																
GDRGx12	12 (2x6)																
GDRGx18	18 (3x6)																
GDRGx24	24 (4x6)																
GDRGx30	30 (5x6)																
GDRGx36	36 (6x6)																
GDRDx24	24 (2x12)	6888	2100	629.6	285.6	∅ 250 ± 15	0.10	2.5	Water-blocking Glass Yarn	0.53	13.4	2.7	3500	20	-	201	268
GDRDx36	36 (3x12)	13448	4100	1229.3	557.6												
GDRDx48	48 (4x12)																
GDRDx60	60 (5x12)																
GDRDx72	72 (6x12)																
GDREx84	84 (7x12)	6888	2100	805.6	365.4	∅ 250 ± 15	0.10	2.5	Water-blocking Glass Yarn	0.59	15.0	3.0/4.3	4000	20	-	225	300
GDREx96	96 (8x12)	13448	4100	1572.8	713.4												
GDRFx08	108 (9x12)	6888	2100	1134.3	514.5	∅ 250 ± 15	0.10	2.5	Water-blocking Glass Yarn	0.72	18.2	3.0/7.5	4000	20	-	273	364
GDRFx20	120 (10x12)	13448	4100	2214.5	1004.5												
GDRFx32	132 (11x12)																
GDRFx44	144 (12x12)																
GDRMx16	216 (18x12)	6888	2100	1319.5	598.5	∅ 250 ± 15	0.10	2.5	Water-blocking Glass Yarn	0.75	19.0	2.7	4000	20	-	285	380
		13448	4100	2576.1	1168.5												
GDRix92	192 (8x24)	6888	2100	1226.9	556.5	∅ 250 ± 15	0.14	3.5	Water-blocking Glass Yarn	0.75	19.0	3.0/6.0	4000	20	-	285	380
		13448	4100	2395.3	1086.5												
GDRJx88	288 (12x24)	6888	2100	1944.5	882.0	∅ 250 ± 15	0.14	3.5	Water-blocking Glass Yarn	0.93	23.5	3.0/10.5	4000	20	-	353	470
		13448	4100	3796.3	1722.0												
GDRLx32	432 (18x24)	6888	2100	2037.1	924.0	∅ 250 ± 15	0.14	3.5	Water-blocking Glass Yarn	0.94	24.0	2.7/3.7	4000	20	-	360	480
		13448	4100	3977.1	1804.0												

Color Code: see chart page 16.23
 Loose tubes: 1. Red, 2. Green, rest of tubes White
 Blind elements: Clear

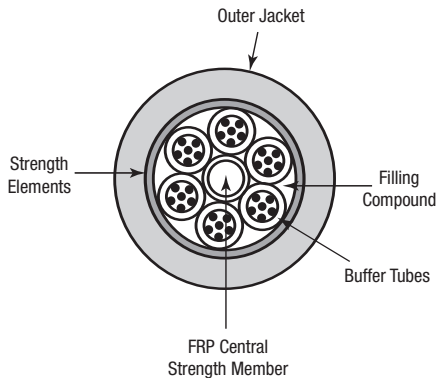

Optical characteristics see page 16.21.
 * jelly-filled, non-dripping and silicone-free

Multi Loose Tube Cables

Outdoor – Full Rodent Protection, Corrugated Steel Tape Armor (CST)

De- scription	Part No.	No. of Fibers	Standard Lengths		Standard Unit Weight		Fiber Size µm	Nom. Buffer/ Tube OD		Strength Members	Nominal OD		Central Element mm	Pulling Tension N	Crush Re- sistance kN/m	Energy kJ/m	Bending Radii Cable (mm)	
			ft.	m	lbs.	kg		inch	mm		inch	mm					static	dyna- mic

GBD • Loose Tubes*/PE Blind Elements are S-Z Stranded Around the Central Element • Water-Blocked • CST • **A-DQ(ZN)2Y(SR)2Y**

Dry Construction • Double Black PE (HDPE) Jacket

-30/70°C



GBDGx04	4 (1x4)	6888	2100	838.0	380.1	∅ 250 ± 15	0.07	1.9	Water-blocking Aramid Yarn	0.52	13.2	2.0	3000	50	-	198	264
GBDGx06	6 (1x6)	13448	4100	1636.0	742.1												
GBDGx08	8 (2x4)																
GBDGx12	12 (2x6)																
GBDGx18	18 (3x6)																
GBDGx24	24 (4x6)																
GBDGx30	30 (5x6)																
GBDGx36	36 (6x6)																
GBDDx24	24 (2x12)	6888	2100	1046.3	474.6	∅ 250 ± 15	0.10	2.5	Water-blocking Aramid Yarn	0.60	15.2	2.7	3500	50	-	228	304
GBDDx36	36 (3x12)																
GBDDx48	48 (4x12)																
GBDDx60	60 (5x12)																
GBDDx72	72 (6x12)																
GBDEx84	84 (7x12)	6888	2100	1273.2	577.5	∅ 250 ± 15	0.10	2.5	Water-blocking Aramid Yarn	0.69	17.4	3.0/4.3	4000	50	-	261	348
GBDEx96	96 (8x12)																
GBDFx08	108 (9x12)	6888	2100	1555.6	705.6	∅ 250 ± 15	0.10	2.5	Water-blocking Aramid Yarn	0.81	20.5	3.0/7.5	4000	50	-	308	410
GBDFx20	120 (10x12)																
GBDFx32	132 (11x12)																
GBDFx44	144 (12x12)																
GBDMx16	216 (18x12)	6888	2100	1759.3	798.0	∅ 250 ± 15	0.10	2.5	Water-blocking Aramid Yarn	0.85	21.5	2.7	4000	50	-	323	430
GBDLx92	192 (8x24)	6888	2100	-	-	∅ 250 ± 15	0.14	3.5	Water-blocking Aramid Yarn	0.85	21.5	3.0/6.0	4000	50	-	323	430
GBDJx88	288 (12x24)	6888	2100	-	-	∅ 250 ± 15	0.14	3.5	Water-blocking Aramid Yarn	1.02	26.0	3.0/10.5	4000	50	-	390	520
GBDLx32	432 (18x24)	6888	2100	-	-	∅ 250 ± 15	0.14	3.5	Water-blocking Aramid Yarn	1.04	26.5	2.7/3.7	4000	50	-	398	530

Color Code: see chart page 16.23
Loose tubes: 1. Red, 2. Green, rest of tubes White
Blind elements: Clear

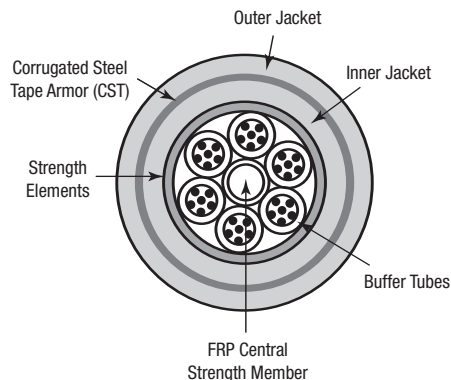

Optical characteristics see page 16.21.
* jelly-filled, non-dripping and silicone-free

Multi Loose Tube Cables

Outdoor – Full Rodent Protection, Corrugated Steel Tape Armor (CST)

De- scription	Part No.	No. of Fibers	Standard Lengths		Standard Unit Weight		Fiber Size µm	Nom. Buffer/ Tube OD		Strength Members	Nominal OD		Central Element mm	Pulling Tension N	Crush Re- sistance kN/m	Energy kJ/m	Bending Radii Cable (mm)	
			ft.	m	lbs.	kg		inch	mm		inch	mm					static	dyna- mic

GDD • Loose Tubes*/PE Blind Elements are S-Z Stranded Around the Central Element • Water-Blocked • CST • **A-DF(ZN)2Y(SR)2Y**

Filled Construction • Double Black PE (HDPE) Jacket

-30/70°C



GDDGx04	4 (1x4)	6888	2100	851.9	386.4	Ø 250 ± 15	0.07	1.9	Water-blocking Aramid Yarn	0.51	13.0	2.0	3000	50	-	195	260
GDDGx06	6 (1x6)	13448	4100	1663.2	754.4												
GDDGx08	8 (2x4)																
GDDGx12	12 (2x6)																
GDDGx18	18 (3x6)																
GDDGx24	24 (4x6)																
GDDGx30	30 (5x6)																
GDDGx36	36 (6x6)																
GDDDx24	24 (2x12)	6888	2100	1083.3	491.4	Ø 250 ± 15	0.10	2.5	Water-blocking Aramid Yarn	0.59	15.0	2.7	3500	50	-	225	300
GDDDx36	36 (3x12)																
GDDDx48	48 (4x12)																
GDDDx60	60 (5x12)																
GDDDx72	72 (6x12)																
GDDEx84	84 (7x12)	6888	2100	1319.5	598.5	Ø 250 ± 15	0.10	2.5	Water-blocking Aramid Yarn	0.67	17.1	3.0/4.3	4000	50	-	257	342
GDDEx96	96 (8x12)																
GDDFx08	108 (9x12)	6888	2100	1745.4	791.7	Ø 250 ± 15	0.10	2.5	Water-blocking Aramid Yarn	0.81	20.5	3.0/7.5	4000	50	-	308	410
GDDFx20	120 (10x12)																
GDDFx32	132 (11x12)																
GDDFx44	144 (12x12)																
GDDMx16	216 (18x12)	6888	2100	1990.8	903.0	Ø 250 ± 15	0.10	2.5	Water-blocking Aramid Yarn	0.83	21.0	2.7	4000	50	-	315	420
GDDIx92	192 (8x24)	6888	2100	-	-	Ø 250 ± 15	0.14	3.5	Water-blocking Aramid Yarn	0.83	21.0	3.0/6.0	4000	50	-	315	420
GDDJx88	288 (12x24)	6888	2100	-	-	Ø 250 ± 15	0.14	3.5	Water-blocking Aramid Yarn	1.00	25.5	3.0/10.5	4000	50	-	383	510
GDDLx32	432 (18x24)	6888	2100	-	-	Ø 250 ± 15	0.14	3.5	Water-blocking Aramid Yarn	1.02	26.0	2.7/3.7	4000	50	-	390	520

Color Code: see chart page 16.23

Loose tubes: 1. Red, 2. Green, rest of tubes White

Blind elements: Clear

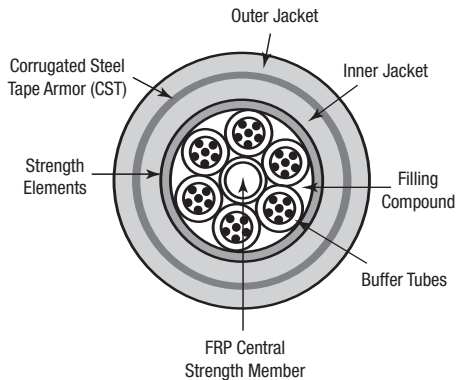

Optical characteristics see page 16.21.

* jelly-filled, non-dripping and silicone-free

Multi Loose Tube Cables

Outdoor – Full Rodent Protection, Galvanised Steel Wire Armor (SWA)

De- scription	Part No.	No. of Fibers	Standard Lengths		Standard Unit Weight		Fiber Size µm	Nom. Buffer/ Tube OD		Strength Members	Nominal OD		Central Element mm	Pulling Tension N	Crush Re- sistance kN/m	Energy kJ/m	Bending Radii Cable (mm)	
			ft.	m	lbs.	kg		inch	mm		inch	mm					static	dyna- mic

GBW • Loose Tubes*/PE Blind Elements are S-Z Stranded Around the Central Element • Water-Blocked • SWA • **A-DQ2YB2Y (R1.0vzk)**

Dry Construction • Double Black PE Jacket

-30/70°C

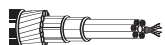

GBWGx04 4 (1x4)	6888	2100	1342.6	609.0	∅ 250 ± 15	0.07	1.9	-	0.53	13.5	2.0	8000	50	-	203	270
GBWGx06 6 (1x6)	13448	4100	2621.3	1189.0												
GBWGx08 8 (2x4)																
GBWGx12 12 (2x6)																
GBWGx18 18 (3x6)																
GBWGx24 24 (4x6)																
GBWGx30 30 (5x6)																
GBWGx36 36 (6x6)																
GBWDx24 24 (2x12)	6888	2100	1666.7	756.0	∅ 250 ± 15	0.10	2.5	-	0.61	15.5	2.7	8000	50	-	233	310
GBWDx36 36 (3x12)	13448	4100	3254.0	1476.0												
GBWDx48 48 (4x12)																
GBWDx60 60 (5x12)																
GBWDx72 72 (6x12)																
GBWEx84 84 (7x12)	6888	2100	1875.0	850.5	∅ 250 ± 15	0.10	2.5	-	0.67	17.0	3.0/4.3	8000	50	-	255	340
GBWEx96 96 (8x12)	13448	4100	3660.7	1660.5												
GBWEx108 108 (9x12)																
GBWEx120 120 (10x12)																
GBWEx132 132 (11x12)																
GBWEx144 144 (12x12)																
GBWFMx16 216 (18x12)	6888	2100	2777.8	1260.0	∅ 250 ± 15	0.10	2.5	-	0.83	21.0	2.7	8000	50	-	315	420
GBWIMx92 192 (8x24)	6888	2100	-	-	∅ 250 ± 15	0.14	3.5	-	0.83	21.0	3.0/6.0	8000	50	-	315	420
GBWJMx88 288 (12x24)	6888	2100	-	-	∅ 250 ± 15	0.14	3.5	-	1.00	25.5	3.0/10.5	8000	50	-	383	510
GBWLMx32 432 (18x24)	6888	2100	-	-	∅ 250 ± 15	0.14	3.5	-	1.02	26.0	2.7/3.7	8000	50	-	390	520

Color Code: see chart page 16.23

Loose tubes: 1. Red, 2. Green, rest of tubes White

Blind elements: Clear

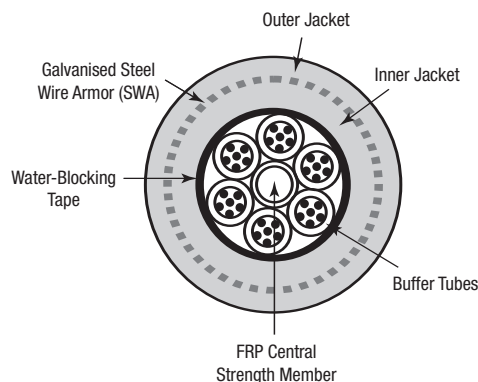

Optical characteristics see page 16.21.
* jelly-filled, non-dripping and silicone-free

Multi Loose Tube Cables

Outdoor – Full Rodent Protection, Galvanised Steel Wire Armor (SWA)

De- scription	Part No.	No. of Fibers	Standard Lengths		Standard Unit Weight		Fiber Size µm	Nom. Buffer/ Tube OD		Strength Members	Nominal OD		Central Element mm	Pulling Tension N	Crush Re- sistance kN/m	Energy kJ/m	Bending Radii Cable (mm)	
			ft.	m	lbs.	kg		inch	mm		inch	mm					static	dyna- mic

GDW • Loose Tubes*/PE Blind Elements are S-Z Stranded Around the Central Element • Water-Blocked • SWA • A-DF2YB2Y (R1.0vzk)

Filled Construction • Double Black PE Jacket

-30/70°C

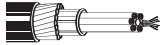

GDWGx04 4 (1x4)	6888	2100	1388.9	630.0	∅ 250 ± 15	0.07	1.9	–	0.53	13.5	2.0	8000	50	–	203	270
GDWGx06 6 (1x6)	13448	4100	2711.7	1230.0												
GDWGx08 8 (2x4)																
GDWGx12 12 (2x6)																
GDWGx18 18 (3x6)																
GDWGx24 24 (4x6)																
GDWGx30 30 (5x6)																
GDWGx36 36 (6x6)																
GDWDx24 24 (2x12)	6888	2100	1713.0	777.0	∅ 250 ± 15	0.10	2.5	–	0.61	15.5	2.7	8000	50	–	233	310
GDWDx36 36 (3x12)	13448	4100	3344.4	1517.0												
GDWDx48 48 (4x12)																
GDWDx60 60 (5x12)																
GDWDx72 72 (6x12)																
GDWEx84 84 (7x12)	6888	2100	1921.3	871.5	∅ 250 ± 15	0.10	2.5	–	0.66	16.8	3.0/4.3	8000	50	–	252	336
GDWEx96 96 (8x12)	13448	4100	3751.1	1701.5												
GDWFx08 108 (9x12)	6888	2100	2638.9	1197.0	∅ 250 ± 15	0.10	2.5	–	0.80	20.2	3.0/7.5	8000	50	–	303	404
GDWFx20 120 (10x12)	13448	4100	5152.2	2337.0												
GDWFx32 132 (11x12)																
GDWFx44 144 (12x12)																
GDWMx16 216 (18x12)	6888	2100	2824.1	1281.0	∅ 250 ± 15	0.10	2.5	–	0.81	20.5	2.7	8000	50	–	308	410
GDWix92 192 (8x24)	6888	2100	–	–	∅ 250 ± 15	0.14	3.5	–	0.81	20.5	3.0/6.0	8000	50	–	308	410
GDWJx88 288 (12x24)	6888	2100	–	–	∅ 250 ± 15	0.14	3.5	–	0.98	25.0	3.0/10.5	8000	50	–	375	500
GDWLx32 432 (18x24)	6888	2100	–	–	∅ 250 ± 15	0.14	3.5	–	1.00	25.5	2.7/3.7	8000	50	–	383	510

Color Code: see chart page 16.23

Loose tubes: 1. Red, 2. Green, rest of tubes White

Blind elements: Clear

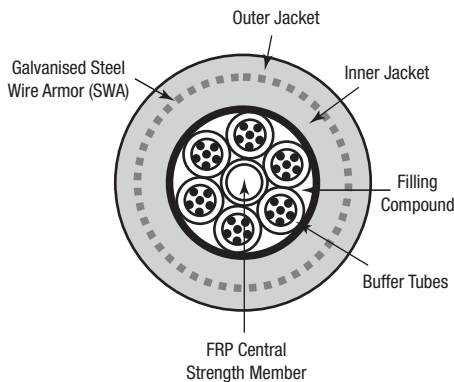

Optical characteristics see page 16.21.

* jelly-filled, non-dripping and silicone-free

Multi Loose Tube Cables

Aerial – Outdoor

De- scription	Part No.	No. of Fibers	Standard Lengths		Standard Unit Weight		Fiber Size µm	Nom. Buffer/ Tube OD		Strength Members	Nominal OD		Central Element mm	Pulling Tension N	Crush Re- sistance kN/m	Energy kJ/m	Bending Radii Cable (mm)	
			ft.	m	lbs.	kg		inch	mm		inch	mm					static	dyna- mic

GALH • Loose Tubes*/PE Blind Elements are S-Z Stranded Around the Central Element • Water-Blocked • **A-DSF(L)2YT (Span = 50 m)**

Filled Construction • Black PE (HDPE) Jacket • Figure 8, Steel Messenger																		
-30/70°C			6888	2100	793.7	360.0	∅ 250 ± 15	0.059	1.5	Steel Messenger	0.380 0.790	9.8 20.0	1.7	4000	20	-	147	196



- GALHx04 4 (1x4)
- GALHx08 8 (2x4)
- GALHx12 12 (3x4)
- GALHx16 16 (4x4)
- GALHx20 20 (5x4)
- GALHx24 24 (6x4)

Color Code: see chart page 16.23
Optional: higher pulling tension available upon request.

GALD • Loose Tubes*/PE Blind Elements are S-Z Stranded Around the Central Element • Water-Blocked • **A-DSF(L)2YT (Span = 50 m)**

Filled Construction • Black PE (HDPE) Jacket • Figure 8, Steel Messenger																		
-30/70°C			6888	2100	1091.3	495.0	∅ 250 ± 15	0.098	2.5	Steel Messenger	0.500 0.914	12.8 23.0	2.7	4000	20	-	192	256



- GALDx12 12 (1x12)
- GALDx24 24 (2x12)
- GALDx36 36 (3x12)
- GALDx48 48 (4x12)
- GALDx60 60 (5x12)
- GALDx72 72 (6x12)

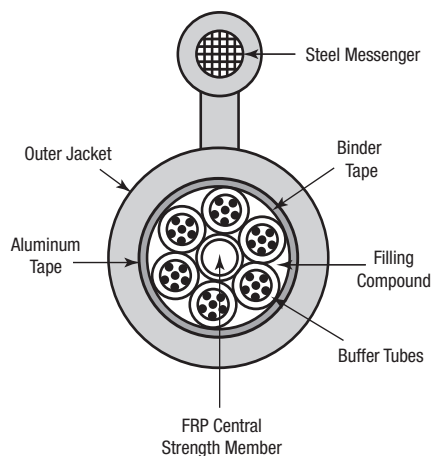

Color Code: see chart page 16.23
Optional: higher pulling tension available upon request.

Optical characteristics see page 16.21.

Multi Loose Tube Cables

Aerial – Outdoor, All Dielectric

De- scription	Part No.	No. of Fibers	Standard Lengths		Standard Unit Weight		Fiber Size µm	Nom. Buffer/ Tube OD		Strength Members	Nominal OD		Central Element mm	Pulling Tension N	Crush Re- sistance kN/m	Energy kJ/m	Bending Radii Cable (mm)	
			ft.	m	lbs.	kg		inch	mm		inch	mm					static	dyna- mic

GAAD • Loose Tubes*/PE Blind Elements are S-Z Stranded Around the Central Element • Water-Blocked • **A-DF(ZN)2YT (Span = 50 m)**

Filled Construction • Black PE (HDPE) Jacket • Figure 8, Dielectric Messenger																		
-30/70°C			6888	2100	910.5	413.0	∅ 250 ± 15	0.098	2.5	FRP Rod Messenger	0.50 0.95	12.7 24.0	2.7	4000	20	-	192	256



- GAADx12 12 (1x12)
- GAADx24 24 (2x12)
- GAADx36 36 (3x12)
- GAADx48 48 (4x12)
- GAADx60 60 (5x12)
- GAADx72 72 (6x12)

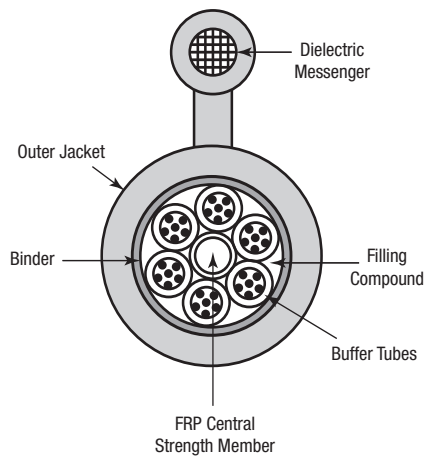

Color Code: see chart page 16.23
 Optional: higher pulling tension available upon request.

Optical characteristics see page 16.21.

Multi Loose Tube Cables

Universal – Indoor/Outdoor

De- scription	Part No.	No. of Fibers	Standard Lengths		Standard Unit Weight		Fiber Size µm	Nom. Buffer/ Tube OD		Strength Members	Nominal OD		Central Element mm	Pulling Tension N	Crush Re- sistance kN/m	Energy kJ/m	Bending Radii Cable (mm)	
			ft.	m	lbs.	kg		inch	mm		inch	mm					static	dyna- mic

GCA • Loose Tubes*/PE Blind Elements are S-Z Stranded Around the Central Element • Water-Blocked • **A/I-DQ(ZN)H**

Dry Construction • Black LSZH Jacket

-30/70°C EN 50266-2-2
EN 50267-2-2
EN 50628-2



GCA Gx04	4 (1x4)	6888	2100	439.8	199.5	Ø 250 ± 15	0.07	1.9	Water-blocking Aramid Yarn	0.41	10.3	2.0	3000	20	–	155	206
GCA Gx06	6 (1x6)	13448	4100	858.7	389.5												
GCA Gx08	8 (2x4)																
GCA Gx12	12 (2x6)																
GCA Gx18	18 (3x6)																
GCA Gx24	24 (4x6)																
GCA Gx30	30 (5x6)																
GCA Gx36	36 (6x6)																
GCA Dx24	24 (2x12)	6888	2100	588.0	266.7	Ø 250 ± 15	0.10	2.5	Water-blocking Aramid Yarn	0.48	12.2	2.7	3500	20	–	183	244
GCA Dx36	36 (3x12)	13448	4100	1147.9	520.7												
GCA Dx48	48 (4x12)																
GCA Dx60	60 (5x12)																
GCA Dx72	72 (6x12)																
GCA Ex84	84 (7x12)	6888	2100	736.1	333.9	Ø 250 ± 15	0.10	2.5	Water-blocking Aramid Yarn	0.54	13.8	3.0/4.3	4000	20	–	207	276
GCA Ex96	96 (8x12)	13448	4100	1437.2	651.9												
GCA Fx08	108 (9x12)	6888	2100	1074.1	487.2	Ø 250 ± 15	0.10	2.5	Water-blocking Aramid Yarn	0.67	17.0	3.0/7.5	4000	20	–	255	340
GCA Fx20	120 (10x12)	13448	4100	2097.0	951.2												
GCA Fx32	132 (11x12)																
GCA Fx44	144 (12x12)																
GCA Mx16	216 (18x12)	6888	2100	1250.0	567.0	Ø 250 ± 15	0.10	2.5	Water-blocking Aramid Yarn	0.72	18.2	2.7	4000	20	–	273	364
		13448	4100	2440.5	1107.0												
GCA Ix92	192 (8x24)	6888	2100	1273.2	577.5	Ø 250 ± 15	0.14	3.5	Water-blocking Aramid Yarn	0.71	18.0	3.0/6.0	4000	20	–	270	360
		13448	4100	2485.7	1127.5												
GCA Jx88	288 (12x24)	6888	2100	1921.3	871.5	Ø 250 ± 15	0.14	3.5	Water-blocking Aramid Yarn	0.88	22.4	3.0/10.5	4000	20	–	336	448
GCA Lx32	432 (18x24)	6888	2100	1944.5	882.0	Ø 250 ± 15	0.14	3.5	Water-blocking Aramid Yarn	0.91	23.2	2.7/3.7	4000	20	–	348	464

Color Code: see chart page 16.23
Loose tubes: 1. Red, 2. Green, rest of tubes White
Blind elements: Clear

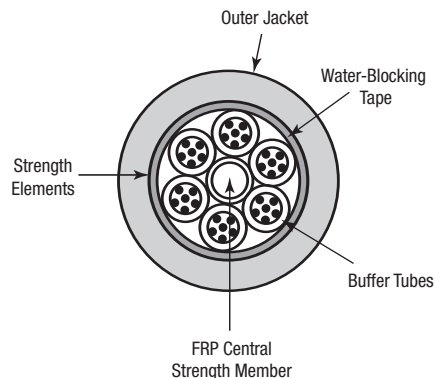

Optical characteristics see page 16.21.
* jelly-filled, non-dripping and silicone-free

Multi Loose Tube Cables

Universal – Indoor/Outdoor

De- scription	Part No.	No. of Fibers	Standard Lengths		Standard Unit Weight		Fiber Size µm	Nom. Buffer/ Tube OD		Strength Members	Nominal OD		Central Element mm	Pulling Tension N	Crush Re- sistance kN/m	Energy kJ/m	Bending Radii Cable (mm)	
			ft.	m	lbs.	kg		inch	mm		inch	mm					static	dyna- mic

GEA • Loose Tubes*/PE Blind Elements are S-Z stranded Around the Central Element • Water-Blocked • **A/I-DF(ZN)H**

Filled Construction • Black LSZH Jacket

-30/70°C EN 50266-2-2
EN 50267-2-2
EN 50628-2



GEAGx04	4 (1x4)	6888	2100	449.1	203.7	∅ 250 ± 15	0.07	1.9	Water-blocking Aramid Yarn	0.39	10.0	2.0	3000	20	-	150	200
GEAGx06	6 (1x6)	13448	4100	876.8	397.7												
GEAGx08	8 (2x4)																
GEAGx12	12 (2x6)																
GEAGx18	18 (3x6)																
GEAGx24	24 (4x6)																
GEAGx30	30 (5x6)																
GEAGx36	36 (6x6)																
GEADx24	24 (2x12)	6888	2100	620.4	281.4	∅ 250 ± 15	0.10	2.5	Water-blocking Aramid Yarn	0.47	12.0	2.7	3500	20	-	180	240
GEADx36	36 (3x12)	13448	4100	1211.2	549.4												
GEADx48	48 (4x12)																
GEADx60	60 (5x12)																
GEADx72	72 (6x12)																
GEAEx84	84 (7x12)	6888	2100	787.0	357.0	∅ 250 ± 15	0.10	2.5	Water-blocking Aramid Yarn	0.54	13.6	3.0/4.3	4000	20	-	204	272
GEAEx96	96 (8x12)	13448	4100	1536.6	697.0												
GEAFx08	108 (9x12)	6888	2100	1157.4	525.0	∅ 250 ± 15	0.10	2.5	Water-blocking Aramid Yarn	0.66	16.8	3.0/7.5	4000	20	-	252	336
GEAFx20	120 (10x12)	13448	4100	2259.7	1025.0												
GEAFx32	132 (11x12)																
GEAFx44	144 (12x12)																
GEAMx16	216 (18x12)	6888	2100	1342.6	609.0	∅ 250 ± 15	0.10	2.5	Water-blocking Aramid Yarn	0.69	17.5	2.7	4000	20	-	263	350
		13448	4100	2621.3	1189.0												
GEAlx92	192 (8x24)	6888	2100	1250.0	567.0	∅ 250 ± 15	0.14	3.5	Water-blocking Aramid Yarn	0.69	17.6	3.0/6.0	4000	20	-	264	352
		13448	4100	2440.5	1107.0												
GEAlx88	288 (12x24)	6888	2100	2013.9	913.5	∅ 250 ± 15	0.14	3.5	Water-blocking Aramid Yarn	0.87	22.1	3.0/10.5	4000	20	-	332	442
GEALx32	432 (18x24)	6888	2100	2129.6	966.0	∅ 250 ± 15	0.14	3.5	Water-blocking Aramid Yarn	0.89	22.5	2.7/3.7	4000	20	-	338	450

Color Code: see chart page 16.23
Loose tubes: 1. Red, 2. Green, rest of tubes White
Blind elements: Clear

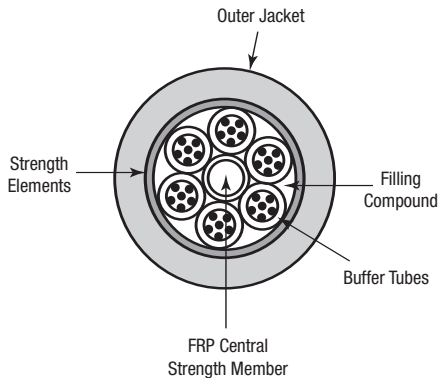

Optical characteristics see page 16.21.
* jelly-filled, non-dripping and silicone-free

Multi Loose Tube Cables

Universal – Indoor/Outdoor, Improved Rodent Protection

De- scription	Part No.	No. of Fibers	Standard Lengths		Standard Unit Weight		Fiber Size µm	Nom. Buffer/ Tube OD		Strength Members	Nominal OD		Central Element mm	Pulling Tension N	Crush Re- sistance kN/m	Energy kJ/m	Bending Radii Cable (mm)	
			ft.	m	lbs.	kg		inch	mm		inch	mm					static	dyna- mic

GCR • Loose Tubes*/PE Blind Elements are S-Z Stranded Around the Central Element • Water-Blocked • A/I-DQ(ZN)BH

Dry Construction • Black LSZH Jacket

-30/70°C EN 50266-2-2
EN 50267-2-2
EN 50268-2



GCRGx04	4 (1x4)	6888	2100	597.2	270.9	∅ 250 ± 15	0.07	1.9	Water-blocking Glass Yarn	0.46	11.8	2.0	3000	20	-	177	236	
GCRGx06	6 (1x6)	13448	4100	1166.0	528.9													
GCRGx08	8 (2x4)																	
GCRGx12	12 (2x6)																	
GCRGx18	18 (3x6)																	
GCRGx24	24 (4x6)																	
GCRGx30	30 (5x6)																	
GCRGx36	36 (6x6)																	
GCRDx24	24 (2x12)	6888	2100	750.0	340.2	∅ 250 ± 15	0.10	2.5	Water-blocking Glass Yarn	0.54	13.7	2.7	3500	20	-	206	274	
GCRDx36	36 (3x12)	13448	4100	1464.3	664.2													
GCRDx48	48 (4x12)																	
GCRDx60	60 (5x12)																	
GCRDx72	72 (6x12)																	
GCREx84	84 (7x12)	6888	2100	930.6	422.1	∅ 250 ± 15	0.10	2.5	Water-blocking Glass Yarn	0.60	15.3	3.0/4.3	4000	20	-	230	306	
GCREx96	96 (8x12)	13448	4100	1816.8	824.1													
GCRFx08	108 (9x12)	6888	2100	1277.8	579.6	∅ 250 ± 15	0.10	2.5	Water-blocking Glass Yarn	0.73	18.5	3.0/7.5	4000	20	-	278	370	
GCRFx20	120 (10x12)	13448	4100	2494.7	1131.6													
GCRFx32	132 (11x12)																	
GCRFx44	144 (12x12)																	
GCRMx16	216 (18x12)	6888	2100	1481.5	672.0	∅ 250 ± 15	0.10	2.5	Water-blocking Glass Yarn	0.78	19.7	2.7	4000	20	-	296	394	
		13448	4100	2892.4	1312.0													
GCRlx92	192 (8x24)	6888	2100	1481.5	672.0	∅ 250 ± 15	0.14	3.5	Water-blocking Glass Yarn	0.77	19.5	3.0/6.0	4000	20	-	293	390	
		13448	4100	2892.4	1312.0													
GCRJx88	288 (12x24)	6888	2100	2129.6	966.0	∅ 250 ± 15	0.14	3.5	Water-blocking Glass Yarn	0.94	23.9	3.0/10.5	4000	20	-	359	478	
GCRlx32	432 (18x24)	6888	2100	2129.6	966.0	∅ 250 ± 15	0.14	3.5	Water-blocking Glass Yarn	0.97	24.7	2.7/3.7	4000	20	-	371	494	

Color Code: see chart page 16.23
Loose tubes: 1. Red, 2. Green, rest of tubes White
Blind elements: Clear

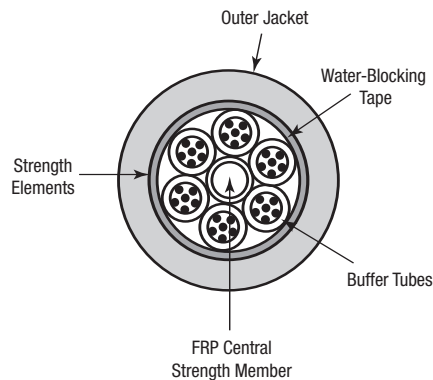

Optical characteristics see page 16.21.
* jelly-filled, non-dripping and silicone-free

Multi Loose Tube Cables

Universal – Indoor/Outdoor, Improved Rodent Protection

De- scription	Part No.	No. of Fibers	Standard Lengths		Standard Unit Weight		Fiber Size µm	Nom. Buffer/ Tube OD		Strength Members	Nominal OD		Central Element mm	Pulling Tension N	Crush Re- sistance kN/m	Energy kJ/m	Bending Radii Cable (mm)	
			ft.	m	lbs.	kg		inch	mm		inch	mm					static	dyna- mic

GER • Loose Tubes*/PE Blind Elements are S-Z Stranded Around the Central Element • Water-Blocked • **A/I-DF(ZN)BH**

Filled Construction • Black LSZH Jacket

-30/70°C EN 50266-2-2
EN 50267-2-2
EN 50268-2



GERGx04	4 (1x4)	6888	2100	601.9	273.0	∅ 250 ± 15	0.07	1.9	Water-blocking Glass Yarn	0.45	11.5	2.0	3000	20	-	173	230
GERGx06	6 (1x6)	13448	4100	1175.1	533.0												
GERGx08	8 (2x4)																
GERGx12	12 (2x6)																
GERGx18	18 (3x6)																
GERGx24	24 (4x6)																
GERGx30	30 (5x6)																
GERGx36	36 (6x6)																
GERDx24	24 (2x12)	6888	2100	777.8	352.8	∅ 250 ± 15	0.10	2.5	Water-blocking Glass Yarn	0.53	13.4	2.7	3500	20	-	201	268
GERDx36	36 (3x12)	13448	4100	1518.5	688.8												
GERDx48	48 (4x12)																
GERDx60	60 (5x12)																
GERDx72	72 (6x12)																
GEREx84	84 (7x12)	6888	2100	967.6	438.9	∅ 250 ± 15	0.10	2.5	Water-blocking Glass Yarn	0.59	15.0	3.0/4.3	4000	20	-	225	300
GEREx96	96 (8x12)	13448	4100	1889.1	856.9												
GERFx08	108 (9x12)	6888	2100	1333.3	604.8	∅ 250 ± 15	0.10	2.5	Water-blocking Glass Yarn	0.72	18.2	3.0/7.5	4000	20	-	273	364
GERFx20	120 (10x12)	13448	4100	2603.2	1180.8												
GERFx32	132 (11x12)																
GERFx44	144 (12x12)																
GERMx16	216 (18x12)	6888	2100	1527.8	693.0	∅ 250 ± 15	0.10	2.5	Water-blocking Glass Yarn	0.75	19.0	2.7	4000	20	-	285	380
		13448	4100	2982.8	1353.0												
GERIx92	192 (8x24)	6888	2100	1435.2	651.0	∅ 250 ± 15	0.14	3.5	Water-blocking Glass Yarn	0.75	19.0	3.0/6.0	4000	20	-	285	380
		13448	4100	2802.0	1271.0												
GERJx88	288 (12x24)	6888	2100	2222.2	1008.0	∅ 250 ± 15	0.14	3.5	Water-blocking Glass Yarn	0.93	23.5	3.0/10.5	4000	20	-	353	470
GERLx32	432 (18x24)	6888	2100	2314.8	1050.0	∅ 250 ± 15	0.14	3.5	Water-blocking Glass Yarn	0.94	24.0	2.7/3.7	4000	20	-	360	480

Color Code: see chart page 16.23
Loose tubes: 1. Red, 2. Green, rest of tubes White
Blind elements: Clear

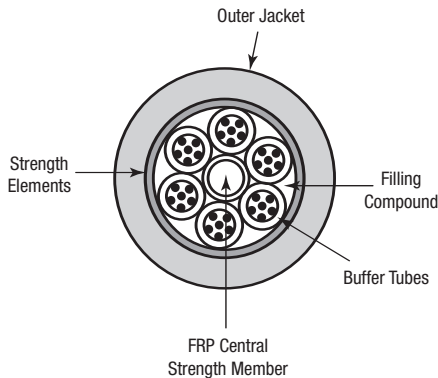

Optical characteristics see page 16.21.
* jelly-filled, non-dripping and silicone-free

Multi Loose Tube Cables

Universal – Indoor/Outdoor, Full Rodent Protection, Corrugated Steel Tape Armor (CST)

De- scription	Part No.	No. of Fibers	Standard Lengths		Standard Unit Weight		Fiber Size µm	Nom. Buffer/ Tube OD		Strength Members	Nominal OD		Central Element mm	Pulling Tension N	Crush Re- sistance kN/m	Energy kJ/m	Bending Radii Cable (mm)	
			ft.	m	lbs.	kg		inch	mm		inch	mm					static	dyna- mic

GCD • Loose Tubes*/PE Blind Elements are S-Z Stranded Around the Central Element • Water-Blocked • CST • **A/I-DQ(ZN)H(SR)H**

Dry Construction • Double Black LSZH Jacket

-30/70°C EN 50266-2-2
EN 50267-2-2
EN 50268-2



GCDGx04	4 (1x4)	6888	2100	1041.7	472.5	∅ 250 ± 15	0.07	1.9	Water-blocking Aramid Yarn	0.52	13.2	2.0	3000	50	-	198	264
GCDGx06	6 (1x6)	13448	4100	2033.7	922.5												
GCDGx08	8 (2x4)																
GCDGx12	12 (2x6)																
GCDGx18	18 (3x6)																
GCDGx24	24 (4x6)																
GCDGx30	30 (5x6)																
GCDGx36	36 (6x6)																
GCDx24	24 (2x12)	6888	2100	1296.3	588.0	∅ 250 ± 15	0.10	2.5	Water-blocking Aramid Yarn	0.60	15.2	2.7	3500	50	-	228	304
GCDx36	36 (3x12)																
GCDx48	48 (4x12)																
GCDx60	60 (5x12)																
GCDx72	72 (6x12)																
GCDEx84	84 (7x12)	6888	2100	1574.1	714.0	∅ 250 ± 15	0.10	2.5	Water-blocking Aramid Yarn	0.69	17.4	3.0/4.3	4000	50	-	261	348
GCDEx96	96 (8x12)																
GCDFx08	108 (9x12)	6888	2100	2055.6	932.4	∅ 250 ± 15	0.10	2.5	Water-blocking Aramid Yarn	0.81	20.5	3.0/7.5	4000	50	-	308	410
GCDFx20	120 (10x12)																
GCDFx32	132 (11x12)																
GCDFx44	144 (12x12)																
GCDMx16	216 (18x12)	6888	2100	2268.5	1029.0	∅ 250 ± 15	0.10	2.5	Water-blocking Aramid Yarn	0.85	21.5	2.7	4000	50	-	323	430
GCDIx92	192 (8x24)	6888	2100	-	-	∅ 250 ± 15	0.14	3.5	Water-blocking Aramid Yarn	0.85	21.5	3.0/6.0	4000	50	-	323	430
GCDJx88	288 (12x24)	6888	2100	-	-	∅ 250 ± 15	0.14	3.5	Water-blocking Aramid Yarn	1.02	26.0	3.0/10.5	4000	50	-	390	520
GCDLx32	432 (18x24)	6888	2100	-	-	∅ 250 ± 15	0.14	3.5	Water-blocking Aramid Yarn	1.04	26.5	2.7/3.7	4000	50	-	398	530

Color Code: see chart page 16.23
Loose tubes: 1. Red, 2. Green, rest of tubes White
Blind elements: Clear

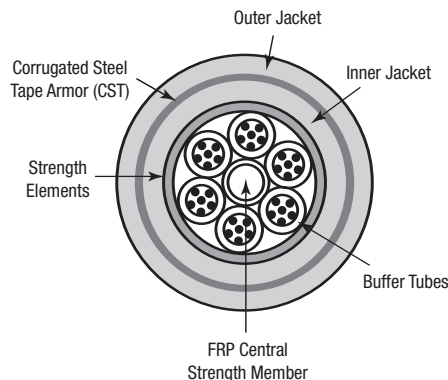

Optical characteristics see page 16.21.
* jelly-filled, non-dripping and silicone-free

Multi Loose Tube Cables

Universal – Indoor/Outdoor, Full Rodent Protection, Corrugated Steel Tape Armor (CST)

De- scription	Part No.	No. of Fibers	Standard Lengths		Standard Unit Weight		Fiber Size µm	Nom. Buffer/ Tube OD		Strength Members	Nominal OD		Central Element mm	Pulling Tension N	Crush Re- sistance kN/m	Energy kJ/m	Bending Radii Cable (mm)	
			ft.	m	lbs.	kg		inch	mm		inch	mm					static	dyna- mic

GED • Loose Tubes*/PE Blind Elements are S-Z Stranded Around the Central Element • Water-Blocked • CST • **A/I-DF(ZN)H(SRJH)**

Filled Construction • Double Black LSZH Jacket

-30/70°C EN 50266-2-2
EN 50267-2-2
EN 50268-2



GEDGx04	4 (1x4)	6888	2100	1050.9	476.7	∅ 250 ± 15	0.07	1.9	Water-blocking Aramid Yarn	0.51	13.0	2.0	3000	50	-	195	260
GEDGx06	6 (1x6)	13448	4100	2051.8	930.7												
GEDGx08	8 (2x4)																
GEDGx12	12 (2x6)																
GEDGx18	18 (3x6)																
GEDGx24	24 (4x6)																
GEDGx30	30 (5x6)																
GEDGx36	36 (6x6)																
GEDDx24	24 (2x12)	6888	2100	1324.1	600.6	∅ 250 ± 15	0.10	2.5	Water-blocking Aramid Yarn	0.59	15.0	2.7	3500	50	-	225	300
GEDDx36	36 (3x12)																
GEDDx48	48 (4x12)																
GEDDx60	60 (5x12)																
GEDDx72	72 (6x12)																
GEDEx84	84 (7x12)	6888	2100	1606.5	728.7	∅ 250 ± 15	0.10	2.5	Water-blocking Aramid Yarn	0.67	17.1	3.0/4.3	4000	50	-	257	342
GEDEx96	96 (8x12)																
GEDFx08	108 (9x12)	6888	2100	2101.9	953.4	∅ 250 ± 15	0.10	2.5	Water-blocking Aramid Yarn	0.81	20.5	3.0/7.5	4000	50	-	308	410
GEDFx20	120 (10x12)																
GEDFx32	132 (11x12)																
GEDFx44	144 (12x12)																
GEDMx16	216 (18x12)	6888	2100	2361.1	1071.0	∅ 250 ± 15	0.10	2.5	Water-blocking Aramid Yarn	0.83	21.0	2.7	4000	50	-	315	420
GEDIx92	192 (8x24)	6888	2100	-	-	∅ 250 ± 15	0.14	3.5	Water-blocking Aramid Yarn	0.83	21.0	3.0/6.0	4000	50	-	315	420
GEDJx88	288 (12x24)	6888	2100	-	-	∅ 250 ± 15	0.14	3.5	Water-blocking Aramid Yarn	1.00	25.5	3.0/10.5	4000	50	-	383	510
GEDLx32	432 (18x24)	6888	2100	-	-	∅ 250 ± 15	0.14	3.5	Water-blocking Aramid Yarn	1.02	26.0	2.7/3.7	4000	50	-	390	520

Color Code: see chart page 16.23
Loose tubes: 1. Red, 2. Green, rest of tubes White
Blind elements: Clear

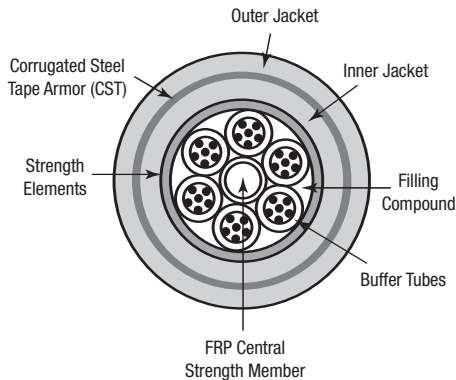

Optical characteristics see page 16.21.
* jelly-filled, non-dripping and silicone-free

Multi Loose Tube Cables

Universal – Indoor/Outdoor, Full Rodent Protection, Galvanised Steel Wire Armor (SWA)

De- scription	Part No.	No. of Fibers	Standard Lengths		Standard Unit Weight		Fiber Size µm	Nom. Buffer/ Tube OD		Strength Members	Nominal OD		Central Element mm	Pulling Tension N	Crush Re- sistance kN/m	Energy kJ/m	Bending Radii Cable (mm)	
			ft.	m	lbs.	kg		inch	mm		inch	mm					static	dyna- mic

GCW • Loose Tubes*/PE Blind Elements are S-Z Stranded Around the Central Element • Water-Blocked • SWA • A/I-DQHBH (R1.0vzk)

Dry Construction • Double Black LSZH Jacket

-30/70°C EN 50266-2-2
EN 50267-2-2
EN 50268-2

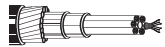

GCWGx04	4 (1x4)	6888	2100	1574.1	714.0	∅ 250 ± 15	0.07	1.9	-	0.54	13.6	2.0	8000	50	-	204	272
GCWGx06	6 (1x6)	13448	4100	3073.2	1394.0												
GCWGx08	8 (2x4)																
GCWGx12	12 (2x6)																
GCWGx18	18 (3x6)																
GCWGx24	24 (4x6)																
GCWGx30	30 (5x6)																
GCWGx36	36 (6x6)																
GCWDx24	24 (2x12)	6888	2100	1912.0	867.3	∅ 250 ± 15	0.10	2.5	-	0.61	15.5	2.7	8000	50	-	233	310
GCWDx36	36 (3x12)	13448	4100	3733.0	1693.3												
GCWDx48	48 (4x12)																
GCWDx60	60 (5x12)																
GCWDx72	72 (6x12)																
GCWEx84	84 (7x12)	6888	2100	2152.8	976.5	∅ 250 ± 15	0.10	2.5	-	0.67	17.0	3.0/4.3	8000	50	-	255	340
GCWEx96	96 (8x12)	13448	4100	4203.1	1906.5												
GCWEx108	108 (9x12)																
GCWEx120	120 (10x12)																
GCWEx132	132 (11x12)																
GCWEx144	144 (12x12)																
GCWEx168	168 (14x12)																
GCWEx192	192 (16x12)																
GCWEx216	216 (18x12)	6888	2100	3101.9	1407.0	∅ 250 ± 15	0.10	2.5	-	0.83	21.0	2.7	8000	50	-	315	420
GCWEx240	240 (20x12)																
GCWEx264	264 (22x12)																
GCWEx288	288 (24x12)																
GCWEx312	312 (26x12)																
GCWEx336	336 (28x12)																
GCWEx360	360 (30x12)																
GCWEx384	384 (32x12)																
GCWEx408	408 (34x12)																
GCWEx432	432 (36x12)																
GCWEx456	456 (38x12)																
GCWEx480	480 (40x12)																
GCWEx504	504 (42x12)																
GCWEx528	528 (44x12)																
GCWEx552	552 (46x12)																
GCWEx576	576 (48x12)																
GCWEx600	600 (50x12)																
GCWEx624	624 (52x12)																
GCWEx648	648 (54x12)																
GCWEx672	672 (56x12)																
GCWEx696	696 (58x12)																
GCWEx720	720 (60x12)																
GCWEx744	744 (62x12)																
GCWEx768	768 (64x12)																
GCWEx792	792 (66x12)																
GCWEx816	816 (68x12)																
GCWEx840	840 (70x12)																
GCWEx864	864 (72x12)																
GCWEx888	888 (74x12)																
GCWEx912	912 (76x12)																
GCWEx936	936 (78x12)																
GCWEx960	960 (80x12)																
GCWEx984	984 (82x12)																
GCWEx1008	1008 (84x12)																
GCWEx1032	1032 (86x12)																
GCWEx1056	1056 (88x12)																
GCWEx1080	1080 (90x12)																
GCWEx1104	1104 (92x12)																
GCWEx1128	1128 (94x12)																
GCWEx1152	1152 (96x12)																
GCWEx1176	1176 (98x12)																
GCWEx1200	1200 (100x12)																
GCWEx1224	1224 (102x12)																
GCWEx1248	1248 (104x12)																
GCWEx1272	1272 (106x12)																
GCWEx1296	1296 (108x12)																
GCWEx1320	1320 (110x12)																
GCWEx1344	1344 (112x12)																
GCWEx1368	1368 (114x12)																
GCWEx1392	1392 (116x12)																
GCWEx1416	1416 (118x12)																
GCWEx1440	1440 (120x12)																
GCWEx1464	1464 (122x12)																
GCWEx1488	1488 (124x12)																
GCWEx1512	1512 (126x12)																
GCWEx1536	1536 (128x12)																
GCWEx1560	1560 (130x12)																
GCWEx1584	1584 (132x12)																
GCWEx1608	1608 (134x12)																
GCWEx1632	1632 (136x12)																
GCWEx1656	1656 (138x12)																
GCWEx1680	1680 (140x12)																
GCWEx1704	1704 (142x12)																
GCWEx1728	1728 (144x12)																
GCWEx1752	1752 (146x12)																
GCWEx1776	1776 (148x12)																
GCWEx1800	1800 (150x12)																
GCWEx1824	1824 (152x12)																
GCWEx1848	1848 (154x12)																
GCWEx1872	1872 (156x12)																
GCWEx1896	1896 (158x12)																
GCWEx1920	1920 (160x12)																
GCWEx1944	1944 (162x12)																
GCWEx1968	1968 (164x12)																
GCWEx1992	1992 (166x12)																
GCWEx2016	2016 (168x12)																
GCWEx2040	2040 (170x12)																

Multi Loose Tube Cables

Universal – Indoor/Outdoor, Full Rodent Protection, Galvanised Steel Wire Armor (SWA)

De- scription	Part No.	No. of Fibers	Standard Lengths		Standard Unit Weight		Fiber Size µm	Nom. Buffer/ Tube OD		Strength Members	Nominal OD		Central Element mm	Pulling Tension N	Crush Re- sistance kN/m	Energy kJ/m	Bending Radii Cable (mm)	
			ft.	m	lbs.	kg		inch	mm		inch	mm					static	dyna- mic

GEW • Loose Tubes*/PE Blind Elements are S-Z Stranded Around the Central Element • Water-Blocked • SWA • **A/I-DFHBH (R1.0vzk)**

Filled Construction • Double Black LSZH Jacket

-30/70°C EN 50266-2-2
EN 50267-2-2
EN 50268-2

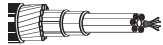

GEWx04	4 (1x4)	6888	2100	1574.1	714.0	Ø 250 ± 15	0.07	1.9	-	0.53	13.5	2.0	8000	50	-	203	270
GEWx06	6 (1x6)	13448	4100	3073.2	1394.0												
GEWx08	8 (2x4)																
GEWx12	12 (2x6)																
GEWx18	18 (3x6)																
GEWx24	24 (4x6)																
GEWx30	30 (5x6)																
GEWx36	36 (6x6)																
GEWd24	24 (2x12)	6888	2100	1944.5	882.0	Ø 250 ± 15	0.10	2.5	-	0.61	15.5	2.7	8000	50	-	233	310
GEWd36	36 (3x12)	13448	4100	3796.3	1722.0												
GEWd48	48 (4x12)																
GEWd60	60 (5x12)																
GEWd72	72 (6x12)																
GEWEx84	84 (7x12)	6888	2100	2199.1	997.5	Ø 250 ± 15	0.10	2.5	-	0.66	16.8	3.0/4.3	8000	50	-	252	336
GEWEx96	96 (8x12)	13448	4100	4293.5	1947.5												
GEWFx08	108 (9x12)	6888	2100	2963.0	1344.0	Ø 250 ± 15	0.10	2.5	-	0.80	20.2	3.0/7.5	8000	50	-	303	404
GEWFx20	120 (10x12)	13448	4100	5784.9	2624.0												
GEWFx32	132 (11x12)																
GEWFx44	144 (12x12)																
GEWMx16	216 (18x12)	6888	2100	3101.9	1407.0	Ø 250 ± 15	0.10	2.5	-	0.81	20.6	2.7	8000	50	-	309	412
GEWix92	192 (8x24)	6888	2100	-	-	Ø 250 ± 15	0.14	3.5	-	0.81	20.5	3.0/6.0	8000	50	-	308	410
GEWJx88	288 (12x24)	6888	2100	-	-	Ø 250 ± 15	0.14	3.5	-	0.98	25.0	3.0/10.5	8000	50	-	375	500
GEWLx32	432 (18x24)	6888	2100	-	-	Ø 250 ± 15	0.14	3.5	-	1.00	25.5	2.7/3.7	8000	50	-	383	510

Color Code: see chart page 16.23
Loose tubes: 1. Red, 2. Green, rest of tubes White
Blind elements: Clear

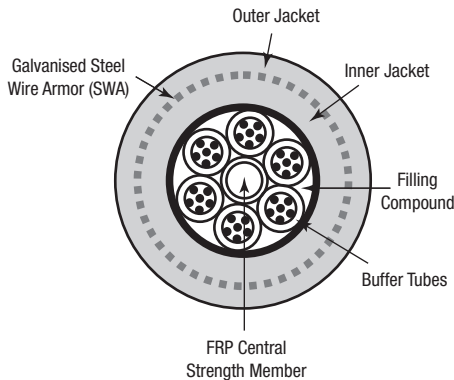

Optical characteristics see page 16.21.
* jelly-filled, non-dripping and silicone-free

Interconnect Cables – Simplex and Duplex

Tight Buffer – Plenum Rated

Applications

- Patch panels
- Workstation equipment connections
- Horizontal distribution in open office environments

Product Description

Interconnect cables are designed for low fiber-count premises environments. They are small and very flexible, making them ideal for confined spaces. Their aesthetic appearance makes these cables suitable for use in open office environments. Available in 1 or 2 fibers. One sub-unit is marked to permit easy identification of transmit and receive fibers. Length markings to facilitate installation.

Jacket Material	PVC
Tight Buffer	PVC
Strength Member	Aramid Yarn
Color Code (Tight Buffer)	Per EIA/TIA 598-A, see page 16.24
Jacket Color	
Single-mode	Yellow
62.5/125 μm	Orange
50/125 μm/1 Gbe	Orange
50/125 μm/10 Gbe	Aqua

Ratings

Plenum	
UL Type	OFNP
cUL Type	OFN FT6
Flame resistance	NFPA 262

Specifications

Temperature Range	
Storage	-40 to +70°C
Operating	-20 to +70°C
Crush Resistance (EIA-455-41)	200 N/cm
Impact Resistance (EIA-455-25)	20 Impacts @ 1.0 N-m
Cyclic Flexing (EIA-455-104)	2000 cycles, min.
Min. Bend Radius	
Installation	15xOD
Long term	10xOD
Optical Specifications	see page 16.24

Fiber Bundle Detail

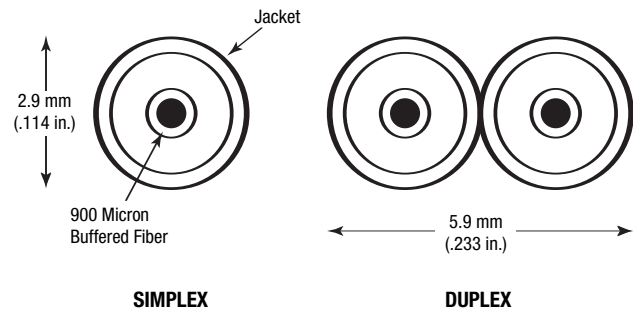

No. of Fibers	Belden Part Number				Outside Diameter		Weight		Max. Install Load	
	62.5/125 μm Std./1 Gbe	50.0/125 μm Std./1 Gbe	50.0/125 μm 10 Gbe - 300M	Single-Mode Enhanced	inch	mm	lbs./1000'	kg/km	lbs.	N

Interconnect Cable Series

Plenum (NEC/CEC OFNP/OFN FT6)										
1	M98086	M9A003	M9C003	M9W003	0.114	2.9	6	9	90	400
2	M96919	M9A004	M9C004	M9W004	0.11 x 0.23	2.9 x 5.9	13	19	180	801

Distribution Cables

Tight Buffer – Indoor Plenum Rated

Applications

- Low to high fiber count requirements
- In-building backbone
- Fiber-to-the-desk applications
- Computer room

Product Description

Flexible thermoplastic jacket provides excellent handling characteristics. Fibers and cable sub-units are color coded for easy identification. Length markings in meters for easy determination of cable length. Full dielectric construction, no grounding required. For Riser offering, MSHA approved cables are available.

Jacket Material	
Non-unitized Plenum	PVC
Unitized Plenum	PVDF
Tight Buffer	
Plenum	PVC
Strength Member	
	Aramid Yarn
Color Code (Tight Buffer)	
	Per EIA/TIA 598-A, see page 16.24
Jacket Color	
Single-mode	Yellow
62.5/125 μm	Orange (Green for LSZH only)
50/125 μm/1 Gbe	Orange
50/125 μm/10 Gbe	Aqua

Ratings

Plenum	
UL Type	OFNP
cUL Type	OFN FT6
Flame resistance	NFPA 262

Specifications

Temperature Range	
Storage	-40 to +80°C
Operating	-20 to +70°C
Crush Resistance (EIA-455-41)	
	2000 N/cm
Impact Resistance (EIA-455-25)	
	2000 Impacts @ 1.6 N-m
Cyclic Flexing (EIA-455-104)	
	2000 cycles, min.
Min. Bend Radius	
Installation	15xOD
Long term	10xOD
Optical Specifications	
	see page 16.24

Fiber Bundle Detail

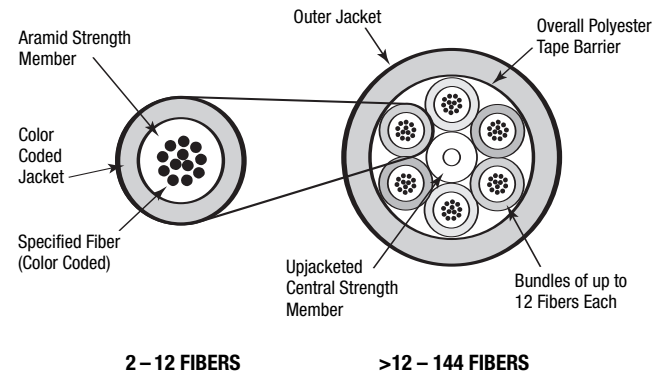

Distribution Cables

Tight Buffer – Indoor Plenum Rated (*continued*)

No. of Fibers	Belden Part Number				Outside Diameter		Weight		Max. Install Load	
	62.5/125 µm Std./1 Gbe	50.0/125 µm Std./1 Gbe	50.0/125 µm 10 Gbe - 300M	Single-Mode Enhanced	inch	mm	lbs./1000'	kg/km	lbs.	N

Distribution Cable Series

Plenum (NEC/CEC OFNP/OFN FT6)										
2	M9B043	M9A043	M9C043	M9W043	0.184	4.67	14	21	180	801
4	M9B044	M9A044	M9C044	M9W044	0.174	4.42	13	19	195	867
6	M9B045	M9A045	M9C045	M9W045	0.190	4.83	16	24	270	1201
8	M9B046	M9A046	M9C046	M9W046	0.222	5.64	19	28	270	1201
12	M9B048	M9A048	M9C048	M9W048	0.225	5.72	22	33	300	1334
24	M9B611*	M9A611*	M9C611*	M9W611*	0.330	8.38	40	60	390	1735
24	M9B612	M9A612	M9C612	M9W612	0.493	12.52	89	132	1263	5618
36	M9B614	M9A614	M9C614	M9W614	0.594	15.09	134	199	1913	8509
48	M9B616	M9A616	M9C616	M9W616	0.599	15.21	131	195	1245	5538
72	M9B620	M9A620	M9C620	M9W620	0.754	19.15	197	293	2093	9310
96	M9B623	M9A623	M9C623	M9W623	0.904	22.96	268	399	2160	9608
144	M9B621	M9A621	M9C621	M9W621	1.047	26.59	365	543	3645	16213

Composite Plenum Cables										
6xSM/ 6x62.5	M97174									
6xSM/ 12x62.5	M97041									
12xSM/ 12x62.5	M97219									
6xSM/ 6x50	M97412									
6xSM/ 12x50	M97411									
12xSM/ 12x50	M96780									

Construction for LSZH cables differs from the drawing. Alternative fiber counts are available.
 * Single jacket design.

Breakout Style Cables

Tight Buffer — Indoor Plenum Rated

Applications

- Low to medium fiber count requirements
- In-building backbone or horizontal deployment
- Office wiring
- Factory floor automation and harsh environment installations

Product Description

Full dielectric construction, no grounding required. Available with 2 to 36 fibers. Fiber subunits are color coded for easy identification. Length markings in meters for easy determination of cable length. For riser offering, MSHA approved cables are available.

Outer Jacket Material	
Riser & Plenum	PVC
Plenum	PVDF
Sub-unit Jacket Material	
Riser & Plenum	PVC
Tight Buffer	
Riser & Plenum	PVC
Strength Member	
	Aramid Yarn
Color Code (Tight Buffer)	
	Per EIA/TIA 598-A, see page 16.24
Jacket Color	
Single-mode	Yellow
62.5/125 μm	Orange (Green for LSZH only)
50/125 μm/1 Gbe	Orange
50/125 μm/10 Gbe	Aqua

Specifications

Temperature Range	
Storage	-40 to +80°C
Operating	-20 to +70°C
Crush Resistance (EIA-455-41)	
	2000 N/cm
Impact Resistance (EIA-455-25)	
	2000 Impacts @ 1.6 N-m
Cyclic Flexing (EIA-455-104)	
	2000 cycles, min.
Min. Bend Radius	
Installation	15xOD
Long term	10xOD
Optical Specifications	
	see page 16.24

Fiber Bundle Detail

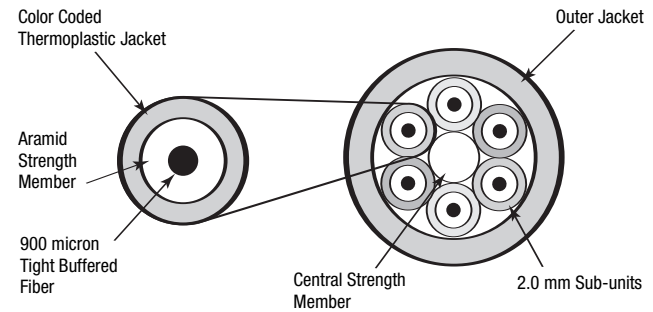

Ratings

Plenum	
UL Type	OFNP
cUL Type	OFN FT6
Flame resistance	NFPA 262

No. of Fibers	Belden Part Number				Outside Diameter		Weight		Max. Install Load	
	62.5/125 μm Std./1 Gbe	50.0/125 μm Std./1 Gbe	50.0/125 μm 10 Gbe - 300M	Single-Mode Enhanced	inch	mm	lbs./1000'	kg/km	lbs.	N

Breakout Cable Series

Plenum (NEC/CEC OFNP/OFN FT6)										
2	M9B013	M9A013	M9C013	M9W013	0.230	5.84	20	30	180	801
4	M9B014	M9A014	M9C014	M9W014	0.263	6.68	30	45	345	1535
6	M9B015	M9A015	M9C015	M9W015	0.309	7.85	41	61	465	2068
8	M9B016	M9A016	M9C016	M9W016	0.336	8.53	55	82	600	2700
10	M9B017	M9A017	M9C017	M9W017	0.385	9.78	73	109	600	2700
12	M9B018	M9A018	M9C018	M9W018	0.391	9.93	65	97	600	2700
18	M9B019	M9A019	M9C019	M9W019	0.456	11.58	89	132	600	2700
24	M9B020	M9A020	M9C020	M9W020	0.544	13.82	117	174	600	2700
36	M9B082	M9A082	M9C082	M9W082	0.612	15.54	154	229	600	2700

2.5 mm Breakout Cables are also available.

Industrial Armored Cables

Tight Buffer — Indoor Plenum Rated (*continued*)

Applications

- Industrial environments
- Rugged installations
- Manufacturing plants
- Mining operations
- Telecommunications and data trunk
- Inter- and intra-building installations

Product Description

Heavy duty construction with interlocking aluminum armor (steel available on request) provides excellent mechanical protection from cutting or crushing and eliminates need for innerduct. Rodent resistant. Also available for outside plant. Loose tube design available on request.

Jacket Material		
Plenum	PVC	
Buffer Tube	PVC	
Strength Member	Aramid Yarn	
Central Strength Member	E-Glass	
Armor	Aluminum	
Color Code (Buffer)	Per EIA/TIA 598-A, see page 16.24	
Jacket Color		
Single-mode	Yellow	
62.5/125 μm	Orange	
50/125 μm/1 Gbe	Orange	
50/125 μm/10 Gbe	Aqua	

Ratings

Plenum	
UL Type	OFCP
cUL Type	OFC FT6
Flame resistance	NFPA 262

Specifications

Temperature Range	
Storage	-40 to +70°C
Operating	-20 to +70°C
Crush Resistance (EIA-455-41)	2000 N/cm
Impact Resistance (EIA-455-25)	2000 Impacts @ 3.0 N-m
Min. Bend Radius	
Installation	20xOD
Long term	15xOD
Optical Specifications	see page 16.24

Fiber Bundle Detail

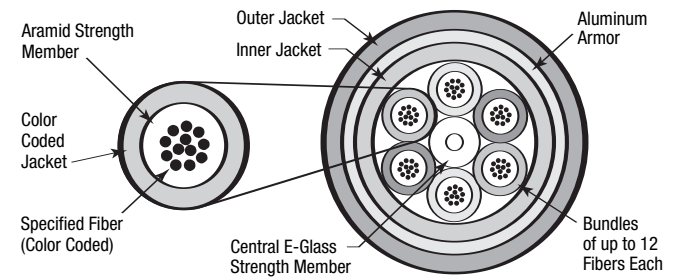

No. of Fibers	Belden Part Number				Outside Diameter		Weight		Max. Install Load	
	62.5/125 μm Std./1 Gbe	50.0/125 μm Std./1 Gbe	50.0/125 μm 10 Gbe - 300M	Single-Mode Enhanced	inch	mm	lbs./1000'	kg/km	lbs.	N

Industrial Armored Series

Plenum (NEC/CEC OFCP/OFC FT6)										
6	M9B240	M9A240	M9C240	M9W240	0.471	12.00	87	129	270	1201
12	M9B241	M9A241	M9C241	M9W241	0.506	12.90	103	153	300	1334
24	M9B242*	M9A242*	M9C242*	M9W242*	0.631	16.00	151	225	390	1735
24	M9B243	M9A243	M9C243	M9W243	0.781	19.84	289	430	600	2700
36	M9B244	M9A244	M9C244	M9W244	0.881	22.38	309	460	600	2700
48	M9B245	M9A245	M9C245	M9W245	0.906	23.01	320	476	600	2700
72	M9B246	M9A246	M9C246	M9W246	1.056	26.82	451	671	600	2700
96	M9B247	M9A247	M9C247	M9W247	1.256	31.90	608	905	600	2700
144	M9B248	M9A248	M9C248	M9W248	1.331	33.81	687	1022	600	2700

All optical fiber products can be supplied in compliance with RoHS regulations.
*Single jacket design.

Single Jacket, All Dielectric Cable

Loose Tube – Indoor/Outdoor Plenum Rated

Applications

- Medium to high fiber count requirements
- Inter-building duct installations
- Lashed aerial
- Indoor/outdoor
- Campus backbones
- Data centers
- High-density cable trays

Product Description

Dry water-blocking technology used within tubes and under jacket. Available as plenum rated cable, thereby eliminating the need for service entrance splicing to in-building cable. Small diameter and bend radius facilitate installation in tight spaces. Full dielectric construction, no grounding required. Available with up to 144 fibers. Fibers grouped into sets of 12 for maximum density. Length markings in meters for easy determination of cable length.

Jacket Material	
Non-unitized	PVC
Unitized	PVDF
Buffer Tube	
	PVC
Strength Member	
	E-Glass and Aramid Yarn
Central Strength Member	
	Upjacketed
Color Code (Buffer)	
	Per EIA/TIA 598-A, see page 16.24
Jacket Color	
	Black

Ratings

Plenum	
UL Type	OFNP
cUL Type	OFN FT6
Flame resistance	NFPA 262

Specifications

Temperature Range	
Storage	-40 to +80°C
Operating	-40 to +70°C
Installation	0 to +60°C
Crush Resistance (EIA-455-41)	
	2000 N/cm
Impact Resistance (EIA-455-25)	
	2000 Impacts @ 1.6 N-m
Cyclic Flexing (EIA-455-104)	
	2000 cycles, min.
Min. Bend Radius	
Installation	20xOD
Long term	15xOD
Optical Specifications	
	see page 16.24

Fiber Bundle Detail

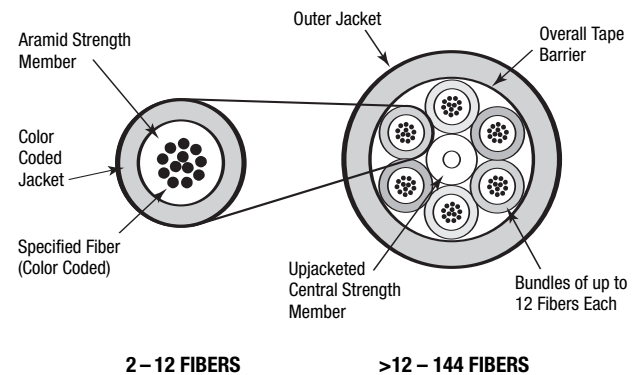

No. of Fibers	Fibers per tube	Belden Part Number				Outside Diameter		Weight		Max. Install Load	
		62.5/125 µm Std./1 Gbe	50.0/125 µm Std./1 Gbe	50.0/125 µm 10 Gbe - 300M	Single-Mode Enhanced	inch	mm	lbs./1000'	kg/km	lbs.	N

Loose Tube Series

Plenum (NEC/CEC OFNP/OFN FT6)											
6	6	M9B202	M9A202	M9C202	M9W202	0.265	6.70	33	49	320	1423
12	12	M9B204	M9A204	M9C204	M9W204	0.265	6.70	33	49	320	1423
24	12	M9B205	M9A205	M9C205	M9W205	0.359	9.12	47	70	405	1801
36	12	M9B206	M9A206	M9C206	M9W206	0.359	9.12	47	70	405	1801
48	12	M9B207	M9A207	M9C207	M9W207	0.359	9.12	48	71	405	1801
72	12	M9B209	M9A209	M9C209	M9W209	0.429	10.90	71	106	585	2602
96	12	M9B211	M9A211	M9C211	M9W211	0.501	12.73	105	156	903	4017
144	12	M9B215	M9A215	M9C215	M9W215	0.665	16.89	189	281	1263	5618

Alternative fiber counts and hybrid constructions are available.