

Hand Surgery

Handchirurgie

Cirugía de la Mano

Chirurgia della Mano

Chirurgie de la Main



20.103.00
Fig. 3



20.103.02
Fig. 3L



20.104.00
Fig. 4



20.104.02
Fig. 4L



20.107.00
Fig. 7



20.290.09
Trousman.Chris
90 mm



20.291.11
110 mm



20.294.13
Castroviejo
130 mm

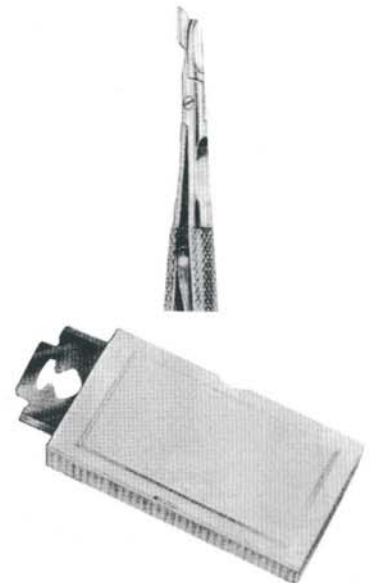

20.296.00
In packages of 10 Pcs



	Standard
22.102.10	105 mm
22.102.11	115 mm
22.102.13	130 mm
22.102.14	145 mm
22.102.15	155 mm
22.102.16	165 mm
22.102.18	185 mm
22.102.20	200 mm



	Standard
22.110.10	105 mm
22.110.11	115 mm
22.110.13	130 mm
22.110.14	145 mm
22.110.15	155 mm
22.110.16	165 mm
22.110.18	185 mm
22.110.20	200 mm



	Standard
22.120.10	105 mm
22.120.11	115 mm
22.120.13	130 mm
22.120.14	145 mm
22.120.15	155 mm
22.120.16	165 mm
22.120.18	185 mm
22.120.20	200 mm

DYNAMIC

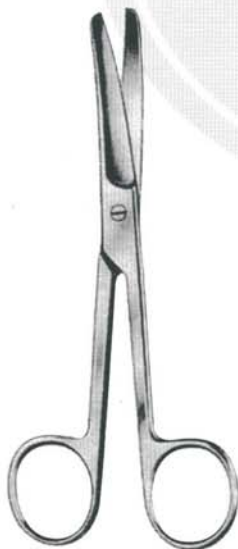

	Standard
22.103.11	115 mm
22.103.13	135 mm
22.103.14	145 mm
22.103.15	155 mm
22.103.16	165 mm
22.103.18	185 mm
22.103.20	200 mm



	Standard
22.111.11	115 mm
22.111.13	135 mm
22.111.14	145 mm
22.111.15	155 mm
22.111.16	165 mm
22.111.18	185 mm
22.111.20	200 mm



	Standard
22.121.11	115 mm
22.121.13	135 mm
22.121.14	145 mm
22.121.15	155 mm
22.121.16	165 mm
22.121.18	185 mm
22.121.20	200 mm



22.190.16 160 mm
22.190.21 210 mm
22.194.16 TC 160 mm
22.194.21 TC 210 mm



22.191.16 160 mm
22.191.21 210 mm
22.195.16 TC 160 mm
22.195.21 TC 210 mm



22.202.10 Lexer.Baby 100 mm straight
22.203.10 100 mm curved
22.206.10 TC 100 mm straight
22.207.10 TC 100 mm curved



Metzenbaum
22.280.15 150 mm
22.280.18 180 mm
22.280.20 200 mm
22.280.23 230 mm
22.280.25 250 mm
22.280.28 280 mm
22.280.30 300 mm
22.284.15 TC 150 mm
22.284.18 TC 180 mm
22.284.20 TC 200 mm
22.284.23 TC 230 mm
22.284.25 TC 250 mm
22.284.28 TC 280 mm
22.284.30 TC 300 mm



Metzenbaum
22.281.15 150 mm
22.281.18 180 mm
22.281.20 200 mm
22.281.23 230 mm
22.281.25 250 mm
22.281.28 280 mm
22.281.30 300 mm
22.285.15 TC 150 mm
22.285.18 TC 180 mm
22.285.20 TC 200 mm
22.285.23 TC 230 mm
22.285.25 TC 250 mm
22.285.28 TC 280 mm
22.285.30 TC 300 mm

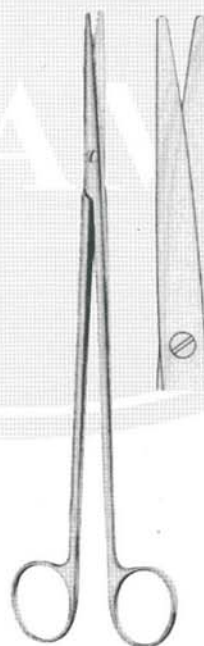

Metzenbaum Fino
22.282.15 150 mm
22.282.18 180 mm
22.282.20 200 mm
22.282.23 230 mm
22.286.15 TC 150 mm
22.286.18 TC 180 mm
22.286.20 TC 200 mm
22.286.23 TC 230 mm

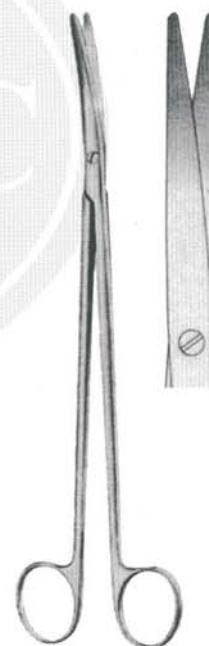

Metzenbaum Fino
22.280.15 150 mm
22.280.18 180 mm
22.280.20 200 mm
22.280.23 230 mm
22.284.15 TC 150 mm
22.284.18 TC 180 mm
22.284.20 TC 200 mm
22.284.23 TC 230 mm



22.291.18 Metzenbaum "S"
22.295.18 TC 180 mm
180 mm

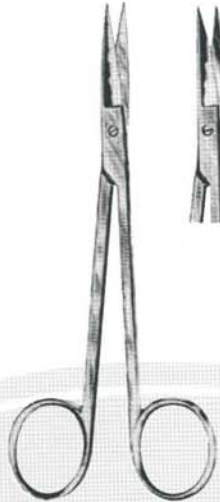

22.302.14 Sanvenero
22.303.14 straight
curved



22.304.14 Joseph
22.305.14 straight
curved

DYNAMIC



22.310.12 Kilner
22.310.15 120 mm
22.314.12 TC 150 mm
22.314.15 TC 120 mm
150 mm



22.320.14 Reynolds
22.321.14 straight
22.324.14 TC curved
22.326.14 TC straight
curved



22.340.09 90 mm, 110 mm
22.340.11 straight
22.341.09 straight
22.341.11 curved
22.344.11 TC curved
22.345.11 TC straight
curved



194-230-14 Lister
140 mm
194-230-18 180 mm
194-230-20 200 mm



194-223-23
Bergmann
230 mm



194-250-20 Esmarch
200 mm
194-250-22 220 mm



194-200-19
Excenter
190 mm



194-155-14
Knowles
140 mm



194-195-23
Lorenz
230 mm



194-122-20 Bruns, 230 mm
194-122-35 straight
serrated



194-130-21
Mod. Seutin
210 mm



194-255-15 Universal
150 mm
194-255-18 180 mm



22.971.11

22.972.11

Westcott, 110 mm

22.971.11 Westcott
22.972.11 Tenotomy Scissors, Pointed straight
Tenotomy Scissors, blunt curved



22.973.10

Castroviejo, 100 mm

22.973.10 Castroviejo
Corneal Scissors, slightly
curved, blunt

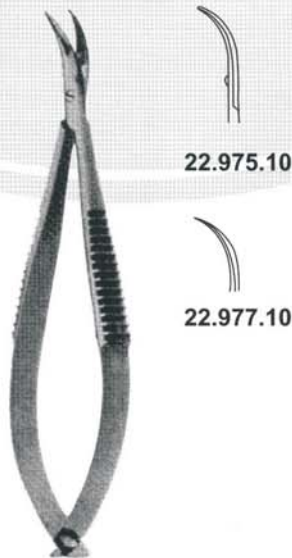

22.975.10

22.977.10

Castroviejo, 100 mm

22.975.10 Castroviejo
22.977.10 Corneal Scissors
Curved, blunt
Curved, sharp



24.170.12 Adson 120 mm
24.174.12 TC 120 mm
24.170.15 150 mm
24.174.15 TC 150 mm



24.176.12 Adson. Micro 120 mm



24.220.17 Cushing 170 mm



24.180.12 Adson 120 mm
24.180.15 150 mm



24.186.12 Adson 120 mm



24.188.12 Adson. Brown 120 mm



24.189.16 Brown 160 mm
24.189.20 200 mm
24.189.25 250 mm



24.190.10 Graefe 105 mm



24.230.17 Cushing 170 mm



Graefe
100 mm



24.411.10



24.413.10



24.420.10



24.421.10



24.423.10



Stevens
105 mm



24.431.10



24.433.10



24.440.10



24.441.10



24.443.10





24.802.09 90 mm
24.802.11 115 mm



24.810.07 75 mm
24.810.11 115 mm



24.812.10
Hunter
105 mm



24.813.10
Hunter
105 mm



24.815.12
125 mm

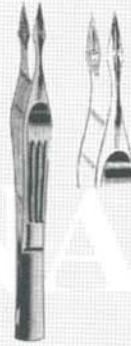

24.816.10
Carmalt
105 mm



24.817.10
Carmalt
105 mm



24.821.11
Peet
115 mm

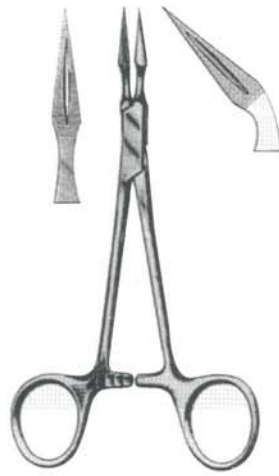

24.822.13 Stiegletz 135 mm
24.823.13 straight
curved



24.824.14 Archer 140 mm
24.825.14 straight
curved



24.828.15
Archer (Ralk)
150 mm



Halstead Mosquito

- | | |
|-----------|----------|
| | straight |
| 26.220.12 | 125 mm |
| 26.220.14 | 150 mm |
| 26.220.18 | 180 mm |
| 26.220.21 | 210 mm |

- | | |
|-----------|--------|
| | curved |
| 26.221.12 | 125 mm |
| 26.221.14 | 150 mm |
| 26.221.18 | 180 mm |
| 26.221.21 | 210 mm |



Halstead Mosquito Micro

- | | |
|-----------|-----------------|
| 26.222.12 | 125 mm straight |
| 26.223.12 | 125 mm curved |



Halstead Mosquito Toothed

- | | |
|-----------|----------|
| | straight |
| 26.230.12 | 125 mm |
| 26.230.14 | 150 mm |
| 26.230.18 | 180 mm |
| 26.230.21 | 210 mm |

- | | |
|-----------|--------|
| | curved |
| 26.231.12 | 125 mm |
| 26.231.14 | 150 mm |
| 26.231.18 | 180 mm |
| 26.231.21 | 210 mm |



Halstead Mosquito Micro Toothed

- | | |
|-----------|-----------------|
| 26.232.12 | 125 mm straight |
| 26.233.12 | 125 mm curved |

DYNAMIC



Clips de serviettes de bain / pinces à pansement



28.101.09
Schaedel, 90 mm



28.103.09
Jones, 90 mm



28.105.09
Jones-Clip 90 mm



28.111.09 Backhaus
90 mm
28.111.11 110 mm
28.111.13 130 mm
28.111.15 150 mm



28.115.11
Backhaus-Clip
110 mm

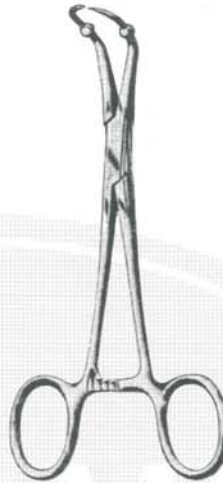

28.117.13
Roeder
130 mm



28.121.11 Lorna
110 mm
28.121.13 130 mm



30.110.20 Gross-Maier
200 mm straight
30.110.25 250 mm straight
30.111.20 130 mm curved
30.111.25 150 mm curved



30.160.20 Ulrich
200 mm straight
30.160.25 250 mm straight

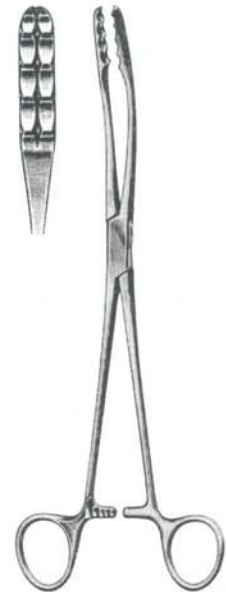

30.161.20 Ulrich
200 mm curved
30.161.25 250 mm curved



32.102.12
Farabeuf
120 mm



32.102.15
Farabeuf
150 mm



32.110.13
Parker
135 mm



32.110.18
Parker
180 mm

DYNAMIC

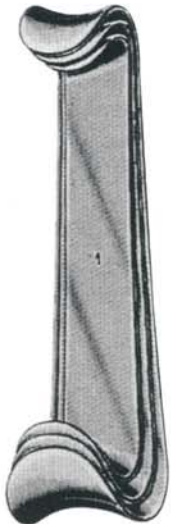

Fig. 1 = 24 mm x 20 mm
Fig. 2 = 29 mm x 26 mm
Fig. 3 = 35 mm x 39 mm

Fig. 1 = 30 mm x 28 mm
Fig. 2 = 36 mm x 36 mm
Fig. 3 = 38 mm x 43 mm

32.120.00	Roux	Fig.
32.120.14	140 mm	1
32.120.15	150 mm	2
32.120.17	170 mm	3



32.122.13
Roux Baby
130 mm



32.124.15
Roux Mini
150 mm



32.127.11
Crile
115 mm

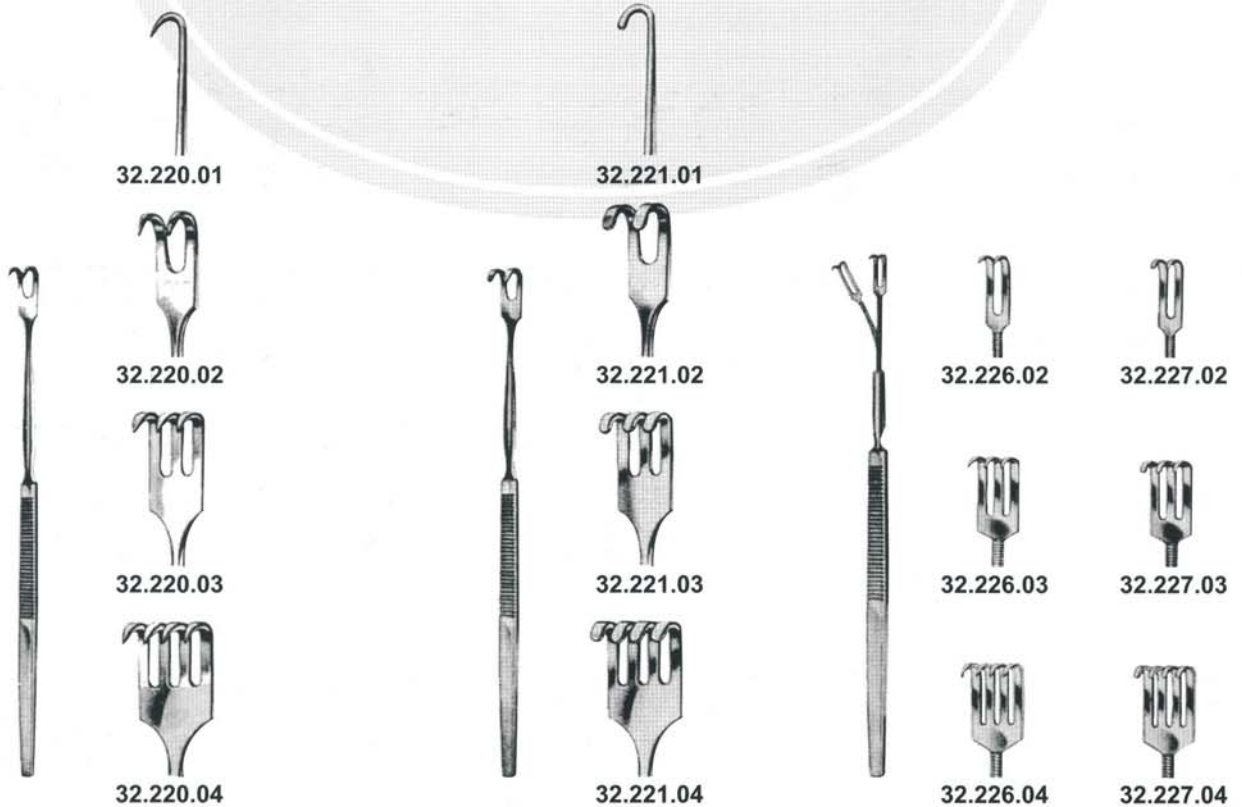
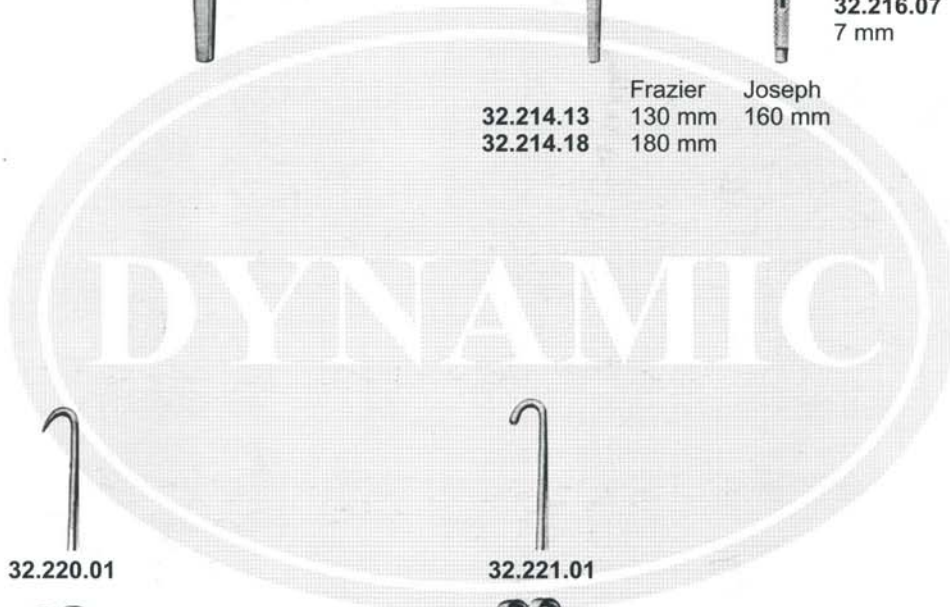
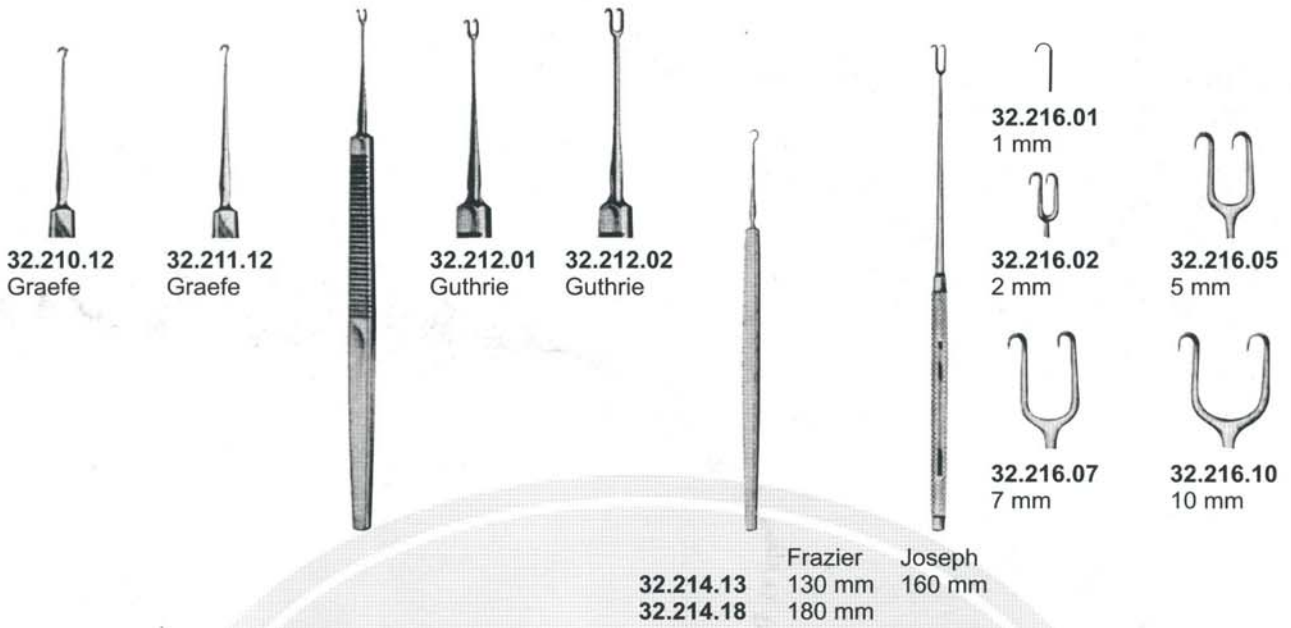

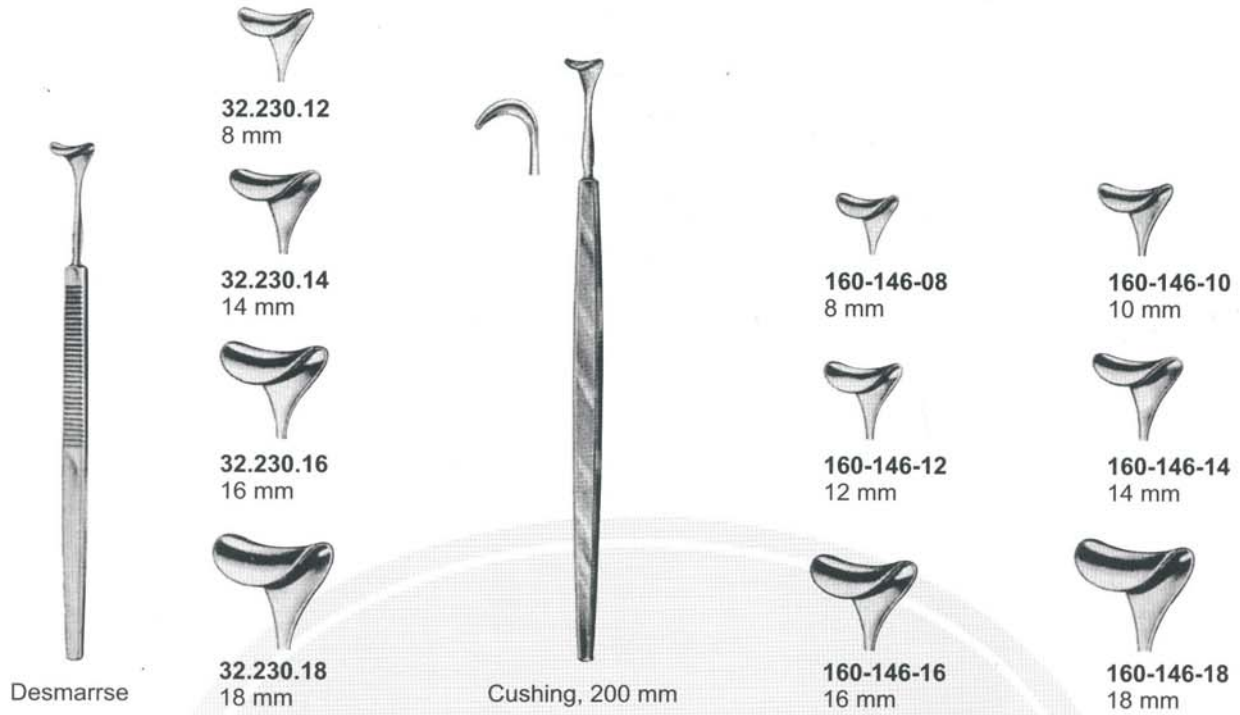

DYNAMIC

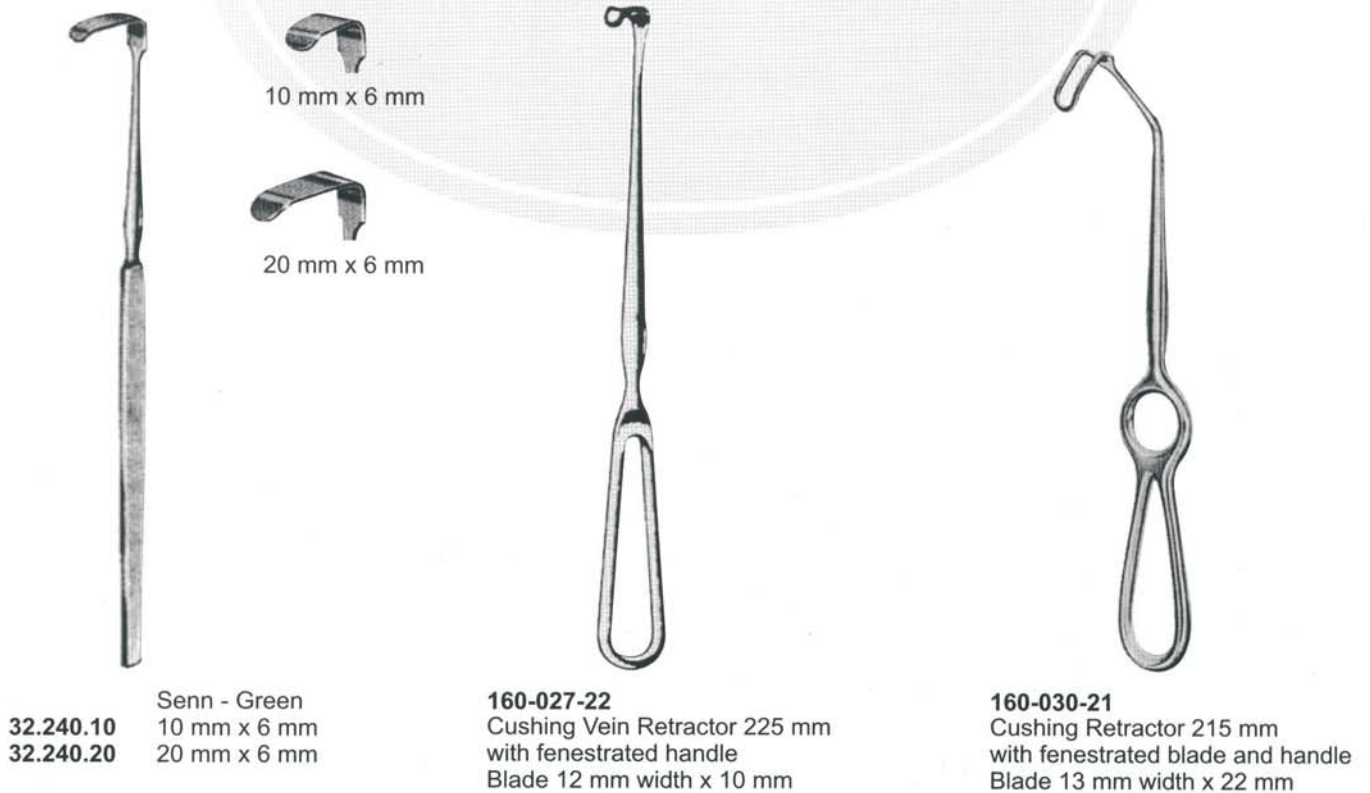



Volkmann 215 mm

Sharp

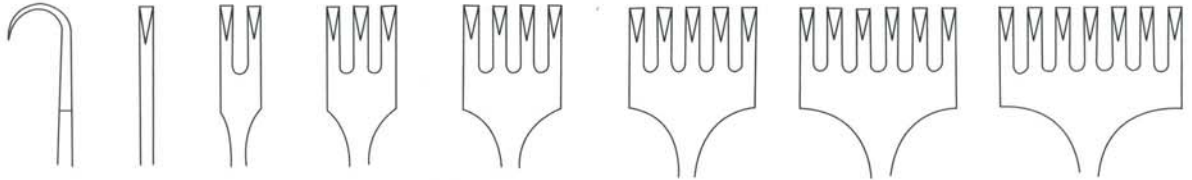

100-408-01 100-408-02 100-408-03 100-408-04 100-408-05 100-408-06 100-408-07

Blunt

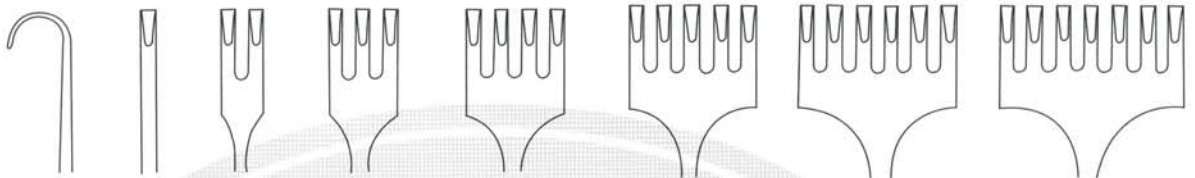

100-409-01 100-409-02 100-409-03 100-409-04 100-409-05 100-409-06 100-409-07

DYNAMIC



160-154-01
18 mm x 7 mm



160-154-02
16 mm x 5 mm



160-154-03
7 mm x 4 mm



160-154-04
7 mm x 4 mm



160-154-05
10 mm x 3 mm



160-154-06
10 mm x 4 mm



Meyerding, 180 mm

28 mm x 6 mm



32.304.19
Lahey, 190 mm

7 mm x 18 mm



160-306-19
Little, 190 mm

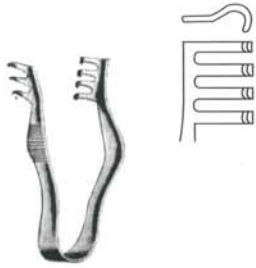

32.900.07 Finsen, 70 mm
sharp
32.902.07 blunt

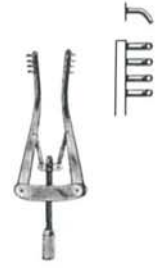

32.904.07 ALM
sharp
70 mm
32.906.10 100 mm
blunt
32.908.07 70 mm
32.910.10 100 mm



32.912.10
Jansen
100 mm



32.914.10
Jansen
100 mm



32.916.10 100 mm
sharp
32.928.10 blunt



Weitlaner, 115 mm
32.920.10 sharp
32.922.10 blunt

< 50 mm >

15 mm
18 mm

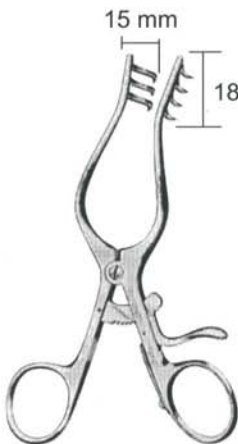

Weitlaner-Wullstein
32.930.13 sharp
32.932.13 blunt



32.934.11
Plester
110 mm

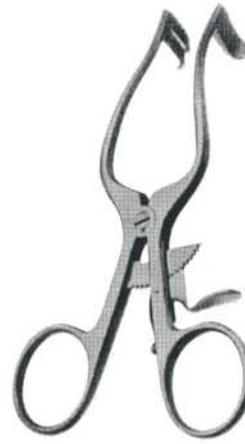

32.936.11
Plester
110 mm



Weitlaner
blunt
100-940-04 sharp
100-942-04 3 x 4 prong



160-122-13
Cloward, 130 mm

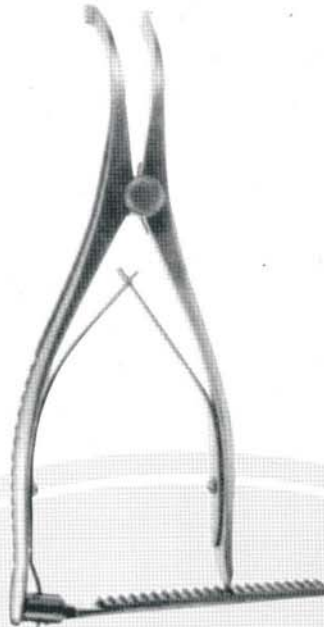

160-125-16
Inge, 160 mm



160-125-05 Inge, 260 mm
Jaw width 5 mm
160-125-10 Inge, 260 mm
Jaw width 10 mm



160-062-13 Gelpi
135 mm
160-062-17 Gelpi
170 mm
sharp



100-481-09 Weitlaner
165 mm
sharp
3 x 4 prongs 16 mm deep



160-080-13 Beckmann-Weitlaner
160 mm
sharp
3 x 4 prongs 13 mm deep



Derf
34.110.12 120 mm
34.114.12 TC 120 mm



Derf
34.120.12
125 mm



Collier
34.122.12
125 mm



Halsey
34.130.13 34.140.13
34.134.13 TC 34.144.13 TC



Neivert
34.146.14



Baumgartner
34.150.12 125 mm
34.150.14 140 mm
34.154.12 TC 125 mm
34.154.14 TC 140 mm



Crile-Wood

34.160.15	150 mm	34.164.15 TC	150 mm
34.160.18	180 mm	34.164.18 TC	180 mm
34.160.20	200 mm	34.164.20 TC	200 mm



Crile-Murray

34.170.15	150 mm
34.174.15 TC	150 mm



Mayo-Hegar

34.180.14	140 mm	34.184.14 TC	140 mm
34.180.16	160 mm	34.184.16 TC	160 mm
34.180.18	180 mm	34.184.18 TC	180 mm
34.180.20	200 mm	34.184.20 TC	200 mm
34.180.24	240 mm	34.184.24 TC	240 mm
34.180.26	260 mm	34.184.26 TC	260 mm
34.180.30	300 mm	34.184.30 TC	300 mm



Mayo-Hegar

34.190.16	160 mm	34.194.16 TC	160 mm
34.190.18	180 mm	34.194.18 TC	180 mm
34.190.20	200 mm	34.194.20 TC	200 mm



34.691.14 Castroviejo, 140 mm



34.692.14 Castroviejo, 140 mm



34.693.14 Castroviejo, 140 mm



34.694.14 Castroviejo, 140 mm



Deschamps, left
36.110.21 210 mm
36.110.24 240 mm
36.110.27 270 mm



Deschamps, right
36.111.21 210 mm
36.111.24 240 mm
36.111.27 270 mm



Deschamps, left
36.120.21 210 mm
36.120.24 240 mm
36.120.27 270 mm



Deschamps, right
36.121.21 210 mm
36.121.24 240 mm
36.121.27 270 mm



36.130.13
 Kronecker, left
 130 mm



36.131.13
 Kronecker, right
 130 mm



Nelson, 245 mm
36.133.24 right
36.135.24 left



36.139.19
 Cooper
 190 mm



Ø 2 mm
38.102.11 105 mm
38.102.13 115 mm
38.102.14 145 mm
38.102.16 160 mm
38.102.18 180 mm
38.102.20 200 mm
38.102.25 250 mm



Ø 1 mm
38.104.11 105 mm
38.104.13 115 mm
38.104.14 145 mm
38.104.16 160 mm
38.104.18 180 mm
38.104.20 200 mm
38.104.25 250 mm



Ø 2 mm
38.106.11 105 mm
38.106.13 115 mm
38.106.14 145 mm
38.106.16 160 mm
38.106.18 180 mm
38.106.20 200 mm
38.106.25 250 mm



38.108.14
145 mm



38.110.13 130 mm
38.110.14 145 mm
38.110.16 160 mm
38.110.18 180 mm
38.110.20 200 mm
38.110.25 250 mm



38.111.14
Doyen, 130 mm



38.112.14
Doyen, 140 mm



38.115.10
Stacke, 105 mm

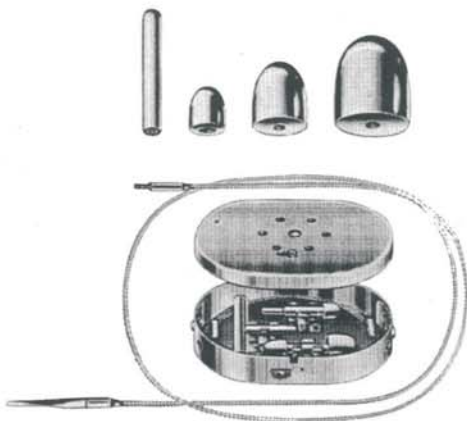

38.150.00 Nabatoff
135 x 100 x 25 mm
compl.

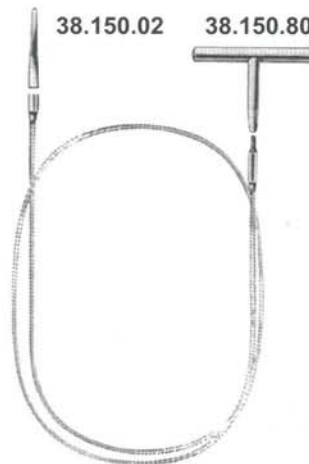

38.150.90

Varicose - vein probe set



38.150.02 **38.150.80**
38.150.03 Ø 3 mm

38.150.06 Ø 6 mm

38.150.09 Ø 9 mm

38.150.12 Ø 12 mm

38.150.15 Ø 15 mm



Indications :

- Fractures of the shaft, simple or comminuted
- Intraarticular fractures
- Compound fractures
- Trauma or tumor -related bone defects of the carpus, metacarpus or phalanges
- Arthodesis
- Distraction osteogenesis (i.e lengthening of the thumb)
- Metacarpal segment transport
- Callotaxis lengthening of the capitate after resection of the lunate bone (for treatment of Kienbock's disease, stage iii)

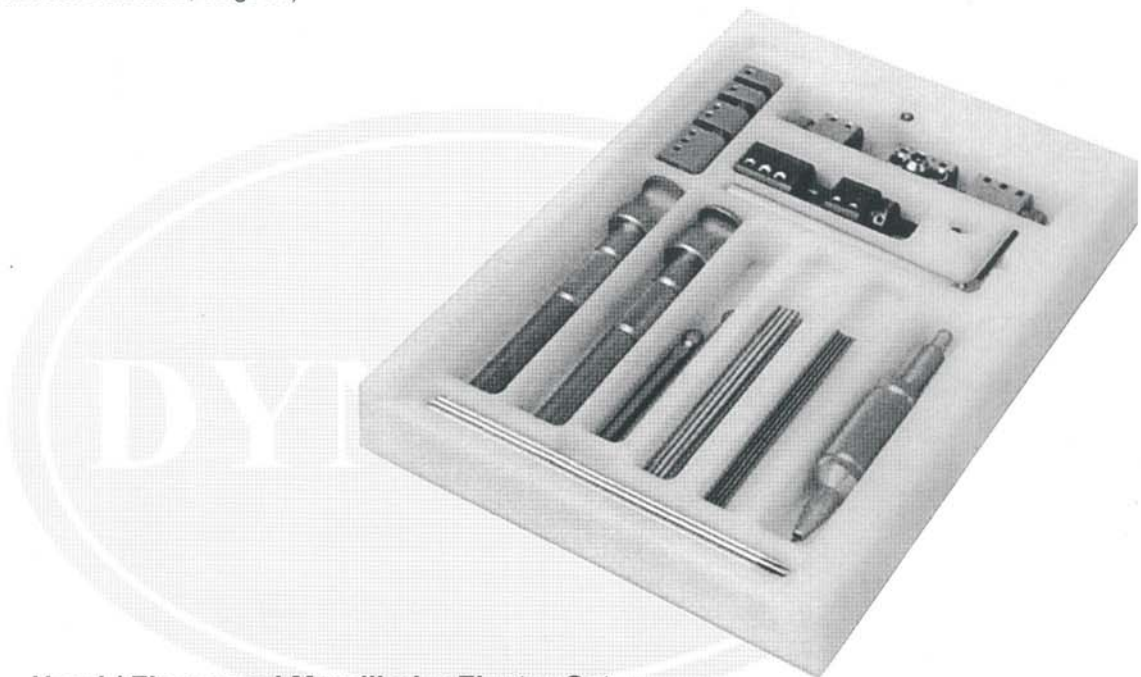

D-150-01 Hand / Finger and Mandibular Fixator Set

150-005-01	Mini Ex. Fix type I	1
150-005-02	Mini Ex. Fix type II	1
150-005-03	Mini Ex. Fix type III	1
150-035-00	Teflon Steri Box	6
150-010-40	Threaded Rod 40 mm	2
150-010-50	Threaded Rod 50 mm	2
150-010-60	Threaded Rod 60 mm	2
150-007-60	Fixation Screws	2
150-025-15	Allen Key 1.5 mm	4
150-025-40	Allen Key 4.0 mm	4
150-028-01	Screw Driver	5
150-030-11	Holding Lever small	5
150-030-15	Holding Lever wide	5
150-012-18	Kirschner Wire Ø 1.8 mm 70 mm long, thread 30 mm	3
150-012-16	Kirschner Wire Ø 1.6 mm 70 mm long, thread 30 mm	3



150-005-01 Mini Ex. Fix type I



150-010-40 Threaded rod 40 mm



150-005-02 Mini Ex. Fix type II



150-010-50 Threaded rod 50 mm



150-005-03 Mini Ex. Fix type III



150-010-60 Threaded rod 60 mm

K. Wire threaded with trocar point, round end.

Cat. No.:	Diameter	Length	Thread Length
150-012-10	1.0 mm	70 mm	30 mm
150-012-16	1.6 mm	70 mm	30 mm
150-012-18	1.8 mm	70 mm	30 mm

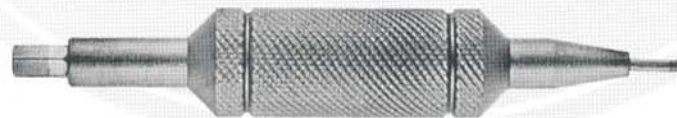

150-028-01 Screwdriver



150-030-11 Holding Lever small



150-030-15 Holding Lever wide

**DYNAMIC
INSTRUMENTS**

**Nail Splitters / Ingrown Forceps
Nagel Splitter / Eingewachsene Zange
Uñas Divisores / Encarnado Fórceps
Chiodo Splitters Incarnito Forcipe
Ongles Splitters / Incarné Forceps**

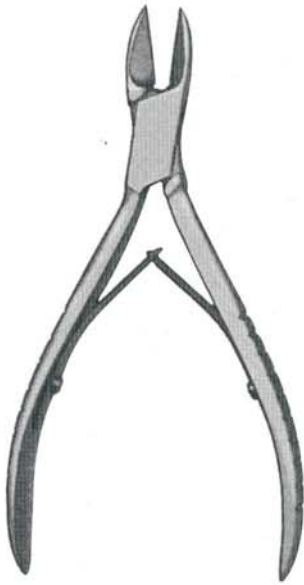

Nail Splitter

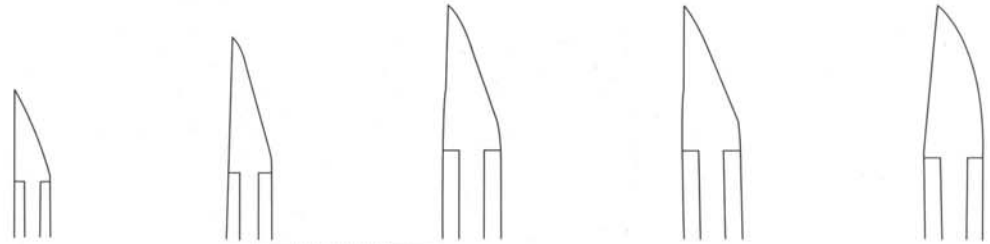
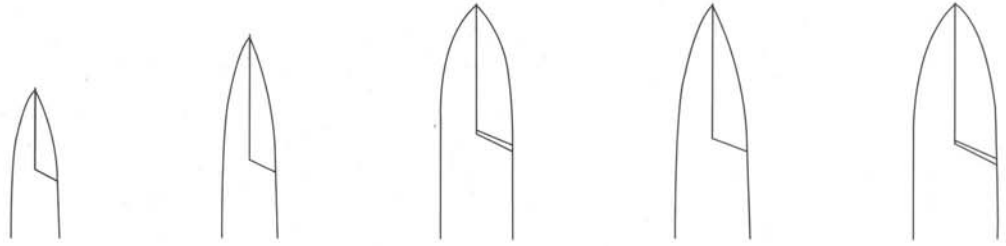

150-052-10
100 mm
Stainless

150-052-11
115 mm
Stainless

150-052-12
125 mm heavy jaw
Stainless

150-052-14
125 mm narrow jaw
Stainless

150-052-15
150 mm
Stainless

DYNAMIC

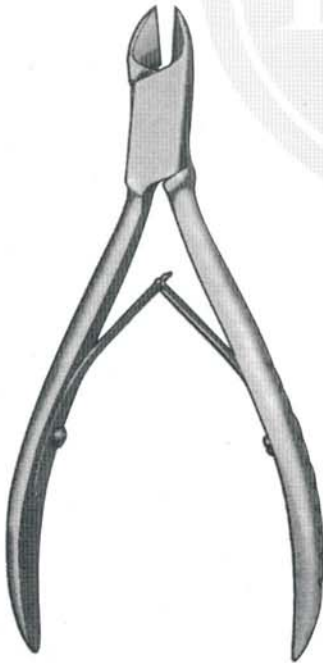

150-054-12 P.I. Short jaw
125 mm Nail Splitter
150-054-15 150 mm
stainless

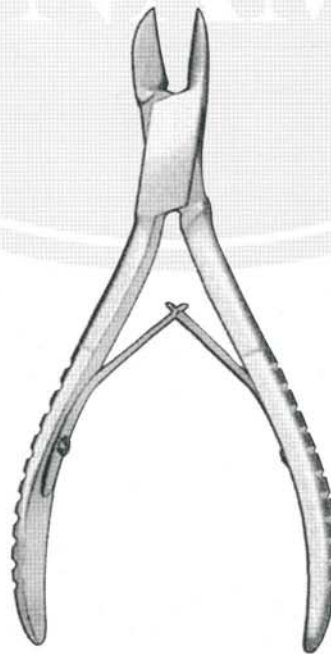

150-055-14
Nail Splitter
140 mm
stainless

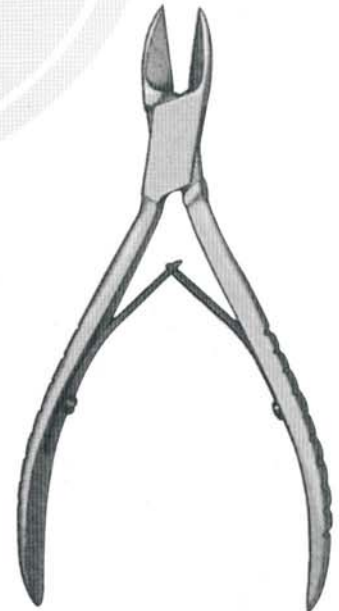

150-058-10 Nail Splitter
100 mm
150-058-11 115 mm
tapered, stainless

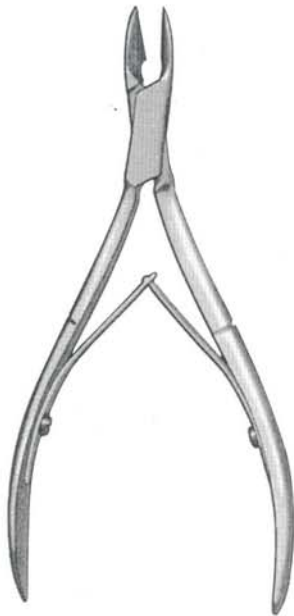

Nail Splitter



150-064-06
100 mm, 6 mm
stainless



150-064-09
100 mm, 9 mm
stainless



150-064-11
115 mm, 11 mm
stainless



150-064-14
125 mm, 14 mm
stainless



Nail Nipper 140 mm
angled concave
150-066-01 sharp end
150-066-02 blunt end

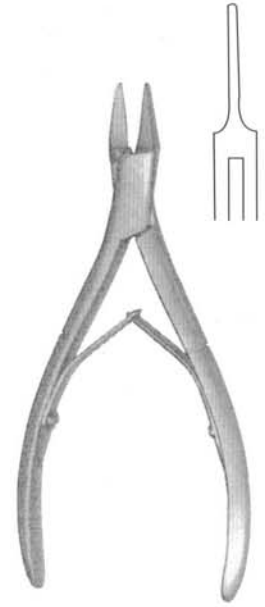

150-067-12
Ingrown Nail Forceps
125 mm
narrow blade stainless



150-069-14
Mycotic Nail Nipper
140 mm
stainless

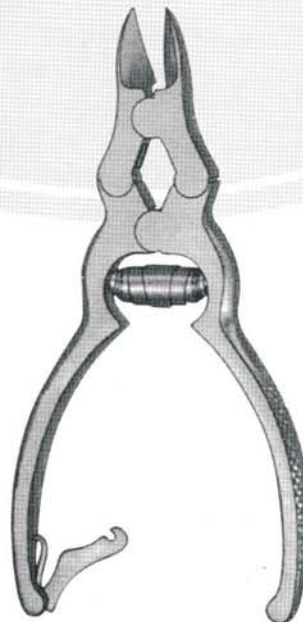

150-072-15
Mycotic Nail Nipper
150 mm, heavy
stainless
double action
barrel spring



150-075-06
Cuticle Nipper
100 mm, 6 mm
ring handle

**DYNAMIC
INSTRUMENTS**

Lead Hands, Finger Ring Saw & Instruments
Lead Hands, Fingerring Saw & Instrumente
Manos de plomo, Anillo de sierra y instrumentos
Mani di piombo, Ring Finger Saw & STRUMENTI
Mains plomb, Ring Finger Saw & instruments



150-080-01 Child Size
 150-080-02 Adult Size

150-085-00 Ringer ring saw
 150-085-02 150 mm spore blade



150-087-14 Radolf, 140 mm
 Nial extracting forceps



150-089-02 Nial extracting forceps
 145 mm



150-092-00 Finger nail drill with 3 drill points



150-092-01 Drill points small



150-092-02 Medium



150-092-03 large

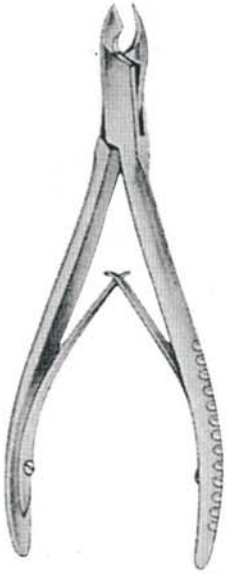

102-001-12 120 mm

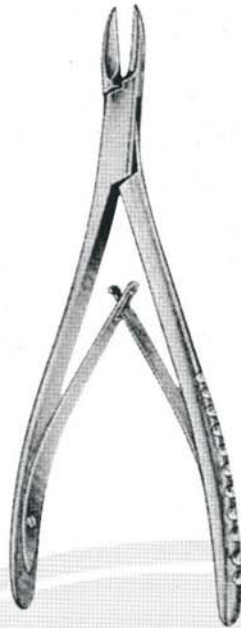

102-003-15 Littauer-Liston, 150 mm

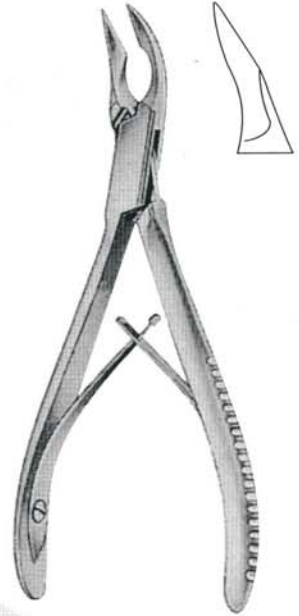

102-005-15 Cleveland, 150 mm

DYNAMIC

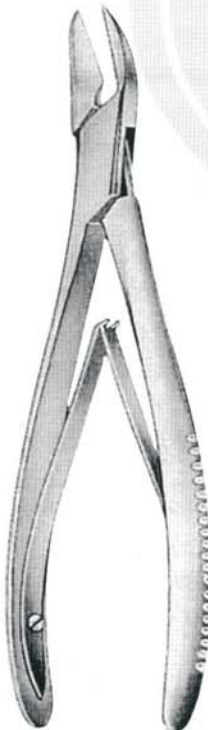

102-006-17 Cleveland, 170 mm

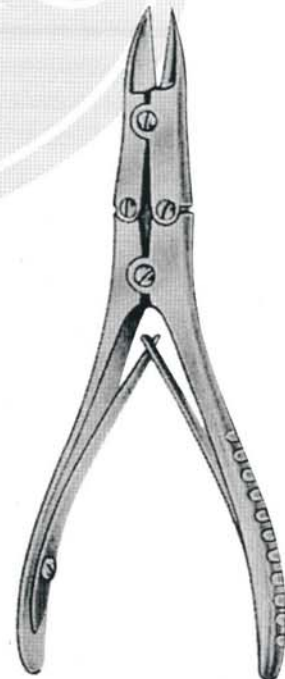

Walton-Liston
102-008-01 straight
102-008-02 curved



102-063-17 Schuardt, 170 mm

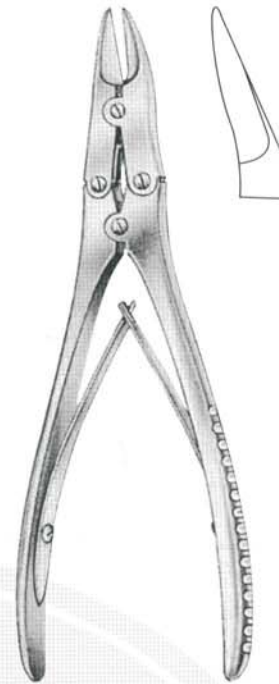

102-078-17 McIndoe, 175 mm



102-025-19 Ruskin-Liston 190 mm straight
102-026-19 Ruskin-Liston 190 mm curved



Liston Bone Cutting Forceps
120-010-14 140 mm Straight
120-010-17 170 mm Straight
120-010-19 190 mm Straight
120-010-22 220 mm Straight

120-011-14 140 mm curved
120-011-17 170 mm curved
120-011-19 190 mm curved
120-011-22 220 mm curved

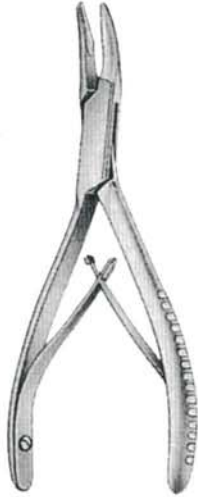

Friedman

102-175-12 120 mm
102-175-14 140 mm

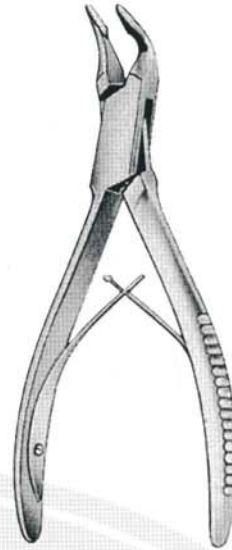

Blumenthal

102-178-15 155 mm
102-178-45 145 mm
102-178-90 190 mm



102-178-15
4 x 11



102-178-45
4 x 11



102-178-90
4 x 11

DYNAMIC

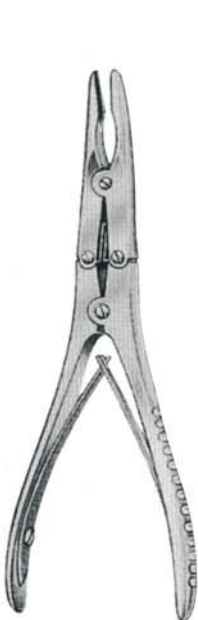

Kleinert-Kutz
150 mm

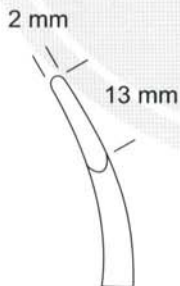

102-181-02

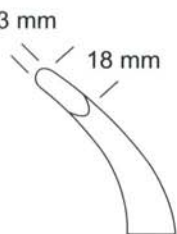

102-181-03

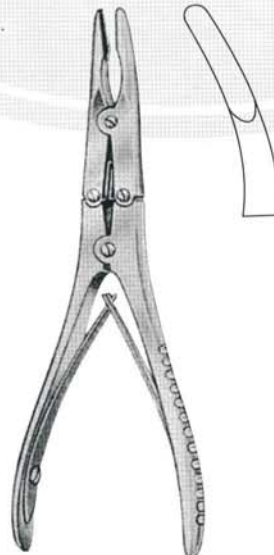

102-230-15
Ruskin-Mini
150 mm

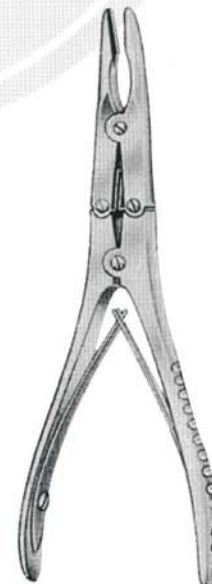

102-225-15 Bohler Rongeur 150 mm straight
102-226-15 Bohler Rongeur 150 mm curved

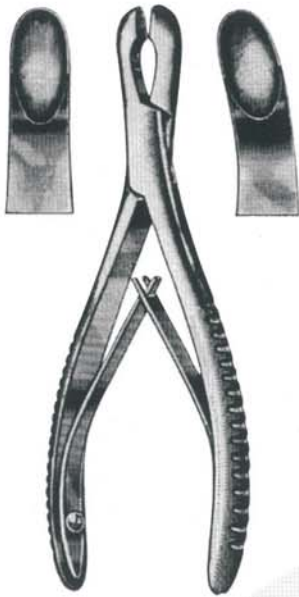

102-207-17 Luer 170 mm straight
102-208-17 Luer 170 mm curved



102-215-19 Lempert 190 mm straight
102-216-19 Lempert 190 mm curved
102-215-16 Lempert 160 mm straight
102-216-16 Lempert 160 mm curved

DYNAMIC



102-219-03 Beyer, 180 mm

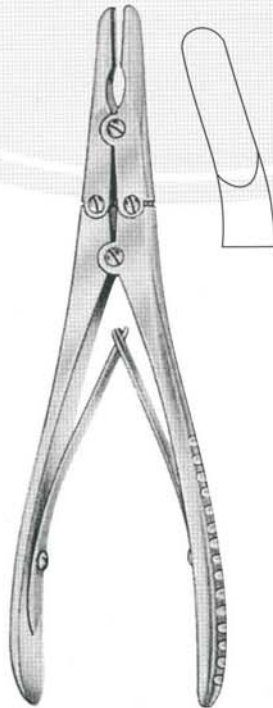

102-231-07 Ruskin, 180 mm

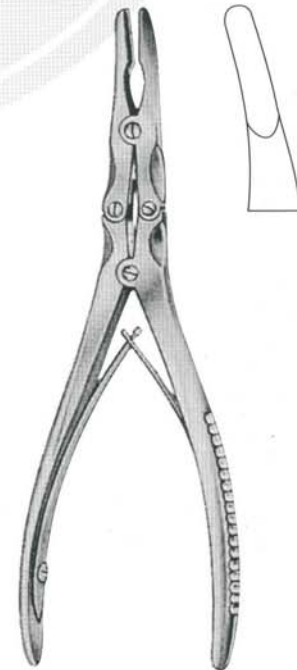

102-235-19 Zaufal-Jansen, 190 mm



100-725-14
Medium straight blade
round edge, width 14 mm



100-727-14
Medium curved blade
round edge, width 14 mm

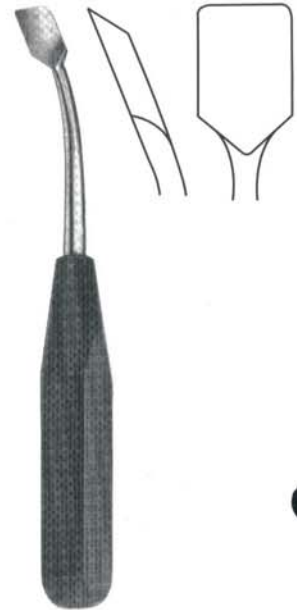

100-728-14
Medium Blade
Straight Edge, 14 mm

100-729-14
Straight 185 mm
Curved 185 mm

DYNAMIC



100-732-14
large straight blade
round edge, width 20 mm



100-735-06
Small curved blade
round edge, width 6 mm



100-740-06
Small curved blade
straight edge, width 6 mm



100-742-03
Extra small curved blade
round edge, width 3 mm



160-228-18
Freer Elevator
185 mm double ended
5 mm sharp / blunt end



Hoehn

7 mm



160-271-07
160 mm

15 mm



160-271-15
190 mm

20 mm

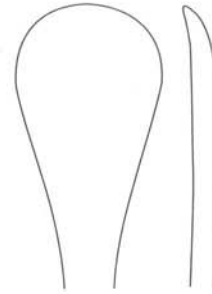

160-271-20
200 mm



100-756-13 Williger, 130 mm



100-757-16 Williger, 160 mm

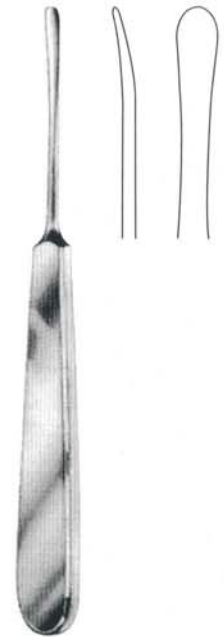

160-215-17 Sebileau, 175 mm

DYNAMIC



150-210-01

150-210-02

150-210-03

Williger
135 mm



150-218-01

150-218-02

150-218-03

Martini
135 mm



150-222-16
Jansen, 160 mm

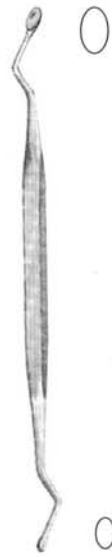

150-223-15
Jansen, 150 mm

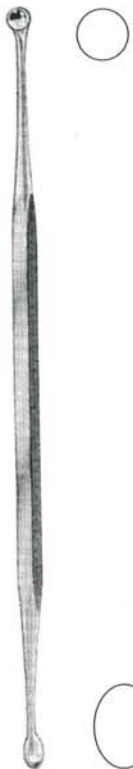
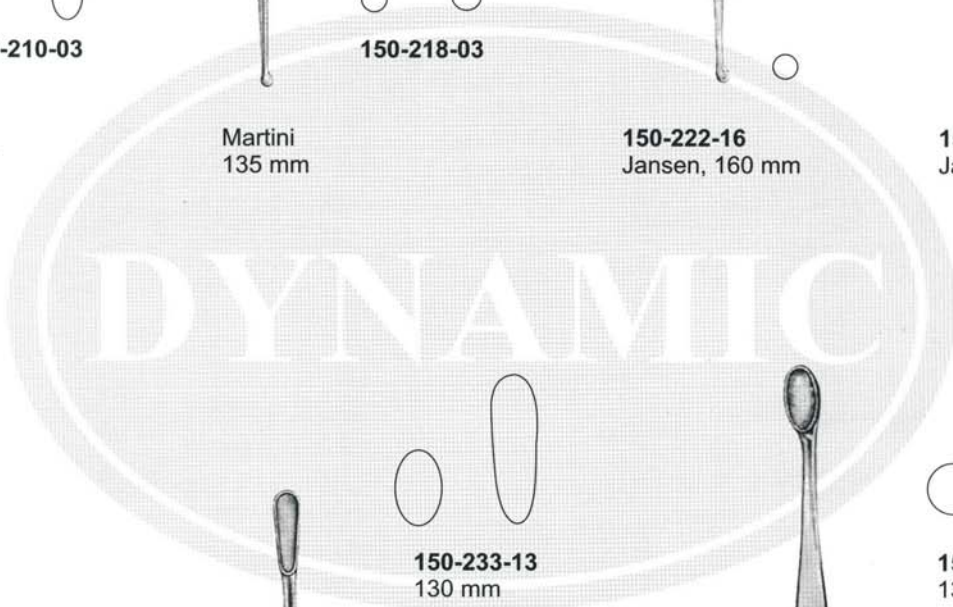

150-228-21
210 mm



Volkmann

150-233-13
130 mm

150-233-14
140 mm

150-233-17
170 mm



Volkmann

150-238-13
130 mm

150-238-16
160 mm

150-238-20
200 mm

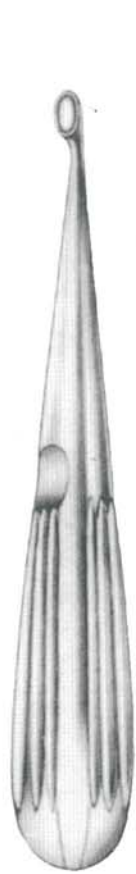

Spratt

Fig. 0000
100-801-40

Fig. 000
100-801-30

Fig. 00
100-801-20

Fig. 0
100-801-10

Fig. 1
100-801-01

Fig. 2
100-801-02

Fig. 3
100-801-03

Fig. 4
100-801-04

Fig. 5
100-801-05



Bruns

Fig. 0000
100-804-40

Fig. 000
100-804-30

Fig. 00
100-804-20

Fig. 0
100-804-10

Fig. 1
100-804-01

Fig. 2
100-804-02

Fig. 3
100-804-03

Fig. 4
100-804-04

Fig. 5
100-804-05

Fig. 6
100-804-06



Fiber Handle 270 mm

Fig. 0
100-825-10

Fig. 1
100-825-01

Fig. 2
100-825-02

Fig. 3
100-825-03

100-830-00
Straight

100-830-03
Down Angle

100-830-04
Up Angle



Scoville 250 mm

DYNAMIC

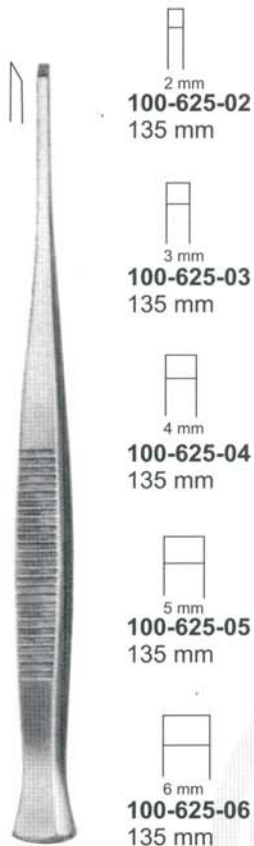

Partsch

2 mm
100-625-02
135 mm

3 mm
100-625-03
135 mm

4 mm
100-625-04
135 mm

5 mm
100-625-05
135 mm

6 mm
100-625-06
135 mm

2 mm
100-626-02
170 mm

3 mm
100-626-03
170 mm

4 mm
100-626-04
170 mm

5 mm
100-626-05
170 mm

6 mm
100-626-06
170 mm



Alexander 180 mm

4 mm
100-628-04

10 mm
100-628-10

6 mm
100-628-06

12 mm
100-628-12

8 mm
100-628-08

14 mm
100-628-14



Hibbs Chisel
stainless steel handle

225 mm straight
160-350-06 6 mm
160-350-09 9 mm
160-350-12 12 mm
160-350-15 15 mm
160-350-18 18 mm
160-350-20 20 mm
160-350-25 25 mm
160-350-30 30 mm
160-350-35 35 mm
160-350-40 40 mm

225 mm curved
160-351-06 6 mm
160-351-09 9 mm
160-351-12 12 mm
160-351-15 15 mm
160-351-18 18 mm
160-351-20 20 mm
160-351-25 25 mm
160-351-30 30 mm
160-351-35 35 mm
160-351-40 40 mm



Stille

100-635-10
100-635-12
100-635-15
100-635-20
100-635-25

Chisels
10 mm
12 mm
15 mm
20 mm
25 mm

100-636-10
100-636-12
100-636-15
100-636-20
100-636-25

Osteotome
10 mm
12 mm
15 mm
20 mm
25 mm



100-640-02 170 mm length 2 mm width
100-640-05 170 mm length 5 mm width
100-640-10 170 mm length 10 mm width

Mini- Lambotte



Lambotte

100-642-10 Straight 10 mm
100-642-15 Straight 15 mm
100-642-20 Straight 20 mm
100-642-25 Straight 25 mm
100-642-30 Straight 30 mm
100-642-38 Straight 38 mm
100-642-44 Straight 44 mm
100-642-50 Straight 50 mm

100-643-10 Curved 10 mm
100-643-15 Curved 15 mm
100-643-20 Curved 20 mm
100-643-25 Curved 25 mm
100-643-30 Curved 30 mm
100-643-38 Curved 38 mm
100-643-44 Curved 44 mm
100-643-50 Curved 50 mm



100-650-00
Chisel Handle



- 100-650-05** Chisel Blade 5 mm
- 100-650-10** Chisel Blade 10 mm
- 100-650-16** Chisel Blade 16 mm
- 100-650-25** Chisel Blade 25 mm

- 100-651-05** Osteotome Blade 5 mm
- 100-651-10** Osteotome Blade 10 mm
- 100-651-16** Osteotome Blade 16 mm
- 100-651-25** Osteotome Blade 25 mm

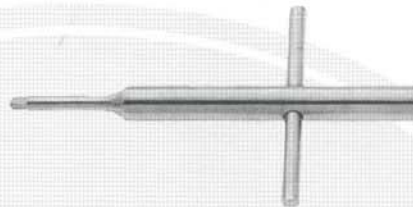

100-650-40
Wrench for Chisel Handle



- 100-656-10** Flat 10 mm
- 100-656-15** Flat 15 mm
- 100-656-20** Flat 20 mm
- 100-656-25** Flat 25 mm



- 100-657-10** Hollow 10 mm
- 100-657-15** Hollow 15 mm
- 100-657-20** Hollow 20 mm
- 100-657-25** Hollow 25 mm



100-661-18
Mini Lexer 180 mm



100-662-18
Mini Lexer 180 mm Hollow

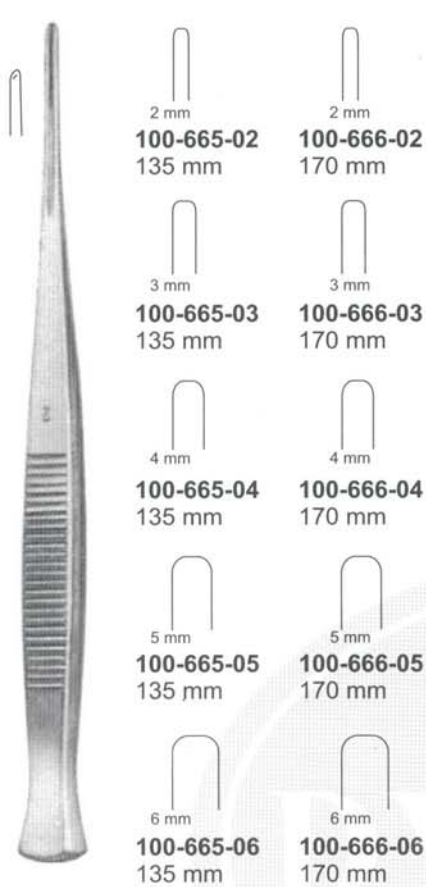

Parsch

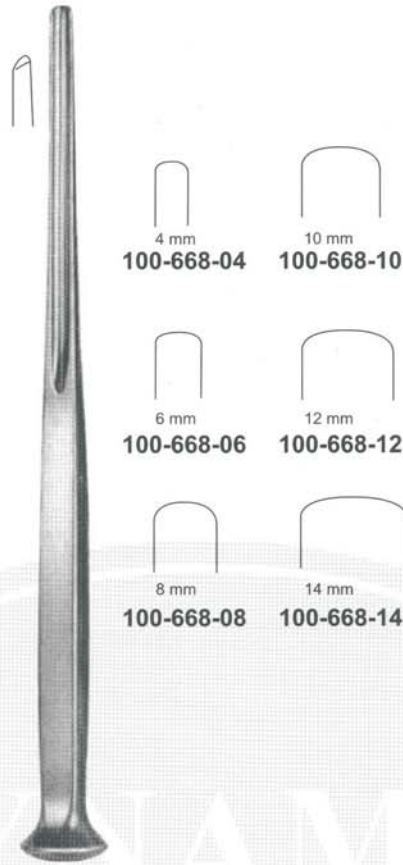

Alexander



- 225 mm straight
- 160-370-06** 6 mm
 - 160-370-09** 9 mm
 - 160-370-12** 12 mm
 - 160-370-15** 15 mm
 - 160-370-18** 18 mm
 - 160-370-20** 20 mm
 - 160-370-25** 25 mm
 - 160-370-30** 30 mm
 - 160-370-35** 35 mm
 - 160-370-40** 40 mm

- 225 mm curved
- 160-371-06** 6 mm
 - 160-371-09** 9 mm
 - 160-371-12** 12 mm
 - 160-371-15** 15 mm
 - 160-371-18** 18 mm
 - 160-371-20** 20 mm
 - 160-371-25** 25 mm
 - 160-371-30** 30 mm
 - 160-371-35** 35 mm
 - 160-371-40** 40 mm

Hibbs, 24 cm
stainless steel handle



Stille

- 100-675-10** Straight 10 mm
- 100-675-12** Straight 12 mm
- 100-675-15** Straight 15 mm
- 100-675-20** Straight 20 mm
- 100-675-25** Straight 25 mm

- 100-676-10** Curved 10 mm
- 100-676-12** Curved 12 mm
- 100-676-15** Curved 15 mm
- 100-676-20** Curved 20 mm
- 100-676-25** Curved 25 mm



- 100-680-05** Straight 5 mm
- 100-680-10** 10 mm
- 100-680-15** 15 mm



- 100-681-05** Curved 5 mm
- 100-681-10** 10 mm
- 100-681-15** 15 mm

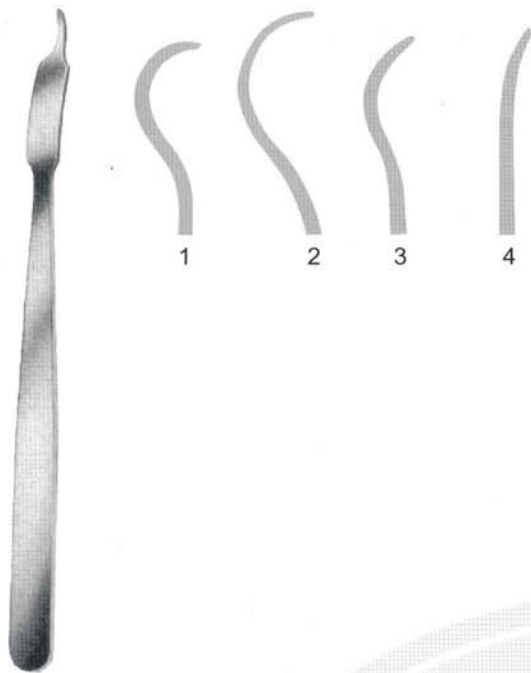

Fig. 1 100-352-06
Fig. 2 100-352-10
Fig. 3 100-352-45
Fig. 4 100-352-50

Periosteal Elevator 175 mm
For Metacarpals Small
6 mm width
For Metacarpals Medium
10 mm width
Light Curve, Rounded End,
5 mm width
Contra Angled Curve
4.5 mm width

100-358-06
Small, width 6 mm
short, narrow tip

100-360-08
Small, width 8 mm
short, narrow tip

100-364-15
For Small Fragments
Board Shank



100-368-08
Width 8 mm
short, narrow tip

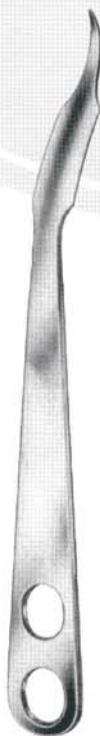

100-374-18 Width 18 mm short,
narrow tip
100-376-18 Width 18 mm long,
narrow tip

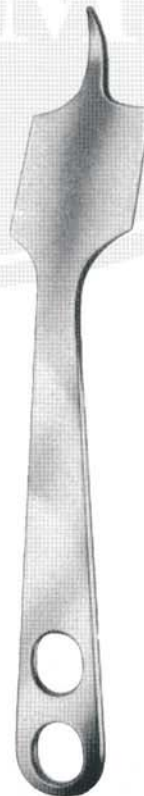

100-376-43 Width 43 mm
narrow tip
100-376-70 Width 70 mm
narrow tip



100-378-43
Width 43 mm
long shank, angled



100-215-15 Self-Centering Bone Holding Forceps with Thread Lock
For small fragments 150 mm, jaw 9 mm
100-215-19 Size 0, 190 mm, extra small jaw 10 mm
100-215-24 Size 1, 240 mm, extra small jaw 14 mm



100-182-16 Kern 160 mm with ratchet
100-182-21 210 mm with ratchet
100-183-16 160 mm without ratchet
100-183-21 210 mm without ratchet



100-200-14 Verbrügge Bone Holding Forceps 175 mm



100-298-16 Reduction Forceps with Thread Lock 160 mm



100-220-19
Ulrich
Straight 190 mm



100-240-20 Semb 200 mm
100-240-30 Semb 200 mm



100-278-13
Reduction Forceps
for small fragments 135 mm



100-284-14
Forceps with Ratchet
Fixation 145 mm



100-270-17
Reil, 170 mm



100-280-13
Holding Forceps for
Mini 135 mm



100-602-35 Weight approx:350 g
100-602-50 Weight approx:500 g(standard size)
100-602-70 Weight approx:700 g (For Medullary Nailing)



100-604-12 18,0 cm length, 30 mm, 125 g (4 oz)
Material Ferozell can be sterilized in an autoclave
at 3 bar overpressure (143°C)

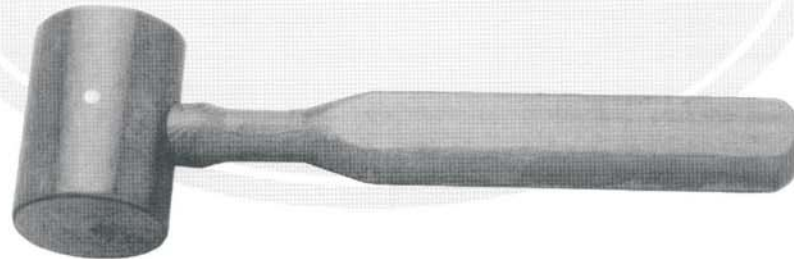

100-609-25 42 mm, 250 mm
Material Ferozell can be sterilized in an autoclave
at 3 bar overpressure (143°C)



100-612-21 30 mm / 215 g
with interchangeable Plastic disks 250 mm
100-613-02 Pair of spare disks

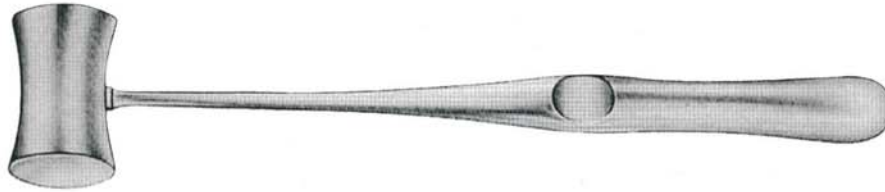

	Williger 24 cm
100-580-26	Ø 26 mm, 300 gr.
100-580-28	Ø 28 mm, 340 gr.
100-580-30	Ø 30 mm, 400 gr.

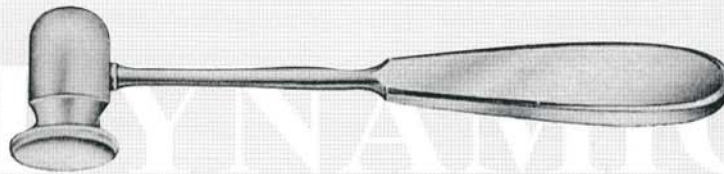

	Doyen 20 cm
100-582-25	Ø 25 mm, 120 gr.
100-582-30	Ø 30 mm, 180 gr.
100-582-35	Ø 35 mm, 260 gr.

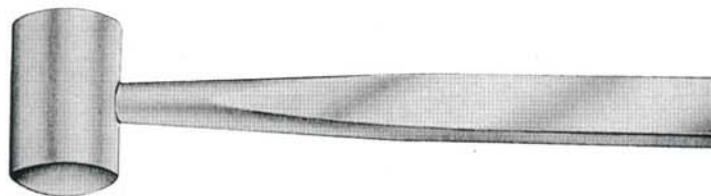

	Cottle 190 mm
100-583-19	240 gr.



Thiess 165 mm
100-585-01 Ø 20 mm, 140 gr. Lead Filled
100-585-02 Ø 20 mm, 140 gr. Brass Solid

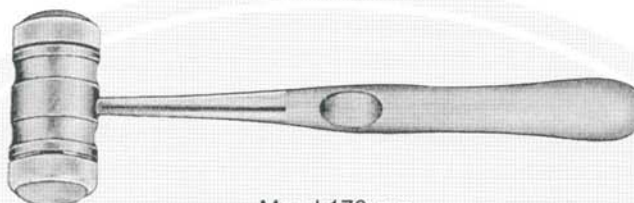

Mead 170 mm
100-588-26 Ø 26 mm, 320 gr.



Lucae 190 mm
100-590-19 Ø 19 mm, 230 gr.
100-590-25 Ø 25 mm, 260 gr.



Partsch 180 mm
100-592-22 Ø 22 mm, 200 gr.

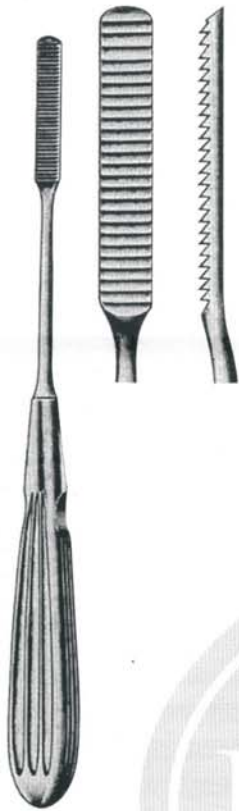

150-308-01
Cottle, 210 mm

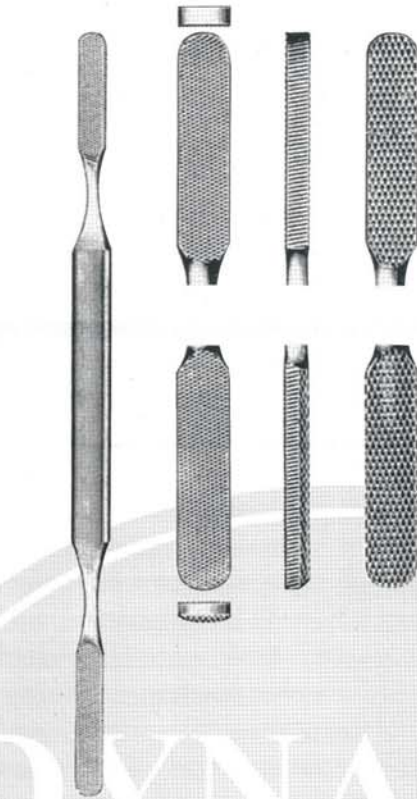

150-312-11
Cottle, 210 mm



Aufricht
210 mm



150-315-03



150-315-04

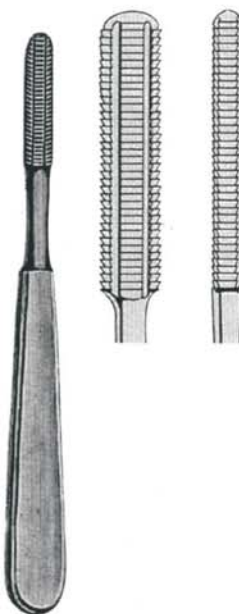

150-318-18
Maltz, 180 mm



Lewis, 180 mm



150-322-03
fine



150-322-04
coarse



Fomon, 200 mm

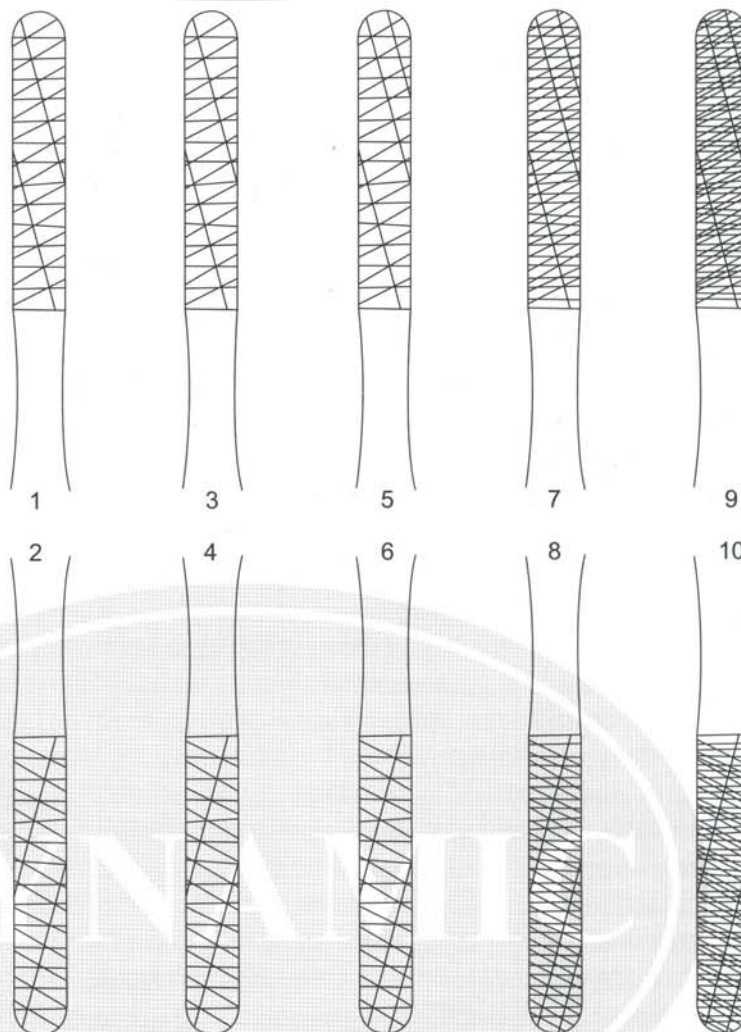

150-325-01

150-325-03

150-325-05

150-325-07

150-325-09



100-935-38 Putti, 280 mm



100-938-30 Putti, 300 mm



100-915-16 160 mm

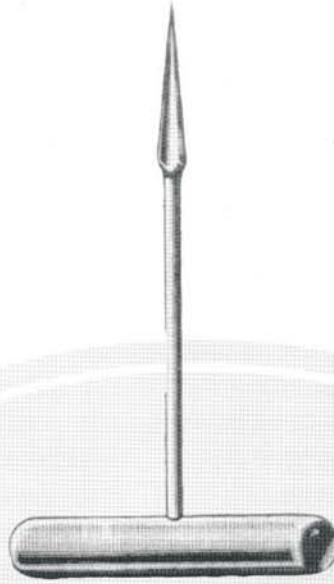

100-917-15 150 mm

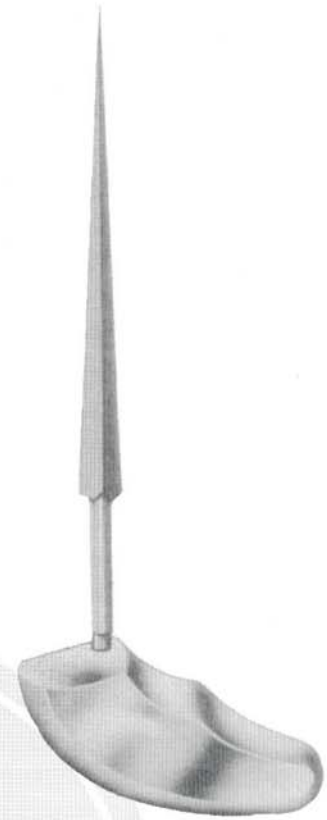

100-922-16 Perthes, 160 mm
100-922-22 Perthes, 220 mm

DYNAMIC



Bone Impactors
155 mm

- 150-350-02
- 150-350-03
- 150-350-04
- 150-350-05
- 150-350-06
- 150-350-08

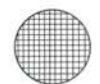

Ø 10 mm



Brand

150-405-16
Steinmann, 160 mm

Tendon Retriever, 205 mm

DYNAMIC

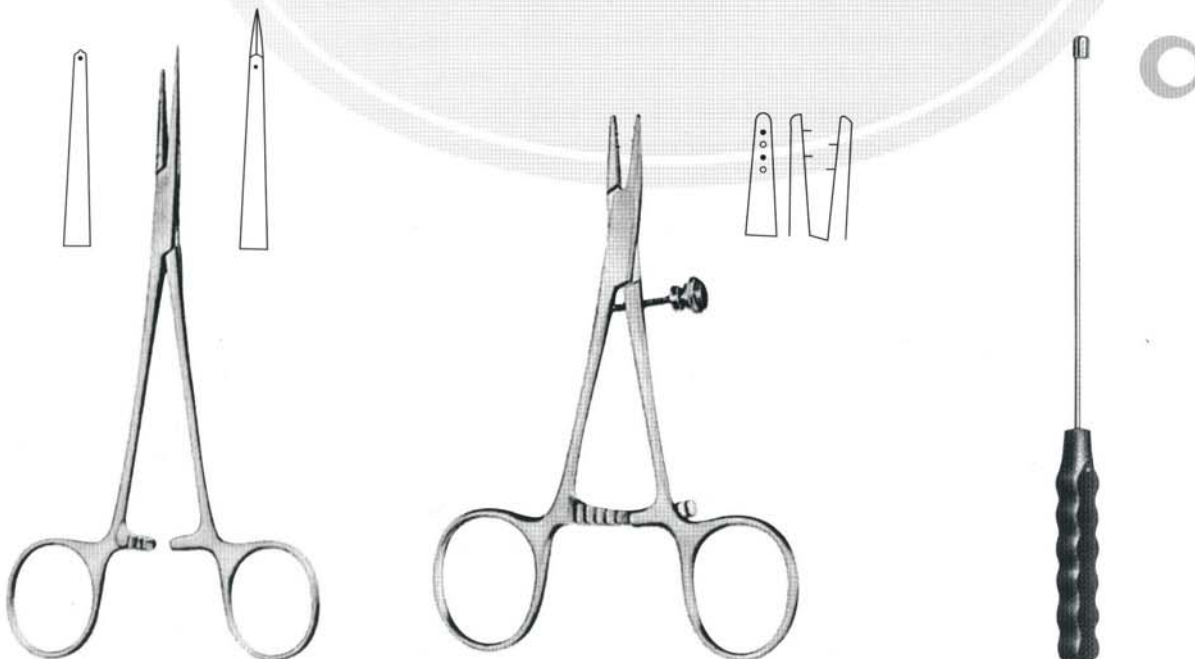

150-422-01 150 mm straight
150-422-02 150 mm curved

150-425-13
130 mm

150-435-01 5 mm dia, 285 mm length
150-435-03 5 mm dia, 285 mm length
150-435-05 5 mm dia, 285 mm length

Tendon Stripper
5 mm dia, 285 mm length
5 mm dia, 285 mm length
5 mm dia, 285 mm length



150-465-30 Ruler, 300 mm
Metric only



150-468-16 Humby Skin Graft Knife,
blade 160 mm, adjustable
setting, overall length 315 mm

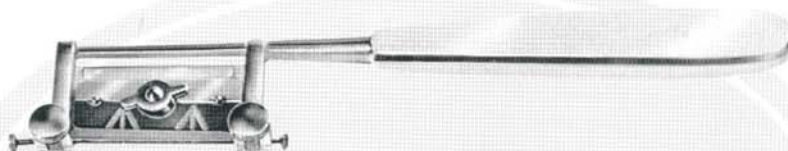

150-470-40 Silver Dermatome, blade 40 mm
overall length 200 mm

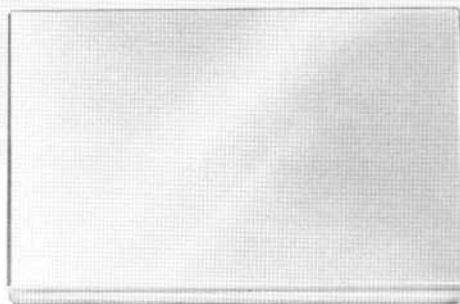

150-475-10 Skin Traction Plate, synthetic,
120 x 80 x 10 mm

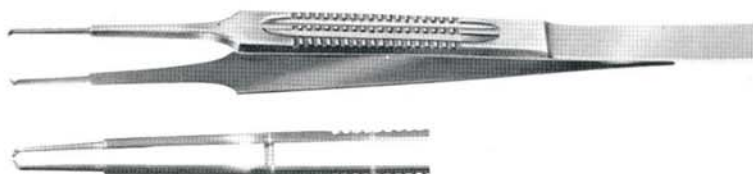

150-480-11 Micro Forceps, straight, 110 mm