

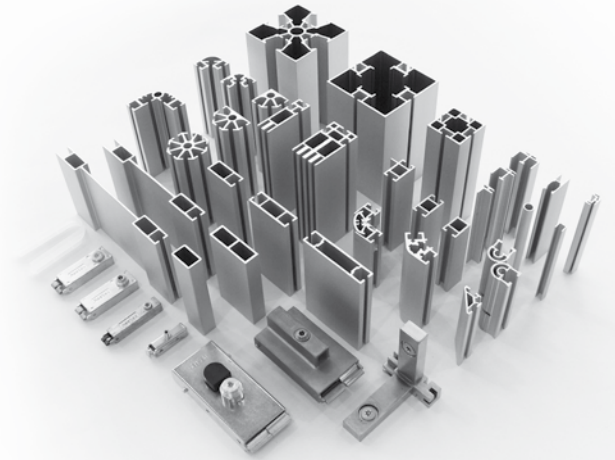

HestexSystems



Hersteller von Aluminium-Systemen für den Vitrinen- und Messebau
Manufacturer of aluminium systems for exhibition stands & showcases
Producteur de systèmes en aluminium pour la construction de stands et de vitrines d'exposition
Fabricante de sistemas de aluminio para vitrinas y expositores



Deutsch

Seit mehr als 30 Jahren beschäftigt sich das Werk in Remscheid mit der Verwertung vieler Produktneuheiten und -verbesserungen im Messe- und Vitrinenaufbau.

Diese neuen Produkte wurden in langjähriger Erfahrung speziell auf dem Gebiet Verbindungstechnik kontinuierlich weiterentwickelt und mit Ideenvielfalt im Design geprägt. Alle diese Neuentwicklungen sind weltweit in den größten Industrieländern patentrechtlich geschützt.

Nach einer gründlichen Testphase gehen diese Produkte nun in die Fertigung und Produktion. Die meist in eigener Regie hergestellten Materialien, Profile, Verbinder und Zubehör etc. ermöglichen flexible Lieferzeiten und Fertigung, die unseren Kunden individuell zugute kommen.

In Zusammenarbeit mit unseren Schwesterfirmen in Holland und England, sowie mit ausgebildeten Werksvertretungen im In- und Ausland werden unsere Produkte weltweit vertrieben. Ein junges, dynamisches Team von Mitarbeitern garantiert weiterhin für eine schnelle und zuverlässige Auftragsabwicklung – wie auch in den letzten 25 Jahren.

English

For the past 30 years Hestex Systems has been designing, producing & trading aluminium systems for the exhibition-, showcase- & display industry.

All products designed by Hestex Systems are the result of longtime development, especially in the field of connectorlocks. All of the developed products by Hestex Systems are patented worldwide.

Products designed by Hestex Systems are tested carefully. Because most of the Hestex Systems products are the result of own development Hestex Systems has a large stock and is therefore able to deliver swift and quickly.

Together with Hestex Systems Holland and our trading partners around the globe, all of the Hestex Systems products are available worldwide. A professional team of designers, engineers, managers and skilfull workers garantue you a reliable partner when it comes to aluminium systems.





Français

Depuis plus de 30 ans, l'usine de Remscheid s'occupe de la réalisation de nombreuses innovations et améliorations de produits pour la construction de stands et de vitrines d'exposition.

Ces nouveaux produits ont été développés continuellement par des années d'expérience, particulièrement dans le domaine des techniques de connexion, et estampés par une multitude d'idées de design. Toutes ces innovations ont été protégées dans la majorité des pays industrialisés par des brevets internationaux.

Après une phase de tests intensifs, les produits passent à la production. La majorité des matériaux, profils, connecteurs, accessoires etc., sont produits localement, ce qui nous permet des productions et délais de livraison flexibles, ce qui ne présente que des avantages pour nos clients.

En coopération avec nos sociétés affiliées aux Pays-Bas et au Royaume-Uni, ainsi qu'avec des bureaux de représentation nationaux et internationaux, nos produits sont commercialisés au monde entier. Une jeune et dynamique équipe commerciale vous garantit un traitement rapide, fiable et efficace de vos commandes – tout comme pendant les 25 dernières années.

Espagnol

La fábrica de Remscheid trabaja desde hace más de 30 años con productos novedosos y mejorados para la construcción de vitrinas y expositores.

Estos nuevos productos se han ido desarrollando y mejorando continuamente gracias a la larga experiencia, especialmente en el campo de la técnica de conexiones. Su diseño está marcado por una gran variedad de ideas. Todos estos nuevos productos están patentados en los países industrializados más importantes.

Tras una minuciosa fase de pruebas, estos productos pasan a la fabricación y producción. La mayoría de los materiales de fabricación propia, perfiles, conectores y accesorios etc. permiten disponer de un período de entrega y fabricación flexibles, beneficiando así a cada uno de nuestros clientes.

Nuestros productos se distribuyen en todo el mundo en cooperación con nuestras sociedades hermanas en Holanda e Inglaterra, así como con representantes especializados nacionales e internacionales. Nuestro joven y dinámico equipo de empleados garantiza como siempre una tramitación de los pedidos rápida y fiable – como en los últimos 25 años.



HestexSystemsGmbH

Am Eichholz 28
42897 Remscheid -Germany

Telefon: +49 (0) 2191 / 78 00 61
Telefax: +49 (0) 2191 / 78 00 64

E-mail: info@hestexsystems.com

www.hestexsystems.com



Hestex Standard 4/8 mm

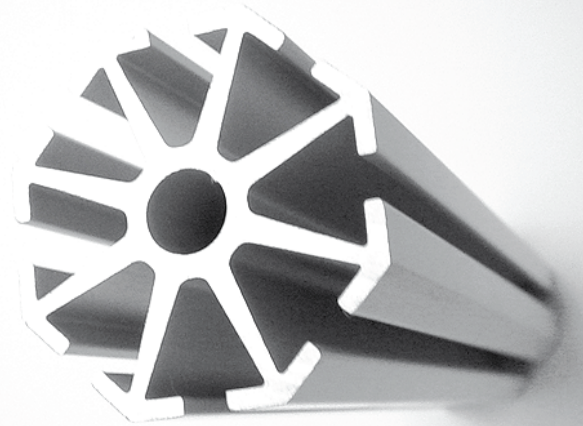



Hestex Standard 4/8 mm

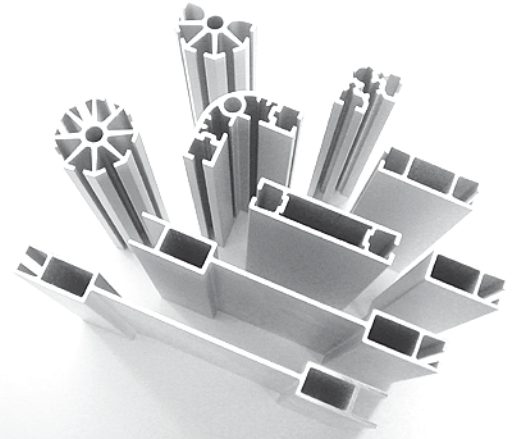

Hestex Standard Profile / profiles / profils / perfiles

Deutsch

Das Hestex Standard System wird unter Verwendung bester Materialien durch Hestex Systems GmbH in Deutschland hergestellt. Die sehr hohe Qualität sowie die Oberflächenausführung der Säulen und Profile garantieren einen jahrelangen, problemlosen Gebrauch, auch bei intensiver Nutzung. Mit dem Hestex Standard System ist es möglich, individuelle Messestände und komplette Messeausstellungen zu bauen.

Der solide Hestex SGS 6 Verbinder, der nach 4-jähriger Entwicklungsphase und Patentprüfungen nun in unserem Programm ist, sorgt dafür, dass schnell und stabil, mit nur ein 1/4-Dreh, gebaut werden kann. Neben Verwendung für das Hestex Standard System, ist der SGS 6 Verbinder auch anwendbar für alle gängigen Aluminium-Messe-Profile mit 4 mm Kammerbreite.

Praktisch ist, dass das Hestex Standardsystem auch in Kombination mit den meisten anderen 4-mm-Systemen verwendet werden kann. Eine Erweiterung von bestehenden Systemen durch das günstige Hestex Standard System ist daher fast immer möglich.

English

The Hestex Standard aluminium system is manufactured by Hestex Systems with the best tools available. The high quality of the Hestex Standard aluminium system itself and its coatings guarantee longtime problemfree use, even when used intensively. With the Hestex Standard aluminium system you are able to create individual exhibition stands and shell-schemes.

The solid Hestex SGS 6 connectors of the Hestex Standard aluminium system, which have been developed and tested for the past 4 years, guarantee a solid and quick build up of your individual exhibition stand or shell-scheme with only a 1/4 turn. Besides using the Hestex SGS 6 connector for Hestex Standard, the connector is also compatible with most other 4-mm aluminium systems.

The Hestex Standard system is also compatible with most other 4-mm aluminium systems which gives you the possibility to extend or convert your existing displays.





Hestex Standard 4/8 mm

Hestex Standard Verbinder / connectorlock / connecteur / conector



Français

Le système Hestex Standard est produit en Allemagne avec les meilleures matières par Hestex Systems GmbH. L'excellente qualité et la finition des surfaces des colonnes et des profils garantissent une utilisation, même intense, sans problèmes pendant des années. Avec le système Hestex Standard, il est possible de construire des stands d'exposition individuels ou intégraux.

Le puissant connecteur Hestex SGS 6, lequel, après 4 ans de développement et de contrôles de brevet, a été intégré dans notre programme de livraison, permet de construire, rapidement et stablement avec seulement un quart de tour. En outre des applications dans le système standard, le connecteur SGS 6 est également utilisable pour tous les profils communs de construction de stands en aluminium avec une largeur de chambre de 4 mm.

Ce qui est réellement pratique, c'est que le système Hestex Standard peut également être utilisé en combinaison avec la majorité des autres systèmes de 4 mm. Il est donc presque toujours possible d'étendre un système existant avec le versatile système Hestex Standard.

Espagnol

El Hestex Standard System está fabricado por Hestex Systems GmbH en Alemania y con los mejores materiales. La alta calidad y el acabado de las superficies de las columnas y perfiles garantizan un largo uso sin problemas, incluso si se usa de forma intensiva. Con el Hestex Standard System es posible montar expositores individuales y exposiciones completas.

El resistente conector Hestex SGS 6, que se encuentra ahora en nuestro programa tras 4 años de fase de desarrollo y pruebas de patentes, se puede montar con sólo un $\frac{1}{4}$ de giro de forma estable y rápida. Además de utilizarse para el Hestex Standard System, el conector SGS 6 también se puede usar para los perfiles convencionales de aluminio de expositores con una anchura de cámara de 4 mm.

Resulta muy práctico, ya que el sistema estándar de Hestex también se puede utilizar en combinación con la mayoría de los otros sistemas de 4 mm. Gracias al ventajoso Hestex Standard System, se pueden ampliar los sistemas actuales en prácticamente todos los casos.





Hestex Standard 4 mm

Profile
Profiles
Profils
Perfiles

(*) Incl. 2 Verbinder
(**) Incl. 4 Verbinder
(**) Incl. Stellfuß M10

(*) inclut 2 connecteurs
(**) inclut 4 connecteurs
(**) inclut pied de réglage M10

(*) Incl. 2 connectors
(**) Incl. 4 connectors
(**) Incl. Foot M10

(*) Incl. 2 conectores
(**) Incl. 4 conectores
(**) Incl. pie M10

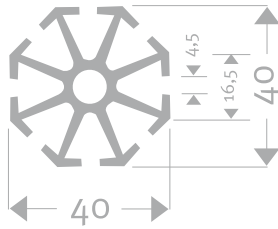

Hestex Standard SN 20 Profil-Säule
Hestex Standard SN 20 vertical profile
Profil de colonne Hestex Standard SN20
Columnas para perfiles Hestex Standard SN 20

Art. Nr.: 1100101 5000	5000 mm	
Art. Nr.: 1100101 3500	3500 mm	(***)
Art. Nr.: 1100101 3000	3000 mm	(***)
Art. Nr.: 1100101 2500	2500 mm	(***)
Art. Nr.: 1100101 2000	2000 mm	(***)
Art. Nr.: 1100101 1500	1500 mm	(***)
Art. Nr.: 1100101 1000	1000 mm	(***)
Art. Nr.: 1100101 0750	750 mm	(***)
Art. Nr.: 1100101 0500	500 mm	(***)
Art. Nr.: 1100101 0150	150 mm	(***)
Art. Nr.: 1100101 0070	70 mm	(***)

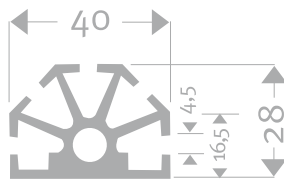

Hestex Standard SN 30 Profil-Säule
Hestex Standard SN 30 vertical profile
Profil de colonne Hestex Standard SN30
Columnas para perfiles Hestex Standard SN 30

Art. Nr.: 1100201 4560	4560 mm	
Art. Nr.: 1100201 2500	2500 mm	(***)
Art. Nr.: 1100201 2000	2000 mm	(***)
Art. Nr.: 1100201 1000	1000 mm	(***)
Art. Nr.: 1100201 0150	150 mm	
Art. Nr.: 1100201 0070	70 mm	

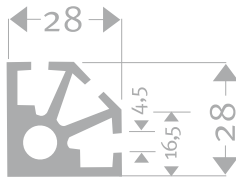

Hestex Standard SN 40 Profil-Säule
Hestex Standard SN 40 vertical profile
Profil de colonne Hestex Standard SN40
Columnas para perfiles Hestex Standard SN 40

Art. Nr.: 1100301 5000	5000 mm	
Art. Nr.: 1100301 2500	2500 mm	(***)
Art. Nr.: 1100301 2000	2000 mm	(***)
Art. Nr.: 1100301 1000	1000 mm	(***)

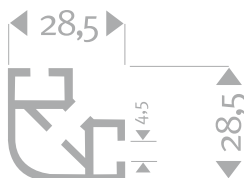

Hestex Standard SN 60 Profil-Säule
Hestex Standard SN 60 vertical profile
Profil de colonne Hestex Standard SN60
Columnas para perfiles Hestex Standard SN 60

Art. Nr.: 1100401 5000	5000 mm	
-------------------------------	---------	--



Hestex Standard 4 mm

Profile
Profiles
Profils
Perfiles

(*) Incl. 2 Verbinder
(**) Incl. 4 Verbinder
(***) Incl. Stellfuß M10

(*) Incl. 2 connectors
(**) Incl. 4 connectors
(***) Incl. Foot M10

(*) inclut 2 connecteurs
(**) inclut 4 connecteurs
(***) inclut pied de réglage M10

(*) Incl. 2 conectores
(**) Incl. 4 conectores
(***) Incl. pie M10

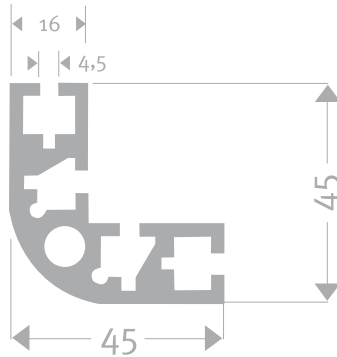

Hestex Standard SN 70 Profil-Säule
Hestex Standard SN 70 vertical profile
Profil de colonne Hestex Standard SN70
Columnas para perfiles Hestex Standard SN 70

Art. Nr.: **1100501 5000** | 5000 mm
Art. Nr.: **1100501 2500** | 2500 mm
Art. Nr.: **1100501 1000** | 1000 mm



Hestex Standard 25 x 16 Zargen-Profil
Hestex Standard 25 x 16 straight beam
Profils d'encadrement Hestex Standard 25 x 16
Hestex Standard 25 x 16 perfil de ranura

Art. Nr.: **1101000 5000** | 5000 mm

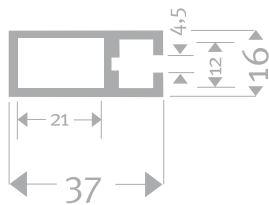

Hestex Standard PP37 Zargen-Profil
Hestex Standard PP37 straight beam
Profils d'encadrement Hestex Standard PP37
Hestex Standard PP37 perfil de ranura

Art. Nr.: **1101001 5000** | 5000 mm
Art. Nr.: **1101001 1360** | 1360 mm (*)
Art. Nr.: **1101001 0950** | 950 mm (*)
Art. Nr.: **1101001 0660** | 660 mm (*)
Art. Nr.: **1101001 0455** | 455 mm (*)

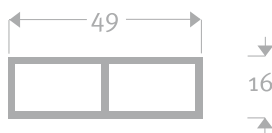

Hestex Standard Twinprofil
Hestex Standard twin profile
Profil de jumeau Hestex Standard
Hestex Standard perfil gemelo

Art. Nr.: **1104230 5000** | 5000 mm



Hestex Standard 4 mm

Profile
Profiles
Profils
Perfiles

(*) Incl. 2 Verbinder
(**) Incl. 4 Verbinder
(***) Incl. Stellfuß M10

(*) inclut 2 connecteurs
(**) inclut 4 connecteurs
(***) inclut pied de réglage M10

(*) Incl. 2 connectors
(**) Incl. 4 connectors
(***) Incl. Foot M10

(*) Incl. 2 conectores
(**) Incl. 4 conectores
(***) Incl. pie M10

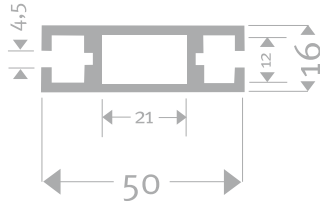

Hestex Standard PP50 Zargen-Profil
Hestex Standard PP50 straight beam
Profils d'encadrement Hestex Standard PP50
Hestex Standard PP50 perfil de ranura

Art. Nr.: 1101101 5000	5000 mm	
Art. Nr.: 1101101 3920	3920 mm	(*)
Art. Nr.: 1101101 2930	2930 mm	(*)
Art. Nr.: 1101101 1940	1940 mm	(*)
Art. Nr.: 1101101 1360	1360 mm	(*)
Art. Nr.: 1101101 0950	950 mm	(*)
Art. Nr.: 1101101 0660	660 mm	(*)
Art. Nr.: 1101001 0455	455 mm	(*)

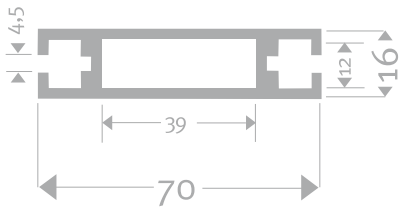

Hestex Standard PP70 Zargen-Profil
Hestex Standard PP70 straight beam
Profils d'encadrement Hestex Standard PP70
Hestex Standard PP70 perfil de ranura

Art. Nr.: 1101201 5000	5000 mm	
Art. Nr.: 1101201 3920	3920 mm	(*)
Art. Nr.: 1101201 2930	2930 mm	(*)
Art. Nr.: 1101201 1940	1940 mm	(*)
Art. Nr.: 1101201 1360	1360 mm	(*)
Art. Nr.: 1101201 0950	950 mm	(*)
Art. Nr.: 1101201 0660	660 mm	(*)
Art. Nr.: 1101201 0455	455 mm	(*)

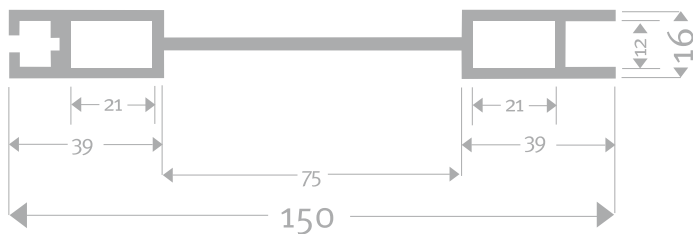

Hestex Standard PP150 Zargen-Profil
Hestex Standard PP150 straight beam
Profils d'encadrement Hestex Standard PP150
Hestex Standard PP150 perfil de ranura

Art. Nr.: 1101301 5000	5000 mm	
Art. Nr.: 1101301 3920	3920 mm	(**)
Art. Nr.: 1101301 2930	2930 mm	(**)
Art. Nr.: 1101301 1940	1940 mm	(**)
Art. Nr.: 1101301 1360	1360 mm	(**)
Art. Nr.: 1101301 0950	950 mm	(**)
Art. Nr.: 1101301 0660	660 mm	(**)
Art. Nr.: 1101301 0455	455 mm	(**)

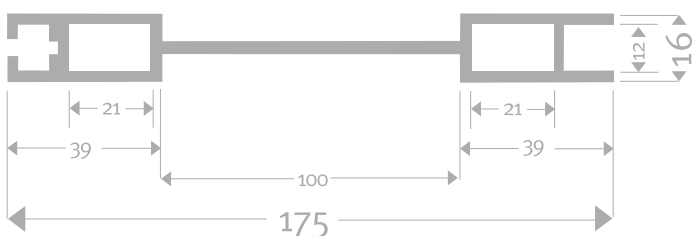

Hestex Standard PP175 Zargen-Profil
Hestex Standard PP175 straight beam
Profils d'encadrement Hestex Standard PP175
Hestex Standard PP175 perfil de ranura

Art. Nr.: 1101401 5000	5000 mm	
Art. Nr.: 1101401 3920	3920 mm	(**)
Art. Nr.: 1101401 2930	2930 mm	(**)
Art. Nr.: 1101401 1940	1940 mm	(**)
Art. Nr.: 1101401 1360	1360 mm	(**)
Art. Nr.: 1101401 0950	950 mm	(**)
Art. Nr.: 1101401 0660	660 mm	(**)
Art. Nr.: 1101401 0455	455 mm	(**)



Hestex Standard 4 mm

Profile
Profiles
Profils
Perfiles

(*) Incl. 2 Verbinder
(**) Incl. 4 Verbinder
(***) Incl. Stellfuß M10

(*) inclut 2 connecteurs
(**) inclut 4 connecteurs
(***) inclut pied de réglage M10

(*) Incl. 2 connectors
(**) Incl. 4 connectors
(***) Incl. Foot M10

(*) Incl. 2 conectores
(**) Incl. 4 conectores
(***) Incl. pie M10

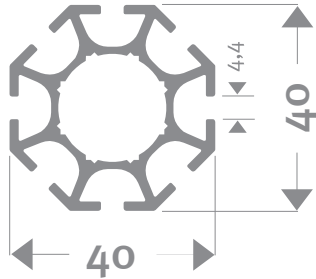

Hestex Standard S108 Profil-Saule
Hestex Standard S108 vertical profile
Profil de colonne Hestex Standard S108
Columnas para perfiles Hestex Standard S108

Art. Nr.: 1100501 5000	5000 mm
Art. Nr.: 1100501 3500	3500 mm (**)
Art. Nr.: 1100501 3000	3000 mm (**)
Art. Nr.: 1100501 2500	2500 mm (**)
Art. Nr.: 1101501 2000	2000 mm (**)
Art. Nr.: 1101501 1500	1500 mm (**)
Art. Nr.: 1101501 1000	1000 mm (**)
Art. Nr.: 1101501 0750	0750 mm (**)
Art. Nr.: 1100501 0500	0500 mm (**)
Art. Nr.: 1100501 0150	0150 mm
Art. Nr.: 1100501 0070	0070 mm

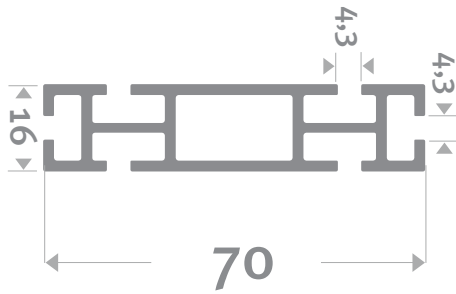

Hestex Standard PP71 Zargen-Profil
Hestex Standard PP71 straight beam
Profils d'encadrement Hestex Standard PP71
Hestex Standard PP71 perfil de ranura

Art. Nr.: 1101501 5000	5000 mm
Art. Nr.: 1101501 3920	9320 mm (**)
Art. Nr.: 1101501 2930	2930 mm (**)
Art. Nr.: 1101501 1940	1940 mm (**)
Art. Nr.: 1101501 1360	1360 mm (**)
Art. Nr.: 1101501 0950	0950 mm (**)
Art. Nr.: 1101501 0660	0660 mm (**)
Art. Nr.: 1101501 0455	0455 mm (**)



Hestex Standard 4 mm

Profile
Profiles
Profils
Perfiles

(*) Incl. 2 Verbinder
(**) Incl. 4 Verbinder
(***) Incl. Stellfuß M10

(*) inclut 2 connecteurs
(**) inclut 4 connecteurs
(***) inclut pied de réglage M10

(*) Incl. 2 connectors
(**) Incl. 4 connectors
(***) Incl. Foot M10

(*) Incl. 2 conectores
(**) Incl. 4 conectores
(***) Incl. pie M10



R=990

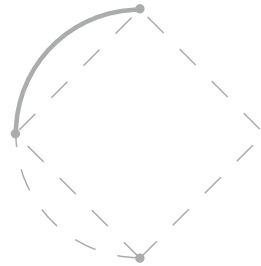

HS Rundzarge PP50 990
HS Curved Beams PP50 990
Poutres courbées HS PP50 990
Vigas curvas HS PP50 990

Pro Stück / per piece / par pièce / por unidad

Art. Nr.: **1102101 0990**



R=1400

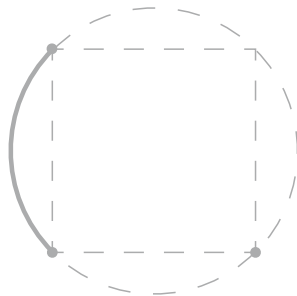

HS Rundzarge PP50 1400
HS Curved Beams PP50 1400
Poutres courbées HS PP50 1400
Vigas curvas HS PP50 1400

Pro Stück / per piece / par pièce / por unidad

Art. Nr.: **1102101 1400**



R=1980

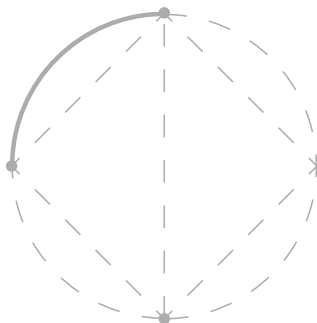

HS Rundzarge PP50 1980
HS Curved Beams PP50 1980
Poutres courbées HS PP50 1980
Vigas curvas HS PP50 1980

Pro Stück / per piece / par pièce / por unidad

Art. Nr.: **1102101 1980**



R=2800

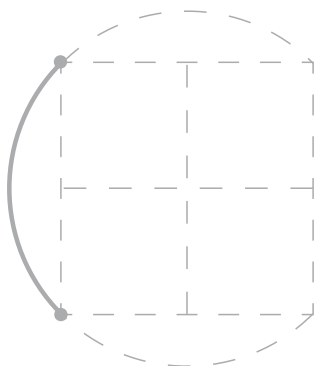

HS Rundzarge PP50 2800
HS Curved Beams PP50 2800
Poutres courbées HS PP50 2800
Vigas curvas HS PP50 2800

Pro Stück / per piece / par pièce / por unidad

Art. Nr.: **1102101 2800**



Hestex Standard 4 mm

Profile
Profiles
Profils
Perfiles

(*) Incl. 2 Verbinder
(**) Incl. 4 Verbinder
(**) Incl. Stellfuß M10

(*) inclut 2 connecteurs
(**) inclut 4 connecteurs
(**) inclut pied de réglage M10

(*) Incl. 2 connectors
(**) Incl. 4 connectors
(**) Incl. Foot M10

(*) Incl. 2 conectores
(**) Incl. 4 conectores
(**) Incl. pie M10



R=990

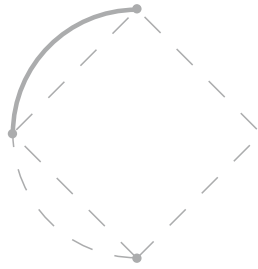

HS Rundzarge PP70 990
HS Curved Beams PP70 990
Poutres courbées HS PP70 990
Vigas curvas HS PP70 990

Pro Stück / per piece / par pièce / por unidad

Art. Nr.: **1102201 0990**



R=1400

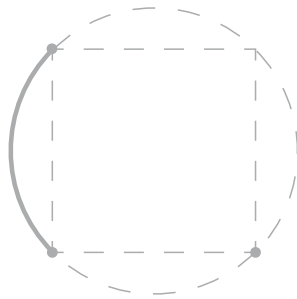

HS Rundzarge PP70 1400
HS Curved Beams PP70 1400
Poutres courbées HS PP70 1400
Vigas curvas HS PP70 1400

Pro Stück / per piece / par pièce / por unidad

Art. Nr.: **1102201 1400**



R=1980

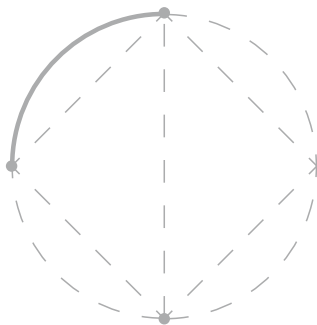

HS Rundzarge PP70 1980
HS Curved Beams PP70 1980
Poutres courbées HS PP70 1980
Vigas curvas HS PP70 1980

Pro Stück / per piece / par pièce / por unidad

Art. Nr.: **1102201 1980**



R=2800

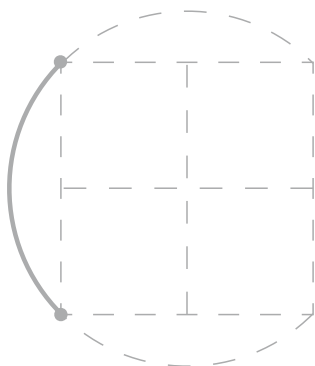

HS Rundzarge PP70 2800
HS Curved Beams PP70 2800
Poutres courbées HS PP70 2800
Vigas curvas HS PP70 2800

Pro Stück / per piece / par pièce / por unidad

Art. Nr.: **1102201 2800**



Hestex Standard 4 mm

Profile
Profiles
Profils
Perfiles

(*) Incl. 2 Verbinder
(**) Incl. 4 Verbinder
(***) Incl. Stellfuß M10

(*) inclut 2 connecteurs
(**) inclut 4 connecteurs
(***) inclut pied de réglage M10

(*) Incl. 2 connectors
(**) Incl. 4 connectors
(***) Incl. Foot M10

(*) Incl. 2 conectores
(**) Incl. 4 conectores
(***) Incl. pie M10



R=990

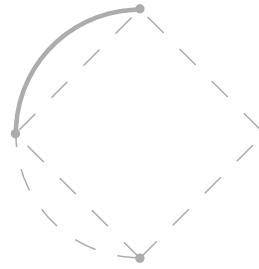

HS Rundzarge PP 71 990
HS Curved Beams PP 71 990
Poutres courbées HS PP 71 990
Vigas curvas HS PP 71 990

Pro Stück / per piece / par pièce / por unidad

Art. Nr.: **1102501 0990**



R=1400

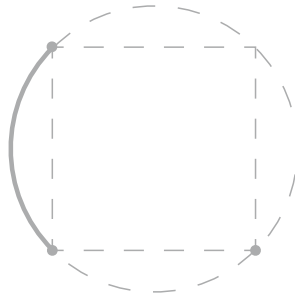

HS Rundzarge PP 71 1400
HS Curved Beams PP 71 1400
Poutres courbées HS PP 71 1400
Vigas curvas HS PP 71 1400

Pro Stück / per piece / par pièce / por unidad

Art. Nr.: **1102501 1400**



R=1980

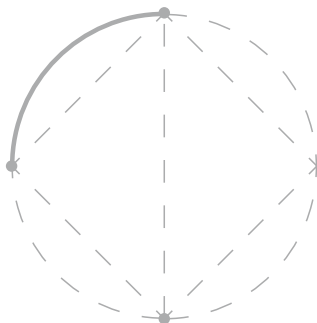

HS Rundzarge PP 71 1980
HS Curved Beams PP 71 1980
Poutres courbées HS PP 71 1980
Vigas curvas HS PP 71 1980

Pro Stück / per piece / par pièce / por unidad

Art. Nr.: **1102501 1980**



R=2800

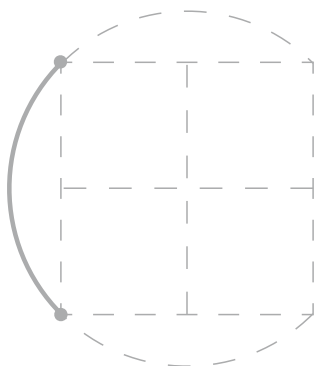

HS Rundzarge PP 71 2800
HS Curved Beams PP 71 2800
Poutres courbées HS PP 71 2800
Vigas curvas HS PP 71 2800

Pro Stück / per piece / par pièce / por unidad

Art. Nr.: **1102501 2800**



Hestex Standard 4 mm

Verbinder
Connectorlocks
Connecteurs
Conector

Zubehör
Accessories
Accessoires
Accesorios



Hestex Standard SGS6 Verbinder
Hestex Standard SGS6 connector
Connecteur Hestex Standard SGS6
Hestex Standard SGS6 conector

Pro Stück / per piece / par pièce / por unidad

Art. Nr.: **110.40.31**

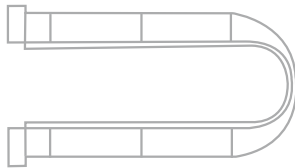

Hestex Standard SGS6 Adapter
Hestex Standard SGS6 lockslide
Élément d'attache Hestex Standard SGS6
Hestex Standard SGS6 elemento de presión

Pro Stück / per piece / par pièce / por unidad

Art. Nr.: **110.41.32**



SN 220 Hammerkopfschraube 20mm
SN 220 Screw 20mm
SN 220 Vis 20mm
SN 220 tornillo con cabeza en forma de tornillo 20mm

Pro Stück / per piece / par pièce / por unidad

Art. Nr.: **110.42.20**



SN 220 Hammerkopfschraube 40mm
SN 220 Screw 40mm
SN 220 Vis 40mm
SN 220 tornillo con cabeza en forma de tornillo 40mm

Pro Stück / per piece / par pièce / por unidad

Art. Nr.: **110.42.40**



Hestex Standard 4 mm

Verbinder
Connectorlocks
Connecteurs
Conector

Zubehör
Accessories
Accessoires
Accesorios



SN 212 Abdeckkappe grau (Passend für Hestex Standard SN 20)
SN 212 cap grey (Suitable for Hestex Standard SN20)
SN 212 Capot gris (Approprié pour système Hestex Standard SN 20)
SN 212 capuchón de protección gris (Para Hestex Standard SN 20)

Pro Stück / per piece / par pièce / por unidad

Art. Nr.: **110.51.11**



SN 212 Abdeckkappe weiß (Passend für Hestex Standard SN 20)
SN 212 cap white (Suitable for Hestex Standard SN20)
SN 212 Capot blanc (Approprié pour système Hestex Standard SN 20)
SN 212 capuchón de protección blanco (Para Hestex Standard SN 20)

Pro Stück / per piece / par pièce / por unidad

Art. Nr.: **110.51.17**



SN 211 Abdeckkappe grau (Passend für Hestex Standard SN 30)
SN 211 cap grey (Suitable for Hestex Standard SN30)
SN 211 Capot gris (Approprié pour système Hestex Standard SN 30)
SN 211 capuchón de protección gris (Para Hestex Standard SN 30)

Pro Stück / per piece / par pièce / por unidad

Art. Nr.: **110.51.12**



SN 211 Abdeckkappe weiß (Passend für Hestex Standard SN 30)
SN 211 cap white (Suitable for Hestex Standard SN30)
SN 211 Capot blanc (Approprié pour système Hestex Standard SN 30)
SN 211 capuchón de protección blanco (Para Hestex Standard SN 30)

Pro Stück / per piece / par pièce / por unidad

Art. Nr.: **110.51.18**



Hestex Standard 4 mm

Verbinder
Connectorlocks
Connecteurs
Conector

Zubehör
Accessories
Accessoires
Accesorios



SN 210 Abdeckkappe grau (Passend für Hestex Standard SN 40)
SN 210 cap grey (Suitable for Hestex Standard SN40)
SN 210 Capot gris (Approprié pour système Hestex Standard SN 40)
SN 210 capuchón de protección gris (Para Hestex Standard SN 40)

Pro Stück / per piece / par pièce / por unidad

Art. Nr.: **110.51.13**



SN 210 Abdeckkappe weiß (Passend für Hestex Standard SN 40)
SN 210 cap white (Suitable for Hestex Standard SN40)
SN 210 Capot blanc (Approprié pour système Hestex Standard SN 40)
SN 210 capuchón de protección blanco (Para Hestex Standard SN 40)

Pro Stück / per piece / par pièce / por unidad

Art. Nr.: **110.51.19**



SN 209 Abdeckkappe grau (Passend für Hestex Standard PP37)
SN 209 cap grey (Suitable for Hestex Standard PP37)
SN 209 Capot gris (Approprié pour système Hestex Standard SPP37)
SN 209 capuchón de protección gris (Para Hestex Standard PP37)

Pro Stück / per piece / par pièce / por unidad

Art. Nr.: **110.51.14**



SN 209 Abdeckkappe weiß (Passend für Hestex Standard PP37)
SN 209 cap white (Suitable for Hestex Standard PP37)
SN 209 Capot blanc (Approprié pour système Hestex Standard SPP37)
SN 209 capuchón de protección blanco (Para Hestex Standard PP37)

Pro Stück / per piece / par pièce / por unidad

Art. Nr.: **110.51.20**



Hestex Standard 4 mm

Verbinder
Connectorlocks
Connecteurs
Conector

Zubehör
Accessories
Accessoires
Accesorios



SN 208 Abdeckkappe grau (Passend für Hestex Standard PP50)
SN 208 cap grey (Suitable for Hestex Standard PP50)
SN 208 Capot gris (Approprié pour système Hestex Standard PP50)
SN 208 capuchón de protección gris (Para Hestex Standard PP50)

Pro Stück / per piece / par pièce / por unidad

Art. Nr.: **110.51.15**



SN 208 Abdeckkappe weiß (Passend für Hestex Standard PP50)
SN 208 cap white (Suitable for Hestex Standard PP50)
SN 208 Capot blanc (Approprié pour système Hestex Standard PP50)
SN 208 capuchón de protección blanco (Para Hestex Standard PP50)

Pro Stück / per piece / par pièce / por unidad

Art. Nr.: **110.51.21**



SN 207 Abdeckkappe grau (Passend für Hestex Standard PP70)
SN 207 cap grey (Suitable for Hestex Standard PP70)
SN 207 Capot gris (Approprié pour système Hestex Standard PP70)
SN 207 capuchón de protección gris (Para Hestex Standard PP70)

Pro Stück / per piece / par pièce / por unidad

Art. Nr.: **110.51.16**



SN 207 Abdeckkappe weiß (Passend für Hestex Standard PP70)
SN 207 cap white (Suitable for Hestex Standard PP70)
SN 207 Capot blanc (Approprié pour système Hestex Standard PP70)
SN 207 capuchón de protección blanco (Para Hestex Standard PP70)

Pro Stück / per piece / par pièce / por unidad

Art. Nr.: **110.51.22**



Hestex Standard 4 mm

Verbinder
Connectorlocks
Connecteurs
Conector

Zubehör
Accessories
Accessoires
Accesorios

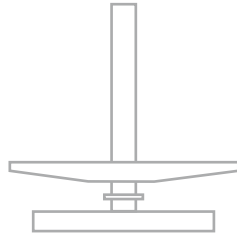

Stellfuß Standard SN20
Foot Standard SN20
Pied réglable Standard SN20
Pie Standard SN20

Pro Stück / per piece / par pièce / por unidad

Art. Nr.: **110.43.22**

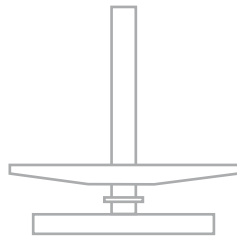
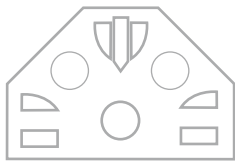

Stellfuß Standard SN30
Foot Standard SN30
Pied réglable Standard SN30
Pie Standard SN30

Pro Stück / per piece / par pièce / por unidad

Art. Nr.: **110.43.23**

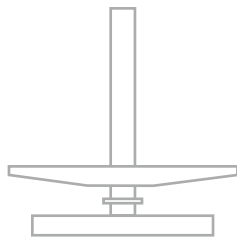

Stellfuß Standard SN40
Foot Standard SN40
Pied réglable Standard SN40
Pie Standard SN40

Pro Stück / per piece / par pièce / por unidad

Art. Nr.: **110.43.24**

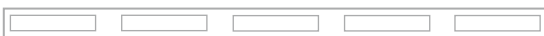

Stripline 4mm
Stripline 4mm
Stripline 4mm
Stripline 4mm

Pro Stück / per piece / par pièce / por unidad

Art. Nr.: **110.40.00** | 950 mm



Hestex Standard 4 mm

Verbinder
Connectorlocks
Connecteurs
Conector

Zubehör
Accessories
Accessoires
Accesorios

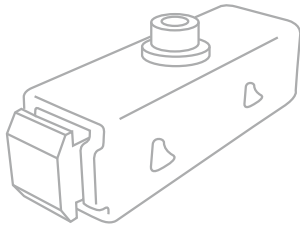

HS Verbinder alt 12 x 12 - 4,5 mm
HS Connector Old 12 x 12 - 4.5 mm
Connecteur HS Vieux 12 x 12 - 4,5 mm
Antiguo conector HS 12 x 12 - 4,5 mm

Pro Stück / per piece / par pièce / por unidad



HS Verbinder SN-20 M10 Zapfen
HS Connector SN-20 M 10 spigot
EEmbout connecteur HS SN-20 M 10 clé
Conector HS SN-20 M 10 espiga

Pro Stück / per piece / par pièce / por unidad

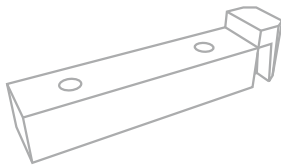

HS Sicherheitsblock PP 070 Typ 04
HS Safetyblock PP 070 type 04
Bloc de sécurité HS PP 070 type 04
Bloqueo de seguridad HS PP 070 de tipo 04

Pro Stück / per piece / par pièce / por unidad



HS Verbinder SGS6 45° links
HS Connector SGS6 45° left
Connecteur HS SGS6 45° liens
Conector HS SGS6 45° enlaces

Pro Stück / per piece / par pièce / por unidad



Hestex Standard 4 mm

Verbinder
Connectorlocks
Connecteurs
Conector

Zubehör
Accessories
Accessoires
Accesorios



HS Verbinder SGS6 45° rechts
HS Connector SGS6 45° right
Connecteur HS SGS6 45° droit
Conector HS SGS6 45° derecho

Pro Stück / per piece / par pièce / por unidad

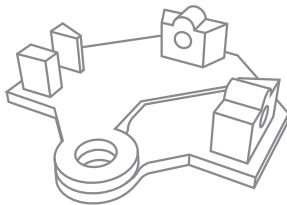

HS SN 90 - SN 95 Drehplatte unten
HS SN 90 - SN 95 Turn plate bottom
Bas de gond HS SN 90 - SN 95
HS SN 90 - Parte inferior de la placa giratoria SN 95

Pro Stück / per piece / par pièce / por unidad



HS-SN90-Profil
HS-SN90-Profile
Profile HS-SN90
HS-SN90-Perfil

Pro Stück / per piece / par pièce / por unidad



HS-SN95-Profil
HS-SN95-Profile
Profile HS-SN95
HS-SN95-Perfil

Pro Stück / per piece / par pièce / por unidad



Hestex Standard 8 mm

Profile
Profiles
Profils
Perfiles

(*) Incl. 2 Verbinder
(**) Incl. 4 Verbinder
(***) Incl. Stellfuß M10

(*) inclut 2 connecteurs
(**) inclut 4 connecteurs
(***) inclut pied de réglage M10

(*) Incl. 2 connectors
(**) Incl. 4 connectors
(***) Incl. Foot M10

(*) Incl. 2 conectores
(**) Incl. 4 conectores
(***) Incl. pie M10

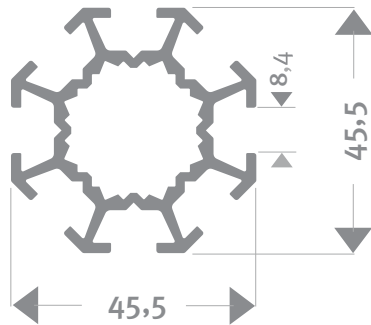

Hestex Standard S109 Profil-Saule
Hestex Standard S109 vertical profile
Profil de colonne Hestex Standard S109
Columnas para perfiles Hestex Standard S109

Art. Nr.: 1100601 5000	5000 mm
Art. Nr.: 1100601 3500	3500 mm (**)
Art. Nr.: 1100601 3000	3000 mm (**)
Art. Nr.: 1100601 2500	2500 mm (**)
Art. Nr.: 1100601 2000	2000 mm (**)
Art. Nr.: 1100601 1500	1500 mm (**)
Art. Nr.: 1100601 1000	1000 mm (**)
Art. Nr.: 1100601 0750	0750 mm (**)
Art. Nr.: 1100601 0500	0500 mm (**)
Art. Nr.: 1100601 0150	0150 mm
Art. Nr.: 1100601 0070	0070 mm

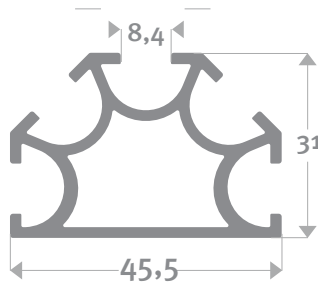

Hestex Standard S110 Profil-Saule
Hestex Standard S110 vertical profile
Profil de colonne Hestex Standard S110
Columnas para perfiles Hestex Standard S110

Art. Nr.: 1100701 5000	5000 mm
Art. Nr.: 1100701 2500	2500 mm (**)
Art. Nr.: 1100701 2000	2000 mm (**)
Art. Nr.: 1100701 1000	1000 mm

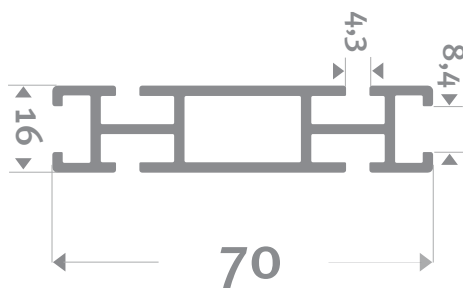

Hestex Standard PP71 8 mm Zargen-Profil
Hestex Standard PP71 8 mm straight beam
Profils d'encadrement Hestex Standard PP71 8 mm
Hestex Standard PP71 8 mm perfil de ranura

Art. Nr.: 1101601 5000	5000 mm
Art. Nr.: 1101601 3920	9320 mm (**)
Art. Nr.: 1101601 2930	2930 mm (**)
Art. Nr.: 1101601 1940	1940 mm (**)
Art. Nr.: 1101601 1360	1360 mm (**)
Art. Nr.: 1101601 0950	0950 mm (**)
Art. Nr.: 1101601 0660	0660 mm (**)
Art. Nr.: 1101601 0455	0455 mm (**)



Hestex Standard PP176 8 mm Zargen-Profil
Hestex Standard PP176 8 mm straight beam
Profils d'encadrement Hestex Standard PP176 8 mm
Hestex Standard PP176 8 mm perfil de ranura

Art. Nr.: 1101701 5000	5000 mm
Art. Nr.: 1101701 3920	9320 mm (**)
Art. Nr.: 1101701 2930	2930 mm (**)
Art. Nr.: 1101701 1940	1940 mm (**)
Art. Nr.: 1101701 1360	1360 mm (**)
Art. Nr.: 1101701 0950	0950 mm (**)
Art. Nr.: 1101701 0660	0660 mm (**)
Art. Nr.: 1101701 0455	0455 mm (**)



Hestex Standard 8 mm

Verbinder
Connectorlocks
Connecteurs
Conector

Zubehör
Accessories
Accessoires
Accesorios



HS Verbinder 45° 8 mm Gewinde für S109 aufrecht
HS Connector 45° 8 mm thread for S109 upright
Connecteur HS 45° filetage 8 mm pour position S109
Conector de 45° HS hilo de 8 mm para el S109 vertical

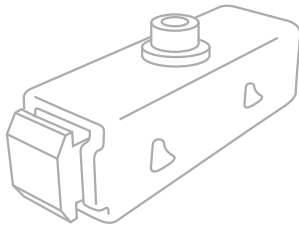

HS Verbinder alt 12 x 12 - 8 mm
HS Connector Old 12 x 12 - 8 mm
Connecteur HS Vieux 12 x 12 - 8 mm
Antiguo conector HS 12 x 12 - 8 mm

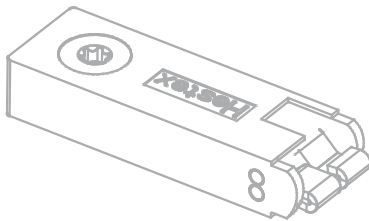

HS Verbinder SGS 6 - 8 mm
HS Connector SGS 6 - 8 mm
Connecteur HS SGS6 - 8 mm
Conector HS SGS 6 - 8 mm

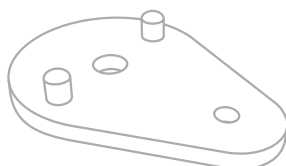

HS Tür S109 Drehplatte unten
HS Door S109 Turnplate botom
Bas de gâche de Porte HS S109
Puerta HS Placa giratoria S109 parte inferior



Hestex Standard 8 mm

Verbinder
Connectorlocks
Connecteurs
Conector

Zubehör
Accessories
Accessoires
Accesorios

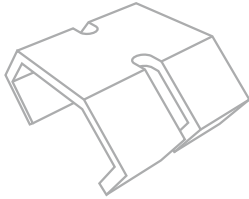

HS Kettenaufhängung
HS Chainhanger
Suspente à chaîne HS
Colgador de cadenas HS

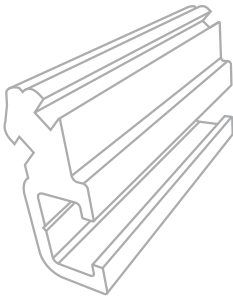

HS Eckblock
HS Cornerblock
Bloc de coin HS
Bloqueador de esquina HS



HS Vorhanggleiter
HS Curtainslide
Glissière de rideau HS
Guía para cortinas HS



HS Hängeklammer
HS Hangbracket
Bouton du nom HS
Soporte para colgar HS



Hestex Standard 8 mm

Verbinder
Connectorlocks
Connecteurs
Conector

Zubehör
Accessories
Accessoires
Accesorios



HS Namensschild
HS Nameboard button
Bouton du nom HS
Botón del nombre del tablón HS

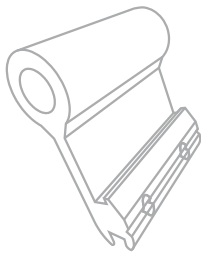

HS Nachtauge
HS Nighteye
HS Nighteye
Vista nocturna HS

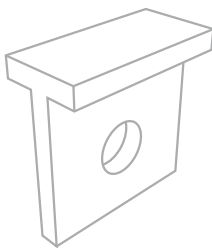

HS Nachtleiter
HS Nightslide
HS Nightslide
Guía nocturna HS

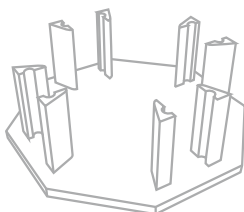

HS SN 109 Abdeckkappe
HS SN 109 Polecap
Embout de poteau SN 109 HS
Tapón de poste HS SN 109



Hestex Standard 8 mm

Verbinder
Connectorlocks
Connecteurs
Conector

Zubehör
Accessories
Accessoires
Accesorios



HS SN 109 Nutenstein 20x15
HS SN 109 Spigot 20x15
Embout HS SN 109 20x15
Espiga de 20 x 15 HS SN 109



HS SN 109 Nutenstein
HS SN 109 Spigotstar
Spigotstar (embout étoile) SN 109 HS
Estrella de espiga HS SN 109

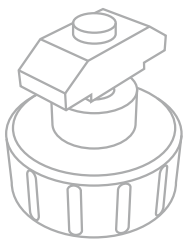

HS Namensschild
HS Nameboard button
Bouton du nom HS
Botón del nombre del tablón HS

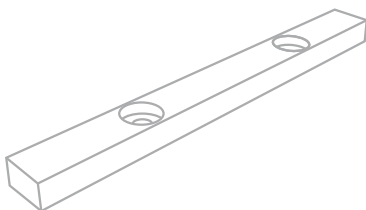

HS Langer Nutenstein PP71
HS Longconnector PP71
Connecteur long HS PP71
Conector largo HS PP71



Hestex Standard 8 mm

Verbinder
Connectorlocks
Connecteurs
Conector

Zubehör
Accessories
Accessoires
Accesorios

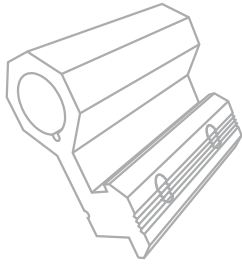

HS Scharnierprofil 8mm
HS Hinge profile 8mm
Profile de charnière HS 8 mm
Perfil de la bisagra HS de 8 mm



Hestex Türen / Doors / Portes / Puertas





Hestex Türen / Doors / Portes / Puertas 4 mm



Hestex Standard Aluminiumsystemtür
Hestex Standard aluminium system door
Hestex Standard l'aluminium porte de système
Hestex Standard puerta de aluminio del sistema

Pro Stück / per piece / par pièce / por unidad

Art. Nr.: **110.25.01** | 1000 x 2500 mm



Hestex 40/40 Aluminiumsystemtür
Hestex 40/40 aluminium system door
Hestex 40/40 l'aluminium porte de système
Hestex 40/40 puerta de aluminio del sistema

Pro Stück / per piece / par pièce / por unidad

Art. Nr.: **140.25.01** | 1000 x 2500 mm

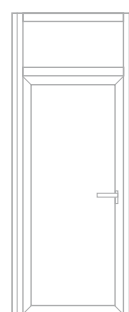

Hestex 80/80 Aluminiumsystemtür
Hestex 80/80 aluminium system door
Hestex 80/80 l'aluminium porte de système
Hestex 80/80 puerta de aluminio del sistema

Pro Stück / per piece / par pièce / por unidad

Art. Nr.: **180.25.01** | 1000 x 2500 mm



Hestex Holztür
Hestex wooden door
Hestex porte en bois
Hestex puerta de madera

Pro Stück / per piece / par pièce / por unidad

Art. Nr.: **100.25.01** | 1000 x 2500 mm



Hestex Türschweller für Systemtür Holz & Alu
Hestex baseplate for system door wood & aluminum
Hestex base de pied par porte en bois & l'aluminium
Hestex placa de soporte par puerta de madera & aluminio

Pro Stück / per piece / par pièce / por unidad

Art. Nr.: **110.25.02**



Hestex Distanzscheibe
Hestex shim
Hestex cale
Hestex calza

Pro Stück / per piece / par pièce / por unidad

Art. Nr.: **110.25.03**

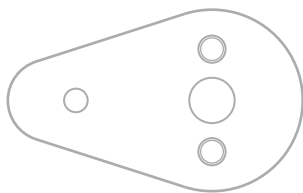

Hestex Standard Fußplatte
Hestex Standard baseplate
Base de pied Hestex Standard
Hestex Standard placa de soporte

Pro Stück / per piece / par pièce / por unidad

Art. Nr.: **110.25.04**

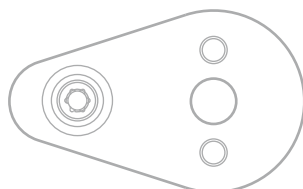

Hestex Standard Fußplatte mit Anschlag
Hestex Standard baseplate
Base de pied Hestex Standard
Hestex Standard placa de soporte

Pro Stück / per piece / par pièce / por unidad

Art. Nr.: **110.25.05**

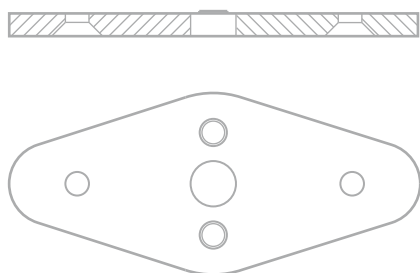

Hestex Standard doppelte Fußplatte
Hestex Standard double baseplate
Base de pied double Hestex Standard
Hestex Standard placa de soporte doble

Pro Stück / per piece / par pièce / por unidad

Art. Nr.: **110.25.06**

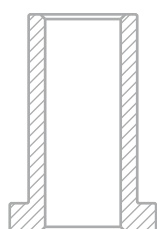

Hestex Standard Türhülse
Hestex Standard door cap
Chapeau de porte Hestex Standard
Hestex Standard casquillo de la puerta

Pro Stück / per piece / par pièce / por unidad

Art. Nr.: **110.25.07**

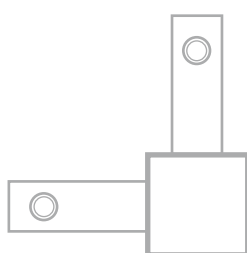

Hestex Standard Verbinder 50 für Türkonstruktion
Hestex Standard connector 50 for door construction
Connecteur construction de porte Hestex Standard 50
Hestex Standard conector 50 par construcción de la puerta

Pro Stück / per piece / par pièce / por unidad

Art. Nr.: **110.25.08**

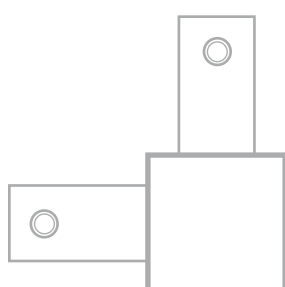

Hestex Standard Verbinder 70 für Türkonstruktion
Hestex Standard connector 70 for door construction
Connecteur construction de porte Hestex Standard 70
Hestex Standard conector 70 par construcción de la puerta

Pro Stück / per piece / par pièce / por unidad

Art. Nr.: **110.25.09**



Hestex Türschweller für Systemtür 40/40
Hestex baseplate for system door 40/40
Hestex base de pied par porte 40/40
Hestex placa de soporte par puerta 40/40

Pro Stück / per piece / par pièce / por unidad

Art. Nr.: **140.25.02**

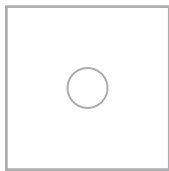

Hestex 40/40 Distanzscheibe
Hestex 40/40 shim
Hestex 40/40 cale
Hestex 40/40 calza

Pro Stück / per piece / par pièce / por unidad

Art. Nr.: **140.25.03**

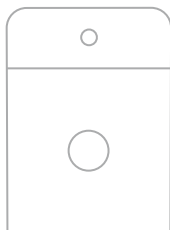

Hestex 40/40 Fußplatte mit Anschlag
Hestex 40/40 baseplate
Base de pied Hestex 40/40
Hestex 40/40 placa de soporte

Pro Stück / per piece / par pièce / por unidad

Art. Nr.: **140.25.04**



Hestex Türschweller für Systemtür 80/80
Hestex baseplate for system door 80/80
Hestex base de pied par porte 80/80
Hestex placa de soporte par puerta 80/80

Pro Stück / per piece / par pièce / por unidad

Art. Nr.: **180.25.02**



Hestex Türen / Doors / Portes / Puertas 8 mm

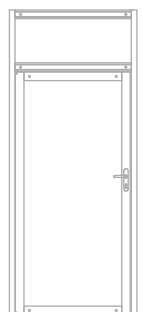

HS Systemtür 8 mm einfach 2500 mm
HS Systemdoor 8 mm single 2500 mm
Système de porte HS 8 mm unique 2500 mm
Sistema de puerta HS de 8 mm única de 2500 mm

Pro Stück / per piece / par pièce / por unidad

Art. Nr.: **110.25.02** | 1000 x 2500 mm

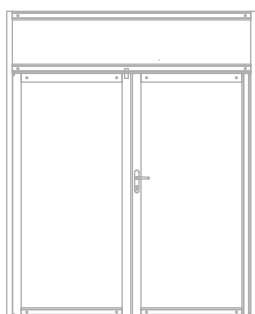

HS Systemtür 8 mm doppelt 2500 mm
HS Systemdoor 8 mm double 2500 mm
Système de porte HS 8 mm double 2500 mm
Sistema de puerta HS de 8 mm doble de 2500 mm

Pro Stück / per piece / par pièce / por unidad

Art. Nr.: **110.25.03** | 1000 x 2500 mm

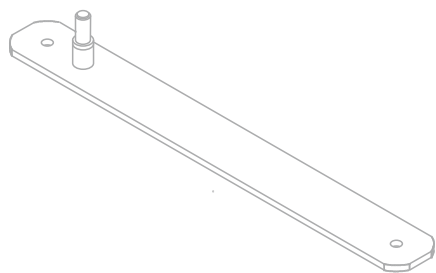

HS Tür-Unterrahmen 8 mm
HS Door underline 8 mm
Cadre de porte HS 8 mm
Línea por debajo de la puerta HS de 8 mm

Pro Stück / per piece / par pièce / por unidad

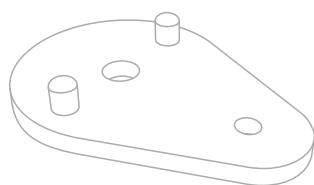

HS Tür-Drehelement oben 8 mm
HS Door turn-top-element 8 mm
Pièce d'accouplement pour porte HS 8 mm
Elemento de cierre basculante superior de la puerta HS de 8 mm

Pro Stück / per piece / par pièce / por unidad



HS Türgriff 8 mm
HS Doorhandle 8 mm
Poignée de porte HS 8 mm
Tirador de la puerta HS de 8 mm

Pro Stück / per piece / par pièce / por unidad

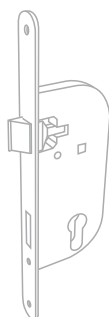

HS Einsteckschloss 8 mm
HS Doorbarrel 8 mm
Baril de porte HS 8 mm
Tambor de la puerta HS de 8 mm

Pro Stück / per piece / par pièce / por unidad



HS Einsteckschloss 8 mm
HS Doorlock 8 mm
Serrure de porte HS 8 mm
Cerradura de la puerta HS de 8 mm

Pro Stück / per piece / par pièce / por unidad



HS Türverbinder 70x70mm
HS Doorconnector 70x70mm
Connecteur de porte HS 70x70mm
Conector de la puerta HS de 70 x 70 mm

Pro Stück / per piece / par pièce / por unidad

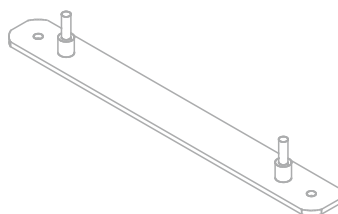

HS Türleiste 2030 mm für Doppeltür
HS Door strip 2030 mm for double door
Plaque pour porte HS 2030 mm pour porte double
Tira de la puerta de 2030 mm HS para puerta puerta doble

Pro Stück / per piece / par pièce / por unidad

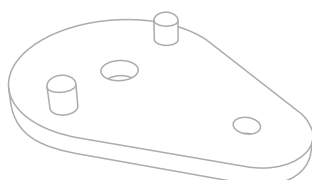

HS Tür S109 Drehelement oben
HS Door S109 Turnelement top
Pièce d'accouplement pour porte S109 HS
Puerta HS Elemento superior basculante S109

Pro Stück / per piece / par pièce / por unidad

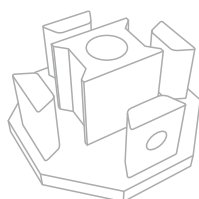

HS Fußplatte S109 mit verstellbarem Fuß
HS Footplate S109 with adjustable foot
Embase HS S109 à pied réglable
Plataforma de la pata HS S109 con pie ajustable

Pro Stück / per piece / par pièce / por unidad



HS Fuß-Montageblock
HS Foot mountingblock
Plaque de montage de pied HS
Bloque de montage de la pata HS

Pro Stück / per piece / par pièce / por unidad



Hestex 80/80

4/8/16 mm

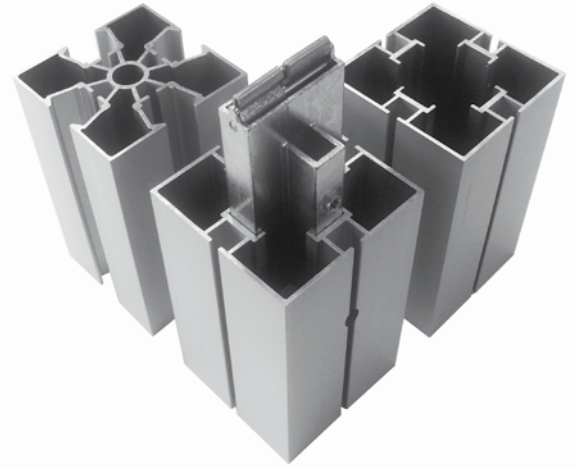

HestexSystems



Hestex 80/80 SGS 7 Verbinder / conector / connecteur / conector

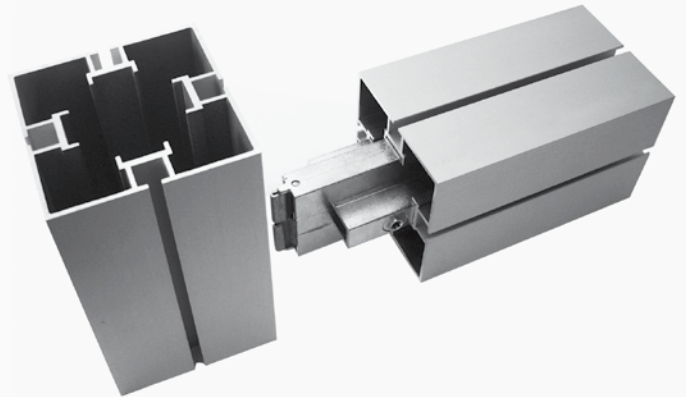

Deutsch

Das Wichtigste ist der Kern von Hestex 80/80.

Durch die Verdoppelung des Außendurchmessers des Hestex- Standard Stützenprofils auf 80mm, erreicht man eine bessere Führung von Quersargen und eine höhere Stabilität. Gleichzeitig erhält man eine völlig veränderte optische Wirkung der Struktur.

Investitionen in unterschiedliche Stützen oder Sonderzargen entfallen, denn die in den Quersargen eingebauten Klemmschlösser schließen an die im Innenkern der großformatigen Stützen hinterlegten Nuten an. Dadurch bleiben die Systemmaße gleich und die im Mietlager der Messebauer bereits vorhandenen Zargen, Ausfachungsplatten, Messetüren und nahezu alle Zubehörteile können weiter verwendet werden.

Ein weiterer Vorteil für den Anwender: Die neuen Hestex 80/80 Stützenprofile sind kompatibel mit dem Standard HestexSystems Systemmaterial, bzw. mit vergleichbaren Aluminiumprofilsystemen. Das bedeutet, dass Sie jetzt Ihr vorhandenes Lagermaterial an Aluminiumprofilen mit den Hestex 80/80 Stützenprofilen optisch und funktionell aufrüsten können. Zur Verkleidung und Schaffung reizvoller optischer Effekte bietet Hestex 80/80 eine Reihe von Lösungsvorschlägen in edlem Design an.

English

The most important feature is the core of Hestex 80/80.

Doubling the external diameter of the Hestex Standard support profile to 80mm provides better cross-frame mounting and increased stability. This also provides a completely different visual impression of the structure.

No investment in different supports or special frames must be made, because the clamps built into the cross frames connect to the grooves in the inner core of the large format supports. This keeps the system dimensions consistent and existing frames, partition sheets, exhibition doors and almost all accessories available in the rental warehouse of the exhibition constructor can be further used.

Another advantage for the user: The new Hestex 80/80 support profiles are compatible with the standard Hestex Systems system material or comparable aluminium profile systems. This allows you to optically and functionally update your existing stocks of aluminium profiles with the Hestex-Plus support profiles. Hestex 80/80 offers a range of fine solution designs for cladding and creating attractive optical effects.





Hestex 80/80 Langverbinder / lengthening connector / Rallonger-morceau / alagar-pedazo



Français

Le plus important chez Hestex 80/80 ; l'élément central.

En doublant le diamètre extérieur du profil Hestex standard à 80 mm, le support des traverses est amélioré et la stabilité est augmentée. Simultanément, l'aspect optique de la structure est profondément modifié.

Il n'est donc plus nécessaire d'investir dans divers supports ou traverses spéciales, puisque les tendeurs intégrés se connectent parfaitement dans la rainure de serrage de cette colonne de grandes dimensions. Ainsi, les dimensions du système sont maintenues et pratiquement tous les accessoires dont dispose déjà le constructeur de stands, tels que traverses, panneaux de séparation, portes, etc., pourront toujours être utilisés.

Un autre avantage pour l'utilisateur : Les nouveaux profils de support Hestex 80/80 sont compatibles avec les composants standard du système Hestex, comme par exemple, les systèmes comparables de profils en aluminium. Cela signifie que vous pouvez désormais compléter les matériaux dont vous disposez déjà, avec les profils de support Hestex 80/80 pour obtenir un ensemble harmonieux et fonctionnel. Hestex 80/80 propose toute une gamme de solutions de design pour l'habillage et pour la création d'élégants effets optiques.

Espagnol

Lo más importante es el núcleo de Hestex 80/80.

Duplicando el diámetro exterior del perfil de apoyo de Hestex-Standard hasta 80 mm se obtiene un mejor montaje de los marcos transversales así como un aumento en la estabilidad. Al mismo tiempo esto proporciona un efecto óptico completamente diferente en la estructura.

Como las abrazaderas integradas en los marcos transversales cierran con las ranuras colocadas en el núcleo interno de los soportes de gran formato, deja de ser necesario invertir en diferentes apoyos y marcos especiales. Gracias a ello las medidas del sistema se mantienen igual y se pueden seguir utilizando los marcos, las láminas divisorias, las puertas para ferias y el resto de piezas auxiliares ya presentes en el almacén de alquiler del constructor de la feria.

Otra de las ventajas para el usuario es que los nuevos perfiles de apoyo Hestex 80/80 son compatibles con el material de sistemas de Hestex Systems estándar o de sistemas de perfiles de aluminio similares. Esto significa que ya puede actualizar su material de almacén de perfiles de aluminio, tanto óptica como funcionalmente hablando, con los perfiles de apoyo Hestex 80/80. Para revestir y obtener atractivos efectos ópticos, Hestex 80/80 ofrece una serie de propuestas con un precioso diseño.



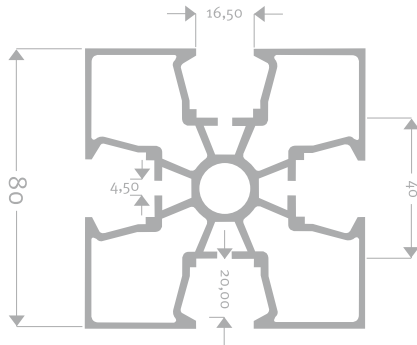

Hestex 80/80 Up Profil-Säule 16mm
Hestex 80/80 Up vertical profile 16mm
Profil de colonne 16mm Hestex 80/80 Up
Hestex 80/80 Up columnas para perfiles 16mm

- Art. Nr.: **180800 6000** | 6000 mm
- Art. Nr.: **1808000 5000** | 5000 mm
- Art. Nr.: **1808000 4000** | 4000 mm
- Art. Nr.: **1808000 3000** | 3000 mm
- Art. Nr.: **1808000 2000** | 2000 mm
- Art. Nr.: **1808000 1000** | 1000 mm

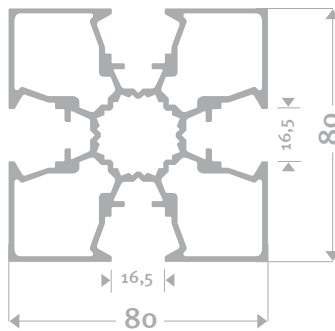

Hestex 80/80 Profil-Säule 8 mm
Hestex 80/80 vertical profile 8 mm
Profil de colonne 8 mm Hestex 80/80
Hestex 80/80 columnas para perfiles 8 mm

- Art. Nr.: **1808003 5000** | 5000 mm
- Art. Nr.: **1808003 4000** | 4000 mm
- Art. Nr.: **1808003 3000** | 3000 mm
- Art. Nr.: **1808003 2000** | 2000 mm
- Art. Nr.: **1808003 1000** | 1000 mm

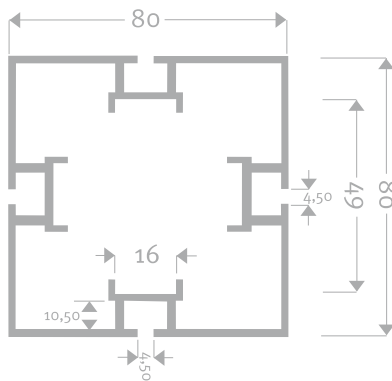

Hestex 80/80 Max Up Profil-Säule 4mm
Hestex 80/80 Max Up vertical profile 4mm
Profil de colonne 4mm Hestex 80/80 Max Up
Hestex 80/80 Max Up columnas para perfiles 4mm

- Art. Nr.: **1808001 6000** | 6000 mm
- Art. Nr.: **1808001 5000** | 5000 mm
- Art. Nr.: **1808001 4000** | 4000 mm
- Art. Nr.: **1808001 3000** | 3000 mm
- Art. Nr.: **1808001 2000** | 2000 mm
- Art. Nr.: **1808001 1000** | 1000 mm

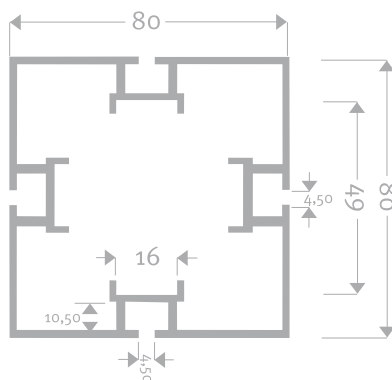

Hestex 80/80 Max Zargen-Profil 4mm
Hestex 80/80 Maxstraight beam 4mm
Profil d'encadrement 4mm Hestex 80/80 Max
Hestex 80/80 Max perfil de ranura 4mm

- Art. Nr.: **1808002 6000** | 6000 mm (*)
- Art. Nr.: **1808002 5000** | 5000 mm (*)
- Art. Nr.: **1808002 4000** | 4000 mm (*)
- Art. Nr.: **1808002 3000** | 3000 mm (*)
- Art. Nr.: **1808002 2000** | 2000 mm (*)
- Art. Nr.: **1808002 1000** | 1000 mm (*)



Hestex 80/80

Verbinder
Connectorlocks
Connecteurs
Conector

Zubehör
Accessories
Accessoires
Accesorios

4/8/16 mm

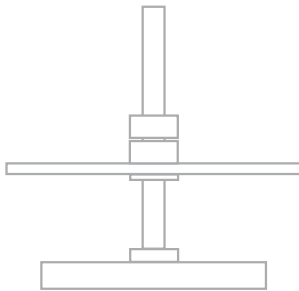

Hestex 80/80 Up Stellfuß
Hestex 80/80 Up Foot
Pied réglable Hestex 80/80 Up
Pie Hestex 80/80 Up

Pro Stück / per piece / par pièce / por unidad

Art. Nr.: **180.80.00**

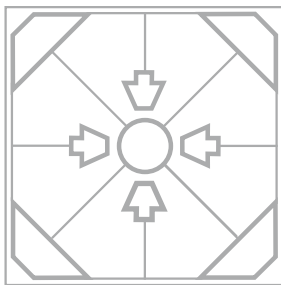

Hestex 80/80 Up Fußplatte 16mm
Hestex 80/80 Up baseplate 16mm
Base de pied Hestex 80/80 Up 16mm
Hestex 80/80 Up placa de soporte 16mm

Pro Stück / per piece / par pièce / por unidad

Art. Nr.: **180.81.00**

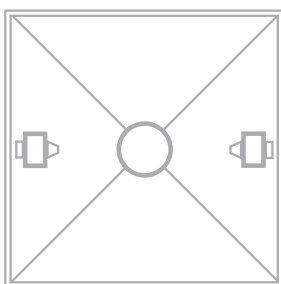

Hestex 80/80 Max Up Fußplatte 4mm
Hestex 80/80 Max Up baseplate 4mm
Base de pied Hestex 80/80 Max Up 4mm
Hestex 80/80 Max Up placa de soporte 4mm

Pro Stück / per piece / par pièce / por unidad

Art. Nr.: **180.82.00**

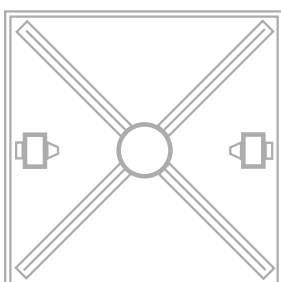

Hestex 80/80 Max Up Abdeckkappe 4mm
Hestex 80/80 Max Up cap 4mm
Hestex 80/80 Max Up capot 4mm
Hestex 80/80 Max Up capuchón de protección 4mm

Pro Stück / per piece / par pièce / por unidad

Art. Nr.: **180.83.00**



Hestex 80/80

Verbinder
Connectorlocks
Connecteurs
Conector

Zubehör
Accessories
Accessoires
Accesorios

4/8/16 mm

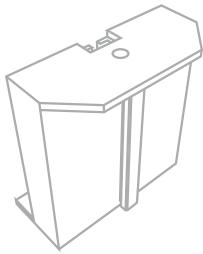

HS Verbinderblock 80 x 80 - 4 mm schwarz
HS Connector block 80 x 80 - 4 mm black
Bloc de connexion 80 x 80 HS - 4 mm noir
Bloque de conexión HS 80 x 80 - 4 mm negro

Pro Stück / per piece / par pièce / por unidad

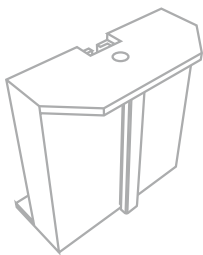

HS Verbinderblock 80 x 80 - 4 mm schwarz
HS Connector block 80 x 80 - 4 mm white
Bloc de connexion 80 x 80 HS - 4 mm blanc
Bloque de conexión HS 80 x 80 - 4 mm blanco

Pro Stück / per piece / par pièce / por unidad

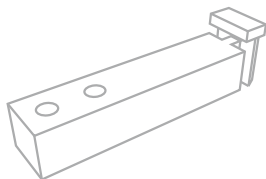

HS Sicherheitsblock 80 x 80 Typ 02
HS Safetyblock 80 x 80 type 02
Bloc de sécurité HS 80 x 80 type 02
Bloqueo de seguridad HS 80 x 80 de tipo 02

Pro Stück / per piece / par pièce / por unidad

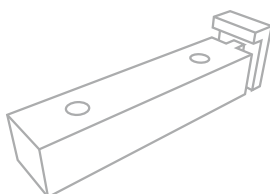

HS Sicherheitsblock 80 x 80 Typ 03
HS Safetyblock 80 x 80 type 03
Bloc de sécurité HS 80 x 80 type 03
Bloqueo de seguridad HS 80 x 80 de tipo 03

Pro Stück / per piece / par pièce / por unidad



Hestex 80/80

Verbinder
Connectorlocks
Connecteurs
Conector

Zubehör
Accessories
Accessoires
Accesorios

4/8/16 mm



Hestex SGS80 Verbinder
Hestex SGS80 connector
Connecteur Hestex SGS80
Hestex SGS80 conector

Pro Stück / per piece / par pièce / por unidad

Art. Nr.: **180.40.31**

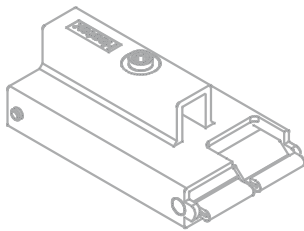

HS Verbinder SGS 80 8 mm
HS Connector SGS 80 8 mm
Connecteur HS SGS 80 8 mm
Conector HS SGS 80 8 mm

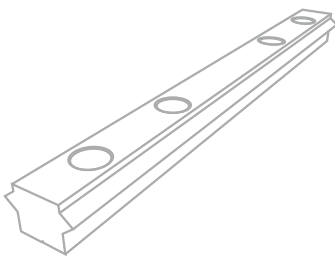

HS Verbinder lang 80 x 80 - 16 mm L = 200 mm
HS Connector long 80 x 80 - 16 mm L = 200 mm
Connecteur HS long 80 x 80 - 16 mm L = 200 mm
Largo del conector HS 80 x 80 - 16 mm L = 200 mm

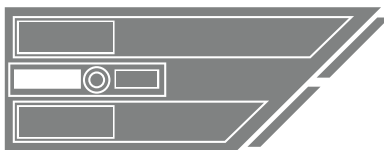

HS Verbinder SGS80 45° rechts
HS Connector SGS80 45° right
Connecteur HS SGS80 45° droit
Conector HS SGS80 45° derecho



Hestex 80/80

Verbinder
Connectorlocks
Connecteurs
Conector

Zubehör
Accessories
Accessoires
Accesorios

4/8/16 mm

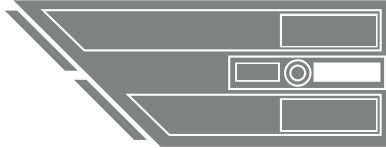

HS Verbinder SGS80 45° links
HS Connector SGS80 45° left
Connecteur HS SGS80 45° liens
Conector HS SGS80 45° enlaces



Hestex Langverbinder für 80/80 4mm
Hestex lengthening connector for 80/80 4mm
Rallonger-morceau de Hestex 80/80 4mm
Hestex alagar-pedazo par 80/80 4mm

Art. Nr.: **180.84.00**



Hestex Langverbinder 12x21x180mm
Hestex lengthening connector 12x21x180mm
Rallonger-morceau 12x21x180mm de Hestex
Hestex alagar-pedazo 12x21x180mm

Art. Nr.: **180.86.00**



Hestex 40/40

4 mm

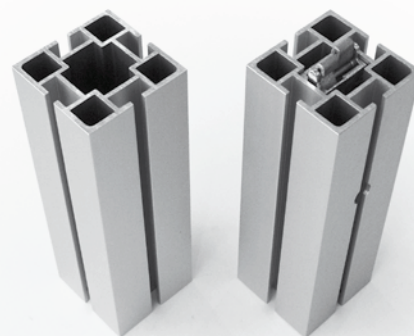

HestexSystems



Hestex 40/40 Profile / profiles / profils / perfiles



Deutsch

Durch des Außendurchmessers des Hestex- 40/40 Stützenprofils auf 40mm, erreicht man eine bessere Führung von Querzargen und eine höhere Stabilität. Gleichzeitig erhält man eine völlig veränderte optische Wirkung der Struktur.

Investitionen in unterschiedliche Stützen oder Sonderzargen entfallen, denn die in den Querzargen eingebauten Klemmschlösser schließen an die im Innenkern der großformatigen Stützen hinterlegten Nuten an. Dadurch bleiben die Systemmaße gleich und die im Mietlager der Messebauer bereits vorhandenen Zargen, Ausfachungsplatten, Messetüren und nahezu alle Zubehörteile können weiter verwendet werden.

Ein weiterer Vorteil für den Anwender: Die neuen Hestex-P40/40 Stützenprofile sind kompatibel mit dem Standard HestexSystems Systemmaterial, bzw. mit vergleichbaren Aluminiumprofilsystemen. Das bedeutet, dass Sie jetzt Ihr vorhandenes Lagermaterial an Aluminiumprofilen mit den Hestex-Plus Stützenprofilen optisch und funktionell aufrüsten können. Zur Verkleidung und Schaffung reizvoller optischer Effekte bietet Hestex-Plus eine Reihe von Lösungsvorschlägen in edlem Design an.

English

Due to the the external diameter of the Hestex 40/40 support profile to 40mm provides better cross-frame mounting and increased stability. This also provides a completely different visual impression of the structure.

No investment in different supports or special frames must be made, because the clamps built into the cross frames connect to the grooves in the inner core of the large format supports. This keeps the system dimensions consistent and existing frames, partition sheets, exhibition doors and almost all accessories available in the rental warehouse of the exhibition constructor can be further used.

Another advantage for the user: The new Hestex-40/40 support profiles are compatible with the standard Hestex Systems system material or comparable aluminium profile systems. This allows you to optically and functionally update your existing stocks of aluminium profiles with the Hestex-Plus support profiles. Hestex-Plus offers a range of fine solution designs for cladding and creating attractive optical effects.





Hestex 40/40 Profiles / profils / perfiles

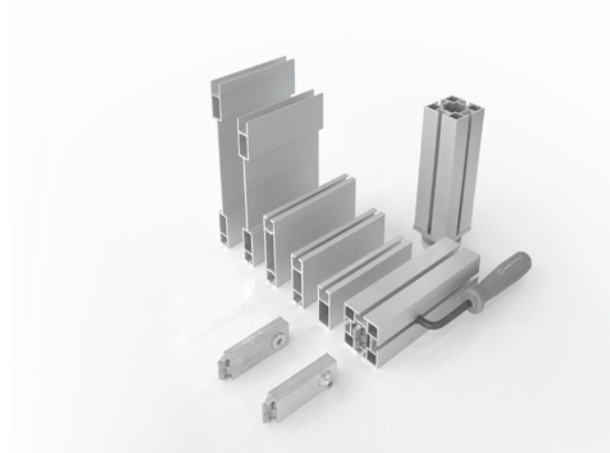

Français

Le diamètre extérieur du profil Hestex 40/40 à 40 mm, le support des traverses est amélioré et la stabilité est augmentée. Simultanément, l'aspect optique de la structure est profondément modifié.

Il n'est donc plus nécessaire d'investir dans divers supports ou traverses spéciales, puisque les tendeurs intégrés se connectent parfaitement dans la rainure de serrage de cette colonne de grandes dimensions. Ainsi, les dimensions du système sont maintenues et pratiquement tous les accessoires dont dispose déjà le constructeur de stands, tels que traverses, panneaux de séparation, portes, etc., pourront toujours être utilisés.

Un autre avantage pour l'utilisateur : Les nouveaux profils de support Hestex-40/40 sont compatibles avec les composants standard du système Hestex, comme par exemple, les systèmes comparables de profils en aluminium. Cela signifie que vous pouvez désormais compléter les matériaux dont vous disposez déjà, avec les profils de support Hestex-Plus pour obtenir un ensemble harmonieux et fonctionnel. Hestex-Plus propose toute une gamme de solutions de design pour l'habillage et pour la création d'élégants effets optiques.

Espagnol

El diámetro exterior del perfil de apoyo de Hestex-40/40 hasta 40 mm se obtiene un mejor montaje de los marcos transversales así como un aumento en la estabilidad. Al mismo tiempo esto proporciona un efecto óptico completamente diferente en la estructura.

Como las abrazaderas integradas en los marcos transversales cierran con las ranuras colocadas en el núcleo interno de los soportes de gran formato, deja de ser necesario invertir en diferentes apoyos y marcos especiales. Gracias a ello las medidas del sistema se mantienen igual y se pueden seguir utilizando los marcos, las láminas divisorias, las puertas para ferias y el resto de piezas auxiliares ya presentes en el almacén de alquiler del constructor de la feria.

Otra de las ventajas para el usuario es que los nuevos perfiles de apoyo Hestex-40/40 son compatibles con el material de sistemas de Hestex Systems estándar o de sistemas de perfiles de aluminio similares. Esto significa que ya puede actualizar su material de almacén de perfiles de aluminio, tanto óptica como funcionalmente hablando, con los perfiles de apoyo Hestex-Plus. Para revestir y obtener atractivos efectos ópticos, Hestex-Plus ofrece una serie de propuestas con un precioso diseño.





Hestex 40/40 4 mm

Profile
Profiles
Profils
Perfiles

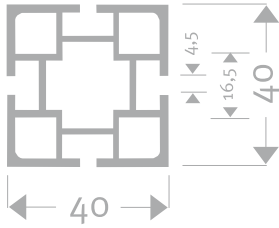

Hestex 40/40 Mini Max Up Profil-Säule
Hestex 40/40 Mini Max Up vertical profile
Profil de colonne Hestex 40/40 Mini Max Up
Hestex 40/40 Mini Max Up columnas para perfiles

Art. Nr.: **1404002 5000** | 5000 mm
Art. Nr.: **1404002 4000** | 4000 mm
Art. Nr.: **1404002 3000** | 3000 mm
Art. Nr.: **1404002 2000** | 2000 mm
Art. Nr.: **1404002 1000** | 1000 mm

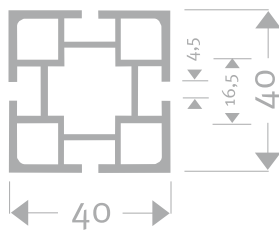

Hestex 40/40 Mini Max Zargen-Profil
Hestex 40/40 Mini Max straight beam
Profils d'encadrement Hestex 40/40 Mini Max
Hestex 40/40 Mini Max perfil de ranura

Art. Nr.: **1404003 5000** | 5000 mm
Art. Nr.: **1404003 4000** | 4000 mm
Art. Nr.: **1404003 3000** | 3000 mm
Art. Nr.: **1404003 2000** | 2000 mm
Art. Nr.: **1404003 1000** | 1000 mm



Hestex 40/40 4 mm

Verbinder
Connectorlocks
Connecteurs
Conector

Zubehör
Accessories
Accessoires
Accesorios



Hestex Standard SGS6 Verbinder
Hestex Standard SGS6 connector
Connecteur Hestex Standard SGS6
Hestex Standard SGS6 conector

Pro Stück / per piece / par pièce / por unidad

Art. Nr.: **110.40.31**



Hestex Standard SGS7 Verbinder
Hestex Standard SGS7 connector
Connecteur Hestex Standard SGS7
Hestex Standard SGS7 conector

Pro Stück / per piece / par pièce / por unidad

Art. Nr.: **110.40.32**

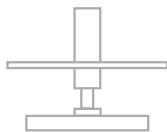

Hestex 40/40 Mini Max Up Stellfuß
Hestex 40/40 Mini Max Up Foot
Pied réglable Hestex 40/40 Mini Max Up
Pie Hestex 40/40 Mini Max Up

Pro Stück / per piece / par pièce / por unidad

Art. Nr.: **140.40.00**



Hestex 40/40 4 mm

Verbinder
Connectorlocks
Connecteurs
Conector

Zubehör
Accessories
Accessoires
Accesorios



Hestex 40/40 Mini Max Up Fußplatte
Hestex 40/40 Mini Max Up baseplate
Base de pied Hestex 40/40 Mini Max Up
Hestex 40/40 Mini Max Up placa de soporte

Pro Stück / per piece / par pièce / por unidad

Art. Nr.: **140.41.00**

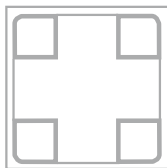

Hestex 40/40 Mini Max Up Abdeckkappe
Hestex 40/40 Mini Max Up cap
Hestex 40/40 Mini Max Up capot
Hestex 40/40 Mini Max Up capuchón de protección

Pro Stück / per piece / par pièce / por unidad

Art. Nr.: **140.42.00**

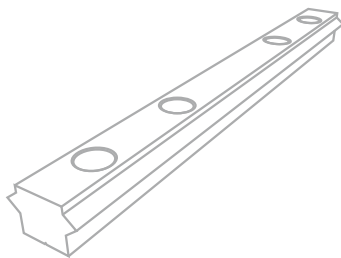

HS Verbinder lang 40 x 40 - 4 mm L = 200 mm
HS Connector long 40 x 40 - 4 mm L = 200 mm
Connecteur HS long 40 x 40 - 4 mm L = 200 mm
Largo del conector HS 40 x 40 - 4 mm L = 200 mm

Pro Stück / per piece / par pièce / por unidad

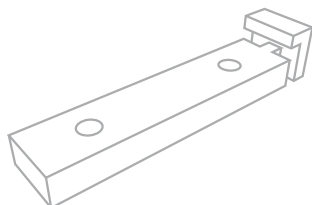

HS Sicherheitsblock 40 x 40 Typ 01
HS Safetyblock 40 x 40 type 01
Bloc de sécurité HS 40 x 40 type 01
Bloqueo de seguridad HS 40 x 40 de tipo 01

Pro Stück / per piece / par pièce / por unidad



Hestex 30/30

4 mm



Hestex 30/30 4 mm

Profile
Profiles
Profils
Perfiles

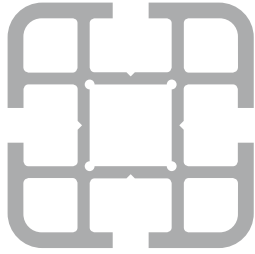

Hestex 30/30 Profil-Saule
Hestex 30/30 vertical profile
Profil de colonne Hestex 30/30
Hestex 30/30 columnas para perfiles

Art. Nr.: 1300301 5000	5000 mm
Art. Nr.: 1300301 4000	4000 mm
Art. Nr.: 1300301 3000	3000 mm
Art. Nr.: 1300301 2000	2000 mm
Art. Nr.: 1300301 1000	1000 mm



Hestex 180° 6/4 mm



HestexSystems



Hestex 180° 6/4 mm

Hestex 180° Profile / profiles / profils / perfiles

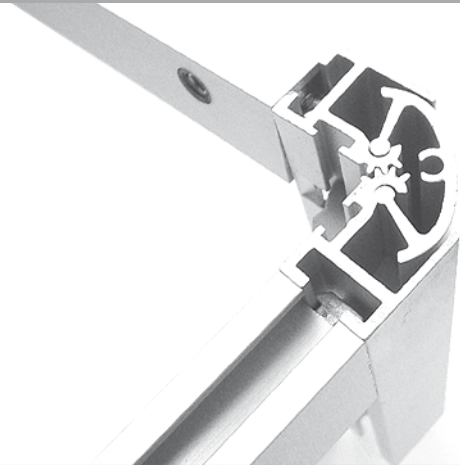

Deutsch

Hestex 180° ist ein vielseitiges 6-mm-Bausystem von Hestex Systems GmbH mit halbrunden und teilweise gezahnten Profilen, wodurch man mehr kreative Freiheit erhält als beim traditionellen Vitrinen-Systemen. Das 180°-System ist unter anderem ideal für die Anfertigung von faltbaren Vitrinen und Theken.

Durch die Flexibilität des Hestex 180°-Systems ist eine Vitrine kostengünstig weltweit zu versenden. Desweiteren sind eine kurze Aufbau- und Montagezeit sowie Bemusterung eine Zeitersparnis für den Außendienst.

Mit dem Hestex 180°-System sind, neben den Standard Vitrinen, auch andere Formen und Größen, Tiefen und Breiten, mit Schiebetüren oder Drehtüren, möglich.

Hestex 180°-System Vitrinen sind auch als Baupaket lieferbar, mit oder ohne Glas, Lichtkranz und Sockel. Das 3-teilige Hestex 180°-System ist in mehreren RAL-Farben lieferbar.

English

The unique Hestex 180° aluminium system allows corner angles from 10°-180°. This instantly gives room for more creative thinking and design capability when considering the benefits and features of your products. Hestex 180° is most ideal for the manufacturing of folding showcases and displays.

Due to the 10°-180° feature of the Hestex 180° aluminium system, transport costs worldwide can be reduced heavily. Besides the reduce of transport-costs the Hestex 180° aluminium system is also practical in quick assembly which reduces labour costs on location of exhibit.

With the Hestex 180° aluminium system you can, besides creating standard showcases and displays, create exciting ones with many different shapes and sizes.

The Hestex 180° aluminium system is also available as "do-it-yourself" construction package, with or without glass, solid panels, lighting or socle. The three-piece Hestex 180° aluminium system is available in a wide range of RAL colours.





Hestex 180° 6/4 mm

Hestex 180° Profile / profiles / profils / perfiles

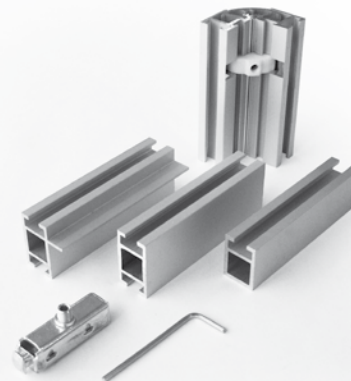

Français

Hestex 180° est un système de construction multifonctionnel de 6 mm de Hestex GmbH avec des profils semi ronds et partiellement dentés, qui permet une plus grande liberté de création que les systèmes de construction de vitrines traditionnels. Le système 180° est, entre autres, idéal pour la construction de vitrines et comptoirs repliables.

Grâce à la flexibilité du système Hestex 180°, il est possible d'envoyer une vitrine autour du monde sans grands frais. En outre, les temps réduits de construction et de montage signifient un grand gain de temps pour les équipes d'installation.

Le système Hestex 180° permet de construire, en outre des vitrines standard, d'autres formes et dimensions, avec portes coulissantes ou classiques.

Les vitrines du système Hestex 180° sont également livrables en tant que kit, avec ou sans vitres, illumination ou socle. Le système Hestex 180° en 3 pièces est livrable en plusieurs coloris RAL.

Español

Hestex 180° es un sistema de construcción variado de 6mm fabricado por Hestex Systems GmbH con perfiles semicirculares y parcialmente dentados, con el que se consigue una libertad más creativa que con el sistema de vitrinas tradicional. El sistema de 180° es ideal, por ejemplo, para la fabricación de vitrinas y mostradores plegables.

Gracias a la flexibilidad del sistema Hestex 180° se puede enviar la vitrina a todo el mundo de forma económica. El rápido montaje y decoración significan un ahorro de tiempo para el servicio de exteriores.

Con el Hestex 180°- System es posible realizar, además de vitrinas estándar, otras formas y tamaños, profundidades y anchos, con puertas correderas o giratorias.

También se pueden suministrar las vitrinas 180° System como paquete de montaje, con o sin vidrio, portalámparas y zócalo. El Hestex 180° System de 3 piezas se suministra en varios colores RAL.





Hestex 180° 6 mm

Profile
Profiles
Profils
Perfiles



Hestex 180° 6 mm Komplett
Hestex 180° 6 mm complete
Hestex 180° 6 mm complet
Hestex 180° 6 mm completo

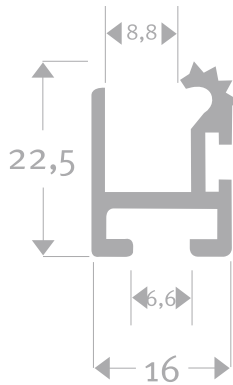

Hestex 180° 6 mm Außenprofil 4-Zahn
Hestex 180° 6 mm outside profile 4-teeth
Profil externe Hestex 180° 6 mm, 4 dents
Hestex 180° 6 mm Perfil exterior 4 dientes

Art. Nr.: **120.10.02** | 5000 mm

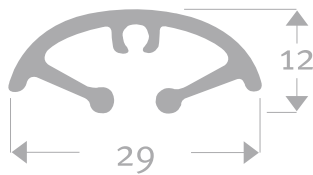

Hestex 180° 6 mm Mittelprofil
Hestex 180° 6 mm middle profile
Profil central Hestex 180° 6 mm
Hestex 180° 6 mm Perfil central

Art. Nr.: **120.15.02** | 5000 mm



Hestex 180° 6 mm Außenprofil 3-Zahn
Hestex 180° 6 mm outside profile 3-teeth
Profil externe Hestex 180° 6 mm, 3 dents
Hestex 180° 6 mm perfil exterior 3 dientes

Art. Nr.: **120.05.02** | 5000 mm



Hestex 180° 6 mm

Profile
Profiles
Profils
Perfiles

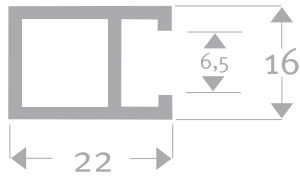

Hestex Einkammer 6 mm
Hestex straight beam 6 mm
Chambre unique Hestex 6 mm
Hestex de cámara única 6 mm

22x16mm

Art. Nr.: **120.30.02** | 5000 mm

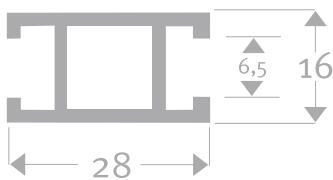

Hestex Doppelkammer ohne Steg 6 mm
Hestex straight beam 6 mm
Chambre double sans bride Hestex 6 mm
Hestex cámara doble sin puente 6 mm

28x16mm

Art. Nr.: **120.25.02** | 5000 mm

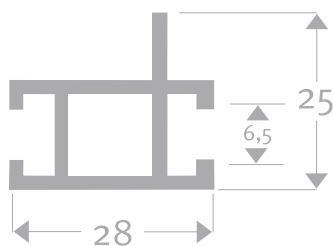

Hestex Doppelkammer mit Steg 6 mm
Hestex straight beam 6 mm
Chambre double avec bride Hestex 6 mm
Hestex cámara doble con puente 6 mm

28x25mm

Art. Nr.: **120.20.02** | 5000 mm



Hestex 180° 4mm

Profile
Profiles
Profils
Perfiles



Hestex 180° 4 mm Komplett
Hestex 180° 4 mm complete
Hestex 180° 4 mm complet
Hestex 180° 4 mm completo

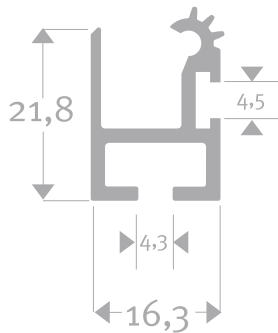

Hestex 180° 4 mm Außenprofil 4-Zahn
Hestex 180° 4 mm outside profile 4-teeth
Profil externe Hestex 180° 4 mm, 4 dents
Hestex 180° 4 mm Perfil exterior 4 dientes

Art. Nr.: **121.10.02** | 5000 mm

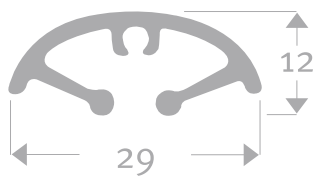

Hestex 180° 4 mm Mittelprofil
Hestex 180° 4 mm middle profile
Profil central Hestex 180° 4 mm
Hestex 180° 4 mm Perfil central

Art. Nr.: **121.15.02** | 5000 mm



Hestex 180° 4 mm Außenprofil 3-Zahn
Hestex 180° 4 mm outside profile 3-teeth
Profil externe Hestex 180° 4 mm, 3 dents
Hestex 180° 4 mm perfil exterior 3 dientes

Art. Nr.: **121.05.02** | 5000 mm



Hestex 180° 4 mm

Profile
Profiles
Profils
Perfiles

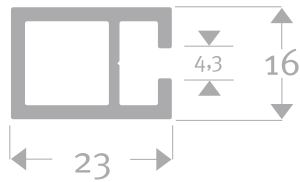

Hestex Einkammer 4 mm
Hestex straight beam 4 mm
Chambre unique Hestex 4 mm
Hestex de cámara única 4 mm

22x16mm

Art. Nr.: **121.30.02** | 5000 mm

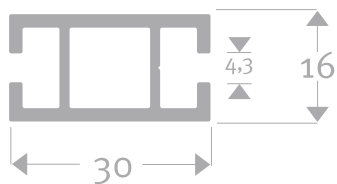

Hestex Doppelkammer ohne Steg 4 mm
Hestex straight beam 4 mm
Chambre double sans bride Hestex 4 mm
Hestex cámara doble sin puente 4 mm

28x16mm

Art. Nr.: **121.25.02** | 5000 mm

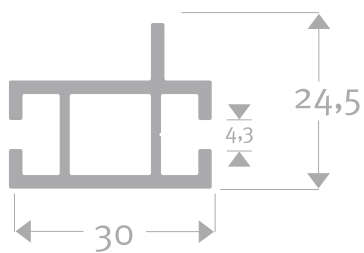

Hestex Doppelkammer mit Steg 4 mm
Hestex straight beam 4 mm
Chambre double avec bride Hestex 4 mm
Hestex cámara doble con puente 4 mm

28x25mm

Art. Nr.: **121.20.02** | 5000 mm



Hestex 180° 4/6mm

Verbinder
Connectorlocks
Connecteurs
Conector

Zubehör
Accessories
Accessoires
Accesorios



Hestex SGS12 Verbinder
Hestex SGS12 connector
Connecteur Hestex SGS12
Hestex SGS12 conector

Pro Stück / per piece / par pièce / por unidad

Art. Nr.: **123.01.00**

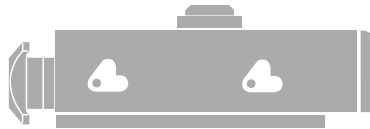

Hestex SGS 12x12 - 6,5 Verbinder
Hestex SGS 12x12 - 6,5 connector
Connecteur Hestex SGS 12x12 - 6,5
Hestex SGS 12x12 - 6,5 conector

Pro Stück / per piece / par pièce / por unidad

Art. Nr.: **120.45.31**

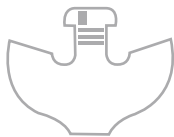

Hestex 180° Bodenträger mit Schraube
Hestex 180° Profilecarrier with screw
Pied de profil avec vis Hestex 180°
Hestex 180° soporte de suelo con tornillo

Pro Stück / per piece / par pièce / por unidad

Art. Nr.: **120.55.11**

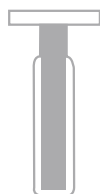

Bodenträger Metall
Profilecarrier metal
Pied de profil métallique
Soporte de suelo de metal

Pro Stück / per piece / par pièce / por unidad

Art. Nr.: **140.30.20**



Hestex 180°_{4/6}mm

Verbinder
Connectorlocks
Connecteurs
Conector

Zubehör
Accessories
Accessoires
Accesorios

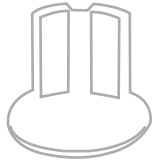

Hestex 180° Fußteller glatt
Hestex 180° Baseplate, plain
Base de pied lisse Hestex 180°
Hestex 180° placa de soporte lisa

Pro Stück / per piece / par pièce / por unidad

Art. Nr.: **120.40.30**

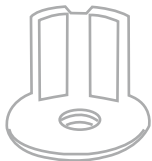

Hestex 180° Fußteller mit Gewinde M10
Hestex 180° Baseplate with screwhead M10
Base de pied à filetage M10 Hestex 180°
Hestex 180° placa de soporte con rosca M10

Pro Stück / per piece / par pièce / por unidad

Art. Nr.: **120.35.30**



Hestex Prisma 6 mm

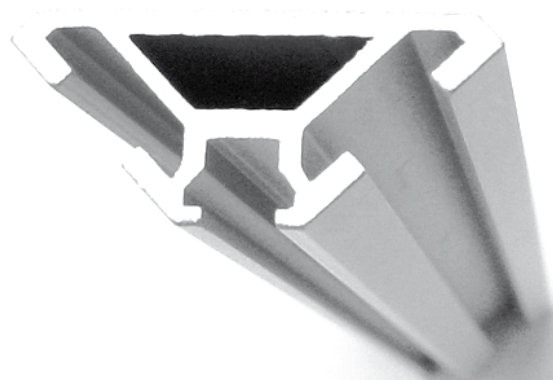



Hestex Prisma 6 mm

Hestex Prisma Profile / profiles / profils / perfiles



Deutsch

Das schlanke Hestex Prisma 6-mm-System, in Kombination mit dem 3-Eck Verbinder, eignet sich besonders für die Herstellung von schick aussehenden Vitrinen und Theken.

Die Hestex Prisma Vitrinen sind geeignet für den Laden- und Ausstellungsbereich. Mit dem Hestex Prisma System ist es möglich, Vitrinen unter 90° oder 135° herzustellen.

Hestex Prisma Vitrinen sind in vielen Abmessungen und RAL-Farben lieferbar, mit Dreh- oder Schiebetür und mit oder ohne Lichtkranz.

English

The slimline Hestex Prisma 6-mm aluminium system, in combination with its practical and classy looking connector, is particularly suitable for the construction of good quality and attractive cost effective showcases and counters.

With Hestex Prisma it's possible to create showcases and counters with angles of 90° and 135°.

Hestex Prisma showcases and counters are available in different sizes and in a wide range of RAL colours, furnished with glass (sliding) doors and with or without lighting.





Hestex Prisma 6 mm

Hestex Prisma Verbinder / connectorlock / connecteur / conector

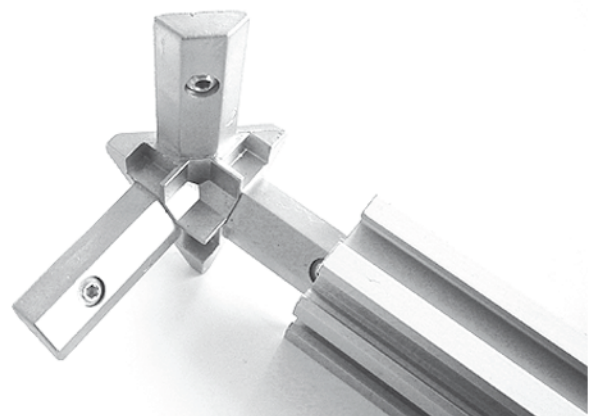

Français

Le délicat système Hestex Prima de 6 mm, en combinaison avec son connecteur triangulaire, est particulièrement approprié pour la réalisation de vitrines et comptoirs très élégants.

Les vitrines Hestex Prisma sont appropriées pour le stockage et l'exposition. Le système Hestex Prisma permet de réaliser des vitrines en angles de 90° ou de 135°.

Les vitrines Hestex Prisma sont livrables en plusieurs dimensions et coloris RAL, avec porte coulissante ou classique, avec ou sans illumination.

Espagnol

El delgado Hestex Prisma System de 6 mm, en combinación con el conector en triángulo, es especialmente apto para la fabricación de vitrinas y mostradores elegantes.

Las vitrinas Hestex Prisma son aptas para la zona de la tienda y la exhibición. Con el Hestex Prisma System es posible fabricar vitrinas con menos de 90° o 135°.

Las vitrinas Hestex Prisma se suministran en muchos tamaños y colores RAL, con puertas giratorias o correderas y con o sin portalámparas.





Hestex Prisma 6 mm

Profile
Profiles
Profils
Perfiles

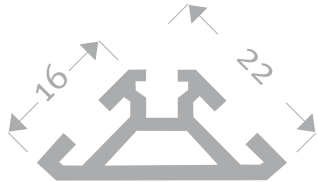

Hestex Prisma Basisprofil 90°
Hestex Prisma main profile 90°
Profil de base Hestex Prisma 90°
Hestex Prisma perfil base 90°

22x16mm

Art. Nr.: **140.10.02** | 5000 mm

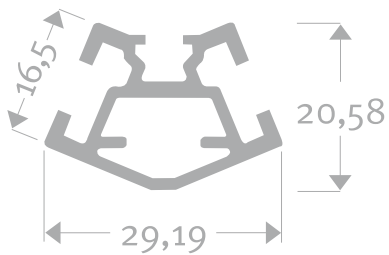

Hestex Prisma Basisprofil 135°
Hestex Prisma main profile 135°
Profil de base Hestex Prisma 135°
Hestex Prisma perfil base 135°

16,5x20,58mm

Art. Nr.: **140.11.02** | 5000 mm

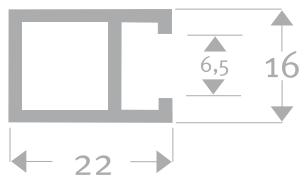

Hestex Einkammer 6mm
Hestex straight beam 6mm
Chambre unique Hestex 6mm
Hestex de cámara única 6mm

22x16mm

Art. Nr.: **120.30.02** | 5000 mm

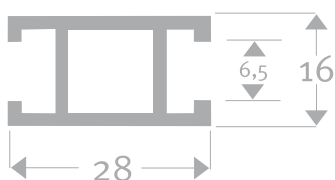

Hestex Doppelkammer ohne Steg 6mm
Hestex straight beam 6mm
Chambre double sans bride Hestex 6mm
Hestex cámara doble sin puente 6mm

28x16mm

Art. Nr.: **120.25.02** | 5000 mm



Hestex Prisma 6 mm

Profile
Profiles
Profils
Perfiles

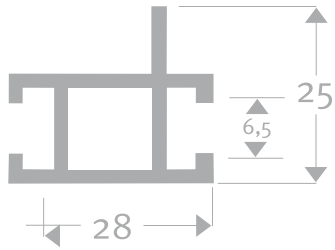

Hestex Doppelkammer mit Steg 6mm
Hestex straight beam 6mm
Chambre double avec bride Hestex 6mm
Hestex cámara doble con puente 6mm

28x25mm

Art. Nr.: **120.20.02** | 5000 mm



Hestex Prisma 6 mm

Verbinder
Connectorlocks
Connecteurs
Conector

Zubehör
Accessories
Accessoires
Accesorios

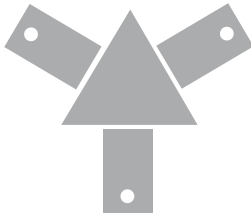

Hestex Prisma Eckverbinder roh
Hestex Prisma cornerconnector raw
Connecteur de coin nu Hestex Prisma
Hestex Prisma conector angular en bruto

Pro Stück / per piece / par pièce / por unidad

Art. Nr.: **140.20.30**

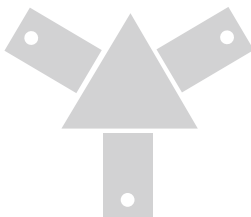

Hestex Prisma Eckverbinder matt
Hestex Prisma cornerconnector mat
Connecteur de coin mat Hestex Prisma
Hestex Prisma conector angular mate

Pro Stück / per piece / par pièce / por unidad

Art. Nr.: **140.20.31**

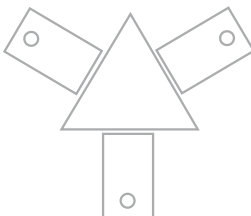

Hestex Prisma Eckverbinder chrom
Hestex Prisma cornerconnector chromium
Connecteur de coin chromé Hestex Prisma
Hestex Prisma conector angular cromado

Pro Stück / per piece / par pièce / por unidad

Art. Nr.: **140.20.32**

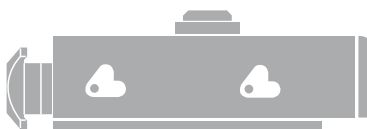

Hestex SGS 12x12 -6,5 Verbinder
Hestex SGS 12x12 -6,5 connector
Connecteur Hestex SGS 12x12 -6,5
Hestex SGS 12x12 -6,5 conector

Pro Stück / per piece / par pièce / por unidad

Art. Nr.: **120.45.31**



Hestex Prisma 6 mm

Verbinder
Connectorlocks
Connecteurs
Conector

Zubehör
Accessories
Accessoires
Accesorios

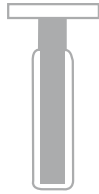

Bodenträger Metall
Profilecarrier metal
Pied de profil métallique
Soporte de suelo de metal

Pro Stück / per piece / par pièce / por unidad

Art. Nr.: **140.30.20**



Hestex Prisma Knotenplatte 90° Innengewinde M10
Hestex Prisma baseplate 90° with screwhead M10
Plaque 90° à filetage M10 Hestex Prisma
Hestex Prisma placa de nudos 90° con rosca M10

Pro Stück / per piece / par pièce / por unidad

Art. Nr.: **110.44.02**

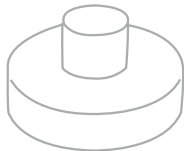

Stellfuß Chrom mit Gewinde M10
Foot chromium with screwhead M10
Pied réglable chromé à filetage M10
Pie cromado con rosca M10

Pro Stück / per piece / par pièce / por unidad

Art. Nr.: **140.30.21**



Hestex SN23 4 mm





Hestex SN23 4 mm

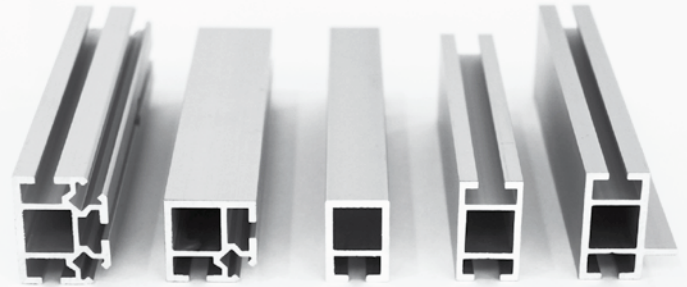

Hestex SN23 Profile / profiles / profils / perfiles

Deutsch

Das Hestex SN23 4-mm-System, in Kombination mit unserem Eckverbinder SN 23, eignet sich besonders für die Herstellung von schicken, schlanken Vitrinen, Würfeln und auch Theken.

Hestex SN23 Profile sind geeignet für den Laden- und Ausstellungsbereich, sowie kombinierbar mit Hestex Standard oder anderen 4-mm-Ausstellungs-Systemen.

Hestex SN23 Vitrinen, Würfel und Theken sind in vielen Abmessungen und RAL- Farben lieferbar, mit Dreh- oder Schiebetür und Beleuchtung. Der Hestex SN23 Eckverbinder ist lieferbar in Roh, Matt oder Chrom.

English

The Hestex SN23 4mm system combined with our SN 23 corner connector is especially well-suited for building chic, streamlined cabinets, cubes and counters.

Hestex SN23 4mm profiles can be used for store and exhibit applications and can be combined with the Hestex Standard or other 4mm display systems.

Hestex SN23 cabinets, cubes and counters are available in a wide variety of dimensions and RAL colours and can be had with revolving or sliding doors as well as lighting. The Hestex SN 23 corner connector is available in natural, matte or chrome.





Hestex SN23 4 mm



Hestex SN23 Profiles / profils / perfiles

Français

En combinaison avec notre connecteur en coin SN 23, le système Hestex SN23 4mm se prête particulièrement à la fabrication de vitrines élégantes à formes délicates, de cubes et également de comptoirs.

Les profils Hestex SN23 conviennent aussi bien pour les locaux commerciaux que d'exposition et sont combinables avec le système Hestex Standard ou d'autres systèmes d'exposition 4mm.

Les vitrines, cubes et comptoirs Hestex SN23 sont disponibles en diverses tailles et couleurs RAL, avec porte pivotante ou coulissante et éclairage. Le connecteur en coin SN23 est livrable en nu, mat ou chromé.

Espagnol

El sistema HestexSN23 de 4 mm, en combinación con nuestro sistema de unión de esquinas SN 23, es especialmente adecuado para la fabricación de elegantes y delicadas vitrinas, cubos y mostradores.

Los perfiles HestexSN23 son adecuados para el ámbito de los negocios y de la exposición. También se pueden combinar con Hestex Standard u otros sistemas para exposición de 4 mm.

Las vitrinas Hestex SN23, cubos y mostradores está disponibles en varias dimensiones y colores RAL, con puerta giratoria o corredera e iluminación. El sistema de unión de esquinas Hestex SN23 está disponible sin acabado, mate o cromo.





Hestex SN23 4 mm

Profile
Profiles
Profils
Perfiles

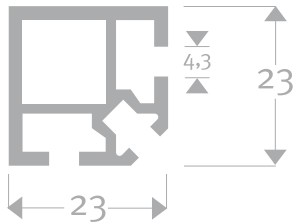

Hestex SN23 Doppelkammer 4 mm
Hestex SN23 double beam 4 mm
Chambre double SN23 Hestex 4 mm
Hestex SN23 cámara doble 4 mm

Art. Nr.: **123.10.00** | 5000 mm

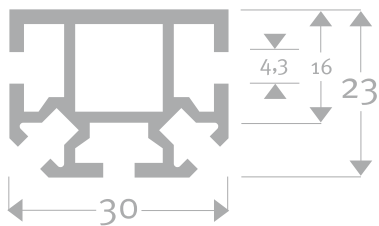

Hestex SN23 Dreikammer 4 mm
Hestex SN23 tripple beam 4 mm
Chambre trois Hestex SN23 4 mm
Hestex SN23 de cámara tres 4 mm

Art. Nr.: **123.20.00** | 5000 mm

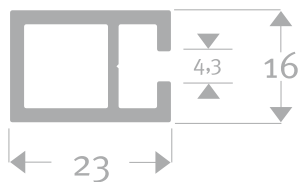

Hestex Einkammer 4 mm
Hestex straight beam 4 mm
Chambre unique Hestex 4 mm
Hestex de cámara única 4 mm

22x16mm

Art. Nr.: **121.30.02** | 5000 mm

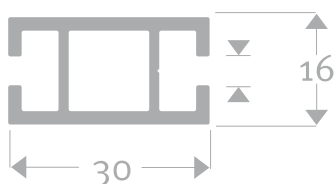

Hestex Doppelkammer ohne Steg 4 mm
Hestex straight beam 4 mm
Chambre double sans bride Hestex 4 mm
Hestex cámara doble sin puente 4 mm

28x16mm

Art. Nr.: **121.25.02** | 5000 mm



Hestex SN23 4 mm

Profile
Profiles
Profils
Perfiles

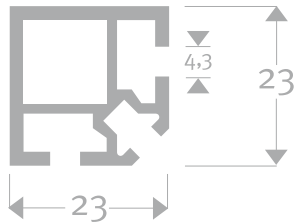

Hestex SN23 Doppelkammer 4 mm
Hestex SN23 double beam 4 mm
Chambre double SN23 Hestex 4 mm
Hestex SN23 cámara doble 4 mm

Art. Nr.: **123.10.00** | 5000 mm

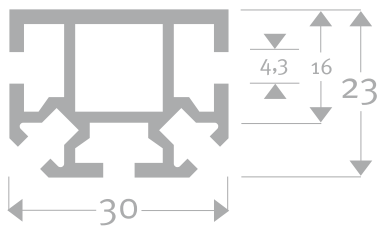

Hestex SN23 Dreikammer 4 mm
Hestex SN23 tripple beam 4 mm
Chambre trois Hestex SN23 4 mm
Hestex SN23 de cámara tres 4 mm

Art. Nr.: **123.20.00** | 5000 mm

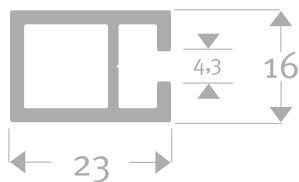

Hestex Einkammer 4 mm
Hestex straight beam 4 mm
Chambre unique Hestex 4 mm
Hestex de cámara única 4 mm

22x16mm

Art. Nr.: **121.30.02** | 5000 mm

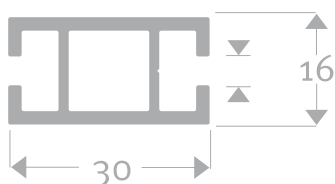

Hestex Doppelkammer ohne Steg 4 mm
Hestex straight beam 4 mm
Chambre double sans bride Hestex 4 mm
Hestex cámara doble sin puente 4 mm

28x16mm

Art. Nr.: **121.25.02** | 5000 mm



Hestex SN23 4 mm

Verbinder
Connectorlocks
Connecteurs
Conector



Hestex SGS12 Verbinder
Hestex SGS12 connector
Connecteur Hestex SGS12
Hestex SGS12 conector

Pro Stück / per piece / par pièce / por unidad

Art. Nr.: **123.01.00**

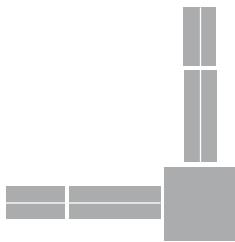

Hestex SN23 Eckverbinder 90° roh
Hestex SN23 cornerconnector 90° raw
Connecteur de coin 90° nu Hestex SN23
Hestex SN23 conector angular 90° en bruto

Pro Stück / per piece / par pièce / por unidad

Art. Nr.: **123.01.01**

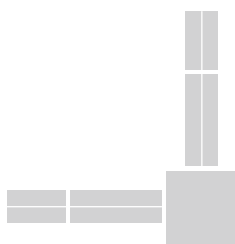

Hestex SN23 Eckverbinder 90° matt
Hestex SN23 cornerconnector 90° mat
Connecteur de coin 90° mat Hestex SN23
Hestex SN23 conector angular 90° mate

Pro Stück / per piece / par pièce / por unidad

Art.Nr.: **123.01.02**

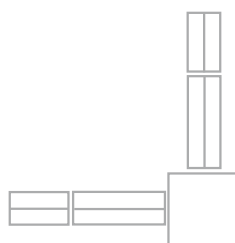

Hestex SN23 Eckverbinder 90° chrom
Hestex SN23 cornerconnector 90° chromium
Connecteur de coin 90° chromé Hestex SN23
Hestex SN23 conector angular 90° cromado

Pro Stück / per piece / par pièce / por unidad

Art.Nr.: **123.01.03**



Hestex SN50 6 mm

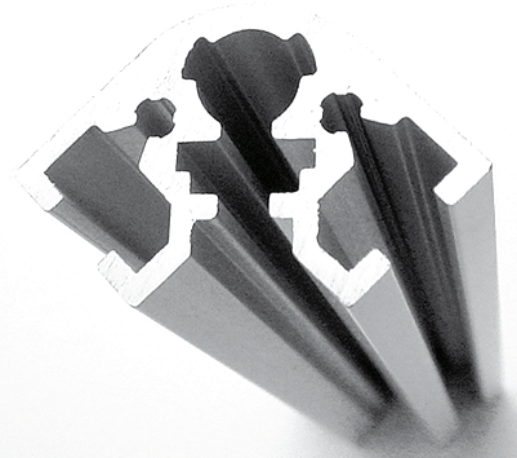



Hestex SN50 6 mm

Hestex SN50 Profile / profiles / profils / perfiles

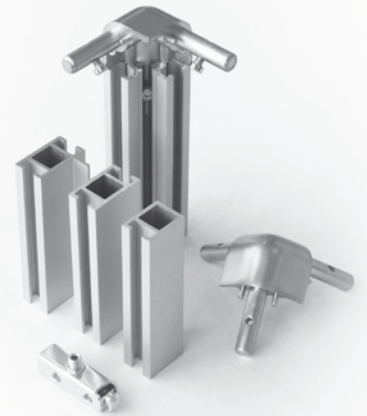

Deutsch

Das Hestex 50-System ist Bestandteil des Hestex Standard-Systems und durch Hestex Systems GmbH für den Vitrinen- und Thekenbau entwickelt worden. Durch die soliden Profile ist es jetzt möglich, Vitrinen und Theken mit schwereren Produkten auszustatten.

Hestex SN50 Vitrinen und Theken sind in vielen Abmessungen mit oder ohne Glas, ausgestattet mit Schiebetüren oder Drehtüren, Lichtkranz und Sockel lieferbar.

Hestex SN50 Vitrinen und Theken sind in mehreren RAL-Farben lieferbar.

English

The Hestex SN50 aluminium system is related to the Hestex Standard aluminium system. Hestex SN50 is particularly suitable for creating showcases and displays if you have to put more heavy weighted products on exhibit.

Hestex SN 50 showcases and displays can be delivered with glass, (sliding) doors, lighting and with or without a socle.

The Hestex SN50 aluminium system is available in a wide range of RAL colours.





Hestex SN50 6 mm

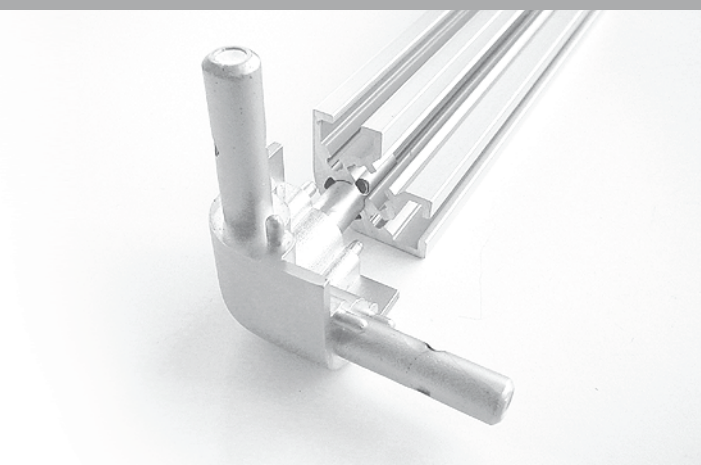

Hestex SN50 Verbinder / connectorlock / connecteur / conector

Français

Le système Hestex 50 est un composant du système Hestex Standard et a été développé par Hestex Systems GmbH pour la construction de vitrines et de comptoirs. Grâce aux solides profils, il est désormais possible de placer des produits plus lourds dans les vitrines et comptoirs.

Les vitrines et comptoirs Hestex SN50 sont livrables en plusieurs dimensions, avec ou sans vitres, avec porte coulissante ou classique, avec ou sans illumination ou socle.

Les vitrines et comptoirs SN50 sont livrables en plusieurs coloris RAL.

Espagnol

El Hestex 50-System es parte del Hestex Standard-System y ha sido desarrollado por Hestex Systems GmbH para la construcción de vitrinas y mostradores. Gracias a los resistentes perfiles, es posible llenar las vitrinas y mostradores con productos pesados.

Las vitrinas y mostradores Hestex SN50 vienen en muchos tamaños, con o sin vidrio, puertas correderas o giratorias, portalámparas y zócalo. Las vitrinas y mostradores

Hestex SN50 se pueden suministrar en varios colores RAL.





Hestex SN50 6 mm

Profile
Profiles
Profils
Perfiles

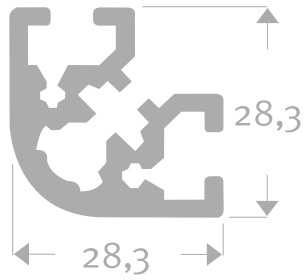

Hestex SN50 Profil-Säule
Hestex SN50 vertical profile
Profil de colonne Hestex SN50
Hestex SN50 columna del perfil

Art. Nr.: **150.01.01** | 5000 mm

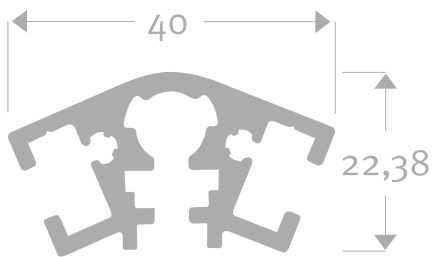

Hestex SN50 Profil-Säule 135°
Hestex SN50 vertical profile 135°
Profil de colonne 135° Hestex SN50
Hestex SN50 columna del perfil 135°

Art. Nr.: **150.04.01** | 5000 mm

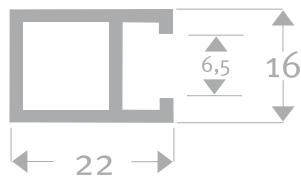

Hestex Einkammer 6mm
Hestex straight beam 6mm
Chambre unique Hestex 6mm
Hestex de cámara única 6mm

22x16mm

Art. Nr.: **120.30.02** | 5000 mm

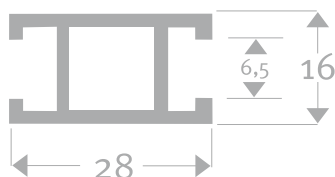

Hestex Doppelkammer ohne Steg 6mm
Hestex straight beam 6mm
Chambre double sans bride Hestex 6mm
Hestex cámara doble sin puente 6mm

28x16mm

Art. Nr.: **120.25.02** | 5000 mm



Hestex SN50 6 mm

Profile
Profiles
Profils
Perfiles

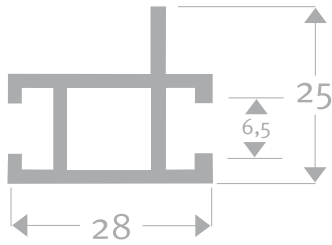

Hestex Doppelkammer mit Steg 6mm
Hestex straight beam 6mm
Chambre double avec bride Hestex 6mm
Hestex cámara doble con puente 6mm

28x25mm

Art. Nr.: **120.20.02** | 5000 mm



Hestex SN50 6 mm

Verbinder
Connectorlocks
Connecteurs
Conector

Zubehör
Accessories
Accessoires
Accesorios



Hestex SN50 Eckverbinder 90° roh
Hestex SN50 cornerconnector 90°raw
Connecteur de coin 90° nu Hestex SN50
Hestex SN50 conector angular 90° en bruto

Pro Stück / per piece / par pièce / por unidad

Art. Nr.: **150.02.00**



Hestex SN50 Eckverbinder 90° matt
Hestex SN50 cornerconnector 90° mat
Connecteur de coin 90° mat Hestex SN50
Hestex SN50 conector angular 90° mate

Pro Stück / per piece / par pièce / por unidad

Art.Nr.: **150.02.01**

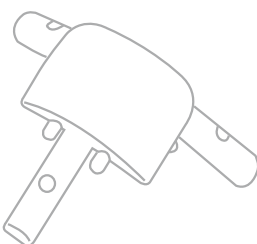

Hestex SN50 Eckverbinder 90° chrom
Hestex SN50 cornerconnector 90° chromium
Connecteur de coin 90° chromé Hestex SN50
Hestex SN50 conector angular 90° cromado

Pro Stück / per piece / par pièce / por unidad

Art.Nr.: **150.02.02**

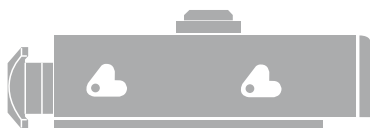

Hestex SGS 12x12 - 6,5 Verbinder
Hestex SGS 12x12 - 6,5 connector
Connecteur Hestex SGS 12x12 - 6,5
Hestex SGS 12x12 - 6,5 conector

Pro Stück / per piece / par pièce / por unidad

Art. Nr.: **120.45.31**



Hestex SN50 6 mm

Verbinder
Connectorlocks
Connecteurs
Conector

Zubehör
Accessories
Accessoires
Accesorios

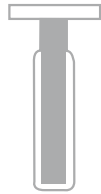

Bodenträger Metall
Profilecarrier metal
Pied de profil métallique
Soporte de suelo de metal

Pro Stück / per piece / par pièce / por unidad

Art. Nr.: **140.30.20**



Hestex SN50 Fußplatte 90° mit Gewinde M10
Hestex SN50 baseplate 90° with screwhead M10
Base de pied 90° Hestex SN50 à filetage M10
Hestex SN50 placa de soporte 90° con rosca M10

Pro Stück / per piece / par pièce / por unidad

Art. Nr.: **150.03.00**



Zubehör . Accessories . Accessoires . Accesorios





SN 220 Hammerkopfschraube 20mm
SN 220 Screw 20mm
SN 220 Vis 20mm
SN 220 tornillo con cabeza en forma de tornillo 20mm

Pro Stück / per piece / par pièce / por unidad

Art. Nr.: **110.42.20**



SN 220 Hammerkopfschraube 40mm
SN 220 Screw 40mm
SN 220 Vis 40mm
SN 220 tornillo con cabeza en forma de tornillo 40mm

Pro Stück / per piece / par pièce / por unidad

Art. Nr.: **110.42.40**

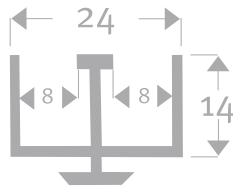

Doppelführung TYP 96 oben, Aluminium
Upper double slide guide TYPE 96, aluminum
Double guide supérieur TYPE 96 l'aluminium
Cañón doble MODELO 96 parte superior aluminio

Art. Nr.: **110.68.02** | 5000 mm

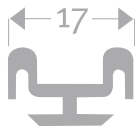

Doppellauf TYP 96 unten, Aluminium
Lower double slide guide TYPE 96, aluminium
Double guide inférieur TYPE 96 l'aluminium
Cañón doble MODELO 96 parte inferior aluminio

Art. Nr.: **110.69.02** | 5000 mm

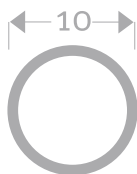

Rundrohr 10mm
Round pipe 10mm
Pipe ronde 10mm
Pipa redonda 10mm

Art. Nr.: **110.49.11** | 5000 mm

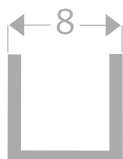

U-Profil 8 x 8 x 1mm
U-Profile 8 x 8 x 1mm
U-Profil 8 x 8 x 1mm
U-Perfil 8 x 8 x 1mm

Art. Nr.: **110.50.12** | 5000 mm



Schiebetürprofil silber oben, Kunststoff
Upper double slide guide, synthetic material
Profil supérieur pour porte coulissante, plastique argenté
Perfil para puerta corredera plateado parte superior / Plástico

Art. Nr.: **110.54.13** | 5000 mm



Schiebetürprofil silber unten, Kunststoff
Lower double slide guide, synthetic material
Profil inférieur pour porte coulissante, plastique argenté
Perfil para puerta corredera plateado parte inferior / Plástico

Art. Nr.: **110.55.13** | 5000 mm



Seitenführungsprofil, Aluminium
Single side slide guide, aluminium
Profil de support latéral l'aluminium
Perfil de guía lateral aluminio

Art. Nr.: **110.70.02** | 5000 mm

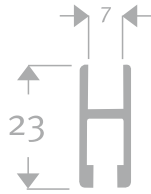

N 56 Laufsuhprofil
N 56 Sliding door profile
N 56 Profil coulissant
N 56 Perfil para pata deslizante

Art. Nr.: **110.62.01** | 5000 mm



Anwendungsbeispiel PS 20 / PS 10
Passend für Hestex Standard 4 mm Glas oder Holz

Slidingbeam example PS 20 / PS 10
Suitable for Hestex Standard

Exemple d'utilisation pour PS 20 / PS 10
Approprié pour système Hestex Standard 4 mm ver ou bois

Ejemplo de uso PS 20 / PS 10
Para Hestex Standard 4 mm vidrio o madera



Gummikappe für Hammerkopfschraube
Cap for screw
Capot caoutchouc pour vis
Caperuza de goma para tornillo

Pro Stück / per piece / par pièce / por unidad

Art. Nr.: **140.30.33**



Rolleneinsatz
Roller element
Roulette pour rail
Carril deslizante

Pro Stück / per piece / par pièce / por unidad

Art. Nr.: **110.65.00**

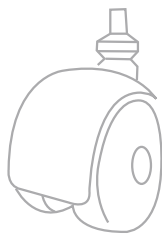

Lenkrolle mit Gewinde M10
Castor, black, with screwhead M10
Roulette inclinable à filetage M10
Rodillo guía con rosca M10

Pro Stück / per piece / par pièce / por unidad

Art. Nr.: **110.50.11**



Lenkrolle mit Stopper & Gewinde M10
Castor, black, with brake & screwhead M10
Roulette inclinable avec arrêt à filetage M10
Rodillo guía con freno & rosca M10

Pro Stück / per piece / par pièce / por unidad

Art. Nr.: **110.48.12**



Endkappe offen
End cap open
Capot final ouvert
Capuchón final abierto

Pro Stück / per piece / par pièce / por unidad

Art. Nr.: **110.63.00**



Endkappe geschlossen
End cap closed
Capot final fermé
Capuchón final cerrado

Pro Stück / per piece / par pièce / por unidad

Art. Nr.: **110.64.00**

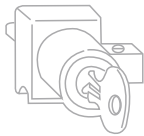

Laufschuhschloss
Cylinderlock
Serrure à cylindre
Cierre de palanca para cilindro

Pro Stück / per piece / par pièce / por unidad

Art. Nr.: **110.66.00**

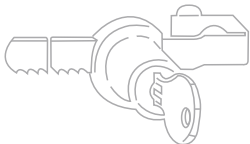

Zahnstangenschloss
Lock
Serrure à tige dentée
Cierre de cremallera

Pro Stück / per piece / par pièce / por unidad

Art. Nr.: **110.67.00**



Hestex XS



HestexSystems



Hestex XS

Profile
Profiles
Profils
Perfiles



Hestex PP37 Stoff-Profil
Hestex PP37 fabric profile
Profil de tissu Hestex PP37
Hestex PP37 Perfil de tela

Art. Nr.: **2002001 5000** | 5000 mm

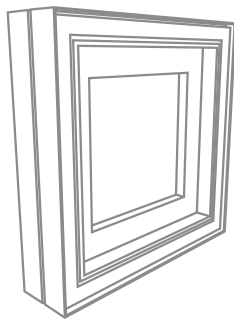

Hestex XS Frame
Hestex XS Rahmen
Hestex XS Cadres
Hestex XS Marcos

0495 x 0495 mm

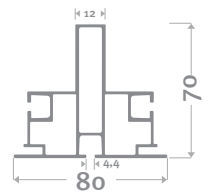

Hestex XS Frame
Hestex XS Rahmen
Hestex XS Cadres
Hestex XS Marcos

0495 x 0990 mm

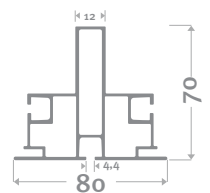

Hestex XS Frame
Hestex XS Rahmen
Hestex XS Cadres
Hestex XS Marcos

0495 x 1485 mm

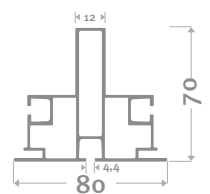



Hestex XS

Profile
Profiles
Profils
Perfiles



Hestex XS Frame
Hestex XS Rahmen
Hestex XS Cadres
Hestex XS Marcos

0495 x 1980 mm

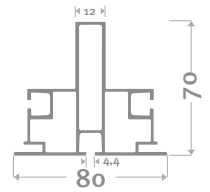

Hestex XS Frame
Hestex XS Rahmen
Hestex XS Cadres
Hestex XS Marcos

0495 x 2475 mm

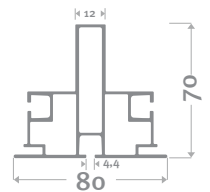

Hestex XS Frame
Hestex XS Rahmen
Hestex XS Cadres
Hestex XS Marcos

0495 x 2970 mm

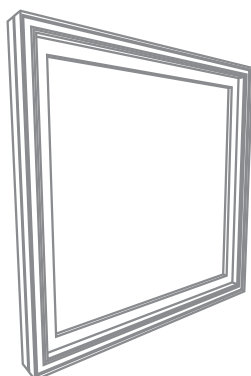
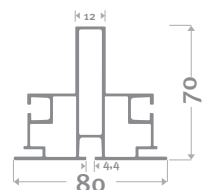

Hestex XS Frame
Hestex XS Rahmen
Hestex XS Cadres
Hestex XS Marcos

0990 x 0990 mm

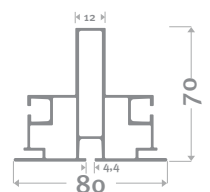

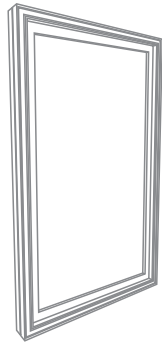

Hestex XS Frame
Hestex XS Rahmen
Hestex XS Cadres
Hestex XS Marcos

0990 x 1485 mm

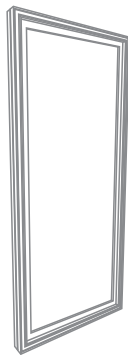
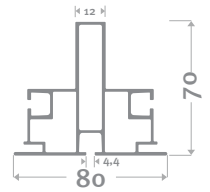

Hestex XS Frame
Hestex XS Rahmen
Hestex XS Cadres
Hestex XS Marcos

0990 x 1980 mm

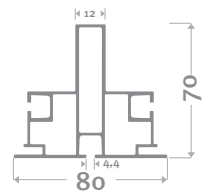

Hestex XS Frame
Hestex XS Rahmen
Hestex XS Cadres
Hestex XS Marcos

0990 x 2475 mm

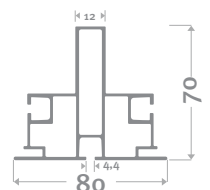

Hestex XS Frame
Hestex XS Rahmen
Hestex XS Cadres
Hestex XS Marcos

0990 x 2970 mm

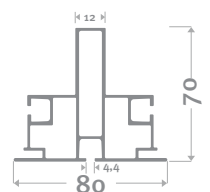



Hestex XS

Verbinder
Connectorlocks
Connecteurs
Conector

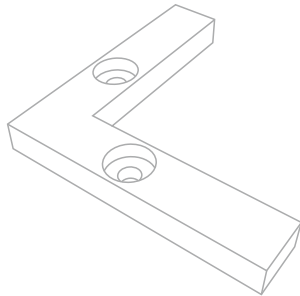

HS Eckverbinder Slimframe-Profil
HS Cornerconnector slimframe profile
Connecteur de coin pour profile à cadre fin HS
Perfil de marco fino de la unión angular HS

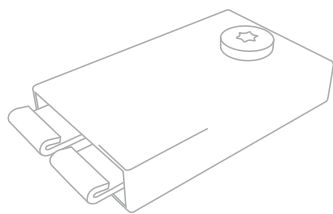

HS Verbinder SGS 6 Maxi
HS Connector SGS 6 Maxi
Connecteur HS SGS 6 Maxi
Conector HS SGS 6 Maxi

HestexSystemsGmbH

Am Eichholz 28
42897 Remscheid -Germany

Telefon: +49 (0) 2191 / 78 00 61
Telefax: +49 (0) 2191 / 78 00 64

E-mail: info@hestexsystems.com

www.hestexsystems.com



HestexSystems



Vitrinenprogramm | Anwendungsbeispiele
Display case range | Application example
Gamme de vitrines | Exemples d'utilisation
Programa de vitrinas | Ejemplos de aplicación

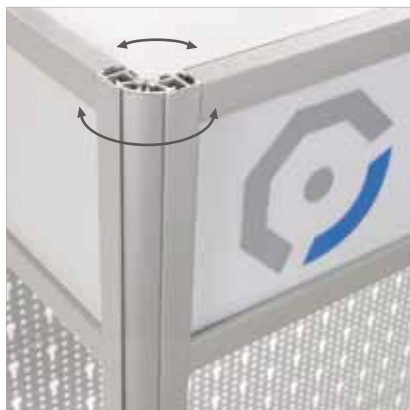
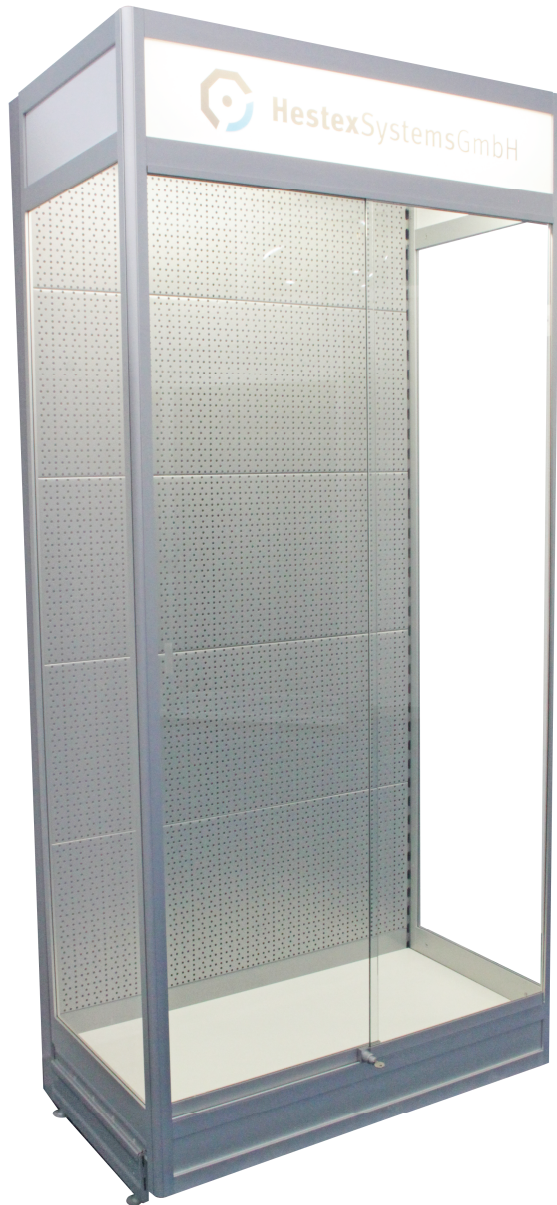

Deutsch

Klappvitrine zum Vorhängen an eine vorhandene Regalwand (Tegometall). Rahmen aus Aluminium 180° Profilen. Seitenwände wahlweise aus Holz oder Glas. Front aus abschließbaren Glasschiebetüren. Im oberen Teil kann auf einer Acryl Platte Ihr Logo angebracht werden.

Standard Formate KLV 1

Höhe 1000 / Breite 665 / Tiefe 240 / 340 mm
Höhe 1200 / Breite 1000 / Tiefe 240 / 340 mm
Höhe 1400 / Breite 1250 / Tiefe 240 / 340 mm
Höhe 1980 / Breite 1000 / Tiefe 240 / 340 mm
Höhe 1980 / Breite 2000 / Tiefe 240 / 340 mm

English

Folding display case for hanging on an existing shelf wall (Tego metal). Aluminium frames with 180° profiles. Side walls of wood or glass as desired. Lockable sliding glass doors at the front. Your logo can be mounted on an acrylic sheet in the upper part.

Standard formats KLV 1

Height 1000 / Width 665 / Depth 240 / 340 mm
Height 1200 / Width 1000 / Depth 240 / 340 mm
Height 1400 / Width 1250 / Depth 240 / 340 mm
Height 1980 / Width 1000 / Depth 240 / 340 mm
Height 1980 / Width 2000 / Depth 240 / 340 mm

Français

Comptoir pour combinaison avec présentoir (Tegometall) existant. Cadre en profils d'aluminium 180°. Parois latérales en bois ou en verre. Face frontale avec portes en verre et système de verrouillage. Vous pouvez appliquer votre logo de société sur un panneau acrylique, situé dans la partie supérieure.

Formats standards KLV 1

Hauteur 1000 / Largeur 665 / Profondeur 240 ou 340 mm
Hauteur 1200 / Largeur 1000 / Profondeur 240 ou 340 mm
Hauteur 1400 / Largeur 1250 / Profondeur 240 ou 340 mm
Hauteur 1980 / Largeur 1000 / Profondeur 240 ou 340 mm
Hauteur 1980 / Largeur 2000 / Profondeur 240 ou 340 mm

Español

Vitrina plegable para colgar en una pared de estanterías ya existente (Tegometall). Marcos a partir de perfiles de aluminio de 180°. Paredes laterales de madera o cristal, a elegir. Puertas corredizas de cristal con posibilidad de cierre en la parte frontal. En la parte superior puede colocar su logotipo sobre una placa acrílica.

Formatos estándar KLV 1

Altura 1000 / Anchura 665 / Profundidad 240 / 340 mm
Altura 1200 / Anchura 1000 / Profundidad 240 / 340 mm
Altura 1400 / Anchura 1250 / Profundidad 240 / 340 mm
Altura 1980 / Anchura 1000 / Profundidad 240 / 340 mm
Altura 1980 / Anchura 2000 / Profundidad 240 / 340 mm

Vitrinenvorsatz

Display case

La vitrine

Módulo de vitrinas

Deutsch

Vitrinenvorsatz für Tegometall-Regale Rahmen aus Aluminiumprofilen, Seitenfüllungen mit HDF-Holz oder Acryl klar. Front aus abschließbaren Glasschiebetüren. Im oberen Teil kann auf einer Acrylplatte die hinterleuchtet ist, Ihr Logo aufgebracht werden. Als nachträglichen Aufbau vor einer Tegometall-Regalwand oder als Einzelaufstellung. Im Lieferprogramm ist auch ein Anbau-Modul erhältlich.

Standard Formate Vitrinenvorsatz

Höhe 2200 / Breite 665 / Tiefe 400 oder 500 mm
 Höhe 2200 / Breite 1000 / Tiefe 400 oder 500 mm
 Höhe 2200 / Breite 1250 / Tiefe 400 oder 500 mm
 Höhe 2200 / Breite 1330 / Tiefe 400 oder 500 mm

Anbauvorsatz Formate, siehe oben.

English

A display case attachment for Tego metal shelves Frames of aluminium profiles, side sheets of HDF wood or acrylic, lockable sliding glass doors at the front. You can display your logo on the backlit acrylic sheet in the upper part. Available as a subsequent expansion in front of a Tego metal shelf wall or as a free-standing system. An attachment module is also available.

Standard formats display case

Height 2200 / Width 665 / Depth 400 or 500 mm
 Height 2200 / Width 1000 / Depth 400 or 500 mm
 Height 2200 / Width 1250 / Depth 400 or 500 mm
 Height 2200 / Width 1330 / Depth 400 or 500 mm

Attachment set formats, see above.

Français

Vitrine pour étagères Tegometall. Cadre en profils d'aluminium, parois latérales en fibre de bois haute densité (HDF) ou acrylique clair. Face frontale avec portes en verre et système de verrouillage. Vous pouvez appliquer votre logo de société sur un panneau acrylique rétro-illuminé, situé dans la partie supérieure. Comme composant additionnel des présentoirs Tegometall, ou comme unité indépendante. Un module d'extension est également disponible.

Formats standards la vitrine

Hauteur 2200 / Largeur 665 / Profondeur 400 ou 500 mm
 Hauteur 2200 / Largeur 1000 / Profondeur 400 ou 500 mm
 Hauteur 2200 / Largeur 1250 / Profondeur 400 ou 500 mm
 Hauteur 2200 / Largeur 1330 / Profondeur 400 ou 500 mm

Module d'extension formats, voir ci-dessus.

Español

Módulo de vitrinas para estanterías de Tegometall Marcos de perfiles de aluminio, paneles laterales con madera HDF o acrílico. Puertas corredizas de cristal con posibilidad de cierre en la parte frontal. En la parte superior puede colocar su logotipo sobre una placa acrílica iluminada por detrás. Para construcciones posteriores frente a la pared de estanterías Tegometall o para montaje sencillo. En el programa de suministro también existe un módulo anexo.

Formatos estándar módulo de vitrinas

Altura 2200 / Anchura 665 / Profundidad 400 o 500 mm
 Altura 2200 / Anchura 1000 / Profundidad 400 o 500 mm
 Altura 2200 / Anchura 1250 / Profundidad 400 o 500 mm
 Altura 2200 / Anchura 1330 / Profundidad 400 o 500 mm

Formatos de módulo anexo, véase arriba.



Vit-1 Vitrinenvorsatz
Vit-1 Display case

Vit-1 La vitrine

Vit-1 Módulo de vitrinas

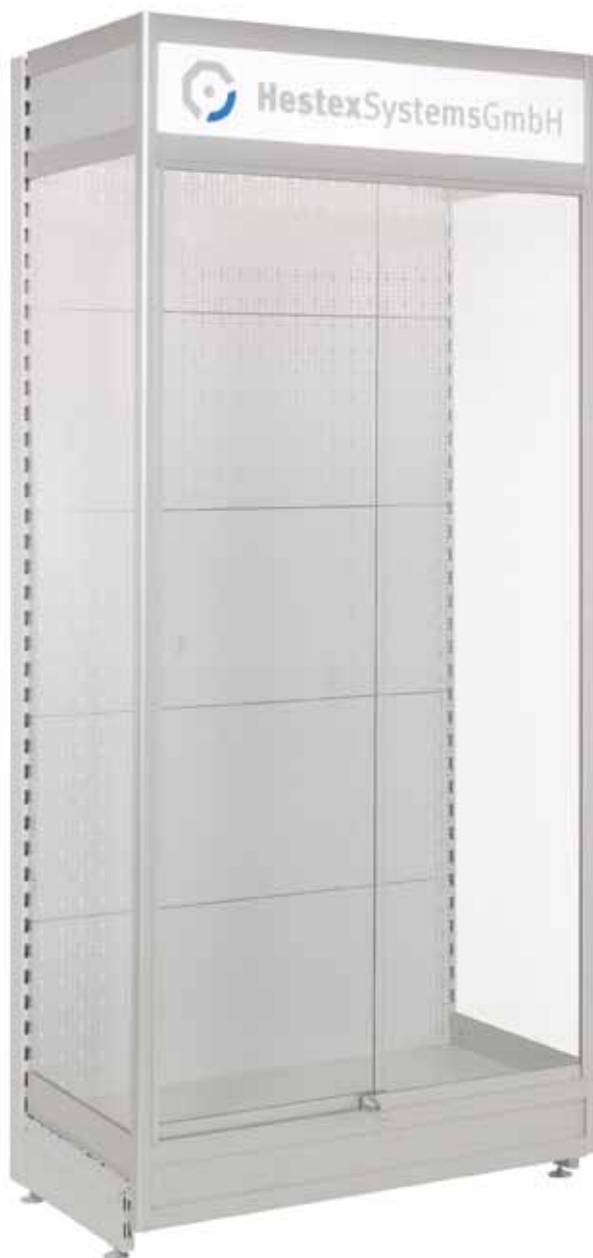
Deutsch

Vitrinenvorsatz für Tegometall-Regale Rahmen aus Aluminiumprofilen, Seitenfüllungen mit HDF-Holz oder Acryl klar. Front aus abschließbaren Glasschiebetüren. Im oberen Teil kann auf einer Acrylplatte die hinterleuchtet ist, Ihr Logo aufgebracht werden. Als nachträglichen Aufbau vor einer Tegometall-Regalwand oder als Einzelaufstellung. Im Lieferprogramm ist auch ein Anbau-Modul erhältlich.

Standard Formate Vit-1 Vitrinenvorsatz

Höhe 2200 / Breite 665 / Tiefe 400 oder 500 mm
 Höhe 2200 / Breite 1000 / Tiefe 400 oder 500 mm
 Höhe 2200 / Breite 1250 / Tiefe 400 oder 500 mm
 Höhe 2200 / Breite 1330 / Tiefe 400 oder 500 mm

VIT-1 Anbauvorsatz Formate, siehe oben.

English

A display case attachment for Tego metal shelves Frames of aluminium profiles, side sheets of HDF wood or acrylic, lockable sliding glass doors at the front. You can display your logo on the backlit acrylic sheet in the upper part. Available as a subsequent expansion in front of a Tego metal shelf wall or as a free-standing system. An attachment module is also available.

Standard formats Vit-1 Display case

Height 2200 / Width 665 / Depth 400 or 500 mm
 Height 2200 / Width 1000 / Depth 400 or 500 mm
 Height 2200 / Width 1250 / Depth 400 or 500 mm
 Height 2200 / Width 1330 / Depth 400 or 500 mm

VIT-1 Attachment set formats, see above.

Français

Vitrine pour étagères Tegometall. Cadre en profils d'aluminium, parois latérales en fibre de bois haute densité (HDF) ou acrylique clair. Face frontale avec portes en verre et système de verrouillage. Vous pouvez appliquer votre logo de société sur un panneau acrylique rétro-illuminé, situé dans la partie supérieure. Comme composant additionnel des présentoirs Tegometall, ou comme unité indépendante. Un module d'extension est également disponible.

Formats standards Vit-1 La vitrine

Hauteur 2200 / Largeur 665 / Profondeur 400 ou 500 mm
 Hauteur 2200 / Largeur 1000 / Profondeur 400 ou 500 mm
 Hauteur 2200 / Largeur 1250 / Profondeur 400 ou 500 mm
 Hauteur 2200 / Largeur 1330 / Profondeur 400 ou 500 mm

Module d'extension VIT-1, formats voir ci-dessus.

Español

Módulo de vitrinas para estanterías de Tegometall Marcos de perfiles de aluminio, paneles laterales con madera HDF o acrílico. Puertas corredizas de cristal con posibilidad de cierre en la parte frontal. En la parte superior puede colocar su logotipo sobre una placa acrílica iluminada por detrás. Para construcciones posteriores frente a la pared de estanterías Tegometall o para montaje sencillo. En el programa de suministro también existe un módulo anexo.

Formatos estándar Vit-1 Módulo de vitrinas

Altura 2200 / Anchura 665 / Profundidad 400 o 500 mm
 Altura 2200 / Anchura 1000 / Profundidad 400 o 500 mm
 Altura 2200 / Anchura 1250 / Profundidad 400 o 500 mm
 Altura 2200 / Anchura 1330 / Profundidad 400 o 500 mm

VIT-1 Formatos de módulo anexo, véase arriba.





Deutsch

Werkzeugschrank aus stabilen Aluminiumprofilen. Seitenfüllungen aus HDF- Holz Front aus abschließbaren Glasschiebetüren. Als Rückwand werden Tegometall-Rückwände eingehängt, auf denen sie Ihre Produkte präsentieren können. Im oberen Teil können sie, auf einer Acrylplatte die hinterleuchtet ist, ihr Logo aufbringen.

Standard Formate WZ

WZ 1810 – Höhe 1800 / Breite 1030 / Tiefe 400 mm
 WZ 2210 – Höhe 2200 / Breite 1030 / Tiefe 400 mm
 WZ 2213 – Höhe 2200 / Breite 1320 / Tiefe 400 mm

English

Tool cabinet using sturdy aluminium profiles. Side panels of HDF wood. Lockable sliding glass doors at the front. A Tego metal rear wall is hung as the rear wall, which you can use for displaying your products. You can display your logo on the backlit acrylic sheet in the upper part.

Standard formats WZ

WZ 1810 – Height 1800 / Width 1030 / Depth 400 mm
 WZ 2210 – Height 2200 / Width 1030 / Depth 400 mm
 WZ 2213 – Height 2200 / Width 1320 / Depth 400 mm

Français

Armoire à outils en profils d'aluminium stabilisés. Parois latérales en fibre de bois haute densité (HDF). Face frontale avec portes en verre et système de verrouillage. La face arrière est composée de panneaux Tegometall, sur lesquels vous pourrez étaler vos produits. Vous pouvez appliquer votre logo de société sur un panneau acrylique rétro-illuminé, situé dans la partie supérieure.

Formats standards WZ

WZ 1810 – Hauteur 1800 / Largeur 1030 / Profondeur 400 mm
 WZ 2210 – Hauteur 2200 / Largeur 1030 / Profondeur 400 mm
 WZ 2213 – Hauteur 2200 / Largeur 1320 / Profondeur 400 mm

Español

Armario de herramientas a partir de perfiles de aluminio estables. Paneles laterales de madera HDF. Puertas corredizas de cristal con posibilidad de cierre en la parte frontal. En la parte posterior se cuelgan paredes de Tegometall sobre las que podrá presentar sus productos. En la parte superior puede colocar su logotipo sobre una placa acrílica iluminada por detrás.

Formatos estándar WZ

WZ 1810 – Altura 1800 / Anchura 1030 / Profundidad 400 mm
 WZ 2210 – Altura 2200 / Anchura 1030 / Profundidad 400 mm
 WZ 2213 – Altura 2200 / Anchura 1320 / Profundidad 400 mm



Highlight
Highlight
Highlight
Highlight



Deutsch

Highlight; Beleuchtungseinheit für eine vorhandene Regalwand (Tegometall). Einfache Handhabung: "auspacken, aufklappen, einhängen, fertig!" Rahmen aus 180° System Frontseite mit einem neutralen Acrylschild um ihr Logo anzubringen.

Standard Formate HL

Höhe 184 / Breite 665 / Tiefe 400 mm
Höhe 184 / Breite 1000 / Tiefe 400 mm
Höhe 184 / Breite 1250 / Tiefe 400 mm

Höhe 196 / Breite 665 / Tiefe 400 mm
Höhe 196 / Breite 1000 / Tiefe 400 mm
Höhe 196 / Breite 1250 / Tiefe 400 mm

Andere Formate und Regalsysteme auf Anfrage erhältlich.

English

Highlight; Lighting unit for an existing shelf wall (Tego metal). Simple to use: "unpack, unfold, hand, finished!" 180° system frames. Neutral acrylic sheet on the front side for your logo.

Standard formats HL

Height 184 / Width 665 / Depth 400 mm
Height 184 / Width 1000 / Depth 400 mm
Height 184 / Width 1250 / Depth 400 mm

Height 196 / Width 665 / Depth 400 mm
Height 196 / Width 1000 / Depth 400 mm
Height 196 / Width 1250 / Depth 400 mm

Other formats and shelf systems available on request.

Français

Highlight; Unité d'éclairage pour présentoir (Tegometall) existant. Simplicité d'installation: "déballer, déplier, accrocher, terminé!" Cadre en système 180° avec un panneau acrylique neutre en face avant, où vous pourrez appliquer votre logo.

Formats standards HL

Hauteur 184 / Largeur 665 / Profondeur 400 mm
Hauteur 184 / Largeur 1000 / Profondeur 400 mm
Hauteur 184 / Largeur 1250 / Profondeur 400 mm

Hauteur 196 / Largeur 665 / Profondeur 400 mm
Hauteur 196 / Largeur 1000 / Profondeur 400 mm
Hauteur 196 / Largeur 1250 / Profondeur 400 mm

Autres formats et systèmes de présentation disponibles à la demande.

Español

Highlight; Unidad de iluminación para pared de estantería existente (Tegometall). Fácil manejo: "desempaquetar, desmontar, colgar... y ya está!" Marcos a partir de sistema 180° Frontal con una placa acrílica neutra para colocar su logotipo.

Formatos estándar HL

Altura 184 / Anchura 665 / Profundidad 400 mm
Altura 184 / Anchura 1000 / Profundidad 400 mm
Altura 184 / Anchura 1250 / Profundidad 400 mm

Altura 196 / Anchura 665 / Profundidad 400 mm
Altura 196 / Anchura 1000 / Profundidad 400 mm
Altura 196 / Anchura 1250 / Profundidad 400 mm

Otros formatos y sistemas de estanterías disponibles si se solicitan.

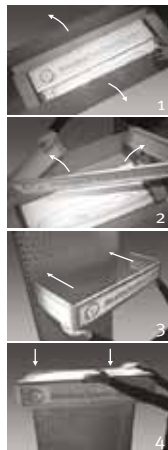



Deutsch

Rahmen aus Hestex 180°-System. Aluminium-Satiniert. Füllungen aus 6 mm Span, Forex oder ähnlichen Material.

Mit wenigen Handgriffen (Deckel ab, Böden raus, zusammenfalten fertig) kann die Theke platzsparend untergebracht oder zum nächsten Einsatzort verbracht werden.

Standard Formate KT

Höhe 900 / Breite 1000 / Tiefe 400 mm

Andere Formate auf Anfrage.

English

Frames of Hestex 180° system, satinised aluminium. Filling of 6 mm Span, Forex or similar material.

With only a few actions (remove cover, remove base, fold together, finished) the counter can be stored in a small space or transported to the next location.

Standard format KT

Height 900 / Width 1000 / Depth 400 mm

Other formats available on request.

Français

Cadre en profils d'aluminium satiné système Hestex 180°. Parois en Span, Forex ou matière similaire d'une épaisseur de 6 mm.

Avec quelques manipulations (enlever le couvercle, retirer le fond, replier, terminé), vous pourrez facilement ranger le comptoir ou le transporter à la prochaine exposition.

Format standard KT

Hauteur 900 / Largeur 1000 / Profondeur 400 mm

Autres formats à la demande.

Español

Marcos a partir de sistema 180° Hestex. Aluminio satinado. Planchas de relleno de 6 mm a partir de virutas, Forex o material similar.

De forma muy sencilla (quitando la tapa, sacando los fondos y plegando el mostrador) es posible guardar el mostrador ahorrando espacio, o transportarlo al siguiente lugar de exposición.

Formato estándar KT

Altura 900 / Anchura 1000 / Profundidad 400 mm

Se pueden solicitar otros formatos.



HestexSystems



Preisliste Hestex Standard | Hestex 80/80 | Hestex 40/40 | Hestex 180° | Hestex Prisma | Hestex SN50
Price-list Hestex Standard | Hestex 80/80 | Hestex 40/40 | Hestex 180° | Hestex Prisma | Hestex SN50
Liste des prix Hestex Standard | Hestex 80/80 | Hestex 40/40 | Hestex 180° | Hestex Prisma | Hestex SN50
Lista de precios Hestex Standard | Hestex 80/80 | Hestex 40/40 | Hestex 180° | Hestex Prisma | Hestex SN50



Hestex Standard

Profile
Profiles
Profils
Perfiles

(*) Incl. 2 Verbinder
(**) Incl. 4 Verbinder
(***) Incl. Stellfuß M10

(*) inclut 2 connecteurs
(**) inclut 4 connecteurs
(***) inclut pied de réglage M10

(*) Incl. 2 connectors
(**) Incl. 4 connectors
(***) Incl. Foot M10

(*) Incl. 2 conectores
(**) Incl. 4 conectores
(***) Incl. pie M10



Hestex Standard SN 20 Profil-Säule
Hestex Standard SN 20 vertical profile
Profil de colonne Hestex Standard SN20
Columnas para perfiles Hestex Standard SN 20

Art. Nr.: 1100101 5000	5000 mm	€ 93,00
Art. Nr.: 1100101 3500	3500 mm (***)	€ 77,00
Art. Nr.: 1100101 3000	3000 mm (***)	€ 68,00
Art. Nr.: 1100101 2500	2500 mm (***)	€ 55,00
Art. Nr.: 1100101 2000	2000 mm (***)	€ 54,00
Art. Nr.: 1100101 1500	1500 mm (***)	€ 38,00
Art. Nr.: 1100101 1000	1000 mm (***)	€ 32,00
Art. Nr.: 1100101 0750	750 mm (***)	€ 22,00
Art. Nr.: 1100101 0500	500 mm (***)	€ 14,50
Art. Nr.: 1100101 0175	175 mm	€ 9,00
Art. Nr.: 1100101 0150	150 mm	€ 7,50
Art. Nr.: 1100101 0070	70 mm	€ 3,50



Hestex Standard SN 70 Profil-Säule
Hestex Standard SN 70 vertical profile
Profil de colonne Hestex Standard SN70
Columnas para perfiles Hestex Standard SN 70

Art. Nr.: 1100501 5000	5000 mm	€ 120,00
Art. Nr.: 1100501 2500	2500 mm	€ 64,00
Art. Nr.: 1100501 1000	1000 mm	€ 34,00



Hestex Standard 25 x 16 Zargen-Profil
Hestex Standard 25 x 16 straight beam
Profils d'encadrement Hestex Standard 25 x 16
Hestex Standard 25 x 16 perfil de ranura

Art. Nr.: 1101000 5000	5000 mm	€ 48,00
-------------------------------	---------	----------------



Hestex Standard SN 30 Profil-Säule
Hestex Standard SN 30 vertical profile
Profil de colonne Hestex Standard SN30
Columnas para perfiles Hestex Standard SN 30

Art. Nr.: 1100201 4560	5000 mm	€ 98,00
Art. Nr.: 1100201 2500	2500 mm (***)	€ 54,00
Art. Nr.: 1100201 2000	2000 mm (***)	€ 50,00
Art. Nr.: 1100201 1000	1000 mm (***)	€ 30,00
Art. Nr.: 1100201 0175	175 mm	€ 9,00
Art. Nr.: 1100201 0150	150 mm	€ 7,50
Art. Nr.: 1100201 0070	70 mm	€ 3,50



Hestex Standard Twinprofil
Hestex Standard twin profile
Profil de jumeau Hestex Standard
Hestex Standard perfil gemelo

Art. Nr.: 1104230 5000	5000 mm	€ 63,00
-------------------------------	---------	----------------



Hestex Standard SN 40 Profil-Säule
Hestex Standard SN 40 vertical profile
Profil de colonne Hestex Standard SN40
Columnas para perfiles Hestex Standard SN 40

Art. Nr.: 1100301 5000	5000 mm	€ 70,00
Art. Nr.: 1100301 2500	2500 mm (***)	€ 42,00
Art. Nr.: 1100301 2000	2000 mm (***)	€ 40,00
Art. Nr.: 1100301 1000	1000 mm (***)	€ 25,00
Art. Nr.: 1100301 0175	175 mm	€ 9,00
Art. Nr.: 1100301 0150	150 mm	€ 7,50
Art. Nr.: 1100301 0070	70 mm	€ 3,50



Hestex Standard PP37 Zargen-Profil
Hestex Standard PP37 straight beam
Profils d'encadrement Hestex Standard PP37
Hestex Standard PP37 perfil de ranura

Art. Nr.: 1101001 5000	5000 mm	€ 53,00
Art. Nr.: 110010011940	1940 mm	€ 34,00
Art. Nr.: 1101001 1360	1360 mm (*)	€ 22,00
Art. Nr.: 1101001 0950	950 mm (*)	€ 18,50
Art. Nr.: 1101001 0660	660 mm (*)	€ 16,00
Art. Nr.: 1101001 0455	455 mm (*)	€ 13,00



Hestex Standard SN 60 Profil-Säule
Hestex Standard SN 60 vertical profile
Profil de colonne Hestex Standard SN60
Columnas para perfiles Hestex Standard SN 60

Art. Nr.: 1100401 4560	5000 mm	€ 75,00
-------------------------------	---------	----------------



Hestex Standard PP50 Zargen-Profil
Hestex Standard PP50 straight beam
Profils d'encadrement Hestex Standard PP50
Hestex Standard PP50 perfil de ranura

Art. Nr.: 1101101 5000	5000 mm	€ 65,00
Art. Nr.: 1101101 3920	3920 mm (*)	€ 62,00
Art. Nr.: 1101101 2930	2930 mm (*)	€ 49,00
Art. Nr.: 1101101 1940	1940 mm (*)	€ 33,00
Art. Nr.: 1101101 1360	1360 mm (*)	€ 27,00
Art. Nr.: 1101101 0950	950 mm (*)	€ 20,50
Art. Nr.: 1101101 0660	660 mm (*)	€ 18,00
Art. Nr.: 1101101 0445	445 mm (*)	€ 13,00



Hestex Standard

Profile
Profiles
Profils
Perfiles

(*) Incl. 2 Verbinder
(**) Incl. 4 Verbinder
(***) Incl. Stellfuß M10

(*) inclut 2 connecteurs
(**) inclut 4 connecteurs
(***) inclut pied de réglage M10

(*) Incl. 2 connectors
(**) Incl. 4 connectors
(***) Incl. Foot M10

(*) Incl. 2 conectores
(**) Incl. 4 conectores
(***) Incl. pie M10



Hestex Standard PP70 Zargen-Profil
Hestex Standard PP70 straight beam
Profils d'encadrement Hestex Standard PP70
Hestex Standard PP70 perfil de ranura

Art. Nr.: 1101201 5000	5000 mm	€ 86,00
Art. Nr.: 1101201 3920	3920 mm (*)	€ 84,00
Art. Nr.: 1101201 2930	2930 mm (*)	€ 63,00
Art. Nr.: 1101201 1940	1940 mm (*)	€ 43,00
Art. Nr.: 1101201 1360	1360 mm (*)	€ 37,00
Art. Nr.: 1101201 0950	950 mm (*)	€ 29,00
Art. Nr.: 1101201 0660	660 mm (*)	€ 24,00
Art. Nr.: 1101201 0455	455 mm (*)	€ 21,00



Hestex Standard PP150 Zargen-Profil
Hestex Standard PP150 straight beam
Profils d'encadrement Hestex Standard PP150
Hestex Standard PP150 perfil de ranura

Art. Nr.: 1101301 5000	5000 mm	€ 149,00
Art. Nr.: 1101301 3920	3920 mm (**)	€ 142,00
Art. Nr.: 1101301 2930	2930 mm (**)	€ 115,00
Art. Nr.: 1101301 1940	1940 mm (**)	€ 79,00
Art. Nr.: 1101301 1360	1360 mm (**)	€ 59,00
Art. Nr.: 1101301 0950	950 mm (**)	€ 46,00
Art. Nr.: 1101301 0660	660 mm (**)	€ 35,50
Art. Nr.: 1101301 0455	455 mm (**)	€ 34,00



Hestex Standard PP175 Zargen-Profil
Hestex Standard PP175 straight beam
Profils d'encadrement Hestex Standard PP175
Hestex Standard PP175 perfil de ranura

Art. Nr.: 1101401 5000	5000 mm	€ 156,00
Art. Nr.: 1101401 3920	3920 mm (**)	€ 142,00
Art. Nr.: 1101401 2930	2930 mm (**)	€ 125,00
Art. Nr.: 1101401 1940	1940 mm (**)	€ 85,00
Art. Nr.: 1101401 1360	1360 mm (**)	€ 66,00
Art. Nr.: 1101401 0950	950 mm (**)	€ 52,50
Art. Nr.: 1101401 0660	660 mm (**)	€ 39,50
Art. Nr.: 1101401 0455	455 mm (**)	€ 35,00

(*) Incl. 2 Verbinder
(**) Incl. 4 Verbinder
(***) Incl. Stellfuß M10

(*) Incl. 2 connectors
(**) Incl. 4 connectors
(***) Incl. Foot M10

(*) inclut 2 connecteurs
(**) inclut 4 connecteurs
(***) inclut pied de réglage M10

(*) Incl. 2 conectores
(**) Incl. 4 conectores
(***) Incl. pie M10



Hestex Standard

Profile
Profiles
Profils
Perfiles

(*) Incl. 2 Verbinder
(**) Incl. 4 Verbinder
(***) Incl. Stellfuß M10

(*) inclut 2 connecteurs
(**) inclut 4 connecteurs
(***) inclut pied de réglage M10

(*) Incl. 2 connectors
(**) Incl. 4 connectors
(***) Incl. Foot M10

(*) Incl. 2 conectores
(**) Incl. 4 conectores
(***) Incl. pie M10

Hestex Standard S108 Profil-Saule 4 mm
Hestex Standard S108 vertical profile 4 mm
Profil de colonne Hestex Standard S108 4 mm
Columnas para perfiles Hestex Standard S108 4 mm



Art. Nr.: 1100501 5000	5000 mm	€ 93,00
Art. Nr.: 1100501 3500	3500 mm (***)	€ 77,00
Art. Nr.: 1100501 3000	3000 mm (***)	€ 68,00
Art. Nr.: 1100501 2500	2500 mm (***)	€ 55,00
Art. Nr.: 1101501 2000	2000 mm (***)	€ 54,00
Art. Nr.: 1101501 1500	1500 mm (***)	€ 38,00
Art. Nr.: 1101501 1000	1000 mm (***)	€ 32,00
Art. Nr.: 1101501 0750	750 mm (***)	€ 22,00
Art. Nr.: 1100501 0500	500 mm (***)	€ 14,50
Art. Nr.: 1100501 0150	150 mm	€ 7,50
Art. Nr.: 1100501 0070	70 mm	€ 3,50



HS Rundzarge 2800
HS Curved Beams 2800
Poutres courbées HS 2800
Vigas curvas HS 2800

Art. Nr.: 1102501 2800

€65,05

Hestex Standard PP71 Zargen-Profil 4 mm
Hestex Standard PP71 straight beam 4 mm
Profils d'encadrement Hestex Standard PP71 4 mm
Hestex Standard PP71 profil de ranura 4 mm



Art. Nr.: 1101501 5000	5000 mm	€86,00
Art. Nr.: 1101501 3920	3920 mm (*)	€84,00
Art. Nr.: 1101501 2930	2930 mm (*)	€63,00
Art. Nr.: 1101501 1940	1940 mm (*)	€43,00
Art. Nr.: 1101501 1360	1360 mm (*)	€37,00
Art. Nr.: 1101501 0950	0950 mm (*)	€29,00
Art. Nr.: 1101501 0660	0660 mm (*)	€24,00
Art. Nr.: 1101501 0455	0455 mm (*)	€21,00



Hestex Standard S109 Profil-Saule 8 mm
Hestex Standard S109 vertical profile 8 mm
Profil de colonne Hestex Standard S109 8 mm
Columnas para perfiles Hestex Standard S109 8 mm

Art. Nr.: 1100601 5000	5000 mm	€ 93,00
Art. Nr.: 1100601 3500	3500 mm (**)	€ 77,00
Art. Nr.: 1100601 3000	3000 mm (**)	€ 68,00
Art. Nr.: 1100601 2500	2500 mm (**)	€ 55,00
Art. Nr.: 1100601 2000	2000 mm (**)	€ 54,00
Art. Nr.: 1100601 1500	1500 mm (**)	€ 38,00
Art. Nr.: 1100601 1000	1000 mm (**)	€ 32,00
Art. Nr.: 1100601 0750	0750 mm (**)	€ 22,00
Art. Nr.: 1100601 0500	0500 mm (**)	€ 14,50
Art. Nr.: 1100601 0150	0150 mm	€ 7,50
Art. Nr.: 1100601 0070	0070 mm	€ 3,50

HS Rundzarge 990
HS Curved Beams 990
Poutres courbées HS 990
Vigas curvas HS 990



Art. Nr.: 1102501 0990

€41,15



Hestex Standard S110 Profil-Saule 8 mm
Hestex Standard S110 vertical profile 8 mm
Profil de colonne Hestex Standard S110 8 mm
Columnas para perfiles Hestex Standard S110 8 mm

Art. Nr.: 1100701 5000	5000 mm	€98,00
Art. Nr.: 1100701 2500	2500 mm (**)	€ 54,00
Art. Nr.: 1100701 2000	2000 mm (**)	€50,00
Art. Nr.: 1100701 1000	1000 mm	€30,00
Art. Nr.: 1100701 0175	0175 mm	€ 9,00
Art. Nr.: 1100701 0150	0150 mm	€ 7,50
Art. Nr.: 1100701 0070	0070 mm	€ 3,50

HS Rundzarge 1400
HS Curved Beams 1400
Poutres courbées HS 1400
Vigas curvas HS 1400



Art. Nr.: 1102501 1400

€45,95



Hestex Standard PP71 8 mm Zargen-Profil
Hestex Standard PP71 8 mm straight beam
Profils d'encadrement Hestex Standard PP71 8 mm
Hestex Standard PP71 8 mm profil de ranura

Art. Nr.: 1101601 5000	5000 mm	€86,00
Art. Nr.: 1101601 3920	3920 mm (*)	€84,00
Art. Nr.: 1101601 2930	2930 mm (*)	€63,00
Art. Nr.: 1101601 1940	1940 mm (*)	€43,00
Art. Nr.: 1101601 1360	1360 mm (*)	€37,00
Art. Nr.: 1101601 0950	0950 mm (*)	€29,00
Art. Nr.: 1101601 0660	0660 mm (*)	€24,00
Art. Nr.: 1101601 0455	0455 mm (*)	€21,00

HS Rundzarge 1980
HS Curved Beams 1980
Poutres courbées HS 1980
Vigas curvas HS 1980



Art. Nr.: 1102501 1980

€54,45



Hestex Standard PP176 8 mm Zargen-Profil
Hestex Standard PP176 8 mm straight beam
Profils d'encadrement Hestex Standard PP176 8 mm
Hestex Standard PP176 8 mm profil de ranura

Art. Nr.: 1101701 5000	5000 mm	€218,00
Art. Nr.: 1101701 3920	3920 mm (**)	€175,00
Art. Nr.: 1101701 2930	2930 mm (**)	€141,00
Art. Nr.: 1101701 1940	1940 mm (**)	€96,00
Art. Nr.: 1101701 1360	1360 mm (**)	€75,00
Art. Nr.: 1101701 0950	0950 mm (**)	€58,00
Art. Nr.: 1101701 0660	0660 mm (**)	€50,00
Art. Nr.: 1101701 0455	0455 mm (**)	€42,00



Hestex Standard

Profile
Profiles
Profils
Perfiles

(*) Incl. 2 Verbinder
(**) Incl. 4 Verbinder
(***) Incl. Stellfuß M10

(*) inclut 2 connecteurs
(**) inclut 4 connecteurs
(***) inclut pied de réglage M10

(*) Incl. 2 connectors
(**) Incl. 4 connectors
(***) Incl. Foot M10

(*) Incl. 2 conectores
(**) Incl. 4 conectores
(***) Incl. pie M10



HS-SN90-Profil
HS-SN90-Profile
Profile HS-SN90
HS-SN90-Perfil

Art. Nr.: 1100901 5000 | 5000 mm

€93,00



HS-SN95-Profil
HS-SN95-Profile
Profile HS-SN95
HS-SN95-Perfil

Art. Nr.: 1101001 5000 | 5000 mm

€70,00



HS Rundzarge PP50 990
HS Curved Beams PP50 990
Poutres courbées HS PP50 990
Vigas curvas HS PP50 990

Art. Nr.: 1102101 0990

€38,10



HS Rundzarge PP70 990
HS Curved Beams PP70 990
Poutres courbées HS PP70 990
Vigas curvas HS PP70 990

Art. Nr.: 1102201 0990

€41,15



HS Rundzarge PP50 1400
HS Curved Beams PP50 1400
Poutres courbées HS PP50 1400
Vigas curvas HS PP50 1400

Art. Nr.: 1102101 1400

€42,10



HS Rundzarge PP70 1400
HS Curved Beams PP70 1400
Poutres courbées HS PP70 1400
Vigas curvas HS PP70 1400

Art. Nr.: 1102201 1400

€45,95



HS Rundzarge PP50 1980
HS Curved Beams PP50 1980
Poutres courbées HS PP50 1980
Vigas curvas HS PP50 1980

Art. Nr.: 1102101 1980

€48,95



HS Rundzarge PP70 1980
HS Curved Beams PP70 1980
Poutres courbées HS PP70 1980
Vigas curvas HS PP70 1980

Art. Nr.: 1102201 1980

€54,45



HS Rundzarge PP50 2800
HS Curved Beams PP50 2800
Poutres courbées HS PP50 2800
Vigas curvas HS PP50 2800

Art. Nr.: 1102101 2800

€57,90



HS Rundzarge PP70 2800
HS Curved Beams PP70 2800
Poutres courbées HS PP70 2800
Vigas curvas HS PP70 2800

Art. Nr.: 1102201 2800

€65,05



Hestex Standard

Verbinder
Connectorlocks
Connecteurs
Conector

Zubehör
Accessories
Accessoires
Accesorios

 <p>SN 209 Abdeckkappe grau (Passend für PP37) SN 209 cap grey (Suitable for PP37) SN 209 Capot gris (Approprié pour système PP37) SN 209 capuchón de protección gris (Para PP37)</p> <p>Pro Stück / per piece / par pièce / por unidad</p> <p>Art. Nr.: 110.51.14</p>	<p>€ 0,95</p>	 <p>SN 207 Abdeckkappe weiß (Passend für PP70) SN 207 cap white (Suitable for PP70) SN 207 Capot blanc (Approprié pour système PP70) SN 207 capuchón de protección blanco (Para PP70)</p> <p>Pro Stück / per piece / par pièce / por unidad</p> <p>Art. Nr.: 110.51.22</p>	<p>€ 0,95</p>
 <p>SN 209 Abdeckkappe weiß (Passend für PP37) SN 209 cap white (Suitable for PP37) SN 209 Capot blanc (Approprié pour système PP37) SN 209 capuchón de protección blanco (Para PP37)</p> <p>Pro Stück / per piece / par pièce / por unidad</p> <p>Art. Nr.: 110.51.20</p>	<p>€ 0,95</p>	 <p>Stellfuß Standard SN20 Foot Standard SN20 Pied réglable Standard SN20 Pie Standard SN20</p> <p>Pro Stück / per piece / par pièce / por unidad</p> <p>Art. Nr.: 110.43.22</p>	<p>€ 4,50</p>
 <p>SN 208 Abdeckkappe grau (Passend für PP50) SN 208 cap grey (Suitable for PP50) SN 208 Capot gris (Approprié pour système PP50) SN 208 capuchón de protección gris (Para PP50)</p> <p>Pro Stück / per piece / par pièce / por unidad</p> <p>Art. Nr.: 110.51.15</p>	<p>€ 0,95</p>	 <p>Stellfuß Standard SN30 Foot Standard SN30 Pied réglable Standard SN30 Pie Standard SN30</p> <p>Pro Stück / per piece / par pièce / por unidad</p> <p>Art. Nr.: 110.43.23</p>	<p>€ 4,25</p>
 <p>SN 208 Abdeckkappe weiß (Passend für PP50) SN 208 cap white (Suitable for PP50) SN 208 Capot blanc (Approprié pour système PP50) SN 208 capuchón de protección blanco (Para PP50)</p> <p>Pro Stück / per piece / par pièce / por unidad</p> <p>Art. Nr.: 110.51.21</p>	<p>€ 0,95</p>	 <p>Stellfuß Standard SN40 Foot Standard SN40 Pied réglable Standard SN40 Pie Standard SN40</p> <p>Pro Stück / per piece / par pièce / por unidad</p> <p>Art. Nr.: 110.43.24</p>	<p>€ 4,00</p>
 <p>SN 207 Abdeckkappe grau (Passend für PP70) SN 207 cap grey (Suitable for PP70) SN 207 Capot gris (Approprié pour système PP70) SN 207 capuchón de protección gris (Para PP70)</p> <p>Pro Stück / per piece / par pièce / por unidad</p> <p>Art. Nr.: 110.51.16</p>	<p>€ 0,95</p>	 <p>Stripline 4mm Stripline 4mm Stripline 4mm Stripline 4mm</p> <p>Pro Stück / per piece / par pièce / por unidad</p> <p>Art. Nr.: 110.40.00 950 mm</p>	<p>€ 9,00</p>



Hestex Standard

Verbinder
Connectorlocks
Connecteurs
Conector

Zubehör
Accessories
Accessoires
Accesorios

 <p>Hestex Standard SGS6 Verbinder Hestex Standard SGS6 connector Connecteur Hestex Standard SGS6 Hestex Standard SGS6 conector</p> <p>Pro Stück / per piece / par pièce / por unidad</p> <p>Art. Nr.: 110.40.31</p>	<p>€ 3,70</p>	 <p>SN 212 Abdeckkappe weiß (Passend für Hestex Standard SN 20)</p> <p>SN 212 cap white (Suitable for Hestex Standard SN20)</p> <p>SN 212 Capot blanc (Approprié pour système Hestex Standard SN 20)</p> <p>SN 212 capuchón de protección blanco (Para Hestex Standard SN 20)</p> <p>Pro Stück / per piece / par pièce / por unidad</p> <p>Art. Nr.: 110.51.17</p>	<p>€ 0,95</p>
 <p>Hestex Standard SGS6 Adapter Hestex Standard SGS6 lockslide Élément d'attache Hestex Standard SGS6 Hestex Standard SGS6 elemento de presión</p> <p>Pro Stück / per piece / par pièce / por unidad</p> <p>Art. Nr.: 110.41.32</p>	<p>€ 0,28</p>	 <p>SN 211 Abdeckkappe grau (Passend für Hestex Standard SN 30)</p> <p>SN 211 cap grey (Suitable for Hestex Standard SN30)</p> <p>SN 211 Capot gris (Approprié pour système Hestex Standard SN 30)</p> <p>SN 211 capuchón de protección gris (Para Hestex Standard SN 30)</p> <p>Pro Stück / per piece / par pièce / por unidad</p> <p>Art. Nr.: 110.51.12</p>	<p>€ 0,95</p>
 <p>SN 220 Hammerkopfschraube 20mm SN 220 Screw 20mm SN 220 Vis 20mm SN 220 tornillo con cabeza en forma de tornillo 20mm</p> <p>Pro Stück / per piece / par pièce / por unidad</p> <p>Art. Nr.: 110.42.20</p>	<p>€ 0,95</p>	 <p>SN 211 Abdeckkappe weiß (Passend für Hestex Standard SN 30)</p> <p>SN 211 cap white (Suitable for Hestex Standard SN30)</p> <p>SN 211 Capot blanc (Approprié pour système Hestex Standard SN 30)</p> <p>SN 211 capuchón de protección blanco (Para Hestex Standard SN 30)</p> <p>Pro Stück / per piece / par pièce / por unidad</p> <p>Art. Nr.: 110.51.18</p>	<p>€ 0,95</p>
 <p>SN 220 Hammerkopfschraube 40mm SN 220 Screw 40mm SN 220 Vis 40mm SN 220 tornillo con cabeza en forma de tornillo 40mm</p> <p>Pro Stück / per piece / par pièce / por unidad</p> <p>Art. Nr.: 110.42.40</p>	<p>€ 1,85</p>	 <p>SN 210 Abdeckkappe grau (Passend für Hestex Standard SN 40)</p> <p>SN 210 cap grey (Suitable for Hestex Standard SN40)</p> <p>SN 210 Capot gris (Approprié pour système Hestex Standard SN 40)</p> <p>SN 210 capuchón de protección gris (Para Hestex Standard SN 40)</p> <p>Pro Stück / per piece / par pièce / por unidad</p> <p>Art. Nr.: 110.51.13</p>	<p>€ 0,95</p>
 <p>SN 212 Abdeckkappe grau (Passend für Hestex Standard SN 20)</p> <p>SN 212 cap grey (Suitable for Hestex Standard SN20)</p> <p>SN 212 Capot gris (Approprié pour système Hestex Standard SN 20)</p> <p>SN 212 capuchón de protección gris (Para Hestex Standard SN 20)</p> <p>Pro Stück / per piece / par pièce / por unidad</p> <p>Art. Nr.: 110.51.11</p>	<p>€ 0,95</p>	 <p>SN 210 Abdeckkappe weiß (Passend für Hestex Standard SN 40)</p> <p>SN 210 cap white (Suitable for Hestex Standard SN40)</p> <p>SN 210 Capot blanc (Approprié pour système Hestex Standard SN 40)</p> <p>SN 210 capuchón de protección blanco (Para Hestex Standard SN 40)</p> <p>Pro Stück / per piece / par pièce / por unidad</p> <p>Art. Nr.: 110.51.19</p>	<p>€ 0,95</p>



Hestex Standard

Verbinder
Connectorlocks
Connecteurs
Conector

Zubehör
Accessories
Accessoires
Accesorios

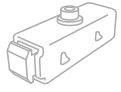

HS Verbinder alt 12 x 12 - 4,5 mm
HS Connector Old 12 x 12 - 4,5 mm
Connecteur HS Vieux 12 x 12 - 4,5 mm
Antiguo conector HS 12 x 12 - 4,5 mm

Pro Stück / per piece / par pièce / por unidad

Art. Nr.: **110.51.14**

€**3,30**



HS Verbinder 45° 8 mm Gewinde für S109 aufrecht
HS Connector 45° 8 mm thread for S109 upright
Connecteur HS 45° filetage 8 mm pour position S109
Conector de 45° HS hilo de 8 mm para el S109 vertical

Pro Stück / per piece / par pièce / por unidad

Art. Nr.: **110.51.22**

€**15,00**



HS Verbinder SN-20 M10 Zapfen
HS Connector SN-20 M 10 spigot
EEmbout connecteur HS SN-20 M 10 clé
Conector HS SN-20 M 10 espiga

Pro Stück / per piece / par pièce / por unidad

Art. Nr.: **110.51.20**

€**2,15**

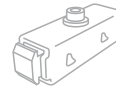

HS Verbinder alt 12 x 12 - 8 mm
HS Connector Old 12 x 12 - 8 mm
Connecteur HS Vieux 12 x 12 - 8 mm
Antiguo conector HS 12 x 12 - 8 mm

Pro Stück / per piece / par pièce / por unidad

Art. Nr.: **110.43.22**

€**3,30**

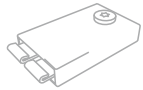

HS Verbinder SGS 6 Maxi
HS Connector SGS 6 Maxi
Connecteur HS SGS 6 Maxi
Conector HS SGS 6 Maxi

Pro Stück / per piece / par pièce / por unidad

Art. Nr.: **110.51.15**

€**14,50**



HS Verbinder SGS 6 - 8 mm
HS Connector SGS 6 - 8 mm
Connecteur HS SGS6 - 8 mm
Conector HS SGS 6 - 8 mm

Pro Stück / per piece / par pièce / por unidad

Art. Nr.: **110.43.23**

€**3,70**

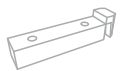

HS Sicherheitsblock PP 070 Typ 04
HS Safetyblock PP 070 type 04
Bloc de sécurité HS PP 070 type 04
Bloqueo de seguridad HS PP 070 de tipo 04

Pro Stück / per piece / par pièce / por unidad

Art. Nr.: **110.51.21**

€**15,00**



HS Tür S109 Drehplatte unten
HS Door S109 Turnplate botom
Bas de gâche de Porte HS S109
Puerta HS Placa giratoria S109 parte inferior

Pro Stück / per piece / par pièce / por unidad

Art. Nr.: **110.43.24**

€**10,00**



HS SN 90 - SN 95 Drehplatte unten
HS SN 90 - SN 95 Turn plate bottom
Bas de gond HS SN 90 - SN 95
HS SN 90 - Parte inferior de la placa giratoria SN 95

Pro Stück / per piece / par pièce / por unidad

Art. Nr.: **110.51.16**

€**20,00**



HS Kettenaufhängung
HS Chainhanger
Suspente à chaîne HS
Colgador de cadenas HS

Pro Stück / per piece / par pièce / por unidad

Art. Nr.: **110.40.00** | 950 mm

€**15,00**



Hestex Standard

Verbinder
Connectorlocks
Connecteurs
Conector

Zubehör
Accessories
Accessoires
Accesorios

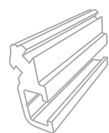

HS Eckblock
HS Cornerblock
Bloc de coin HS
Bloqueador de esquina HS

Pro Stück / per piece / par pièce / por unidad

Art. Nr.: **110.51.14**

€4,22



HS SN 109 Nutenstein 20x15
HS SN 109 Spigot 20x15
Embout HS SN 109 20x15
Espiga de 20 x 15 HS SN 109

Pro Stück / per piece / par pièce / por unidad

Art. Nr.: **110.43.24**

€5,50



HS Vorhanggleiter
HS Curtainslide
Glissière de rideau HS
Guía para cortinas HS

Pro Stück / per piece / par pièce / por unidad

Art. Nr.: **110.51.20**

€2,25



HS SN 109 Nutenstein
HS SN 109 Spigotstar
Spigotstar (embout étoile) SN 109 HS
Estrella de espiga HS SN 109

Pro Stück / per piece / par pièce / por unidad

Art. Nr.: **110.40.00** | 950 mm

€8,14



HS Nachtauge
HS Nighteye
HS Nighteye
Vista nocturna HS

Pro Stück / per piece / par pièce / por unidad

Art. Nr.: **110.51.16**

€5,25

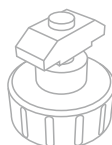

HS Namensschild
HS Nameboard button
Bouton du nom HS
Botón del nombre del tablón HS

Pro Stück / per piece / par pièce / por unidad

Art. Nr.: **110.51.14**

€2,50



HS Nachtgleiter
HS Nightslide
HS Nightslide
Guía nocturna HS

Pro Stück / per piece / par pièce / por unidad

Art. Nr.: **110.51.22**

€2,52

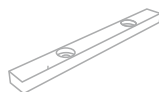

HS Langer Verbinder PP71
HS Longconnector PP71
Connecteur long HS PP71
Conector largo HS PP71

Pro Stück / per piece / par pièce / por unidad

Art. Nr.: **110.51.20**

€17,50



HS SN 109 Abdeckkappe
HS SN 109 Polecap
Embout de poteau SN 109 HS
Tapón de poste HS SN 109

Pro Stück / per piece / par pièce / por unidad

Art. Nr.: **110.43.23**

€9,60

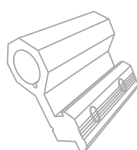

HS Scharnierprofil 8mm
HS Hinge profile 8mm
Profile de charnière HS 8 mm
Perfil de la bisagra HS de 8 mm

Pro Stück / per piece / par pièce / por unidad

Art. Nr.: **110.51.21**

€4,22



Hestex Standard

Verbinder
Connectorlocks
Connecteurs
Conector

Zubehör
Accessories
Accessoires
Accesorios



HS Balken-Hängeklammer
HS Beam hanging bracket
Crochet pour poutre HS
Soporte de suspensión de la viga HS

Pro Stück / per piece / par pièce / por unidad

Art. Nr.: **110.51.16**

€**3,15**



HS Verbinder SGS6 45° links
HS Connector SGS6 45° left
Connecteur HS SGS6 45° liens
Conector HS SGS6 45° enlaces

Pro Stück / per piece / par pièce / por unidad

€**6,50**



HS Verbinder SGS6 45° rechts
HS Connector SGS6 45° right
Connecteur HS SGS6 45° droit
Conector HS SGS6 45° derecho

Pro Stück / per piece / par pièce / por unidad

€**6,50**



Hestex Türen / Doors / Portes / Puertas

Zubehör
Accessories
Accessoires
Accesorios

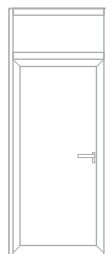

Hestex Standard Aluminiumsystemtür
Hestex Standard aluminium system door
Hestex Standard l'aluminium porte de système
Hestex Standard puerta de aluminio del sistema

Pro Stück / per piece / par pièce / por unidad

Art. Nr.: **110.25.01** | 1000 x 2500 mm

€ **549,00**



Hestex Distanzscheibe
Hestex shim
Hestex cale
Hestex calza

Pro Stück / per piece / par pièce / por unidad

Art. Nr.: **110.25.03**

€ **4,50**



Hestex 40/40 Aluminiumsystemtür
Hestex 40/40 aluminium system door
Hestex 40/40 l'aluminium porte de système
Hestex 40/40 puerta de aluminio del sistema

Pro Stück / per piece / par pièce / por unidad

Art. Nr.: **140.25.01** | 1000 x 2500 mm

€ **567,00**

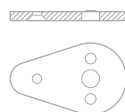

Hestex Standard Fußplatte
Hestex Standard baseplate
Base de pied Hestex Standard
Hestex Standard placa de soporte

Pro Stück / per piece / par pièce / por unidad

Art. Nr.: **110.25.04**

€ **6,50**

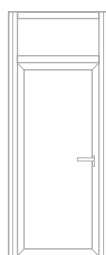

Hestex 80/80 Aluminiumsystemtür
Hestex 80/80 aluminium system door
Hestex 80/80 l'aluminium porte de système
Hestex 80/80 puerta de aluminio del sistema

Pro Stück / per piece / par pièce / por unidad

Art. Nr.: **140.25.01** | 1000 x 2500 mm

€ **659,00**



Hestex Standard Fußplatte mit Anschlag
Hestex Standard baseplate
Base de pied Hestex Standard
Hestex Standard placa de soporte

Pro Stück / per piece / par pièce / por unidad

Art. Nr.: **110.25.05**

€ **10,00**



Hestex Holztür
Hestex wooden door
Hestex porte en bois
Hestex puerta de madera

Pro Stück / per piece / par pièce / por unidad

Art. Nr.: **100.25.01** | 1000 x 2500 mm

€ **372,60**

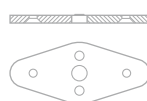

Hestex Standard doppelte Fußplatte
Hestex Standard double baseplate
Base de pied double Hestex Standard
Hestex Standard placa de soporte doble

Pro Stück / per piece / par pièce / por unidad

Art. Nr.: **110.25.06**

€ **12,00**



Hestex Türschweller für Systemtür Holz & Alu
Hestex baseplate for system door wood & aluminum
Hestex base de pied par porte en bois & l'aluminium
Hestex placa de soporte par puerta de madera & aluminio

Pro Stück / per piece / par pièce / por unidad

Art. Nr.: **110.25.02**

€ **15,00**



Hestex Standard Türhülse
Hestex Standard door cap
Chapeau de porte Hestex Standard
Hestex Standard casquillo de la puerta

Pro Stück / per piece / par pièce / por unidad

Art. Nr.: **110.25.07**

€ **3,50**

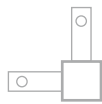

Hestex Standard Verbinder 50 für Türkonstruktion
Hestex Standard connector 50 for door construction
Connecteur construction de porte Hestex Standard 50
Hestex Standard conector 50 par construcción de la puerta

Pro Stück / per piece / par pièce / por unidad

Art. Nr.: **110.25.08**

€ **41,00**



Hestex Türschweller für Systemtür 80/80
Hestex baseplate for system door 80/80
Hestex base de pied par porte 80/80
Hestex placa de soporte par puerta 80/80

Pro Stück / per piece / par pièce / por unidad

Art. Nr.: **180.25.02**

€ **39,50**

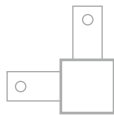

Hestex Standard Verbinder 70 für Türkonstruktion
Hestex Standard connector 70 for door construction
Connecteur construction de porte Hestex Standard 70
Hestex Standard conector 70 par construcción de la puerta

Pro Stück / per piece / par pièce / por unidad

Art. Nr.: **110.25.09**

€ **56,00**



Hestex Türschweller für Systemtür 40/40
Hestex baseplate for system door 40/40
Hestex base de pied par porte 40/40
Hestex placa de soporte par puerta 40/40

Pro Stück / per piece / par pièce / por unidad

Art. Nr.: **140.25.02**

€ **27,50**



Hestex 40/40 Distanzscheibe
Hestex 40/40 shim
Hestex 40/40 cale
Hestex 40/40 calza

Pro Stück / per piece / par pièce / por unidad

Art. Nr.: **140.25.03**

€ **6,50**

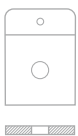

Hestex 40/40 Fußplatte mit Anschlag
Hestex 40/40 baseplate
Base de pied Hestex 40/40
Hestex 40/40 placa de soporte

Pro Stück / per piece / par pièce / por unidad

Art. Nr.: **140.25.04**

€ **8,50**



HS Systemtür 8 mm einfach 2500 mm
HS Systemdoor 8 mm single 2500 mm
Système de porte HS 8 mm unique 2500 mm
Sistema de puerta HS de 8 mm única de 2500 mm

Pro Stück / per piece / par pièce / por unidad

€549,00









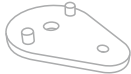

HS Systemtür 8 mm doppelt 2500 mm
HS Systemdoor 8 mm double 2500 mm
Système de porte HS 8 mm double 2500 mm
Sistema de puerta HS de 8 mm doble de 2500 mm

Pro Stück / per piece / par pièce / por unidad

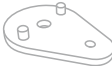
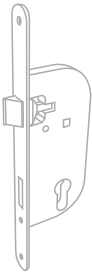
€1098,00

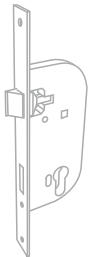

 <p>HS Tür-Unterrahmen 8 mm HS Door underline 8 mm Cadre de porte HS 8 mm Línea por debajo de la puerta HS de 8 mm</p> <p>Pro Stück / per piece / par pièce / por unidad</p>	<p>€15,00</p>	 <p>HS Türverbinder 70x70mm HS Doorconnector 70x70mm Connecteur de porte HS 70x70mm Conector de la puerta HS de 70 x 70 mm</p> <p>Pro Stück / per piece / par pièce / por unidad</p>	<p>€4,50</p>
 <p>HS Tür-Drehelement oben 8 mm HS Door turn-top-element 8 mm Pièce d'accouplement pour porte HS 8 mm Elemento de cierre basculante superior de la puerta HS de 8 mm</p> <p>Pro Stück / per piece / par pièce / por unidad</p>	<p>€10,00</p>	 <p>HS Türleiste 2030 mm für Doppeltür HS Door strip 2030 mm for double door Plaque pour porte HS 2030 mm pour porte double Tira de la puerta de 2030 mm HS para puerta puerta doble</p> <p>Pro Stück / per piece / par pièce / por unidad</p>	<p>€30,00</p>
 <p>HS Türgriff 8 mm HS Doorhandle 8 mm Poignée de porte HS 8 mm Tirador de la puerta HS de 8 mm</p> <p>Pro Stück / per piece / par pièce / por unidad</p>	<p>€15,00</p>	 <p>HS Tür S109 Drehelement oben HS Door S109 Turnelement top Pièce d'accouplement pour porte S109 HS Puerta HS Elemento superior basculante S109</p> <p>Pro Stück / per piece / par pièce / por unidad</p>	<p>€4,90</p>
 <p>HS Einsteckschloss 8 mm HS Doorbarrel 8 mm Baril de porte HS 8 mm Tambor de la puerta HS de 8 mm</p> <p>Pro Stück / per piece / par pièce / por unidad</p>	<p>€35,00</p>	 <p>HS Fußplatte S109 mit verstellbarem Fuß HS Footplate S109 with adjustable foot Embase HS S109 à pied réglable Plataforma de la pata HS S109 con pie ajustable</p> <p>Pro Stück / per piece / par pièce / por unidad</p>	<p>€5,50</p>
 <p>HS Einsteckschloss 8 mm HS Doorlock 8 mm Serrure de porte HS 8 mm Cerradura de la puerta HS de 8 mm</p> <p>Pro Stück / per piece / par pièce / por unidad</p>	<p>€35,00</p>	 <p>HS Fuß-Montageblock HS Foot mountingblock Plaque de montage de pied HS Bloque de montaje de la pata HS</p> <p>Pro Stück / per piece / par pièce / por unidad</p>	<p>€15,00</p>



Hestex 80/80

Profile
Profiles
Profils
Perfiles



Hestex 80/80 Up Profil-Säule 16mm
Hestex 80/80 Up vertical profile 16mm
Profil de colonne 16mm Hestex 80/80 Up
Hestex 80/80 Up columnas para perfiles 16mm

Art. Nr.: 1808000 6000	6000 mm	€ 226,00
Art. Nr.: 1808000 5000	5000 mm	€ 188,00
Art. Nr.: 1808000 4000	4000 mm	€ 159,00
Art. Nr.: 1808000 3000	3000 mm	€ 109,00
Art. Nr.: 1808000 2000	2000 mm	€ 76,00
Art. Nr.: 1808000 1000	1000 mm	€ 38,00



HS 80 x 80 x 16 Profil 8 mm
HS 80 x 80 x 16 profile 8 mm
Profile Hestex 80 x 80 x 16 - 8 mm
Perfil HS 80 80 x 16 de 8 mm

Art. Nr.: 1808003 6000	6000 mm	€ 314,40
Art. Nr.: 1808003 5000	5000 mm	€ 262,00
Art. Nr.: 1808003 4000	4000 mm	€ 209,60
Art. Nr.: 1808003 3000	3000 mm	€ 157,20
Art. Nr.: 1808003 2000	2000 mm	€ 104,80
Art. Nr.: 1808003 1000	1000 mm	€ 52,40



Hestex 80/80 Max Up Profil-Säule 4mm
Hestex 80/80 Max Up vertical profile 4mm
Profil de colonne 4mm Hestex 80/80 Max Up
Hestex 80/80 Max Up columnas para perfiles 4mm

Art. Nr.: 1808001 6000	6000 mm	€ 189,00
Art. Nr.: 1808001 5000	5000 mm	€ 158,00
Art. Nr.: 1808001 4000	4000 mm	€ 134,00
Art. Nr.: 1808001 3000	3000 mm	€ 98,00
Art. Nr.: 1808001 2000	2000 mm	€ 65,00
Art. Nr.: 1808001 1000	1000 mm	€ 33,00



Hestex 80/80 Max Zargen-Profil 4mm
Hestex 80/80 Max straight beam 4mm
Profils d'encadrement 4mm Hestex 80/80 Max
Hestex 80/80 Max perfil de ranura 4mm

Art. Nr.: 1808002 6000	6000 mm (*)	€ 229,00
Art. Nr.: 1808002 5000	5000 mm (*)	€ 199,00
Art. Nr.: 1808002 4000	4000 mm (*)	€ 169,00
Art. Nr.: 1808002 3000	3000 mm (*)	€ 136,00
Art. Nr.: 1808002 2000	2000 mm (*)	€ 106,00
Art. Nr.: 1808002 1000	1000 mm (*)	€ 69,00



Hestex 80/80

Verbinder
Connectorlocks
Connecteurs
Conector

Zubehör
Accessories
Accessoires
Accesorios



Hestex SGS80 Verbinder
Hestex SGS80 connector
Connecteur Hestex SGS80
Hestex SGS80 conector

Pro Stück / per piece / par pièce / por unidad

Art. Nr.: **180.40.31**

€ **18,50**



Hestex Langverbinder für 80/80 4mm
Hestex lengthening connector for 80/80 4mm
Rallonger-morceau de Hestex 80/80 4mm
Hestex alagar-pedazo par 80/80 4mm

Pro Stück / per piece / par pièce / por unidad

Art. Nr.: **180.84.00**

€ **17,50**

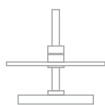

Hestex 80/80 Up Stellfuß
Hestex 80/80 Up Foot
Pied réglable Hestex 80/80 Up
Pie Hestex 80/80 Up

Pro Stück / per piece / par pièce / por unidad

Art. Nr.: **180.80.00**

€ **5,00**



Hestex Langverbinder 12x21x180mm
Hestex lengthening connector 12x21x180mm
Rallonger-morceau 12x21x180mm de Hestex
Hestex alagar-pedazo 12x21x180mm

Pro Stück / per piece / par pièce / por unidad

Art. Nr.: **180.86.00**

€ **12,00**

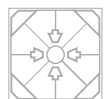

Hestex 80/80 Up Fußplatte 16mm
Hestex 80/80 Up baseplate 16mm
Base de pied Hestex 80/80 Up 16mm
Hestex 80/80 Up placa de soporte 16mm

Pro Stück / per piece / par pièce / por unidad

Art. Nr.: **180.81.00**

€ **11,00**

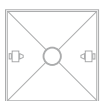

Hestex 80/80 Max Up Fußplatte 4mm
Hestex 80/80 Max Up baseplate 4mm
Base de pied Hestex 80/80 Max Up 4mm
Hestex 80/80 Max Up placa de soporte 4mm

Pro Stück / per piece / par pièce / por unidad

Art. Nr.: **180.82.00**

€ **9,00**

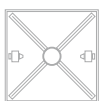

Hestex 80/80 Max Up Abdeckkappe 4mm
Hestex 80/80 Max Up cap 4mm
Hestex 80/80 Max Up capot 4mm
Hestex 80/80 Max Up capuchón de protección 4mm

Pro Stück / per piece / par pièce / por unidad

Art. Nr.: **180.83.00**

€ **9,00**



Hestex 80/80

Verbinder
Connectorlocks
Connecteurs
Conector

Zubehör
Accessories
Accessoires
Accesorios



Hestex 40/40

Profile
Profiles
Profils
Perfiles



Hestex 40/40 Mini Max Profil-Säule
Hestex 40/40 Mini Max vertical profile
Profil de colonne Hestex 40/40 Mini Max
Hestex 40/40 Mini Max columnas para perfiles

Art. Nr.: 1404002 5000	5000 mm	€ 99,00
Art. Nr.: 1404002 4000	4000 mm	€ 79,00
Art. Nr.: 1404002 3000	3000 mm	€ 59,00
Art. Nr.: 1404002 2000	2000 mm	€ 42,00
Art. Nr.: 1404002 1000	1000 mm	€ 24,00



Hestex 40/40 Mini Max Zargen-Profil
Hestex 40/40 Mini Max straight beam
Profils d'encadrement Hestex 40/40 Mini Max
Hestex 40/40 Mini Max perfil de ranura

Art. Nr.: 1404003 5000	5000 mm (*)	€ 123,00
Art. Nr.: 1404003 4000	4000 mm (*)	€ 99,00
Art. Nr.: 1404003 3000	3000 mm (*)	€ 75,00
Art. Nr.: 1404003 2000	2000 mm (*)	€ 51,00
Art. Nr.: 1404003 1000	1000 mm (*)	€ 35,00



Hestex 40/40

Verbinder
Connectorlocks
Connecteurs
Conector

Zubehör
Accessories
Accessoires
Accesorios



Hestex Standard SGS6 Verbinder
Hestex Standard SGS6 connector
Connecteur Hestex Standard SGS6
Hestex Standard SGS6 conector

Pro Stück / per piece / par pièce / por unidad

Art. Nr.: **110.40.31**

€ **3,70**

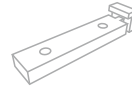

HS Sicherheitsblock 40 x 40
HS Safetyblock 40 x 40
Bloc de sécurité HS 40 x 40
Bloqueo de seguridad HS 40 x 40

€**15,00**



Hestex Standard SGS7 Verbinder
Hestex Standard SGS7 connector
Connecteur Hestex Standard SGS7
Hestex Standard SGS7 conector

Pro Stück / per piece / par pièce / por unidad

Art. Nr.: **110.40.32**

€ **4,50**

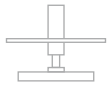

Hestex 40/40 Mini Max Up Stellfuß
Hestex 40/40 Mini Max Up Foot
Pied réglable Hestex 40/40 Mini Max Up
Pie Hestex 40/40 Mini Max Up

Pro Stück / per piece / par pièce / por unidad

Art. Nr.: **140.40.00**

€ **5,00**



Hestex 40/40 Mini Max Up Fußplatte
Hestex 40/40 Mini Max Up baseplate
Base de pied Hestex 40/40 Mini Max Up
Hestex 40/40 Mini Max Up placa de soporte

Pro Stück / per piece / par pièce / por unidad

Art. Nr.: **140.41.00**

€ **8,00**



Hestex 40/40 Mini Max Up Abdeckkappe
Hestex 40/40 Mini Max Up cap
Hestex 40/40 Mini Max Up capot
Hestex 40/40 Mini Max Up capuchón de protección

Pro Stück / per piece / par pièce / por unidad

Art. Nr.: **140.42.00**

€ **7,00**



Hestex 30/30

Profile
Profiles
Profils
Perfiles



HS 30 x 30 4 mm Profil
HS 30 x 30 4 mm profile
Profile 30 x 30 - 4 mm HS
Perfil HS 30 x 30 - 4 mm

Art. Nr.: 1300301 5000	5000 mm	€ 93,00
Art. Nr.: 1300301 4000	4000 mm	€ 75,00
Art. Nr.: 1300301 3000	3000 mm	€ 50,00
Art. Nr.: 1300301 2000	2000 mm	€ 37,00
Art. Nr.: 1300301 1000	1000 mm	€ 20,00



Hestex 180° 4mm

Profile
Profiles
Profils
Perfiles



Hestex 180° Komplett
Hestex 180° complete
Hestex 180° complet
Hestex 180° completo



Hestex Doppelkammer ohne Steg 4mm
Hestex straight beam 4mm
Chambre double sans bride Hestex 4mm
Hestex cámara doble sin puente 4mm

28x16mm

Art. Nr.: **120.25.02** | 5000 mm

€ **42,00**



Hestex 180° 4mm Außenprofil 4-Zahn
Hestex 180° 4mm outside profile 4-teeth
Profil externe Hestex 180° 4mm, 4 dents
Hestex 180° 4mm Perfil exterior 4 dientes

Art. Nr.: **120.10.02** | 5000 mm

€ **35,00**



Hestex Doppelkammer mit Steg 4mm
Hestex straight beam 4mm
Chambre double avec bride Hestex 4mm
Hestex cámara doble con puente 4mm

28x25mm

Art. Nr.: **120.20.02** | 5000 mm

€ **45,00**



Hestex 180° 4mm Mittelprofil
Hestex 180° 4mm middle profile
Profil central Hestex 180° 4mm
Hestex 180° 4mm Perfil central

Art. Nr.: **120.15.02** | 5000 mm

€ **30,00**



Hestex 180° 4mm Außenprofil 3-Zahn
Hestex 180° 4mm outside profile 3-teeth
Profil externe Hestex 180° 4mm, 3 dents
Hestex 180° 4mm perfil exterior 3 dientes

Art. Nr.: **120.05.02** | 5000 mm

€ **34,00**



Hestex Einkammer 4mm
Hestex straight beam 4mm
Chambre unique Hestex 4mm
Hestex de cámara única 4mm

22x16mm

Art. Nr.: **120.30.02** | 5000 mm

€ **35,00**



Hestex 180° 6mm

Profile
Profiles
Profils
Perfiles



Hestex 180° Komplett
Hestex 180° complete
Hestex 180° complet
Hestex 180° completo



Hestex Doppelkammer ohne Steg 6mm
Hestex straight beam 6mm
Chambre double sans bride Hestex 6mm
Hestex cámara doble sin puente 6mm

28x16mm

Art. Nr.: **120.25.02** | 5000 mm

€ **42,00**



Hestex 180° 6mm Außenprofil 4-Zahn
Hestex 180° 6mm outside profile 4-teeth
Profil externe Hestex 180° 6mm, 4 dents
Hestex 180° 6mm Perfil exterior 4 dientes

Art. Nr.: **120.10.02** | 5000 mm

€ **35,00**



Hestex Doppelkammer mit Steg 6mm
Hestex straight beam 6mm
Chambre double avec bride Hestex 6mm
Hestex cámara doble con puente 6mm

28x25mm

Art. Nr.: **120.20.02** | 5000 mm

€ **45,00**



Hestex 180° 6mm Mittelprofil
Hestex 180° 6mm middle profile
Profil central Hestex 180° 6mm
Hestex 180° 6mm Perfil central

Art. Nr.: **120.15.02** | 5000 mm

€ **30,00**



Hestex 180° 6mm Außenprofil 3-Zahn
Hestex 180° 6mm outside profile 3-teeth
Profil externe Hestex 180° 6mm, 3 dents
Hestex 180° 6mm perfil exterior 3 dientes

Art. Nr.: **120.05.02** | 5000 mm

€ **34,00**



Hestex Einkammer 6mm
Hestex straight beam 6mm
Chambre unique Hestex 6mm
Hestex de cámara única 6mm

22x16mm

Art. Nr.: **120.30.02** | 5000 mm

€ **35,00**



Hestex 180° 4/6mm

Verbinder
Connectorlocks
Connecteurs
Conector

Zubehör
Accessories
Accessoires
Accesorios

 <p>Hestex SGS12 Verbinder Hestex SGS12 connector Connecteur Hestex SGS12 Hestex SGS12 conector</p> <p>Pro Stück / per piece / par pièce / por unidad</p> <p>Art. Nr.: 123.01.00</p>	€ 3,70	 <p>Hestex 180° Fußteller mit Gewinde M10 Hestex 180° Baseplate with screwhead M10 Base de pied à filetage M10 Hestex 180° Hestex 180° placa de soporte con rosca M10</p> <p>Pro Stück / per piece / par pièce / por unidad</p> <p>Art. Nr.: 120.35.30</p>	€ 3,30
 <p>Hestex SGS 12x12 - 6,5 Verbinder Hestex SGS 12x12 - 6,5 connector Connecteur Hestex SGS 12x12 - 6,5 Hestex SGS 12x12 - 6,5 conector</p> <p>Pro Stück / per piece / par pièce / por unidad</p> <p>Art. Nr.: 120.45.31</p>	€ 3,30		
 <p>Hestex 180° Bodenträger mit Schraube Hestex 180° Profilecarrier with screw Pied de profil avec vis Hestex 180° Hestex 180° soporte de suelo con tornillo</p> <p>Pro Stück / per piece / par pièce / por unidad</p> <p>Art. Nr.: 120.55.11</p>	€ 1,20		
 <p>Bodenträger Metall Profilecarrier metal Pied de profil métallique Soporte de suelo de metal</p> <p>Pro Stück / per piece / par pièce / por unidad</p> <p>Art. Nr.: 140.30.20</p>	€ 1,50		
 <p>Hestex 180° Fußteller glatt Hestex 180° Baseplate, plain Base de pied lisse Hestex 180° Hestex 180° placa de soporte lisa</p> <p>Pro Stück / per piece / par pièce / por unidad</p> <p>Art. Nr.: 120.40.30</p>	€ 3,20		



Hestex Prisma

Verbinder
Connectorlocks
Connecteurs
Conector

Zubehör
Accessories
Accessoires
Accesorios

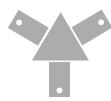

Hestex Prisma Eckverbinder roh
Hestex Prisma cornerconnector raw
Connecteur de coin nu Hestex Prisma
Hestex Prisma conector angular en bruto

Pro Stück / per piece / par pièce / por unidad

Art. Nr.: **140.20.30**

€ **6,00**



Hestex Prisma Knotenplatte 90° Innengewinde M10
Hestex Prisma baseplate 90° with screwhead M10
Plaquette 90° à filetage M10 Hestex Prisma
Hestex Prisma placa de nudos 90° con rosca M10

Pro Stück / per piece / par pièce / por unidad

Art. Nr.: **110.44.02**

€ **3,30**



Hestex Prisma Eckverbinder matt
Hestex Prisma cornerconnector mat
Connecteur de coin mat Hestex Prisma
Hestex Prisma conector angular mate

Pro Stück / per piece / par pièce / por unidad

Art. Nr.: **140.20.31**

€ **7,00**



Stellfuß Chrom mit Gewinde M10
Foot chromium with screwhead M10
Pied réglable chromé à filetage M10
Pie cromado con rosca M10

Pro Stück / per piece / par pièce / por unidad

Art. Nr.: **140.30.21**

€ **3,30**

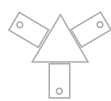

Hestex Prisma Eckverbinder chrom
Hestex Prisma cornerconnector chromium
Connecteur de coin chromé Hestex Prisma
Hestex Prisma conector angular cromado

Pro Stück / per piece / par pièce / por unidad

Art. Nr.: **140.20.32**

€ **8,00**



Hestex SGS 12x12 - 6,5 Verbinder
Hestex SGS 12x12 - 6,5 connector
Connecteur Hestex SGS 12x12 - 6,5
Hestex SGS 12x12 - 6,5 conector

Pro Stück / per piece / par pièce / por unidad

Art. Nr.: **120.45.31**

€ **3,30**



Bodenträger Metall
Profilecarrier metal
Pied de profil métallique
Soporte de suelo de metal

Pro Stück / per piece / par pièce / por unidad

Art. Nr.: **140.30.20**

€ **1,50**



Hestex Prisma Basisprofil 90°
Hestex Prisma main profile 90°
Profil de base Hestex Prisma 90°
Hestex Prisma perfil base 90°

22x16mm

Art. Nr.: **140.10.02** | 5000 mm € **36,00**



Hestex Prisma Basisprofil 135°
Hestex Prisma main profile 135°
Profil de base Hestex Prisma 135°
Hestex Prisma perfil base 135°

16,5x20,58mm

Art. Nr.: **140.11.02** | 5000 mm € **48,00**



Hestex Einkammer 6mm
Hestex straight beam 6mm
Chambre unique Hestex 6mm
Hestex de cámara única 6mm

22x16mm

Art. Nr.: **120.30.02** | 5000 mm € **35,00**



Hestex Doppelkammer ohne Steg 6mm
Hestex straight beam 6mm
Chambre double sans bride Hestex 6mm
Hestex cámara doble sin puente 6mm

28x16mm

Art. Nr.: **120.25.02** | 5000 mm € **42,00**



Hestex Doppelkammer mit Steg 6mm
Hestex straight beam 6mm
Chambre double avec bride Hestex 6mm
Hestex cámara doble con puente 6mm

28x25mm

Art. Nr.: **120.20.02** | 5000 mm € **45,00**



Hestex SN23

Profile
Profiles
Profils
Perfiles



Hestex SN23 Doppelkammer 4 mm
Hestex SN23 double beam 4 mm
Chambre double SN23 Hestex 4 mm
Hestex SN23 câmara doble 4 mm

Art. Nr.: **123.10.00** | 5000 mm

€ **42,00**



Hestex SN23 Dreikammer 4 mm
Hestex SN23 tripple beam 4 mm
Chambre trois Hestex SN23 4 mm
Hestex SN23 de câmara tres 4 mm

Art. Nr.: **123.20.00** | 5000 mm

€ **48,00**



Hestex Einkammer 4 mm
Hestex straight beam 4 mm
Chambre unique Hestex 4 mm
Hestex de câmara única 4 mm

22x16mm

Art. Nr.: **121.30.02** | 5000 mm

€ **35,00**



Hestex Doppelkammer ohne Steg 4 mm
Hestex straight beam 4 mm
Chambre double sans bride Hestex 4 mm
Hestex câmara doble sin puente 4 mm

28x16mm

Art. Nr.: **121.25.02** | 5000 mm

€ **43,00**



Hestex Doppelkammer mit Steg 4 mm
Hestex straight beam 4 mm
Chambre double avec bride Hestex 4 mm
Hestex câmara doble con puente 4 mm

28x25mm

Art. Nr.: **121.20.02** | 5000 mm

€ **45,00**



Hestex SN23

Verbinder
Connectorlocks
Connecteurs
Conector



Hestex SGS12 Verbinder
Hestex SGS12 connector
Connecteur Hestex SGS12
Hestex SGS12 conector

Pro Stück / per piece / par pièce / por unidad

Art. Nr.: **123.01.00**

€ **3,70**

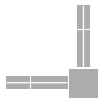

Hestex SN23 Eckverbinder 90° roh
Hestex SN23 cornerconnector 90°raw
Connecteur de coin 90° nu Hestex SN23
Hestex SN23 conector angular 90° en bruto

Pro Stück / per piece / par pièce / por unidad

Art. Nr.: **123.01.01**

€ **11,00**

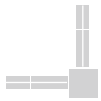

Hestex SN23 Eckverbinder 90° matt
Hestex SN23 cornerconnector 90° mat
Connecteur de coin 90° mat Hestex SN23
Hestex SN23 conector angular 90° mate

Pro Stück / per piece / par pièce / por unidad

Art.Nr.: **123.01.02**

€ **13,00**

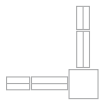

Hestex SN23 Eckverbinder 90° chrom
Hestex SN23 cornerconnector 90° chromium
Connecteur de coin 90° chromé Hestex SN23
Hestex SN23 conector angular 90° cromado

Pro Stück / per piece / par pièce / por unidad

Art.Nr.: **123.01.03**

€ **15,00**



Hestex SN50

Profile
Profiles
Profils
Perfiles



Hestex SN50 Profil-Säule
Hestex SN50 vertical profile
Profil de colonne Hestex SN50
Hestex SN50 columna del perfil

Art. Nr.: **150.01.01** | 5000 mm € **82,00**



Hestex SN50 Profil-Säule 135°
Hestex SN50 vertical profile 135°
Profil de colonne 135° Hestex SN50
Hestex SN50 columna del perfil 135°

Art. Nr.: **150.04.01** | 5000 mm € **94,00**



Hestex Einkammer 6mm
Hestex straight beam 6mm
Chambre unique Hestex 6mm
Hestex de cámara única 6mm

22x16mm

Art. Nr.: **120.30.02** | 5000 mm € **35,00**



Hestex Doppelkammer ohne Steg 6mm
Hestex straight beam 6mm
Chambre double sans bride Hestex 6mm
Hestex cámara doble sin puente 6mm

28x16mm

Art. Nr.: **120.25.02** | 5000 mm € **42,00**



Hestex Doppelkammer mit Steg 6mm
Hestex straight beam 6mm
Chambre double avec bride Hestex 6mm
Hestex cámara doble con puente 6mm

28x25mm

Art. Nr.: **120.20.02** | 5000 mm € **45,00**



Hestex SN50

Verbinder
Connectorlocks
Connecteurs
Conector

Zubehör
Accessories
Accessoires
Accesorios



Hestex SN50 Eckverbinder 90° roh
Hestex SN50 cornerconnector 90°raw
Connecteur de coin 90° nu Hestex SN50
Hestex SN50 conector angular 90° en bruto

Pro Stück / per piece / par pièce / por unidad

Art. Nr.: **150.02.00**

€ **8,00**



Hestex SN50 Fußplatte 90° mit Gewinde M10
Hestex SN50 baseplate 90° with screwhead M10
Base de pied 90° Hestex SN50 à filetage M10
Hestex SN50 placa de soporte 90° con rosca M10

Pro Stück / per piece / par pièce / por unidad

Art. Nr.: **150.03.00**

€ **1,20**



Hestex SN50 Eckverbinder 90° matt
Hestex SN50 cornerconnector 90° mat
Connecteur de coin 90° mat Hestex SN50
Hestex SN50 conector angular 90° mate

Pro Stück / per piece / par pièce / por unidad

Art.Nr.: **150.02.01**

€ **9,00**



Hestex SN50 Eckverbinder 90° chrom
Hestex SN50 cornerconnector 90° chromium
Connecteur de coin 90° chromé Hestex SN50
Hestex SN50 conector angular 90° cromado

Pro Stück / per piece / par pièce / por unidad

Art.Nr.: **150.02.02**

€ **10,00**



Hestex SGS 12x12 - 6,5 Verbinder
Hestex SGS 12x12 - 6,5 connector
Connecteur Hestex SGS 12x12 - 6,5
Hestex SGS 12x12 - 6,5 conector

Pro Stück / per piece / par pièce / por unidad

Art. Nr.: **120.45.31**

€ **3,30**



Bodenträger Metall
Profilecarrier metal
Pied de profil métallique
Soporte de suelo de metal

Pro Stück / per piece / par pièce / por unidad

Art. Nr.: **140.30.20**

€ **1,50**

 <p>HS PP37 Spannstoff-Profil HS PP37 tension fabric profile Profile de tension du tissu HS PP37 Perfil de tensión del tejido HS PP37</p> <p>Art. Nr.: 1100801 5000 5000 mm Art. Nr.: 1100801 3920 3920 mm Art. Nr.: 1100801 2930 2930 mm Art. Nr.: 1100801 1940 1940 mm Art. Nr.: 1100801 1360 1360 mm Art. Nr.: 1100801 0950 0950 mm Art. Nr.: 1100801 0660 0660 mm Art. Nr.: 1100801 0445 0445 mm</p>	<p>€65,00 €62,00 €49,00 €33,00 €27,00 €20,50 €18,00 €13,00</p>	 <p>Hestex XS Frame Hestex XS Rahmen Hestex XS Cadres Hestex XS Marcos</p> <p>495 x 2475</p>	<p>€ 300,00</p>
 <p>Hestex XS Frame Hestex XS Rahmen Hestex XS Cadres Hestex XS Marcos</p> <p>495 x 495</p>	<p>€ 140,00</p>	 <p>Hestex XS Frame Hestex XS Rahmen Hestex XS Cadres Hestex XS Marcos</p> <p>495 x 2970</p>	<p>€ 330,00</p>
 <p>Hestex XS Frame Hestex XS Rahmen Hestex XS Cadres Hestex XS Marcos</p> <p>495 x 990</p>	<p>€ 180,00</p>	 <p>Hestex XS Frame Hestex XS Rahmen Hestex XS Cadres Hestex XS Marcos</p> <p>990 x 990</p>	<p>€ 210,00</p>
 <p>Hestex XS Frame Hestex XS Rahmen Hestex XS Cadres Hestex XS Marcos</p> <p>495 x 1485</p>	<p>€ 210,00</p>	 <p>Hestex XS Frame Hestex XS Rahmen Hestex XS Cadres Hestex XS Marcos</p> <p>990 x 1485</p>	<p>€ 240,00</p>
 <p>Hestex XS Frame Hestex XS Rahmen Hestex XS Cadres Hestex XS Marcos</p> <p>495 x 1980</p>	<p>€ 270,00</p>	 <p>Hestex XS Frame Hestex XS Rahmen Hestex XS Cadres Hestex XS Marcos</p> <p>990 x 1980</p>	<p>€ 300,00</p>

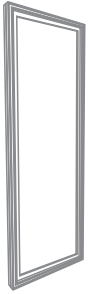

Hestex XS Frame
 Hestex XS Rahmen
 Hestex XS Cadres
 Hestex XS Marcos

990 x 2475

€ **330,00**



Hestex XS Frame
 Hestex XS Rahmen
 Hestex XS Cadres
 Hestex XS Marcos

990 x 2970

€ **360,00**

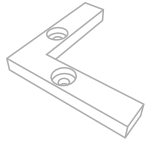

HS Eckverbinder Slimframe-Profil
 HS Cornerconnector slimframe profile
 Connecteur de coin pour profile à cadre fin HS
 Perfil de marco fino de la unión angular HS

€17,50

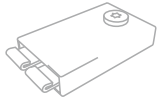

HS Verbinder SGS 6 Maxi
 HS Connector SGS 6 Maxi
 Connecteur HS SGS 6 Maxi
 Conector HS SGS 6 Maxi

€14,50



Endkappe geschlossen
End cap closed
Capot final fermé
Capuchón final cerrado

Pro Stück / per piece / par pièce / por unidad

Art. Nr.: **110.64.00**

€ **1,34**



Zahnstangenschloss
Lock
Serrure à tige dentée
Cierre de cremallera

Pro Stück / per piece / par pièce / por unidad

Art. Nr.: **110.67.00**

€ **13,00**



Laufschuhschloss
Cylinderlock
Serrure à cylindre
Cierre de palanca para cilindro

Pro Stück / per piece / par pièce / por unidad







Art. Nr.: **110.66.00**

€ **19,00**



 <p>Seitenführungsprofil, Aluminium Single side slide guide, aluminum Profil de support latéral l'aluminium Perfil de guía lateral aluminio</p> <p>Art. Nr.: 110.70.02 5000 mm</p> <p>€ 27,00</p>		 <p>Rolleneinsatz Roller element Roulette pour rail Carril deslizante</p> <p>Pro Stück / per piece / par pièce / por unidad</p> <p>Art. Nr.: 110.65.00</p> <p>€ 3,45</p>	
 <p>N 56 Laufschuhprofil N 56 Sliding door profile N 56 Profil coulissant N 56 Perfil para pata deslizante</p> <p>Art. Nr.: 110.62.01 5000 mm</p> <p>€ 44,00</p>		 <p>Lenkrolle mit Gewinde M10 Castor, black, with screwhead M10 Roulette inclinable à filetage M10 Rodillo guía con rosca M10</p> <p>Pro Stück / per piece / par pièce / por unidad</p> <p>Art. Nr.: 110.50.11</p> <p>€ 5,25</p>	
 <p>Anwendungsbeispiel PS 20 / PS 10 Passend für Hestex Standard 4 mm, Glas oder Holz.</p> <p>Slidingbeam example PS 20 / PS 10 Suitable for Hestex Standard 4mm, glass or wood</p> <p>Exemple d'utilisation pour PS 20 / PS 10 Approprié pour système Hestex Standard 4 mm, ver ou bois</p> <p>Ejemplo de uso PS 20 / PS 10 Para Hestex Standard 4 mm, vidrio o madera</p>		 <p>Lenkrolle mit Stopper & Gewinde M10 Castor, black, with brake & screwhead M10 Roulette inclinable avec arrêt à filetage M10 Rodillo guía con freno & rosca M10</p> <p>Pro Stück / per piece / par pièce / por unidad</p> <p>Art. Nr.: 110.48.12</p> <p>€ 6,00</p>	
 <p>Gummikappe für Hammerkopfschraube Cap for screw Capot caoutchouc pour vis Caperuza de goma para tornillo</p> <p>Pro Stück / per piece / par pièce / por unidad</p> <p>Art. Nr.: 140.30.33</p> <p>€ 0,14</p>		 <p>Endkappe offen End cap open Capot final ouvert Capuchón final abierto</p> <p>Pro Stück / per piece / par pièce / por unidad</p> <p>Art. Nr.: 110.63.00</p> <p>€ 1,40</p>	
 <p>SN 220 Hammerkopfschraube 20mm SN 220 Screw 20mm SN 220 Vis 20mm SN 220 tornillo con cabeza en forma de tornillo 20mm</p> <p>Pro Stück / per piece / par pièce / por unidad</p> <p>Art. Nr.: 110.42.20</p> <p>€ 0,95</p>		 <p>SN 220 Hammerkopfschraube 40mm SN 220 Screw 40mm SN 220 Vis 40mm SN 220 tornillo con cabeza en forma de tornillo 40mm</p> <p>Pro Stück / per piece / par pièce / por unidad</p> <p>Art. Nr.: 110.42.40</p> <p>€ 1,85</p>	



 <p>Doppelführung TYP 96 oben, Aluminium Upper double slide guide TYPE 96, aluminum Double guide supérieur TYPE 96 l'aluminium Cañón doble MODELO 96 parte superior aluminio</p> <p>Art. Nr.: 110.68.02 5000 mm</p>	<p>€ 33,00</p>	 <p>Rundrohr 10mm Round pipe 10mm Pipe ronde 10mm Pipa redonda 10mm</p> <p>Art. Nr.: 110.49.11 5000 mm</p>	<p>€ 8,50</p>
 <p>U-Profil 8 x 8 x 1mm U-Profile 8 x 8 x 1mm U-Profil 8 x 8 x 1mm U-Perfil 8 x 8 x 1mm</p> <p>Art. Nr.: 110.50.12 5000 mm</p>	<p>€ 19,00</p>	 <p>Schiebetürprofil silber oben, Kunststoff (PS20) Upper double slide guide, synthetic material Profil supérieur pour porte coulissante, plastique argenté Perfil para puerta corredera plateado parte superior / Plástico</p> <p>Art. Nr.: 110.54.13 5000 mm</p>	<p>€ 29,00</p>
 <p>Doppellauf TYP 96 unten, Aluminium Lower double slide guide TYPE 96, aluminum Double guide inférieur TYPE 96 l'aluminium Cañón doble MODELO 96 parte inferior aluminio</p> <p>Art. Nr.: 110.69.02 5000 mm</p>	<p>€ 22,00</p>	 <p>Schiebetürprofil silber unten, Kunststoff (PS10) Lower double slide guide, synthetic material Profil inférieur pour porte coulissante, plastique argenté Perfil para puerta corredera plateado parte inferior / Plástico</p> <p>Art. Nr.: 110.55.13 5000 mm</p>	<p>€ 21,00</p>