

JEDO

collection

catalogue

41

the name of quality architectural hardware



FRELAN
HARDWARE



Frelan hardware began 40 years ago and has over the years established itself as one of the leading suppliers of ironmongery to the trade and DIY markets.

Our goal is to combine quality products and service at competitive prices which suit the needs of our customers. .

Our latest catalogue brings together an even larger range of products offering a wider choice of styles and finishes to suit our customers requirements for use in both the domestic and commercial sectors.

Offering contemporary and classic designs in our range of door and window furniture manufactured in factories from around the world we have brought together a collection of products manufactured from materials such as zinc, brass , aluminium, glass and even incorporating Swarovski crystal elements.

We have collated designs and styles offering choice and quality to help our customers to provide the ever changing market place with a diversity of products from which any design can be achieved .



CONTENTS

Levers on rose and matching accessories	04 - 41
Levers on backplate	42 - 57
PVCu door and window furniture	58 - 61
Stainless steel furniture	62 - 87
Pull handles	88 - 90
Signage and plates	91 - 95
Black antique furniture	96 - 109
Pewter furniture	110 - 117
Aluminium furniture	118 - 123
Mortice & rim knob furniture	124 - 131
Glass furniture	132 - 141
Porcelain furniture	142 - 144
Cabinet furniture	145 - 155
Hanging rail & fittings	156 - 157
Crystal furniture	158 - 162
Exterior door furniture	163 - 170
Locks & latches	171 - 189
Espagnolette bolts	190 - 194
Hinges	195 - 209
Door controls	210 - 213
Window furniture	214 - 219
Accessories	220 - 230



AB - Antique Bronze	PAA - Polished Anodised Aluminium	RUS - Rustic
BL - Black	PBSC - Polished Brass/Satin Chrome	S - Silver
BN - Brushed Nickel	PBN - Polished Black Nickel	SAA - Satin Anodised Aluminium
BR - Bronze	PBNP - Polished Brass/Nickel Plated	SB - Satin Brass
BZP - Bright Zinc Plated	PB - Polished Brass	SC - Satin Chrome
DB - Dark Bronze	PC - Polished Chrome	SE - Silver Enamelled
EB - Electro Brassed	PCBN - Polished Chrome/Polished Black Nickel	SN - Satin Nickel
G - Gold	PCSC - Polished Chrome/Satin Chrome	SSPS - Satin Stainless/Polished Stainless
GLB - Goldline Black	PCSN - Polished Chrome/Satin Nickel	SSS - Satin Stainless Steel
GLW - Goldline White	PEW - Pewter	T - Tin Finish
GY - Grey	PN - Polished Nickel	WH - White
GN - Green	PSS - Polished Stainless Steel	Y - Yellow
NP - Nickel Plated	PVD - Brass Finish	ZP - Zinc Plated

GLOSSARY OF TERMS AND SYMBOLS USED



Items available in display packaging



British & European Standard requirements and testing methods covering lever handles and knob furniture.



British & European Standard requirements and testing methods covering locks and latches.



British & European Standard requirements and testing methods covering single axis hinges



British & European Standard requirements and testing methods covering controlled door closing devices



British Standard for thief resistant lock assembly-key egress.



The European Fire Safety Standard for determining the fire resistance of door and shutter assemblies, including door hardware.



30 minute fire doors



60 minute fire doors



30/60 minute fire doors



30/60/120 minute fire doors



30/60/240 minute fire doors



CE marked ironmongery products have been third party tested to the relevant BS-EN standard; with evidence of satisfactory performance in a relevant fire test and produced in a factory which has a production control system in place which has been assessed by the certification body.



Certifire is an independent third party certification scheme that assures performance, quality, reliability and traceability of products. Recognised by regulatory authorities worldwide. It is an internationally respected mark of fire safety and one of the most authoritative in the industry.

DESIGNER



A stylish mix of classical and modern designs manufactured from zinc or brass and plated to create a wide choice of finishes with matching escutcheons and turns & releases



TWIN

GRADE 4 EN1906

JEDGO collection



JV430PCSC

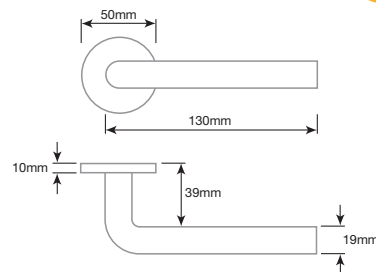

MAILAND

GRADE 4 EN1906



JV710PC

JV710PVD

JV710SC

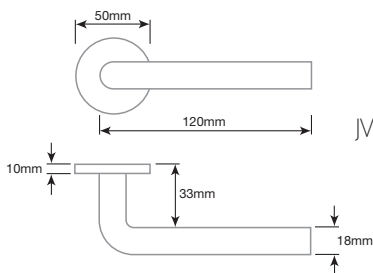

THAME

GRADE 4 EN1906



JV502PB

JV502PC

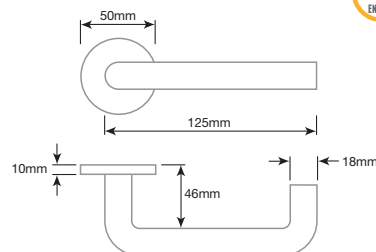

CHARLOTTE

GRADE 4 EN1500

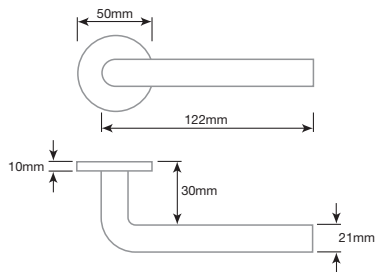

JV467PCSN

AVANTIME

GRADE 4 EN1500

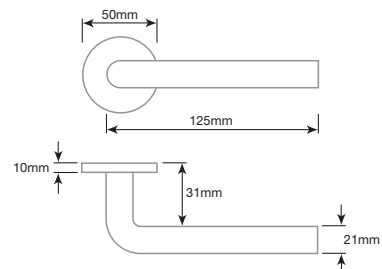

JV555PCSC

ATHENA

GRADE 4 EN1500

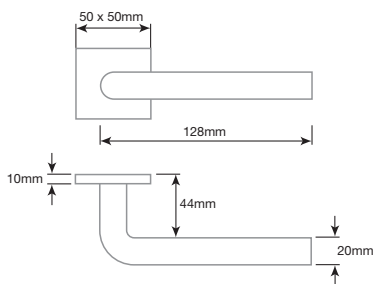

JV3002PCSC



ALEXANDER

GRADE 4 EN1906

JEDOO collection



JV465PCSN

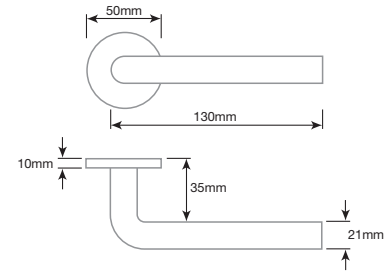

MODENA

GRADE 4 EN1906



JV780PCBN

JV780PCSC

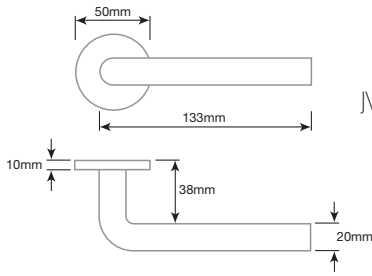

OLIVIA

GRADE 4 EN1906



JV466PCSN

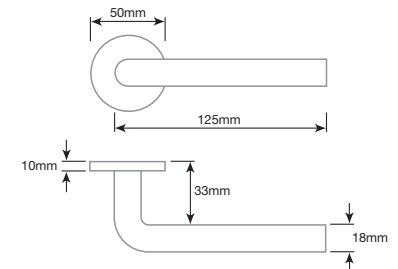

OCTAVIA 

GRADE 4
EN1505

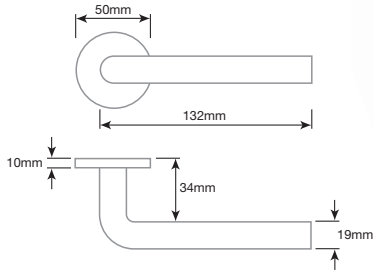

JV765PCBN

JV765PCSC

OXFORD 

GRADE 4
EN1505



JC6003PC
Cream crackle china

JC6002PC
White china

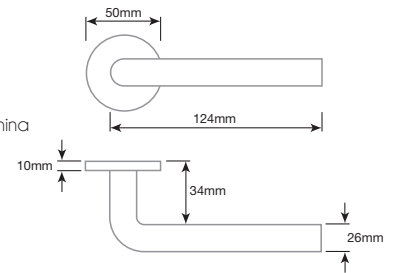

MITRED 

GRADE 4
EN1505

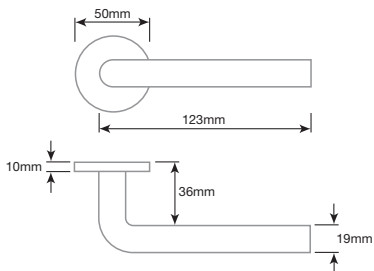

JV435PCBN

JV435PCSC

JV650PB



JV650SN



JV650AB



JV650PN

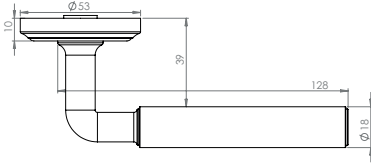

GISELLE

JV652PB



JV652SN



JV652AB



JV652PN

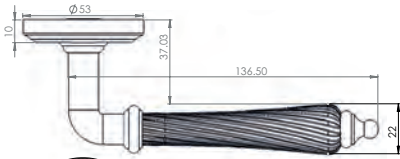

CAMILLE

JV651PB



JV651SN



JV651AB



JV651PN

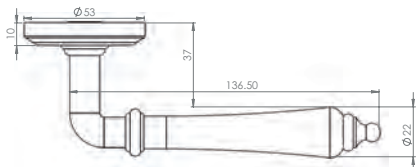

LYDIA



GRADE
4
EN1906

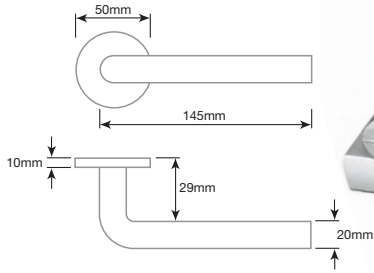

JV790PCSC

SEROS



GRADE
4
EN1906



JV3001SC

JV3001PC

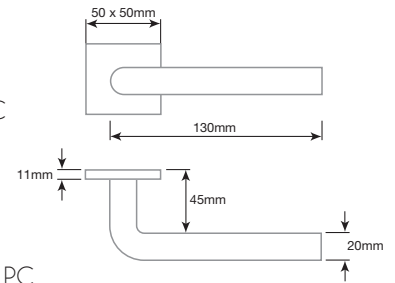

AERODECK



GRADE
4
EN1906

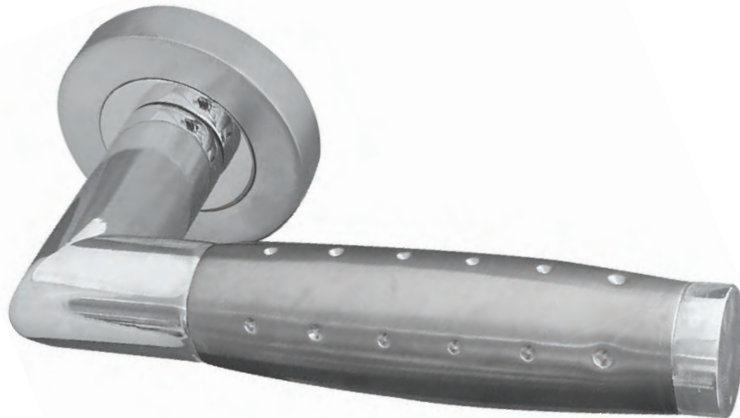
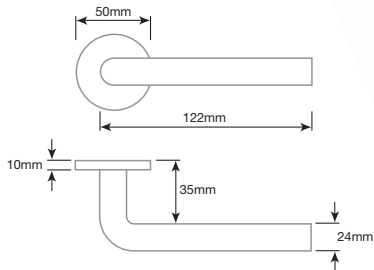

JV482PCSC



ARKUS

GRADE
4
EN1906

JEDDO
collection

JV760PCBN



JV760PCSC

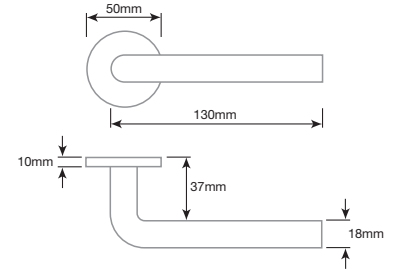

GULL

GRADE
4
EN1906

JV420PVD



JV420PC



JV420SC

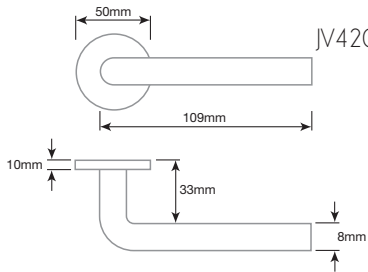

MILO GLASS

JH5314SC



JH5314PC

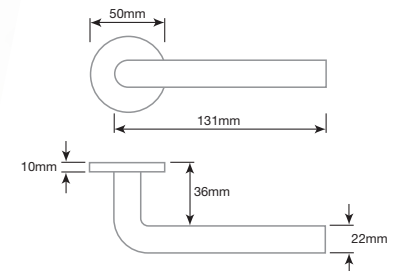

MONACO

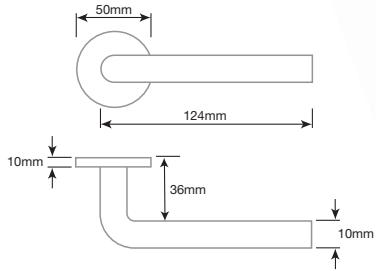

JV690SC

JV690PC

GAMMA

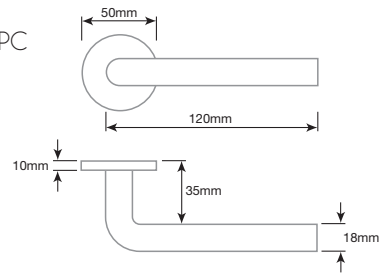

JV509PC

JV509PVD

JV509SC

FLUTED GLASS

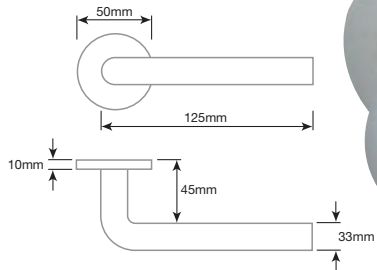

JH5312PC

JH5312SC





JV504PCSC

JV504PVD

JV504PC

JV504SC

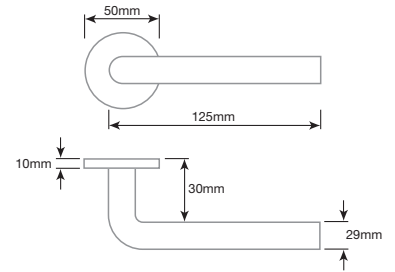

JV508SN

JV508PC

JV508PVD

JV508SC

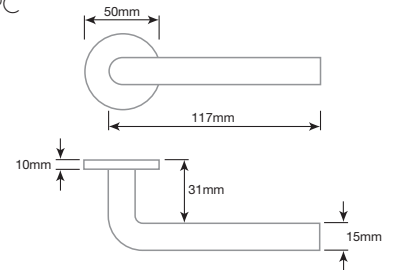



TURIN



JEDGO
collection

JV550SC



JV550PVD

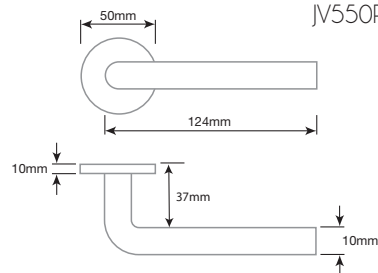

JV550PC

JV550RUS



CURVE



JV520SN



JV520PC

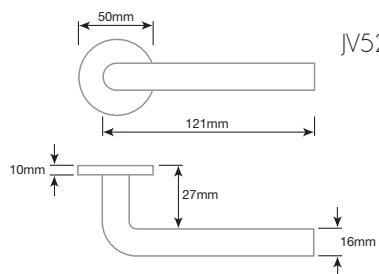

JV520PVD

JV520SC

COMET

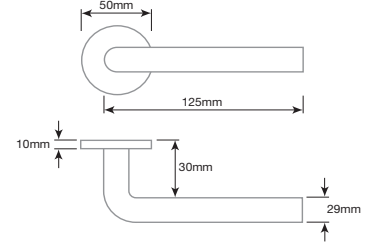

CAPRI

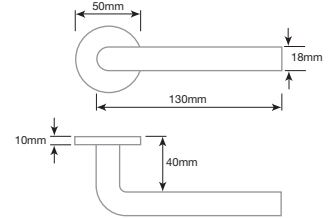

OPAL

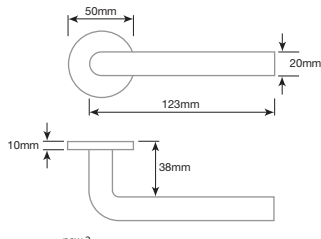



ROSETTA

kontrax
aluminium

JV843SC



JV843PC

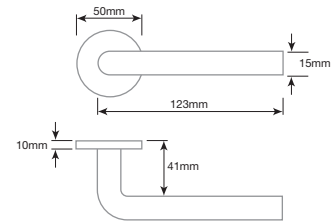

LORENZO

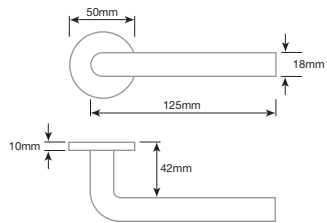

JV861PCSC



ASTRAL

JV842PC



JV842SC

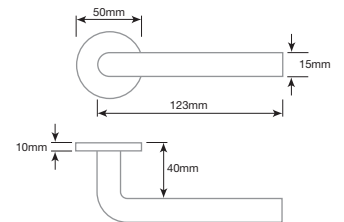

MATCHING ESCUTCHEONS

STANDARD LEVER KEY

50mm x 10mm



JV503PVD
JV503PC
JV503PCBN
JV503PCSC
JV503PCSN
JV503RUS
JV503SB
JV503SC
JV503SN

OVAL PROFILE

50mm x 10mm



JV503UPVD
JV503UPC
JV503UPCSC
JV503USC

EURO PROFILE

50mm x 10mm



JV503EPVD
JV503EPC
JV503EPCBN
JV503EPCSC
JV503EPCSN
JV503ERUS
JV503ESC
JV503ESN

PARISIAN

42mm x 10mm



JV604PN



JV604SN



JV604PB



JV604AB

STANDARD LEVER KEY

50mm x 11mm



JV3005PC
JV3005PCSC
JV3005SC

EURO PROFILE

50mm x 11mm



JV3005EPC
JV3005EPCSC
JV3005ESC

MATCHING TURNS AND RELEASES

TURN & RELEASE

35mm x 8mm



JV2777PVD
JV2777PC
JV2777PCSC
JV2777PN
JV2777SC
JV2777SN

TURN & RELEASE

50mm x 10mm



WITH INDICATOR

JV421PVD
JV421PC
JV421PCSC
JV421SC

WITHOUT INDICATOR

JV422PVD
JV422PC
JV422PCSC
JV422SC

PARISIAN TURN & RELEASE

40mm x 13mm



JV2652AB
JV2652PB
JV2652PN
JV2652SN

TURN & RELEASE

50mm x 10mm



JV2666PVD
JV2666PC
JV2666PCBN
JV2666PCSC
JV2666PCSN
JV2666RUS
JV2666SB
JV2666SC
JV2666SN

EASY TURN & RELEASE

50mm x 10mm



WITH INDICATOR

JV2888PB
JV2888PC
JV2888SC

WITHOUT INDICATOR

JV2889PB
JV2889PC
JV2889SC

TURN & RELEASE

50mm x 11mm



JV3266PC
JV3266PCSC
JV3266SC

A range of levers and accessories
manufactured in Portugal from solid brass and
available in stock in PB , PC or SC finish or to
special order in many other finishes



SPIRAL

JV819SC



JV819PC

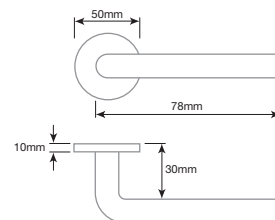

GOCCIA

JV700SC



JV700PB



JV700SN

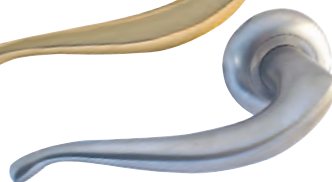

JV700PC

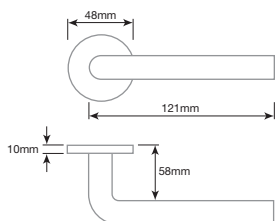

JV4001PC



JV4001SC

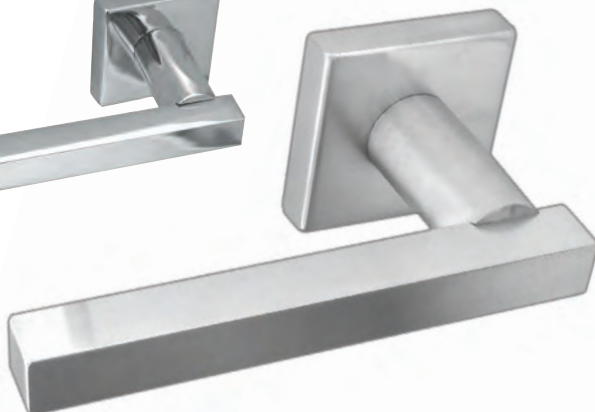

KUBUS STRAIGHT

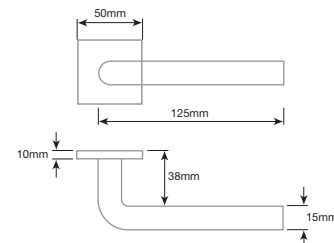

ASCOT
BROWN LEATHER

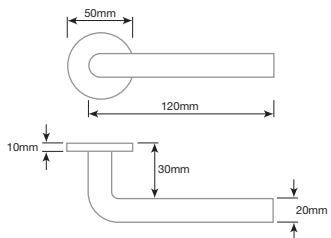

ALLADIN

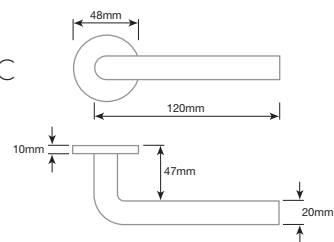

HORN

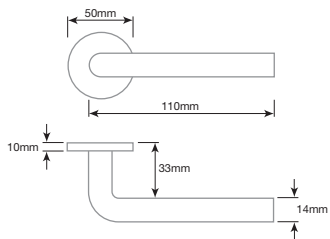

KUBUS CURVED

JV4002PC



JV4002SC

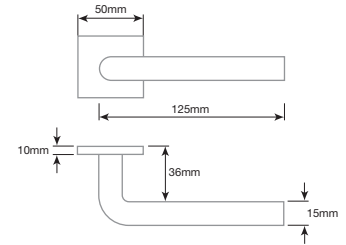

LAGUNA

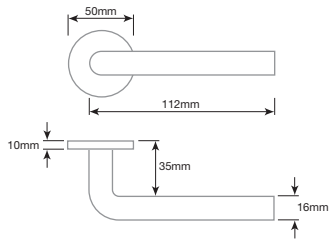

JV720SC



JV720PB



JV720PC



FLOW

JV630SC



JV630PC

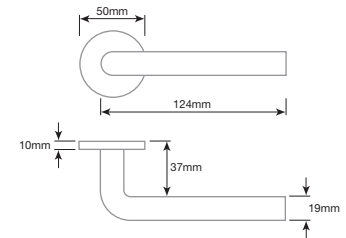

ARTICA

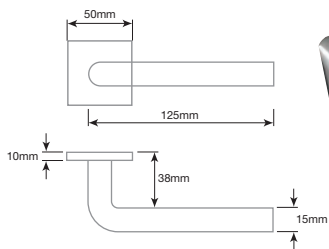

JV818SC

JV818PC

CANTO



JV746SC

JV746PB

JV746PC

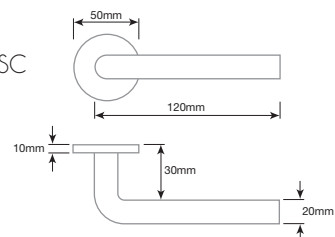

CLUB

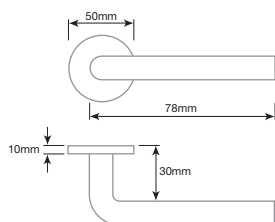

JV721SC

JV721PC

ASCOT
BLACK LEATHER

Paja
Fabrica de Ferragens, S.A.

JV4010SC



JV4010PC

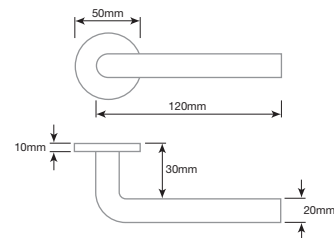

GARDA

JV480PB



JV480PC



JV480SC

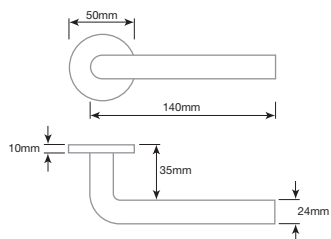

MATCHING ESCUTCHEONS

STANDARD LEVER KEY

48mm x 10mm

JV702PB
JV702PC
JV702SC
JV702SN



EURO PROFILE

48mm x 10mm

JV703PB
JV703PC
JV703SC
JV703SN



OVAL PROFILE

48mm x 10mm

JV704PB
JV704PC
JV704SC
JV704SN



STANDARD LEVER KEY

50mm x 11mm

JV4005PC
JV4005SC



EURO PROFILE

50mm x 11mm

JV4005EPC
JV4005ESC



STANDARD LEVER KEY

50mm x 10mm



JV503



See page 18 for Finishes

EURO PROFILE

50mm x 10mm



JV503E



See page 18 for Finishes

OVAL PROFILE

50mm x 10mm



JV503U



See page 18 for Finishes

MATCHING TURNS AND RELEASES

TURN & RELEASE

48mm x 10mm



JV701PB
JV701PC
JV701SC
JV701SN

TURN & RELEASE

48mm x 11mm



JV4266PC
JV4266SC

TURN & RELEASE

50mm x 10mm



WITH INDICATOR

JV2888

See page 19 for Finishes

WITHOUT INDICATOR

JV2889

See page 19 for Finishes

TURN & RELEASE

50mm x 10mm



WITH INDICATOR

JV421

See page 19 for Finishes

WITHOUT INDICATOR

JV422

See page 19 for Finishes

TURN & RELEASE

50mm x 10mm



JV2666

See page 19 for Finishes

Classic and stunning contemporary designs made using zinc and brass manufactured and designed in Italy



ROMBO



JV409SC

JV409PC

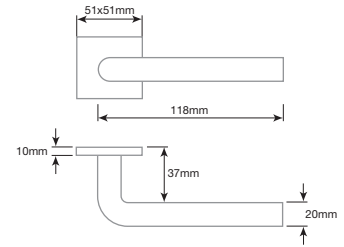

HAVANNA

JV455PC

JV455PB

JV455SC

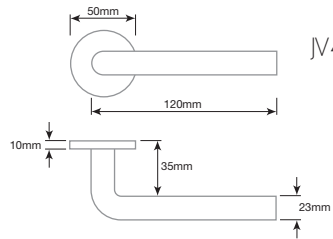

INOXIA

JV495PCSC

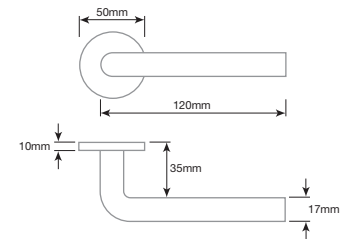

STYLO

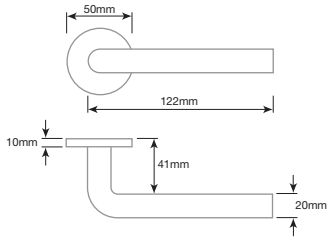

JV490SC

JV490PC

CUBA



JV455DSC

JV455DPB

JV455DPC

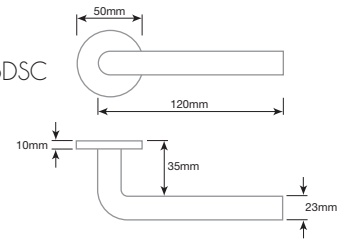

ARC

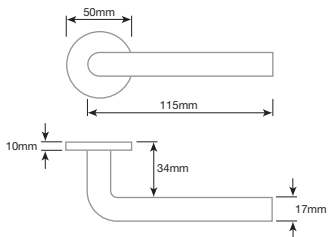

JV450SC

JV450PC

PHAEDRA



JV540SC



JV540PC

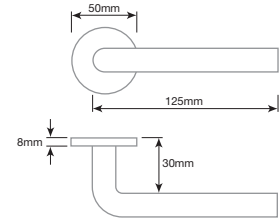

CLASSIC

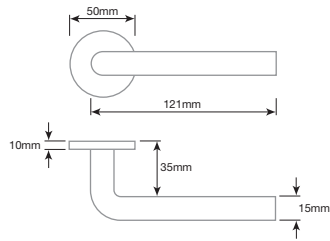

JV440PC



JV440SC



MINIMAL

JV426SC

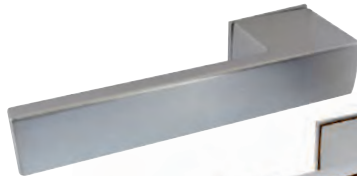

JV426PC

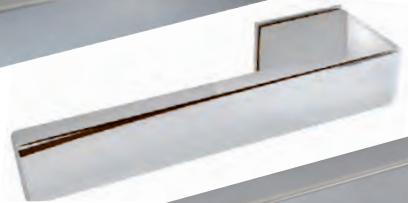

JV426PCSC

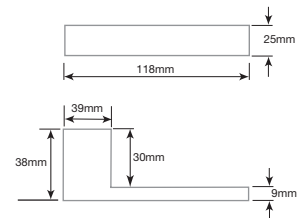

We recommend using with heavy duty latches see page 181

MAGRO

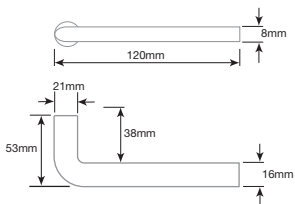

JV119PC

JV119SC

EBONY

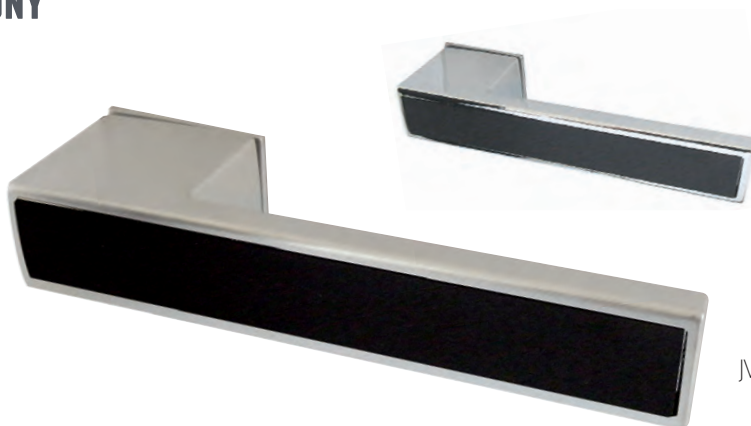

JV425PC

JV425SC

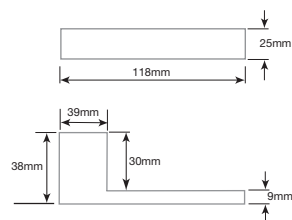

We recommend using with heavy duty latches see page 181

COLLINA

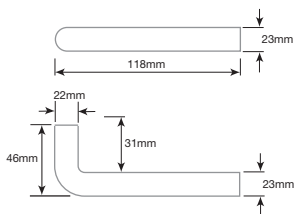

JV195SC

JV195PC



MATCHING ESCUTCHEONS

ROMBO

STANDARD LEVER KEY

50mm x 10mm

JV411PC
JV411SC



EURO PROFILE

50mm x 10mm

JV411EPC
JV411ESC



MATCHING MINIMAL RANGES

STANDARD LEVER KEY

25mm x 25mm



JV220SC
JV220PC

STANDARD LEVER KEY

25mm



JV221SC
JV221PC

EURO PROFILE

25mm x 40mm



JV222SC
JV222PC

EURO PROFILE

25mm x 40mm



JV223SC
JV223PC

ROMBO

TURN & RELEASE

50mm x 10mm

JV416PC
JV416SC



EASY TURN & RELEASE

50mm x 10mm



WITH INDICATOR

JV2888

See page 19 for Finishes

WITHOUT INDICATOR

JV2889

See page 19 for Finishes

TURN & RELEASE

Matching minimal ranges
25mm



WITHOUT INDICATOR

JV2202SC

JV2202PC

TURN & RELEASE

Matching minimal ranges
25 x 25mm



WITHOUT INDICATOR

JV2201SC

JV2201PC

DRILL - MILLER & BIT FOR FLUSH FIT.
VF22FSOTQ



High quality brass and zinc handles designed and made in Italy to a high quality to enable a rich designer finish to any specification

CLOUD

mariani

JV578SC



JV578PC

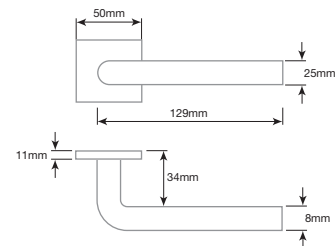

BALENO

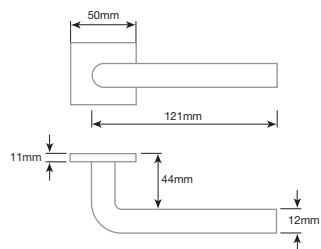

JV595SC



JV595PC



SCAN

JV572SC



JV572PC

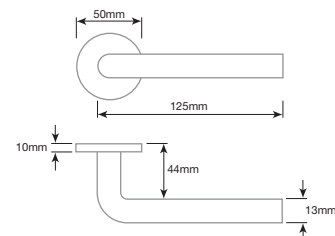

KATE

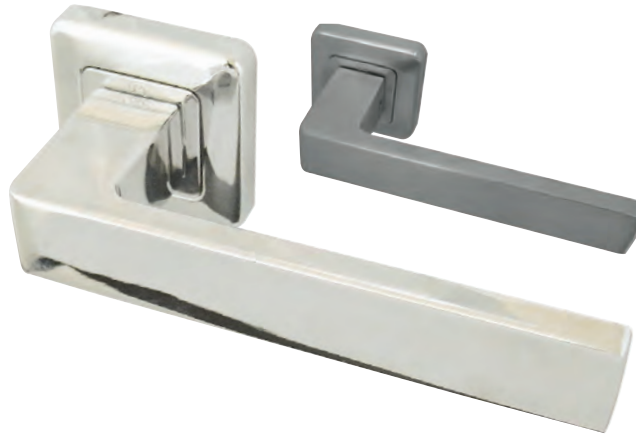
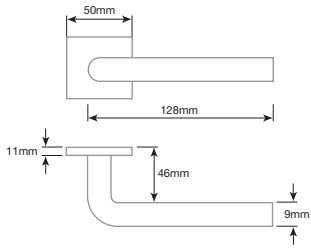

JV593SC

JV593PC

ARTE



JV5001SC

JV5001PC

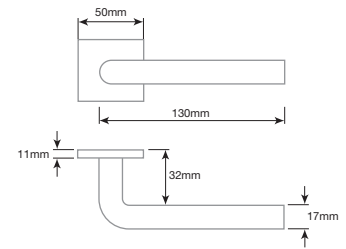

SUN

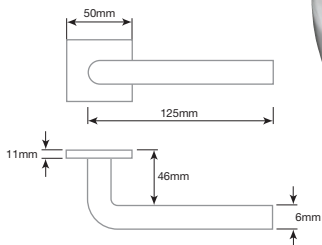

JV574PC

JV574SC

COMET

mariani®

JV5003PC



JV5003SC

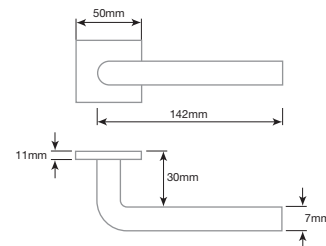

KLAUDIA

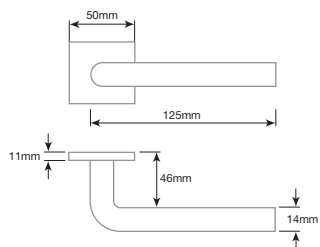

JV594SC



JV594PC



ZENITH

JV5002PC



JV5002SC

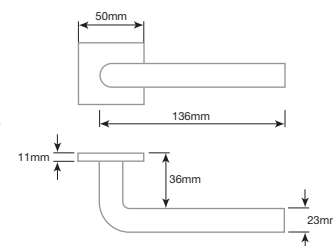

MATCHING ESCUTCHEONS & TURNS AND RELEASES

STANDARD LEVER KEY

50mm x 7mm

JV575PC
JV575SC



EURO PROFILE

50mm x 7mm

JV575EPC
JV575ESC



TURN & RELEASE

50mm x 7mm

JV576PC
JV576SC



STANDARD LEVER KEY

50mm x 11mm

JV5004PC
JV5004SC



EURO PROFILE

50mm x 11mm

JV5005PC
JV5005SC



TURN & RELEASE

50mm x 11mm

JV5006PC
JV5006SC





LEVER FURNITURE

Our range of levers on plates are manufactured using zinc or brass with a variety of finishes in a selection of standard classic and stunning modern designs



Bathroom
JV3023PC
JV3023SC



Latchset
JV3013PC
JV3013SC



Lockset
JV3003PC
JV3003SC



Euro Lockset
JV3003EPC
JV3003ESC

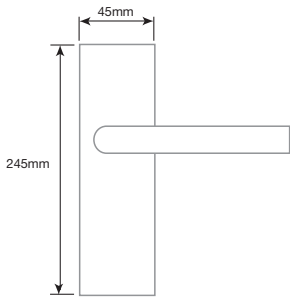
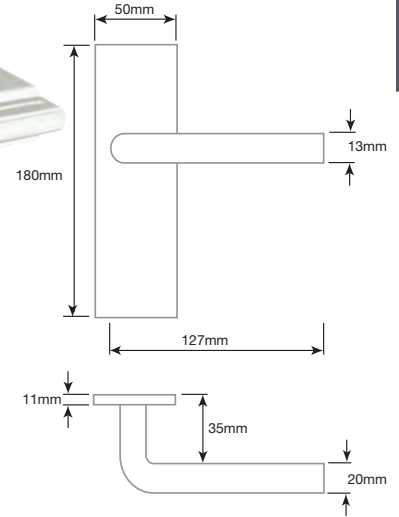

Bathroom
JV580BT

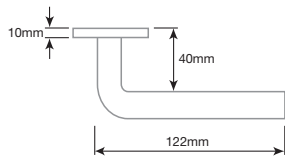

Latchset
JV581T



VENEZIA

Lockset
JV580T



PARIS

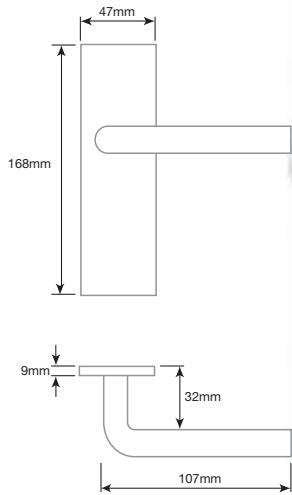

Bathroom
JV283PC

Bathroom
JV283AB
JV283PVD
JV283PC
JV283SC



Lockset
JV280AB
JV280PVD
JV280PC
JV280SC



Latchset
JV281AB
JV281PVD
JV281PC
JV281SC

TWIN



Latchset
JV432PCSC



Lockset
JV431PCSC



Euro Lockset
JV531EPCSC



Bathroom
JV433PCSC

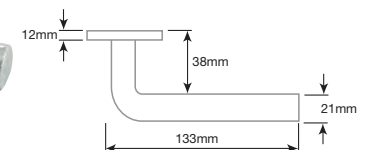
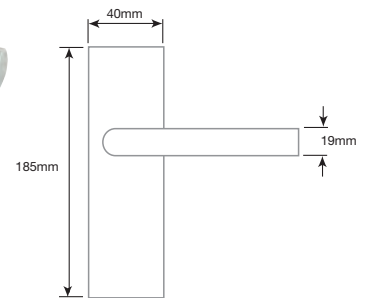

Bathroom
IRC4000B



Latchset
IRC4001



Lockset
IRC4000

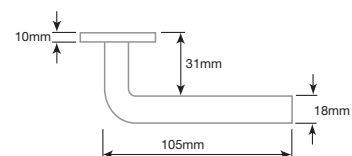
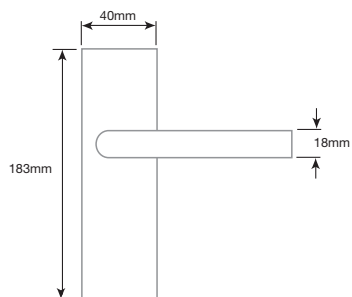
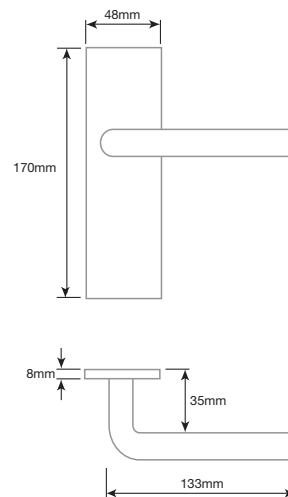

Lockset
JV660PB
JV660PC
JV660SC



Euro Lockset
JV660EPB
JV660EPC
JV660ESC



Latchset
JV661PB
JV661PC
JV661SC



Bathroom
JV660BPB
JV660BPC
JV660BSC



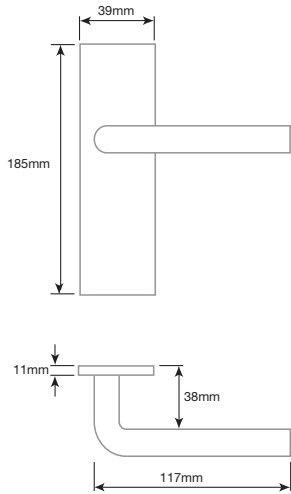

DECO

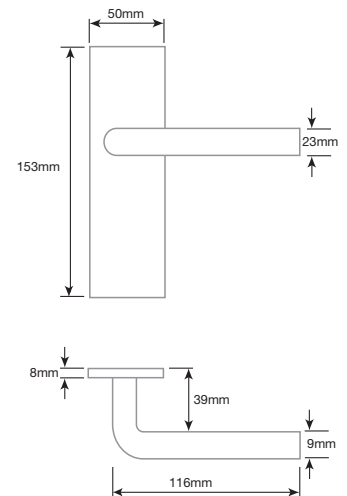



VICTORIAN STRAIGHT LEVER



*Bathroom
Long Plate
JV30BPB
JV30BPC
JV30BSC*



*Euro Lockset
Long Plate
JV30EPB
JV30EPC
JV30ESC*

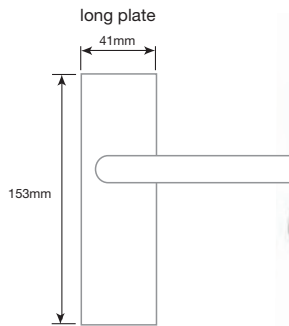

*Lockset
Long Plate
JV30PB
JV30PC
JV30SC*



*Latchset
Short Plate
JV31PB
JV31PC
JV31SC*

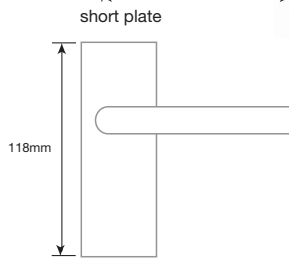
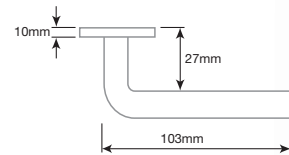

*Privacy Set
Short Plate
JV31PRPB
JV31PRPC
JV31PRSC*



*Latchset
Long Plate
JV31LPB
JV31LPC
JV31LSC*



*Euro Lockset
Long Plate
JV10EPB
JV10EPC
JV10ESC*



*Bathroom
Long Plate
JV10BPB
JV10BPC
JV10BSC*



*Latchset
Short Plate
JV11PB
JV11PC
JV11SC*



*Lockset
Long Plate
JV10PB
JV10PC
JV10SC*



*Latchset
Long Plate
JV11LPB
JV11LPC
JV11LSC*



*Privacy Set
Short Plate
JV11PRPB
JV11PRPC
JV11PRSC*

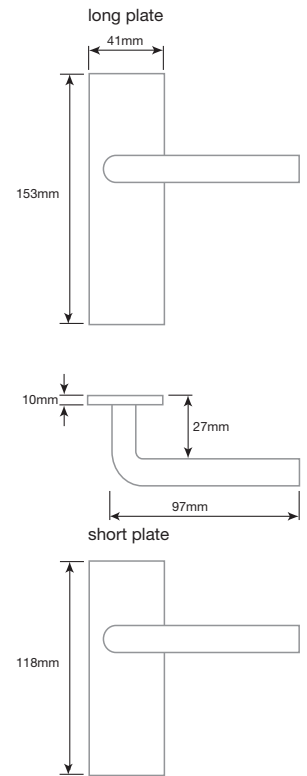

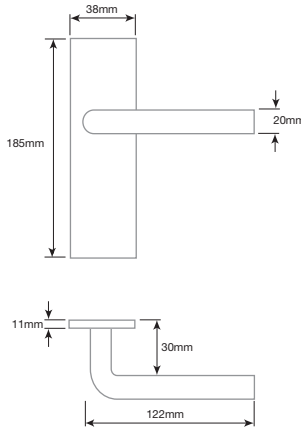

Latchset
JV437PCSC



Lockset
JV436PCSC



Euro Lockset
JV431EPCSC



Bathroom
JV438PCSC



Latchset
JV251PB
JV251PC
JV251SC



Lockset
JV250PB
JV250PC
JV250S



Euro Lockset
JV250EPB
JV250EPC
JV250ESC



Bathroom
JV250BPB
JV250BPC
JV250BSC

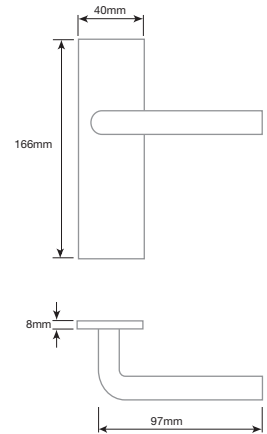



Bathroom
Long Plate
JG1BPB



Latchset
Long Plate
JG1APB



Lockset
Long Plate
JG1PB



Latchset
Short Plate
JG2PB



Privacy Set
Short Plate
JG2PRPB

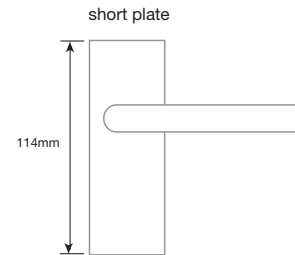
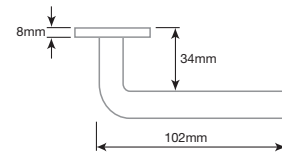
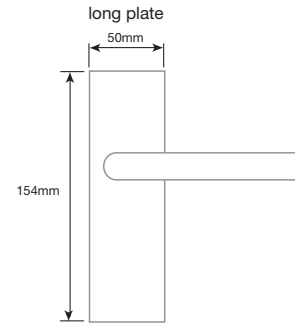

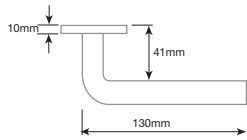
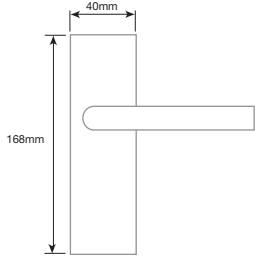

Lockset
JV390AB
JV390PC
JV390SC



Latchset
JV391AB
JV391PC
JV391SC



Bathroom
JV393AB
JV393PC
JV393SC



Bathroom
JV193AB
JV193PC
JV193SC



Lockset
JV190AB
JV190PC
JV190SC



Latchset
JV191AB
JV191PC
JV191SC

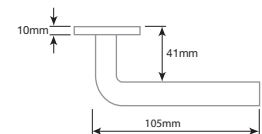
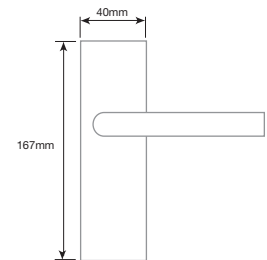

Lockset
JV270AB
JV270PC
JV270SC



Latchset
JV271AB
JV271PC
JV271SC



Bathroom
JV273AB
JV273PC
JV273SC

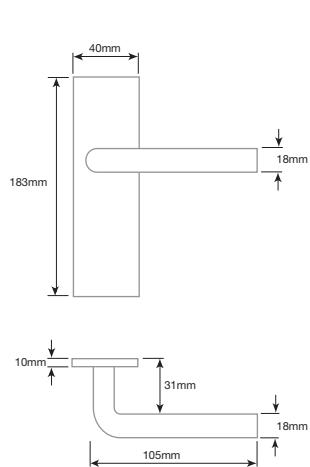
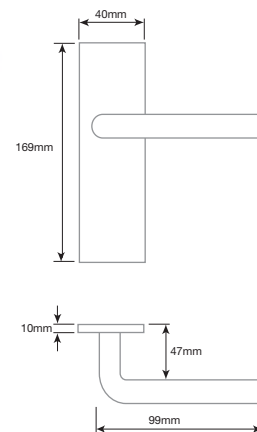

Bathroom
JV498PC
JV498SC



Lockset
JV496PC
JV496SC



Latchset
JV497PC
JV497SC

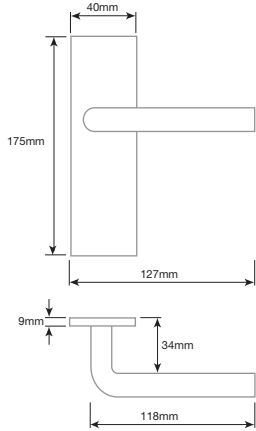

Bathroom
JV922PC
JV922SC



Lockset
JV920PC
JV920SC

Latchset
JV921PC
JV921SC



Bathroom
JV260BPB
JV260BPN
JV260BSN



Latchset
JV261PB
JV261PN
JV261SN



Lockset
JV260PB
JV260PN
JV260SN

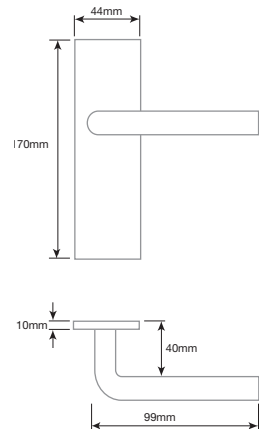



GEORGIAN KONTRAX SUITE

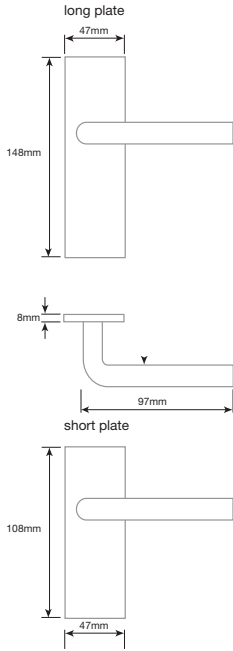

EPSOM KONTRAX SUITE

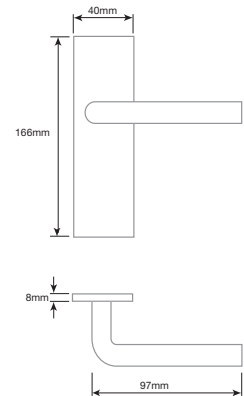



VICTORIAN KONTRAX STRAIGHT LEVER

Kontrax

Privacy
Short Plate
JV331PR EB



Bathroom
Long Plate
JV330B EB



Lockset
Long Plate
JV330 EB



Latchset
Short Plate
JV331 EB

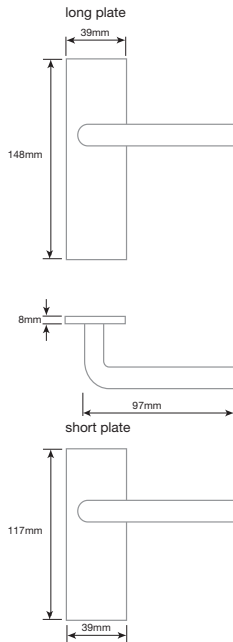
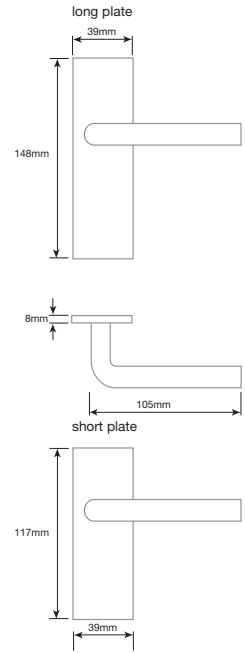

VICTORIAN KONTRAX SCROLL LEVER

Bathroom
Long Plate
JV130B EB



Lockset
Long Plate
JV130 EB



Privacy
Short Plate
JV131PR EB



Latchset
Short Plate
JV131 EB



PVCu

FOR DOORS & WINDOWS

Introducing a selection of door and window furniture designed for PVCu doors and windows which are equally at home with modern wooden doors and windows.





PVCu FURNITURE FOR WINDOWS

LOCKSETS FOR PVCu & WOODEN DOORS

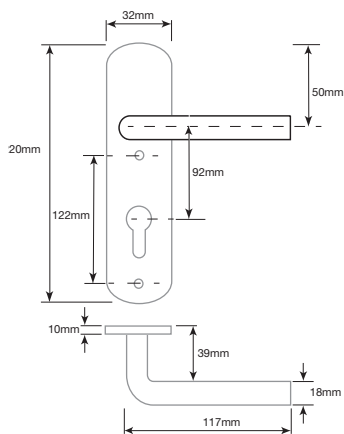

JW70SC



JW70PC



JW70WH



JW70PVD



LOCKING ESPAGNOLETTE WINDOW FASTENER FOR PVCu & WOODEN DOORS

SPINDLE 7mm X 45mm
FIXING CENTRES 43mm



JW79LSC



JW79LPB



JW79LWH



JW79LPC

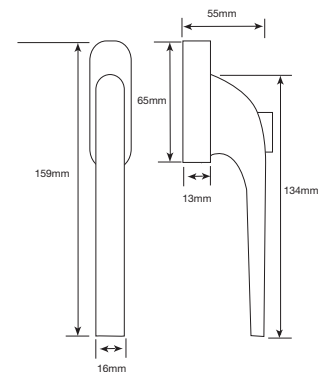

PVCu FURNITURE

TELESCOPIC LETTERPLATE



JW80S SILVER
JW80G GOLD
JW80WH WHITE

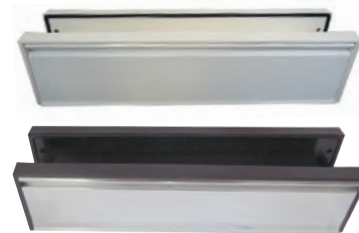

Letterplate with brush seal.
Sleeved to suit doors 38 to 65mm

Size 295mm x 71mm
Aperture 256mm x 38mm
Fixing centres 27mm x 6mm

TELESCOPIC LETTERPLATE BLACK ANTIQUE

JAB113

Size 274mm x 71mm
Aperture 230mm x 41mm
Fixing centres 243mm
Sleeve width 45mm to 75mm



nb. We do not recommend pre cutting of doors as sizes are approximate and may differ to those shown.

LOCKING ESPAGNOLETTE FASTENER BLACK ANTIQUE



Handle 100mm
Projection 35mm
Spindle 35mm
fixing centres 43mm

JAB19E-LH

JAB19E-RH

R.H pictured

LOCKING ESPAGNOLETTE FASTENER PEWTER



Handle 100mm
Projection 35mm
Spindle 35mm
fixing centres 43mm

PEW19E-LH

PEW19E-RH

R.H pictured

PVCu FURNITURE

LOCKSETS FOR PVCu & WOODEN DOORS BLACK ANTIQUE

JAB700

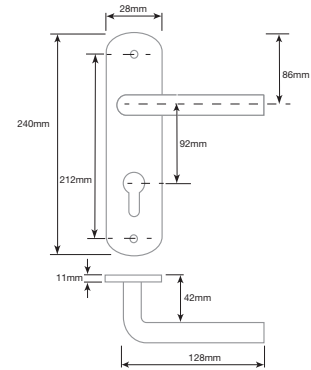

LOCKSETS FOR PVCu & WOODEN DOORS PEWTER

PEW700

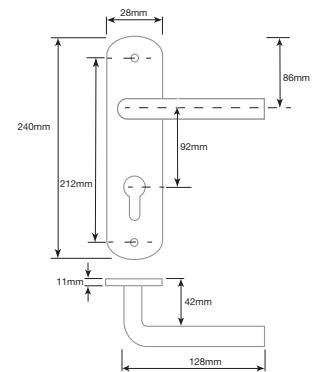

FURNITURE

STAINLESS STEEL

Our range of stainless steel furniture is manufactured using grade 304 and 202 stainless steel and is ideal for use in both commercial and domestic situations



CAMBRIO

MITRED LEVER

JSSPS701 SSPSS



GRADE 304

GRADE 4 EN1506

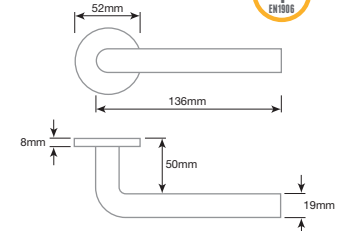

Tested to 200,000 cycles

RADIUM

JPS403 PSS

GRADE 304

GRADE 4 EN1506

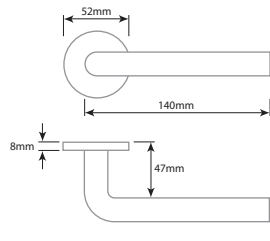

JSS403 SSS

GRADE 304

GRADE 4 EN1506



JSS304 SSS

GRADE 201

GRADE 3 EN1506

Tested to 200,000 cycles

SANDRINE

JSS580 SSS



JPS580 PSS



GRADE 304

GRADE 4 EN1506

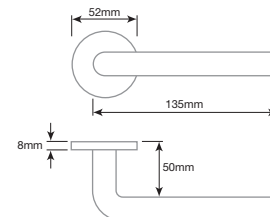

Tested to 200,000 cycles

SIRIUS

GRADE 304

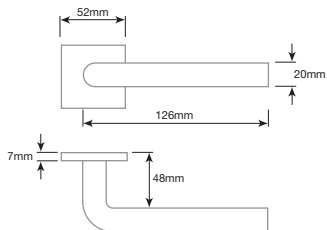

JSS280 SSS

JPS280 PSS

ORBIT 19mm



JPS01 PSS
5mm Unsprung Rose
JPS13 PSS
8mm Sprung Rose

GRADE 304

GRADE 4 EN1008

GRADE 304

GRADE 4 EN1008

GRADE 201

GRADE 3 EN1008

JSS01 SSS
5mm Unsprung Rose
JSS13 SSS
8mm sprung Rose

JSS202 SSS19mm
8mm Sprung Rose

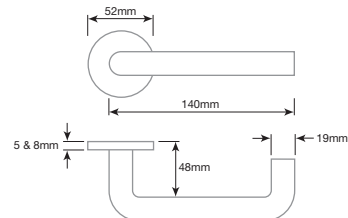

NEBULA

GRADE 304

GRADE 4 EN1008

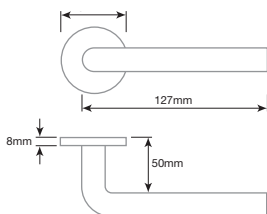

JSS480 SSS

JPS480 PSS

Tested to 200,000 cycles



JPS412 PSS

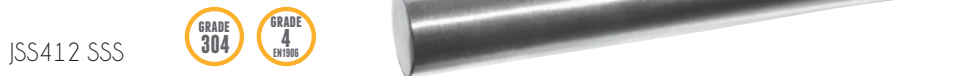

JSS412 SSS

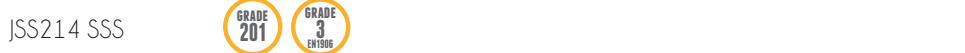

JSS214 SSS

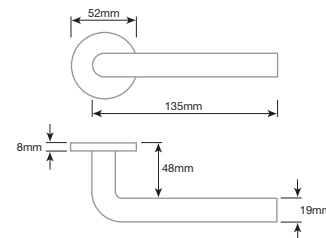

Tested to 200,000 cycles

ORBIT 22mm



JSS213 SSS



JPS213 PSS



JSS212 SSS

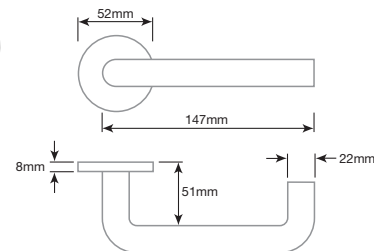

Tested to 200,000 cycles

ARCHED

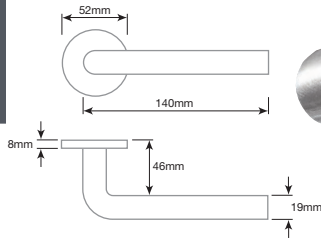

Tested to 200,000 cycles



JPS407 PSS **GRADE 304** **GRADE 4 EN1906**
JSS407 SSS **GRADE 304** **GRADE 4 EN1906**

JSS704 SSS **GRADE 201** **GRADE 3 EN1906**

METEOR

GRADE 304
GRADE 4 EN1906



Tested to 200,000 cycles

JSS360 SSS

JPS360 PSS

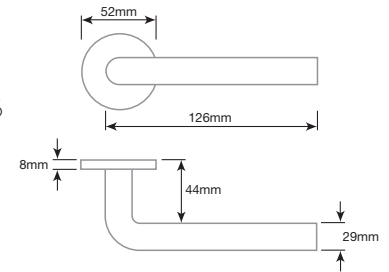

JUNO

GRADE 304 **GRADE 4 EN1906**

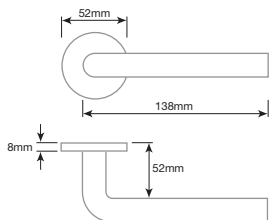

Tested to 200,000 cycles



JSS385 SSS

JPS385 PSS

SATURN

MITRED OVAL LEVER

GRADE 304

GRADE 4 EN1906

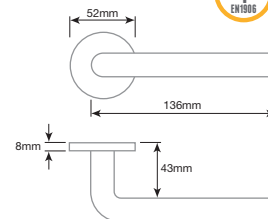

Tested to 200,000 cycles



JSSPS702 SSPS

NEPTUNE

MITRED LEVER

GRADE 4 EN1906 GRADE 304

GRADE 4 EN1906 GRADE 304

GRADE 3 EN1906 GRADE 201

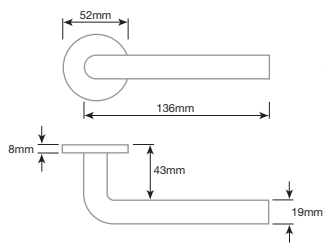

Tested to 200,000 cycles



JPS406 PSS

JSS406 SSS

JSS604 SSS

VECTA

GRADE 304

GRADE 4 EN1906

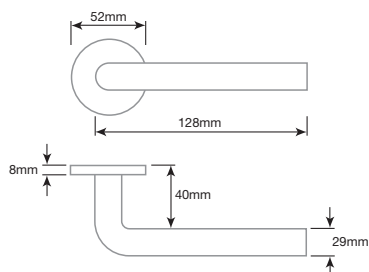

Tested to 200,000 cycles



JSS501 SSS

CARINA

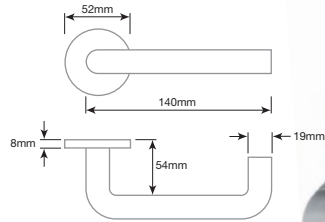

JPS405 PSS



JSS405 SSS



JSS408 SSS



Tested to 200,000 cycles

JULIAN

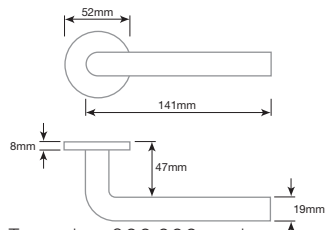

JPS402 PSS



JSS402 SSS



JSS204 SSS



Tested to 200,000 cycles

LUMA

GRADE 304

GRADE 4 EN1986

JEDGO collection

JSS380 SSS



JPS380 PSS

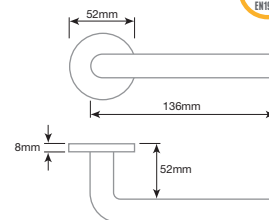

Tested to 200,000 cycles

LUMA

GRADE 304



Euro Lockset
JSS682 SSS



Bathroom
JSS683 SSS



Latch Set
JSS680 SSS



Lockset
JSS681 SSS

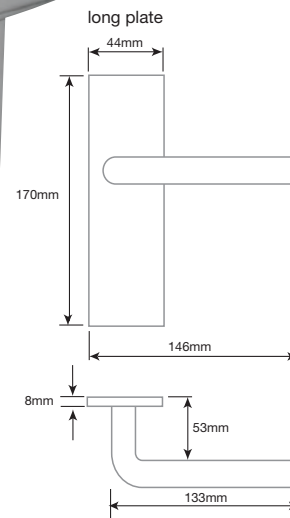



MATCHING ESCUTCHEONS

STANDARD ESCUTCHEON



JSS03 SSS
52mm x 5mm
JPS03 PSS
52mm x 5mm



JSS16 SSS
52mm x 8mm
JPS16 PSS
52mm x 8mm



JSS26 SSS
52mm x 8mm



EURO ESCUTCHEON



JSS02 SSS
52mm x 5mm
JPS02 PSS
52mm x 5mm



JSS18 SSS
52mm x 8mm
JPS18 PSS
52mm x 8mm



JSS28 SSS
52mm x 8mm



OVAL ESCUTCHEON



JSS04 SSS
52mm x 5mm
JPS04 PSS
52mm x 5mm



JSS17 SSS
52mm x 8mm
JPS17 PSS
52mm x 8mm



JSS27 SSS
52mm x 8mm



BLANK ESCUTCHEON



JSS9B SSS
52mm x 5mm
JPS9B PSS
52mm x 5mm



JSS14B SSS
52mm x 8mm
JPS14B PSS
52mm x 8mm

JSS24B SSS
52mm x 8mm



SQUARE STANDARD ESCUTCHEON

Size 52mm x 7mm



JSS10 SSS
JPS10 PSS



SQUARE EURO ESCUTCHEON

Size 52mm x 7mm



JSS11 SSS
JPS11 PSS



MATCHING TURNS AND RELEASES

NEW TURNS

STANDARD

GRADE 304

JSS05 SSS 52mm x 5mm with Indicator
 JPS05 PSS 52mm x 5mm with Indicator
 JSS55 SSS 52mm x 8mm with Indicator
 JPS55 PSS 52mm x 8mm with Indicator

JSS225 52mm x 8mm no Indicator
 JSS226 52mm x 8mm with Indicator



EASY TURN

GRADE 304

JSS354 SSS 52mm x 5mm with Indicator
 JPS354 PSS 52mm x 5mm with Indicator
 JSS355 SSS 52mm x 8mm with Indicator
 JPS355 PSS 52mm x 8mm with Indicator

GRADE 201

JSS255 52mm x 8mm with Indicator

GRADE 201



COVER ONLY TO SUIT RELEASE NO INDICATOR

GRADE 304



JSS60B SSS 52mm x 5mm to suit JSS505 & JSS354
 JPS60B PSS 52mm x 5mm to suit JPS505 & JPS354
 JSS61B SSS 52mm x 8mm to suit JSS55 & JSS355
 JPS61B PSS 52mm x 8mm to suit JPS55 & JPS355

SQUARE TURN & RELEASE

GRADE 304



JSS54 SSS 52mm x 7mm
 JPS54 PSS 52mm x 7mm

SQUARE EASY TURN & RELEASE

GRADE 304



JSS356 SSS 52mm x 7mm
 JPS356 PSS 52mm x 7mm

D SHAPED PULL HANDLES

INCLUDING FIXINGS TO SUIT WOODEN AND GLASS DOORS

GRADE
304

GRADE
304

JEDGO
collection

BOLT THROUGH FIXING SSS FINISH

JSS119A - 150mm x 19mm
JSS119B - 225mm x 19mm
JSS119C - 300mm x 19mm
JSS119D - 425mm x 19mm
JSS119E - 600mm x 19mm

JSS122A - 225mm x 22mm
JSS122B - 300mm x 22mm
JSS122C - 425mm x 22mm
JSS122D - 600mm x 22mm

BOLT THROUGH FIXING PSS FINISH

JPS119A - 150mm x 19mm
JPS119B - 225mm x 19mm
JPS119C - 300mm x 19mm
JPS119D - 425mm x 19mm
JPS119E - 600mm x 19mm

JPS122A - 225mm x 22mm
JPS122B - 300mm x 22mm
JPS122C - 425mm x 22mm
JPS122D - 600mm x 22mm

BACK TO BACK FIXING SSS FINISH

JSS120A - 150mm x 19mm
JSS120B - 225mm x 19mm
JSS120C - 300mm x 19mm
JSS120D - 425mm x 19mm
JSS120E - 600mm x 19mm

JSS123A - 225mm x 22mm
JSS123B - 300mm x 22mm
JSS123C - 425mm x 22mm
JSS123D - 600mm x 22mm

BACK TO BACK FIXING PSS FINISH

JPS120A - 150mm x 19mm
JPS120B - 225mm x 19mm
JPS120C - 300mm x 19mm
JPS120D - 425mm x 19mm
JPS120E - 600mm x 19mm

JPS123A - 225mm x 22mm
JPS123B - 300mm x 22mm
JPS123C - 425mm x 22mm
JPS123D - 600mm x 22mm



GUARDSMAN PULL HANDLES

INCLUDING FIXINGS TO SUIT WOODEN AND GLASS DOORS



BOLT THROUGH FIXING SSS FINISH

JSS219A - 325mm x 19mm (225mm Centres)
 JSS219B - 400mm x 19mm (300mm Centres)
 JSS219C - 1000mm x 19mm (900mm Centres)

JSS222A - 400mm x 25mm (300mm Centres)
 JSS222B - 600mm x 25mm (450mm Centres)
 JSS222C - 750mm x 25mm (650mm Centres)
 JSS222D - 1000mm x 25mm (900mm Centres)

BOLT THROUGH FIXING PSS FINISH

JPS219A - 325mm x 19mm (225mm Centres)
 JPS219B - 400mm x 19mm (300mm Centres)
 JPS219C - 1000mm x 19mm (900mm Centres)

JPS222A - 400mm x 25mm (300mm Centres)
 JPS222B - 600mm x 25mm (450mm Centres)
 JPS222C - 750mm x 25mm (650mm Centres)
 JPS222D - 1000mm x 25mm (900mm Centres)



BACK TO BACK FIXING SSS FINISH

JSS220A - 325mm x 19mm (225mm Centres)
 JSS220B - 400mm x 19mm (300mm Centres)
 JSS220C - 1000mm x 19mm (900mm Centres)

JSS223A - 400mm x 25mm (300mm Centres)
 JSS223B - 600mm x 25mm (450mm Centres)
 JSS223C - 750mm x 25mm (650mm Centres)
 JSS223D - 1000mm x 25mm (900mm Centres)

JSS521A - 600mm x 32mm (400mm Centres)
 JSS521B - 800mm x 32mm (600mm Centres)
 JSS521C - 1200mm x 32mm (1000mm Centres)
 JSS521D - 1800mm x 32mm (1600mm Centres)

BACK TO BACK FIXING PSS FINISH

JPS220A - 325mm x 19mm (225mm Centres)
 JPS220B - 400mm x 19mm (300mm Centres)
 JPS220C - 1000mm x 19mm (900mm Centres)

JPS223A - 400mm x 25mm (300mm Centres)
 JPS223B - 600mm x 25mm (450mm Centres)
 JPS223C - 750mm x 25mm (650mm Centres)
 JPS223D - 1000mm x 25mm (900mm Centres)

CONCEALED ROSES

GRADE 304 SS



50mm x 5mm SSS Finish

JSS19 - 16mm DIAMETER TO SUIT JSS219 & JSS220
 JSS22 - 19mm DIAMETER TO SUIT JSS119 & JSS120
 JSS25 - 22mm DIAMETER TO SUIT JSS122 & JSS222, JSS123 & JSS223

50mm x 5mm PSS Finish

JPS19 - 16mm DIAMETER TO SUIT JPS219 & JPS220
 JPS22 - 19mm DIAMETER TO SUIT JPS119 & JPS120
 JPS25 - 22mm DIAMETER TO SUIT JPS122 & JPS222, JPS123 & JPS223

D SHAPE PULL HANDLES B/T FIXING

GRADE
201

JSS319A 150 x 19mm
 JSS319B 225 x 19mm
 JSS319C 300 x 19mm
 JSS319D 425 x 19mm
 JSS319E 600 x 19mm



JSS320A 150 x 19mm
 JSS320B 225 x 19mm
 JSS320C 300 x 19mm
 JSS320D 425 x 19mm
 JSS320E 600 x 19mm

JSS619B 225 x 22mm
 JSS619C 300 x 22mm
 JSS619D 425 x 22mm
 JSS619E 600 x 22mm

JSS620B 150 x 22mm
 JSS620C 225 x 22mm
 JSS620D 300 x 22mm
 JSS620E 425 x 22mm



MITRED PULL HANDLES

GRADE
304



JSS419A SSS 300mm x 19mm
 JSS419B SSS 450mm x 22mm
 JSS419C SSS 600mm x 22mm

SANDRINE PULL HANDLES

GRADE
304



JSS585 - SSS 225mm Centres
 JSS586 - SSS 300mm Centres

JPS585 - PSS 225mm Centres
 JPS586 - PSS 300mm Centres



CRANKED PULL HANDLE

GRADE
304

JEDGO
collection

JSS519A - 600mm x 32mm x 25mm - 2 supports centres 400mm
JSS519B - 1200mm x 32mm x 25mm - 2 supports centres 1000mm
JSS519C - 1800mm x 32mm x 25mm - 3 supports centres 800mm

TO FIT DOORS UP TO 70MM THICKNESS COMPLETE WITH BOLT THROUGH AND BACK TO BACK FIXINGS FOR WOODEN OR GLASS DOORS.

n.b For back to back fitting bolts will need to be cut to size



pictured on page 76

PULL HANDLES ON PLATE

GRADE
304



JSS1601 - 225mm x 19mm Plate 305 x 75mm
JSS1602 - 300mm x 19mm Plate 350 x 75mm

JPS1601 - 225mm x 19mm Plate 305 x 75mm
JPS1602 - 300mm x 19mm Plate 350 x 75mm

FINGER PLATES RADIUS CORNER

GRADE
304



JSS80 - SSS 305mm x 75mm
JPS80 - PSS 305mm x 75mm

JSS81 - SSS 350mm x 75mm
JPS81 - PSS 350mm x 75mm

T BAR CABINET HANDLES 12mm DIAMETER



SSS FINISH

- JSS110A-156mm x 96mm Centres
- JSS110B-188mm x 128mm Centres
- JSS110C-220mm x 160mm Centres
- JSS110D-244mm x 184mm Centres
- JSS110E-294mm x 234mm Centres
- JSS112A-344mm x 284mm Centres
- JSS112B-394mm x 334mm Centres
- JSS112C-444mm x 384mm Centres
- JSS112D-494mm x 434mm Centres
- JSS112E-544mm x 484mm Centres
- JSS114A-580mm x 520mm Centres
- JSS114B-655mm x 595mm Centres
- JSS114C-706mm x 646mm Centres
- JSS114D-835mm x 775mm Centres
- JSS114E-920mm x 860mm Centres



PSS FINISH

- JPS110A-156mm x 96mm Centres
- JPS110B-188mm x 128mm Centres
- JPS110C-220mm x 160mm Centres
- JPS110D-244mm x 184mm Centres
- JPS110E-294mm x 234mm Centres
- JPS112A-344mm x 284mm Centres
- JPS112B-394mm x 334mm Centres
- JPS112C-444mm x 384mm Centres
- JPS112D-494mm x 434mm Centres
- JPS112E-544mm x 484mm Centres
- JPS114A-580mm x 520mm Centres
- JPS114B-655mm x 595mm Centres
- JPS114C-706mm x 646mm Centres
- JPS114D-835mm x 775mm Centres
- JPS114E-920mm x 860mm Centres



FLOOR MOUNTED DOOR STOPS

GRADE
304

CYLINDER DOOR STOP

30mm Diameter X 40mm High



JSS06 SSS
JPS06 PSS

OVAL DOOR STOP

50mm Diameter X 30mm High



JSS08 SSS
JPS08 PSS

DOME TOP DOOR STOP

30mm Diameter X 45mm High



JSS09 SSS
JPS09 PSS

WALL MOUNTED DOOR STOPS

GRADE
304

CYLINDER PROJECTING DOOR STOP

80mm Projection x 20mm Diameter
Rose 48mm



JSS07 SSS
JPS07 PSS

BUFFERED ROBE HOOK

Projection 78mm
Diameter 16mm
Rose 25mm



JSS669 SSS

CYLINDER PROJECTING DOOR STOP

75mm Projection x 16mm Diameter
Rose 25mm



JSS700 SSS
JPS700 PSS

EXTERIOR DOOR FURNITURE

GRADE
304

LETTERPLATE

JSS3009 SSS
330mm x 100mm
aperture 250mm x 50mm
Fixing centres 300mm



nb. We do not recommend pre cutting of doors as sizes are approximate and may differ to those shown.

CENTRE DOOR KNOB

GRADE
304

JSS3580 SSS
Diameter 70mm
Projection 72mm
Rose 86mm



DOOR KNOCKER

GRADE
304

JSS3003 SSS
Rose 38mm
Length 150mm



DOOR VIEWER

GRADE
304

JSS940 SSS

Door Viewer with Cover
Fits doors 35mm to 60mm thickness
Diameter 14mm
160-180 degree viewing angle with fire
protection internal glass lens



EXTERIOR DOOR FURNITURE

CYLINDER PULLS



ROUND CYLINDER

JSS40 SSS



EURO PROFILE

JSS40E SSS



STANDARD KEYWAY

JSS40STD SSS



OVAL PROFILE

JSS40U SSS

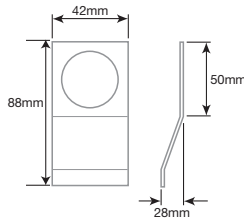

NUMERALS



100MM

SSS FINISH



JSS-0
JSS-1
JSS-2
JSS-3
JSS-4
JSS-5
JSS-6&9
JSS-7
JSS-8

150MM

SSS FINISH



JNSS-0
JNSS-1
JNSS-2
JNSS-3
JNSS-4
JNSS-5
JNSS-6&9
JNSS-7
JNSS-8



HOOKS GRADE 304

HAT & COAT HOOK 

Projection 60mm
Height 115mm



JSS662 SSS

HAT & COAT HOOK 

Projection 82mm
Height 130mm
Rose 30mm



JSS663 SSS

BUFFERED HAT & COAT HOOK 

Projection 82mm



JSS15 SSS

ROBE HOOK 

Projection 64mm
Rose 30mm



JSS664 SSS

ROBE HOOK 

Projection 35mm
Rose 25mm



JSS665 SSS

ROBE HOOK 

Projection 50mm
Rose 30mm

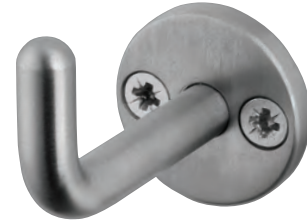

JSS666 SSS

COAT HOOK

Projection 84mm



JSS668A - 35 x 20mm
JSS668B - 45 x 20mm

MULTI HOOK UNIT

Projection 84mm



JSS800 SSS - 3 Hook unit
Plate Size 40mm high x 250mm width

JSS801 SSS - 5 Hook unit
Plate Size 40mm high x 450mm width

SINGLE ROBE HOOK

Projection 29mm
Plate 48mm x 48mm



JSS901A SSS
JPS901A PSS

SINGLE ROBE HOOK

Projection 29mm
Plate 45mm Diameter



JSS902A SSS
JPS902A PSS

HAT & COAT HOOK

Projection 57mm
Plate 94mm x 46mm



JSS901B SSS
JPS901B PSS

HAT & COAT HOOK

Projection 57mm
Plate 90mm x 45mm

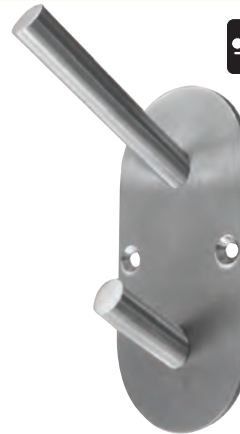

JSS902B SSS
JPS902B PSS

DOUBLE ROBE HOOK

Projection 29mm
Plate 94mm x 46mm



JSS901C SSS
JPS901C PSS

DOUBLE ROBE HOOK

Projection 29mm
Plate 90mm x 45mm

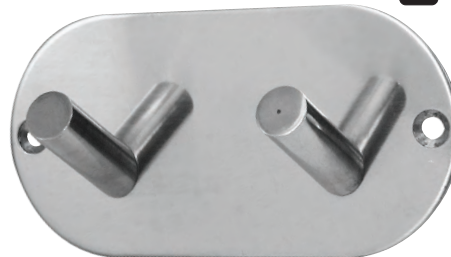

JSS902C SSS
JPS902C PSS

WINDOW FURNITURE



CASEMENT STAY ROUND BAR



JSS1237 SSS
260mm x 13mm Diameter 'bar

Accessories
JSS1237PINS TO SUIT JSS1237

ESPAGNOLETTE WINDOW FASTENER ROUND BAR



JSS1235LH SSS
JSS1235RH SSS

Projection 33mm
Plate 65 x 20mm

120mm handle
7mm x 35mm Spindle
Fixing centres 43mm
(right hand pictured)

CASEMENT FASTENER ROUND BAR WITH MORTICE PLATE



JSS1234LH SSS
JSS1234RH SSS

Projection 36mm
Plate 56 x 18mm

120mm handle
(right hand pictured)

Accessories
JSS1234HP - Hook Plate To Suit JSS1234
JSS1234MP - Mortice Plate to Suit JSS1234

STAINLESS STEEL SQUARE & RADIUS FLUSH BOLTS

GRADE
304

SUCCESSFULLY TESTED TO BS-EN12051-1999
Test Cycles 10,000, Corrosion 240 hours, EN1634-1

JSS50 150x20mm
JPS50 150x20mm
JSS51 200x20mm
JPS51 200x20mm
JSS52 300x20mm
JPS52 300x20mm
JSS53 457x20mm
JSS56 609x20mm
JSS57 914x20mm



JSS51R 200x20mm
JPS51R 200x20mm
JSS52R 300x20mm
JPS52R 300x20mm
JSS53R 457x20mm
JSS56R 609x20mm



DUST SOCKETS



FOR CONCRETE

JSS5642



FOR WOODEN FLOORS

JSS5643

FLUSH PULL

GRADE
304



JSS429B SSS - 130mm x 50mm
JPS429B PSS - 130mm x 50mm
Depth 11mm



JSS428B SSS - 100mm x 50mm
JPS428B PSS- 100mm x 50mm
Depth 11mm

TOILET ROLL HOLDER

GRADE
304



JSS102 SSS
Width 136mm
Depth 78mm

HANDRAIL BRACKETS

GRADE
304



JSS85H SSS

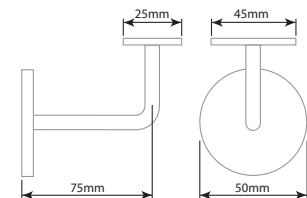

PULL HANDLES

With classic and modern styling these pull handles add a touch of style to any situation



AVANTIME PULL HANDLE ON ROSE

JV791PCSC
Length 275mm
Centres 225mm
Projection 60mm

JV792PCSC
Length 350mm
Centres 300mm
Projection 60mm

(Not recommended for external use)



REGENT



JV3700PB
JV3700PC
JV3700SC

Length 460mm
Centres 300mm
Diameter 20mm
Rose 60mm

BOW SHAPE PULL HANDLE

JV96PC
152mm



JV96APB
152mm



JV96BPB
175mm

PULL HANDLE



JV90APB
152mm

JV90BPB
200mm

JV90CPB
250mm

JV90DPB
305mm



LUNAR HANDLE ON ROSE

JV815PCSC
Length 315mm
Centres 202mm
Projection 66mm

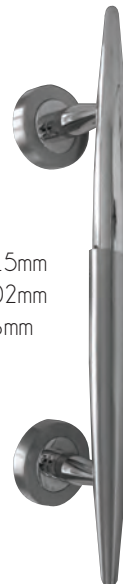

KUBUS PULL HANDLES

Length 340mm
Centres 300mm
Projection 47mm

Can be used as back to back handle

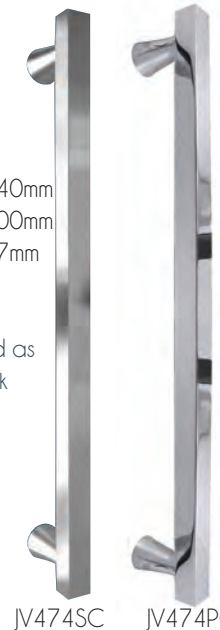

JV474SC

JV474PC

PULL HANDLES

PULL HANDLE ON ROSE



JV515
Length 225mm
Centres 174mm
Projection 62mm

JV516
Length 305mm
Centres 250mm
Projection 62mm

JV515PC
JV516PC



JV515SC
JV516SC



JV515PB
JV516PB

PULL HANDLE ON ROSE



JV3500APB
225mm x 19mm

JV3500BPB
305mm x 19mm

Can also be fixed as a bolt through handle without Rose

PULL HANDLE ON PLATE



JV124PB
Handle 185mm
Plate 300mm x 58mm

CHATSWORTH



JV3694PB
JV3694PC
JV3694SC
Handle 320mm
Plate 380mm x 63mm

JV3695PB
JV3695PC
JV3695SC
Handle 390mm
Plate 460mm x 75mm

BLenheim



JV3696PB
JV3696PC
JV3696SC
Handle 275mm
Plate 380mm x 63mm

JV3697PB
JV3697PC
JV3697SC
Handle 310mm
Plate 460mm x 75mm

SIGNS

PUSH & FINGERPLATES

Our range of signage and finger and kickplates are available in a variety of finishes .

PLAIN FINGERPLATE



305 x 75mm

JV58PB
JPS80 PSS
JSS80 SSS
J1409 SAA

350 x 75mm

JV78PB
JPS81 PSS
JSS81 SSS
J1410 SAA

ENGRAVED FINGERPLATE “PUSH”

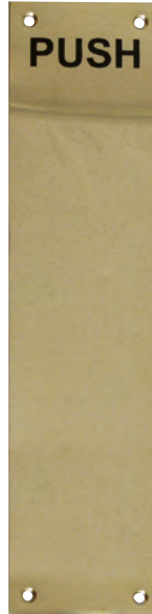

305 x 75mm

JV998PB
J1998A SAA

ENGRAVED FINGERPLATE “PULL”



305 x 75mm

JV999PB
J1998B SAA

RAISED PLAIN FINGERPLATE



305 x 75mm

JV39PB
JV39PC
JV39SC

FLAT SHAPED FINGERPLATE

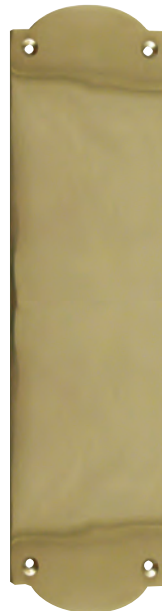

305 x 75mm

JV54PB

RAISED SHAPED FINGERPLATE



305 x 75mm

JV54RPB

FINGERPLATES

REEDED FINGERPLATE



305 x 75mm

JR5PB
JR5PC
JR5SC

FINGERPLATE MATCHING BLENHEIM/CHATSWORTH



380 x 63mm

JV3698PB
JV3698PC
JV3698SC

460 x 75mm

JV3699PB
JV3699PC
JV3699SC

GEORGIAN FINGERPLATE



305 x 75mm

JG10PB

KICK PLATES

available to order cut to size as required, in a variety of finishes.
Please ask for details and prices.

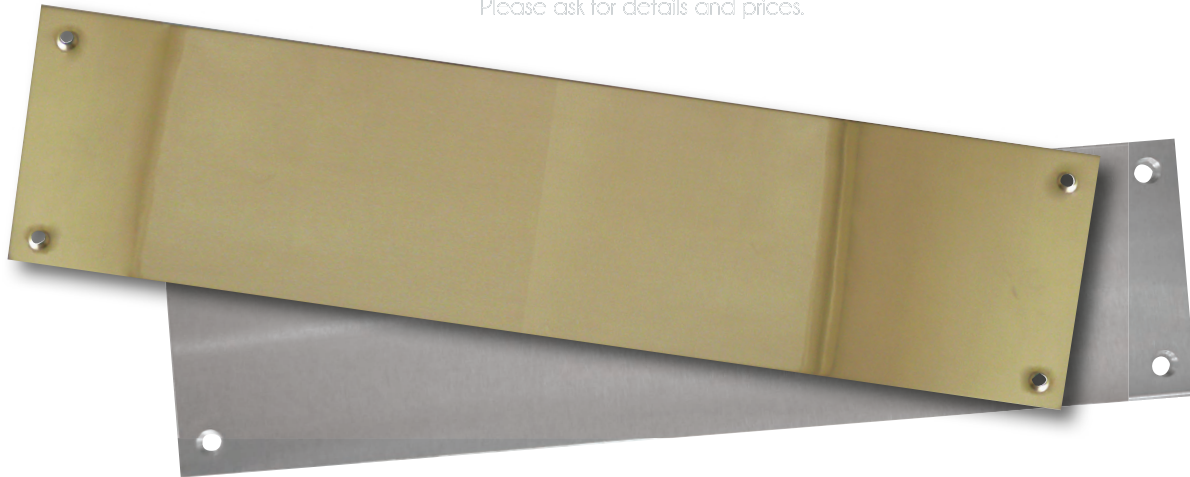

SIGNAGE 75MM DIAMETER PICTOGRAM DISCS

FIRE DOOR KEEP SHUT



JS100PB
JS100PSS
JS100SAA
JS100SSS

FIRE DOOR KEEP LOCKED



JS101PB
JS101PSS
JS101SAA
JS101SSS

MALE PICTOGRAM



JS102PB
JS102PSS
JS102SAA
JS102SSS

FEMALE PICTOGRAM



JS103PB
JS103PSS
JS103SAA
JS103SSS

DIASABILITY PICTOGRAM



JS104PB
JS104PSS
JS104SAA
JS104SSS

UNISEX PICTOGRAM



JS105PB
JS105PSS
JS105SAA
JS105SSS

SHOWER PICTOGRAM



JS106PB
JS106PSS
JS106SAA
JS106SSS

BABY CHANGE PICTOGRAM



JS107PB
JS107PSS
JS107SAA
JS107SSS

FIRE DOOR KEEP CLEAR



JS108PB
JS108PSS
JS108SAA
JS108SSS

FIRE DOOR KEEP LOCKED SHUT



JS109PB
JS109PSS
JS109SAA
JS109SSS

AUTOMATIC FIRE DOOR KEEP CLEAR



JS110PB
JS110PSS
JS110SAA
JS110SSS

AUTOMATIC DOOR CLOSER KEEP CLEAR



JS111PB
JS111PSS
JS111SAA
JS111SSS



BLACK ANTIQUE

Classical designs of furniture manufactured from malleable iron create an authentic feel of days gone by.

Bathroom
JAB300B



Latch
JAB301



Lockset
JAB300

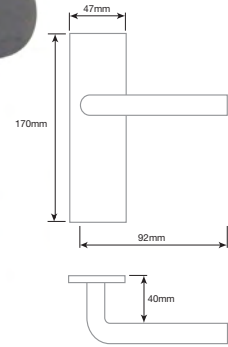

FLEUR DE LYS

Latchset
JAB84



Bathroom
JAB83B



Lockset
JAB83

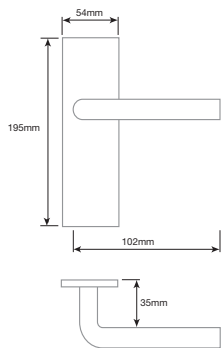

REGAL

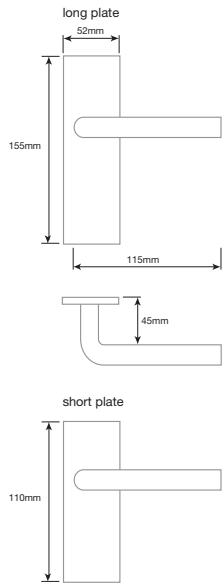

JAB1
Lock furniture
Long
plate

JAB2
Latch furniture
short plate



JAB1B
bathroom furniture
Long plate



JAB2L
Latch furniture
Long plate

ROYAL

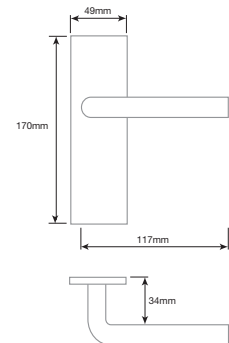



WENTWORTH

JEDGO
collection

Lockset
JAB500



Bathroom
JAB500B



Latchset
JAB501

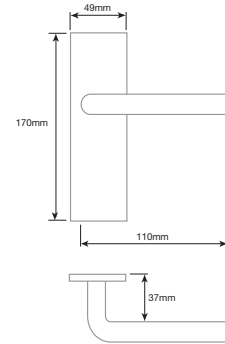

WALL MOUNTED STOP



JAB9551
Length 90mm
Rose 38mm

FLOOR MOUNTED STOP



JAB186
Diameter 44mm
Height 26mm

LION HEAD KNOCKER

Height 165mm
Width 100mm



JAB8

RING KNOCKER

Diameter 95mm



JAB7

RECTANGULAR BELL PUSH

Height 76mm
Width 25mm



JAB118

CENTRE DOOR KNOB

Diameter 70mm
Projection 63mm
Rose 73mm

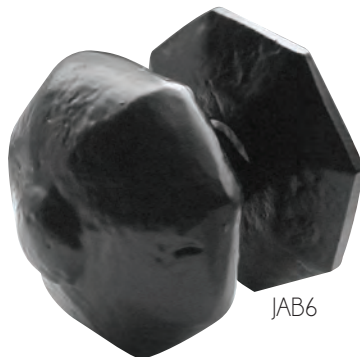

JAB6

DOOR STUDS

Diameter 25mm x 25mm



JAB29

NUMERALS 100MM



JAB15 - 0
JAB15 - 1
JAB15 - 2
JAB15 - 3
JAB15 - 4
JAB15 - 5
JAB15 - 6&9
JAB15 - 7
JAB15 - 8

CYLINDER COVER

Height 78mm
Width 65mm



JAB10

FLEUR DE LYS CYLINDER COVER

Height 120mm
Width 55mm



JAB9

LETTERPLATE



JAB12
270mm x 115mm
aperture 190mm x 43mm
Fixing centres 230mm

JAB12A
260mm x 80mm
aperture 190mm x 40mm
Fixing centres 220mm

POSTAL KNOCKER

JAB46
310mm x 105mm
aperture 200mm x 45mm
fixing centres 258mm



FLEUR DE LYS LETTERPLATE

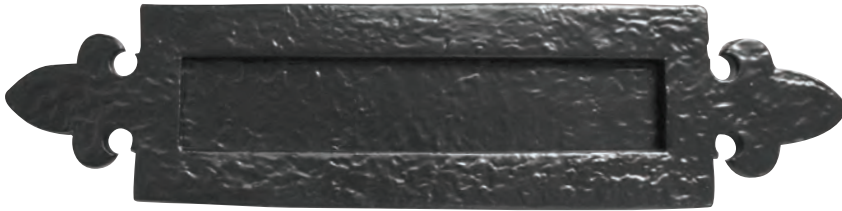

JAB13
350mm x 85mm
aperture 200mm x 37mm
fixing centres 260mm

INNER TIDY

JAB112
308 x 85mm



We do not recommend pre cutting of doors as sizes are approximate and may differ from those shown

BALL SHAPE MORTICE KNOB

Diameter 50mm
Projection 75mm
Rose 66mm

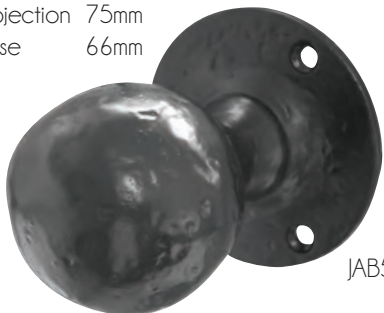

JAB5

OVAL MORTICE KNOB

Diameter 68mm
Projection 62mm
Rose 62mm

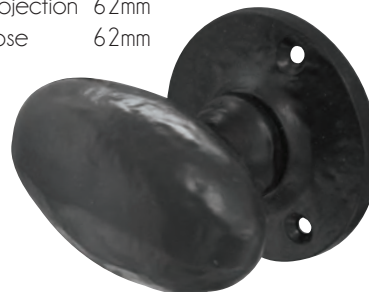

JAB48

BALL SHAPE RIM KNOB

Diameter 46mm
Projection 75mm
Rose 60mm

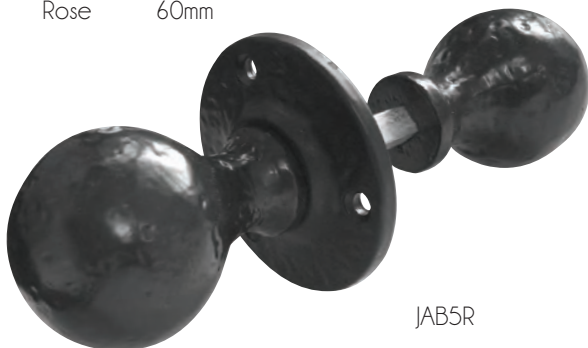

JAB5R

OVAL SHAPE RIM KNOB

Diameter 68mm
Projection 62mm
Rose 62mm



JAB48R

ROUND CUPBOARD KNOB



JAB85
Diameter 25mm
Projection 32mm
Rose 32mm

JAB86
Diameter 32mm
Projection 38mm
Rose 36mm

JAB87
Diameter 38mm
Projection 45mm
Rose 43mm

OVAL CUPBOARD KNOB



JAB45
Diameter 40mm x 30mm
Projection 39mm
Rose 41mm



**CASEMENT FASTENER
HOOK & MORTICE PLATE**



JAB19M
Handle 86mm
Projection 34mm

**LOCKING CASEMENT FASTENER
HOOK & MORTICE PLATE**



JAB19L
Handle 100mm
Projection 34mm

JAB19R
Handle 100mm
Projection 34mm

Right hand pictured

CASEMENT FASTENER HOOK & MORTICE PLATE



JAB36M
Handle 94mm
Projection 41mm

CASEMENT STAY

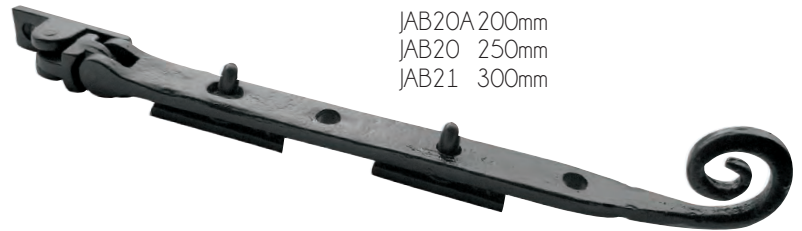

JAB20A 200mm
JAB20 250mm
JAB21 300mm

CASEMENT STAY

JAB33 200mm
JAB34 250mm
JAB35 300mm



SCREWDOWN STAY

JAB62A 250mm
JAB62B 300mm



BUTT HINGES



JAB103 75mm x 50mm
JAB104 100mm x 68mm



JAB59 152mm
JAB60 225mm



JAB37A 225mm
JAB37B 305mm



JAB660 300mm



JAB90 400mm



JAB38 430mm

LOCKS & LATCHES

REVERSIBLE RIM LOCK

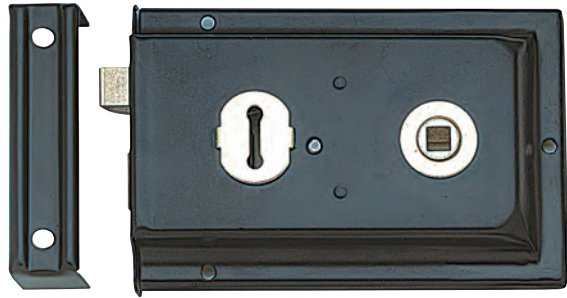

JL189BL

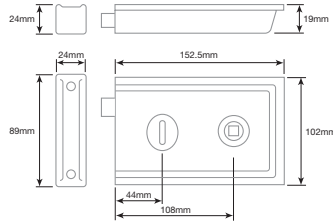
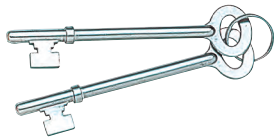

3 LEVER SASHLOCK

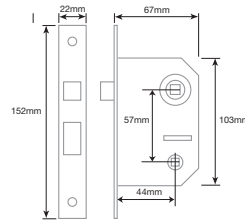

JL174BL

BATHROOM LOCK

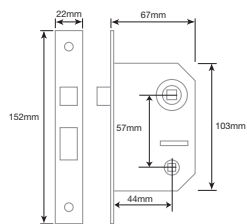

JL154BL

TUBULAR LATCH

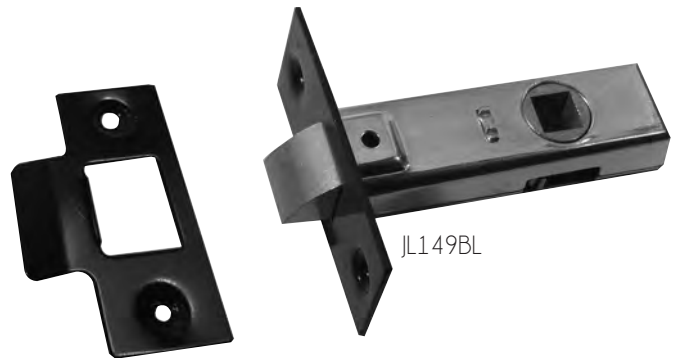

JL149BL

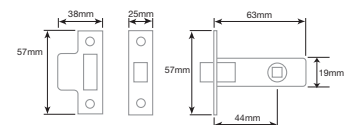

STRAIGHT BOLT 



JAB25 100mm

NECKED BOLT 



JAB24 100mm

STRAIGHT BOLT



JAB39 125mm

NECKED BOLT



JAB41 125mm

STRAIGHT BOLT



JAB40 200mm

NECKED BOLT



JAB42 200mm

INDICATOR BOLT

Diameter 70mm



JAB80

BATHROOM TURN & RELEASE

For use with deadbolts
5mm Spindle

Diameter 32mm
Projection 33mm
Rose 36mm



JAB82

FLEUR DE LYS PULL HANDLE



JAB26 100mm
JAB27 125mm
JAB28 170mm

FLEUR DE LYS PULL HANDLE



JAB52 230mm

PULL HANDLE



JAB66 200mm

FINGERPLATE

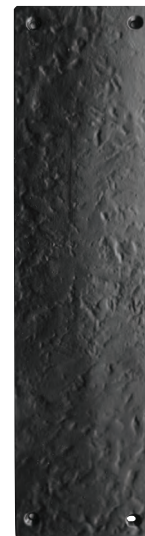

JAB56 300mm x 76mm

GATE CATCHES

THUMB LATCH



JAB30 140mm

THUMB LATCH



JAB18 203mm

COVERED ESCUTCHEON



JAB53
56mm

RECTANGULAR ESCUTCHEON



JAB70
50mm x 32mm

OVAL ESCUTCHEON



JAB75
50mm

HAT & COAT HOOK



JAB77
Height 125mm
Projection 70mm
Plate 53mm x 35mm

ROBE HOOK



JAB78
Height 55mm
Projection 40mm

DOUBLE ROBE HOOK



JAB79
Height 55mm
Projection 40mm

CABIN HOOK



JAB49
102mm

JAB50
152mm

HANDRAIL BRACKET



JAB91
70mm

PEWTER FURNITURE

Introducing a range of Pewter finished furniture
in either antique or hand forged designs

PEWTER ANTIQUE



WENTWORTH

Lockset
PEW500



Latchset
PEW501



Bathroom
PEW500B

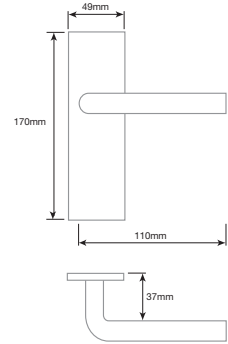

TURNBERRY

Bathroom
PEW300B



Latchset
PEW301



Lockset
PEW300

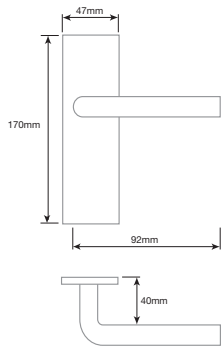

PEWTER ANTIQUE

ROYAL

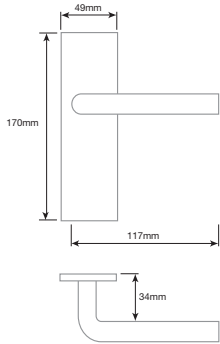

bathroom
PEW400B



Latchset
PEW401

Lockset
PEW400

BALL SHAPE MORTICE KNOB



Diameter 50mm
Projection 75mm
Rose 66mm



PEW5

BALL SHAPE RIM KNOB

Diameter 46mm
Projection 75mm
Rose 60mm



PEW5R

RING KNOCKER

Diameter 100mm
Rose 46mm



PEW7

CENTRE DOOR KNOB

Diameter 65mm
Projection 63mm
Rose 68mm

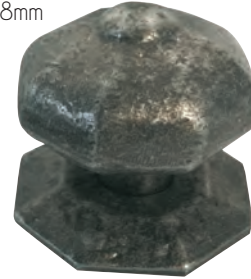

PEW6

FLEUR DE LYS CYLINDER COVER

Height 120mm
Width 55mm



PEW 9

BELL PUSH

Height 76mm
Width 25mm



PEW118

LETTERPLATE



PEW12
270mm x 115mm
aperture 197mm x 43mm
fixing centres 232mm

PEW12A
260mm x 80mm
aperture 190mm x 43mm
fixing centres 220mm

We do not recommend pre cutting of doors as sizes are approximate and may differ from those shown

PEWTER ANTIQUE

PULL HANDLE

PEW26 100mm
PEW27 125mm
PEW28 170mm



HAT & COAT HOOK

PEW77
Height 125mm
Projection 70mm
Plate 53 x 35mm



DOUBLE ROBE HOOK

PEW79
Height 55mm
Projection 40mm



CASEMENT STAY



PEW20 250mm
PEW21 300mm

CASEMENT FASTENER HOOK & MORTICE PLATE



PEW19M
Handle 86mm
Projection 34mm

COVERED ESCUTCHEON



PEW42
35mm

RETANGULAR ESCUTCHEON



PEW70
Height 50mm
Width 32mm

ROUND ESCUTCHEON



PEW41
Diameter 38mm

FLOOR MOUNTED STOP



PEW186
Diameter 44mm
Height 26mm

WALL MOUNTED STOP



PEW9551
Length 90mm
Rose 38mm

HANDFORGED PEWTER FURNITURE

BELFRY

Latchset
HF101



Lockset
HF100



Bathroom
HF100B

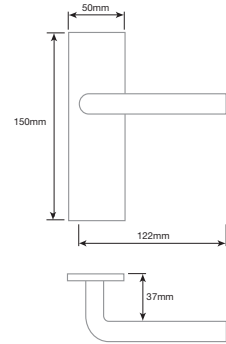
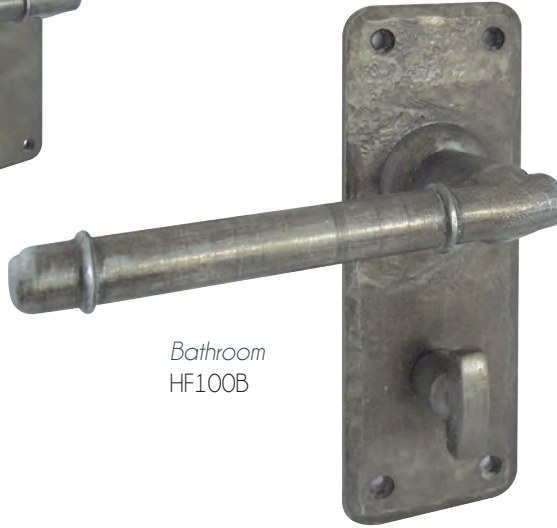

CHESTER

Latchset
HF201



Bathroom
HF200B



Lockset
HF200

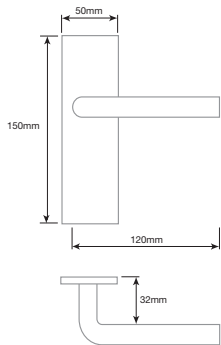

HANDFORGED PEWTER FURNITURE

CASEMENT STAY



HF20
200mm

HF21
250mm

HF22
300mm

CASEMENT FASTENER



HF19M
Height 105mm
Projection 33mm

CABINET HANDLE

HF66 125mm
HF67 170mm



HAT & COAT HOOK

HF16
Height 134mm
Projection 47mm



PULL HANDLE

HF58
Height 265mm



HANDFORGED PEWTER FURNITURE

GATE LATCH LH pictured



HF48-LH
HF48-RH
Plate 150 x 102mm

THUMB LATCH

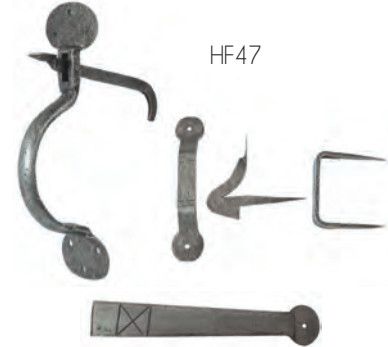

HF47

HINGES



HF26 305mm
HF28 375mm

CABINET LATCH



HF50
Diameter 72mm

STRAIGHT BOLT



HF25 100mm

NECKED BOLT



HF24 100mm

ALUMINIUM

DOOR FURNITURE

From commercial round bar furniture to budget range furniture and accessories we have aluminium furniture to suit most applications.



19MM ROUND BAR LEVER ON ROSE SATIN FINISH

2 PIECE SCREW ON ROSE

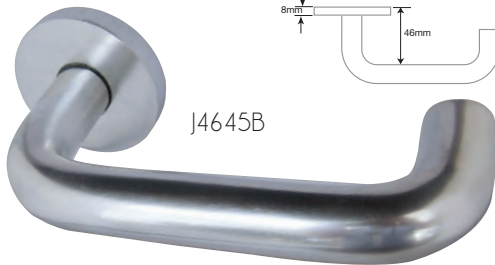
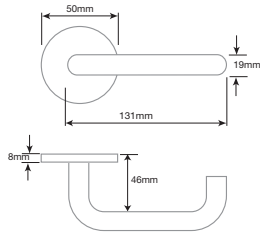

J4645B

LEVER ON ROSE FURNITURE

52 x 8mm SCREW ON ROSE & HESO SPINDLE

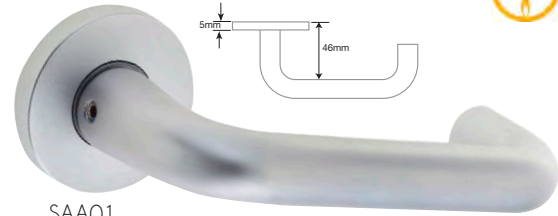
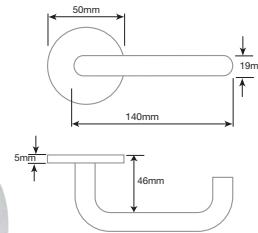

SAA01



MATCHING ESCUTCHEONS



STANDARD ESCUTCHEON

J4646B 50mm x 8mm

EURO ESCUTCHEON

J4648B 50mm x 8mm

OVAL ESCUTCHEON

J4647B 50mm x 8mm



STANDARD ESCUTCHEON

SAA10 SAA 50mm x 5mm

EURO ESCUTCHEON

SAA11 SAA 50mm x 5mm

OVAL ESCUTCHEON

SAA12 SAA 50mm x 5mm

MATCHING BATHROOM TURNS AND RELEASES

TURN & RELEASE

50mm x 8mm



J4676B

EASY TURN & RELEASE

50mm x 8mm

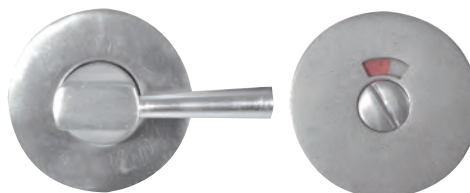

WITH INDICATOR J4649B
WITHOUT INDICATOR J4649B

TURN & RELEASE

50mm x 5mm



SAA20 SAA with Indicator
SAA22 without Indicator
SAA21 Easy Turn & Release

19MM ROUND BAR LEVER ON PLATE SATIN FINISH

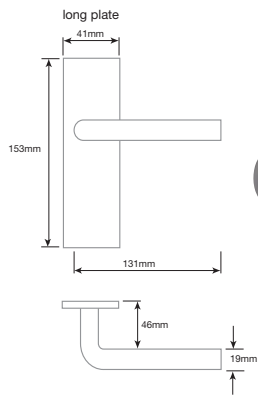

CONTRACT

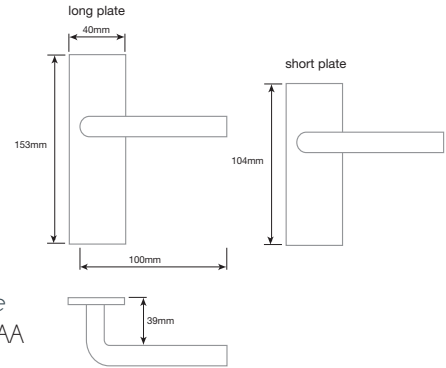

LASER SAA RANGE



*Euro Profile
J2100E SAA
Oval Profile
J2100U SAA*



PULL HANDLES



BOLT THROUGH FIXING

J1049
152mm x 19mm

J1050
225mm x 19mm

J1051
305mm x 19mm



PULL HANDLES- BOLT THROUGH FIXING

SAA150
150x19mm

SAA151
225x19mm

SAA152
305x19mm

SAA153
425x19mm

SAA154
600x19mm



SAA160
SAA Rose kit for pull handles

ROSE FIXING

J1056
152mm x 19mm

J1055
225mm x 19mm

J1057
305mm x 19mm

J1058
400mm x 19mm

J1059
600mm x 19mm



Can also be fixed as a bolt through handle

PULL HANDLE ON PLATE



J3572A
225mm

J3572B
305mm



J1903A
150mm

J1903B
180mm



J1601
Handle 225mm x 19mm
Plate 300mm x 75mm

J1602
Handle 305mm x 19mm
Plate 375mm x 75mm

EXTERIOR DOOR FURNITURE

GRAVITY FLAP LETTERPLATE



J1403

size 252mm x 76mm

aperture 200mm x 43mm

Fixing centres 242mm

FACE FIX LETTERPLATE

J1400

size 252mm x 78mm

aperture 200mm x 43mm

Fixing centres 237mm



INNER TIDY



J1405

size 260mm x 70mm

aperture 200mm x 43mm

Fixing centres 242mm

We do not recommend pre cutting of doors as sizes are approximate and may differ from those shown

ESCUTCHEON



J1407
Diameter 32mm

CYLINDER PULL



J2601
70mm x 42mm

PROJECTING DOOR STOP 
WALL MOUNTED



J1280
Projection 86mm
Rose 40mm

OVAL DOOR STOP 
FLOOR MOUNTED



J1185
length 50mm
Height 23mm

SHIELDED DOOR STOP 
FLOOR MOUNTED



J1182
Diameter 36mm
Height 30mm

CYLINDRICAL DOOR STOP
FLOOR MOUNTED



J1195
Diameter 50mm
Height 38mm

HAT AND COAT HOOK 



J4303
Height 130mm
Projection 35mm

ROBE HOOK 



J4403
Projection 35mm
Height 50mm

INDICATOR BOLT

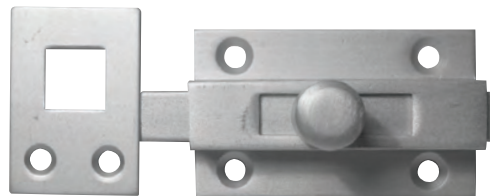

J3701
Internal
66mm x 34mm
External
55mm x 34mm



HANDRAIL BRACKET

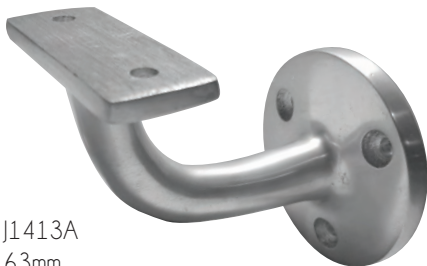

J1413A
63mm
J1413B
76mm

FLUSH PULL 



J1408
90mm x 40mm
Depth 10mm

DRAWER PULL 

J4801
102mm x 9mm



MORTICE

KNOB FURNITURE

Mortice door knobs with a mix of designs and materials helping to create a range of variety and style.



MORTICE KNOB FURNITURE

MUSHROOM MORTICE KNOB

SPRUNG ONE SIDE
Diameter 52mm
Projection 64mm
Rose 60mm



JV35SC



JV35SB



JV35PB



JV35SN



JV35PC



JV35AB

REEDED MORTICE KNOB

UNSPRUNG
Diameter 53mm
Projection 75mm
Rose 60mm



JR6MSC



JR6MPC



JR6MPB



CORONET MORTICE KNOB

UNSPRUNG

Diameter 55mm
Projection 67mm
Rose 59mm



JV66SN



JV66PN



JV66AB



MUSHROOM MORTICE KNOB

CONCEALED ROSE UNSPRUNG

Diameter 54mm
Projection 67mm
Rose 62mm



JV46PB



JV46PC



JV46SC



OVAL MORTICE KNOB

SPRUNG

Diameter 56mm
Projection 64mm
Rose 60mm



JV34SC



JV34PB



JV34PC



BALL SHAPE MORTICE KNOB

SPRUNG

Diameter 48mm
Projection 80mm
Rose 60mm



JV48PB



JV48SC



JV48PC



MORTICE KNOB FURNITURE

MUSHROOM MORTICE KNOB

UNSPRUNG

Diameter 52mm
Projection 65mm
Rose 55mm



RONSON MORTICE KNOB

UNSPRUNG

Diameter 67x48mm
Projection 65mm
Rose 59mm



MORTICE KNOB ON ROUND ROSE

UNSPRUNG

Diameter 50mm
Projection 60mm
Rose 56mm



MORTICE KNOB ON SQUARE ROSE

UNSPRUNG

Diameter 50mm
Projection 56mm
Rose 57mm

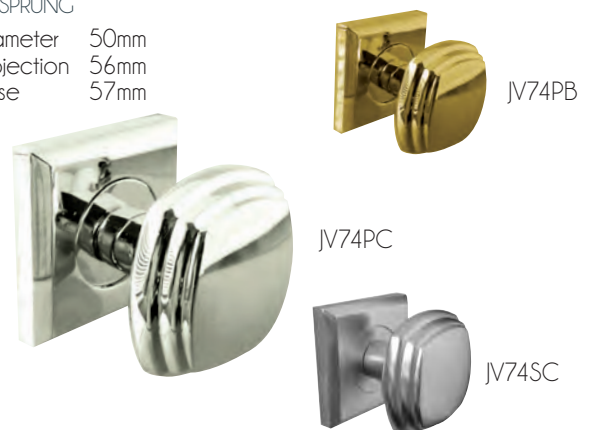

CROWN MORTICE KNOB

UNSPRUNG

Diameter 50mm
Projection 60mm
Rose 56mm



GEORGIAN MORTICE KNOB

SPRUNG

Diameter 52mm
Projection 68mm
Rose 58mm



MORTICE KNOB FURNITURE

CONTRACT MUSHROOM MORTICE KNOB

SPRUNG

Diameter 52mm
Projection 67mm
Rose 60mm

JV35BSC

JV35BPC

JV35BPB



JADE GREEN MARBLE MORTICE KNOB

SPRUNG

Diameter 60mm
Projection 88mm
Rose 55mm

JH5212PB

JH5212PC

JH5212SC



CONTRACT OVAL MORTICE KNOB

SPRUNG

Diameter 63mm
Projection 72mm
Rose 60mm

JV34BPC

JV34BSC

JV34BPB



WHITE MARBLE MORTICE KNOB

SPRUNG

Diameter 60mm
Projection 88mm
Rose 55mm

JH5214PB

JH5214PC

JH5214SC



MUSHROOM MORTICE KNOB

UNPRUNG

Diameter 58mm
Projection 67mm
Rose 64mm

JV172BPB

JV172BPC

JV172BSC



SUNSET RED MARBLE MORTICE KNOB

SPRUNG

Diameter 60mm
Projection 88mm
Rose 55mm

JH5213PB

JH5213PC

JH5213SC



MORTICE KNOB FURNITURE

ANTIQU BRASS REEDED

48mm Diameter



JR8MAB

WOODEN

60mm Diameter



JKA70MSN
French Oak SN finish



JKA60MPB
Dark pine PB finish



JKA60PPB
Pine PB finish

CONCEALED FIXING

60mm Diameter



JV50PB



JV50PC



JV50SC

LINED

60mm Diameter



JV68SC



JV68PC



JV68PB

MORTICE KNOB FURNITURE



JV183MAB



JV183MPC



JV183MPBN



JV183MSC

FLUTED MORTICE KNOB



UNSPRUNG
Diameter 56mm
Projection 84mm
Rose 65mm



JV183MPB

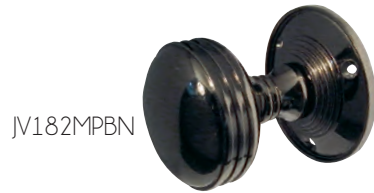

JV182MPBN



JV182MPB



JV182MPC



JV182MAB

RINGED MORTICE KNOB



UNSPRUNG
Diameter 57mm
Projection 75mm
Rose 65mm

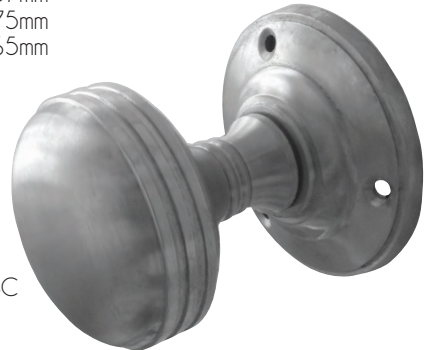

JV182MSC



JV181MPC



JV181MAB



JV181MPB



JV181MSC

LINED MORTICE KNOB



UNSPRUNG
Diameter 55mm
Projection 75mm
Rose 65mm



JV181MPBN

MORTICE KNOB FURNITURE

OVAL RIM KNOB FURNITURE

UNPRUNG

Diameter 53mm

Projection 75mm

Rose 60mm



JV34RPB

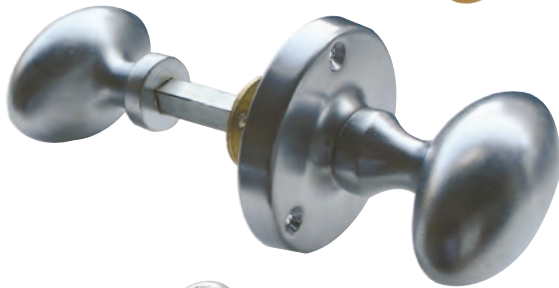

JV34RSC



JV34RPC

MUSHROOM RIM KNOB FURNITURE

UNPRUNG

Diameter 52mm

Projection 65mm

Rose 55mm



JV176ASC



JV176APC



JV176APB

REEDED RIM KNOB FURNITURE

UNPRUNG

Diameter 53mm

Projection 75mm

Rose 60mm



JR6RPC



JR6RPB



JR6RSC

CONTRACT RIM KNOB FURNITURE

UNPRUNG

Diameter 50mm

Projection 66mm

Rose 54mm



JV177SC



JV177PB



JV177PC

ESCUTCHEONS & TURNS AND RELEASES

Rose 40mm

MATCHING JV181M, JV182M & JV183M



JV2680AB



JV2680PBN



JV2680PB

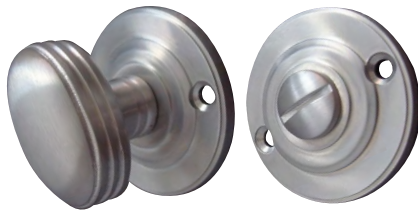

JV2680SC



JV2680PC

MATCHING JV181M, JV182M & JV183M

Diameter 40mm



JV603AB
STANDARD KEYWAY



JV603PB
STANDARD KEYWAY



JV603PC
STANDARD KEYWAY



JV603EAB
EURO PROFILE



JV603EPB
EURO PROFILE



JV603EPC
EURO PROFILE



JV603PBN
STANDARD KEYWAY



JV603SC
STANDARD KEYWAY



JV603EPBN
EURO PROFILE



JV603ESC
EURO PROFILE



JV76AB
JV76PN
JV76SN
STANDARD KEYWAY

matches JV65 Mortice Knob

GLASS

FURNITURE

Our large range of glass door and cabinet furniture gives you a huge choice of styles, colour and design to choose from.

GLASS MORTICE KNOBS

FACETED GLASS MORTICE FURNITURE



SPRUNG

Diameter 60mm
Projection 86mm
Rose 55mm

JH5255PB



JH5255SC



JH5255PC



DICE GLASS MORTICE FURNITURE



UNSPRUNG

Diameter 45mm
Projection 80mm
Rose 60mm

JH1160PC



JH1160SN



PLAIN BALL GLASS MORTICE FURNITURE



SPRUNG

Diameter 60mm
Projection 88mm
Rose 55mm

JH5201PB



JH5201SN



JH5201SC



JH5201PC



PUMPKIN GLASS MORTICE FURNITURE



SPRUNG

Diameter 60mm
Projection 86mm
Rose 55mm

JH5202PB



JH5202PC



JH5202SC



GLASS MORTICE KNOBS

MODERNO MORTICE KNOB FURNITURE



OVAL GLASS MORTICE FURNITURE



PLAIN BALL GLASS MORTICE FURNITURE



UNSPRUNG

Diameter 60mm
Projection 94mm
Rose 60mm



FROSTED BALL GLASS MORTICE FURNITURE



SPRUNG

Diameter 60mm
Projection 88mm
Rose 55mm



BUBBLE MORTICE KNOB



SPRUNG

Diameter 60mm
Projection 88mm
Rose 55mm



GLASS MORTICE KNOBS

CUBE GLASS MORTICE FURNITURE

UNSPRUNG

Diameter 45mm
Projection 84mm
Rose 60mm

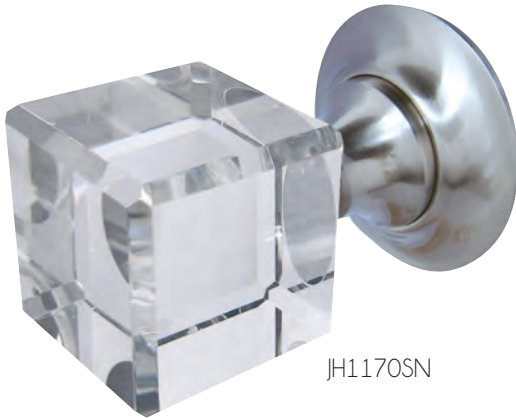

JH1170SN



JH1170PN

RUBIC GLASS MORTICE FURNITURE

UNSPRUNG

Diameter 45mm
Projection 84mm
Rose 60mm



JH1180SN



JH1180PN

PALMA GLASS MORTICE FURNITURE

SPRUNG

Diameter 58mm
Projection 88mm
Rose 55mm



JH1190SN



JH1190PN



GLASS MORTICE KNOBS



COLOURED PLAIN BALL MORTICE FURNITURE

SPRUNG

Diameter 60mm
Projection 88mm
Rose 55mm

PURPLE
JH5209PB
JH5209PC
JH5209SC



BLACK
JH5206PB
JH5206PC
JH5206SC



GREEN
JH5208PB
JH5208PC
JH5208SC



BLUE
JH5207PB
JH5207PC
JH5207SC



AMBER
JH5205PB
JH5205PC
JH5205SC



COLOURED FACETED MORTICE FURNITURE

SPRUNG

Diameter 60mm
Projection 88mm
Rose 55mm

GREEN
JH5259PB
JH5259PC
JH5259SC



BLACK
JH5257PB
JH5257PC
JH5257SC



BLUE
JH5258PB
JH5258PC
JH5258SC



AMBER
JH5256PB
JH5256PC
JH5256SC



PURPLE
JH5260PB
JH5260PC
JH5260SC

FLOWER-OCTAGONAL MORTICE KNOB

UNSPRUNG

Diameter 54mm
Projection 69mm
Rose 59mm



JH7020PB



JH7020SC



JH7020PC

MILO GLASS

See page 11 for details



JH5314SC

FLUTED GLASS

See page 12 for details



JH5312PC

GLASS TURN AND RELEASE

5mm Spindle

Rose Diameter 36mm

JH6001PB
JH6001PC
JH6001SC

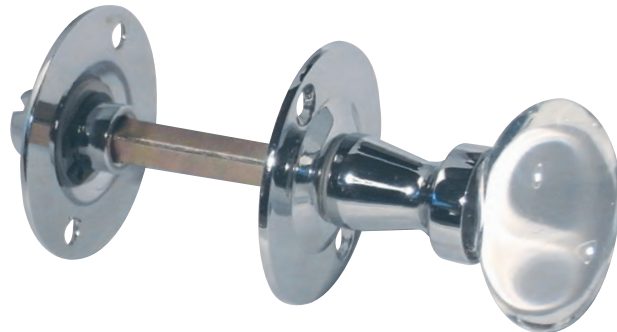

GLASS CUPBOARD KNOBS

Diameter 40mm
Projection 54mm
Rose 28mm



JH1155-40PB
JH1155-40PC
JH1155-40SC

Diameter 30mm
Projection 43mm
Rose 26mm



JH1155-30PB
JH1155-30PC
JH1155-30SC

FACETED GLASS



Diameter 25mm
Projection 35mm
Rose 20mm

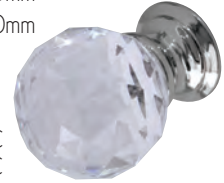

JH1155-25PB
JH1155-25PC
JH1155-25SC

Diameter 35mm
Projection 48mm
Rose 26mm



JH1151-35PB
JH1151-35PC
JH1151-35SC

Diameter 30mm
Projection 43mm
Rose 26mm



JH1151-30PB
JH1151-30PC
JH1151-30SC

PLAIN CLEAR BALL



Diameter 25mm
Projection 36mm
Rose 20mm



JH1151-25PB
JH1151-25PC
JH1151-25SC

Diameter 35mm
Projection 50mm
Rose 26mm



JH1152-35PB
JH1152-35PC
JH1152-35SC

Diameter 30mm
Projection 42mm
Rose 26mm



JH1152-30PB
JH1152-30PC
JH1152-30SC

PUMPKIN GLASS



Diameter 25mm
Projection 36mm
Rose 20mm



JH1152-25PB
JH1152-25PC
JH1152-25SC

Diameter 35mm
Projection 48mm
Rose 26mm



JH1156-35PB
JH1156-35PC
JH1156-35SC

Diameter 30mm
Projection 43mm
Rose 26mm



JH1156-30PB
JH1156-30PC
JH1156-30SC

PLAIN FROSTED BALL



Diameter 25mm
Projection 36mm
Rose 20mm



JH1156-25PB
JH1156-25PC
JH1156-25SC

GLASS CUPBOARD KNOBS

COLOURED FACETED CUPBOARD KNOB

SIZE 25mm	SIZE 30mm	SIZE 40mm
Diameter 25mm	Diameter 30mm	Diameter 40mm
Projection 35mm	Projection 43mm	Projection 54mm
Rose 20mm	Rose 26mm	Rose 28mm



AMBER		
25mm	30mm	40mm
JH1256-25PB	JH1256-30PB	JH1256-40PB
JH1256-25PC	JH1256-30PC	JH1256-40PC
JH1256-25SC	JH1256-30SC	JH1256-40SC

BLACK		
25mm	30mm	40mm
JH1257-25PB	JH1257-30PB	JH1257-40PB
JH1257-25PC	JH1257-30PC	JH1257-40PC
JH1257-25SC	JH1257-30SC	JH1257-40SC

BLUE		
25mm	30mm	40mm
JH1258-25PB	JH1258-30PB	JH1258-40PB
JH1258-25PC	JH1258-30PC	JH1258-40PC
JH1258-25SC	JH1258-30SC	JH1258-40SC

GREEN		
25mm	30mm	40mm
JH1259-25PB	JH1259-30PB	JH1259-40PB
JH1259-25PC	JH1259-30PC	JH1259-40PC
JH1259-25SC	JH1259-30SC	JH1259-40SC

PURPLE		
25mm	30mm	40mm
JH1260-25PB	JH1260-35PB	JH1260-40PB
JH1260-25PC	JH1260-35PC	JH1260-40PC
JH1260-25SC	JH1260-35SC	JH1260-40SC

COLOURED PLAIN CUPBOARD KNOB

SIZE 25mm	SIZE 30mm	SIZE 35mm
Diameter 25mm	Diameter 30mm	Diameter 35mm
Projection 36mm	Projection 43mm	Projection 50mm
Rose 20mm	Rose 26mm	Rose 26mm



AMBER		
25mm	30mm	35mm
JH1205-25PB	JH1205-30PB	JH1205-35PB
JH1205-25PC	JH1205-30PC	JH1205-35PC
JH1205-25SC	JH1205-30SC	JH1205-35SC

BLACK		
25mm	30mm	35mm
JH1206-25PB	JH1206-30PB	JH1206-35PB
JH1206-25PC	JH1206-30PC	JH1206-35PC
JH1206-25SC	JH1206-30SC	JH1206-35SC

BLUE		
25mm	30mm	35mm
JH1207-25PB	JH1207-30PB	JH1207-35PB
JH1207-25PC	JH1207-30PC	JH1207-35PC
JH1207-25SC	JH1207-30SC	JH1207-35SC

GREEN		
25mm	30mm	35mm
JH1208-25PB	JH1208-30PB	JH1208-35PB
JH1208-25PC	JH1208-30PC	JH1208-35PC
JH1208-25SC	JH1208-30SC	JH1208-35SC

PURPLE		
25mm	30mm	35mm
JH1209-25PB	JH1209-30PB	JH1209-35PB
JH1209-25PC	JH1209-30PC	JH1209-35PC
JH1209-25SC	JH1209-30SC	JH1209-35SC

OVAL GLASS CUPBOARD KNOB



Diameter	31mm x 19mm
Projection	36mm
Rose	21mm

JH1161PB
JH1161PC
JH1161SC



Diameter	41mm x 26mm
Projection	43mm
Rose	21mm

JH1162PB
JH1162PC
JH1162SC



PORCELAIN

FURNITURE

Four finishes of door and cabinet furniture manufactured to traditional designs in porcelain.



REPLACEMENT ROSES ONLY 60MM

TO SUIT JC10, JC20, JC60 & JC70



JC80RPC



JC10RWH



JC60RBL



JC80RPVD



JC80RAB



JC80RDB



JC80RSC

MORTICE KNOB FURNITURE



UNSPRUNG

Diameter 60mm
Projection 61mm
Rose 62mm

JC60
Plain black



JC20
Goldline white



JC10
Plain white



JC70
Goldline black



COVERED ESCUTCHEON 64mm x 23mm



JC22
Goldline white



JC72
Goldline black



JC62
Plain black



JC12
Plain white

FINGER PLATES

280mm x 78mm



JC21
Goldline white



JC61
Plain black



JC11
Plain white



JC71
Goldline black

PORCELAIN FURNITURE

BATHROOM TURN & RELEASE

Rose 42mm

Bolt supplied separately

Use with J727 & J728 mortice bolts on page 226



JC17
Plain WHITE

JC67
Plain black

WARDROBE KNOB



Diameter 39mm

Projection 40mm

Rose 36mm

JC24
Goldline white



JC74
Goldline black



JC64
Plain black



JC14
Plain white



CUPBOARD KNOB



Diameter 33mm

Projection 36mm

Rose 32mm



JC25
Goldline black



JC65
Plain black



JC15
Plain white



JC75
Goldline black

CUPBOARD KNOB



Diameter 50mm

Projection 50mm

Rose 48mm

JC26
Goldline white



JC16
plain white



JC66
plain black



JC76
Goldline black



CABINET

FURNITURE

Our selection of cabinet furniture brings many designs of handle and knob furniture together in different designs and colours complemented by a range of hooks to match.

CABINET FURNITURE

CUPBOARD KNOB



JV47APB
JV47APC
JV47ASB
JV47ASC
JV47ASN



Diameter 25mm
Projection 24mm
Rose 24mm

JV47BPB
JV47BPC
JV47BSB
JV47BSC
JV47BSN



Diameter 32mm
Projection 28mm
Rose 31mm

JV47CPB
JV47CPC
JV47CSB
JV47CSC
JV47CSN



Diameter 38mm
Projection 32mm
Rose 38mm

JV47DPB
JV47DPC
JV47DSC

Diameter 42mm
Projection 38mm
Rose 41mm

JV47EPB
JV47EPC
JV47ESC

Diameter 50mm
Projection 42mm
Rose 50mm

BALL SHAPED CUPBOARD KNOB



JH8351PC

Diameter 33mm
Projection 41mm
Rose 27mm

JH8352PC

Diameter 28mm
Projection 35mm
Rose 24mm

JH8353PC

Diameter 24mm
Projection 30mm
Rose 21mm

JH8354PC

Diameter 18mm
Projection 24mm
Rose 17mm

MUSHROOM SHAPED CUPBOARD KNOB



JH8471PC

Diameter 35mm
Projection 32mm
Rose 28mm

JH8472PC

Diameter 30mm
Projection 28mm
Rose 24mm

JH8473PC

Diameter 25mm
Projection 24mm
Rose 21mm

IRON CUPBOARD KNOB

IRC3001

Diameter 32mm
Projection 29mm
Rose 21mm

IRC3002

Diameter 38mm
Projection 36mm
Rose 25mm



REEDED CUPBOARD KNOB

JR23APB
JR23APC
JR23ASC

Diameter 22mm
Projection 32mm
Rose 25mm

JR23PB
JR23PC
JR23SC

Diameter 28mm
Projection 44mm
Rose 30mm

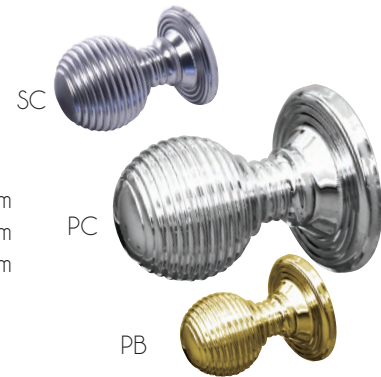

CYLINDER CUPBOARD KNOB

JH8921SSS

Diameter 18mm
Projection 27mm

JH8922SSS

Diameter 14mm
Projection 22mm

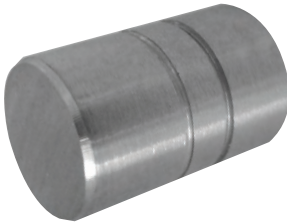

TIN FINISH CUPBOARD KNOB

JH8651T

Diameter 35mm
Projection 30mm
Rose 27mm

JH8653T

Diameter 25mm
Projection 25mm
Rose 21mm

JH8652T

Diameter 30mm
Projection 27mm
Rose 23mm



BALL SHAPED CUPBOARD KNOB WITH NO ROSE



JH8361SSS
JH8361PSS

Diameter 30mm
Projection 31mm

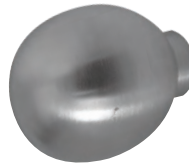

JH8362SSS
JH8362PSS

Diameter 25mm
Projection 27mm

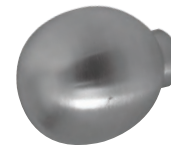

JH8363SSS
JH8363PSS

Diameter 20mm
Projection 22mm

CABINET FURNITURE

DRAWER PULL



PB



PC



SC

JV423PB
JV423PC
JV423SC

Width 87mm
Height 37mm
Projection 23mm

CABINET PULL HANDLE



JH7921B SSS

Length 200mm
Centres 160mm

JH7922B SSS

Length 166mm
Centres 128mm

JH7923B SSS

Length 132mm
Centres 96mm

WOODEN KNOB



DIAMETER 30mm
JKA30A VARNISHED
JKA30B UNVARNISHED



DIAMETER 50mm
JKA50A VARNISHED
JKA50B UNVARNISHED



DIAMETER 38mm
JKA38A VARNISHED
JKA38B UNVARNISHED

NARVI CABINET KNOB

Projection 27mm



GA23PC
22mm



GA23BN
22mm

RITTO CABINET KNOB

Projection: 23mm



GA18BG
25mm



GA18PC
25mm

QUADRA CABINET KNOB

Projection 25mm



GA43BN
35mm



GA43PC
35mm

POLARIS CABINET KNOB

Projection 25mm



GA33BN
18mm



GA33PC
18mm

GYRO CABINET KNOB

Projection 28mm



GA1000PC
32mm



GA1000BN
32mm

DYNASTY CABINET KNOB

Projection 25mm

GA307PC
30mm



OVAL CABINET KNOB

Projection 25mm



GA700BN
43X20mm



GA700PC
43X20mm

LEVA CABINET KNOB

Projection 20mm



GA900BN
70X20mm



GA900PC
70X20mm

CABINET FURNITURE

GRATA CABINET KNOB



	Diameter	Projection
GA800BN	33mm	26mm
GA800PC	33mm	26mm
GA801BN	27mm	23mm
GA801PC	27mm	23mm

DADO CABINET KNOB



	Diameter	Projection
GA500PC	15mm	20mm
GA500SC	15mm	20mm

CUBO CABINET KNOB

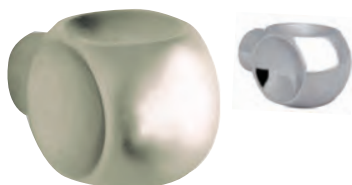

	Diameter	Projection
GA501PC	12mm	20mm
GA501SN	12mm	20mm

LUNA CABINET KNOB



	Diameter	Projection
GA600PC	30mm	23mm
GA600SN	30mm	23mm

PALLA CABINET KNOB



	Diameter	Projection
GA1001BN	25mm	
GA1001PC	32mm	32mm
GA1002BN	22mm	28mm
GA1002PC	22mm	28mm
GA1003BN	18mm	23mm
GA1003PC	18mm	23mm

CRISTALLO ROUND KNOB

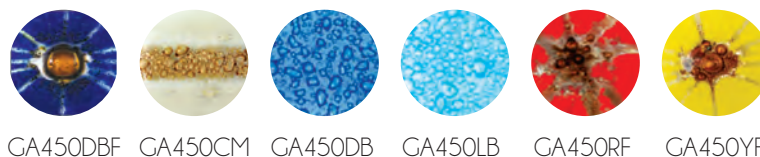

Diameter	48mm
Projection	27mm

CRISTALLO SQUARE KNOB

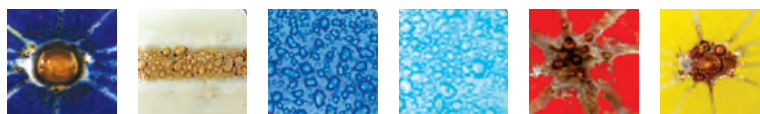

GA440DBF	GA440CM	GA440DB	GA440LB	GA440RF	GA440YF
----------	---------	---------	---------	---------	---------

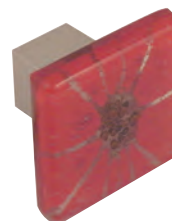

Diameter	38mm
Projection	28mm

NARVI CABINET HANDLE



	Length	Centres
GA20BN	136mm	96mm
GA20PC	136mm	96mm
GA21BN	168mm	128mm
GA21PC	168mm	128mm

RITTO CABINET HANDLE



	Length	Centres
GA10BC	148mm	128mm
GA10PC	148mm	128mm
GA11BC	180mm	160mm
GA11PC	180mm	160mm

QUADRA CABINET HANDLE



	Length	Centres
GA40BN	120mm	96mm
GA40PC	120mm	96mm
GA41BN	150mm	128mm
GA41PC	150mm	128mm
GA42BN	182mm	160mm
GA42PC	182mm	160mm

POLARIS CABINET HANDLE

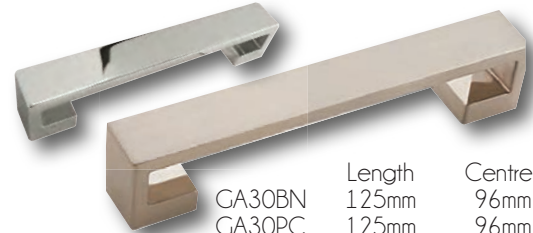

	Length	Centres
GA30BN	125mm	96mm
GA30PC	125mm	96mm
GA31BN	157mm	128mm
GA31PC	157mm	128mm

TWIST CABINET HANDLE



	Length	Centres
GA50BN	106mm	96mm
GA50PC	106mm	96mm
GA51BN	140mm	128mm
GA51PC	140mm	128mm
GA52BN	176mm	160mm
GA52PC	176mm	160mm

DYNASTY CABINET HANDLE



	Length	Centres
GA300PC	128mm	96mm
GA301PC	158mm	128mm
GA302PC	190mm	160mm

PONTE CABINET HANDLE



	Length	Centres
GA60PC	126mm	96mm
GA60SN	126mm	96mm

RIGA CABINET HANDLE



	Length	Centres
GA80SN	145mm	128mm

CABINET FURNITURE

ARCO CABINET HANDLE



	Length	Centres
GA100BN	107mm	96mm
GA100PC	107mm	96mm
GA101BN	145mm	128mm
GA101PC	145mm	128mm

ALTURA CABINET HANDLE



	Length	Centres
GA70PC	126mm	96mm

LISCIO CABINET HANDLE



	Length	Centres
GA200BN	85mm	64mm
GA200PC	85mm	64mm
GA201BN	118mm	96mm
GA201PC	118mm	96mm
GA202BN	156mm	128mm
GA202PC	156mm	128mm

SCUDO CABINET HANDLE



	Length	Centres
GA90PC	120mm	96mm
GA90SN	120mm	96mm
GA91PC	156mm	128mm
GA91SN	156mm	128mm

CRISTALLO CABINET HANDLE

	Length	Centres
	182mm	128mm

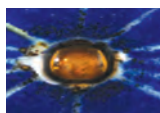

GA430DBF

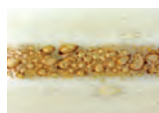

GA430CM

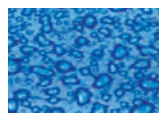

GA430DB



GA430LB



GA430RF



GA430YF

CHAMELEON 2 CABINET HANDLE

Length 183mm
Centres 96mm
Projection 24mm

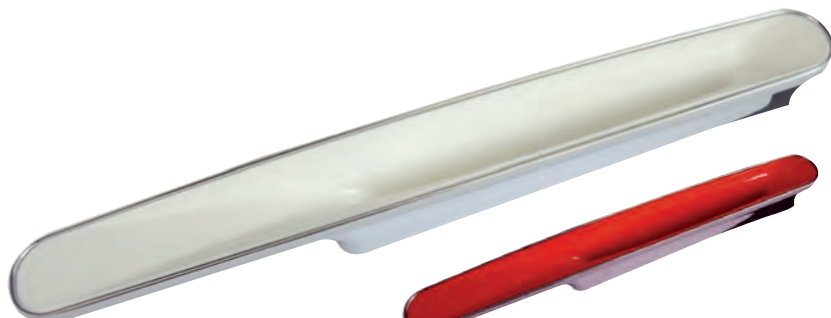

GA416PC WHITE



GA415PC RED

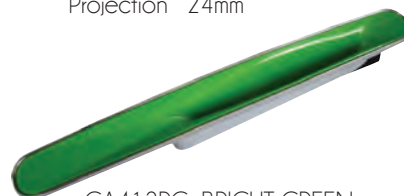

GA412PC BRIGHT GREEN



GA413PC GREEN

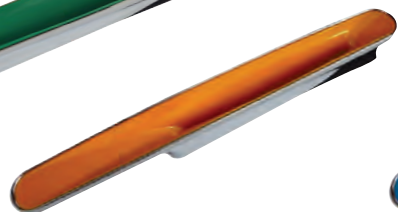

GA414PC ORANGE

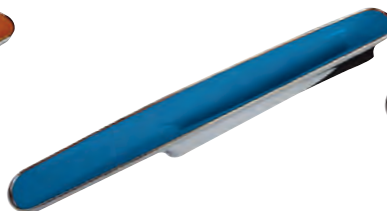

GA411PC BLUE



GA410PC BLACK

CHAMELEON 1 CABINET HANDLE

Length 183mm
Centres 96mm
Projection 24mm



GA404PC ORANGE



GA406PC WHITE

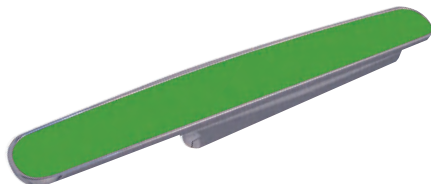

GA402PC BRIGHT GREEN

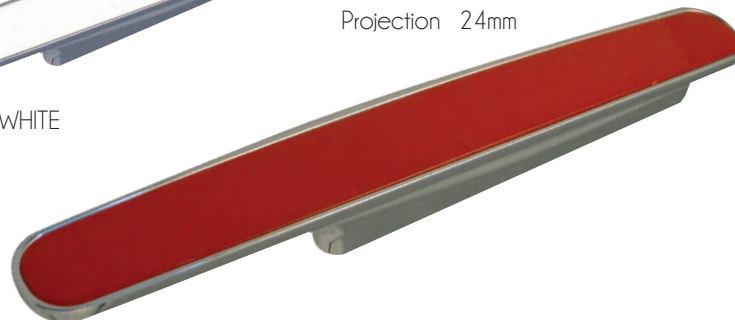

GA405PC RED

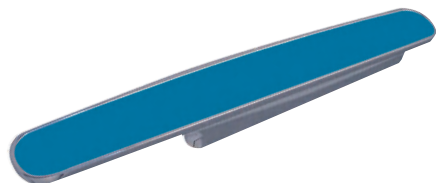

GA401PC BLUE



GA400PC BLACK

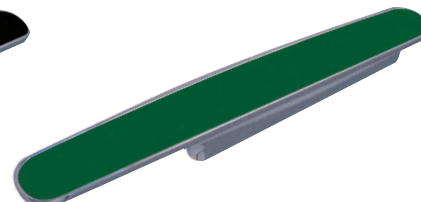

GA403PC GREEN

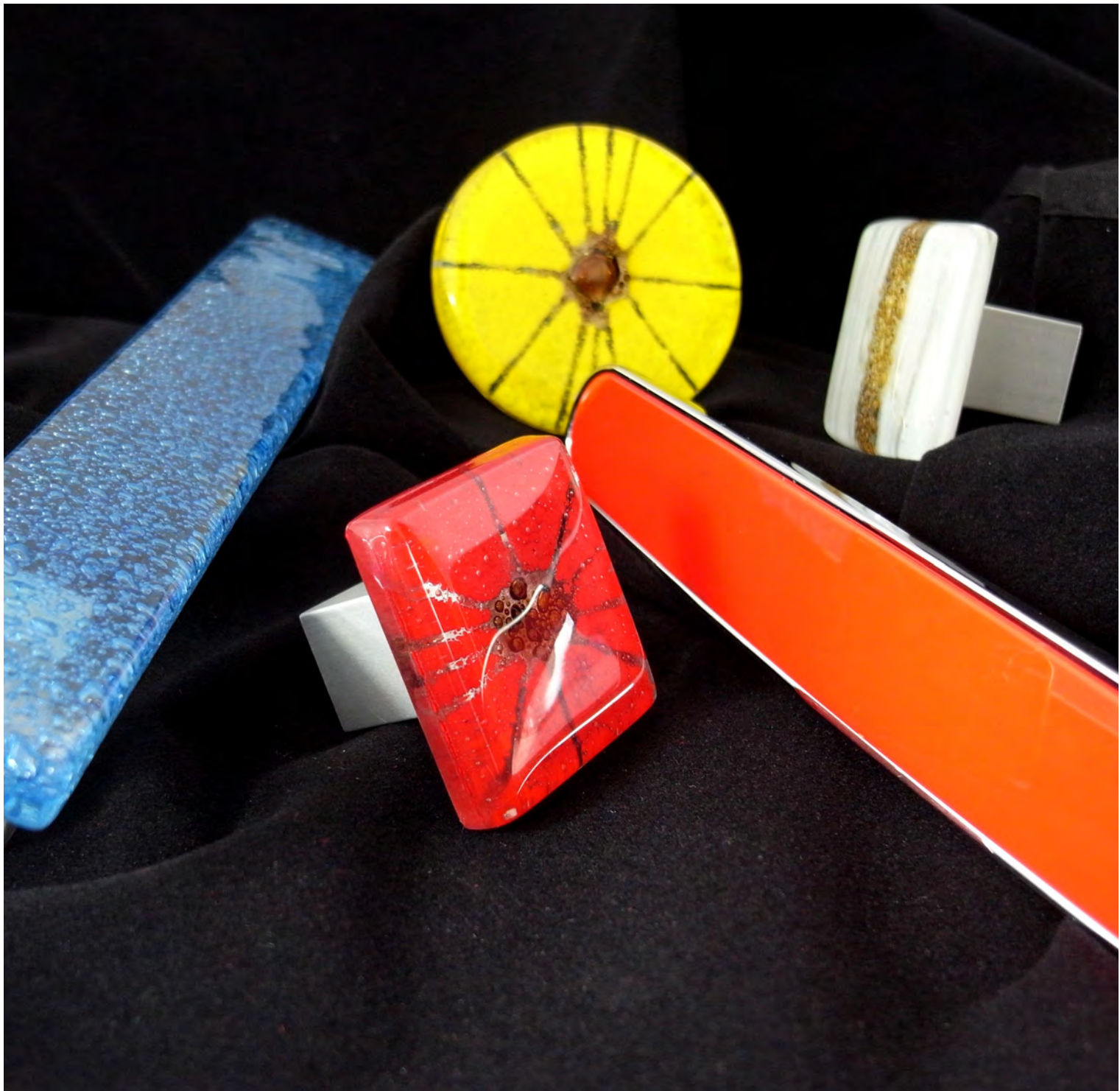

COAT HOOKS

DOUBLE ROBE HOOK

Height 53mm
Projection 27mm



JV62AB
JV62PB
JV62PC
JV62SC
JV62SN

ROBE HOOK

Height 44mm
Projection 36mm



JV61AB
JV61PB
JV61PC
JV61SC
JV61SN

HAT & COAT HOOK

Height 142mm
Projection 64mm



JV60AB
JV60PB
JV60PC
JV60SC
JV60SN

MISTERON HAT & COAT HOOK

Height 135mm
Projection 57mm



GA2000BN
GA2000PC

QUADRA HAT & COAT HOOK

Height 152mm
Projection 70mm



GA44BN
GA44PC

VITTORIA HAT & COAT HOOK

Height 144mm
Projection 60mm



GA2002PC
GA2002SN

VITTORIA DOUBLE ROBE HOOK

Height 58mm
Projection 30mm



GA2001PC
GA2001SN

SEGRETO HAT & COAT HOOK

Height 140mm
Projection 65mm



GA3000PC
GA3000SN

ANSA LARGE ROBE HOOK

Height 117mm
Projection 48mm



GA2006PC
GA2006SN

ANSA SMALL ROBE HOOK

Height 68mm
Projection 23mm



GA2005PC
GA2005SN

HANGING

RAILS

A selection of hanging rail and fittings in chrome and brass.



HANGING RAIL AND FITTINGS

(Rail sold in bundles of 10)



POLISHED CHROME

19mm		25mm	
T100C2 PC 610mm		T100D2 PC 610mm	
T100C3 PC 915mm		T100D3 PC 915mm	
T100C4 PC 1220mm		T100D4 PC 1220mm	
T100C5 PC 1525mm		T100D5 PC 1525mm	
T100C6 PC 1838mm		T100D6 PC 1838mm	
T100C8 PC 2500mm		T100D8 PC 2500mm	



ELECTRO BRASSED

19mm		25mm	
T200C2 EB 610mm		T200D2 EB 610mm	
T200C3 EB 915mm		T200D3 EB 915mm	
T200C4 EB 1220mm		T200D4 EB 1220mm	
T200C5 EB 1525mm		T200D5 EB 1525mm	
T200C6 EB 1838mm		T200D6 EB 1838mm	
T200C8 EB 2500mm		T200D8 EB 2500mm	

CENTRE BRACKET



C826C PC 19mm
C826D PC 25mm
B826C EB 19mm
B826D EB 25mm

END SOCKET



C525C PC 19mm
C525D PC 25mm
B525C EB 19mm
B525D EB 25mm

END SOCKET



C625C PC 19mm
C625D PC 25mm
B625C EB 19mm
B625D EB 25mm

PROJECTING END BRACKET



C100C PC 19mm
C100D PC 25mm
B100C EB 19mm
B100D EB 25mm

PROJECTING CENTRE BRACKET



C101C PC 19mm
C101D PC 25mm
B101C EB 19mm
B101D EB 25mm

CRYSTAL

DOOR FURNITURE

Beautiful range of both Classical and contemporary designer door and cabinet furniture, manufactured combining solid brass with Swarovski® elements.



CRYSTAL MORTICE KNOB FURNITURE

Diameter: 60mm
Projection: 100mm
Rose: 64mm

MADE WITH SWAROVSKI® ELEMENTS

2000-60PC



2000-60PB



2000-60SC



Diameter: 50mm
Projection: 77mm
Rose: 56mm

MADE WITH SWAROVSKI® ELEMENTS

2000-50PB



2000-50PC



2000-50SC



2018PB



2018PC



Diameter: 52mm
Projection: 81mm
Rose: 56mm

MADE WITH SWAROVSKI® ELEMENTS

2018SC



CRYSTAL CABINET FURNITURE

SIZE 40mm
Diameter: 40mm
Projection: 55mm
Rose: 24mm

SIZE 30mm
Diameter: 30mm
Projection: 42mm
Rose: 20mm

SIZE 20mm
Diameter: 20mm
Projection: 32mm
Rose: 14mm

MADE WITH SWAROVSKI® ELEMENTS

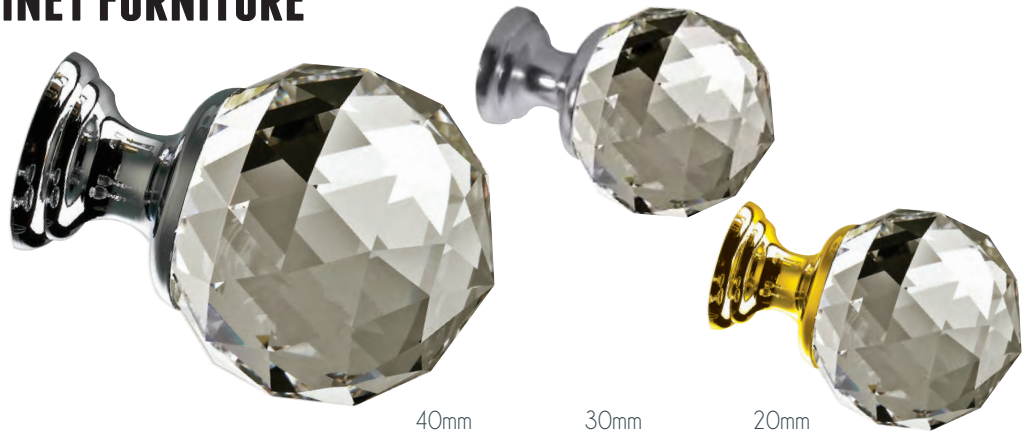

40mm
2000-40PB
2000-40PC
2000-40SC

30mm
2000-30PB
2000-30PC
2000-30SC

20mm
2000-20PB
2000-20PC
2000-20SC



ROUND BAR CABINET HANDLE

2021PC	SIZE 210mm	Centre 160mm
2021SC	SIZE 210mm	Centre 160mm
2022PC	SIZE 250mm	Centre 200mm
2022SC	SIZE 250mm	Centre 200mm

MADE WITH SWAROVSKI® ELEMENTS



SQUARE BAR CABINET HANDLE

2031PC	SIZE 210mm	Centre 160mm
2031SC	SIZE 210mm	Centre 160mm
2032PC	SIZE 250mm	Centre 200mm
2032SC	SIZE 250mm	Centre 200mm



2017PC

Diameter: 20mm
Projection: 26mm

MADE WITH SWAROVSKI® ELEMENTS



2017PB

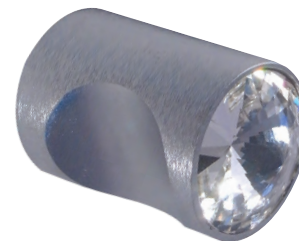

2017SC

CRYSTAL CYLINDRICAL DOOR FURNITURE

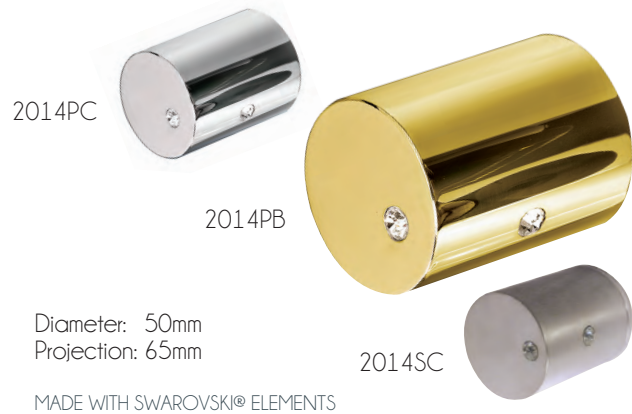
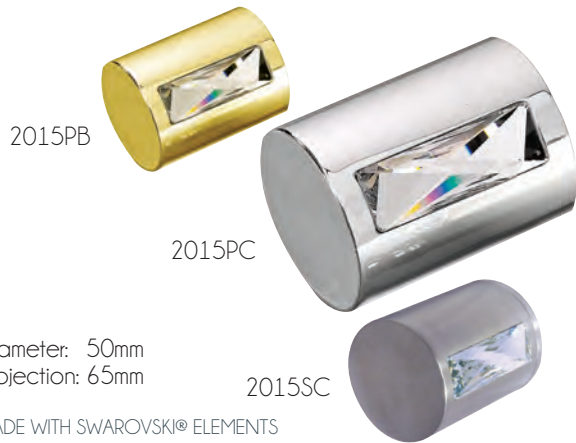

PLAIN MORTICE HANDLE

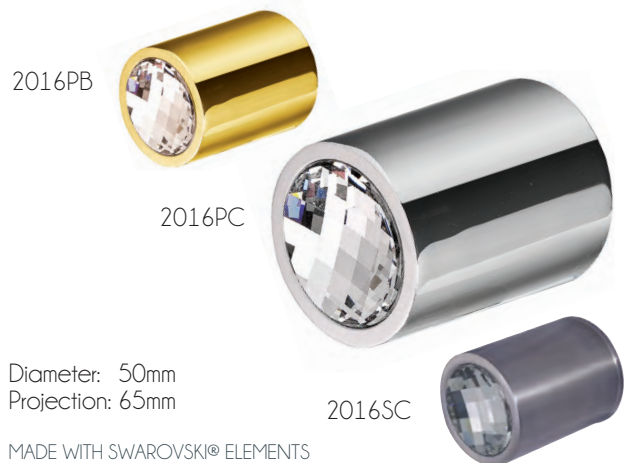
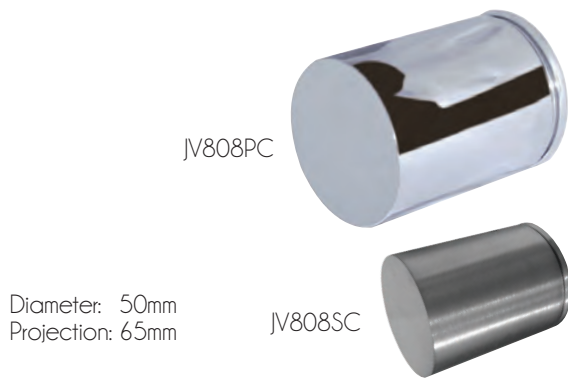

CRYSTAL CABINET KNOBS



2009PC
18X35mm



2008PC
16X30mm



2010PC
14X35mm



2007PC
16X30mm

MADE WITH SWAROVSKI® ELEMENTS



2013-20PC
20X25mm



2012-20PC
20X25mm



2012-28PC
28X27mm

MADE WITH SWAROVSKI® ELEMENTS



2018-23PC
23X20mm

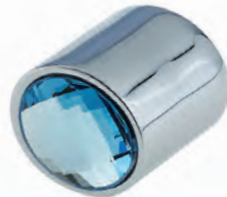

2020-23PC
23X20mm



2022-23PC
23X20mm

MADE WITH SWAROVSKI® ELEMENTS



2019PC
80X22mm



2664PC
20X25mm



2663PC
20X25mm

MADE WITH SWAROVSKI® ELEMENTS

EXTERIOR



DOOR FURNITURE

A wide range of exterior door furniture and fittings to add the finishing touches to the exterior of properties as well as adding security.

EXTERIOR DOOR FURNITURE

180 DEGREE DOOR VIEWER

Max door Width 55mm
Min Door Width 35mm
Tube Diameter 14mm



JV940PB
JV940PC
JV940SC

OUTSIDE COVERS TO SUIT JV940 DOOR VIEWER



JV941PB
JV941PC
JV941SC

FIRE TESTED 200 DEGREE DOORVIEWERS C/W INTUMESCENT STRIP

BLACK

JV944BL
JV945BL



POLISHED BRASS

JV944PB
JV945PB



POLISHED CHROME

JV944PC
JV945PC



SATIN BRASS

JV944SB
JV945SB



SATIN CHROME

JV944SC
JV945SC



WHITE

JV944WH
JV945WH



ANTIQUE BRASS

JV944AB
JV945AB



JV944 To fit 35 – 55mm Door thickness
JV945 To Fit 50 – 70mm Door thickness

SPRUNG LETTERPLATES



- -
- | | | |
|----------------------------|-----------------------|----------------------|
| JV36SPB size 250mm x 76mm | aperture 196mm x 43mm | fixing centres 225mm |
| JV36LPB size 254mm x 100mm | aperture 206mm x 50mm | fixing centres 232mm |
| JV36BPB size 280mm x 90mm | aperture 206mm x 50mm | fixing centres 240mm |
| JV36APB size 305mm x 100mm | aperture 234mm x 57mm | fixing centres 270mm |
| JV36CPB size 355mm x 115mm | aperture 283mm x 63mm | fixing centres 322mm |



- -
- | | | |
|----------------------------|-----------------------|----------------------|
| JV36SPC size 250mm x 76mm | aperture 196mm x 43mm | fixing centres 225mm |
| JV36LPC size 254mm x 100mm | aperture 206mm x 50mm | fixing centres 232mm |
| JV36BPC size 280mm x 90mm | aperture 206mm x 50mm | fixing centres 240mm |
| JV36APC size 305mm x 100mm | aperture 234mm x 57mm | fixing centres 270mm |
| JV36CPC size 355mm x 115mm | aperture 283mm x 63mm | fixing centres 322mm |



- -
- | | | |
|----------------------------|-----------------------|----------------------|
| JV36SSC size 250mm x 76mm | aperture 196mm x 43mm | fixing centres 225mm |
| JV36LSC size 254mm x 100mm | aperture 206mm x 50mm | fixing centres 232mm |
| JV36BSC size 280mm x 90mm | aperture 206mm x 50mm | fixing centres 240mm |
| JV36ASC size 305mm x 100mm | aperture 234mm x 57mm | fixing centres 270mm |
| JV36CSC size 355mm x 115mm | aperture 283mm x 63mm | fixing centres 322mm |

SLOANE LETTERPLATE



- | | | | |
|--------|--------------------|-----------------------|----------------------|
| JV25PB | size 304mm x 100mm | aperture 237mm x 55mm | fixing centres 269mm |
| JV25PC | size 304mm x 100mm | aperture 237mm x 55mm | fixing centres 269mm |
| JV25SC | size 304mm x 100mm | aperture 237mm x 55mm | fixing centres 269mm |

We do not recommend pre cutting of doors as sizes are approximate and may differ from those shown

EXTERIOR DOOR FURNITURE

POSTAL KNOCKER

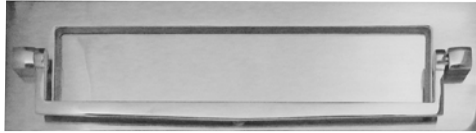

JV80PC



JV80SC



JV80PB

Size 250mm x 76mm Aperture 190mm x 40mm Fixing Centres 215mm

GRAVITY PLATE



JV16PB

Size 254mm x 76mm Aperture 204mm x 42mm Fixing Centres 230mm

GEORGIAN BRASS LETTERPLATE

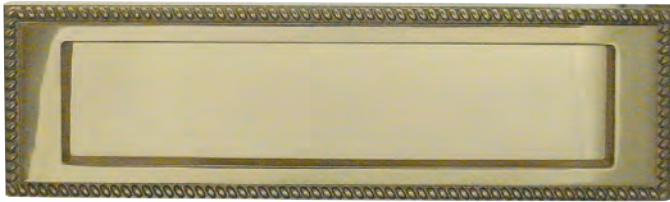

JG7SPB

Size 254mm x 76mm Aperture 204mm x 44mm Fixing Centres 227mm

GEORGIAN BRASS POSTAL KNOCKER



JG80PB

Size 254mm x 76mm Aperture 195mm x 40mm Fixing Centres 225mm

INNER TIDY



JV53PB

JV53PC

JV53SC

Size 280mm x 80mm

JV53APB

JV53APC

JV53ASC

Size 297mm x 85mm



JV53BPB

JV53BPC

JV53BSC

Size 352mm x 127mm



JV53CPB

JV53CPC

JV53CSC

Size 400mm x 127mm

We do not recommend pre cutting of doors as sizes are approximate and may differ from those shown

EXTERIOR DOOR FURNITURE

SCROLL KNOCKER

Length 135 mm
Rose 34mm



SLOANE SCROLL KNOCKER ON SQUARE ROSE

Length 196 mm
Rose 45mm

JV3PB
JV3PC
JV3SC



SLOANE SCROLL KNOCKER ON ROUND ROSE

Length 196 mm
Rose 45mm

JV4PB
JV4PC
JV4SC



RING KNOCKER

Diameter 105 mm



JV37PB



JV37PC



JV37SC

CONTEMPORARY KNOCKER

Length 157 mm
Width 36mm



URN KNOCKER

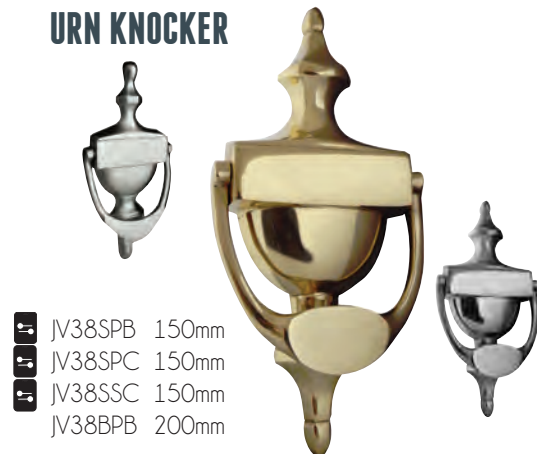

JV38SPB 150mm
JV38SPC 150mm
JV38SSC 150mm
JV38BPB 200mm

EXTERIOR DOOR FURNITURE

PLAIN CYLINDER PULL

Length 86 mm
Width 44mm



JV40PB
JV40PC
JV40SC

GEORGIAN CYLINDER PULL

Length 86 mm
Width 44mm



JG9PB

BELL PUSH

Length 80 mm
Width 30mm



JV18PC



JV18SC



JV18PB

SLOANE BELL PUSH

Height 81 mm
Width 31mm



JV17PC



JV17SC



JV17PB

PINFIX NUMERALS

Height 60 mm

1 2 3 4 0

JP-0 PB PC SC JP-5 PB PC SC
JP-1 PB PC SC JP-6&9 PB PC SC
JP-2 PB PC SC JP-7 PB PC SC
JP-3 PB PC SC JP-8 PB PC SC
JP-4 PB PC SC

SCREWFIX NUMERALS

Height 75 mm

5 6 7 8 9

JN-0 PB PC SC JN-5 PB PC SC
JN-1 PB PC SC JN-6&9 PB PC SC
JN-2 PB PC SC JN-7 PB PC SC
JN-3 PB PC SC JN-8 PB PC SC
JN-4 PB PC SC

PINFIX NUMERALS

Height 50 mm

A B C D

JP-A PB PC SC
JP-B PB PC SC
JP-C PB PC SC
JP-D PB PC SC

EXTERIOR DOOR FURNITURE

CENTRE DOOR KNOB

Diameter 70mm
Projection 80mm
Rose 85mm



JV33PB
JV33PC
JV33SC

CENTRE DOOR KNOB

Diameter 66mm
Projection 76mm
Rose 79mm



JV59PB
JV59PC
JV59SC

SLOANE CENTRE DOOR KNOB

Diameter 102mm
Projection 100mm
Rose 107mm



JV57PB
JV57PC
JV57SC

CENTRE DOOR KNOB

Diameter 75mm
Projection 100mm
Rose 86mm



JV830PB
JV830PC
JV830SC

CENTRE DOOR KNOB

Diameter 60mm
Projection 75mm
Rose 65mm

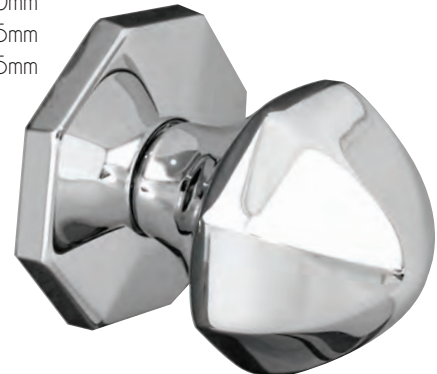

JV49PB
JV49PC
JV49SC

EXTERIOR DOOR FURNITURE

ROUND OPEN ESCUTCHEON

Diameter 32mm



JV41AB
JV41PB
JV41PC
JV41PN
JV41SB
JV41SC
JV41SN

SQUARE OPEN ESCUTCHEON

Size 50mm x 50mm



JV153PB
JV153PC
JV153SC

ROUND COVERED ESCUTCHEON

Diameter 32mm



JV42AB
JV42PB
JV42PC
JV42PN
JV42SB
JV42SC
JV42SN

OVAL COVERED ESCUTCHEON

Diameter 45mm



JV75PB
JV75PC
JV75SC

REEDED COVERED ESCUTCHEON

Diameter 32mm



JR9PB
JR9PC
JR9SC

GEORGIAN COVERED ESCUTCHEON

Diameter 32mm



SECURITY CHAINS & DOOR GUARDS

Chain Retainer 52mm x 20mm

Plate 84mm x 35mm

Chain 200mm

Chain Retainer 60mm x 13mm

Angle Plate 45mm x 32mm x 38mm

Chain 200mm

J3001PB
J3001PC
J3001SC



J3002PB
J3002PC
J3002SC



J3003PB
J3003PC
J3003SC
J3003SN

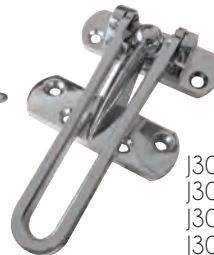

J3004EB
J3004PC
J3004SN

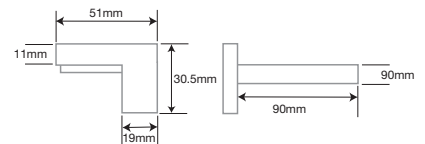

LOCKS & LATCHES

A close-up photograph of a door lock mechanism. The lock is mounted on a dark-colored door. A brass handle is visible on the left, and a keyhole is on the right. The lock body is dark and has a textured finish. The background is blurred, showing a window and some interior elements.

locks and latches for both mortice and rim applications of both architectural and budget quality.

ARCHITECTURAL 72MM DIN LOCKS

SASHLOCK JL100SS

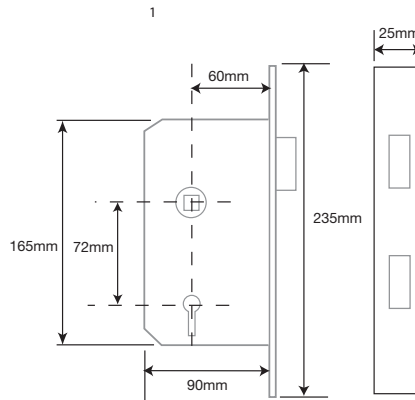

ACCESSORIES FOR SASHLOCK

- SQUARE FOREND
- JL1010PSS
- JL1010PVD
- RADIUSED FOREND
- JL1020PSS
- JL1020PVD
- JL1020SS
- REBATE KIT
- JL1030PSS 13mm
- JL1030SS 13mm
- JL1030PVD 13mm
- JL1031PSS 25mm
- JL1031SS 25mm
- JL1031PVD 25mm

DEADLOCK JL101SS

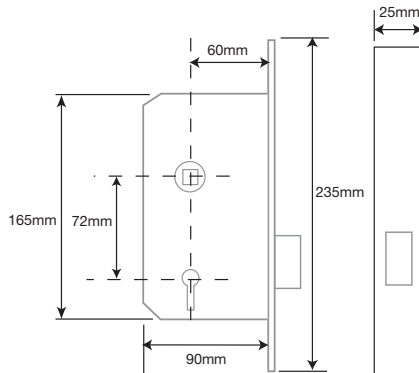

ACCESSORIES FOR DEADLOCK

- SQUARE FOREND
- JL1012PVD
- JL1012PSS
- RADIUSED FOREND
- JL1022PVD
- JL1022PSS
- JL022SS
- REBATE KIT
- JL1030PSS 13mm
- JL1030SS 13mm
- JL1030PVD 13mm
- JL1031PSS 25mm
- JL1031SS 25mm
- JL1031PVD 25mm

BATHROOM LOCK JL1002SS

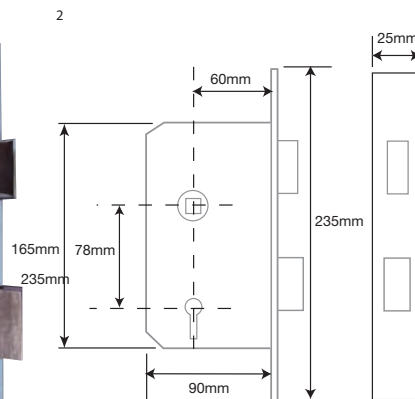

ACCESSORIES FOR BATHROOM LOCK

- SQUARE FOREND
- JL1010PVD
- JL1010PSS
- RADIUSED FOREND
- JL1020PVD
- JL1020PSS
- JL1020SS
- REBATE KIT
- JL1030PSS 13mm
- JL1030SS 13mm
- JL1030PVD 13mm
- JL1031PSS 25mm
- JL1031SS 25mm
- JL1031PVD 25mm

ARCHITECTURAL QUALITY LOCKS



ACCESSORIES FOR LATCH

- SQUARE FOREND
- JL1011PVD
- JL1011PSS
- RADIUSSED FOREND
- JL1021PVD
- JL1021PSS
- JL1021SS
- REBATE KIT
- JL1030PSS 13mm
- JL1030SS 13mm
- JL1030PVD 13mm
- JL1031PSS 25mm
- JL1031SS 25mm
- JL1031PVD 25mm

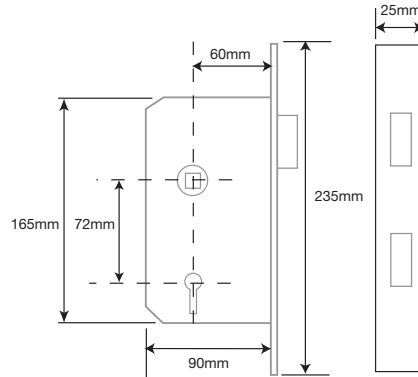

LATCH JL1003SS



ACCESSORIES FOR NIGHTLATCH

- SQUARE FOREND
- JL1011PVD
- JL1011PSS
- RADIUSSED FOREND
- JL1021PVD
- JL1021PSS
- JL1021SS
- REBATE KIT
- JL1030PSS 13mm
- JL1030SS 13mm
- JL1030PVD 13mm
- JL1031PSS 25mm
- JL1031SS 25mm
- JL1031PVD 25mm



NIGHT LATCH JL1004SS WITH ANTI THRUST BOLT

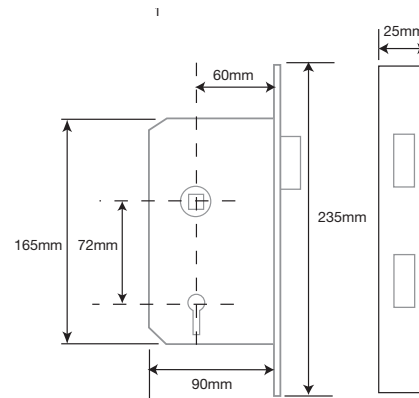

ACCESSORIES FOR LATCH

- SQUARE FOREND
- JL1010PVD
- JL1010PSS
- RADIUSSED FOREND
- JL1020PVD
- JL1020PSS
- JL1020SS
- REBATE KIT
- JL1030PSS 13mm
- JL1030SS 13mm
- JL1030PVD 13mm
- JL1031PSS 25mm
- JL1031SS 25mm
- JL031PVD 25mm

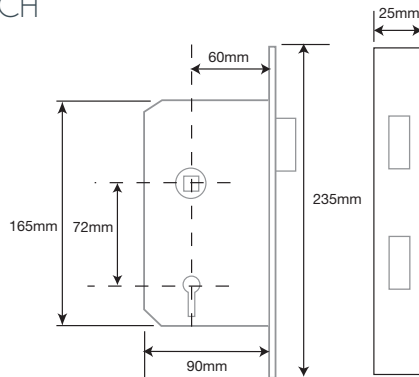

ESCAPE LOCK JL1005SS

C/W 2 PIECE SPINDLE

*Conforms when used with JSS13



ARCHITECTURAL QUALITY LOCKS

5 LEVER BS3621

INSURANCE RATED DEADLOCK

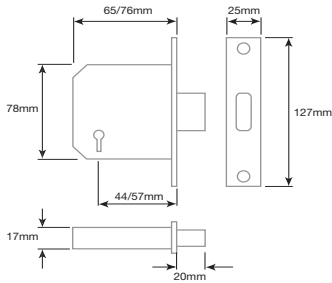

- JL115PVD 65mm
- JL116PVD 76mm
- JL117SSS 65mm
- JL118SSS 76mm

5 LEVER BS3621

INSURANCE RATED SASHLOCK



- JL125PVD 65mm
- JL126PVD 76mm
- JL127SSS 65mm
- JL128SSS 76mm

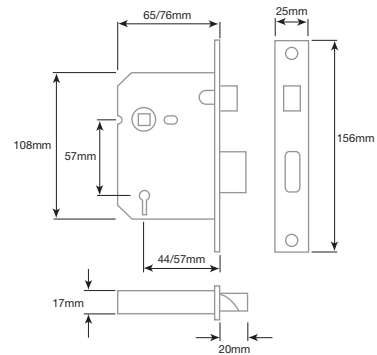

FULL CASE MORTICE LATCH

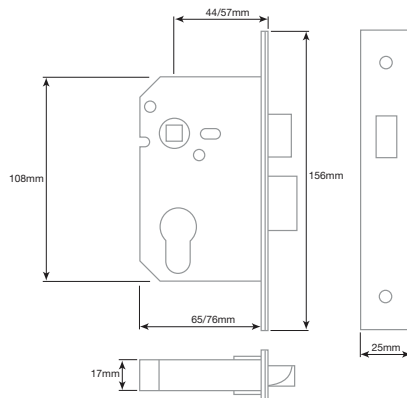

- JL1080SSS 65mm
- JL1081SSS 76mm
- JL1080PVD 65mm
- JL1081PVD 76mm

ARCHITECTURAL QUALITY LOCKS

JEDCO
collection

JL1060SSS 65mm
 JL1061SSS 76mm
 JL1060PVD 65mm
 JL1061PVD 76mm

REBATE KITS

JL9213EB 13mm
 JL9213ZP 13mm



EURO PROFILE DEADLOCK

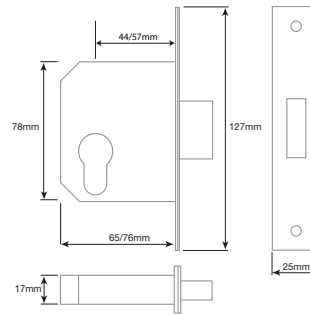

BATHROOM HUB

FITTED TO A EURO PROFILE DEADLOCK OR DINLOCK
 TO ENABLE USE OF A TURN & RELEASE.

JL1070



BATHROOM LOCK



BATHROOM LOCK

JL1071 SSS 65mm
 JL1072 SSS 76mm
 JL1071 PVD 65mm
 JL1072 PVD 76mm

REBATE KITS

JL9113EB 13mm
 JL9113ZP 13mm

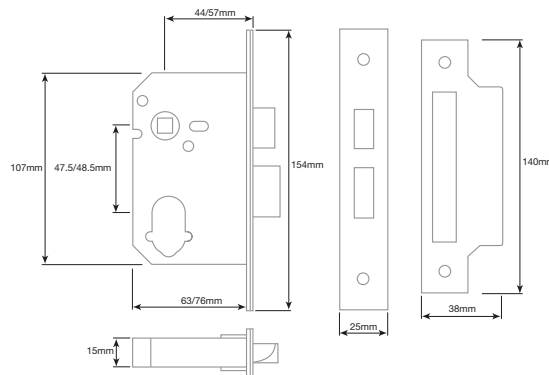

JL1050SSS 65mm
 JL1051SSS 76mm
 JL1050PVD 65mm
 JL1051PVD 76mm

REBATE KITS

JL9113EB 13mm
 JL9113ZP 13mm



EURO PROFILE SASHLOCK

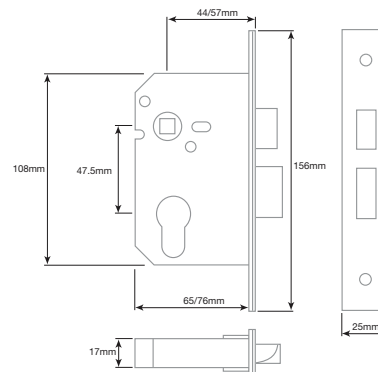

ARCHITECTURAL QUALITY LOCKS

5 LEVER SASHLOCK

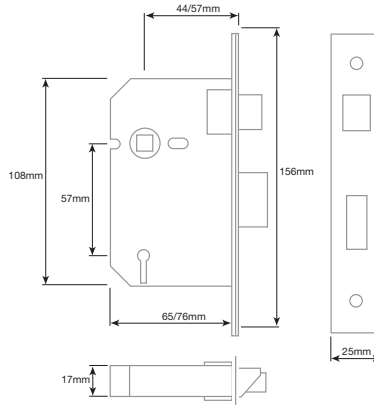

JL135PVD 65mm
JL136PVD 76mm
JL137SSS 65mm
JL138SSS 76mm

REBATE KITS

JL9113EB 13mm
JL9113ZP 13mm

5 LEVER DEADLOCK

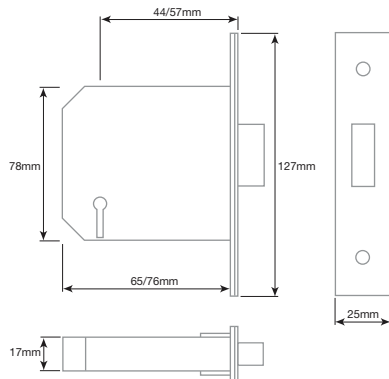

JL145PVD 65mm
JL146PVD 76mm
JL147SSS 65mm
JL148SSS 76mm

REBATE KITS

JL9213EB 13mm
JL9213ZP 13mm



3 LEVER SASHLOCK

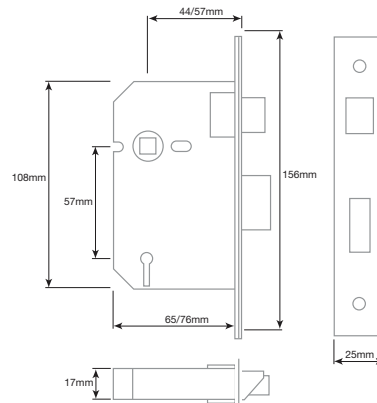

JL1090SSS 65mm
JL1091SSS 76mm
JL1090PVD 65mm
JL1091PVD 76mm

REBATE KITS

JL9113EB 13mm
JL9113ZP 13mm

ARCHITECTURAL QUALITY LOCKS



3 LEVER DEADLOCK

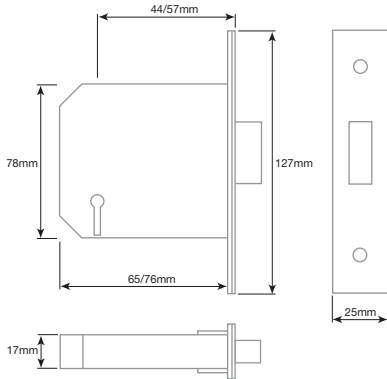

JL1092SSS 65mm
 JL1093SSS 76mm
 JL1092PVD 65mm
 JL1093PVD 76mm



REBATE KITS

JL9213EB 13mm
 JL9213ZP 13mm



SMALL CASE MORTICE LATCH

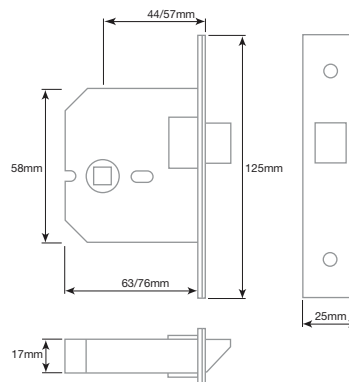

JL1040SSS	65mm	SSS
JL1041SSS	76mm	SSS
JL1040PVD	65mm	PVD GOLD
JL1041PVD	76mm	PVD GOLD

BUDGET LOCKS

BATHROOM LOCKS

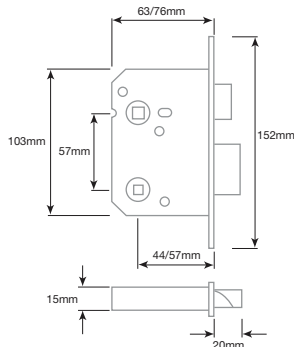

ACCESSORIES FOR BATHROOM LOCK

- REBATE KITS
 JL176EB 13mm
 JL176NP 13mm

- JL150NP 63mm
 JL151NP 76mm
 JL152EB 63mm
 JL153EB 76mm

- RADIUS FORENDS
 JL177RAD-EB
 JL178RAD-NP

3 LEVER SASHLOCK

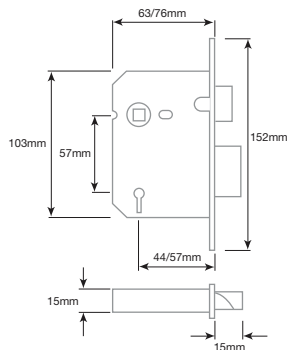

ACCESSORIES FOR SASHLOCK

- REBATE KITS
 JL176EB 13mm
 JL176NP 13mm

- JL170NP 63mm
 JL171NP 76mm
 JL172EB 63mm
 JL173EB 76mm

- RADIUS FORENDS
 JL177RAD-EB
 JL178RAD-NP

BOX DEADBOLT

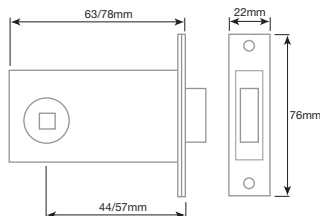

- JL190PB 76mm 5mm Spindle
 JL191SSS 76mm 5mm Spindle
 JL192SSS 76mm 8mm Spindle
 JL194SSS 63mm 5mm Spindle

5 PIN EURO & OVAL PROFILE CYLINDERS - ANTI PICK & ANTI DRILL

Master Key Suites also available Tel 020 648 1500 for details

EURO PROFILE SINGLE CYLINDERS



TO DIFFER

JL-40EPSPB	40mm PB
JL-40EPSPC	40mm PC
JL-40EPSSC	40mm SC
JL-45EPSPB	45mm PB
JL-45EPSPC	45mm PC
JL-45EPSSC	45mm SC
JL-50EPSPB	50mm PB
JL-50EPSPC	50mm PC
JL-50EPSSC	50mm SC

KEYED ALIKE

JL-40EPSPB-KA	40mm PB
JL-40EPSPC-KA	40mm PC
JL-40EPSSC-KA	40mm SC
JL-45EPSPB-KA	45mm PB
JL-45EPSPC-KA	45mm PC
JL-45EPSSC-KA	45mm SC

EURO PROFILE DOUBLE CYLINDERS



TO DIFFER

JL-60EPDPB	60MM	PB
JL-60EPDPC	60MM	PC
JL-60EPDSC	60MM	SC
JL-70EPDPB	70MM	PB
JL-70EPDPC	70MM	PC
JL-70EPDSC	70MM	SC
JL-80EPDPB	80MM	PB
JL-80EPDPC	80MM	PC
JL-80EPDSC	80MM	SC
JL-90EPDPB	90MM	PB
JL-90EPDPC	90MM	PC
JL-90EPDSC	90MM	SC
JL-100EPDPB	100MM	PB
JL-100EPDPC	100MM	PC
JL-100EPDSC	100MM	SC

KEYED ALIKE

JL-60EPDPB-KA	60MM	PB
JL-60EPDPC-KA	60MM	PC
JL-60EPDSC-KA	60MM	SC
JL-70EPDPB-KA	70MM	PB
JL-70EPDPC-KA	70MM	PC
JL-70EPDSC-KA	70MM	SC
JL-80EPDPB-KA	80MM	PB
JL-80EPDPC-KA	80MM	PC
JL-80EPDSC-KA	80MM	SC

OFFSET CYLINDERS

JL-3040EPDPB	30x40mm	PB
JL-3040EPDPC	30x40mm	PC
JL-3040EPDSC	30x40mm	SC
JL-3545EPDPB	35x45mm	PB
JL-3545EPDPC	35x45mm	PC
JL-3545EPDSC	35x45mm	SC
JL-3550EPDPB	35x50mm	PB
JL-3550EPDPC	35x50mm	PC
JL-3550EPDSC	35x50mm	SC
JL-3555EPDPB	35x55mm	PB
JL-3555EPDPC	35x55mm	PC
JL-3555EPDSC	35x55mm	SC
JL-4050EPDPB	40x50mm	PB
JL-4050EPDPC	40x50mm	PC
JL-4050EPDSC	40x50mm	SC
JL-4555EPDPB	45x55mm	PB
JL-4555EPDPC	45x55mm	PC
JL-4555EPDSC	45x55mm	SC

TO DIFFER

JL-60EPTPB	60MM	PB
JL-60EPTPC	60MM	PC
JL-60EPTSC	60MM	SC
JL-70EPTPB	70MM	PB
JL-70EPTPC	70MM	PC
JL-70EPTSC	70MM	SC
JL-80EPTPB	80MM	PB
JL-80EPTPC	80MM	PC
JL-80EPTSC	80MM	SC
JL-90EPTPB	90MM	PB
JL-90EPTPC	90MM	PC
JL-90EPTSC	90MM	SC
JL-100EPTPB	100MM	PB
JL-100EPTPC	100MM	PC
JL-100EPTSC	100MM	SC

KEYED ALIKE

JL-70EPTPB-KA	70MM	PB
JL-70EPTPC-KA	70MM	PC
JL-70EPTSC-KA	70MM	SC

OFFSET CYLINDERS

JL-3050EPTPB	30x50mm	PB
JL-3050EPTPC	30x50mm	PC
JL-3050EPTSC	30x50mm	SC
JL-3070EPTPB	30x70mm	PB
JL-3070EPTPC	30x70mm	PC
JL-3070EPTSC	30x70mm	SC
JL-3540EPTPB	35x40mm	PB
JL-3540EPTPC	35x40mm	PC
JL-3540EPTSC	35x40mm	SC
JL-3545EPTPB	35x45mm	PB
JL-3545EPTPC	35x45mm	PC
JL-3545EPTSC	35x45mm	SC
JL-3555EPTPB	35x55mm	PB
JL-3555EPTPC	35x55mm	PC
JL-3555EPTSC	35x55mm	SC
JL-4035EPTPB	40x35mm	PB
JL-4035EPTPC	40x35mm	PC
JL-4035EPTSC	40x35mm	SC
JL-4050EPTPB	40x50mm	PB
JL-4050EPTPC	40x50mm	PC
JL-4050EPTSC	40x50mm	SC
JL-4060EPTPB	40x60mm	PB
JL-4060EPTPC	40x60mm	PC
JL-4060EPTSC	40x60mm	SC

EURO PROFILE CYLINDER & TURN



STOCK MASTER KEY SUITE MK1

RIM CYLINDERS



JL-5PRCPB-MK1
JL-5PRCPC-MK1
JL-5PRCSC-MK1

EURO PROFILE SINGLE CYLINDERS



JL-45EPSPB-MK1 45mm PB
JL-45EPSPC-MK1 45mm PC
JL-45EPSSC-MK1 45mm SC

EURO PROFILE DOUBLE CYLINDERS



JL-60EPDPB-MK1 60mm PB
JL-60EPDPC-MK1 60mm PC
JL-60EPDSC-MK1 60mm SC
JL-70EPDPB-MK1 70mm PB
JL-70EPDPC-MK1 70mm PC
JL-70EPDSC-MK1 70mm SC
JL-80EPDPB-MK1 80mm PB
JL-80EPDPC-MK1 80mm PC
JL-80EPDSC-MK1 80mm SC

EURO PROFILE CYLINDERS & TURNS



JL-60EPCTPB-MK1 60mm PB
JL-60EPCTPC-MK1 60mm PC
JL-60EPCTSC-MK1 60mm SC
JL-70EPCTPB-MK1 70mm PB
JL-70EPCTPC-MK1 70mm PC
JL-70EPCTSC-MK1 70mm SC
JL-80EPCTPB-MK1 80mm PB
JL-80EPCTPC-MK1 80mm PC
JL-80EPCTSC-MK1 80mm SC

KEYS

JL-1900 BLANK KEYS
JL-MK1 MASTER KEYS FOR STOCK SUITE MK1

OVAL PROFILE CYLINDERS - ANTI PICK & ANTI DRILL

OVAL PROFILE SINGLE CYLINDERS



JL40-OPSPB 40mm PB
JL40-OPSPC 40mm PC
JL40-OPSSC 40mm SC
JL45-OPSPB 45mm PB
JL45-OPSPC 45mm PC
JL45-OPSSC 45mm SC

OVAL PROFILE DOUBLE CYLINDERS



JL60-OPDPB 60mm PB
JL60-OPDPC 60mm PC
JL60-OPDSC 60mm SC
JL70-OPDPB 70mm PB
JL70-OPDPC 70mm PC
JL70-OPDSC 70mm SC
JL80-OPDPB 80mm PB
JL80-OPDPC 80mm PC
JL80-OPDSC 80mm SC

OVAL PROFILE CYLINDER & TURN



JL60-OPCTPB 60mm PB
JL60-OPCTPC 60mm PC
JL60-OPCTSC 60mm SC
JL70-OPCTPB 70mm PB
JL70-OPCTPC 70mm PC
JL70-OPCTSC 70mm SC
JL80-OPCTPB 80mm PB
JL80-OPCTPC 80mm PC
JL80-OPCTSC 80mm SC

TESTED HEAVY DUTY LATCHES AND DEADBOLTS

HEAVY DUTY TUBULAR LATCHES

Tested to 200,000 cycles



COMPLETE

JL-HDT64PSS 64mm PSS finish
 JL-HDT64PVD 64mm PVD brass finish
 JL-HDT64SS 64mm SS finish

JL-HDT76PSS 76mm PSS finish
 JL-HDT76PVD 76mm PVD brass finish
 JL-HDT76SS 76mm SS finish

JL-HDT102PSS 102mm PSS finish
 JL-HDT102PVD 102mm PVD brass finish
 JL-HDT102SS 102mm SS finish



HEAVY DUTY TUBULAR DEADBOLTS

Tested to 50,000 cycles



COMPLETE

JL-HDB64PSS 64mm PSS finish
 JL-HDB64PVD 64mm PVD brass finish
 JL-HDB64SS 64mm SS finish

JL-HDB76PSS 76mm PSS finish
 JL-HDB76PVD 76mm PVD brass finish
 JL-HDB76SS 76mm SS finish

JL-HDB102PSS 102mm PSS finish
 JL-HDB102PVD 102mm PVD brass finish
 JL-HDB102SS 102mm SS finish

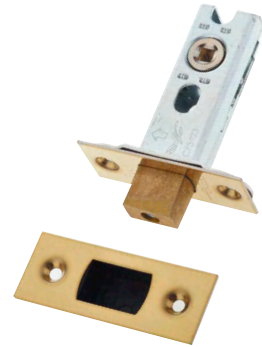

BODIES ONLY

JL-HDT64 64mm
 JL-HDT76 76mm
 JL-HDT102 102mm

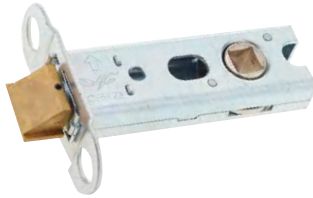

BODIES ONLY

JL-HDB64 64mm
 JL-HDB76 76mm
 JL-HDB102 102mm



ACCESSORY PACKS FOR HD LATCHES



JL-ACTAB Antique Brass finish
 JL-ACTBL Black finish
 JL-ACTPSS PSS finish
 JL-ACTPVD PVD brass finish
 JL-ACTSS SS finish
 JL-ACTRPSS PSS finish Radiused
 JL-ACTRPVD PVD brass finish Radiused
 JL-ACTRSS SS finish Radiused

ACCESSORY PACKS FOR HD DEADBOLTS



JL-ACDAB Antique Brass finish
 JL-ACDBL Black finish
 JL-ACDPSS PSS finish
 JL-ACDPVD PVD brass finish
 JL-ACDSS SS finish
 JL-ACDRPSS PSS finish Radiused
 JL-ACDRPVD PVD brass finish Radiused
 JL-ACDRSS SS finish Radiused

TUBULAR LATCH



JL120NP 63mm
 JL121NP 76mm
 JL122EB 63mm
 JL123EB 76mm

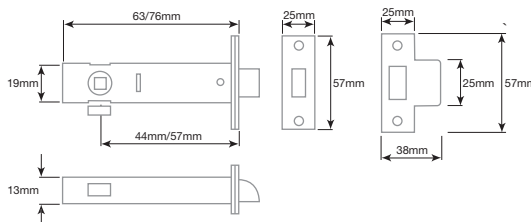

ACCESSORIES FOR TUBULAR LATCH

REBATE KITS
 JL139EB 13mm
 JL139NP 13mm

TUBULAR LATCH

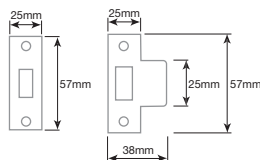
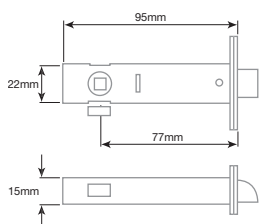

ACCESSORIES FOR JL1444

REBATE KITS
 JL139EB 13mm JL144EB 95mm
 JL139NP 13mm JL144NP 95mm



DOUBLE SPRUNG TUBULAR LATCH



JL6666S-80 80mm PB/SC
 JL6666S-100 100mm PB/SC
 JL6666S-150 150mm PB/SC

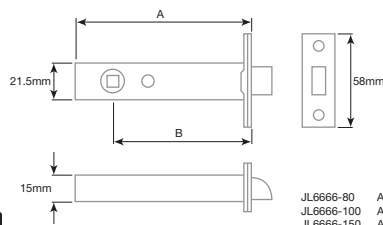

JL6666-80 A=f
 JL6666-100 A=f
 JL6666-150 A=f

JL6666S-80 A=80mm B= 60mm
 JL6666S-100 A=100mm B= 75mm
 JL6666S-150 A=150mm B= 130mm

ACCESSORIES FOR JL6666

REBATE KITS
 JL6666B-REB 13mm PB
 JL6666S-REB 13mm SC

RADIUS FORENDS
 JL6666BS- RAD PB & SC

TUBULAR DEADBOLT 5mm SPINDLE

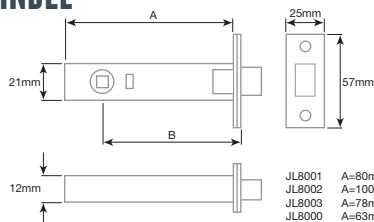

JL8001 A=90mm B=60mm
 JL8002 A=100mm B=75mm
 JL8003 A=78mm B=57mm
 JL8000 A=63mm B=44mm

JL8001PBSC matching JL6666S-80
 JL8002PBSC matching JL6666S-100

JL8003EBNP matching JL121/123
 JL8000PBSC matching JL120/122

NIGHT LATCHES

ROLLER BOLT NIGHTLATCH

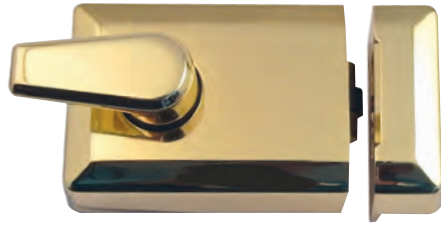

JL5011PB
JL5011PC
JL5011SC

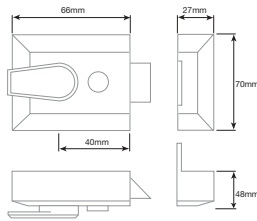
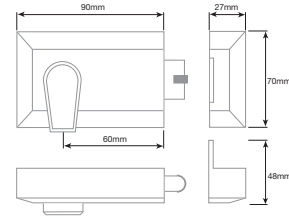

NARROW STILE NIGHTLATCH



JL5031PB
JL5031PC
JL5031SC



STANDARD STILE NIGHTLATCH



JL5021PB
JL5021PC
JL5021SC

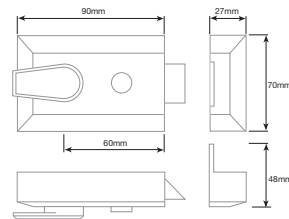

5 PIN RIM CYLINDERS



TO DIFFER

JL-5PRCPB Rim cylinder PB
JL-5PRCPC Rim cylinder PC
JL-5PRCSC Rim cylinder SC

KEYED ALIKE

JL-5PRCPB-KA Rim cylinder KA PB
JL-5PRCPC-KA Rim cylinder KA PC
JL-5PRCSC-KA Rim cylinder KA SC

STANDARD STILE BUDGET NIGHTLATCH



JL5041CN

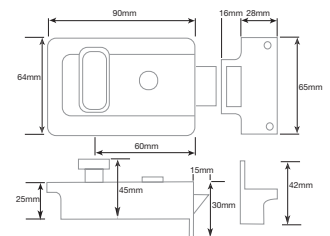

See page 180 for MK suite

RIM LOCKS

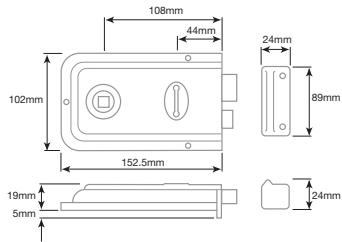

JL180PB
JL185EB
JL186PC
JL187GY
JL188SC
JL189BL



RIM LATCHES

JL181EB
JL181PC
JL181SC

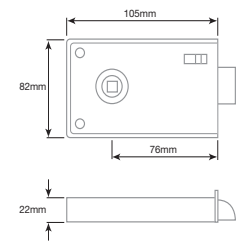
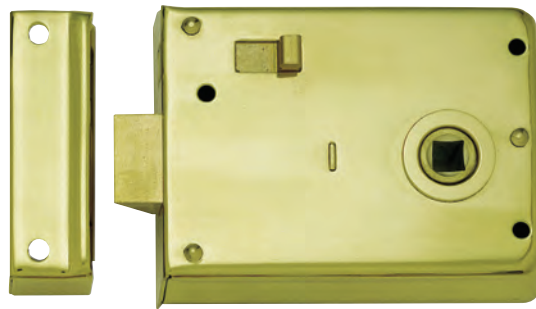

ROLLERBOLT CATCH

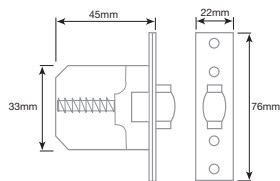

JL8090SB
JL8091SS

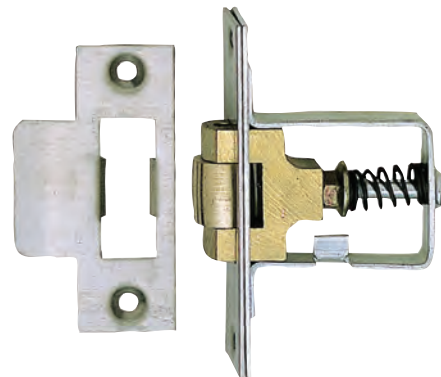

FIRE BRIGADE LOCKS



ADJUSTABLE ROLLERBOLT CATCH BRASS ROLLER



J8072PB
J8073SN

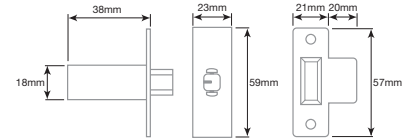

J8074EB
J8075PC



ADJUSTABLE ROLLERBOLT CATCH NYLON ROLLER

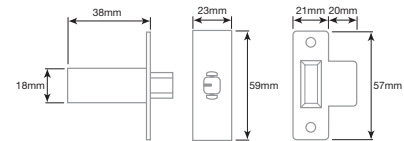

BUDGET LOCKS & ACCESSORIES

RIM BUDGET LOCK



JL200ZP

MORTICE BUDGET LOCK C/W KEY

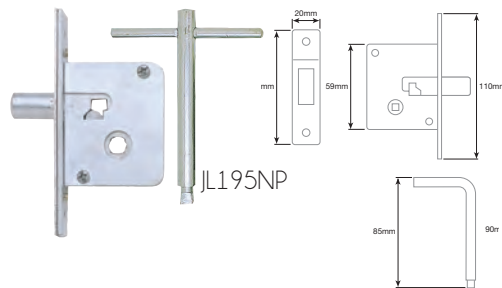

JL195NP

RIM BUDGET LOCK C/W KEY

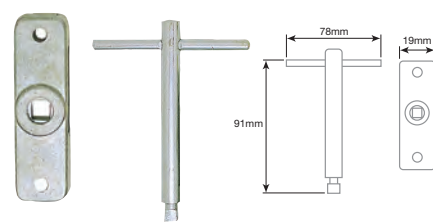

JL196NP

BUDGET LOCK ESCUTCHEON



JL198E-NP

BUDGET LOCK KEY



JL197K

BUDGET T BAR KEY



JL200K

BUDGET LOCK STRIKE PLATE



JL199S-NP

FIRE BRIGADE LOCKS

FIRE BRIGADE PADLOCKS

FB PADLOCK



JLFB

JLFBK
KEY FOR FB
PADLOCK



FB11 PADLOCK



JLFB11

JLFB11K
KEY FOR FB11
PADLOCK



FB14 PADLOCK



JLFB14

JLFB14K KEY FOR
FB14 PADLOCK



FIRE BRIGADE LOCKS



JLFB1 LOCK
JLFB1K KEY FOR FB1 LOCK
JLFB2 FB2 LOCK
JLFB2K KEY FOR FB2 LOCK



JLFBRCK
13MM RIM
CONVERSION KIT

JLFBREB
13MM REBATE KIT

FB SLAMLOCK

JLFB4 REPLACEMENT BODY ONLY



JLFB4K KEY FOR FB4 SLAMLOCK



DROP KEY



JLFBDK

MECHANICAL DIGITAL DOOR LOCKS

JEDGO
collection

STANDARD DIGITAL LOCK C/W LATCH

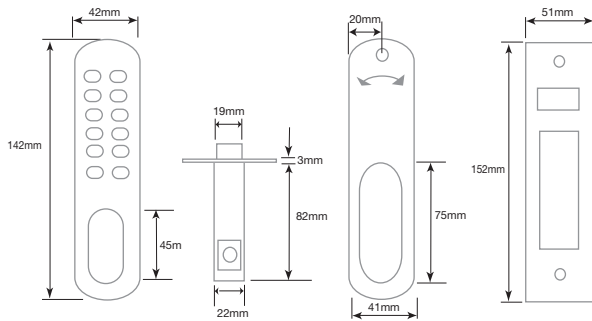
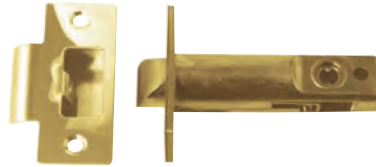

JL2010EB
JL2010SE



DIGITAL LOCK WITH HOLDBACK C/W LATCH

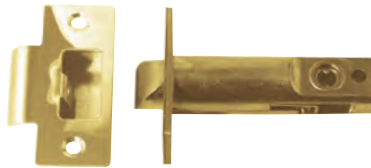

JL2020EB
JL2020SE

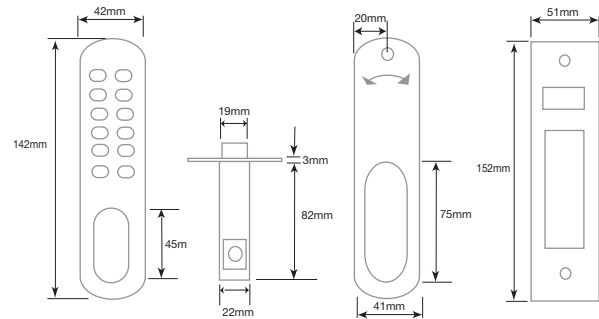

BATHROOM SLIDING DOOR LOCKS

BATHROOM SLIDING DOOR KIT CIRCULAR FURNITURE

C/W FLUSH EDGE PULL FOR DOOR THICKNESS 40/45mm & 35/38mm

- JV825PC - 40/45mm
- JV825SC - 40/45mm
- JV821PC - 35/38mm
- JV821SC - 35/38mm

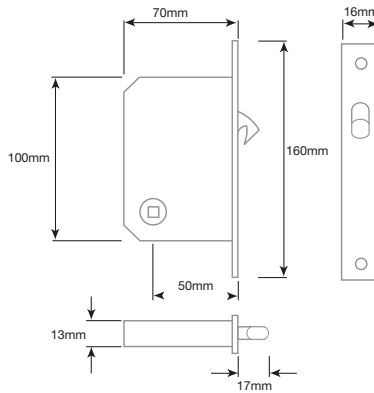

BATHROOM SLIDING DOOR KIT SQUARE FURNITURE

C/W FLUSH EDGE PULL FOR DOOR THICKNESS 40/45mm & 35/38mm

- JV829PC - 40/45mm
- JV829SC - 40/45mm
- JV827PC - 35/38mm
- JV827SC - 35/38mm

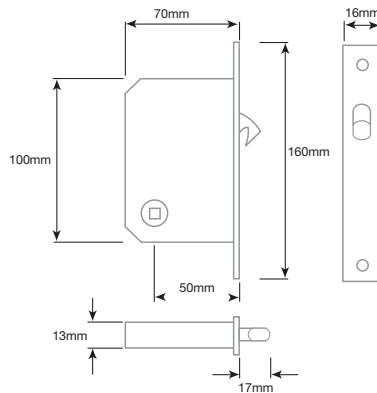

EDGE FLUSH PULL ONLY



- JV824PC ROUND
- JV824SC ROUND
- JV828PC SQUARE
- JV828SC SQUARE

CIRCULAR FLUSH PULL KIT

FOR DOOR THICKNESS OVER 30mm



- JV822PC
- JV822SC

SQUARE FLUSH PULL KIT

FOR DOOR THICKNESS OVER 30mm

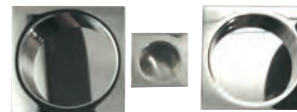

- JV823PC
- JV823SC

POSITION TOOL FOR LOCKS



SECONDARY SECURITY FITTINGS

PATIO DOOR LOCKS



JL1820WH
White

JL1820SE
Silver

HINGE BOLTS

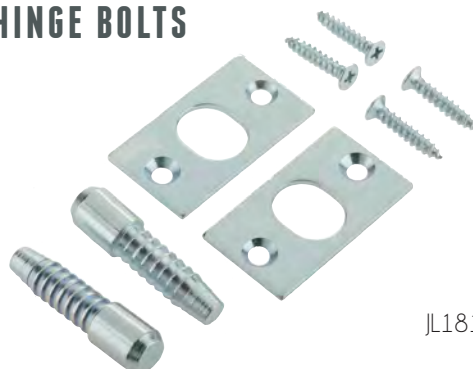

JL1815ZP

NARROW LOCKING FITCH FASTNERS



JL1817PB
Polished Brass

JL1817PC
Polished Chrome

JL1817SC
Satin Chrome

JL1817WH
White

WINDOW SECURITY LOCKS



JL1819WH
White

MULTI PURPOSE BOLTS



JL1816PC
Polished Chrome

JL1816SC
Satin Chrome

JL1816WH
White

NARROW FITCH FASTNERS



JL1818PB
Polished Brass

JL1818PC
Polished Chrome

JL1818SC
Satin Chrome

JL1818WH
White

LOCKING ESPAGNOLETTE BOLTS

For use on either doors or windows our espagnolette bolts are available in a range of styles and finishes.



LOCKING ESPAGNOLETTE BOLTS

C/W Locking Attachment To Suit Maximum Door Height 2400mm

JV1000PB

SPARES FOR JV1000PB

MECHANISM ONLY	JV1000MPB
BARS ONLY (EACH)	JV1000BOPB
CENTRES GUIDES (EACH)	JV1000CGPB
END GUIDES (PAIR)	JV1000EGPB
ANGLE PLATES (EACH)	JV1000APPB
FLAT PLATES (PAIR)	JV1000FPPB



C/W Locking Attachment To Suit Maximum Door Height 2400mm

JV1000PC

SPARES FOR JV1000PC

MECHANISM ONLY	JV1000MPC
BARS ONLY (EACH)	JV1000BOPC
CENTRE GUIDES (EACH)	JV1000CGPC
END GUIDES (PAIR)	JV1000EGPC
ANGLE PLATES (EACH)	JV1000APPC
FLAT PLATES (PAIR)	JV1000FPPC



C/W Locking Attachment To Suit Maximum Door Height 2400mm

JV1000SC

SPARES FOR JV1000SC

MECHANISM ONLY	JV1000MSC
BARS ONLY (EACH)	JV1000BOSC
CENTRE GUIDES (EACH)	JV1000CGSC
END GUIDES (PAIR)	JV1000EGSC
ANGLE PLATES (EACH)	JV1000APSC
FLAT PLATES (PAIR)	JV1000FPSC

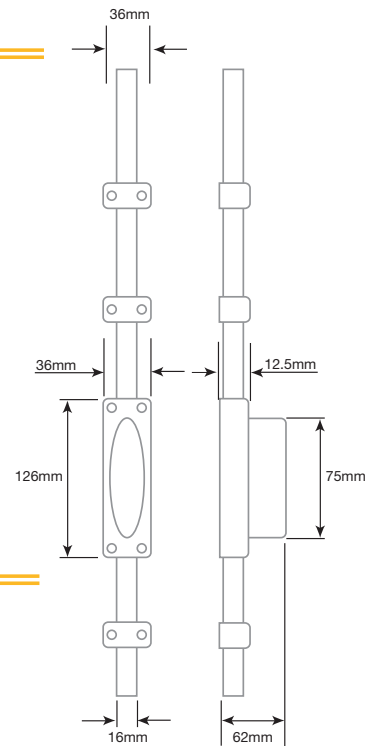

LOCKING ESPAGNOLETTE BOLTS

C/W Euro Profile Cylinder To Suit Maximum Door Height 2400mm

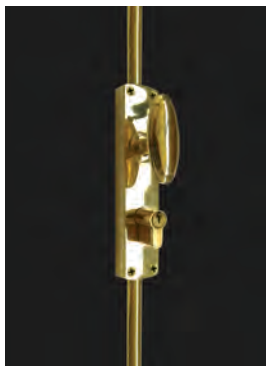

JV2000PB

SPARES FOR JV2000PB

MECHANISM ONLY	JV2000MPB
BARS ONLY (EACH)	JV2000BOPB
CENTRES GUIDES (EACH)	JV1000CGPB
END GUIDES (PAIR)	JV1000EGPB
ANGLE PLATES (EACH)	JV1000APPB
FLAT PLATES (PAIR)	JV1000FPPB
70 x 30mm CYLINDER ONLY	JV2002PB

C/W Euro Profile Cylinder To Suit Maximum Door Height 2400mm



JV2000PC

SPARES FOR JV2000PC

MECHANISM ONLY	JV2000MPC
BARS ONLY(EACH)	JV2000BOPC
CENTRES GUIDES (EACH)	JV1000CGPC
END GUIDES (PAIR)	JV1000EGPC
ANGLE PLATES (EACH)	JV1000APPC
FLAT PLATES (PAIR)	JV1000FPPC
70 x 30mm CYLINDER ONLY	JV2002PC

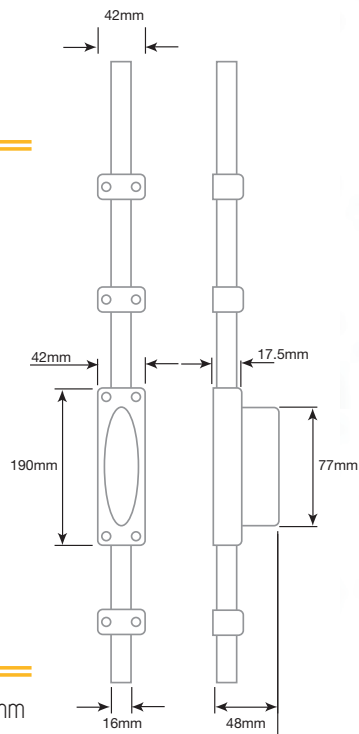

C/W Euro Profile Cylinder To Suit Maximum Door Height 2400mm



JV2000SC

SPARES FOR JV2000SC

MECHANISM ONLY	JV2000MSC
BARS ONLY (EACH)	JV2000BOSC
CENTRES GUIDES (EACH)	JV1000CGSC
END GUIDES (PAIR)	JV1000EGSC
ANGLE PLATES (EACH)	JV1000APSC
FLAT PLATES (PAIR)	JV1000FPSC
70 x 30mm CYLINDER ONLY	JV2002SC

ESPAÑOLETE BOLTS

C/W LOCKING ATTACHMENT TO SUIT MAXIMUM HEIGHT 2400mm

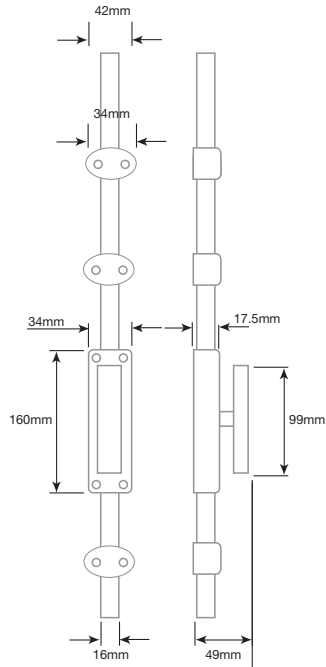

JV617PB



JV617PC



JV617SC

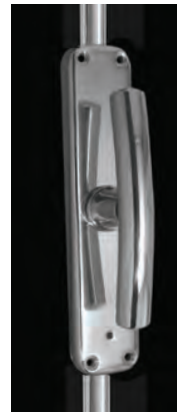
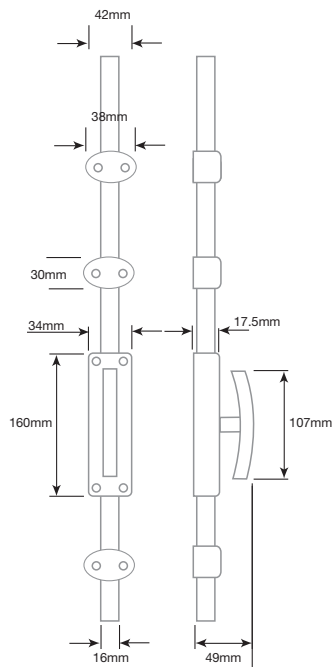

JV633PC



JV633SC



JV633PB

ESPAGNOLETTE BOLTS

C/W LOCKING ATTACHMENT TO SUIT MAXIMUM HEIGHT 2400mm



Jv3400PC



Jv3400PB



Jv3400SC

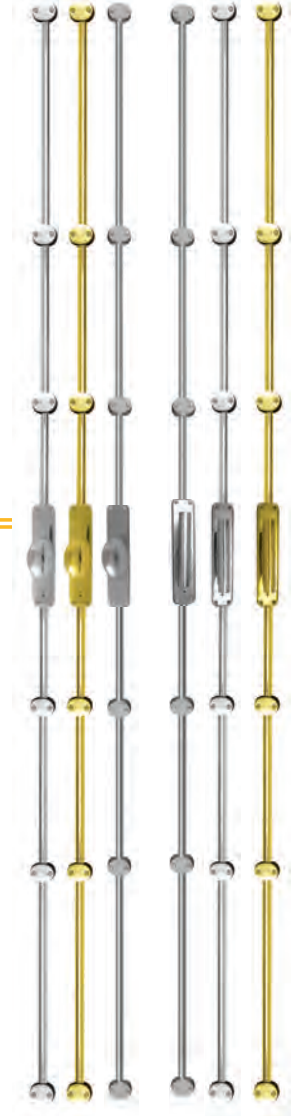
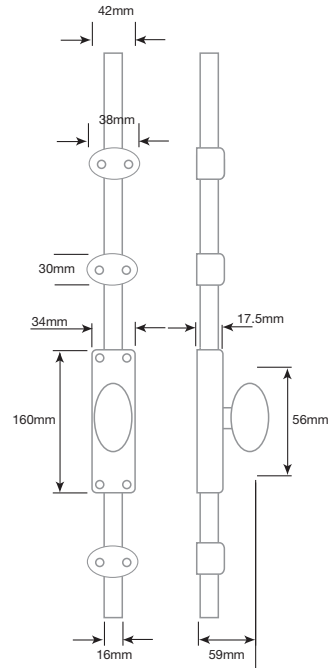

Jv662PC



Jv662PB



Jv662SC

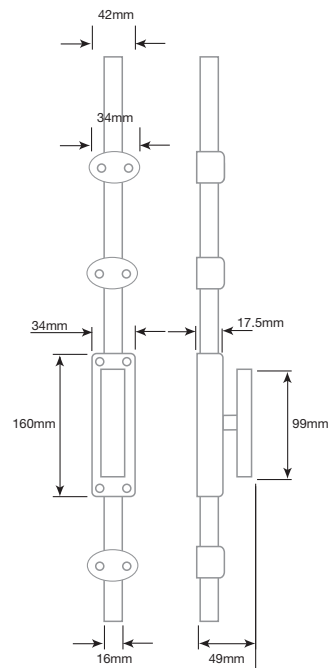

HINGES

A comprehensive range of hinges manufactured from brass, steel and stainless steel to satisfy the requirements of both domestic and commercial properties.



STAINLESS STEEL HINGES

SELF LUBRICATING HINGE c/w screws

102mm x 76mm x 3mm



J2050PSS



200,000 CYCLES
SUITABLE FOR 120kg DOORS
GRADE 4 CORROSION



J2050SSS

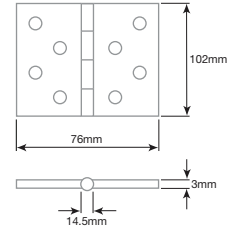

RADIUSED SELF LUBRICATING HINGE c/w screws

102mm x 76mm x 3mm (10mm Radius)

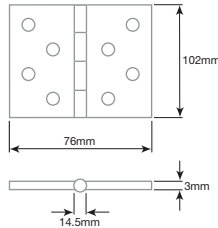

J2050RSSS



200,000 CYCLES
SUITABLE FOR 120kg DOORS
GRADE 4 CORROSION



J2050RPSS

BALL BEARING HINGE c/w screws 102mm x 76mm x 3mm

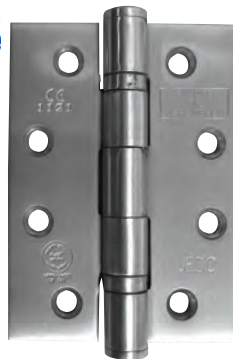
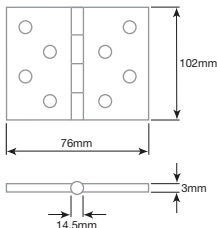

J9500SSS
Grade 202 SS
J9507SSS
Grade 316 SS
J9533SSS
Grade 202 SS
PACK OF 3



200,000 CYCLES
SUITABLE FOR 120kg DOORS
GRADE 4 CORROSION



J9500BL



J9500EB



J9500BR



J9500PSS

Grade 202 SS Grade 202 SS Grade 202 SS Grade 202 SS

J9507PSS
Grade 316 SS

STAINLESS STEEL HINGES

RADIUSED BALL BEARING HINGE c/w screws

102mm x 76mm x 3mm (10mm Radius)

200,000 CYCLES
SUITABLE FOR 120kg DOORS
GRADE 4 CORROSION

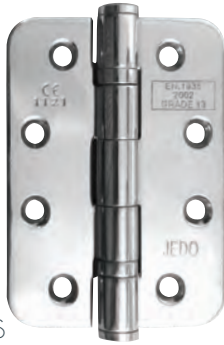
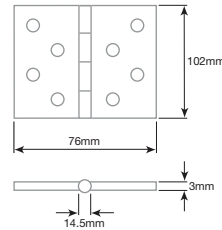

J9500RPSS
Grade 202 SS



J9500RSSS
Grade 202 SS

BALL BEARING HINGE c/w screws

102mm x 102mm x 3mm

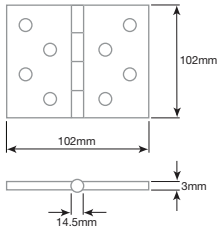

J9501PSS
Grade 202 SS



J9501SSS
Grade 202 SS



BALL BEARING HINGE c/w screws

76mm x 50mm x 2mm

200,000 CYCLES
SUITABLE FOR 40kg DOORS
GRADE 4 CORROSION

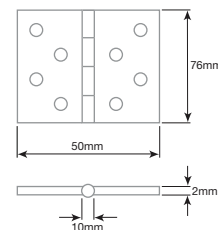

J9502EB
Grade 202 SS

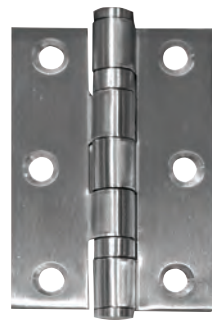

J9502SSS
Grade 202 SS



J9502PSS
Grade 202 SS

STAINLESS STEEL HINGES

STAINLESS STEEL WASHERED HINGE c/w screws

102mm x 76mm x 2mm

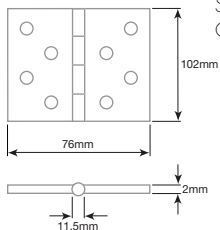

200,000 CYCLES
SUITABLE FOR 40kg DOORS
GRADE 4 CORROSION



J9505PSS



J9505SSS

STAINLESS STEEL WASHERED HINGE c/w screws

76mm x 50mm x 2mm



200,000 CYCLES
SUITABLE FOR 40kg DOORS
GRADE 4 CORROSION

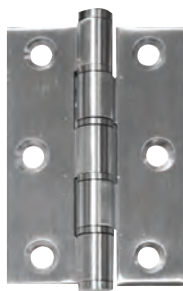

J9504SSS
Grade 202 SS



J9504PSS
Grade 202 SS

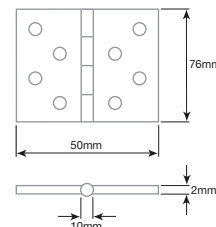

RISING BUTT HINGE c/w screws

102mm x 76mm x 3mm

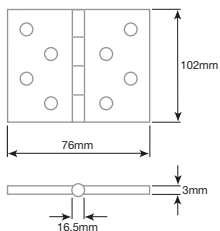

left hand
pictured)

J9510LHPSS
J9510RHPPSS



right hand
pictured)

J9510LHSSS
J9510RHSSS

CONCEALED BEARING HINGE c/w screws

102mm x 76mm x 3mm

200,000 CYCLES
SUITABLE FOR 120kg DOORS
GRADE 4 CORROSION



J2020PSS



J2020SSS

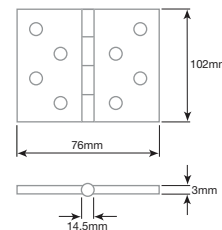

STAINLESS STEEL HINGES

S.S.S BALL BEARING PARLIAMENT HINGE



J9469 SSS
102 X 152 X 3mm



J9459 SSS
102 X 127 X 3mm



J9449 SSS
102 X 102 X 3mm

STAINLESS STEEL POLYMER BEARING HINGE



J9603PSS
J9603SSS
102 X 76 X 3mm 3 Knuckle

J9633SSS (PACK OF 3 HINGES)
102 X 76 X 3mm Radius 3 Knuckle

J9604PSS
J9604SSS
102 X 102 X 3mm 5 Knuckle

J9606PSS
J9606SSS
102 X 76 X 3mm 5 Knuckle



STEEL HINGES (not recommended for exterior use)

CONCEALED BEARING HINGE c/w screws
102mm x 76mm x 3mm



200,000 CYCLES
SUITABLE FOR 100kg DOORS
GRADE 4 CORROSION

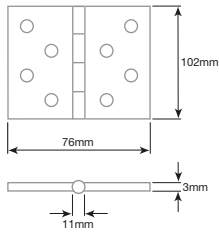

J7500SN



J7500SC



J7500PC



J7500EB

BALL BEARING HINGE c/w screws
102mm x 76mm x 2.7mm



200,000 CYCLES
SUITABLE FOR 80kg DOORS
GRADE 4 CORROSION



J8500BR



J8500PC



J8500SC



J8500BL



J8500SN



J8500EB

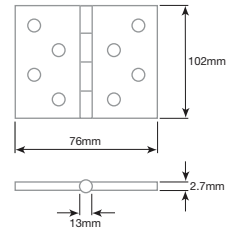

RADIUSED BALL BEARING HINGE c/w screws
102mm x 76mm x 2.7mm (10mm radius)



200,000 CYCLES
SUITABLE FOR 80kg DOORS
GRADE 4 CORROSION

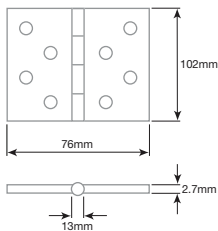

J8500RSN



J8500RPC

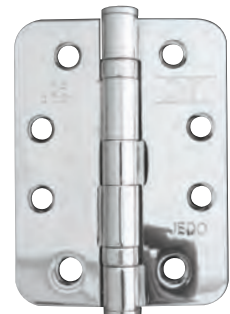

STEEL HINGES (NOT RECOMMENDED FOR EXTERIOR USE)

NOT TESTED

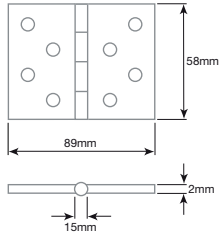

58 x 89 x 2mm
 J8501BL
 J8501EB
 J8501PC
 J8501SC
 J8501SN



BALL BEARING HINGE c/w screws

200,000 CYCLES
 SUITABLE FOR 40kg DOORS
 GRADE 4 CORROSION

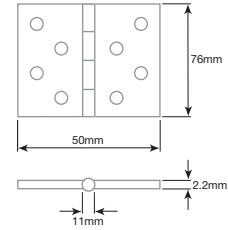

76 x 50 x 2.2mm
 J8502BL
 J8502BR
 J8502EB
 J8502PC
 J8502SC
 J8502SN



SPRING HINGE c/w screws 102mm x 76mm x 2.7mm 3 Hinge Pack

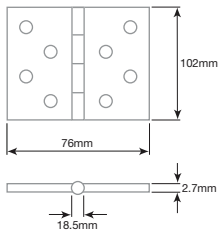

J9800PC

Included in a successful 30 minute fire test

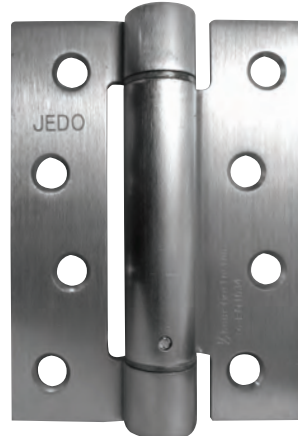

J9800SC



J9800EB

STEEL HINGES (NOT RECOMMENDED FOR EXTERIOR USE)

HEAVY DUTY BUTTON TIP HINGE c/w screws

102mm x 75mm x 2.5mm



200,000 CYCLES

SUITABLE FOR 40kg DOORS
GRADE 3 CORROSION

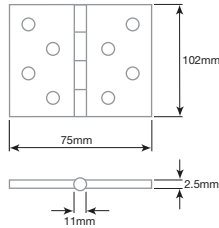

J451BT-EB
J451BT-PC
J451BT-SC
J451BT-SN

HEAVY DUTY BUTTON TIP HINGE c/w screws

76mm x 50mm x 2mm



NOT TESTED



J452BT-EB
J452BT-PC
J452BT-SC
J452BT-SN

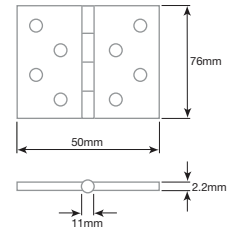

HEAVY DUTY STEEL HINGE

102mm x 76mm x 2.5mm

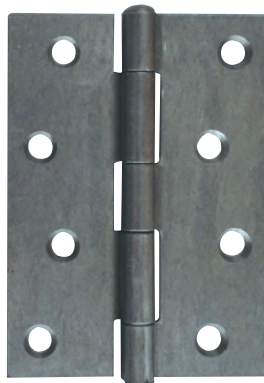

J451ZP

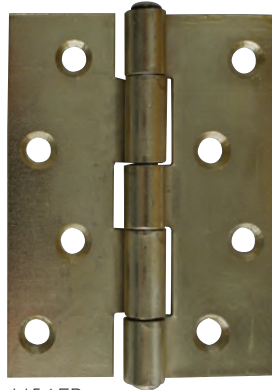

J451EB



J451 (Self colour)

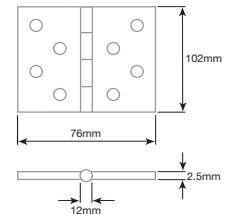

STEEL BUTT HINGE

102mm x 76mm x 2.5mm

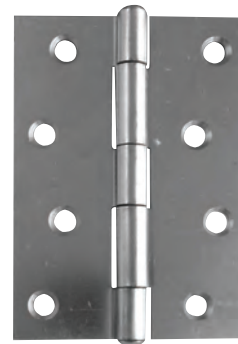
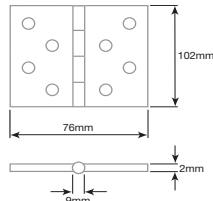
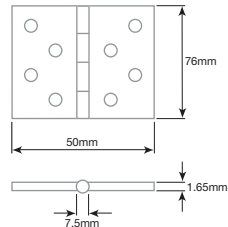

J1838-FZP 102mm ZP
J1838-DZP 76mm ZP

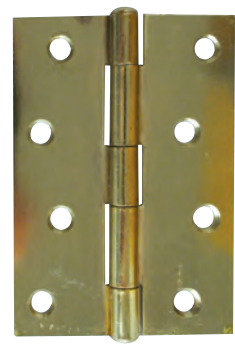

J1838FEB 102mm EB
J1838DEB 76mm EB

STEEL HINGES (NOT RECOMMENDED FOR EXTERIOR USE)

LOOSE PIN HINGE



102mm x 75mm x 2mm
 J1841FEB EB Finish
 J1841JZP ZP Finish
 J1841FBL BL Finish

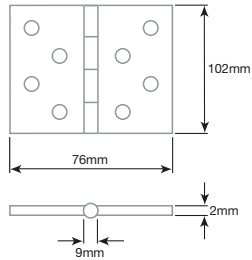

76mm x 50mm x 1.65mm
 J1841DEB EB Finish
 J1841CZP ZP Finish

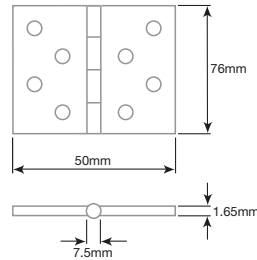

Polished Brass

	Max door Weight	Max door Width	Door Thickness
HB3003-3PB - 75mm	15kg	600mm	18-25mm
HB3003-4PB - 100mm	22kg	700mm	25-30mm
HB3003-5PB - 125mm	27kg	700mm	30-35mm
HB3003-6PB - 150mm	40kg	750mm	35-40mm

Silver Sprayed

	Max door Weight	Max door Width	Door Thickness
HG3003-3GY 75mm	15kg	600mm	18-25mm
HG3003-4GY 100mm	22kg	700mm	25-30mm
HG3003-5GY 125mm	27kg	700mm	30-35mm
HG3003-6GY 150mm	40kg	750mm	35-40mm

SINGLE ACTION SPRING HINGES



Polished Brass

	Max door Weight	Max door Width	Door Thickness
HB3005-3PB 75mm	15kg	600mm	18-25mm
HB3005-4PB 100mm	22kg	700mm	25-30mm
HB3005-5PB 125mm	27kg	700mm	30-35mm
HB3005-6PB 150mm	40kg	750mm	35-40mm

Silver Sprayed

	Max door Weight	Max door Width	Door Thickness
HG3005-3GY 75mm	15kg	600mm	18-25mm
HG3005-4GY 100mm	22kg	700mm	25-30mm
HG3005-5GY 125mm	27kg	700mm	30-35mm
HG3005-6GY 150mm	40kg	750mm	35-40mm
HG3005-7GY 175mm	55kg	850mm	40-45mm

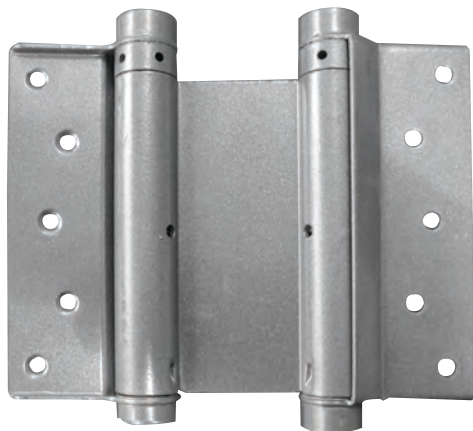

DOUBLE ACTION SPRING HINGES

BRASS HINGES

DOUBLE PHOSPHOR BRONZE WASHERED c/w screws

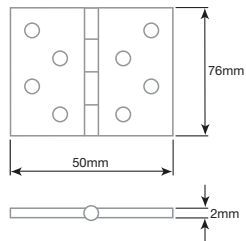
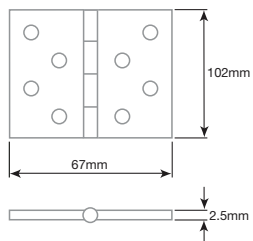

J9120BSC
102mm

J9121BSC
76mm



J9120BPC
102mm

J9121BPC
76mm



POLISHED BRASS BALL BEARING HINGE c/w screws

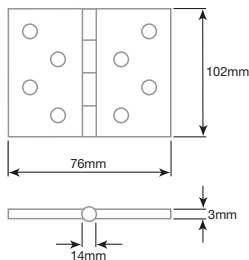
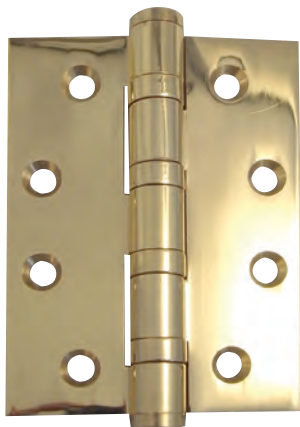

J9050PB

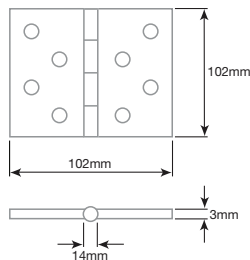

J9051PB

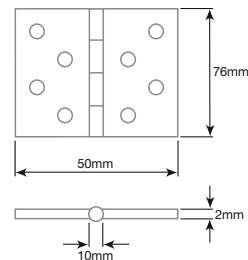

J9052PB



BRONZE HINGE PHOSPHOR BRONZE WASHERED c/w screws

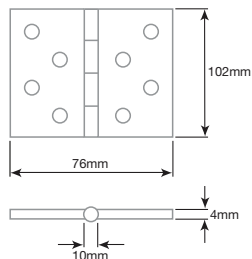

J6007AB

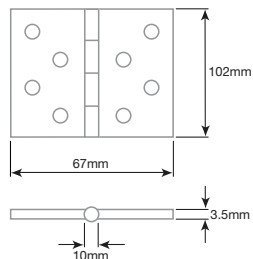

J6012AB

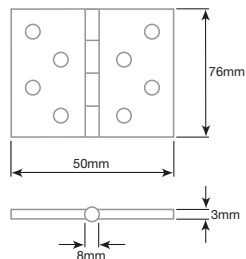

J6016AB

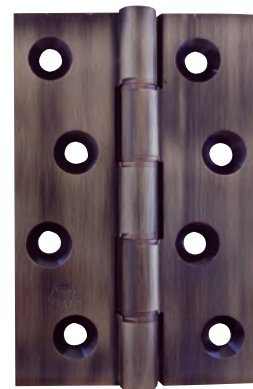

BRASS HINGES



SATIN CHROME HINGE PHOSPHOR BRONZE WASHED c/w screws

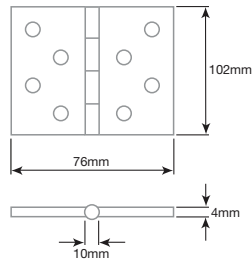

J9312SC

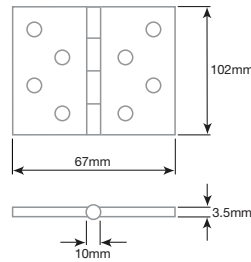

J9311SC

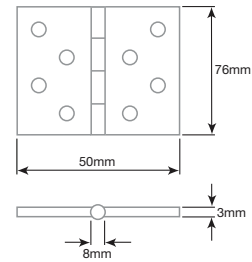

J9310SC



POLISHED & LACQUERED BRASS HINGE DOUBLE PHOSPHOR BRONZE WASHED c/w screws

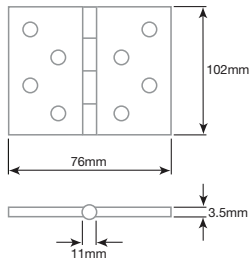

J9007PB

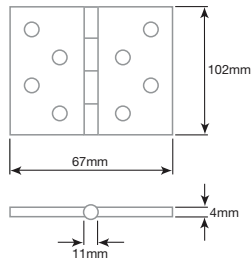

J9012PB

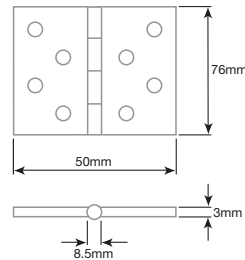

J9016PB



POLISHED CHROME HINGES DOUBLE PHOSPHOR BRONZE WASHED c/w screws

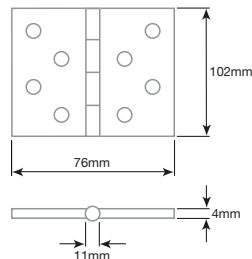

J9118BPC

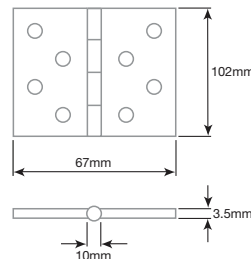

J9117BPC

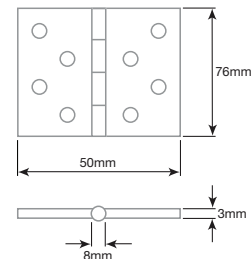

J9116BPC

BRASS HINGES

POLISHED & LACQUERED BRASS HINGE DOUBLE PHOSPHOR BRONZE WASHERED c/w screw

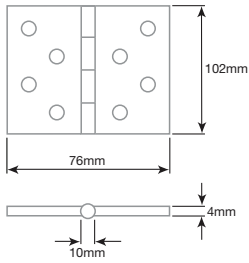

J7007PB

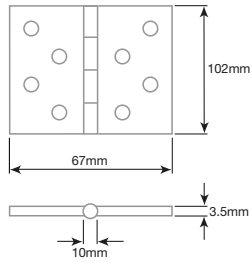

J7012PB

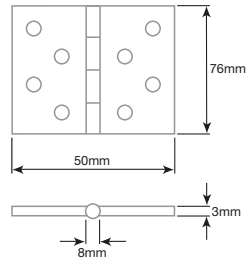

J7016PB



POLISHED & LACQUERED BRASS HINGE DOUBLE STEEL WASHERED c/w screws

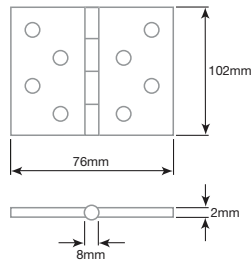
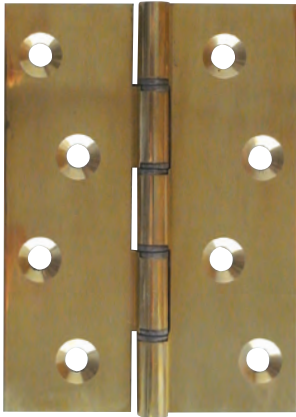

J9004PB

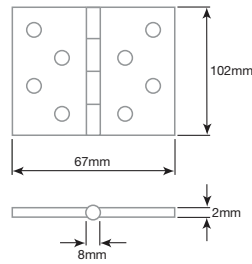

J9003PB

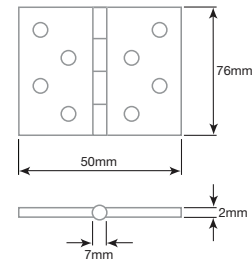

J9002PB

POLISHED CHROME ON BRASS HINGE c/w screws

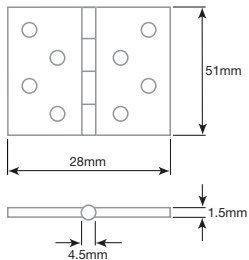

J9112PC

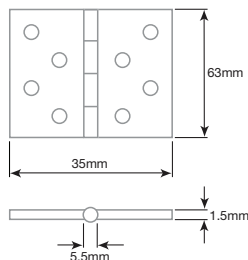

J9113PC

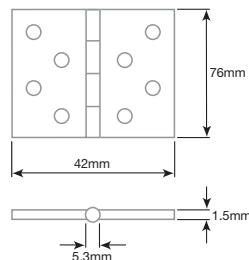

J9114PC 

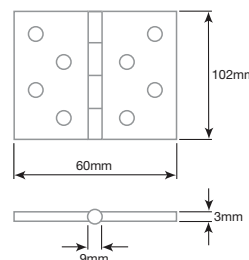

J9115PC 



BRASS HINGES

CROWN PARLIAMENT HINGE *c/w screws*

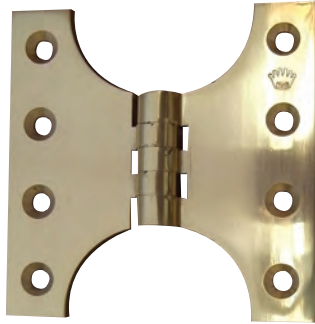

J9009C4PB
J9009C4PC
J9009C4SC

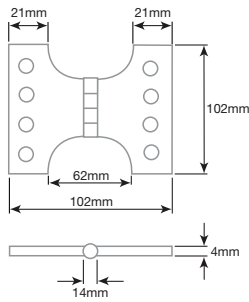

J9009C5PB
J9009C5PC
J9009C5SC

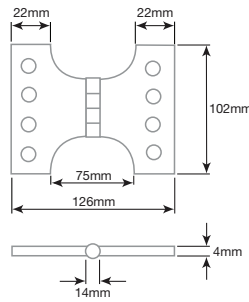

J9009C6PB
J9009C6PC
J9009C6SC

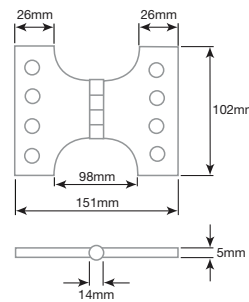

J9009B4PB
J9009B4PC
J9009B4SC

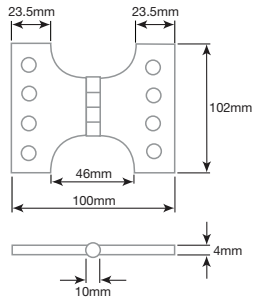

J9009B5PB
J9009B5PC
J9009B5SC

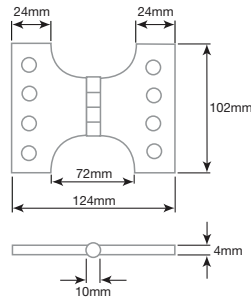

J9009B6PB
J9009B6PC
J9009B6SC

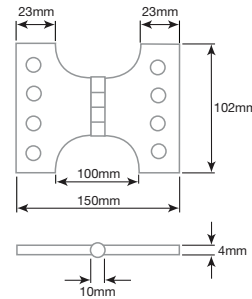

BUDGET PARLIAMENT HINGE *c/w screws*

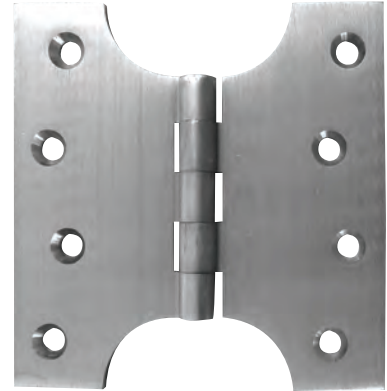

COUNTER FLAP HINGE *c/w screws*



J9020PB

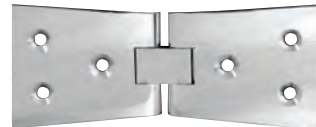

J9020PC



J9020SC

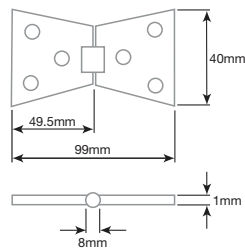

COUNTER FLAP CATCH



JV73PB
JV73PC
JV73SC

BRASS HINGES

POLISHED & LACQUERED BRASS PROJECTION HINGES c/w screws

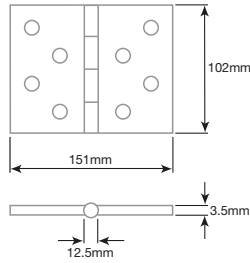

J9036PB
J9036PC
J9036SC

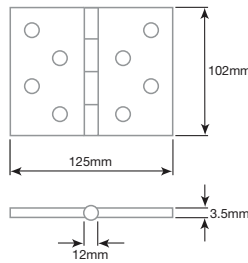

J9035PB
J9035PC
J9035SC

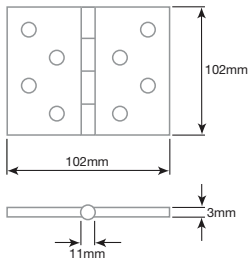

J9026PB
J9026PC
J9026SC

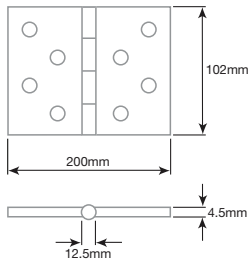

J9037PB
J9037PC
J9037SC

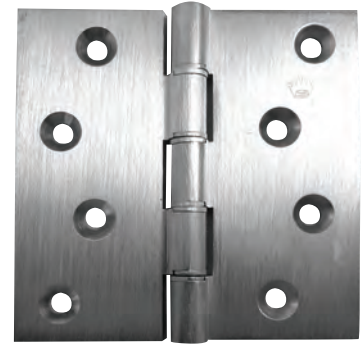

SOLID DRAWN SELF COLOUR BRASS HINGE

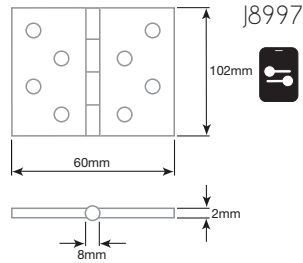

J8997

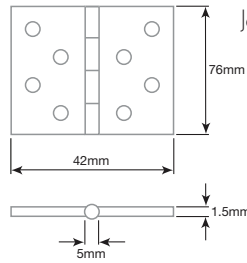

J8996

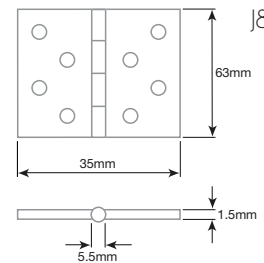

J8995

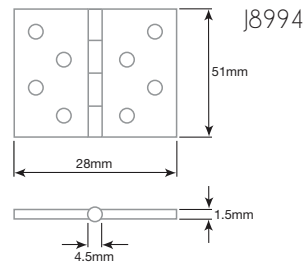

J8994

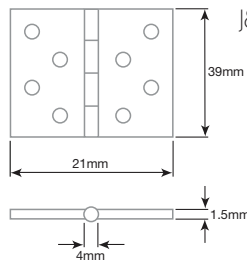

J8993

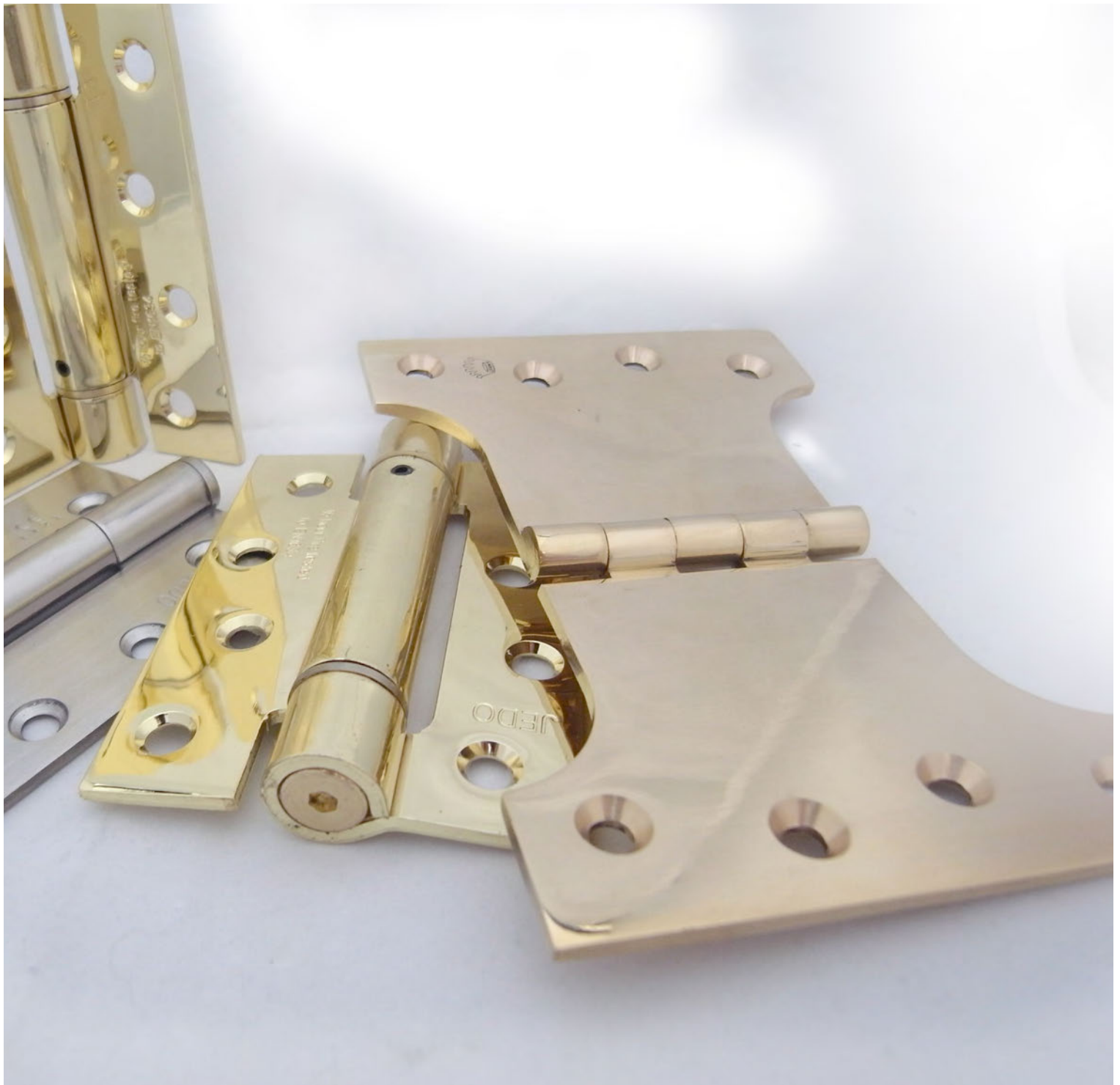

DOOR CONTROLS



A selection of surface mounted and concealed door controls for both domestic and commercial applications

DOOR CONTROLS

STANDARD DOOR CLOSER

EN1154

CE

FD
30/60

JEDGO
collection



Specification

Power size - adjustable by position EN-2/3/4

Adjustable closing speed

Adjustable latch action

Maximum door Width 1100mm

Maximum door weight 80kg

Universal application Figs 1, 61 and 66

JD150PB BLACK ARMS

JD150PN BLACK ARMS

JD150SE BLACK ARMS

JD150SN BLACK ARMS

DOOR CONTROLS

CONTRACT DOOR CLOSER



SPECIFICATION

adjustable power size EN-2 to EN-4
 adjustable closing speed
 adjustable latch action
 adjustable delayed action
 adjustable backcheck
 maximum door Width 1100mm
 maximum door weight 80kg
 universal application Figs 1,61 & 66

JD200PB MATCHING ARMS
 JD200PN MATCHING ARMS
 JD200SE MATCHING ARMS
 JD200SN MATCHING ARMS



SLIMLINE ARCHITECTURAL CLOSER



SPECIFICATION

adjustable power size EN-2 to EN-5
 adjustable closing speed
 adjustable latch action
 adjustable delayed action
 adjustable backcheck
 maximum door Width 1250mm
 maximum door weight 100kg
 universal application Figs 1,61 & 66

JD300SE MATCHING ARMS

DOOR CONTROLS

SURFACE MOUNTED DOOR CLOSERS

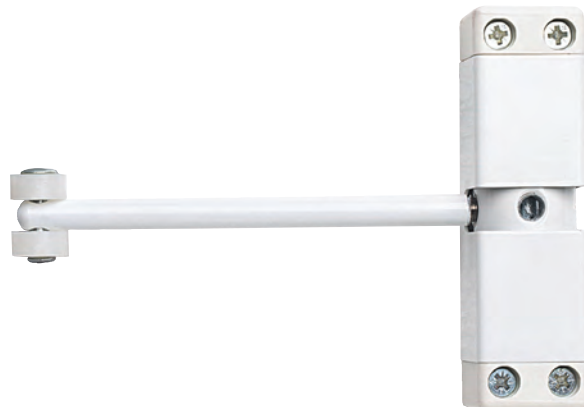

SPECIFICATION

Body size 105mm x 30mm x 30mm

Arm Length 118mm

Maximum door weight 50kg

JW901EB

JW901S

JW901WH

CONCEALED DOOR CLOSERS

SPECIFICATION

Barrel size 138mm x 22mm

Face plate 51mm x 25mm

Maximum door weight 50kg

JW900EB

JW900NP

JW900SC

JW900R-EB RADIUS PLATES

JW900R-NP RADIUS PLATES

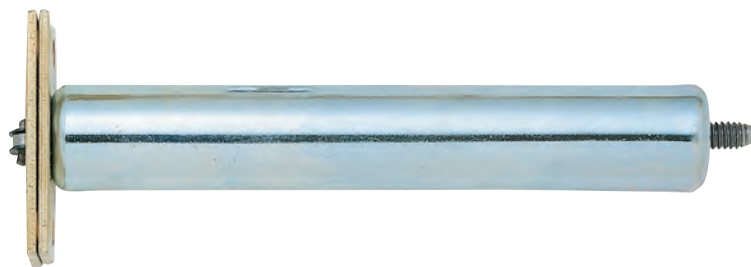

Included in a successful 30 minute fire test

DOOR SELECTOR

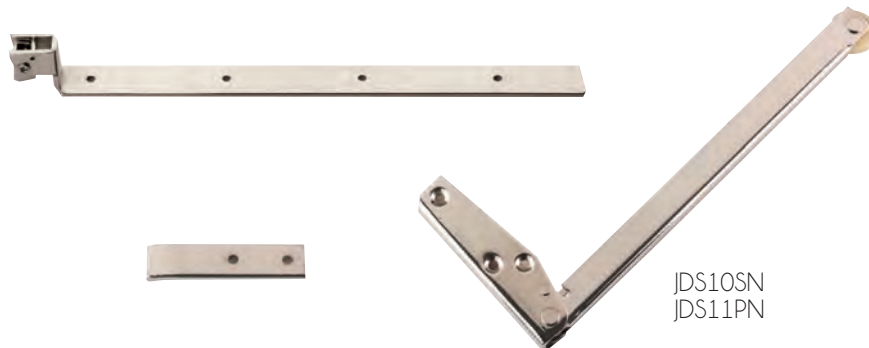

JDS10SN
JDS11PN

OVERHEAD DOOR STAY

30mm x 375mm



JDS20

WINDOW FURNITURE

Window fittings of both classic and modern styling for use with most window designs



WINDOW FURNITURE

NON LOCKABLE WINDOW STAY



JW77PB	250mm
JW77PC	250mm
JW77SC	250mm
JW77WH	250mm

Supplied, with
both flat and EJMA
fittings



LOCKABLE WINDOW STAY

JW77LPB	250mm
JW77LPC	250mm
JW77LSC	250mm
JW77LWH	250mm

Supplied, with
both flat and EJMA
fittings



NON LOCKABLE CASEMENT FASTENER

Handle 124mm Projection 30mm



JW78PB
JW78PC
JW78SC
JW78WH



All items supplied,
with both flat and
EJMA fittings

LOCKABLE CASEMENT FASTENER

Handle 124mm Projection 30mm



JW78LPB
JW78LPC
JW78LSC
JW78LWH



LOCKABLE ESPAGNOLETTE CASEMENT FASTENER

FOR WOODEN OR PVCu
FOR DIMENSIONS SEE PAGE 59



JW79LPB
JW79LPC
JW79LSC
JW79LWH



WINDOW FURNITURE

BULB END CASEMENT STAY



JV306APB 200mm
 JV306BPB 250mm
 JV306CPB 300mm
 JV306APC 200mm
 JV306BPC 250mm
 JV306CPC 300mm
 JV306ASC 200mm
 JV306BSC 250mm
 JV306CSC 300mm

JULIETTA WINDOW STAY



JV4925PB 250mm
 JV4925PC 250mm
 JV4925SC 250mm
 JV4925SN 250mm



JULIETTA CASEMENT FASTENER

Handle 115mm Projection 39mm

JV4917PB
 JV4917PC
 JV4917SC
 JV4917SN



BULB END CASEMENT FASTENER

Handle 100mm Projection 37mm

JV308PB
 JV308PC
 JV308SC

WINDOW FURNITURE

WINDOW STAY

- JV44APB 200mm
- JV44SPB 250mm
- JV44BPB 300mm
- JV44APC 200mm
- JV44SPC 250mm
- JV44BPC 300mm
- JV44ASC 200mm
- JV44SSC 250mm
- JV44BSC 300mm

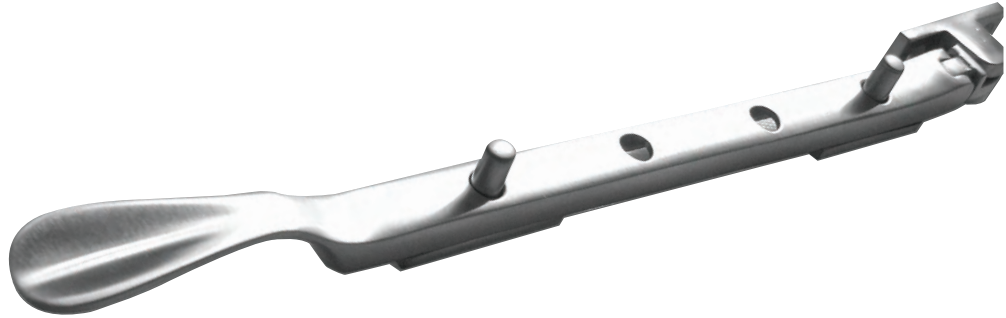

SLIDING SCREW DOWN STAY

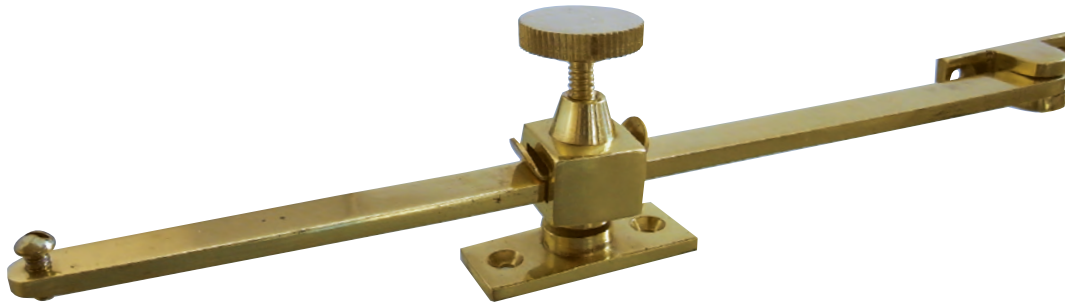

- JV150PB 250mm
- JV151PB 305mm

CASEMENT FASTENER

Handle 105mm Projection 33mm

- JV301PB
- JV301PC
- JV301SC



CASEMENT FASTENER

Handle 100mm Projection 34mm

- JV45RPB
- JV45RPC
- JV45RSC



WINDOW FURNITURE

BRIGHTON FASTENER



JV88PB 55mm
JV88PC 55mm
JV88SC 55mm
JV88SN 55mm

HEAVY BRIGHTON FASTENER

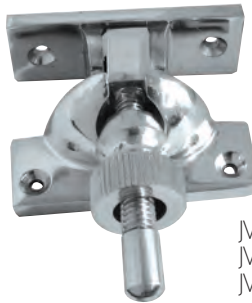

JV4288PB 58mm
JV4288PC 58mm
JV4288SC 58mm

LOCKABLE BRIGHTON SASH FASTENER

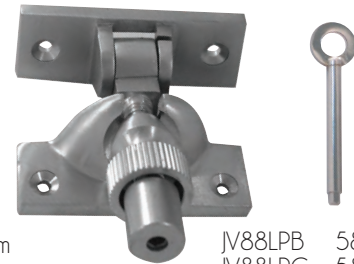

JV88LPB 58mm
JV88LPC 58mm
JV88LSC 58mm
JV88LSN 58mm

SASH FASTENER

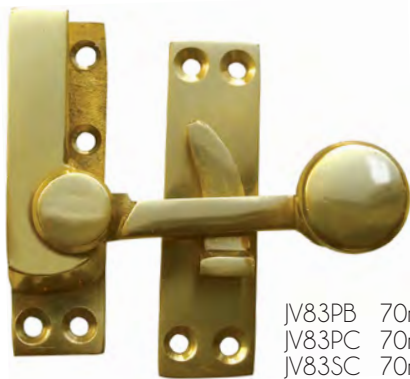

JV83PB 70mm
JV83PC 70mm
JV83SC 70mm

HEAVY QUADRANT SASH FASTENER



JV4200PB 70mm
JV4200PC 70mm
JV4200SC 70mm

LOCKABLE QUADRANT SASH FASTENER



JV4200LPB 70mm
JV4200LPC 70mm
JV4200LSC 70mm

NARROW FITCH FASTENER NON LOCKING



JV89NPB 65mm
JV89NPC 65mm
JV89NSC 65mm
JV89NSN 65mm

NARROW FITCH FASTENER LOCKING



JV89LPB 65mm
JV89LPC 65mm
JV89LSC 65mm

BUDGET FASTENER

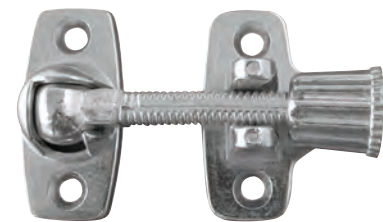

J490EB 45mm
J499ZP 45mm

WINDOW FURNITURE

LOCKING SASH STOPS AND KEYS

C/W 4 SCREWS & 2 BARRELS

JV4201PB
JV4201PC
JV4201SC

JV4201K
2 KEY PACK

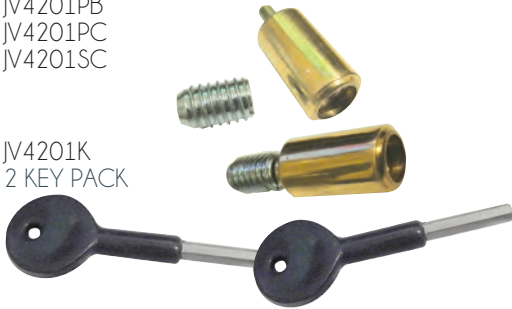

SASH LIFT

JV84PB 50mm
JV84PC 50mm
JV84SC 50mm
JV84SN 50mm



SASH HANDLE

JV194APB 100mm
JV194BPB 125mm
JV194CPB 150mm
JV194APC 100mm
JV194BPC 125mm
JV194CPC 150mm
JV194ASC 100mm
JV194BSC 125mm
JV194CSC 150mm



SASH PULLEY ZINC PLATED FACE & NYLON ROLLER

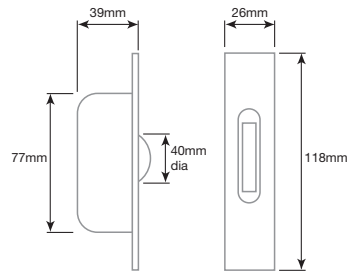

J992BZP



SASH PULLEY BRASS ROLLER

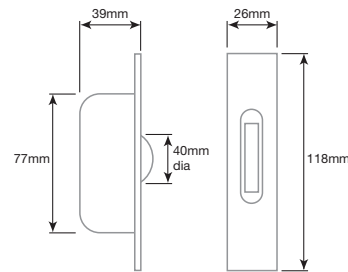

J993BPC
J994BSC
J995BPB



FANLIGHT CATCH

56mm x 36mm



JV1976PB
JV1976PC
JV1976SC

FANLIGHT CATCH

63mm



JV950PB
JV950PC
JV950SC

SASH PULLEY-BRASS ROLLER RADIUSED FACEPLATE

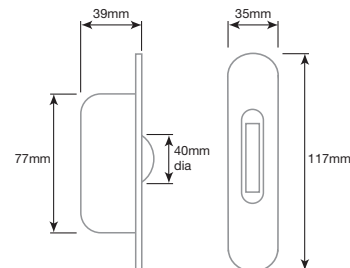

J996PB
J996PC
J996SC

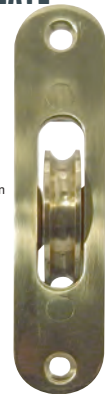

ACCESSORIES

A full range of accessories complementing our furniture to add those finishing touches.



STRAIGHT BRASS BARREL BOLT

J1001BA PB	J1001CA PC	J1001DA SC	38mm x 25mm
J1001BB PB	J1001CB PC	J1001DB SC	50mm x 25mm
J1001BC PB	J1001CC PC	J1001DC SC	64mm x 25mm
J1001BD PB	J1001CD PC	J1001DD SC	75mm x 25mm
J1001BE PB	J1001CE PC	J1001DE SC	100mm x 25mm
J1001BF PB	J1001CF PC	J1001DF SC	150mm x 25mm
J1001PB-4	J1001PC-4	J1001SC-4	100mm x 38mm
J1001PB-6	J1001PC-6	J1001SC-6	150mm x 38mm
J1001PB-8	J1001PC-8	J1001SC-8	200mm x 38mm



NECKED BRASS BARREL BOLT



J1002BB PB	J1002CB PC	J1002DB SC	50mm x 25mm
J1002BC PB	J1002CC PC	J1002DC SC	64mm x 25mm
J1002BD PB	J1002CD PC	J1002DD SC	75mm x 25mm
J1002BE PB	J1002CE PC	J1002DE SC	100mm x 25mm
J1002BF PB	J1002CF PC	J1002DF SC	150mm x 25mm
J1002PB-4	J1002PC-4	J1002SC-4	100mm x 38mm
J1002PB-6	J1002PC-6	J1002SC-6	150mm x 38mm
J1002PB-8	J1002PC-8	J1002SC-8	200mm x 38mm

STRAIGHT ALUMINIUM BARREL BOLT

J1001SB SAA	50mm x 25mm
J1001SC SAA	64mm x 25mm
J1001SD SAA	75mm x 25mm
J1001SE SAA	100mm x 25mm
J1001SF SAA	150mm x 25mm



NECKED ALUMINIUM BARREL BOLT



J1002SD SAA	75mm x 25mm
J1002SE SAA	100mm x 25mm
J1002SF SAA	152mm x 25mm

ACCESSORIES

STRAIGHT BELL SHAPE BRASS BOLT

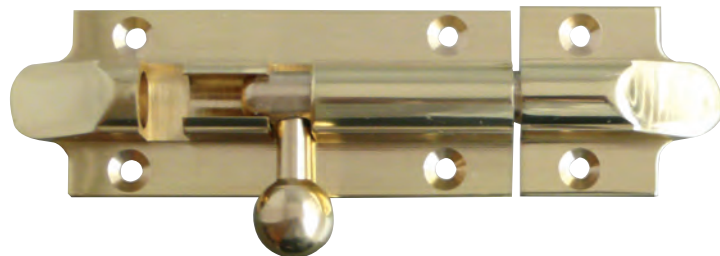

J1101-3PB	J1101-3PC	75mm x 32mm
J1101-4PB	J1101-4PC	100mm x 32mm
J1101-6PB	J1101-6PC	150mm x 32mm

NECKED BELL SHAPE BRASS BOLT

J1102-3PB	J1102-3PC	75mm x 32mm
J1102-4PB	J1102-4PC	100mm x 32mm
J1102-6PB	J1102-6PC	150mm x 32mm



BRASS DOOR BOLT



JV189APB	JV189APC	JV189ASC	150mm x 30mm
JV189BPB	JV189BPC	JV189BSC	200mm x 40mm



CONTRACT VERSION

JV179PB	JV179PC	JV179SC	102mm x 30mm
JV179APB	JV179APC	JV179ASC	150mm x 30mm
JV179BPB	JV179BPC	JV179BSC	200mm x 40mm

BRASS DOOR BOLT

JV178PB	150mm x 40mm
JV178PC	150mm x 40mm
JV178SC	150mm x 40mm



ACCESSORIES

BRASS DOOR BOLT

JV1005PB-200	JV1005PC-200	JV1005SC-200	200mm x 35mm
JV1005PB-250	JV1005PC-250	JV1005SC-250	250mm x 35mm
JV1005PB-300	JV1005PC-300	JV1005SC-300	300mm x 35mm
JV1005PB-350	JV1005PC-350	JV1005SC-350	350mm x 35mm
JV1005PB-400	JV1005PC-400	JV1005SC-400	400mm x 35mm
JV1005PB-500	JV1005PC-500	JV1005SC-500	500mm x 35mm
JV1005PB-600	JV1005PC-600	JV1005SC-600	600mm x 35mm



BRASS LEVER ACTION FLUSHBOLTS



JV5640BPB	JV5640DPB
JV5640BPC	JV5640DPC
JV5640BSC	JV5640DSC
JV5640BSN	250 X 20mm
150 X 20mm	
JV5640CPB	JV5640EPB
JV5640CPC	JV5640EPC
JV5640CSC	JV5640ESC
JV5640CSN	JV5640ESN
200 X 20mm	305 X 20mm



SLIDE ACTION FLUSH BOLT

JV5640APB
JV5640APC
JV5640ASC

100mm x 16mm



ALUMINIUM LEVER ACTION FLUSHBOLT DUST PROOF SPRING FLOOR SOCKET EASY CLEAN BOLT SOCKETS

63mm x 20mm



150mm x 19mm
JV5640A

200mm x 19mm
JV5640B



25mm x 40mm

JV5642SN
JV5642PN



JV5643PB
JV5643PC
JV5643SC

MORTICE RACK BOLTS



J726
Forend 42x19mm
Backset 14mm
Barrel 16mm

J726BL J726PC
J726NP J726SC
J726PB J726WH



J727
Forend 42x19mm
Backset 28mm
Barrel 16mm

J727BL J727PC
J727NP J727SC
J727PB J727WH



J728
Forend 42x19mm
Backset 57mm
Barrel 16mm

J728PB
J728PC
J728SC

KEYS



J729K - 35mm

J730K - 65mm

INDICATOR BOLT



JV2662PVD
JV2662PC
JV2662SC

Internal 60mm x 40mm
External 61mm x 42mm

BATHROOM SLIDE BOLT



J1414PB
J1414PC
J1414SC

65mm x 25mm

INDICATOR BOLT

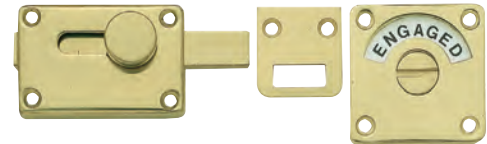

JV2552PVD
JV2552PC
JV2552SC

Internal 60mm x 40mm
External 50mm x 50mm

BATHROOM BOLT

c/w mortice bolt

Forend: 42mm x 19mm
Diameter: 32mm
Rose: 36mm
Backset: 38mm

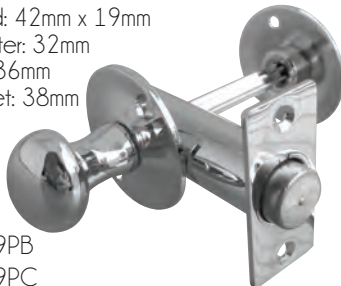

JV2689PB
JV2689PC
JV2689SC

TURN FOR USE WITH RACKBOLTS

Diameter: 31mm
Projection 33mm
Rose: 36mm
Spindle: 38mm



JV2715PB
JV2715PC
JV2715SC

BATHROOM TURN AND RELEASE

for use with deadbolts
5mm Spindle

Diameter: 32mm
Projection: 33mm
Rose: 36mm

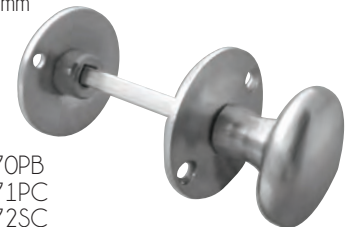

JV2670PB
JV2671PC
JV2672SC

CYLINDER FLOOR MOUNTED DOOR STOP

38mm x 27mm



JV9565PC
JV9565SC
JV9565SN

FLOOR MOUNTED DOOR STOP

40mm x 30mm



JV9529PB
JV9529PC
JV9529SC

FLOOR MOUNTED DOOR STOP

Diameter: 46mm
Height: 26mm



JV86PB
JV86PC
JV86SC
JV86SN

WALL MOUNTED SPRING DOOR STOP

Projection: 78mm
Rose: 25mm



J739HEB
J739HZP

WALL MOUNTED DOOR STOP



JV9551A PB
JV9551A PC
JV9551A SC

Projection: 64mm
Rose: 38mm

JV9551B PB
JV9551B PC
JV9551B SC

Projection: 75mm
Rose: 38mm

DOME TOPPED FLOOR MOUNTED DOOR STOP

45mm x 28mm



JV9560PC
JV9560SC
JV9560SN

FOOT OPERATED DOOR HOLDER

120mm x 24mm



IA4306PB
IA4306PC
IA4306SC

FOOT OPERATED DOOR HOLDER

180mm x 37mm



IA4307PB
IA4307PC
IA4307SC

WALL MOUNTED DOOR STOP



JV9559APB
JV9559APC
JV9559ASC

70mm Projection

JV9559BPB
JV9559BPC
JV9559BSC

102mm Projection

ACCESSORIES

CABIN HOOK



JV110HPB	JV110H PC	JV110HSC	50mm
JV110APB	JV110APC	JV110ASC	75mm
JV110BPB	JV110BPC	JV110BSC	100mm
JV110DPB	JV110DPC	JV110DSC	152mm
JV110EPB	JV110EPC	JV110ESC	205mm
JV110FPB	JV110FPC	JV110FSC	250mm
JV110GPB	JV110GPC	JV110GSC	300mm

FLUSH RING



JV424APB
JV424APC
JV424ASC

38mm x 50mm

JV424BPB
JV424BPC
JV424BSC

50mm x 63mm

HANDRAIL BRACKET

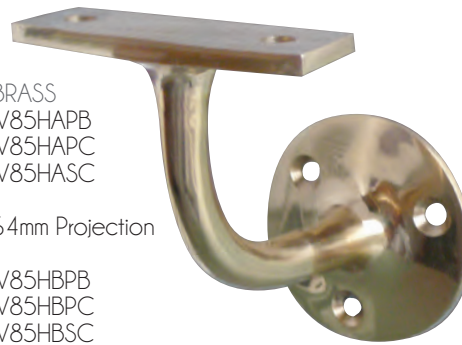

BRASS
JV85HAPB
JV85HAPC
JV85HASC

64mm Projection

JV85HBPB
JV85HBPC
JV85HBSC

75mm Projection

ZINC
JV95APC
JV95ASC
JV95ASN

64mm Projection

JV95BPC
JV95BSC
JV95BSN

75mm Projection

FLUSH PULL



SATIN CHROME



WHITE



POLISHED CHROME



POLISHED BRASS



BLACK

JV428BL
JV428PB
JV428PC
JV428SC
JV428WH

75mm x 40mm
Depth 11mm

JV428ABL
JV428APB
JV428APC
JV428ASC
JV428AWH

89mm x 42mm
Depth 11mm

JV428BBL
JV428BPB
JV428BPC
JV428BSC
JV428BWH

102mm x 45mm
Depth 11mm

SLOTTED VENTILATOR

JM3763APB	JM3763APSS	150mm x 75mm
JM3763BPB	JM3763BPSS	225mm x 75mm
JM3763CPB	JM3763CPSS	225mm x 150mm
JM3763DPB	JM3763DPSS	225mm x 225mm
JM3763EPB	JM3763EPSS	305mm x 75mm
JM3763FPB	JM3763FPSS	305mm x 150mm
JM3763GPB	JM3763GPSS	305mm x 225mm
JM3763HPB	JM3763HPSS	305mm x 305mm

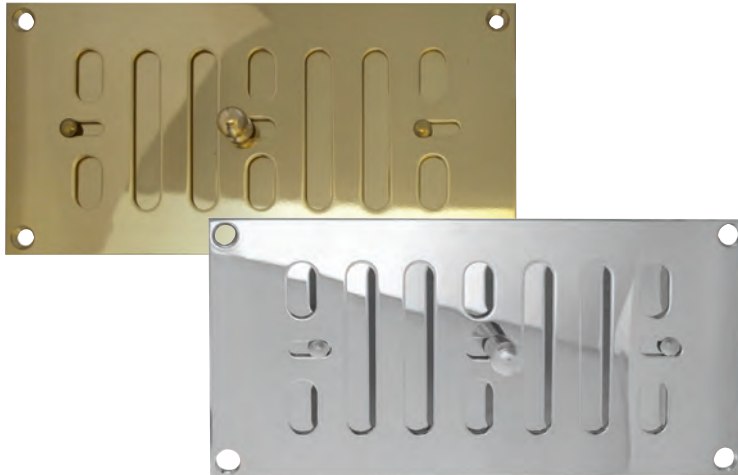
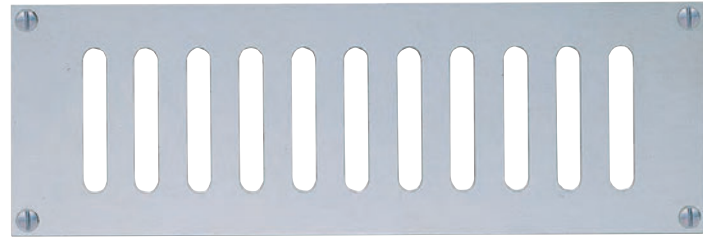

HIT AND MISS VENTILATOR

JM5310APB	JM5310APSS	150mm x 75mm
JM5310BPB	JM5310BPSS	225mm x 75mm
JM5310CPB	JM5310CPSS	225mm x 150mm
JM5310DPB	JM5310DPSS	225mm x 225mm
JM5310EPB	JM5310EPSS	305mm x 75mm
JM5310FPB	JM5310FPSS	305mm x 150mm
JM5310GPB	JM5310GPSS	305mm x 225mm
JM5310HPB	JM5310HPSS	305mm x 305mm

LOUVRE VENTILATOR

JM5630APB	JM5630APSS	150mm x 75mm
JM5630BPB	JM5630BPSS	225mm x 75mm
JM5630CPB	JM5630CPSS	225mm x 150mm
JM5630DPB	JM5630DPSS	225mm x 225mm
JM5630EPB	JM5630EPSS	305mm x 75mm
JM5630FPB	JM5630FPSS	305mm x 150mm
JM5630GPB	JM5630GPSS	305mm x 225mm
JM5630HPB	JM5630HPSS	305mm x 305mm

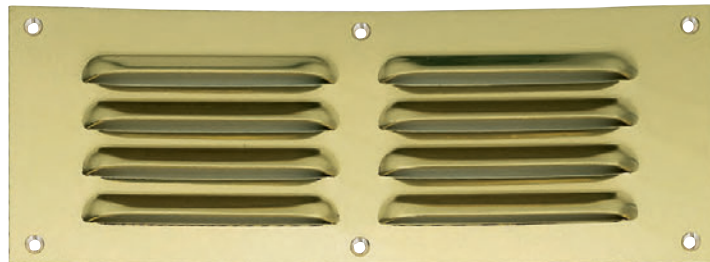

ACCESSORIES

SAA SLOTTED VENTILATOR

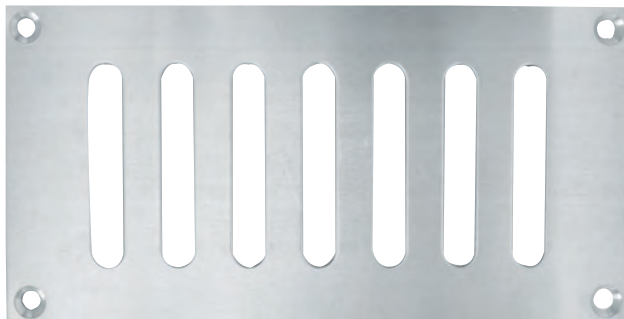

JM7763A	150mm x 75mm
JM7763B	225mm x 75mm
JM7763C	225mm x 150mm
JM7763D	225mm x 225mm
JM7763E	305mm x 75mm
JM7763F	305mm x 150mm
JM7763G	305mm x 225mm
JM7763H	305mm x 305mm

SAA HIT AND MISS VENTILATOR

JM7313A	150mm x 75mm
JM7313B	225mm x 75mm
JM7313C	225mm x 150mm
JM7313D	225mm x 225mm
JM7313E	305mm x 75mm
JM7313F	305mm x 150mm
JM7313G	305mm x 225mm
JM7313H	305mm x 305mm



SAA LOUVRE VENTILATOR

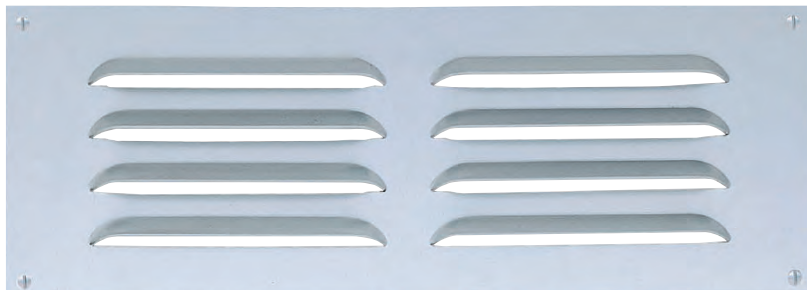

JM7631A	150mm x 75mm
JM7631B	225mm x 75mm
JM7631C	225mm x 150mm
JM7631D	225mm x 225mm
JM7631E	305mm x 75mm
JM7631F	305mm x 150mm
JM7631G	305mm x 225mm
JM7631H	305mm x 305mm

SHOWCASE CATCH

42mm



JV87PB

DOOR CATCH

57mm x 41mm

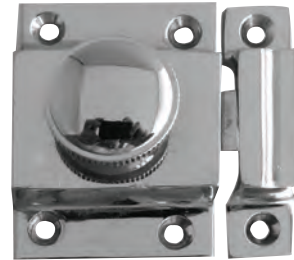

JV360PB
JV360PC
JV360SC

THROW OVER CATCH

52mm

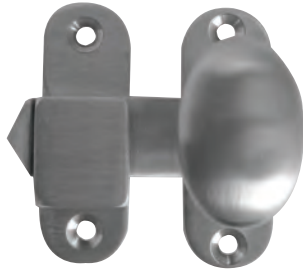

JVCCPB1
JVCCPC1
JVCCSC1

THROW OVER CATCH

55mm



JV4434PB
JV4434PC

DOUBLE BALL CATCH



JV888APB 42mm
JV888BPB 50mm
JV888CPB 60mm
JV888DPB 70mm

MAGNETIC CATCH



J1412A small
J1412B large

DOUBLE ROLLER CATCH



J337H

TOUGH CATCH



J234ZP

ACCESSORIES

DUMMY SPINDLES



STDS ZP finish with
26mm plate

TDS ZP finish
for round Rose levers
TDS-JC ZP Finish
for China mortice knobs

SPINDLES FOR CHINA MORTICE KNOBS



BUL202

2 PIECE SPINDLE FOR SPLIT FOLLOWERS

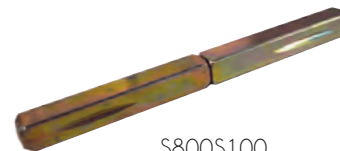

S800S100
8mm x 110mm

8MM SPLIT SPINDLES



S800S100 - 8mm x 100mm
S800S110 - 8mm x 110mm

8MM PLAIN SPINDLES



S800P100 - 8mm x 100mm
S800P110 - 8mm x 110mm

8MM HESO SPINDLE



S800D100 - 8mm x 110mm
H800H110 - 8mm x 110mm
H800H120 - 8mm x 120mm
H800H140 - 8mm x 140mm

5MM PLAIN SPINDLES



S500P120
5mm x 120mm

GRUB SCREWS



HKGRUB
PORGRUB
JSSGRUB
JHGRUB

BACK TO BACK FIXINGS

TO SUIT LEVERS ON ROSE



HKBBF
PORBBF

5MM TO 8MM ADAPTOR

JV701INS PLUG
JV701SI SLEEVE
JV701 SLM METAL SLEEVE



INTUMESCENT HINGE PADS

INT1 30X 102 X 1mm
PACK OF 4 30 MIN FD
INT3 30X 102 X 1mm
PACK OF 6 30 MIN FD
INT4 30X 102 X 2mm
PACK OF 4 60 MIN FD
INT5 30X 102 X 2mm
PACK OF 6 60 MIN FD



SCREWS FOR HINGES

1 1/4 X 10G (PACK OF 8)



J9509BL
J9509BR
J9509EB
J9509PSS
J9509SSS

TURN & RELEASE

TO SUIT BATHROOM LEVERS ON PLATE



JVT&RPB
JVT&RPC
JVT&RSC

Like all metal based products ironmongery requires regular cleaning to prevent deposits from accumulating and damaging the items appearance. The following instructions will enable you to prolong the lifetime of the finish on these products.

PLATED FINISHES

Occasional wiping with a soft cloth and cleaning with a non abrasive wax polish

POLISHED AND LACQUERED FINISHES.

Clean with a damp clean cloth moistened with soapy water or wipe with a soft cloth with a non abrasive wax polish

It should be noted that the life of lacquer on most items is limited and will eventually break down. Adverse conditions such as industrial pollution, sea air, acid rain, abrasives etc and repeated continual handling may cause the coating to deteriorate prematurely.

BLACK & PEWTER FURNITURE

Iron is vulnerable to rusting and whilst we make every effort to cover all areas of our products to avoid rusting it is essential to maintain these items , especially in external situations, to try and prevent rusting . It is recommended to give items an occasional light oiling. This can be done by wiping the items with a lightly oiled cloth to help prevent a build up of harmful deposits which will cause corrosion.

STAINLESS STEEL

Whilst stainless steel is a strong durable material, it will , if not maintained regularly, show signs of rusting .

It is therefore recommended that you carry out the following cleaning regime.

Clean regularly with a dry cloth or duster

Periodic washing with warm soapy water and dried with a clean cloth.

Wipe occasionally with a good quality silicone wax polish

APPLIED FINISHES

Finishes such as bronze , rustic , tin and black nickel are what is know as an applied finish, these can be cleaned as polished and lacquered finishes. This type of finish will vary in colour between batches.

IT SHOULD BE NOTED HOWEVER THAT THESE FINISHES WILL WEAR OVER TIME.

ALL FINISHES

Under no circumstances should you clean these products with: **ABRASIVE CLEANERS OR ACID BASED PRODUCTS**

DISPLAY PACKS

WE ALSO SUPPLY A VARIETY OF PRODUCTS DISPLAY PACKED FOR RETAIL DISPLAY UNITS.

DISPLAY STANDS ARE ALSO AVAILABLE.

PRODUCTS AVAILABLE IN DISPLAY PACKS ARE MARKED WITH THIS SYMBOL  IN THE CATALOGUE.

PLEASE ASK FOR DETAILS ON THESE AND DISPLAY STANDS.



DESCRIPTION	PAGES
A	
ADAPTORS	230
ALUMINIUM FURNITURE	118-123
B	
BALL BEARING HINGES	196,197,200,201,204
BARREL BOLTS	221,222
BATHROOM BOLTS	224
BATHROOM HUB	175
BATHROOM LOCKS	106,172,175,178
BELL PUSHES	100,113,168
BLACK ANTIQUE FURNITURE	96,109
BOLT SOCKETS	87,223
B.S. LOCKS	174
BUDGET LOCKS	185
BUFFERED HOOKS	80,84
C	
CABIN HOOKS	109,226
CABINET HANDLES	78,116,117,148,151 152, 153,160
CABINET KNOBS	102, 139, 140, 144 146-150,160,162
CASEMENT FASTENERS	59,60,86,104,114- 215,216-217
CASEMENT STAYS	86,104,114,215,216-217
CENTRE DOOR KNOBS	81,100,113,169
COLOURED GLASS CUPBOARD KNOBS	140
COLOURED GLASS MORTICE FURNITURE	137
CONCEALED BEARING HINGES	198,200
CONCEALED DOOR CLOSERS	213
CONCEALED DOOR CHAIN	170
COUNTER FLAP CATCH	207
COUNTER FLAP HINGE	207

DESCRIPTION	PAGES
CRYSTAL CUPBOARD KNOBS	160,162
CRYSTAL MORTICE KNOBS	159,161
CRYSTAL CABINET HANDLES	160
CUPBOARD CATCHES	117,229
CUPBOARD KNOBS	78,102,139,140,144,146-150 160,162
CYLINDER COVERS	100,113
CYLINDER PULLS	82,100,167,168
CYLINDERS	179,180
D	
DEADBOLTS	178,180, 181
DEADLOCK 3 LEVER	177
DEADLOCKS - 5 LEVER	174,176,
DIGITAL LOCKS	187
DIN LOCKS	172,173
DOOR BOLTS	107,117,221,222,223
DOOR CATCHES	228
DOOR CHAINS	170
DOOR CLOSERS	211-213
DOOR GUARDS	170
DOOR HOLDERS	225
DOOR KNOCKERS	81,100,113,167
DOOR SELECTOR	213
DOOR STAYS	213
DOOR STOPS	80,99,114,123,225
DOOR STUDS	100
DOOR VIEWERS	81,164
DRAWER PULLS	123,148
DUST PROOF SPRING FLOOR SOCKET	87,223
E	
EASY CLEAN SOCKETS	223
ESCAPE LOCKS	173

INDEX

DESCRIPTION	PAGES
ESCUTCHEONS	18,26,34,40,71,109, 114,119,122,131,143,170
ESPAÑOLETTE DOOR BOLTS	191-194
ESPAÑOLETTE WINDOW FASTENER	59,60,86,215
EURO PROFILE CYLINDERS	180
EURO PROFILE DEADLOCK	172,175
EURO PROFILE SASHLOCK	172,175
EXTERIOR DOOR FURNITURE	163-170
F	
FANLIGHT CATCH	228
FINGER PLATES	77,92,93,108,143
FIRE BRIGADE LOCKS	186
FIXING BOLTS	230
FLUSH BOLTS	87,223
FLUSH PULLS	87,123,226
FLUSH RINGS	226
FOOT OPERATED DOOR HOLDER	225
G	
GATE CATCHES	108,117
GATE LATCH	117
GLASS CUPBOARD KNOBS	139,140
GLASS MORTICE KNOBS	133-138
GLASS LEVER ON ROSE FURNITURE	11,12,138
GRUB SCREWS	230
H	
HANDRAIL BRACKETS	87,109,123,226
HANGING RAIL	157
HANGING RAIL FITTINGS	157
HAT & COAT HOOKS	84,85,109,114,116,123,155
HEAVY DUTY BUTT HINGE	202
HEAVY DUTY LATCH	181

DESCRIPTION	PAGES
HEAVY DUTY DEADBOLTS	181
HINGES	105,117,195-209
HAND FORGED FURNITURE	115-117
I	
INDICATOR BOLTS	107,123,224
INNER TIDIES	101,122,166
INTUMESCENT HINGE PADS	230
K	
KEY BLANKS	180
KICK PLATES	93
L	
LETTER PLATES	81,101,113,122,165,166
LETTERS	168
LEVERS ON BACKPLATE	43-57,69,97-99 111,112,115,120
LEVERS ON ROSE	5-17,21-25,29-32,37-39 63-69,119,138
LOCKABLE CASEMENT FASTENERS	59,60,104,215
LOCKABLE CASEMENT STAYS	215
LOCKING SASH FASTENERS	218
LOCKING SASH STOPS	219
LOOSE PIN HINGES	203
M	
MAGNETIC CATCHES	229
MASTER KEYS	180
MECHANICAL DIGITAL LOCKS	186
MORTICE BOLTS	224
MORTICE KNOB FURNITURE	102,112,124-129,133-138 143,159,161
MORTICE LATCHES	173,174,177,180,181
MARBLE MORTICE KNOB FURNITURE	127

DESCRIPTION	PAGES
N	
NECKED BOLTS	107,117,221,222
NIGHTLATCHES	173,183
NUMERALS	82,100,167
O	
OVAL PROFILE CYLINDERS	180
OVERHEAD DOOR CLOSERS	211,212
OVERHEAD DOOR STAY	213
P	
PARLIAMENT HINGES	199,207
POLYMER BEARING HINGES	199
PORCELAIN FURNITURE	142,144
PROJECTION HINGES	208
PULL HANDLES	73-75,77,89,90,108,114,116,121
PVCu DOOR FURNITURE	59,61
PVCu LETTERPLATES	60
PVCu WINDOW FURNITURE	59,60
PULL HANDLES ON PLATE	77,90,121
PEWTER FURNITURE	110-117
R	
RACK BOLTS	224
RADIUSED HINGES	196,197,199,200
RADIUSED SASH PULLIES	219
RIM CYLINDERS	180,183
RIM KNOB FURNITURE	102,112,130
RIM LATCHES	184
RIM LOCKS	106,184
RISING BUTT HINGES	198
ROBE HOOKS	84,85,109,114,123,155
ROLLER CATCHES	228
ROLLER BOLT CATCHES	184,185,229
ROLLERBOLT NIGHTLATCH	183

DESCRIPTION	PAGES
S	
SASH FASTENERS	218
SASH HANDLE	219
SASH LIFT	219
SASHLOCK - 3 LEVER	106,176,178
SASHLOCK - 5 LEVER	174,176
SASH PULLIES	219
SASH STOPS	219
SCREWS	230
SECONDARY SECURITY FITTINGS	189
SELF LUBRICATING HINGES	196
SIGNAGE	94
SLIDING DOOR LOCKS	188
SLIDING STAYS	104,217
SPINDLES	230
SPRING HINGES	201,203
STAINLESS STEEL FURNITURE	62-87
STEEL BUTT HINGES	202
STRAIGHT BOLTS	107,117,221,222,223
SURFACE MOUNTED CLOSER	213
T	
THUMB LATCH	108,117
TOUCH CATCH	229
TUBULAR LATCHES	106,181,182
TUBULAR DEADBOLTS	180,182
URNS	107,224
URNS AND RELEASES	19,27,35,40,72,,107,119,131,138,144,224,230
TOILET ROLL HOLDER	87
V	
VENTILATOR GRILLES	227,228
W	
WARDROBE KNOBS	144
WASHERED HINGES	198,199,204,205,206
WINDOW FURNITURE	59,60,86,104,114,116,215,219

TERMS & CONDITIONS

1. ORDERS

Orders are accepted subject to the following conditions.

2. PRICES

Goods will be invoiced at the price ruling on the date of dispatch. Verbal prices or quotations will not be deemed valid.

3. VALUE ADDED TAX.

All prices are quoted exclusive of VAT, which will be charged at the current rate and shown as an extra on all invoices.

4. DELIVERY.

Whilst every effort is made to ensure orders are dispatched for next day delivery, we advise that this is not guaranteed and we shall not be responsible for delays or failure in deliveries due to or contributed by any cause whatsoever.

5. SETTLEMENT TERMS

a. Invoices are due and payable at the end of the month following the date of the invoice. We reserve the right to charge interest at 2% per month on accounts that are not paid within our terms.

b. All invoice queries must be raised with our accounts department within 7 days of receipt of invoice.

6. TITLE OF GOODS

Ownership of goods shall remain with the company until payment for goods has been received in full. If any goods are resold before payment is made, the company's right of ownership shall be transferred to the proceeds of sale or to the claim for such proceeds.

7. CARRIAGE

a. Orders to the net value of £120.00 will be carriage paid to the UK mainland.

b. Carriage on orders under £120.00 will be charged at the rate applicable on the date of dispatch.

c. For all other areas, including Northern Ireland, Eire and the Channel Islands, orders to the net value of £650.00 will be carriage paid.

8. GOODS DELIVERED TO SITE ADDRESSES

a. Goods requested to be delivered to addresses other than that of the buyer (site address) shall be subject to a carriage charge regardless of the order value.

b. If nobody is available to take delivery there will be a further charge for each subsequent attempt to deliver.

c. Collections cannot be made from site addresses and it is the responsibility of the buyer to arrange collection to enable collection from their invoice address.

9. RISK IN GOODS

A. The risk in goods shall pass to the buyer when delivery is made to the buyer's premises or destination specified by the buyer.

b. Shortages or damages must be advised within 7 working days of receipt of goods.

10. RETURNS

Returns will be accepted and credited with the following conditions.

a. Goods must not be returned without prior agreement and must be accompanied by an official Frelan returns note filled out with full details of all goods being returned. Any goods returned not on the collection note will not be credited.

b. Goods returned, which are surplus to requirements or ordered in error, will be subject to a 25% re-stocking charge and must be returned by the customer otherwise a carriage charge will be applied to collect the goods.

c. Goods requested to be returned after a period of six months from date of invoice cannot be considered for return or credit.

d. All goods must be returned in their original packing and in a re-saleable condition, goods returned not in a re-saleable condition may result in a refusal to credit.

e. Goods will only be collected from the buyers address, collections from site will have to be arranged by the buyer.

11. DEFECTIVE GOODS

a. Goods represented by the buyer to be defective shall not form the subject of any claim for any work done by the buyer or for any such loss, damage or expense whatsoever arising directly or indirectly from such defects.

b. Items that are received damaged or faulty will be collected by Frelan Hardware.

c. After inspection of products if they are found to be faulty due to a manufacturing error we will issue a credit or replace goods free of charge.

12. SPECIAL ORDERS

a. Any orders for items requested to be supplied to specific customers' requests and manufactured specially to those requirements will be accepted on receipt of an official written order and once accepted cannot be cancelled.

b. Special orders will be dispatched immediately on receipt into Frelan Hardware and normal carriage charges will apply.

c. Should customers require goods on a call of basis this can be arranged at time of order but a deposit may be required before the goods are purchased.

13. SAMPLES

Samples for approval will be invoiced at the normal list price and credited in full if returned within 28 days in a condition fit for re-sale.

14. SIZES

Sizes shown in catalogues and web sites are approximate and we reserve the right to change these where necessary and without notice.

15. ORDER CANCELLATIONS.

Cancellation will only be accepted by us on condition that any costs and expenses incurred by Frelan Hardware up to the time of cancellation and all loss or damage by reason of such cancellation will be reimbursed by the purchaser to us forthwith. Acceptance of such cancellation will be considered binding only if received in writing.

16. SMALL ORDERS

We can no longer post small orders as we cannot obtain proof of delivery, therefore these will be sent by carrier and charged at the rate applicable at date of dispatch.

17. BOX QUANTITIES CANNOT BE SPLIT

18. CONDITIONS OF SALE

Conditions of sale are as stated unless specified terms are negotiated and supported by written confirmation.

Frelan Hardware reserves the right to make any necessary amendments.

All sizes shown are approximate and we reserve the right to change them where necessary and without notice. Colours may vary from the actual product due to photography and print techniques.





FRELAN HARDWARE LTD

UNIT 10
MITCHAM INDUSTRIAL ESTATE
STREATHAM ROAD
MITCHAM
SURREY CR4 2AP

TEL: 020 8648 1500 • FAX: 020 8648 1626 • EMAIL: SALES@FRELAN.CO.UK

WWW.FRELAN.CO.UK