

GAS UNIT HEATERS

ARM RANGE



ErP 
Energy related Product
2018



FLEXIHEAT UK LTD

www.flexiheatuk.com

01202 822221

ARM



Simple and reliable heater
Efficiency up to 91 %

Fleaxiheat Gas Unit Heaters - ARM series are suitable for indoor installation in industrial and commercial premises. Thanks to the closed combustion chamber and atmospheric burner, the ARM gas fired unit heater is compliant with ERP 2018 Directive and achieves up to 92% efficiency.

TYPICAL APPLICATION



Industries



Supermarkets



Sport facilities



Warehouses



Workshops



Greenhouses

Gas Unit Heater

ARM Gas Unit Heater is running with natural gas (G20/G25) or propane gas (G31). The range includes 8 models from 14 to 80 kW and 3 versions such as axial, and vertical for direct blowing (ARMH, ARMV) and centrifugal for ducted flow (ARMC).

Product advantages	Customer benefits
Atmospheric burner	Efficiency up to 92 %
2 mm thickness heat exchanger with seamless pipe	Efficient heat exchange, long life service
Horizontal heat exchanger	Low height of device, useful for buildings with low ceilings
4 – route heat exchanger	Maximum use of combustion calories
Compact device	Rapid and easy installation
Pilot wire card	Regulation of several devices with only one thermostat
Double louver series	Efficient air distribution
Automatic security system	Safe use

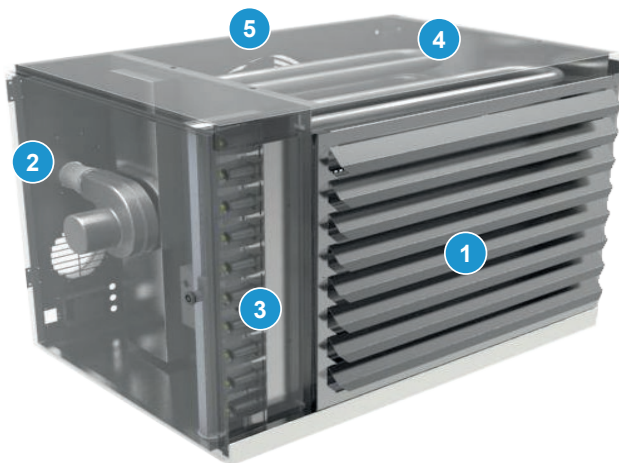

- 1 Louver Series
- 2 Flue Pipe Connection
- 3 Burner
- 4 Tubular Heat Exchanger
- 5 Axial Fan

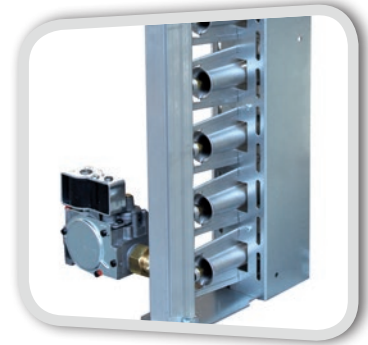

[Multi-jet gas burner]



[Heat exchanger]

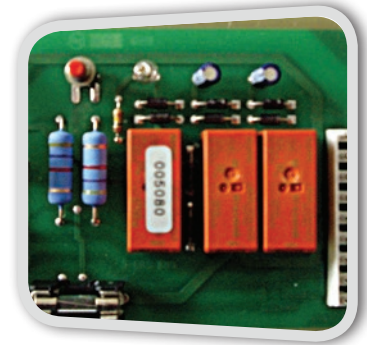

[Pilot wire card]



[Axial fan]

ARM'H'



Performances

Models	ARM1H	ARM2H	ARM3H	ARM4H	ARM4.5H	ARM5H	ARM6H	ARM8H
Heat Input (kW)	14.2	21	28	35	45	55	71	92
Heat Output (kW)	13.1	18.5	25	31.5	36.1	46.3	55.5	74
Efficiency (%)	>92	>92	>92	>92	>92	>92	>92	>92
Air flow T 15°C (m3/h)	1 600	2100	2 800	3 500	4 200	5 500	6 500	8 800
Sound level (dBa)	42	43	47	46	56	56	54	53

Dimensions

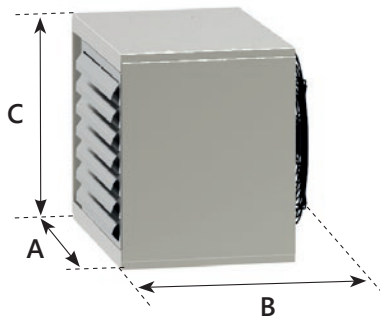

Models	ARM1H	ARM2H	ARM3H	ARM4H	ARM4.5H	ARM5H	ARM6H	ARM8H
A (mm)	810	1 040	1 040	1 040	1 040	1 040	1 120	1 120
B* (mm)	780	800	820	840	840	840	840	840
C (mm)	356	460	460	510	570	700	820	1 075
Gas (mm)	1/2"	1/2"	1/2"	1/2"	1/2"	1/2"	3/4"	3/4"
Fumes (mm)	80	80	80	80	100	130	130	130
Air (mm)	125	125	125	125	100	130	130	130
Weight (kg)	54	82	82	92	105	125	152	194

* From the front to back side of gas heater

Flue connection

Models 1-4

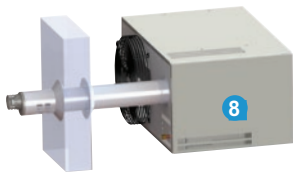

Concentric wall duct C12
maximum length : 6m



Concentric roof duct C32
maximum length : 6m

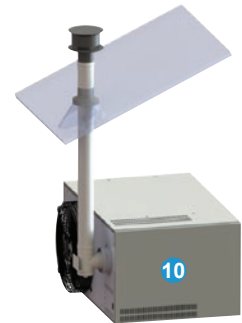

Sealed roof chimney B22
maximum length : 8m

Models 4.5-8

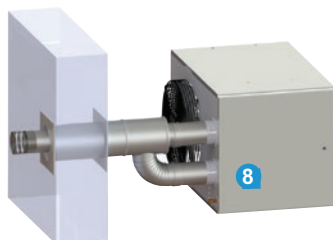

Concentric wall duct C12
maximum length : 6m



Concentric roof duct C32
maximum length : 8m



Sealed roof chimney B22
maximum length : 8m

Axial Gas Unit Heater

Prices

Models	ARM1H	ARM2H	ARM3H	ARM4H	ARM4.5H	ARM5H	ARM6H	ARM8H	
Axial gas air heater Erp2018	POA ARM1H	POA ARM2H	POA ARM3H	POA ARM4H	POA ARM4.5H	POA ARM5H	POA ARM6H	POA ARM8H	
Gas connection	Natural gas kit 20 or 25 mBar		1		POA KGN20				
	Natural gas kit 300 mBar		2		POA KDG55	POA KDG55	POA KDG55	POA KDG100	POA KDG100
	Propane gas kit 1,5 Bar		3		POA KDP55	POA KDP55	POA KDP55	POA KDP100	POA KDP100
	Flexible gas connection		4		POA FLEXIND1/2	POA FLEXIND1/2	POA FLEXIND1/2	POA FLEXIND3/4	POA FLEXIND3/4
Fixation	Directional wall-mounted bracket		5		POA CORATM	POA CORAT	POA CORAT	-	-
	KRSJ kit for directional bracket		6		POA KIPN				-
	Wall-mounting brackets (pair)		7		POA COAT				-
Flue pipes	Concentric wall duct C12		8		POA KC1280	POA KC1280	POA KC1280	POA KC12100	POA KC12130
	Concentric roof duct C32		9		POA KC3280	POA KC3280	POA KC3280	POA KC32100	POA KC32130
	Sealed roof chimney B22		10		POA KB2280	POA KB2280	POA KB2280	POA KB22100	POA KB22130
	Single extension 1 m				POA LE80100	POA LE80100	POA LE80100	POA LE100100	POA LE130100
	Single extension 0,5 m				POA LE80050	POA LE80050	POA LE80050	POA LE100050	POA LE130050
	Single elbow 45°				POA CE8045	POA CE8045	POA CE8045	POA CE10045	POA CE13045
	Single elbow 90°				POA CE8090	POA CE8090	POA CE8090	POA CE10090	POA CE13090
	Concentric extension 1 m				POA LC80100	POA LC80100	POA LC80100	-	-
	Concentric extension 0,5 m				POA LC80050	POA LC80050	POA LC80050	-	-
	Concentric elbow 45°				POA CC8045	POA CC8045	POA CC8045	-	-
	Concentric elbow 90°				POA CC8090	POA CC8090	POA CC8090	-	-
Regulation	Switch disconnecter		11		POA BSAT4P				
	Thermostat + remote reset		12		POA TFP1-ET85P2				
	Timer thermostat + remote reset		13		POA TFP2TS(FR) / TFP2TSE(EN)				
	Timer thermostat with external sensor + remote reset				POA TFP3TS				

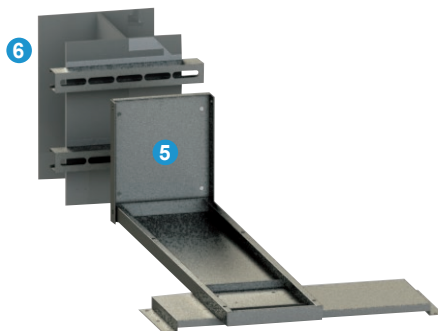
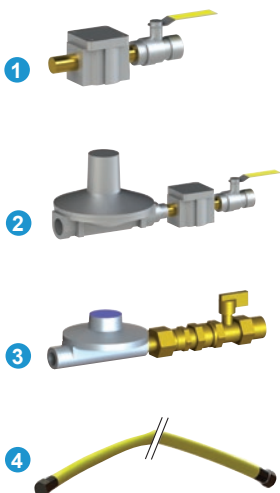

ARM'C'



Performances

Models	ARM2C	ARM3C	ARM4C	ARM4.5C	ARM5C	ARM6C	ARM8C
Heat Input (kW)	20	27	34	39	50	60	80
Heat Output (kW)	18.5	25	31.5	36.1	46.3	55.5	74
Efficiency (%)	>92	>92	>92	>92	>92	>92	>92
Air flow (m3/h)	2 100	2 800	3 500	4 200	5 500	6 500	8 800

Dimensions

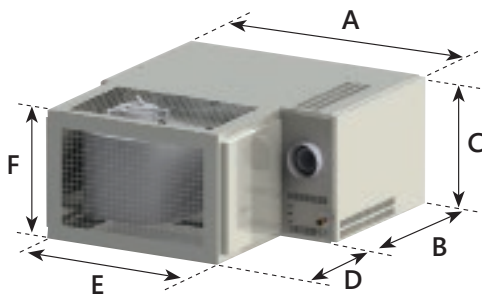

Models	ARM2C	ARM3C	ARM4C	ARM4.5C	ARM5C	ARM6C	ARM8C
A (mm)	1 040	1 040	1 040	1 040	1 040	1 120	1 120
B (mm)	677	677	677	677	677	677	677
C (mm)	460	460	510	570	700	825	1 075
D (mm)	480	480	480	580	580	580	680
E (mm)	750	750	750	750	750	750	750
F (mm)	460	460	510	570	700	700	1 075
Ø Gas	1/2"	1/2"	1/2"	1/2"	1/2"	3/4"	3/4"
Ø Fumes (mm)	80	80	80	100	130	130	130
Ø Air (mm)	125	125	125	100	130	130	130
Weight (kg)	99	117	125	140	165	180	260

Flue connection

Models 2-4

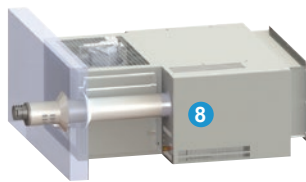

Concentric wall duct C12
maximum length : 6m

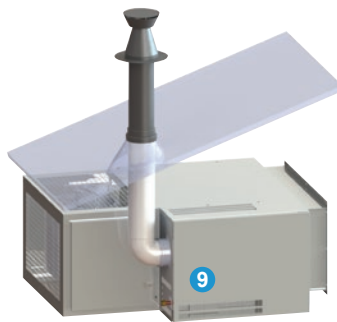

Concentric roof duct C32
maximum length : 6m

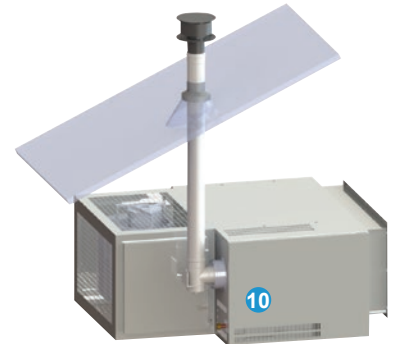

Sealed roof chimney B22
maximum length : 8m

Models 4.5-8

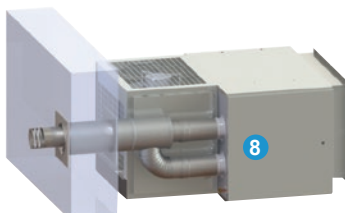

Concentric wall duct C12
maximum length : 6m

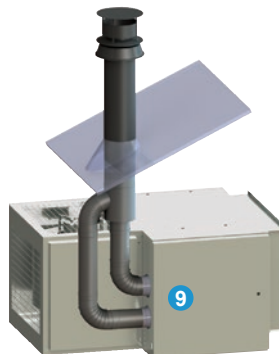

Concentric roof duct C32
maximum length : 8m

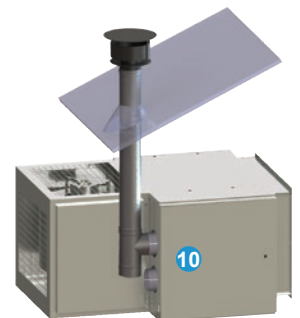

Sealed roof chimney B22
maximum length : 8m

Centrifugal Gas Unit Heater

Prices

Models	ARM2C	ARM3C	ARM4C	ARM4.5C	ARM5C	ARM6C	ARM8C
Centrifugal gas unit heater Erp2018	POA ARM2C	POA ARM3C	POA ARM4C	POA ARM4.5C	POA ARM5C	POA ARM6C	POA ARM8C
Accessoires							
Filter box + filter	1 POA CFIATE	POA CFIATE	POA CFIATE	POA CFIATI	POA CFIATI	POA CFIATI	2 x POA CFIATI
2 dampers	2 POA KRMATE	POA KRMATE	POA KRMATE	POA KRMATI	POA KRMATI	POA KRMATI	2 x POA KRMATI
Gas connection							
Natural gas kit 20 or 25 mBar	3			POA KGN20			
Natural gas kit 300 mBar	4 POA KDGN55	POA KDGN55	POA KDGN55	POA KDGN55	POA KDGN55	POA KDGN100	POA KDGN100
Propane gas kit 1,5 Bar	5 POA KDP55	POA KDP55	POA KDP55	POA KDP55	POA KDP55	POA KDP100	POA KDP100
Flexible gas connection	6 POA FLEXIND1/2	POA FLEXIND1/2	POA FLEXIND1/2	POA FLEXIND1/2	POA FLEXIND1/2	POA FLEXIND3/4	POA FLEXIND3/4
Fix.							
Wall-mounting brackets (pair)*	7			POA COAT			-
Flue pipes							
Concentric wall duct C12	8 POA KC1280	POA KC1280	POA KC1280	POA KC12100	POA KC12130	POA KC12130	POA KC12130
Concentric roof duct C32	9 POA KC3280	POA KC3280	POA KC3280	POA KC32100	POA KC32130	POA KC32130	POA KC32130
Sealed roof chimney B22	10 POA KB2280	POA KB2280	POA KB2280	POA KB22100	POA KB22130	POA KB22130	POA KB22130
Single extension 1 m	POA LE80100	POA LE80100	POA LE80100	POA LE100100	POA LE130100	POA LE130100	POA LE130100
Single extension 0,5 m	POA LE80050	POA LE80050	POA LE80050	POA LE100050	POA LE130050	POA LE130050	POA LE130050
Single elbow 45°	POA CE8045	POA CE8045	POA CE8045	POA CE10045	POA CE13045	POA CE13045	POA CE13045
Single elbow 90°	POA CE8090	POA CE8090	POA CE8090	POA CE10090	POA CE13090	POA CE13090	POA CE13090
Concentric extension 1 m	POA LC80100	POA LC80100	POA LC80100	-	-	-	-
Concentric extension 0,5 m	POA LC80050	POA LC80050	POA LC80050	-	-	-	-
Concentric elbow 45°	POA CC8045	POA CC8045	POA CC80	-	-	-	-
Concentric elbow 90°	POA CC8090	POA CC8090	POA CC8090	-	-	-	-
Regulation							
Switch disconnecter	11			POA BSAT4P			
Thermostat + remote reset	12			POA TFP1-ET85P2			
Timer thermostat + remote reset	13			POA TFP2TS(FR) / TFP2TSE(EN)			
Timer thermostat with external sensor + remote reset				POA TFP3TS			

* Warning : These brackets are unsuitable for use with filter and mixing box with dampers.

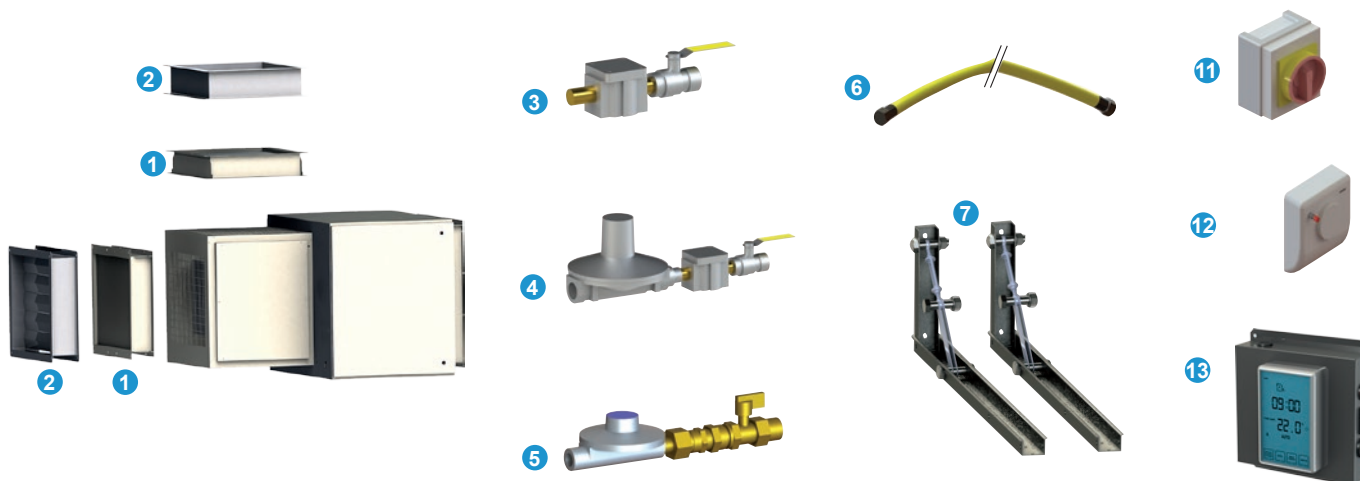

ARM'V'



Performances

Models	ARM3V	ARM4V	ARM5V	ARM6V	ARM8V
Heat Input (kW)	27	34	50	60	80
Heat Output	25	31.3	46.3	55.5	74
Efficiency (%)	> 92	>92	> 92	> 92	> 92
Air flow T 15°C (m3/h)	2 800	3 500	5 500	6 500	8 800
Sound level dB(A)	47	46	56	54	53

Dimensions

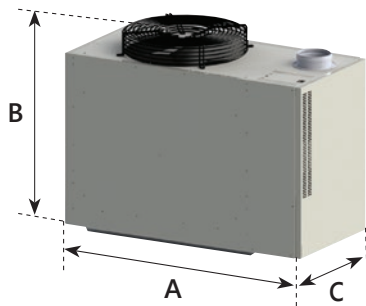

Models	ARM3V	ARM4V	ARM5V	ARM6V	ARM8V
A (mm)	810	1 040	1 040	1 120	1 120
B (mm)	820	820	840	840	840
C (mm)	570	570	700	820	1 075
Ø Gas	1/2"	1/2"	1/2"	3/4"	3/4"
Ø Fumes (mm)	80	100	130	130	130
Ø Air (mm)	125	100	130	130	130
Weight (kg)	85	105	125	152	194

* From the front to back side of gas heater

Flue connection Model 3



Concentric roof duct C32
maximum length : 6m



Sealed roof chimney B22
maximum length : 8m

Model 4.5-8

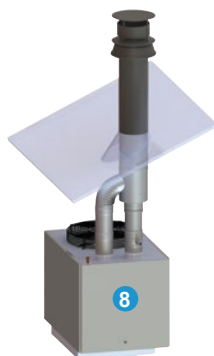

Concentric roof duct C32
maximum length : 8m



Sealed roof chimney B22
maximum length : 8m

Vertical Gas Unit Heater

Prices

Models		ARM3V	ARM4V	ARM5V	ARM6V	ARM8V
Vertical gas air heater Erp2018		POA ARM3V	POA ARM4V	POA ARM5V	POA ARM6V	POA ARM8V
Gas connection	Natural gas kit 20 or 25 mBar	1		POA KGN20		
	Natural gas kit 300 mBar	2 POA KDGN55	POA KDGN55	POA KDGN55	POA KDGN100	POA KDGN100
	Propane gas kit 1,5 Bar	3 POA KDP55	POA KDP55	POA KDP55	POA KDP100	POA KDP100
	Flexible gas connection	4 POA FLEXIND1/2	POA FLEXIND1/2	POA FLEXIND1/2	POA FLEXIND3/4	POA FLEXIND3/4
Fix.	Wall-mounting brackets	5 POA COATV	POA COATV	POA COATV	POA COATV	POA COATV2
Flue pipes	Sealed roof chimney B22	6 POA KB2280V	POA KB22100V	POA KB22130V	POA KB22130V	POA KB22130V
	Concentric roof duct C32	7 POA KC3280V	POA KC32100V	POA KC32130V	POA KC32130V	POA KC32130V
	Single extension 1 m	POA LE80100	POA LE100100	POA LE130100	POA LE130100	POA LE130100
	Single extension 0,5 m	POA LE80050	POA LE100050	POA LE130050	POA LE130050	POA LE130050
	Single elbow 45°	POA CE8045	POA CE10045	POA CE13045	POA CE13045	POA CE13045
	Single elbow 90°	POA CE8090	POA CE10090	POA CE13090	POA CE13090	POA CE13090
	Concentric extention 1 m	POA LC80100	-	-	-	-
	Concentric extention 0,5 m	POA LC80050	-	-	-	-
	Concentric elbow 45°	POA CC80	-	-	-	-
	Concentric elbow 90°	POA CC8090	-	-	-	-
Regulation	Switch disconnecter	8		POA BSAT4P		
	Thermostat + remote reset	9		POA TFP1-ET85P2		
	Timer thermostat + remote reset	10		POA TFP2TS(FR) / TFP2TSE(EN)		
	Timer thermostat with external sensor + remote reset	11		POA TFP3S		

