



EXPERIENCE
ATTENTION TO DETAIL



SUITE[®]
vertical dimension

Manufactured
by Nova



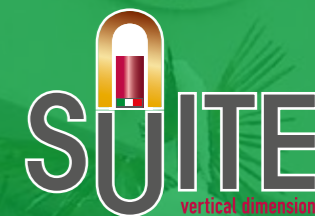

THE **QUALITY** YOU DESERVE



OUTDOOR



RAIN
CANOPY

TINTED
GLASS

BALUSTRADE

BRIDGE
LINK

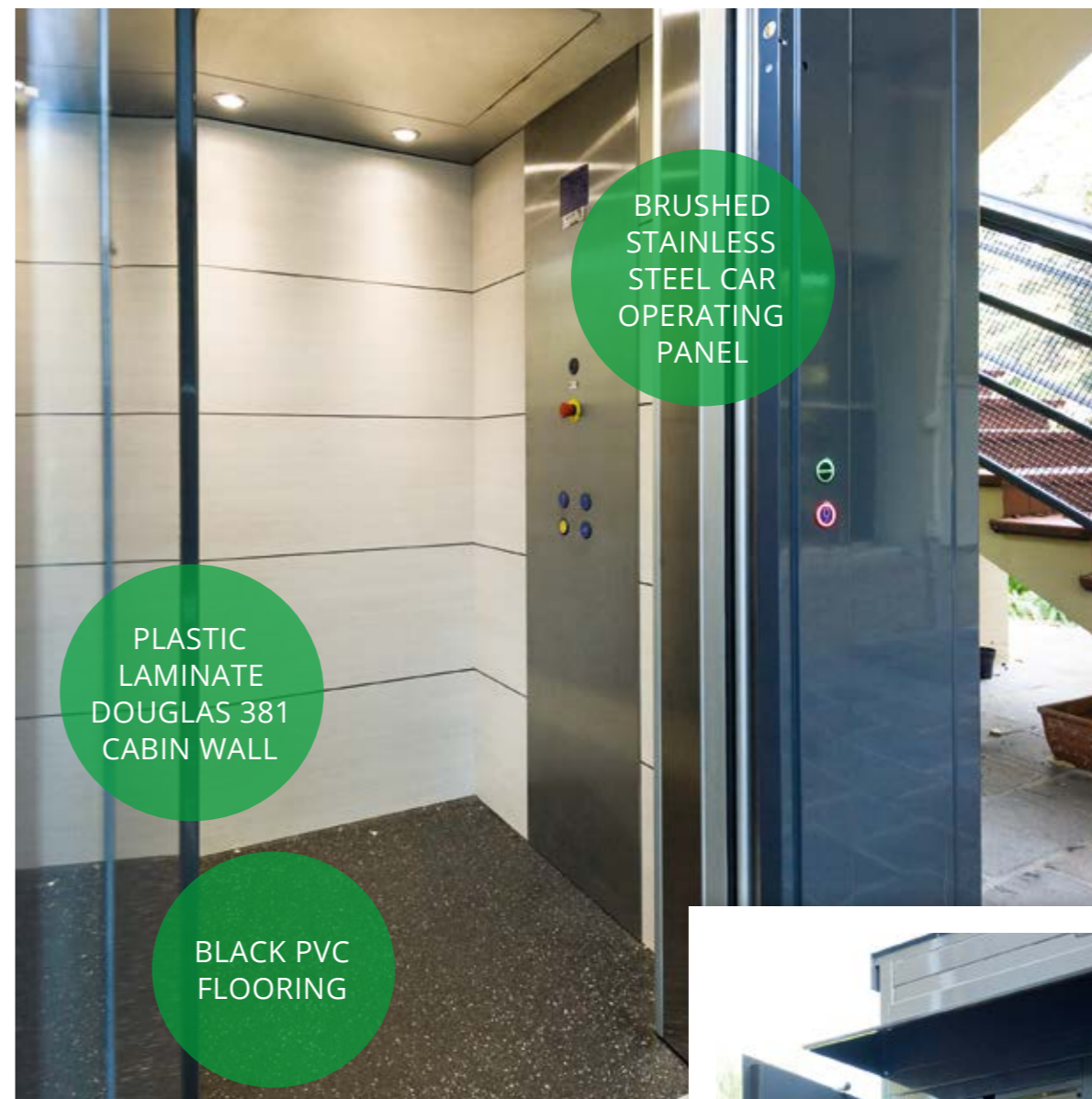

BRUSHED
STAINLESS
STEEL CAR
OPERATING
PANEL

PLASTIC
LAMINATE
DOUGLAS 381
CABIN WALL

BLACK PVC
FLOORING



RAIN
CANOPY

Green Energy Solutions

Suite traction is designed and manufactured according to **Green Energy Principles**, reduces energy consumption and consequently the emissions of CO₂ up to 70%.

42 kg



138 kg *

OTHER
HOMELIFTS

*average data

INDOOR

SMOKED
GLASS

"GRETA"
DOOR

POWDER
COATED STEEL
STRUCTURE



Suite operates on 230V-50 Hz.



Suite requires only **0,55 kW**,
same as your vacuum cleaner.



Automatic return to lower floor in case of
power failure is provided as standard.

Safety first!

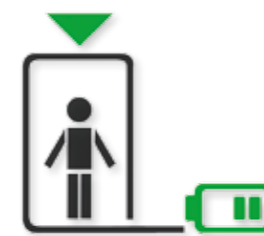

STAINLESS STEEL



BRUSHED
STAINLESS
STEEL
STRUCTURE

BRUSHED
STAINLESS
STEEL "GRETA"
DOOR



1

Beautiful in all finishes

*Attention to detail,
Elegant finishes,
Made to measure sizes and solutions,*

2

Door recessed *handle*,
Horizontal COP

STAINLESS STEEL FINISHES

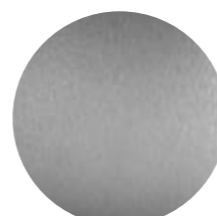

Brushed
stainless steel



Mirror
stainless steel



Patterned
stainless steel

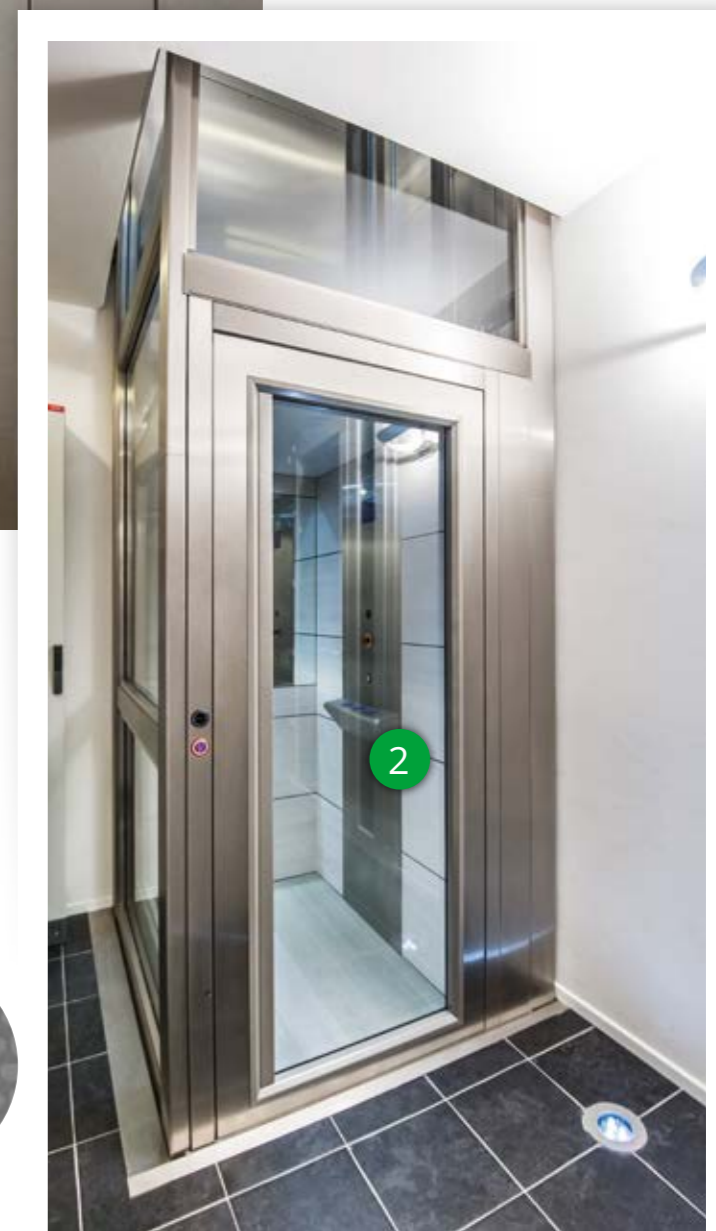

2

AUTOMATIC CAR AND LANDING SLIDING DOORS

"FULL-GLASS" AUTOMATIC SLIDING DOORS

"CORTEN" STEEL STRUCTURE

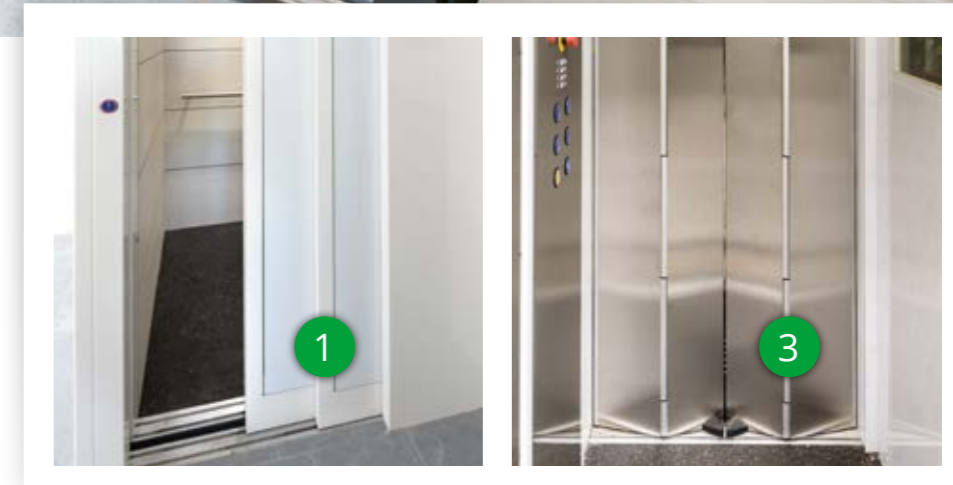
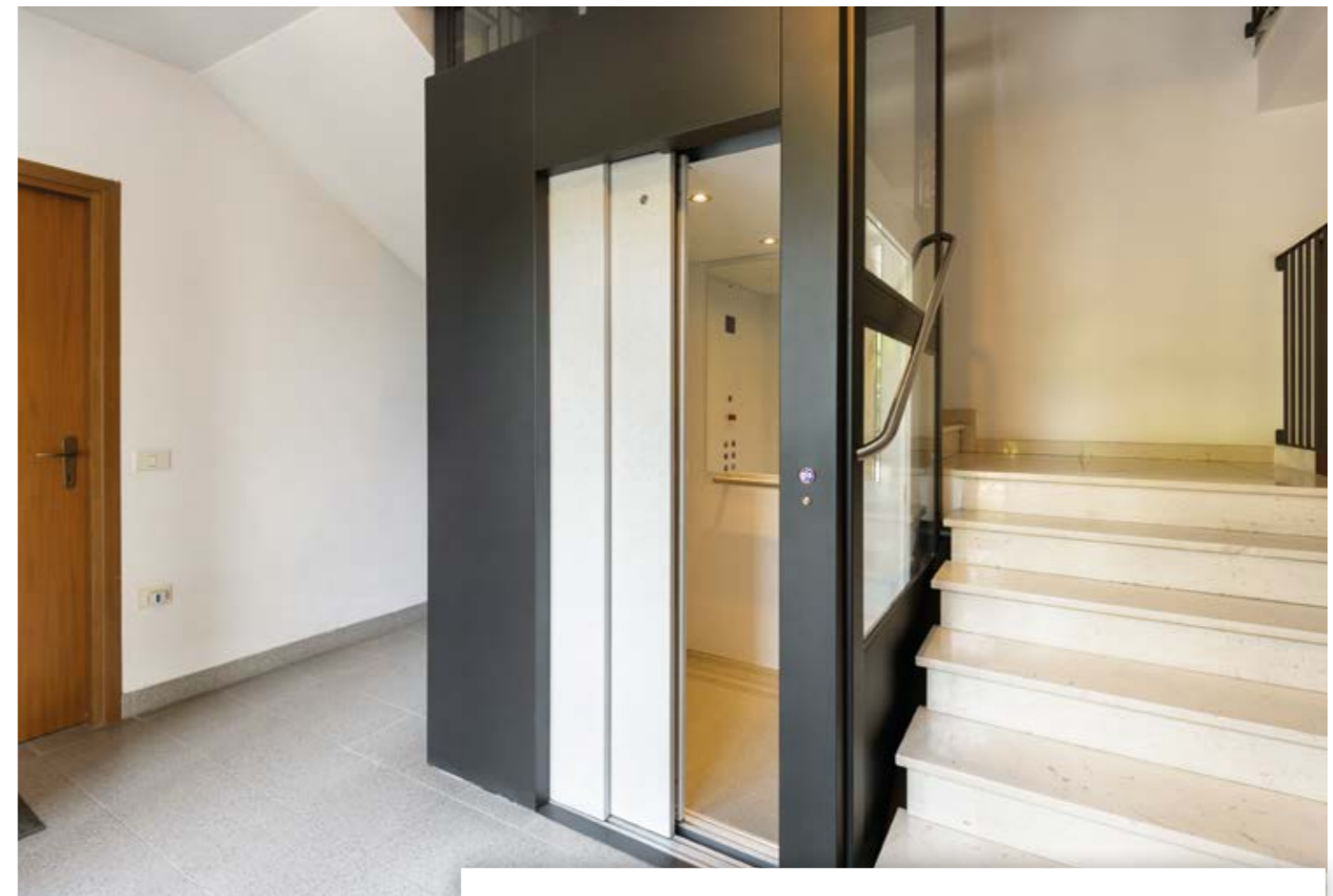

Automatic Solutions

- 1 **Milk glazed automatic** car and landing **sliding doors**
- 2 Landing **swing door** with **automatic opener**
- 3 **Folding car door**



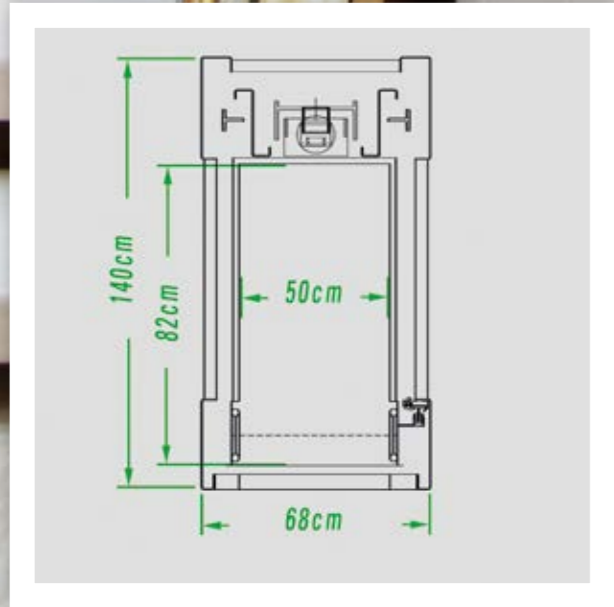
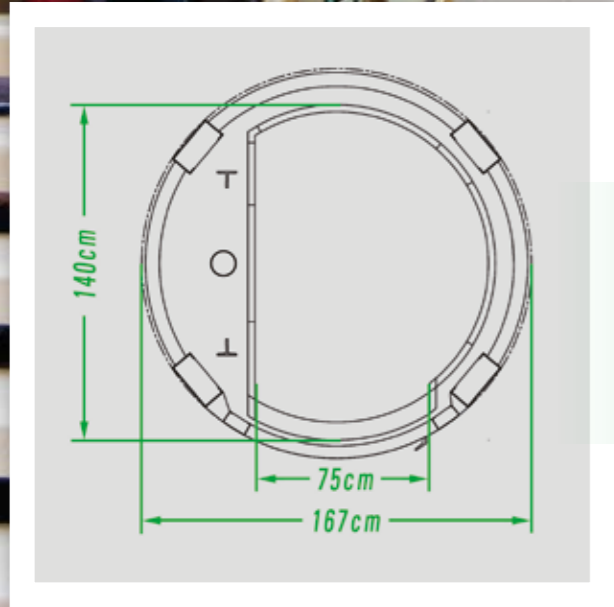
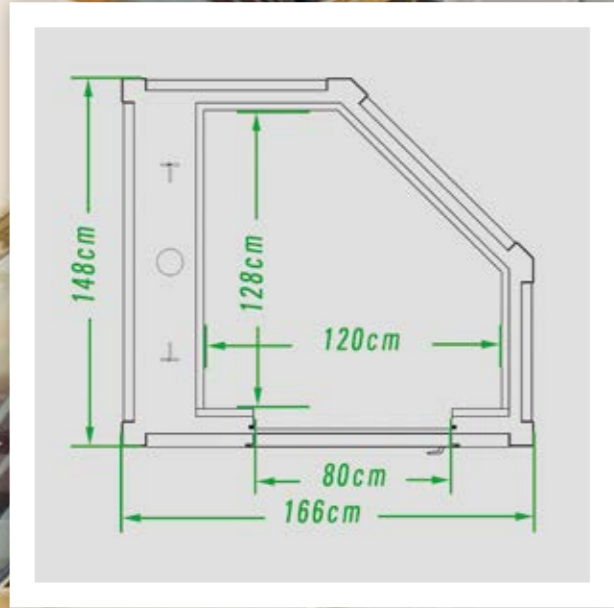

ROUND
HOMELIFT



WE HAVE CUSTOM SOLUTIONS
FOR ALL APPLICATIONS

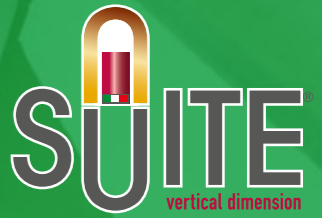

NARROW
SHAFT

DOORS

LANDING SWING DOOR



1
GRETA



2
KRYSTAL



3
SUBLIMA

AUTOMATIC CAR AND LANDING DOORS



4
FOLDING
CAR DOOR



5
GLASS
FOLDING
CAR DOOR

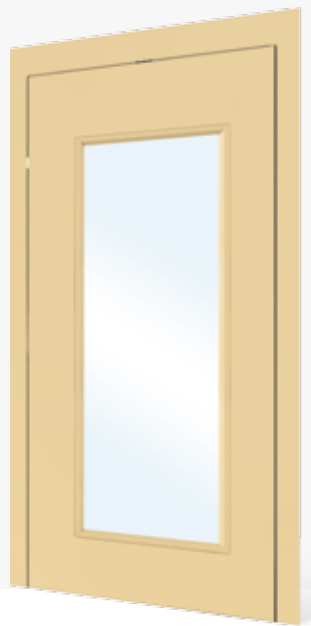

6
MARYLIN

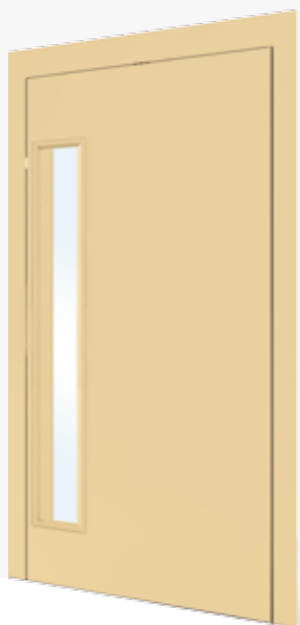

7
ANNA



8
EMMA
E1120 FIRE RATED DOOR
AVAILABLE



9
AUTOMATIC CAR
AND LANDING
SLIDING DOOR



10
GLASS
AUTOMATIC CAR
AND LANDING
SLIDING DOORS

"GRETA"
DOOR

WEATHER-RESISTANT DOOR

WEATHER-RESISTANT SWING DOOR DESIGNED TO REDUCE THE THERMAL TRANSMITTANCE



- 1 Sealing all around swing panel
- 2 Double glazed
- 3 Lower automatic sealing

THERMAL TRANSMITTANCE
Ud = 2.4 W/mqK*

4 TIMES MORE EFFICIENT THAN A STANDARD SWING DOOR

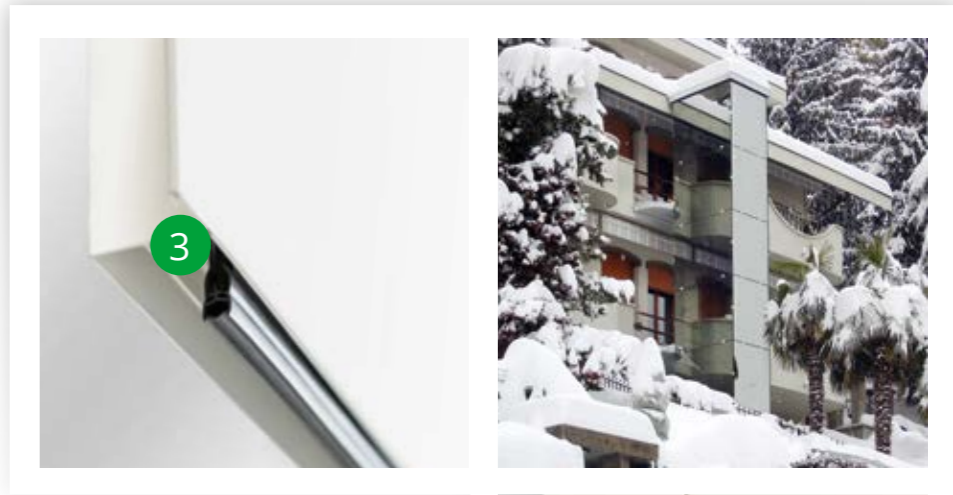

The tests performed on Marilyn TH door confirmed a *thermal insulation of Ud=2,4 W/mqk**, which is *4 times less* than a standard one-panel swing door.

*Calculations made according to the UNI EN ISO 10077-1.2

OPTIONS AVAILABLE



1
SAFETY KEY
on swing door



2
ENABLING KEY
in car



3
TELEPHONE
HANDSET
in car



in car

4
DISPLAY



at landing



5
ENABLING KEY
at landing



6
SWING DOOR
MANUAL
RELEASE
from inside car



7
LIGHTING
spot LEDS



8
LIGHTING
LEDs panel



9
FULL HEIGHT
INFRA-RED
BARRIER



10
CABINET
for Traction

2100mm

280mm

250mm



11
CABINET
for Hydraulic

medium small
1400mm / 1400mm

750mm / 600mm

410mm / 360mm

CAR FINISHES

WALLS

GLASS
WALL

PPS10
CAR WALL

SKINPLATE FINISHES (STANDARD)



F12PPS

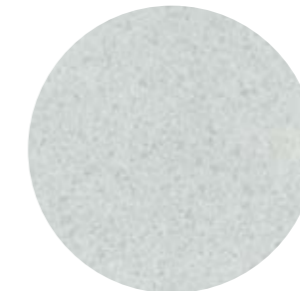

PPS12



A4



N1



PPS10

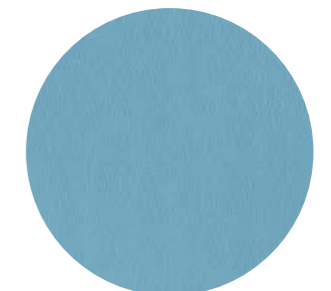

B13



G1



PPS11



A13

CAR FINISHES

WALLS

RAL 9001
POWDER
COATED
ROOF

RAL 1014
POWDER
COATED
COP

PLASTIC
LAMINATE
DOUGLAS 388
CABIN WALLS

BLACK PVC
FLOORING

PLASTIC LAMINATE FINISHES (OPTIONAL)



ACERO OTTAWA
385 sei-due



CILIEGIO EUROPEO
380 sei-due



TEAK SUMATRA
1612 sei-due



DOUGLAS ICE
388 microline



DOUGLAS VANILLA
381 microline



DOUGLAS
387 microline



ROVERE TENNESSEE
656 sei-due

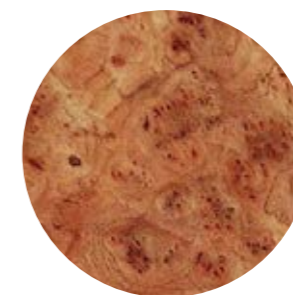

RADICA OLMO
1306 morbida

CAR FINISHES

CAR FLOOR FINISHES



BRUSHED
STAINLESS
STEEL
VERTICAL AND
HORIZONTAL
COP

PLASTIC
LAMINATE
DOUGLAS 388

SOLID WOOD
FLOORING
BY CLIENT

BRUSHED
STAINLESS
STEEL
"GRETA"
DOOR

PVC (STANDARD)

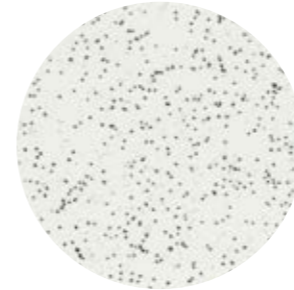

GHIACCIO

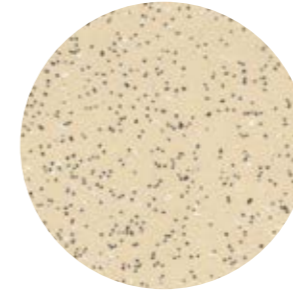

SABBIA

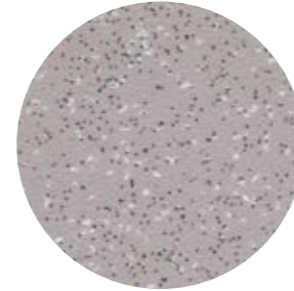

GRIGIO

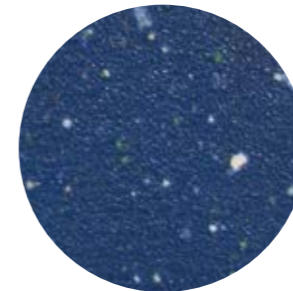

BLU

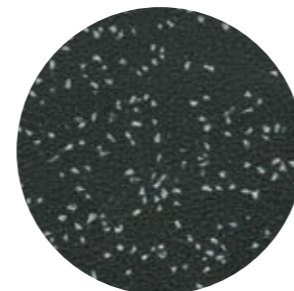

NERO

GRANITES (OPTIONAL)



WHITE STAR



SUNSET BEACH

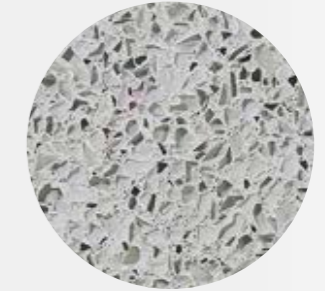

DOVE TAIL

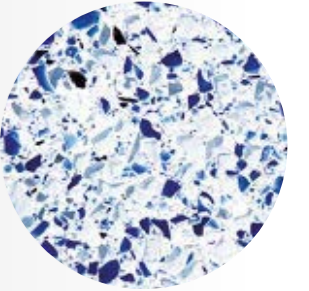

BLUE DREAM



NERO MALTESE

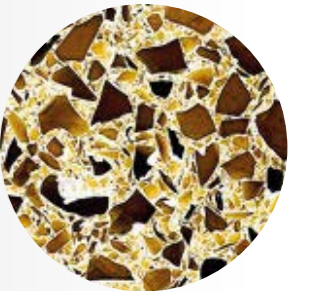

CHIARO AMBRA



GREEN DREAM



Allowance for flooring
provided by others

max thickness 2 cm



FOR **INDOOR** AND **OUTDOOR**

TRANSPARENT
GLASS

GLASS
FOLDING
CAR DOOR

STEEL
STRUCTURE
POWDER
COATED IN
RAL 1015

"GRETA"
DOOR

STANDARD RAL COLOURS AVAILABLE FOR METAL STRUCTURES AND LANDING DOORS



1014 AVORIO

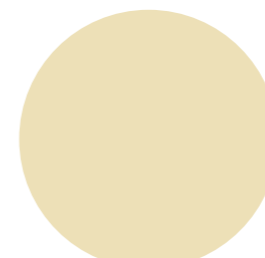

1015 AVORIO CHIARO

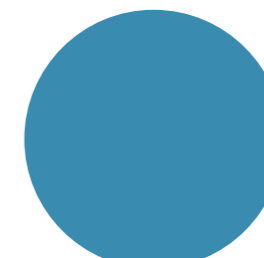

5024 BLU PASTELLO

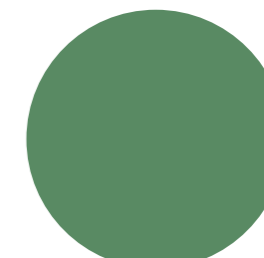

6011 VERDE RESEDA



7016 GRIGIO
ANTRACITE



7032 GRIGIO GHIAIA

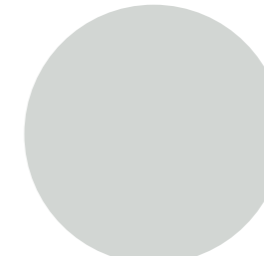

7035 GRIGIO LUCE

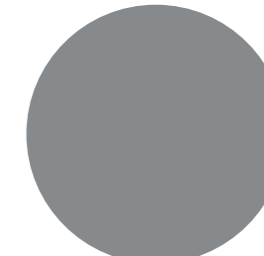

7037 GRIGIO POLVERE

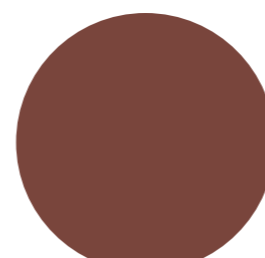

8002 MARRONE
SEGNALE

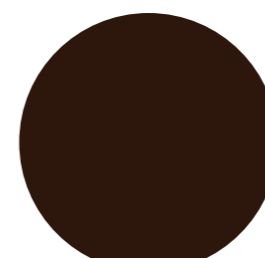

8017 MARRONE
CIOCCOLATA



9001 BIANCO
CREMA



9002 BIANCO
GRIGIASTRO

GLASS CLADDING

COLOURED GLASS

FROSTED GLASS

SMOKED GLASS

TINTED GLASS

MIRROR GLASS

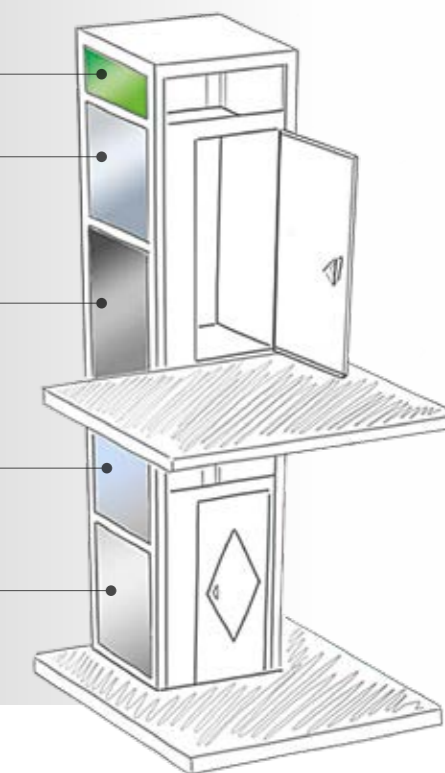



“
They even considered my cat!
”
BRIDGE WALK PROVIDED ON REQUEST



BRIDGE WALK EXIT

STEEL STRUCTURE POWDER COATED IN RAL 7016

VENTILATION



STAINLESS STEEL MIRROR POLISHED

MADE TO MEASURE SOLUTIONS

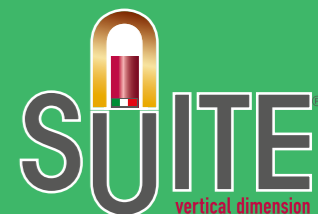

ROUND SUITE PAINTED RAL 9010 WHITE

STEEL
STRUCTURE
POWDER COATED
IN RAL 7001

DOOR FRAME
STAINLESS STEEL
BRUSHED

"KRYSTAL"
DOOR



Pietro
Quality



Paolo
Technical



Carla
Logistics



Fabrizio
CEO

TALK WITH NOVA FOR YOUR SPECIAL HOMELIFT

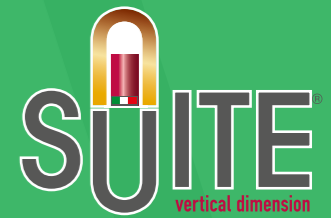

Fabio
Sales
domestic



Annarosa
Sales



Sandro
Electrical



Filippo
Design



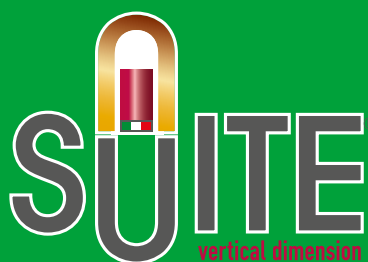

THE **QUALITY** ASSURANCE OF
"MADE IN ITALY!"

SUITE® is a registered trademark distributed
by **Nova s.r.l.**

Via G.Galilei, 116/c
40014 Crevalcore (fraz. Palata Pepoli)
(Bologna) Italy
Tel. 051/98.53.30 r.a.
Fax 051/98.52.20
info@suitelift.it

Associated:  ANICA

www.suitelift.it



Lloyd's
register

