

**YAMAHA**

*Virtual Acoustic Tone Generator*

**VL70-m**

**Owner's Manual**



**VL**  
for XG

# FCC INFORMATION (U.S.A.)

## 1. IMPORTANT NOTICE: DO NOT MODIFY THIS UNIT!

This product, when installed as indicated in the instructions contained in this manual, meets FCC requirements. Modifications not expressly approved by Yamaha may void your authority, granted by the FCC, to use the product.

## 2. IMPORTANT:

When connecting this product to accessories and/or another product use only high quality shielded cables. Cable/s supplied with this product MUST be used. Follow all installation instructions. Failure to follow instructions could void your FCC authorization to use this product in the USA.

## 3. NOTE:

This product has been tested and found to comply with the requirements listed in FCC Regulations, Part 15 for Class "B" digital devices. Compliance with these requirements provides a reasonable level of assurance that your use of this product in a residential environment will not result in harmful interference with other electronic devices. This equipment generates/uses radio frequencies and, if not installed and used according to the instructions found in the users manual, may cause interference harmful to the operation of other electronic devices. Compliance with FCC regulations does not guaran-

tee that interference will not occur in all installations. If this product is found to be the source of interference, which can be determined by turning the unit "OFF" and "ON", please try to eliminate the problem by using one of the following measures:

Relocate either this product or the device that is being affected by the interference.

Utilize power outlets that are on different branch (circuit breaker or fuse) circuits or install AC line filter/s.

In the case of radio or TV interference, relocate/reorient the antenna. If the antenna lead-in is 300 ohm ribbon lead, change the lead-in to co-axial type cable.

If these corrective measures do not produce satisfactory results, please contact the local retailer authorized to distribute this type of product. If you can not locate the appropriate retailer, please contact Yamaha Corporation of America, Electronic Service Division, 6600 Orangethorpe Ave, Buena Park, CA90620

The above statements apply ONLY to those products distributed by Yamaha Corporation of America or its subsidiaries.

\* This applies only to products distributed by YAMAHA CORPORATION OF AMERICA.

## NEDERLAND / NETHERLAND

- Dit apparaat bevat een lithium batterij voor geheugen back-up.
- This apparatus contains a lithium battery for memory back-up.
- Raadpleeg uw leverancier over de verwijdering van de batterij op het moment dat u het apparaat aan het einde van de levensduur afdankt of de volgende Yamaha Service Afdeling:  
Yamaha Music Nederland Service Afdeling  
Kanaalweg 18-G, 3526 KL UTRECHT  
Tel. 030-2828425
- For the removal of the battery at the moment of the disposal at the end of the service life please consult your retailer or Yamaha Service Center as follows:  
Yamaha Music Nederland Service Center  
Address : Kanaalweg 18-G, 3526 KL UTRECHT  
Tel : 030-2828425
- Gooi de batterij niet weg, maar lever hem in als KCA.
- Do not throw away the battery. Instead, hand it in as small chemical waste.

## ADVARSEL!

Lithiumbatteri—Eksplodingsfare ved fejlagtig håndtering. Udskiftning må kun ske med batteri af samme fabrikat og type. Levér det brugte batteri tilbage til leverandoren.

## VARNING

Explosionsfara vid felaktigt batteribyte. Använd samma batterityp eller en ekvivalent typ som rekommenderas av apparattillverkaren. Kassera använt batteri enligt fabrikantens instruktion.

## VAROITUS

Paristo voi räjähtää, jos se on virheellisesti asennettu. Vaihda paristo ainoastaan laitevalmistajan suosittelemaan tyyppiin. Hävitä käytetty paristo valmistajan ohjeiden mukaisesti.

# SPECIAL MESSAGE SECTION

This product utilizes batteries or an external power supply (adapter). DO NOT connect this product to any power supply or adapter other than one described in the manual, on the name plate, or specifically recommended by Yamaha.

**WARNING:** Do not place this product in a position where anyone could walk on, trip over, or roll anything over power or connecting cords of any kind. The use of an extension cord is not recommended! IF you must use an extension cord, the minimum wire size for a 25' cord (or less) is 18 AWG. NOTE: The smaller the AWG number, the larger the current handling capacity. For longer extension cords, consult a local electrician.

This product should be used only with the components supplied or; a cart, rack, or stand that is recommended by Yamaha. If a cart, etc., is used, please observe all safety markings and instructions that accompany the accessory product.

## SPECIFICATIONS SUBJECT TO CHANGE:

The information contained in this manual is believed to be correct at the time of printing. However, Yamaha reserves the right to change or modify any of the specifications without notice or obligation to update existing units.

This product, either alone or in combination with an amplifier and headphones or speaker/s, may be capable of producing sound levels that could cause permanent hearing loss. DO NOT operate for long periods of time at a high volume level or at a level that is uncomfortable. If you experience any hearing loss or ringing in the ears, you should consult an audiologist.

**IMPORTANT:** The louder the sound, the shorter the time period before damage occurs.

Some Yamaha products may have benches and / or accessory mounting fixtures that are either supplied with the product or as optional accessories. Some of these items are designed to be dealer assembled or installed. Please make sure that benches are stable and any optional fixtures (where applicable) are well secured BEFORE using. Benches supplied by Yamaha are designed for seating only. No other uses are recommended.

## NOTICE:

Service charges incurred due to a lack of knowledge relating to how a function or effect works (when the unit is operating as designed) are not covered by the manufacturer's warranty, and are therefore the owners responsibility. Please study this manual carefully and consult your dealer before requesting service.

## ENVIRONMENTAL ISSUES:

Yamaha strives to produce products that are both user safe and environmentally friendly. We sincerely believe that our products and the production methods used to produce them, meet these goals. In keeping with both the letter and the spirit of the law, we want you to be aware of the following:

## Battery Notice:

This product MAY contain a small non-rechargeable battery which (if applicable) is soldered in place. The average life span of this type of battery is approximately five years. When replacement becomes necessary, contact a qualified service representative to perform the replacement.

This product may also use "household" type batteries. Some of these may be rechargeable. Make sure that the battery being charged is a rechargeable type and that the charger is intended for the battery being charged.

When installing batteries, do not mix batteries with new, or with batteries of a different type. Batteries MUST be installed correctly. Mismatches or incorrect installation may result in overheating and battery case rupture.

## Warning:

Do not attempt to disassemble, or incinerate any battery. Keep all batteries away from children. Dispose of used batteries promptly and as regulated by the laws in your area. Note: Check with any retailer of household type batteries in your area for battery disposal information.

## Disposal Notice:

Should this product become damaged beyond repair, or for some reason its useful life is considered to be at an end, please observe all local, state, and federal regulations that relate to the disposal of products that contain lead, batteries, plastics, etc. If your dealer is unable to assist you, please contact Yamaha directly.

## NAME PLATE LOCATION:

The name plate is located on the top of the product. The model number, serial number, power requirements, etc., are located on this plate. You should record the model number, serial number, and the date of purchase in the spaces provided below and retain this manual as a permanent record of your purchase.

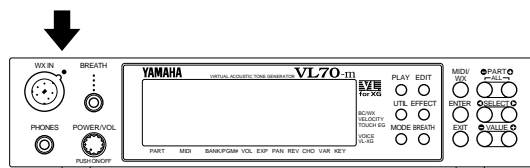

**Model**

---

**Serial No.**

---

**Purchase Date**

---

# PLEASE KEEP THIS MANUAL

*Thank you for choosing a Yamaha VL70-m Virtual Acoustic Tone Generator. The VL70-m is a monophonic tone generator incorporating Yamaha's revolutionary "Virtual Acoustic Synthesis" tone generation system — based on the most advanced computer physical modeling technology. Virtual Acoustic Synthesis produces sound that is more realistic, more expressive, and more musical than any other system available at this time. The VL70-m includes 256 preset voices, from super-realistic to innovative, that can add a new dimension to your sound ... whether you play a keyboard, wind controller, MIDI guitar synthesizer, or use a sequencer to create music.*

*Please read this owner's manual carefully, and follow the instructions within in order to ensure proper operation. Also keep this manual in a safe place for later reference.*

---

# About the Manual

The VL70-m is a very unique tone generator that operates on totally new principles that were simply unheard of until Yamaha released the worlds first “Virtual Acoustic” synthesizer based on computer physical modelling. If you’ve had some experience with the Yamaha VL1, VL1-m, VL-7, or their “Version 2” upgrades, you will have very little trouble understanding the VL70-m. If you are new to VA synthesis, however, you will need a little background before attempting to edit and modify voices. We urge you to read the following section of this manual — “Virtual Acoustic Synthesis — before getting into the details. It will make a huge difference in how quickly you understand the VL70-m system, and how efficiently you will be able to edit voices to create the sound you’re looking for.

Other than the above, the structure of the manual is fairly straightforward. You can approach it in a “linear” manner, reading through from beginning to end, or on an “on demand” basis, going directly to the information you need as you need it. Use the table of contents at the beginning, and the index at the end of the manual to find the information you need.

## Conventions

The following conventions are used through the VL70-m manuals to avoid confusion and make the text easier to read.

### ■ Buttons & Controls

Button and control names used on the VL70-m panel appear in the text in capital letters within square brackets: “the [ENTER] button”, for example.

### ■ Parameter Ranges

An ellipsis is used to indicate a range of parameter values: e.g. “0 ... 127”. This minimizes the confusion sometimes caused by the use of a hyphen or dash for this purpose.

---

# Contents

<b>Precautions</b>	4	<b>The VOICE PLAY Mode</b>	31
<b>Virtual Acoustic Synthesis</b>	6	The VOICE PLAY Main Control Mode . . . .	31
VA Advantages . . . . .	6	The VOICE PLAY Sub-control Mode . . . . .	34
The VL70-m Model . . . . .	7	<b>The VL-XG PLAY Mode</b>	36
■ The Instrument . . . . .	8	● A Simple XG System Incorporating the VL70-m . . . . .	36
■ The Controllers . . . . .	9	The VL-XG PLAY Main Control Mode . . . .	37
■ The Modifiers . . . . .	10	The VL-XG PLAY Sub-control Mode . . . . .	40
There's More ... . . . .	11	<b>Controllers &amp; Control Editing</b>	42
<b>The Controls &amp; Connectors</b>	12	● Physical Controllers . . . . .	43
■ Front Panel . . . . .	12	● VL70-m Controller Parameters . . . .	45
■ Rear Panel . . . . .	14	Accessing & Editing the Control Parameters . . . . .	46
<b>Setting Up</b>	15	The Control Edit Parameters . . . . .	48
Power Supply . . . . .	15	■ VOICE Sound Module Mode Control Edit Parameters . . . . .	48
MIDI Connections . . . . .	16	■ VL-XG Sound Module Mode Control Edit Parameters . . . . .	50
Breath Controller . . . . .	17	■ Control Edit Parameter Descriptions .	52
WX-series Wind MIDI Controller . . . . .	18	● Pitch Bend . . . . .	52
G50 Guitar MIDI Converter . . . . .	19	● Modulation Wheel . . . . .	53
Connecting to a Personal Computer . . . . .	20	● Aftertouch . . . . .	53
■ Connecting to an Apple Macintosh Series Computer . . . . .	20	● Assignable Controller . . . . .	54
■ Connecting to an IBM PC/AT Series Computer . . . . .	21	● Expression . . . . .	54
■ Connecting to an NEC PC-9801/9821 Series Computer . . . . .	21	● Pressure . . . . .	55
Audio Connections . . . . .	22	● Filter . . . . .	55
● Headphones . . . . .	22	● Amplitude . . . . .	56
● Stereo Sound System . . . . .	22	● Embouchure . . . . .	57
Power-on Procedure . . . . .	23	● Tonguing . . . . .	58
Play the Demo . . . . .	24	● Scream . . . . .	59
The Supplied Demo Disk . . . . .	25	● Breath Noise . . . . .	60
The VL70-m Voice Editing Software . . . . .	25	● Growl . . . . .	61
<b>Voice Organization and Sound Module Modes</b>	26	● Throat Formant . . . . .	62
Voice Organization . . . . .	26	● Harmonic Enhancer . . . . .	62
The VL70-m Sound Module Modes . . . . .	27	● Damping . . . . .	63
■ The VOICE Mode . . . . .	27	● Absorption . . . . .	64
■ The VL-XG Mode . . . . .	28		
■ Selecting the VOICE or VL-XG Sound Module Mode . . . . .	29		
● VL Extension for XG . . . . .	30		

---

## **Filter & Envelope Generator Editing** 66

- Amplitude & Filter EG ..... 66
- Pitch & Embouchre EG ..... 66
- Accessing & Editing the Filter & EG Parameters ..... 67
- The Filter & EG Edit Parameters ..... 69
  - VOICE Sound Module Mode Filter & EG Edit Parameters ..... 69
  - VL-XG Sound Module Mode Filter & EG Edit Parameters ..... 70
  - Filter & EG Edit Parameter Descriptions ..... 71
    - Filter ..... 71
    - Amplitude & Filter Envelope ... 72
    - Pitch & Embouchure Envelope ... 73

## **Other Edit Parameters** 75

- Accessing & Editing the “Others” Parameters ..... 75
- The “Others” Edit Parameters ..... 77
  - VOICE Sound Module Mode “Others” Edit Parameters ..... 77
  - VL-XG Sound Module Mode “Others” Edit Parameters ..... 78
  - “Others” Edit Parameter Descriptions 79
    - Vibrato ..... 79
    - Detune & Voice Level ..... 79
    - Assignment & Expansion ..... 80
    - Velocity Sensitivity ..... 81
    - Note Limits ..... 81
    - Portamento ..... 82
    - Dry Level & Voice Name ..... 82

## **The Store Function** 84

- Storing an Edited Voice ..... 84

## **Effects & Effect Editing** 86

- Effect Signal Flow ..... 86
  - When the Variation Stage is an Insertion Effect ..... 86
  - When the Variation Stage is a System Effect ..... 87
- Accessing & Editing the Effect Parameters 88
- The Reverb Parameters ..... 90
- The Chorus Parameters ..... 91
- The Variation Parameters ..... 92
- The Distortion Parameters ..... 94

## **Breath Settings** 95

- Accessing & Editing the Breath Parameters 95
- The Breath Parameters ..... 96

## **The Utility Mode** 97

- The System Parameters ..... 98
- The Dump Out Function ..... 100
  - DUMPOUT Operation ..... 100
- The Initialize Function ..... 102

## **Appendix** 103

- Show Control Change ..... 103
- Show Exclusive ..... 103
- The Message Window ..... 104
  - Message Window Data Format . 104
- Bitmap Window ..... 105
  - Bitmap Window Data Format .. 105
  - Creating Bitmap Data ..... 105
- Checksum ..... 106
- Troubleshooting ..... 107
- Answers to Some Common Questions .. 110
- Error Messages ..... 112
- Specifications ..... 113

## **Index** 114

---

# Precautions !! PLEASE READ THIS BEFORE PROCEEDING !!

## ■ Location

Do not expose the instrument to the following conditions to avoid deformation, discoloration, or more serious damage.

- Direct sunlight (e.g. near a window).
- High temperatures (e.g. near a heat source, outside, or in a car during the daytime).
- Excessive humidity.
- Excessive dust.
- Strong vibration.

## ■ Power Supply

- Turn the power switch OFF when the instrument is not in use.
- The power adaptor should be unplugged from the AC outlet if the instrument is not to be used for an extended period of time.
- Unplug the instrument during electric storms.
- Avoid plugging the instrument into the same AC outlet as appliances with high power consumption, such as electric heaters or ovens. Also avoid using multi-plug adaptors since these can result in reduced sound quality and possibly damage.

## ■ Turn Power OFF When Making Connections

- To avoid damage to the instrument and other devices to which it is connected (a sound system, for example), turn the power switches of all related devices OFF prior to connecting or disconnecting audio and MIDI cables.

## ■ MIDI Connections

- When connecting the VL70-m to MIDI equipment, be sure to use high-quality cables made especially for MIDI data transmission.
- Avoid MIDI cables longer than about 15 meters. Longer cables can pick up electrical noise that can cause data errors.

## ■ Handling and Transport

- Never apply excessive force to the controls, connectors or other parts of the instrument.
- Always unplug cables by gripping the plug firmly, not by pulling on the cable.
- Disconnect all cables before moving the instrument.
- Physical shocks caused by dropping, bumping, or placing heavy objects on the instrument can result in scratches and more serious damage.



---

### ■ Cleaning

- Clean the cabinet and panel with a dry soft cloth.
- A slightly damp cloth may be used to remove stubborn grime and dirt.
- Never use cleaners such as alcohol or thinner.

### ■ Electrical Interference

- This instrument contains digital circuitry and may cause interference if placed too close to radio or television receivers. If this occurs, move the instrument further away from the affected equipment.

### ■ Data Backup

- The VL70-m contains a special long-life battery that retains the contents of its internal memory even when the power is turned OFF. The backup battery should last for several years. When the backup battery needs to be replaced “Battery Low!” will appear on the display when the power is turned on. When this happens, have the backup battery replaced by qualified Yamaha service personnel. **DO NOT ATTEMPT TO REPLACE THE BACKUP BATTERY YOURSELF!**

### ■ Service and Modification

- The VL70-m contains no user serviceable parts. Opening it or tampering with it in any way can lead to irreparable damage and possibly electric shock. Refer all servicing to qualified YAMAHA personnel.

### ■ Third-party Software

- Yamaha can not take any responsibility for software produced for this product by third-party manufacturers. Please direct any questions or comments about such software to the manufacturer or their agents.

**YAMAHA is not responsible for damage caused by improper handling or operation.**

---

# Virtual Acoustic Synthesis

Unlike previous tone generation systems which use oscillators, function generators, preset waveforms or samples to produce sound, Yamaha Virtual Acoustic (“VA”) Synthesis applies sophisticated computer-based “physical modeling” technology to musical sound synthesis. In the same way that computer “models” are used to simulate weather systems or the flight characteristics of aircraft in the design stage, the VL70-m simulates the very complex vibrations, resonances, reflections and other acoustic phenomena that occur in a real wind or string instrument.

## VA Advantages

The VL70-m offers many advantages in terms of musical performance. Not just in terms of sound, but also in terms of the “behavior” that makes acoustic instruments so ... well, musical! Yamaha Virtual Acoustic Synthesis is simply the most musical tone generation system ever created.

- The VL70-m sounds better, has more depth, and is more realistic in the musical sense than any other tone generation system.
- Simply playing a note in the same way does not always produce precisely the same sound. The instrument is responsive and “alive”.
- Note-to-note transitions have the same continuity exhibited by acoustic instruments. What goes on in between the notes is just as important musically as the notes themselves.
- It has extraordinary expressive capability. Rather than simply controlling parameters like volume or pitch, you can control characteristics such as breath and reed pressure with appropriate complex effects on the timbre of the sound.

---

## The VL70-m Model

The overall VL70-m model or “algorithm” consists of three main blocks: the instrument, controllers, and modifiers. In schematic form these blocks are arranged as follows:

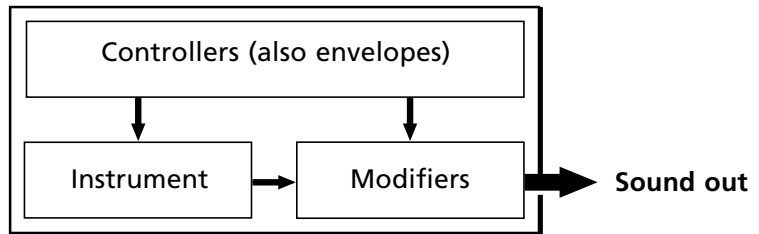

## The Instrument

The key block in this algorithm is the instrument, since it is here that the fundamental tone or “timbre” of the sound is defined. The instrument model consists primarily of a driver — the reed/mouthpiece, lip/mouthpiece, or bow/string system — and a resonant system corresponding to the tube and air column or string.

### ■ NOTES

- *The sound thus produced is amplified and sustained by the body of the instrument.*
- *The pitch of the sound is determined by the length of the air column or string, and the timbre is a complex product of the driving source (reed, lip, air, string), the shape of the resonant cavity, the materials from which the instrument is made, etc.*

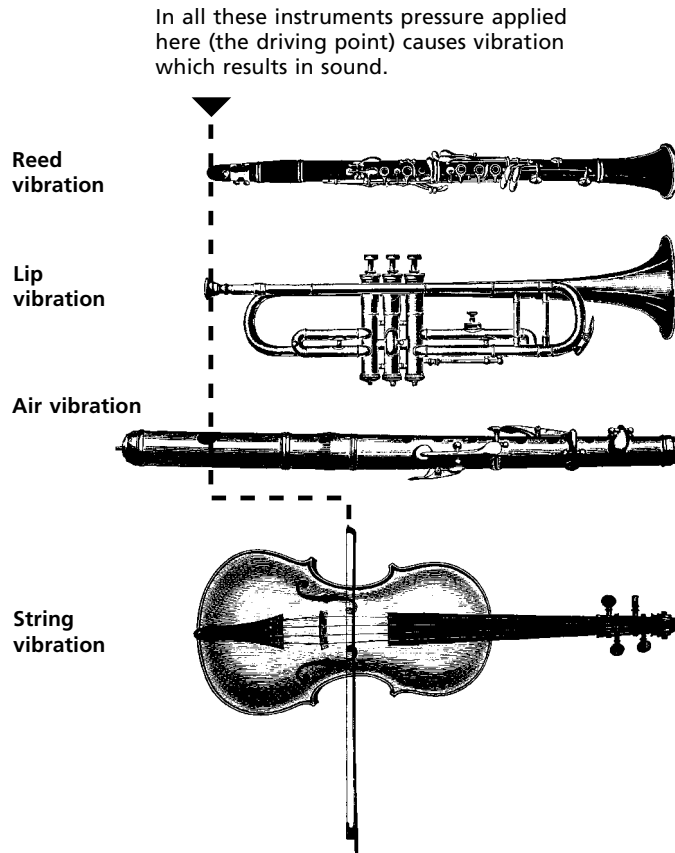

One of the remarkable features of the VL70-m’s Virtual Acoustic Synthesis system is that just about any driver can be used with any type of pipe or string.

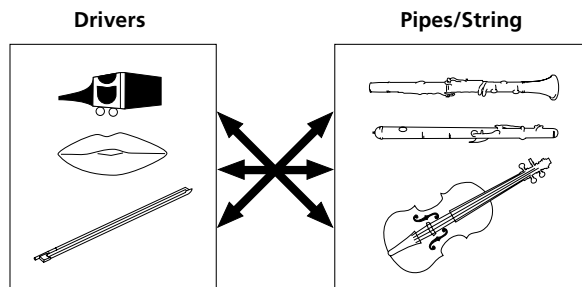

---

## The Controllers

The input to an acoustic wind instrument comes from the player's lungs, trachea, oral cavity, and lips. In a string instrument it comes from the player's arm movement, transmitted to the string via a bow. These elements actually form an important part of the sound generating system and, in the VL70-m model, are included in the controllers block. The player also influences the sound of the instrument by playing the keys, tone holes, or frets, and this aspect of control constitutes another part of the controllers block. These and other control parameters provided by the VL70-m are listed in the illustration below.

In essence, the controller parameters determine how the instrument "plays". All of these parameters can be assigned to any external controller that can be used with the VL70-m: breath controller, foot controller, modulation wheel, etc. The pressure parameter, for example, will normally be assigned to a breath controller so the player can control the dynamics of the instrument by varying the breath pressure applied to the controller — a natural, instinctive way to play wind-instrument voices. At the same time the growl and throat parameters might also be assigned to the breath controller in order to achieve life-like response and effects.

### Embouchure

The tightness of the lips against the reed or against each other, or the force of the bow against the string.

### Tonguing

Simulates the half-tonguing technique used by saxophone players by changing the "slit" of the reed.

### Pitch

Changes the length of the air column or string, and thereby the pitch of the sound.

### Damping & Absorption

Simulate the effects of air friction in the pipe or on the string, and of high-frequency losses at the end of the pipe or string.

### Throat

Controls the characteristics of the "player's" throat or bowing arm.

### Pressure

The amount of breath pressure applied to the reed or mouthpiece, or bow velocity applied to the string.

### Growl

A periodic pressure (bow velocity) modulation which produces the "growl" effect often heard in wind instruments.

### Scream

Drives the entire system into chaotic oscillation, creating effects that can only be achieved with physical modelling technology.

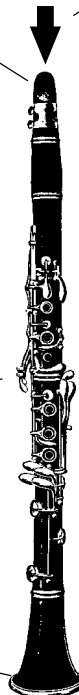

---

## The Modifiers

The modifiers block consists of 4 sections as shown in the diagram. Although these may appear to be simple effects, they are actually intimately related to the VL70-m's sound-producing model and have a significant effect on the sound (the VL70-m has a separate effects stage with reverb, chorus, variation, and distortion effects — see page 86).

### ● Harmonic Enhancer

The Harmonic Enhancer determines the harmonic structure of the sound to the extent that it can produce radical timbral variations within an instrument “family” (e.g. saxes). The harmonic enhancer parameters can be accessed via the Yamaha VL70-m Expert Editor software (page 25).

### ● Dynamic Filter

This section is similar to the dynamic filters found in many conventional synthesizers, with high-pass, bandpass, band elimination, and low-pass modes. Some filter parameters are available via the VL70-m controls, but detailed editing of parameters such as the filter type requires the Yamaha VL70-m Expert Editor software (page 25)

### ● Frequency Equalizer

This is a 5-band parametric equalizer with frequency, Q (bandwidth), and level control. The equalizer also has pre-EQ high- and low-pass filters as well as key scaling capability for precise response control throughout the instrument's range. Although only simplified treble and bass parameters are available via the VL70-m controls, the full range of equalizer parameters can be accessed via the Yamaha VL70-m Expert Editor software (page 25).

### ● Resonator

The Resonator uses simulated “resonator” pipes or strings and delays to produce a “woody” resonance effect — although it has little or no effect on some voices. The resonator parameters can be accessed via the Yamaha VL70-m Expert Editor software (page 25).

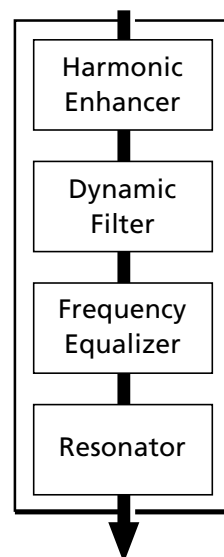

---

## **There's More ...**

In this brief introduction to VL70-m basics we've only looked at the central physical model which is the key to the VL70-m's unprecedented sound and musical performance. There's actually much more to it. There's also an extensive range of other functions and features that are similar to those you may be familiar with from conventional synthesizers. There are, for example, programmable envelopes that can be applied to most of the controllers in addition to real-time player control. And, of course, there's a comprehensive selection of utility functions that give the VL70-m maximum versatility and convenience. Now that you understand the basics, dive in and find out what the VL70-m can really do.

---

# The Controls & Connectors

The following brief descriptions of the VL70-m controls and connectors should help you to understand the overall logic of the interface.

## Front Panel

### ❶ [POWER/VOL] Control

Press to turn power ON or OFF. Rotate to adjust overall output volume (clockwise to increase the volume).

### ❷ Breath Controller Jack

An optional Yamaha BC3, BC2 or BC1 Breath Controller can be plugged in here.

➤ *page 17*

### ❸ WX IN Jack

Allows direct connection of a Yamaha WX-series Wind MIDI Controller such as the WX11 or WX7, without the need for a WT11 or BT7 wind controller interface.

➤ *page 18*

### ❹ PHONES Jack

Accepts a standard pair of stereo headphones (stereo mini phone plug) for headphone monitoring of the VL70-m sound without the need for external amplification equipment. The volume of the headphone sound is adjusted via the [POWER/VOL] control.

### ❺ Display

This large backlit liquid crystal display panel shows all parameters and prompts necessary for easy, efficient operation and programming of the VL70-m. The display contrast can be adjusted as described on page 99.

➤ *page 31*

### ❻ [PLAY] Button

Press this button to select the VL70-m PLAY mode in which voices can be selected and played. If the PLAY mode is already selected,

pressing the [PLAY] button causes the currently selected voice to sound — a convenient test feature.

➤ *page 31*

### ❼ [EDIT] Button

Activates the VL70-m EDIT mode in which voices can be edited to create new sounds.

➤ *page 46*

### ❽ [UTIL] Button

Selects the VL70-m UTILITY mode. The UTILITY mode includes a range of important utility functions that affect operation of the VL70-m: SYSTEM SETUP, DUMP OUT, INITIALIZE, and DEMO SONG.

➤ *page 97*

### ❾ [EFFECT] Button

Selects the VL70-m EFFECT mode in which the built-in reverb, chorus, variation, and distortion effects can be assigned and edited as required.

➤ *page 88*

### ❿ [MODE] Button

Accesses the VL70-m sound module mode selection function.

➤ *page 29*

### ⓫ [BREATH] Button

Selects the BREATH SETTING which includes parameters that determine how the VL70-m responds to control from a breath controller, WX-series Wind MIDI Controller, or similar device.

➤ *page 95*



## 12 [MIDI/WX] Button

Pressing this button alternately selects the VL70-m MIDI and WX control modes (when the rear-panel HOST SELECT switch is set to Mac, PC-1, PC-2).

➤ page 18

## 13 [ENTER] Button

The [ENTER] button is used to engage sub-modes, confirm input, and execute certain operations. Double-clicking this button (i.e. press the button twice in rapid succession) provides access to the SHOW CONTROL and SHOW EXCLUSIVE (page 103) modes.

➤ page 24

## 14 [EXIT] Button

This button is used to exit from sub-modes and cancel certain operations. No matter where you are in the VL70-m display structure, pressing the [EXIT] button (a number of times if necessary) will eventually return you to the PLAY mode.

➤ page 24

## 15 PART [-] and [+] Buttons

When the VL-XG sound module mode is selected (page 28) these buttons select the part to be played. Either button can be pressed briefly for single stepping in the specified direction, or held for continuous scrolling. In either the VL-

XG or VOICE sound module mode (page 27) pressing both buttons simultaneously switches in and out of the PLAY mode sub-control mode (pages 34 and 40).

When the EDIT mode is selected the PART buttons can be used to switch between parameters without having to return to the EDIT mode menu.

➤ page 36

## 16 SELECT [◀] and [▶] Buttons

These buttons are used to select sub-modes or parameters. In some cases the selection will be made from a menu displays, and in others the SELECT buttons will actually switch display pages.

➤ page 31

## 17 VALUE [-] and [+] Buttons

Used to select voices and edit parameter values. Either button can be pressed briefly for single stepping in the specified direction, or held for continuous scrolling. They also have a large-step function which allows you to skip ahead or backward in larger increments when selecting voices or editing numeric parameters: press either the [-] or [+] button while holding the other button.

➤ page 31

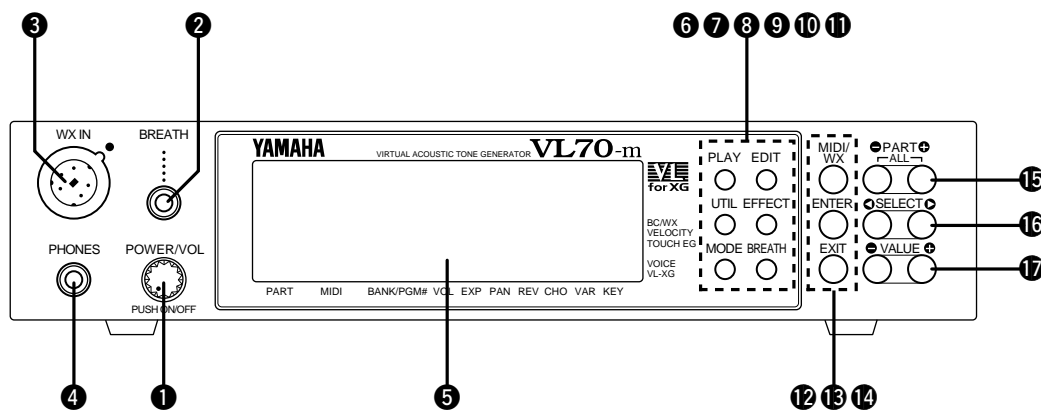

---

## Rear Panel

### 18 DC IN Connector

The DC output cable from the Yamaha PA-3B AC Power Adaptor supplied with the VL70-m is plugged in here.

➤ page 15

### 19 OUTPUT L/MONO and R Jacks

These are the main stereo outputs from the VL70-m. Be sure to connect both outputs to the appropriate channels of a stereo sound system in order to appreciate the full quality of the VL70-m sound and effects. The L/MONO jack can be used alone when connecting to a mono sound system (e.g. a musical instrument amplifier).

➤ page 22

### 20 MIDI IN, OUT and THRU Connectors

The MIDI IN connector receives the data from an external sequencer or other MIDI device which is to control or transmit data to the VL70-m. The MIDI THRU connector simply re-transmits the data received at the MIDI IN connector, allowing convenient chaining of MIDI devices. The MIDI OUT connector transmits data corresponding to VL70-m Breath Controller operation, or bulk data when one of the MIDI data transmission functions are activated. The MIDI OUT connector can also be used to “echo” (re-transmit) data received via the MIDI IN or TO HOST connectors.

➤ page 16

### 21 TO HOST Connector & HOST SELECT Switch

This jack and selector switch allow direct connection to a personal computer for sequencing and other music applications — without the need for a separate MIDI interface.

➤ page 20

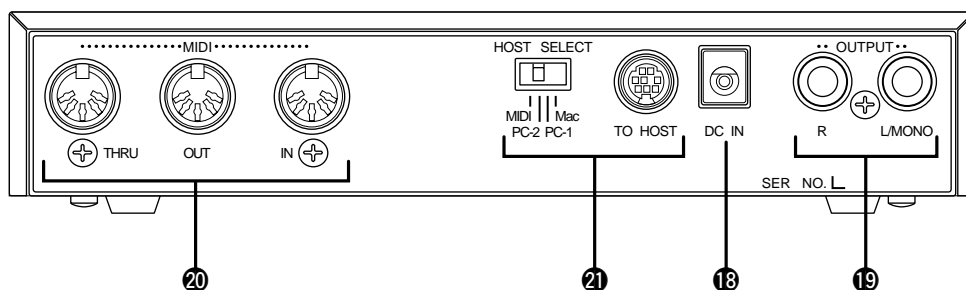

# Setting Up

## Power Supply

Your VL70-m comes supplied with a Yamaha PA-3B AC adaptor. Plug the DC output cable from the AC adaptor into the DC IN jack on the rear panel, then plug the adaptor into a convenient wall AC power socket. It is also a good idea to clip the adaptor's DC cable into the cable clip on the VL70-m rear panel to minimize the possibility of accidentally unplugging the cable during operation.

### ■ CAUTION

- Do not attempt to use an AC adaptor other than the supplied unit or an appropriate replacement provided by your Yamaha dealer to power the VL70-m. The use of an incompatible adaptor may cause irreparable damage to the VL70-m, and might pose a serious shock hazard!
- Be sure to unplug the AC adaptor from the AC mains socket when the VL70-m is not in use.

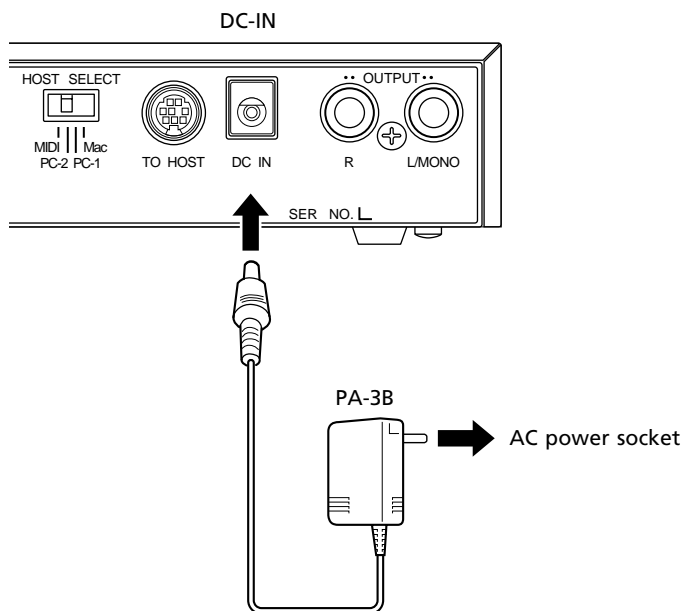

---

## MIDI Connections

The VL70-m can be used with virtually any type of MIDI controller: keyboard, wind controller, sequencer, etc. To ensure reliable error-free transfer of MIDI data always use high-quality MIDI cables obtained from your Yamaha dealer or music equipment store. Also avoid MIDI cables that are longer than about 15 meters, since cables longer than this can pick up noise which can cause data errors.

The VL70-m MIDI receive channel and device number parameters are available via the PLAY mode display and PLAY mode sub-control display (pages 32 and 34). Make sure these parameters are set to match the corresponding settings of the MIDI controller used with the VL70-m.

### ● The VL70-m receives the following MIDI data:

<b>Note</b>	The played note and velocity values.
<b>Control Change</b>	Modulation wheel, breath controller, foot controller, sustain, and other controller data.
<b>Aftertouch</b>	Keyboard aftertouch pressure (channel aftertouch only).
<b>Pitch Bend</b>	Pitch bend wheel position.
<b>Program Change &amp; Bank Select</b>	Voice numbers and bank select messages.
<b>System Exclusive</b>	Voice and system data transmitted in the form of "bulk dumps."

### ■ NOTES

- **IMPORTANT!:** The rear-panel *HOST SELECT* switch must be set to "MIDI" when the VL70-m is not connected to a computer via the *TO HOST* connector.
- For detailed MIDI specifications refer to the "MIDI Data Format" on page 26 of the *List Book*.
- When using the VL70-m with other MIDI equipment, it is a good idea to refer to the MIDI specifications (implementation chart, MIDI data format) of the equipment used to ensure compatibility.

---

## Breath Controller

If you will be using the VL70-m with a keyboard, a breath controller is an essential expressive tool — both for realistic expression with wind-instrument voices and unprecedented expressive control with string voices. Plug an optional Yamaha BC3, BC2 or BC1 Breath Controller into the front-panel breath controller jack. If the controlling MIDI keyboard has a breath controller jack, it might be more convenient to plug the breath controller in there rather than directly into the VL70-m. The Breath Controller is ideal for controlling parameters that would normally be affected by a wind player's breath: dynamics, timbre, pitch, and others.

### ■ IMPORTANT!

- If you will be using a BC3, BC2, or BC1 breath controller plugged into the BREATH jack, the "Breath Mode" parameter must be set to "BC/WX" (page 96). This is also necessary if you plug the breath controller into the keyboard's breath controller jack.

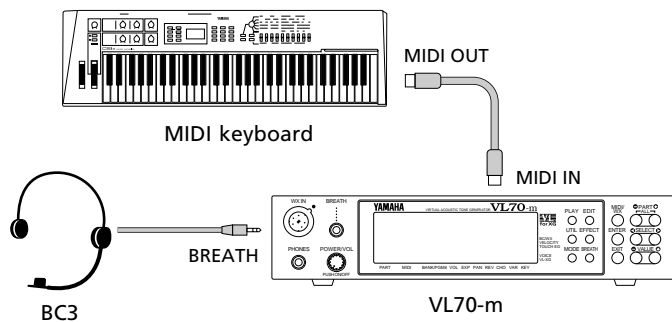

## WX-series Wind MIDI Controller

The VL70-m is an ideal tone generator for use with a Yamaha WX-series Wind MIDI Controller such as the WX11 or WX7. In either case the controller can be plugged directly into the WX IN connector on the VL70-m front panel, without the need for a WT11 or BT7 wind controller interface.

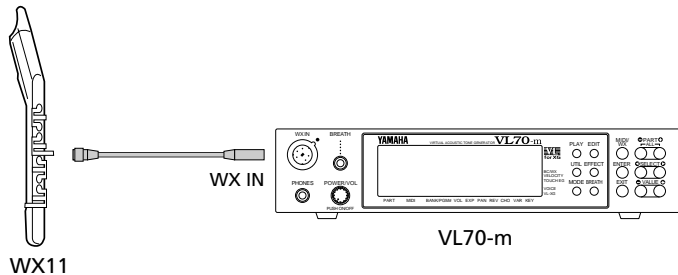

Special care must be taken with the following parameters and controls when using a WX-series Wind MIDI Controller:

### ■ NOTES

- If a WX controller is unplugged while the VL70-m power is on, the breath level may remain fixed at "0" and subsequently played notes may not sound. If this happens, turn the VL70-m power off and then on again.

<b>BREATH MODE</b>	The Breath Mode parameter (page 96) must be set to "BCWX" in order for the VL70-m to recognize breath data from the controller.
<b>SOUND MODULE MODE</b>	If you intend to drive additional MIDI devices via the VL70-m MIDI OUT connector when using a Wind MIDI Controller, the VL70-m sound module mode should be set to VOICE (page 29). When the VL-XG mode is selected MIDI note data received via the MIDI IN connector is not re-transmitted via the MIDI OUT connector.
<b>LIP MODE</b>	WX-series Wind MIDI Controllers produce pitch bend data ranging from "-16" to "+32" in response to lip (reed) pressure. The WX Lip parameter (page 98) determines whether these values are used as is ("Norm"), or expanded to a "-64" through "+63" range ("Expd"). When the "Expd" mode is selected, the expanded pitch bend data is also transmitted via the MIDI OUT connector. The "Expd" setting is recommended when using a WX controller in the "tight lip" mode. The "Norm" setting is recommended when using the WX controller "loose lip" mode.
<b>MIDI/WX SETTING</b>	When the VL70-m is connected to a WX controller <u>and</u> a computer via the TO HOST connector, and the HOST SELECT switch is set to any position other than "MIDI", the front-panel [MIDI/WX] button must be used to select the "WX" mode (a small WX icon will appear on the left side of the display) in order for the VL70-m to recognize data from the WX controller. When the HOST SELECT switch is set to "MIDI" the VL70-m accepts both MIDI and WX data (both the MIDI and WX icons appear on the display), and the [MIDI/WX] button has no effect.

---

## G50 Guitar MIDI Converter

The Yamaha G50 is a high-performance Guitar MIDI Converter designed to work in conjunction with the Yamaha G1D Divided Pickup Unit installed on an electric or steel-string acoustic guitar. The G50 offers unprecedented MIDI guitar synthesizer performance with exceptionally fast response and a range of advanced features that bring the true creative potential of MIDI control to guitar players for the first time. Naturally, the VL70-m is an ideal tone generator for use with a MIDI guitar system based on the G50.

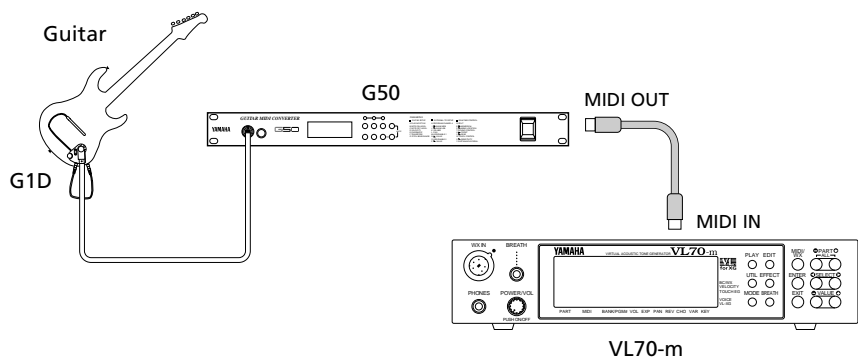

Since the G50 produces MIDI output, the standard MIDI connection rules that apply to a keyboard or any other MIDI controller also apply when connecting the G50 to the VL70-m (page 16).

## Connecting to a Personal Computer

Although the VL70-m can be connected to a personal computer via the MIDI IN/OUT connectors and a MIDI interface, the TO HOST connector and selector switch allow direct connection to Apple Macintosh, IBM PC/AT, or NEC PC-9801/9821 series personal computers for sequencing and other music applications without the need for a separate MIDI interface.

### ■ IMPORTANT!

- If the VL70-m is to be connected to a computer via the TO HOST connector and a MIDI controller via the MIDI IN connector, the “echo back” function of the music software or sequencer you are using must be turned “on” so that the MIDI note data from the controller is returned to the VL70-m and any subsequent devices connected to the VL70-m MIDI OUT connector.

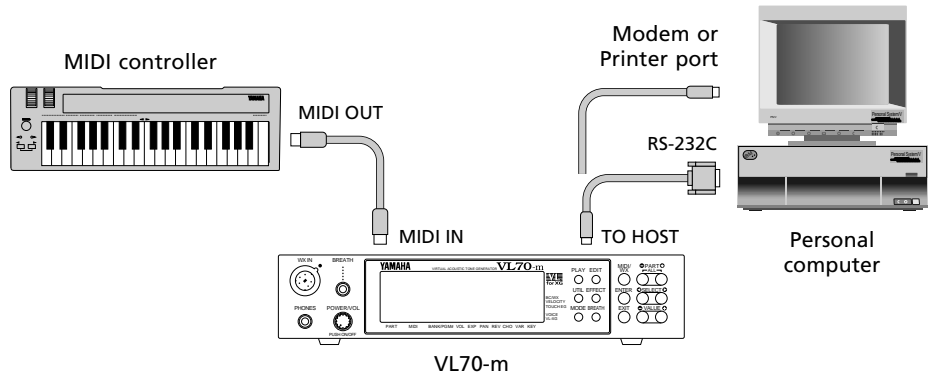
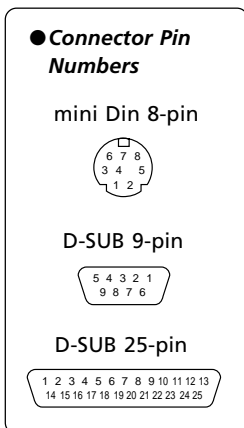

## Connecting to an Apple Macintosh Series Computer

Connect the TO HOST connector of the VL70-m to the modem or printer port on your Macintosh, depending on which port your MIDI software is using for MIDI data communication, using a standard Macintosh 8-pin system peripheral cable. Set the TO HOST selector to the “Mac” position.

You may also have to make other MIDI interface settings on the computer side, depending on the type of software you use (refer to your software owner’s manual). In any case the clock speed should be set to 1 MHz.

### ● “Mac” Cable Connections

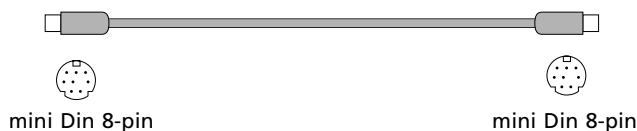

- 8-pin system peripheral cable.
- Data transfer rate: 31,250 bps.



---

## Connecting to an IBM PC/AT Series Computer

Connect the TO HOST connector of the VL70-m to the RS-232C port on your IBM computer, using a standard 8-pin MINI DIN → 9-pin D-SUB cross cable. Set the TO HOST selector to the “PC-2” position. Refer to your software owner’s manual for information on any settings you might have to make on the computer side.

### ● “PC-2” Cable Connections



- 8-pin mini DIN → 9-pin D-SUB cable. Use a “PC-1” type cable if your computer uses a 25-pin serial port.
- Data transfer rate: 38,400 bps.

## Connecting to an NEC PC-9801/9821 Series Computer

The NEC PC-9801/9821 computers are widely used in Japan. Connect the TO HOST connector of the VL70-m to the RS-232C port on your NEC computer, using a standard 8-pin MINI DIN → 25-pin D-SUB cross cable. Set the TO HOST selector to the “PC-1” position. Refer to your software owner’s manual for information on any settings you might have to make on the computer side.

### ■ NOTES

- If your system doesn’t work properly with the connections and settings listed above, your software may require different settings. Check your software operation manual and set the HOST SELECT switch to the position the provides the appropriate data transfer rate.

### ● “PC-1” Cable Connections

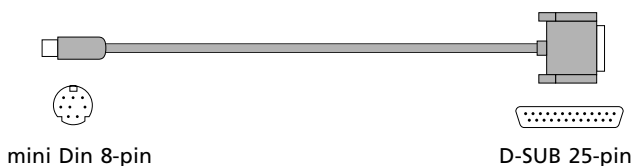

- 8-pin mini DIN → 25-pin D-SUB cable. Use a “PC-2” type cable if your computer uses a 9-pin serial port.
- Data transfer rate: 31,250 bps.

---

## Audio Connections

### ■ Headphones

For private listening and practice headphones are ideal. You don't have to hook up and complete sound system, and you won't disturb the neighbors no matter how loud or late you play. Any standard pair of stereo headphones with a stereo mini phone plug and an impedance of between about 8 and 150 ohms can be used.

### ■ Stereo Sound System

The VL70-m voices and effects are designed to sound their best in stereo, so you should always use a stereo sound system to appreciate the full impact of the VL70-m voices and expressive features. The VL70-m OUTPUT L/MONO and R jacks can be connected directly to musical instrument amplifiers designed for keyboard use, or to the line inputs of a mixing console. It is also possible to connect the VL70-m outputs directly to the inputs of a multitrack or stereo tape recorder.

#### ■ NOTES

- *If you need to drive a mono amp or other device, connect only the L/MONO output jack. The left and right channel signals are automatically combined and delivered via the L/MONO jack when a single phone plug is inserted in this jack and the R output jack is left unconnected.*
- *Make sure that both the VL70-m and your sound system are turned OFF when making connections.*

---

## Power-on Procedure

Always follow proper procedure when powering-up a sound system to minimize the possibility of damage to the equipment (and your ears!).

1. Make sure your sound system's main level/volume control(s) and the VL70-m volume control are turned all the way down prior to turning power on.
2. Turn on the VL70-m.
3. Turn on your MIDI controller (and computer/sequencer, if used).
4. Turn on the sound system.
5. Raise the sound system volume to a reasonable level.
6. Gradually raise the VL70-m VOLUME control while playing the MIDI controller to set the desired listening level.

### ■ NOTES

- Some keyboards and other MIDI controllers automatically transmit MIDI control change data corresponding to their control status when the power switch is turned ON or OFF. The VL70-m is programmed to receive this data and respond accordingly, so it is preferable to turn the VL70-m ON before turning the controlling device ON.

---

## Play the Demo

Once you've set up your VL70-m system, you might like to play the pre-programmed demo sequence to hear how some of the voices sound. This process will also help to familiarize you with some of the VL70-m's selection and editing procedures.

### ■ NOTES

- When the demo is played all system setup parameters and current voice are initialized. If your VL70-m memory contains data you want to keep, be sure to use the bulk dump function (page 100) to save the data to an external MIDI data recorder or other appropriate storage device before playing the demo.

#### 1. Select the Utility Mode

Press the [UTILITY] button to select the utility mode.

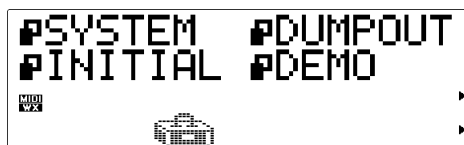

#### 2. Select the Demo Mode

Use the SELECT [◀] and [▶] buttons to select the “DEMO” mode.

#### 3. Press [ENTER] and Confirm

Press the [ENTER] button if it's OK to go ahead with the demo. The VL70-m will ask you to confirm: press [ENTER] again to proceed to the demo song select display, or [EXIT] to abort.

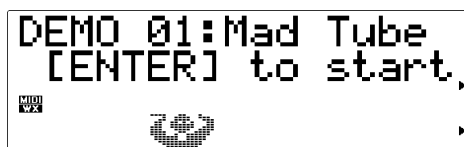

#### 4. Select a Song

Use the VALUE [-] and [+] buttons to select the demo song number you want to start with.

#### 5. Run the Demo

Press the [ENTER] button to run the demo. Playback will start with the selected song, then all other songs will be played in sequence. The cycle will repeat until stopped.

#### 6. Stop the Demo

Press the [EXIT] button to stop demo playback. This will return you to the demo song select display.

#### 7. Return To the Play Mode When Done

Press the [PLAY] button to return to the PLAY mode.

---

## The Supplied Demo Disk

The VL70-m is supplied with a demonstration data disk which contains several songs which demonstrate some of the VL70-m's advanced musical capabilities. The songs on this disk can be reproduced using any sequencer or computer-based sequence software which can handle SMF (Standard MIDI File — format 0) song files.

All of the demo songs use the VL70-m for the main melody line, while a second XG tone generator (Yamaha MU50 or MU80 for example) supplies the backing.

### ■ NOTES

- *The supplied disk is a 2DD type (720 kilobytes) using MS-DOS format. The disk can be read by Macintosh computers by using the PC Exchange application and an application such as ResEdit which can change the file's file type.*

## The VL70-m Voice Editing Software

### — What It Is & Where To Get It —

The range of parameters accessible via the VL70-m programming interface is limited to the simplest “upper level” of virtual acoustic synthesis parameters. The “core” parameters which are the true foundation of physical modeling are extremely complex, and were therefore not made directly accessible.

The VL70-m Expert Editor voice editing software provides full access to the complete range of physical modeling parameters. It can be used alone to create new voices, or edit voices loaded from the VL70-m. The VL70-m Expert Editor is basically a refined version of the editing software Yamaha voicing professionals use to create original voices for VL-series synthesizers and tone generators. It therefore gives you full professional-level programming power and potential. Another handy VL editing software is the VL Visual Editor. The VL Visual Editor makes it easy for anyone to create new VL voices via a graphic, easy-to-use editing interface. The VL70-m Expert Editor can read voice files created by the VL Visual Editor, allowing further in-depth programming.

The VL Voice Editing Software can be obtained via Yamaha's XG home page on the World Wide Web, “<http://www.yamaha.co.jp/english/xg/html/libhm.html>”.

# Voice Organization and Sound Module Modes

## Voice Organization

The VL70-m voices are organized into four main banks. Additional banks are used when the VL70-m is set to operate in the VL-XG sound module mode (page 29). The four main banks are as follows:

<b>PRESET 1</b>	The PRESET 1 bank contains 128 preset voices which have been created primarily to be played via a keyboard.
<b>PRESET 2</b>	The PRESET 2 bank contains 128 preset voices which have been created to provide maximum expressive capability when played with a breath controller or WX-series Wind MIDI Controller.
<b>CUSTOM</b>	The CUSTOM bank has 6 memory locations in which voices can be edited in detail via an appropriate personal computer and the Yamaha VL70-m Expert Editor application software (page 25). When the VL70-m is initially shipped CUSTOM voice numbers 001 through 006 contain a selection of sound-effect type voices from the PRESET banks.
<b>INTERNAL</b>	The INTERNAL bank has 64 memory locations in which voices you have edited can be stored and easily recalled for use as required. Unlike CUSTOM voices, INTERNAL voices can be edited via the VL70-m panel controls. When the VL70-m is initially shipped INTERNAL voice numbers 001 through 064 contain a selection of voices from the PRESET 1 and PRESET 2 banks, set up to be played via a WX-series Wind MIDI Controller.

Banks 112 through 119 become available when the VL70-m is set to the VL-XG sound module mode (page 29). In the VL-XG sound module mode some voices from the PRESET 1 and PRESET 2 banks are assigned MIDI bank and program change numbers conforming to the Yamaha XG format. Since the VL70-m does not have a full set of XG-compatible voices, however, some voice numbers will be skipped (e.g. 23, 24, 27, etc.).

### NOTES

- PRESET 1, PRESET 2, and CUSTOM voices can be edited via the VL70-m panel controls, but the edited voices cannot be stored to the PRESET 1, PRESET 2, or CUSTOM bank. Edited voices can only be stored to the INTERNAL bank, and only when the VL70-m is set to the VOICE sound module mode (page 29).
- The factory preset CUSTOM and INTERNAL voices can be restored by using the Factory Set Initialize function described on page 102.
- Refer to the separate "List Book" for a complete listing of the VL70-m voices.
- Use the MIDI bank MSB (control number 00) and LSB (control number 32) numbers listed at right to select VL70-m banks from an external MIDI device. In the VOICE sound module mode, the MSB is ignored (recognized as 33) and only LSB numbers 0 through 3 are recognized.

BANK	MSB	LSB
PRESET 1	33	0
PRESET 2	33	1
CUSTOM	33	2
INTERNAL	33	3
BANK 112	97 or 81	112
BANK 113	97 or 81	113
BANK 114	97 or 81	114
BANK 115	97 or 81	115
BANK 116	97 or 81	116
BANK 117	97 or 81	117
BANK 118	97 or 81	118
BANK 119	97 or 81	119

---

## The VL70-m Sound Module Modes

The VL70-m has two main Sound Module Modes: VOICE and VL-XG. It is important to understand the difference between these modes because they determine how the VL70-m responds to MIDI program change and bank numbers received from a MIDI keyboard or other controller, and how the internal effects relate to the individual voices.

### The VOICE Mode

In this mode the VL70-m functions as a “standard” tone generator module. The VOICE mode should be used when the VL70-m is being used alone or with other non-XG tone generators/synthesizers (see “VL Extension for XG”, page 30).

#### ● Voice Selection

The PRESET 1, PRESET 2, CUSTOM, and INTERNAL voices can be individually selected by the VL70-m panel VALUE [-] and [+] buttons, or appropriate MIDI program change numbers and bank numbers received from your keyboard or controller (see the “Voice Organization” section, above).

#### ● Voice Editing

In the VOICE mode the INTERNAL voices can be individually edited via the VL70-m panel controls. Each voice has its own edit parameters which can be stored with the voice and are recalled whenever the voice is selected. In fact, the edited data must be stored with the voice before a new voice is selected otherwise the edited data will be lost.

#### ● Effects

Each voice has its own effect settings which are recalled whenever the voice is selected, so that effects become an important part of the individual sound of each voice. As with edited voice data, edited effect data must be stored with the voice before a new voice is selected otherwise the edited effects data will be lost.

#### ● MIDI Output

Normally, MIDI data received at the VL70-m MIDI IN connector is re-transmitted “as is” via the MIDI OUT connector. The Note Filter function described on page 99 can be used to filter out (i.e. block) note data transmission on specified channels.

---

## The VL-XG Mode

In this mode the VL70-m functions as an “XG expansion” tone generator module. The VL-XG mode should be selected when the VL70-m is being used with other XG tone generators/synthesizers to play music data created for tone generators complying with the Yamaha XG format (see “VL Extension for XG”, page 30).

### ● Voice Selection

The PRESET 1, PRESET 2, CUSTOM, and INTERNAL voices can be individually selected by the VL70-m panel VALUE [-] and [+] buttons, or appropriate MIDI program change numbers and bank numbers received from your keyboard or controller (see the “Voice Organization” section, above). In the VL-XG mode banks 112 through 119 become available, and some voices from the PRESET 1 and PRESET 2 banks are assigned MIDI bank and program change numbers conforming to the Yamaha XG format. Since the VL70-m does not have a full set of XG-basic voices, however, some voice numbers will be skipped (e.g. 23, 24, 27, etc.).

### ● Voice Editing

In the VL-XG mode only one set of voice parameters is provided for all voices. Voices can not be individually edited and stored in the INTERNAL bank as in the VOICE mode. In fact, the VL-XG mode has no store function. Any voice parameter edits are retained no matter what voice is selected. This allows the same controller and other settings to be retained while switching to different voices.

### ● Effects

In the VL-XG mode only one set of effect parameters is provided for all voices. Effects can not be edited and stored with each individual voice in the INTERNAL bank as in the VOICE mode. The current effect settings are retained no matter what voice is selected. This allows the same reverb and other “ambience-defining” settings to be retained while switching to different voices.

### ● MIDI Output

Only MIDI messages which are not used by the VL70-m are re-transmitted via the MIDI OUT connector. The Note Filter function described on page 99 can be used to filter out (i.e. block) note data transmission on specified channels.



## Selecting the VOICE or VL-XG Sound Module Mode

The current sound module mode is indicated by the triangular pointer in the lower right- corner of the display in the PLAY mode.

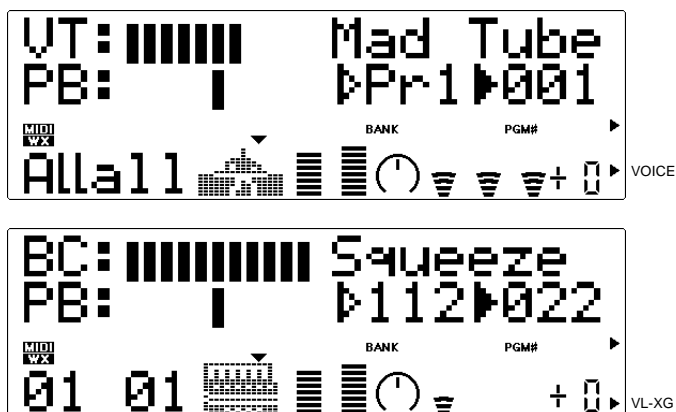

The VOICE or VL-XG sound module mode is selected as follows:

### 1. Press the [MODE] Button

Press the [MODE] button access the VL70-m sound module modes selection function.



### 2. Select the VOICE or VL-XG Mode

Use the VALUE [-] and [+] buttons to select the “VOICE” or “VL-XG” sound module mode, as required.

### 3. Press [EXIT] or [PLAY] When Done

Press the [EXIT] or [PLAY] button to return to the PLAY mode when the desired sound module mode has been selected.

---

## ■ VL Extension for XG



The VL Extension for XG (“VL Extension for XG” is abbreviated to VL-XG) included in the VL70-m Virtual Acoustic Tone Generator significantly enhances and expands the musical capabilities of the XG format with the superior sound and expressive potential of Yamaha Virtual Acoustic Synthesis. A VL70-m can be used in conjunction with a Yamaha MU80 or MU50 XG tone generator, for example: the VL70-m providing superior wind and string instrument voices while the MU80 or MU50 supplies drums, percussion, keyboard, and other voices.

The XG format is basically a set of rules describing how a tone generator will respond to MIDI data. The current GM (General MIDI) format is a similar concept, allowing GM music data to be reproduced accurately on any GM tone generator from any manufacturer. GM, however, applies only to a limited set of parameters. XG significantly expands on the basic GM format, providing many more voices, voice editing capability, effects, external input, and other features that contribute to enhanced musical expression. And since XG is totally upward compatible with GM, GM data can be accurately reproduced on any XG tone generator.

\* The VL70-m does not contain the basic set for the XG format.

---

# The VOICE PLAY Mode

When the VOICE sound module mode is selected (see “The VL70-m Sound Module Modes, page 27), pressing the [PLAY] button engages the VL70-m VOICE PLAY mode. This mode allows voices to be selected and played, and thus is the mode you’ll normally use when playing the VL70-m. The VOICE PLAY mode also provides access to several important performance parameters including volume, panning, etc. The VOICE PLAY mode actually has two control modes — the main control mode and the sub-control mode — which provide access to different sets of parameters, as described below.

## The VOICE PLAY Main Control Mode

This mode is initially selected when the VL70-m power is turned on. If the sub-control mode is active (see page 34), the main control mode can be selected by simultaneously pressing the PART [-] and [+] buttons. The VOICE PLAY main control mode display looks like this:

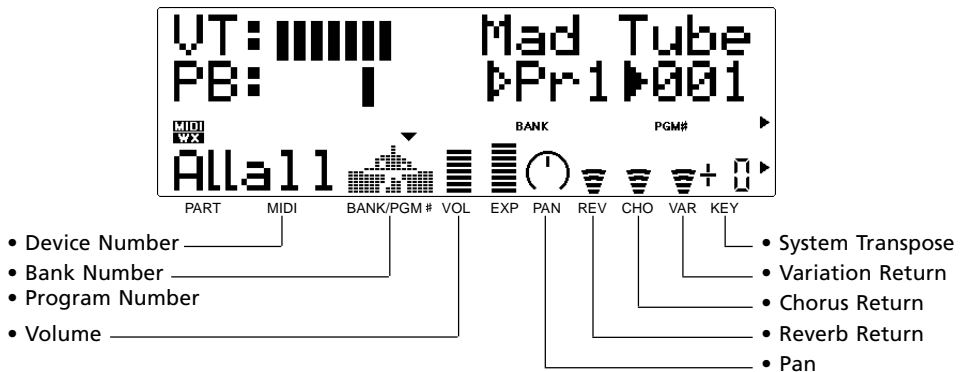

The various parameters in this mode are selected via the SELECT [◀] and [▶] buttons. The name of the currently selected parameter appears in the upper right corner of the display (when the bank and program number parameters are showing a solid triangular pointer indicates which of the two parameters is selected). A small triangular pointer appears above the icon corresponding to the selected parameter in the bottom line of the display. Once the desired parameter has been selected, it’s value can be set as required via the VALUE [-] and [+] buttons.

## DevNo. (Device Number)

Settings: 001 ... 016, all



The Device Number parameter must be set properly when you want to transmit or receive MIDI system exclusive data to or from another VL70-m or other MIDI device (system exclusive data includes voice parameters, system setup parameters, etc). The VL70-m Device number must be set to the same number as the Device Number of the external device. Select a device number from “001” to “016”, or “all”. When “all” is selected, MIDI system exclusive data can be received on all device numbers, but transmission occurs via device number 001.

## (Bank Number)

Settings: Pr1, Pr2, Cst, Int

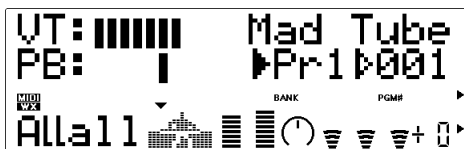

Selects the VL70-m PRESET 1 (Pr1), PRESET 2 (Pr2), CUSTOM (Cst), or INTERNAL (Int) voice bank (see “Voice Organization” on page 26).

## (Program Number)

Settings: 001 ... 128

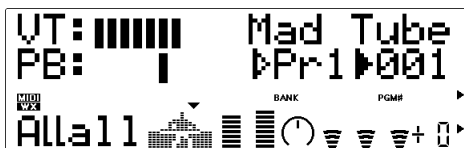

Selects the voice to played on the VL70-m. The PRESET 1 and PRESET 2 banks each have voice numbers from “001” to “128”, while the INTERNAL bank has voice numbers from “001” to “064”, and the CUSTOM bank has voice numbers from “001” to “006”.

## Volume

Settings: 000 ... 127

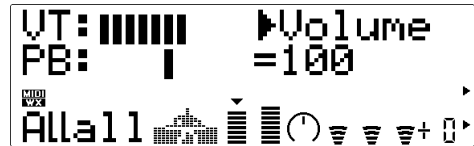

Sets the volume of the current voice. The higher the value the louder the volume.

## Pan

Settings: Rnd, L63 ... C ... R63

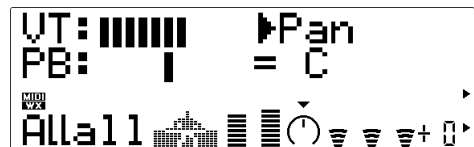

Sets the pan position of the current voice — i.e. the position of the voice between left and right in the stereo sound field. A setting of “L63” sets the pan position full left, “C” sets the pan at center, and “R63” sets the pan full right. In between settings produce corresponding intermediate pan positions. The “Rnd” setting produces a randomly-generated pan position.

## RevRtn (Reverb Return)

Settings: 000 ... 127



Adjusts the level of the signal returned from the VL70-m reverb effect stage. The higher the value, the higher the level of the reverb signal.

---

## ChoRtn (Chorus Return)

Settings: 000 ... 127



Adjusts the level of the signal returned from the VL70-m chorus effect stage. The higher the value, the higher the level of the chorus signal.

## VarRtn (Variation Return)

Settings: 000 ... 127



Adjusts the level of the signal returned from the VL70-m variation effect stage. The higher the value, the higher the level of the variation signal.

## SysTran (System Transpose)

Settings: -24 ... 0 ... +24



Transposes the pitch of the entire VL70-m system (a single setting applies to all voices) down or up in semitone steps over a  $\pm 2$  octave range. “+00” corresponds to standard pitch. Each increment corresponds to a semitone. A setting of “-12”, for example, transposes the pitch down one octave.

### ■ NOTES

- The Volume, Pan, Reverb Return, Chorus Return, and Variation Return settings are actually voice parameters, and are stored and recalled with each individual voice. This means that any edits you make may change when a new voice is selected.

---

## The VOICE PLAY Sub-control Mode

The sub control mode can be selected from the main control mode by simultaneously pressing the PART [-] and [+] buttons. The VOICE PLAY sub-control mode display looks like this:

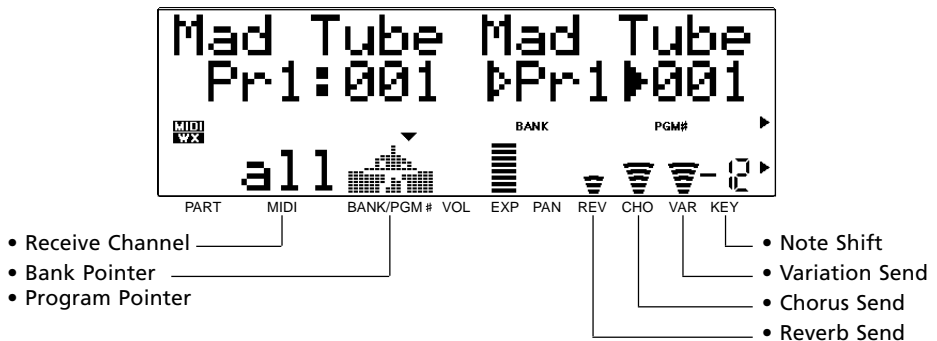

The various parameters in this mode are selected via the SELECT [◀] and [▶] buttons. The name of the currently selected parameter appears in the upper right corner of the display (when the bank and program pointer parameters are showing a solid triangular pointer indicates which of the two parameters is selected). A small triangular pointer appears above the icon corresponding to the selected parameter in the bottom line of the display. Once the desired parameter has been selected, it's value can be set as required via the VALUE [-] and [+] buttons.

### Rcv CH (Receive Channel)

Settings: 01 ... 16, all

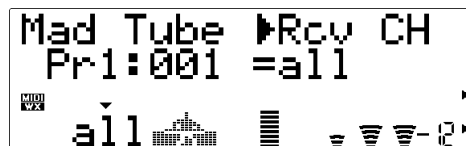

Sets the MIDI receive channel on which the VL70-m will receive data from your keyboard or other controller. The receive channel must be set to the same channel that the controlling device is transmitting on (“01” through “16”), or “all” to allow reception on all channels.

### (Bank Pointer)

Settings: Pr1, Pr2, Cst



This parameter refers to the bank containing the selected voice in the VOICE PLAY main control mode. It selects the VL70-m PRESET 1 (Pr1), PRESET 2 (Pr2) or CUSTOM (Cst) voice bank (see “Voice Organization” on page 26).

### (Program Pointer)

Settings: 001 ... 128



This parameter refers to the selected voice in the VOICE PLAY main control mode. The PRESET 1 and PRESET 2 banks each have voice numbers from “001” to “128”, and the CUSTOM bank has voice numbers from “001” to “006”.

### RevSend (Reverb Send)

Settings: 000 ... 127



Adjusts the level of the signal sent to the VL70-m reverb effect stage. The higher the value, the higher the level of the reverb send signal.

### ChoSend (Chorus Send)

Settings: 000 ... 127

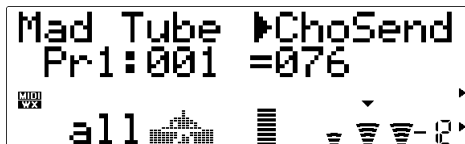

Adjusts the level of the signal sent to the VL70-m chorus effect stage. The higher the value, the higher the level of the chorus send signal.

### VarSend (Variation Send)

Settings: 000 ... 127

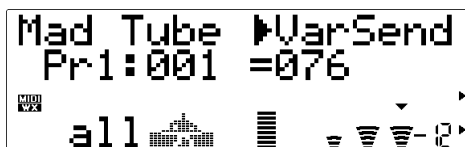

Adjusts the level of the signal sent to the VL70-m variation effect stage. The higher the value, the higher the level of the variation send signal.

### NoteSft (Note Shift)

Settings: -24 ... 0 ... +24

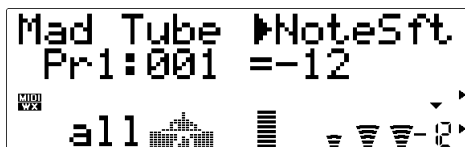

Transposes the pitch of the current voice down or up in semitone steps over a  $\pm 2$  octave range. “+00” corresponds to standard pitch. Each increment corresponds to a semitone. A setting of “-12”, for example, transposes the pitch down one octave.

#### ■ NOTES

- The Reverb Send, Chorus Send, Variation Send, Note Shift settings are actually voice parameters, and are stored and recalled with each individual voice. This means that any edits you make may change when a new voice is selected.

# The VL-XG PLAY Mode

When the VL-XG sound module mode is selected (see “The VL70-m Sound Module Modes, page 27), pressing the [PLAY] button engages the VL70-m VL-XG PLAY mode. In this mode the VL70-m can be used as an “XG expansion” tone generator module with other XG tone generators/synthesizers to play music data created for tone generators complying with the Yamaha XG format (see “VL Extension for XG”, page 30). Like the VOICE PLAY mode, the VL-XG PLAY mode also provides access to several important performance parameters via two control modes — the main control mode and the sub-control mode. When the VL-XG sound module mode is selected the PART [-] and [+] buttons select the XG “part” to be played. Either button can be pressed briefly for single stepping in the specified direction, or held for continuous scrolling. XG parts “01” to “16” can be selected, or the part parameter can be turned “Of” (off). No sound will be produced when “Of” is selected.

## ■ NOTES

- When selecting an XG part from the external MIDI device, specify the part number and transmit ON message using “NOTE ASSIGN” of the Current Voice/Common Part parameter (see page 34 in the separate “List Book”). If the external MIDI device transmits OFF message, “Of” is selected.

## ● A Simple XG System Incorporating the VL70-m

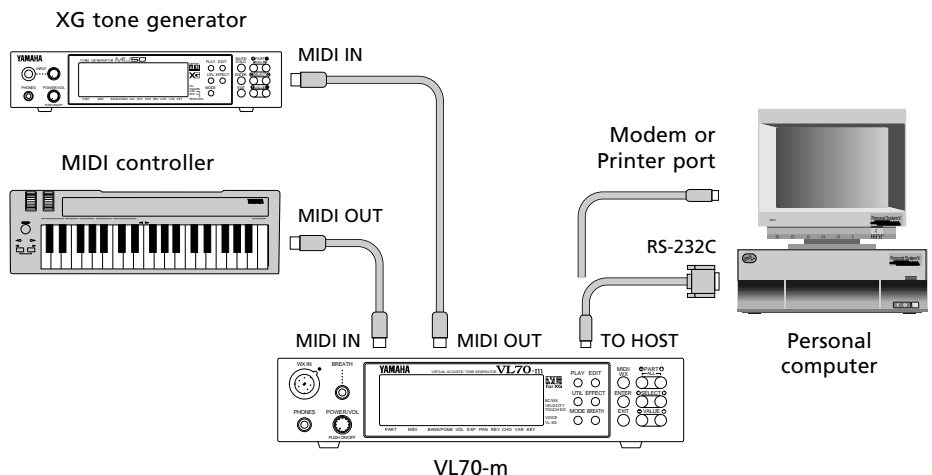



## The VL-XG PLAY Main Control Mode

This mode is initially engaged when the VL-XG sound module mode is selected. If the sub-control mode is active (see page 40), the main control mode can be selected by simultaneously pressing the PART [-] and [+] buttons. The VL-XG PLAY main control mode display looks like this:

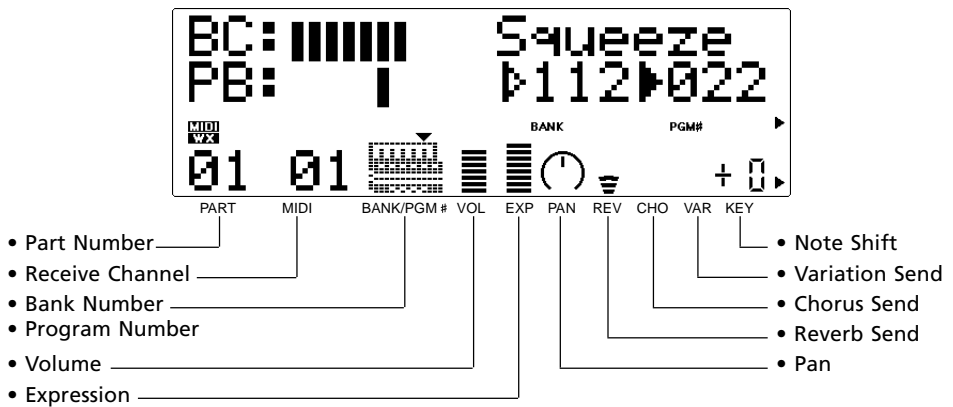

The various parameters in this mode are selected via the SELECT [◀] and [▶] buttons. The name of the currently selected parameter appears in the upper right corner of the display (when the bank and program number parameters are showing a solid triangular pointer indicates which of the two parameters is selected). A small triangular pointer appears above the icon corresponding to the selected parameter in the bottom line of the display. Once the desired parameter has been selected, it's value can be set as required via the VALUE [-] and [+] buttons.

## Rcv CH (Receive Channel)

Settings: 01 ... 16, OFF



Sets the MIDI receive channel on which the VL70-m will receive data from your keyboard or other controller. The receive channel must be set to the same channel that the controlling device is transmitting on (“01” through “16”). When “OFF” is selected, the VL70-m will not receive any data from external MIDI devices.

## (Bank Number)

Settings: 112 ... 119, Pr1, Pr2, Cst, Int

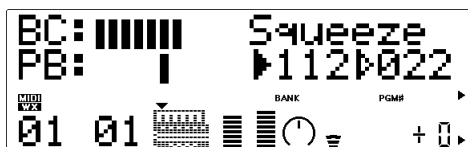

Selects the VL70-m voice bank: 112 through 119, PRESET 1 (Pr1), PRESET 2 (Pr2), CUSTOM (Cst), or INTERNAL (Int). See “Voice Organization” on page 26.

## (Program Number)

Settings: 001 ... 128

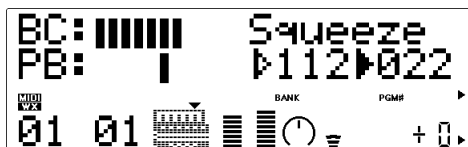

Selects the voice to played on the VL70-m. Banks 112 through 119 allow selection of voice numbers from “022” to “128”, although some voice numbers are skipped since the VL70-m does not have a full basic XG voice set. The PRESET 1 and PRESET 2 banks each have voice numbers from “001” to “128”, while the CUSTOM bank has voice numbers from “001” to “006”, and the INTERNAL bank has voice numbers from “001” to “064”

## Volume

Settings: 000 ... 127

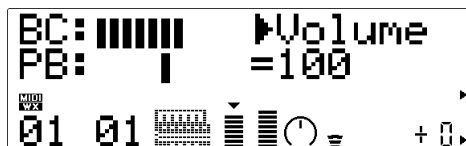

Sets the volume of the current voice. The higher the value the louder the volume.

## Express (Expression)

Settings: 000 ... 127

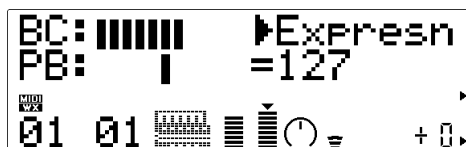

Sets the expression level of the current voice. The higher the value the higher the expression level.

## Pan

Settings: Rnd, L63 ... C ... R63

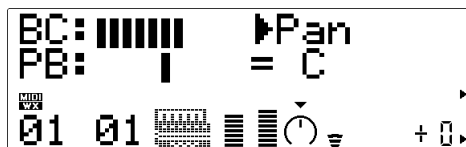

Sets the pan position of the current voice — i.e. the position of the voice between left and right in the stereo sound field. A setting of “L63” sets the pan position full left, “C” sets the pan at center, and “R63” sets the pan full right. In between settings produce corresponding intermediate pan positions. The “Rnd” setting produces a randomly-generated pan position.

---

### RevSend (Reverb Send)

Settings: 000 ... 127

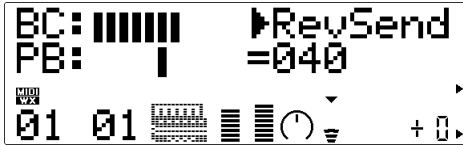

Adjusts the level of the signal sent to the VL70-m reverb effect stage. The higher the value, the higher the level of the reverb send signal.

### ChoSend (Chorus Send)

Settings: 000 ... 127

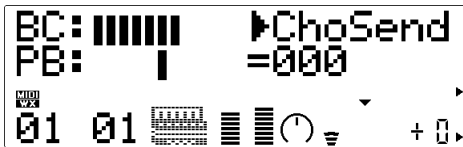

Adjusts the level of the signal sent to the VL70-m chorus effect stage. The higher the value, the higher the level of the chorus send signal.

### VarSend (Variation Send)

Settings: 000 ... 127 (on, off when "INS")

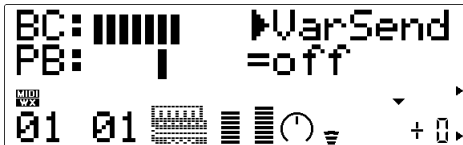

When the variation stage is connected as a system effect (page 87), this parameter adjusts the level of the signal sent to the VL70-m variation effect stage. The higher the value, the higher the level of the variation send signal. When the variation stage is connected as an "insertion" effect (page 86), this parameter turns variation send "on" or "off".

### NoteSft (Note Shift)

Settings: -24 ... 0 ... +24

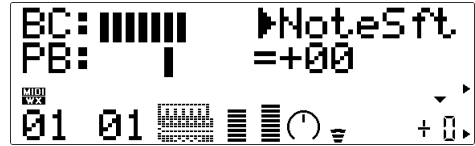

Transposes the pitch of the current voice down or up in semitone steps over a  $\pm 2$  octave range. "+00" corresponds to standard pitch. Each increment corresponds to a semitone. A setting of "-12", for example, transposes the pitch down one octave.

---

## The VL-XG PLAY Sub-control Mode

The sub control mode can be selected from the main control mode by simultaneously pressing the PART [-] and [+] buttons. The VL-XG PLAY sub-control mode display looks like this:

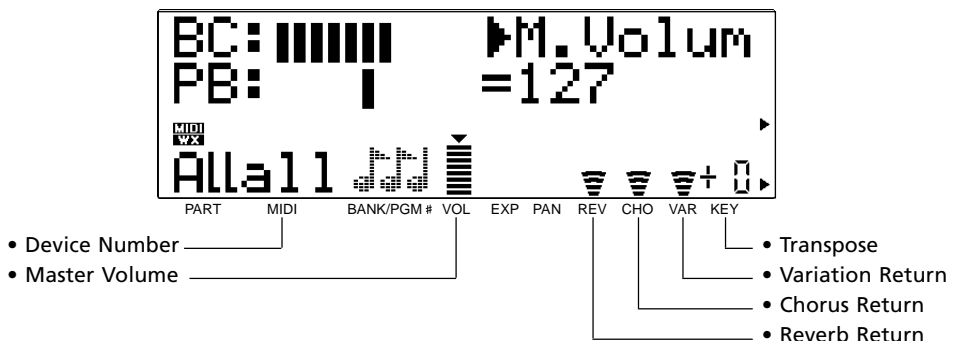

- When you enter the VL-XG sub control mode from the main control mode, “ALL” is automatically selected for the “part” by simultaneously pressing the PART [-] and [+] buttons (“ALL”).

The various parameters in this mode are selected via the SELECT [◀] and [▶] buttons. The name of the currently selected parameter appears in the upper right corner of the display. A small triangular pointer appears above the icon corresponding to the selected parameter in the bottom line of the display. Once the desired parameter has been selected, it’s value can be set as required via the VALUE [-] and [+] buttons.

### DevNo. (Device Number)

Settings: 001 ... 016, all



The Device Number parameter must be set properly when you want to transmit or receive MIDI system exclusive data to or from another VL70-m or other MIDI device (system exclusive data includes voice parameters, system setup parameters, etc). The VL70-m Device number must be set to the same number as the Device Number of the external device. Select a device number from “001” to “016”, or “all”. When “all” is selected, MIDI system exclusive data can be received on all device numbers, but transmission occurs via device number 001.

### M.Volum (Master Volume)

Settings: 000 ... 127



Sets the VL70-m master volume level. The higher the value the louder the volume.

### RevRtn (Reverb Return)

Settings: 000 ... 127



Adjusts the level of the signal returned from the VL70-m reverb effect stage. The higher the value, the higher the level of the reverb signal.

### ChoRtn (Chorus Return)

Settings: 000 ... 127

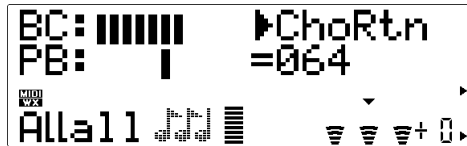

Adjusts the level of the signal returned from the VL70-m chorus effect stage. The higher the value, the higher the level of the chorus signal.

### VarRtn (Variation Return)

Settings: 000 ... 127

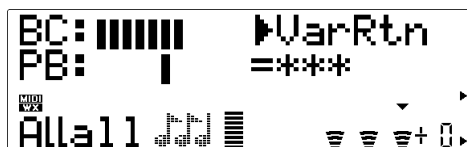

Adjusts the level of the signal returned from the VL70-m variation effect stage. The higher the value, the higher the level of the variation signal. This parameter is not available (“\*\*\*” will appear in place of the VarRtn value) when the variation stage is connected as an “insertion” effect (page 86).

### Trans (Transpose)

Settings: -24 ... 0 ... +24

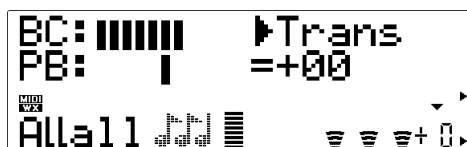

Transposes the pitch of the entire VL70-m system (a single setting applies to all voices) down or up in semitone steps over a  $\pm 2$  octave range. “+00” corresponds to standard pitch. Each increment corresponds to a semitone. A setting of “-12”, for example, transposes the pitch down one octave.

---

# Controllers & Control Editing

If you've read the "Virtual Acoustic Synthesis" section (if you haven't, please do so — page 6) you should understand the concept of "controllers" as applied to the VL70-m. The "controller parameters" correspond to simulated characteristics of the instrument model — e.g. breath pressure, embouchure or tonguing. Any of these can be controlled by you via "physical controllers" — e.g. a breath controller or modulation wheel — assigned to the required controller parameter.

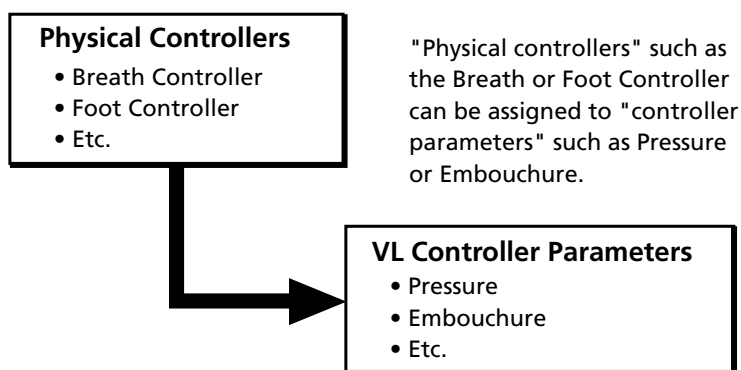

The effectiveness of the VL70-m as a musical instrument depends to a great deal on how well you learn to use these controllers. Since the VL70-m sound is produced by a computer-based physical model rather than an oscillator-based tone generator, there are no hard-and-fast rules as to how any controller will actually affect the sound. There are guidelines, based on the rule of the corresponding controller parameter within the physical model, but proficiency with the VL70-m depends more on experience and practice — just as it does in any acoustic instrument.

## ● Physical Controllers

First, here's a list of some of the physical controllers you might want to use with the VL70-m:

<b>Breath Controller (MIDI control change no. 02)</b>	A natural candidate for controlling pressure, tonguing, throat formant, growl, and other parameters.
<b>Pitch Bend Wheel</b>	The pitch bend wheel on your keyboard or other MIDI device can be assigned to a range of parameters, but its "standard" function is pitch control. A controller parameter such as Embouchure can also be assigned to the pitch bend wheel for more realistic pitch variations.
<b>Modulation Wheel (MIDI control change no. 01)</b>	Since the modulation wheel on your keyboard or other MIDI device can be assigned to any controller parameter, it can be an important tool for musical expression. Use it in conjunction with a breath controller or a foot controller for broad expressive variation.
<b>Foot Controller (MIDI control change no. 04)</b>	Like the modulation wheel, a foot controller connected to your keyboard or other MIDI device can be assigned to any VL70-m controller parameter.
<b>Aftertouch</b>	Keyboard aftertouch allows you to control any controller parameter by the pressure you apply to a key after it is initially pressed. This is perhaps the most "intimate" type of keyboard expression control.
<b>Velocity</b>	Although normally assigned to pressure (particularly in plucked string voices), keyboard velocity can also be assigned to any other controller parameter.
<b>Others</b>	The MIDI protocol provides 119 control change numbers, some of which are pre-assigned to specific controllers — as noted above, "01" is "Modulation Wheel", for example. 95 of these are available for assignments to the VL70-m controller parameters, so any available MIDI control devices can be used to full advantage. A complete list of the available MIDI control change numbers is given below.

**● MIDI Control Change Number Assignments**

Control No.	Controller
off(00)	off (used by Bank Select MSB)
01	Modulation Wheel
02	Breath Controller
03	<i>Unassigned</i>
04	Foot Controller
05	Portamento Time
06	Data Entry MSB
07	Volume Control
08~09	<i>Unassigned</i>
10	Panpot
11	Expression
12~31	<i>Unassigned</i>

<b>Control No.</b>	<b>Controller</b>
off(32)	off (used by Bank Select LSB)
33~37	<i>Unassigned</i>
38	Data Entry LSB
39~63	<i>Unassigned</i>
64	Hold1
65	Portamento Switch
66	<i>Unassigned</i>
67	Soft Pedal
68~70	<i>Unassigned</i>
71	Harmonic Content
72	Release Time
73	Attack Time
74	Brightness
75~90	<i>Unassigned</i>
91	Effect Send Level (Reverb Effect)
92	<i>Unassigned</i>
93	Effect Send Level 3 (Chorus Effect)
94	Effect Send Level 4 (Variation Effect)
95	<i>Unassigned</i>
AT	After Touch
VEL	Velocity
PB	Pitch Bend



## ● VL70-m Controller Parameters

Any of the physical controllers listed above can be assigned to control any of the VL70-m's controller parameters:

<b>Pressure</b>	The amount of breath pressure applied to a reed or mouthpiece, or the speed of the bow applied to a string. Pressure variations affect both volume and timbre.
<b>Embouchure</b>	The tightness of the lips against the reed or against each other. In a string instrument voice Embouchure corresponds to how strongly the bow is pressed against the string. Affects both pitch and timbre.
<b>Tonguing</b>	Simulates the half-tonguing technique used by saxophone players by changing the "slit" of the reed. The slit is the space between the tip of the reed and the mouthpiece.
<b>Amplitude</b>	Unlike Pressure, this parameter simply controls the volume of the sound without varying timbre.
<b>Scream</b>	Drives the entire system into chaotic oscillation, creating effects that can only be achieved with physical modeling technology.
<b>Breath Noise</b>	Adds breath noise to produce exceptionally realistic effects with many wind instruments.
<b>Growl</b>	A periodic pressure modulation which produces the "growl" effect often heard in wind instruments.
<b>Throat Formant</b>	Controls the characteristics of the simulated player's lungs, trachea, and oral cavity. Can add a realistic "roughness" to the sound. Throat formant only applies to some reed-type voices.
<b>Filter</b>	Similar to the dynamic filters found in many conventional synthesizers, the cutoff frequency can be varied to produce a wide range of timbral variations. Most voices use the low-pass filter type, but some use the bandpass, high-pass, or band eliminate types. Some voices use very little filter processing at all. Changing the filter settings may not produce a particularly noticeable effect. For detailed filter parameter programming use the VL70-m Expert Editor software (page 25).
<b>Harmonic Enhancer</b>	The Harmonic Enhancer can vary the harmonic structure of the sound over a wide range. Since most VL70-m voices have sufficient natural harmonic content, the Harmonic Enhancer is actually only used on a few voices. Therefore changing the controller destination with many voices will produce either no change in the sound or a simple change in amplitude. For detailed harmonic enhancer programming use the VL70-m Expert Editor software (page 25).
<b>Damping</b>	Simulates the effect of damping due to losses within the body of a wind instrument or in a string due to air friction. Affects both pitch and timbre.
<b>Absorption</b>	Simulates the effect of high-frequency loss at the end of the air column or string. In the case of a wind instrument, the Damping and Absorption parameters control the diameter and shape of the bell.

---

## Accessing & Editing the Control Parameters

The CONTROL EDIT mode can be accessed from the VOICE PLAY mode as follows:

### 1. Press [EDIT]

Press the [EDIT] button to go to the VOICE EDIT sub-mode menu.

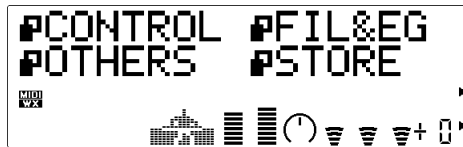

### 2. Select the CONTROL Sub-mode

Use the SELECT [◀] and [▶] buttons to select the CONTROL sub-mode, if necessary. The icon to the left of “CONTROL” on the display will flash when the CONTROL sub-mode is selected.

### 3. Press [ENTER]

Press the [ENTER] button to go to the CONTROL EDIT mode. “CONTROL EDIT” will appear at the top of the display along with the number of the currently selected control parameter.

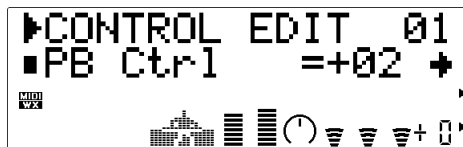

### 4. Select a Parameter

Use the SELECT [◀] and [▶] buttons to select the parameter you want to edit (see “The Control Edit Parameters”, below). The name of the currently selected parameter and its current setting appear on the second line of the display. An arrow to the left and/or right of the parameter name/value indicates that the SELECT [◀] and/or [▶] buttons can be used to select more parameters in the indicated direction.

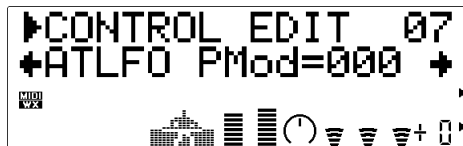

### 5. Edit the Selected Parameter

Use the VALUE [-] and [+] buttons to set the value of the selected parameter as required.

---

## 6. Repeat As Necessary

Repeat steps 4 and 5 to edit as many parameters as required.

## 7. Exit When Done

Press the [EXIT] button to return to the VOICE EDIT sub-mode menu, or the [PLAY] button to return to the VOICE PLAY mode when you're finished editing.

### ■ **IMPORTANT!**

- *If you want to keep the changes you made in the VOICE EDIT mode, be sure to store the edited voice to an appropriate INTERNAL voice number before selecting a new voice. All edited data will be lost if you select a new voice before storing the edited voice!*

---

# The Control Edit Parameters

Please note that a number of CONTROL EDIT parameters which are available in the VOICE sound module mode are not available in the VL-XG sound module mode (page 28). The parameter numbers are therefore different in each mode. Some of the value ranges are also different — the differences will be listed with the actual parameter descriptions.

## ● VOICE Sound Module Mode Control Edit Parameters

Refer to the page numbers listed for full details on each parameter.

<b>Pitch Bend</b> .....	<b>52</b>
01: PB Ctrl (Pitch Bend Control)	
02: PB LowCtrl (Pitch Bend Low Control)	
03: PBLFO PMod (Pitch Bend LFO Pitch Modulation)	
<b>Modulation Wheel</b> .....	<b>53</b>
04: MWLFO PMod (Modulation Wheel LFO Pitch Modulation)	
05: MWLFO FMod (Modulation Wheel LFO Filter Modulation)	
<b>Aftertouch</b> .....	<b>53</b>
06: ATFil Ctrl (Aftertouch Filter Control)	
07: ATLFO PMod (Aftertouch LFO Pitch Modulation)	
<b>Assignable Controller</b> .....	<b>54</b>
08: AC1 CC No. (Assignable Controller 1 Control Change Number)	
09: AC1FilCtrl (Assignable Controller 1 Filter Control)	
10: AC1AmpCtrl (Assignable Controller 1 Amplitude Control)	
11: AC1LFOPMod (Assignable Controller 1 LFO Pitch Modulation)	
<b>Expression</b> .....	<b>54</b>
12: Exp Mode (Expression Mode)	
<b>Pressure</b> .....	<b>55</b>
13: Prs CC No. (Pressure Control Change Number)	
14: PrsCtrlDpt (Pressure Control Depth)	
15: Prs Curve (Pressure Curve)	
<b>Filter</b> .....	<b>55</b>
16: Fil CC No. (Filter Control Change Number)	
17: FilCtrlDpt (Filter Control Depth)	
18: Fil Curve (Filter Curve)	
<b>Amplitude</b> .....	<b>56</b>
19: Amp CC No. (Amplitude Control Change Number)	
20: AmpCtrlDpt (Amplitude Control Depth)	
21: Amp Curve (Amplitude Curve)	

---

<b>Embouchure .....</b>	<b>57</b>
22: Emb CC No. (Embouchure Control Change Number)	
23: EmbUpprDpt (Embouchure Upper Control Depth)	
24: EmbLowrDpt (Embouchure Lower Control Depth)	
25: Emb Mode (Embouchure Mode)	
<b>Tonguing .....</b>	<b>58</b>
26: Tng CC No. (Tonguing Control Change Number)	
27: TngCtrlDpt (Tonguing Control Depth)	
28: Tng Curve (Tonguing Curve)	
<b>Scream .....</b>	<b>59</b>
29: Scr CC No. (Scream Control Change Number)	
30: ScrCtrlDpt (Scream Control Depth)	
31: Scr Curve (Scream Curve)	
<b>Breath Noise .....</b>	<b>60</b>
32: Bnz CC No. (Breath Noise Control Change Number)	
33: BnzCtrlDpt (Breath Noise Control Depth)	
34: Bnz Curve (Breath Noise Curve)	
<b>Growl .....</b>	<b>61</b>
35: Grl CC No. (Growl Control Change Number)	
36: GrlCtrlDpt (Growl Control Depth)	
37: Grl Curve (Growl Curve)	
<b>Throat Formant .....</b>	<b>62</b>
38: Thr CC No. (Throat Formant Control Change Number)	
39: ThrCtrlDpt (Throat Formant Control Depth)	
40: Thr Curve (Throat Formant Curve)	
<b>Harmonic Enhancer .....</b>	<b>62</b>
41: Hrm CC No. (Harmonic Enhancer Control Change Number)	
42: HrmCtrlDpt (Harmonic Enhancer Control Depth)	
43: Hrm Curve (Harmonic Enhancer Curve)	
<b>Damping .....</b>	<b>63</b>
44: Dmp CC No. (Damping Control Change Number)	
45: DmpCtrlDpt (Damping Control Depth)	
46: Dmp Curve (Damping Curve)	
<b>Absorption .....</b>	<b>64</b>
47: Abs CC No. (Absorption Control Change Number)	
48: AbsCtrlDpt (Absorption Control Depth)	
49: Abs Curve (Absorption Curve)	

---

## ● VL-XG Sound Module Mode Control Edit Parameters

Refer to the page numbers listed for full details on each parameter.

<b>Pitch Bend</b> .....	<b>52</b>
01: PB Ctrl (Pitch Bend Control)	
02: PB LowCtrl (Pitch Bend Low Control)	
03: PBLFO PMod (Pitch Bend LFO Pitch Modulation)	
<b>Modulation Wheel</b> .....	<b>53</b>
04: MWLFO PMod (Modulation Wheel LFO Pitch Modulation)	
05: MWLFO FMod (Modulation Wheel LFO Filter Modulation)	
<b>Aftertouch</b> .....	<b>53</b>
06: ATFil Ctrl (Aftertouch Filter Control)	
07: ATLFO PMod (Aftertouch LFO Pitch Modulation)	
<b>Assignable Controller</b> .....	<b>54</b>
08: AC1 CC No. (Assignable Controller 1 Control Change Number)	
09: AC1FilCtrl (Assignable Controller 1 Filter Control)	
10: AC1AmpCtrl (Assignable Controller 1 Amplitude Control)	
11: AC1LFOPMod (Assignable Controller 1 LFO Pitch Modulation)	
<b>Pressure</b> .....	<b>55</b>
12: Prs CC No. (Pressure Control Change Number)	
13: PrsCtrlDpt (Pressure Control Depth)	
<b>Embouchure</b> .....	<b>57</b>
14: Emb CC No. (Embouchure Control Change Number)	
15: EmbCtrlDpt (Embouchure Control Depth)	
<b>Tonguing</b> .....	<b>58</b>
16: Tng CC No. (Tonguing Control Change Number)	
17: TngCtrlDpt (Tonguing Control Depth)	
<b>Scream</b> .....	<b>59</b>
18: Scr CC No. (Scream Control Change Number)	
19: ScrCtrlDpt (Scream Control Depth)	
<b>Breath Noise</b> .....	<b>60</b>
20: Bnz CC No. (Breath Noise Control Change Number)	
21: BnzCtrlDpt (Breath Noise Control Depth)	
<b>Growl</b> .....	<b>61</b>
22: Grl CC No. (Growl Control Change Number)	
23: GrlCtrlDpt (Growl Control Depth)	

---

<b>Throat Formant</b> .....	<b>62</b>
24: Thr CC No. (Throat Formant Control Change Number)	
25: ThrCtrlDpt (Throat Formant Control Depth)	
<b>Harmonic Enhancer</b> .....	<b>62</b>
26: Hrm CC No. (Harmonic Enhancer Control Change Number)	
27: HrmCtrlDpt (Harmonic Enhancer Control Depth)	
<b>Damping</b> .....	<b>63</b>
28: Dmp CC No. (Damping Control Change Number)	
29: DmpCtrlDpt (Damping Control Depth)	
<b>Absorption</b> .....	<b>64</b>
30: Abs CC No. (Absorption Control Change Number)	
31: AbsCtrlDpt (Absorption Control Depth)	

---

## ● Control Edit Parameter Descriptions

The small parameter numbers in parentheses apply in the VL-XG sound module mode.

### Pitch Bend

#### 01(01): PB Ctrl

- Pitch Bend Control
- Settings: -24 ... +24



This parameter sets the maximum amount of pitch bend which will occur when the pitch controller is set to its maximum position (e.g. when the pitch bend wheel on a keyboard is rolled all the way up). Minus settings produce a downward pitch bend. Each increment corresponds to a semitone. A setting of "+12", for example, results in maximum upward pitch bend of one octave.

- This setting automatically switches the plus/minus status of the "PB LowCtrl" parameter, below: If "PB Ctrl" is set to a "+" value, "PB LowCtrl" is automatically switched to a "-" value, and vice-versa.
- Natural acoustic musical instruments have no "pitch parameter". Pitch is determined by the properties of the instrument's resonant body as well as the condition of the instrument's driver. The same applies to Virtual Acoustic Synthesis: in the VL70-m pitch bend is simulated by manipulating the appropriate pipe/string length and driver characteristics. As a result, the pitch bend range may not always be "mathematically" accurate.

#### 02(02): PB LowCtrl

- Pitch Bend Low Control
- Settings: -24 ... +24



"PB LowCtrl" sets the maximum amount of pitch bend which will occur when the pitch controller is set to its lowest position (e.g. when the pitch bend wheel on a keyboard is rolled all the way down). Plus settings produce an upward pitch bend. Each increment corresponds to a semitone. A setting of "-12", for example, results in maximum downward pitch bend of one octave.

#### 03(03): PBLFO PMod

- Pitch Bend LFO Pitch Modulation
- Settings: 000 ... 127



Sets the amount of LFO pitch modulation applied by the pitch controller (e.g. the pitch bend wheel on a keyboard). The higher the value the greater the amount of pitch modulation produced by pitch controller operation. A setting of "000" produces no pitch modulation.

- In the VL70-m pitch modulation produces extremely realistic vibrato effects by simultaneously modulating the pitch, embouchure, and pressure parameters.



## Modulation Wheel

### 04(04): MWLFO PMod

- Modulation Wheel LFO Pitch Modulation
- Settings: 000 ... 127



Sets the amount of LFO pitch modulation applied by the modulation controller (e.g. the modulation wheel on a keyboard — MIDI control change number 01). The higher the value the greater the amount of pitch modulation produced by modulation controller operation. A setting of “000” produces no pitch modulation.

### 05(05): MWLFO FMod

- Modulation Wheel LFO Filter Modulation
- Settings: 000 ... 127



Sets the amount of LFO filter cutoff frequency modulation applied by the modulation controller (e.g. the modulation wheel on a keyboard — MIDI control change number 01). The higher the value the greater the amount of filter modulation produced by modulation controller operation. A setting of “000” produces no filter modulation.

## Aftertouch

### 06(06): ATFil Ctrl

- Aftertouch Filter Control
- Settings: -64 ... +63



Determines the degree to which the filter is affected by keyboard aftertouch. Plus settings cause the cutoff frequency of the filter to increase in response to increasing aftertouch pressure, while minus values cause the filter frequency to decrease in response to increasing aftertouch pressure.

### 07(07): ATLFO PMod

- Aftertouch LFO Pitch Modulation
- Settings: 000 ... 127



Sets the amount of LFO pitch modulation applied by keyboard aftertouch. The higher the value the greater the amount of pitch modulation produced by aftertouch pressure. A setting of “000” produces no pitch modulation.

## Assignable Controller

### 08(08): AC1 CC No.

- Assignable Controller 1 Control Change Number
- Settings: off ... 95



Assigns the specified control change number as “Assignable Controller 1”. The assigned controller can then be used to control filter, amplitude, and/or pitch modulation as specified by the “AC1FilCtrl”, AC1AmpCtrl, and “AC1LFOPMod” parameters below. For example, if this parameter is set to “04” (Foot Controller), then a MIDI foot controller can be used to control any of the parameters just mentioned.

### 09(09): AC1FilCtrl

- Assignable Controller 1 Filter Control
- Settings: -64 ... +63



Determines the degree to which the filter is affected by Assignable Controller 1 (see “AC1 CC No.”, above). Plus settings cause the cutoff frequency of the filter to increase in response to increasing controller values, while minus values cause the filter frequency to decrease in response to increasing controller values.

### 10(10): AC1AmpCtrl

- Assignable Controller 1 Amplitude Control
- Settings: -64 ... +63



Determines the degree to which amplitude (volume) is affected by Assignable Controller 1 (see “AC1 CC No.”, above). Plus settings cause the

amplitude to increase in response to increasing controller values, while minus values cause the amplitude to decrease in response to increasing controller values.

### 11(11): AC1LFOPMod

- Assignable Controller 1 LFO Pitch Modulation
- Settings: 000 ... 127



Sets the amount of LFO pitch modulation applied by Assignable Controller 1 (see “AC1 CC No.”, above). The higher the value the greater the amount of pitch modulation produced by the controller. A setting of “000” produces no pitch modulation.

## Expression

### 12: Exp Mode (VOICE mode only)

- Expression Mode
- Settings: BC, Vol



Determines whether expression control (MIDI control change number 11) will function as volume control or as breath controller. When set to “Vol” expression will affect volume, but when set to “BC” expression will produce the same effect as a breath controller connected to the VL70-m BREATH jack, affecting the same breath-controlled parameters.

## Pressure

### 13(12): Prs CC No.

- Pressure Control Change Number
- Settings: off... 95, AT, VEL, PB

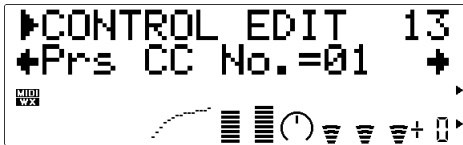

“Pressure” corresponds to the amount of breath pressure applied to a reed or mouthpiece, or the speed of the bow applied to a string. Pressure variations affect both volume and timbre. The “Prs CC No.” parameter specifies the controller to be used for pressure control. When set to “off” maximum pressure is applied at all times.

- Please note that pressure affects not only volume, but timbre and pitch as well. Accurate keyboard/controller pitch is produced only at maximum pressure.
- The “PrsCtrlDpt” parameter, below, must be set to an appropriate value (higher than “+01” or lower than “-01”) for pressure control to have any effect.

### 14(13): PrsCtrlDpt

- Pressure Control Depth
- Settings: -127 ... +127 (VL-XG Mode: -64 ... +63)

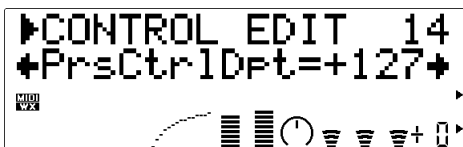

Sets the amount of variation produced by the controller assigned to pressure. The higher the value the greater the variation. Positive values cause an increase in pressure in response to higher controller values (e.g. increased breath pressure or higher modulation wheel position), while minus values cause a decrease in pressure in response to higher controller values. The “Depth” setting is reflected in the graph at the bottom of the display — the horizontal axis represents the controller value and the vertical axis represents pressure.

- Set this parameter to “+00” if do not intend to control pressure via a controller.

### 15: Prs Curve (VOICE mode only)

- Pressure Curve
- Settings: -16 ... +16

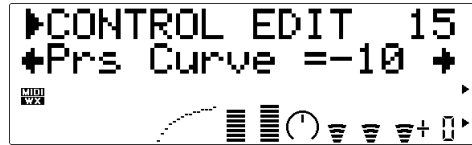

Determines the relationship between the controller value and pressure. When set to “+00” the relationship is linear. That is, a change in the controller value produces a corresponding change in pressure. As the curve value increases the lower end of the controller range has relatively little effect on the sound while higher controller values produce more dramatic changes. Negative curve values have the opposite effect: the sound changes dramatically at low controller values while higher values produce relatively little effect. The “Curve” setting is reflected in the graph at the bottom of the display — the horizontal axis represents the controller value and the vertical axis represents pressure.

## Filter

### 16: Fil CC No. (VOICE mode only)

- Filter Control Change Number
- Settings: off... 95, AT, VEL, PB

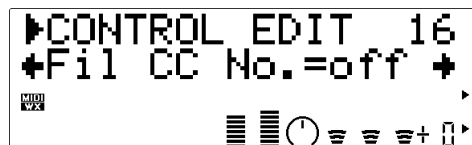

The “Fil CC No.” parameter specifies the controller to be used for filter cutoff frequency control (page 45). When set to “off” no filter frequency variation can be applied via a controller.

- The “FilCtrlDpt” parameter, below, must be set to an appropriate value (higher than “+01” or lower than “-01”) for filter control to have any effect.
- Most voices use the low-pass filter type, but some use the bandpass, high-pass, or band

eliminate types. Some voices use very little filter processing at all. Changing the filter settings may not produce a particularly noticeable effect. For detailed filter parameter programming use the VL70-m Expert Editor software (page 25).

**17: FilCtrlDpt** (VOICE mode only)

- Filter Control Depth
- Settings: -127 ... +127

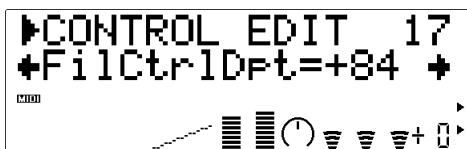

Sets the amount of variation produced by the controller assigned to dynamic filter. The higher the value the greater the variation. Positive values cause an increase in filter cutoff frequency in response to higher controller values (e.g. increased breath pressure or higher modulation wheel position), while minus values cause a decrease in filter cutoff frequency in response to higher controller values. The “Depth” setting is reflected in the graph at the bottom of the display — the horizontal axis represents the controller value and the vertical axis represents filter cutoff frequency.

- The effect of the filter may be barely noticeable on some voices. In some cases it may be necessary to lower the cutoff frequency to produce the desired effect.

**18: Fil Curve** (VOICE mode only)

- Filter Curve
- Settings: -16 ... +16

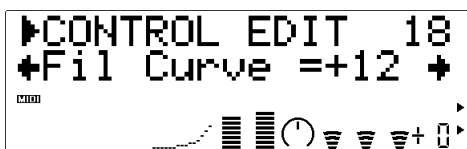

Determines the relationship between the controller value and dynamic filter cutoff frequency. When set to “+00” the relationship is linear. That is, a change in the controller value produces a corresponding change in frequency. As the curve value increases the lower end of the controller range has

relatively little effect on the sound while higher controller values produce more dramatic changes. Negative curve values have the opposite effect: the sound changes dramatically at low controller values while higher values produce relatively little effect. The “Curve” setting is reflected in the graph at the bottom of the display — the horizontal axis represents the controller value and the vertical axis represents filter cutoff frequency.

**Amplitude**

**19: Amp CC No.** (VOICE mode only)

- Amplitude Control Change Number
- Settings: off... 95, AT, VEL, PB

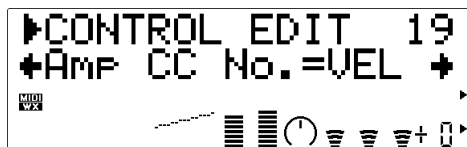

Unlike pressure, “Amplitude” controls the volume of the sound without varying timbre or pitch. The “Amp CC No.” parameter specifies the controller to be used for amplitude control. When set to “off” maximum volume is produced at all times.

- The “AmpCtrlDpt” parameter, below, must be set to an appropriate value (higher than “+01” or lower than “-01”) for amplitude control to have any effect.

**20: AmpCtrlDpt** (VOICE mode only)

- Amplitude Control Depth
- Settings: -127 ... +127



Sets the amount of variation produced by the controller assigned to amplitude. The higher the value the greater the variation. Positive values cause an increase in amplitude in response to higher controller values (e.g. increased breath

## Embouchure

pressure or higher modulation wheel position), while minus values cause a decrease in amplitude in response to higher controller values. The “Depth” setting is reflected in the graph at the bottom of the display — the horizontal axis represents the controller value and the vertical axis represents amplitude.

### 21: Amp Curve (VOICE mode only)

- Amplitude Curve
- Settings: -16 ... +16

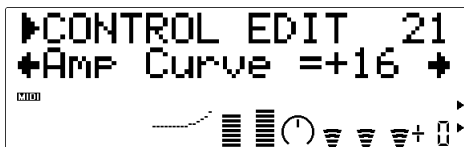

Determines the relationship between the controller value and amplitude. When set to “+00” the relationship is linear. That is, a change in the controller value produces a corresponding change in amplitude. As the curve value increases the lower end of the controller range has relatively little effect on the sound while higher controller values produce more dramatic changes. Negative curve values have the opposite effect: the sound changes dramatically at low controller values while higher values produce relatively little effect. The “Curve” setting is reflected in the graph at the bottom of the display — the horizontal axis represents the controller value and the vertical axis represents amplitude.

### 22(14): Emb CC No.

- Embouchure Control Change Number
- Settings: off... 95, AT, VEL, PB

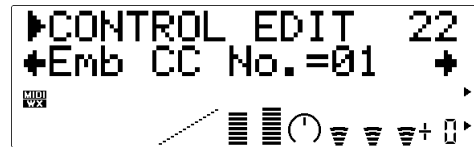

“Embouchure” corresponds to the tightness of the lips against the reed or against each other. In a string instrument voice embouchure corresponds to how strongly the bow is pressed against the string. Affects both pitch and timbre. The “Emp CC No.” parameter specifies the controller to be used for embouchure control. When set to “off” medium embouchure is applied at all times.

- Please note that with many voices accurate keyboard/controller pitch is produced only at medium embouchure.
- The “EmbUpprDpt” and “EmbLowrDpt” parameters, below, must be set to appropriate values (higher than “+01” or lower than “-01”) for embouchure control to have any effect.

### 23: EmbUpprDpt (VOICE mode only)

- Embouchure Upper Control Depth
- Settings: -127 ... +127



Sets the amount of variation produced by the controller assigned to embouchure when the controller is set to its maximum position (e.g. a modulation wheel rolled all the way up). The higher the value the greater the variation. Positive values cause an increase in embouchure in response to higher controller values, while minus values cause a decrease in embouchure in response to higher controller values.

#### 24: EmbLowrDpt (VOICE mode only)

- Embouchure Lower Control Depth
- Settings: -127 ... +127



Sets the amount of variation produced by the controller assigned to embouchure when the controller is set to its minimum position (e.g. a modulation wheel rolled all the way down). The higher the value the greater the variation. Positive values cause an increase in embouchure in response to lower controller values, while minus values cause a decrease in embouchure in response to lower controller values. The “EmbLowrDpt” parameter has no effect when the “Emb Mode” parameter, below, is set to “Min”.

#### 25: Emb Mode (VOICE mode only)

- Embouchure Mode
- Settings: Cntr, Min

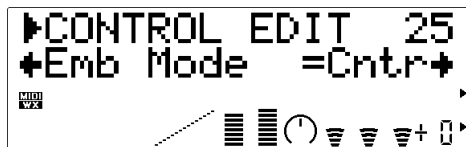

Selects the controller value (position) which will produce “normal” embouchure. When set to “Cntr” (Center) a central controller position will produce normal embouchure, allowing both downward and upward variation. A setting of “Min” (Minimum) will produce normal embouchure when the controller is set to its minimum position, allowing only upward variation.

#### ● VL-XG MODE

In the VL-XG sound module mode (page 28) the “EmbUpprDpt” and EmbLowrDpt” parameters are replaced by a single “EmbCtrlDpt” parameter, as follows:

#### 15: EmbCtrlDpt

- Embouchure Control Depth
- Settings: -64 ... +63



Sets the amount of variation produced by the controller assigned to embouchure. The higher the value the greater the variation. Positive values cause an increase in embouchure in response to higher controller values (e.g. increased breath pressure or higher modulation wheel position), while minus values cause a decrease in embouchure in response to higher controller values.

#### Tonguing

#### 26(16): Tng CC No.

- Tonguing Control Change Number
- Settings: off ... 95, AT, VEL, PB

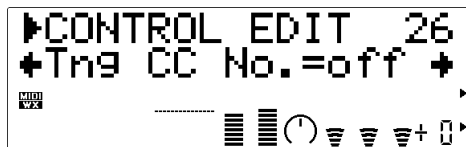

“Tonguing” simulates the half-tonguing technique used by saxophone players by changing the “slit” of the reed. The slit is the space between the tip of the reed and the mouthpiece. The “Tng CC No.” parameter specifies the controller to be used for tonguing control. When set to “off” no tonguing is applied.

- Please note that accurate keyboard pitch is produced only when maximum tonguing is applied or the tonguing controller is turned off.
- The “EmbCtrlDpt” parameter, below, must be set to an appropriate value (higher than “+01” or lower than “-01”) for tonguing control to have any effect.

## 27(17): TngCtrlDpt

- Tonguing Control Depth
- Settings: -127 ... +127 (VL-XG Mode: -64 ... +63)

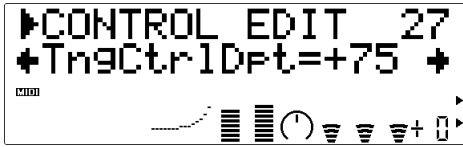

Sets the amount of variation produced by the controller assigned to tonguing. The higher the value the greater the variation. Positive values cause an decrease in tonguing in response to higher controller values (e.g. increased breath pressure or higher modulation wheel position), while minus values cause an increase in tonguing in response to higher controller values. The “Depth” setting is reflected in the graph at the bottom of the display — the horizontal axis represents the controller value and the vertical axis represents tonguing.

## 28: Tng Curve (VOICE mode only)

- Tonguing Curve
- Settings: -16 ... +16

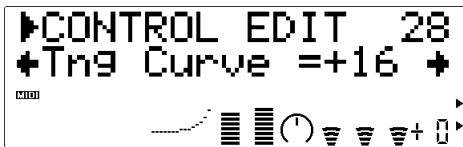

Determines the relationship between the controller value and tonguing. When set to “+00” the relationship is linear. That is, a change in the controller value produces a corresponding change in tonguing. As the curve value increases the lower end of the controller range has relatively little effect on the sound while higher controller values produce more dramatic changes. Negative curve values have the opposite effect: the sound changes dramatically at low controller values while higher values produce relatively little effect. The “Curve” setting is reflected in the graph at the bottom of the display — the horizontal axis represents the controller value and the vertical axis represents tonguing.

## Scream

## 29(18): Scr CC No.

- Scream Control Change Number
- Settings: off ... 95, AT, VEL, PB

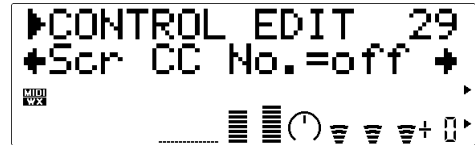

“Scream” drives the entire system into chaotic oscillation, creating effects that can only be achieved with physical modeling technology. The “Scr CC No.” parameter specifies the controller to be used for scream control. When set to “off”, no scream variation can be produced via a controller, but a continuous scream value is determined by the “30(19): ScrCtrlDpt” parameter, below (negative values increase the scream level).

- The “ScrCtrlDpt” parameter, below, must be set to an appropriate value (higher than “+01” or lower than “-01”) for scream control to have any effect.

## 30(19): ScrCtrlDpt

- Scream Control Depth
- Settings: -127 ... +127 (VL-XG Mode: -64 ... +63)

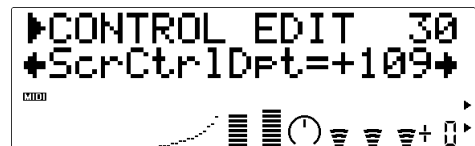

Sets the amount of variation produced by the controller assigned to scream. The higher the value the greater the variation. Positive values cause an increase in scream effect in response to higher controller values (e.g. increased breath pressure or higher modulation wheel position), while minus values cause a decrease in scream effect in response to higher controller values. The “Depth” setting is reflected in the graph at the bottom of the display — the horizontal axis represents the controller value and the vertical axis represents scream.

### 31: Scr Curve (VOICE mode only)

- Scream Curve
- Settings: -16 ... +16

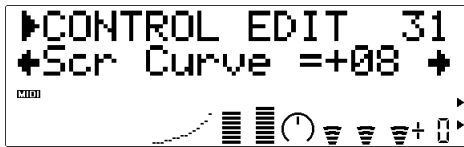

Determines the relationship between the controller value and scream. When set to “+00” the relationship is linear. That is, a change in the controller value produces a corresponding change in scream effect. As the curve value increases the lower end of the controller range has relatively little effect on the sound while higher controller values produce more dramatic changes. Negative curve values have the opposite effect: the sound changes dramatically at low controller values while higher values produce relatively little effect. The “Curve” setting is reflected in the graph at the bottom of the display — the horizontal axis represents the controller value and the vertical axis represents scream.

## Breath Noise

### 32(20): Bnz CC No.

- Breath Noise Control Change Number
- Settings: off... 95, AT, VEL, PB

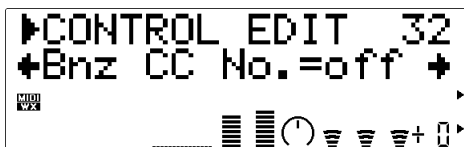

“Breath Noise” can be used to add the required amount of breath noise to a voice. The “Bnz CC No.” parameter specifies the controller to be used for breath noise control. When set to “off”, no breath noise variation can be produced via a controller, but a continuous breath noise value is determined by the “33(21): BnzCtrlDpt” parameter, below (negative values increase the breath noise level).

- The “BnzCtrlDpt” parameter, below, must be set to an appropriate value (higher than “+01” or lower than “-01”) for breath noise control to have any effect.

### 33(21): BnzCtrlDpt

- Breath Noise Control Depth
- Settings: -127 ... +127 (VL-XG Mode: -64 ... +63)

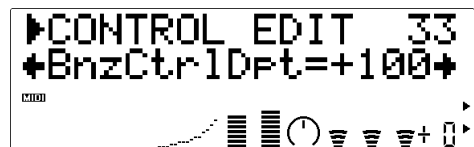

Sets the amount of variation produced by the controller assigned to breath noise. The higher the value the greater the variation. Positive values cause an increase in breath noise in response to higher controller values (e.g. increased breath pressure or higher modulation wheel position), while minus values cause a decrease in breath noise in response to higher controller values. The “Depth” setting is reflected in the graph at the bottom of the display — the horizontal axis represents the controller value and the vertical axis represents breath noise.

### 34: Bnz Curve (VOICE mode only)

- Breath Noise Curve
- Settings: -16 ... +16

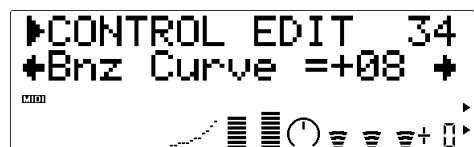

Determines the relationship between the controller value and breath noise. When set to “+00” the relationship is linear. That is, a change in the controller value produces a corresponding change in breath noise. As the curve value increases the lower end of the controller range has relatively little effect on the sound while higher controller values produce more dramatic changes. Negative curve values have the opposite effect: the sound changes dramatically at low controller values while higher values produce relatively little effect. The “Curve” setting is reflected in the graph at the bottom of the display — the horizontal axis



represents the controller value and the vertical axis represents breath noise.

- The amount of breath noise produced also depends on pressure, so the breath noise curve indicated by the graph at the bottom of the display may not always accurately reflect the perceived curve.

## Growl

### 35(22): Gr1 CC No.

- Growl Control Change Number
- Settings: off... 95, AT, VEL, PB

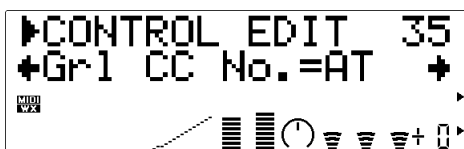

“Growl” produces a periodic pressure modulation which produces the “growl” effect often heard in wind instruments. The “Gr1 CC No.” parameter specifies the controller to be used for growl control. When set to “off”, no growl variation can be produced via a controller, but a continuous growl value is determined by the “36(23): Gr1CtrlDpt” parameter, below (negative values increase the growl level).

- The “Gr1CtrlDpt” parameter, below, must be set to an appropriate value (higher than “+01” or lower than “-01”) for growl control to have any effect.

### 36(23): Gr1CtrlDpt

- Growl Control Depth
- Settings: -127 ... +127 (VL-XG Mode: -64 ... +63)

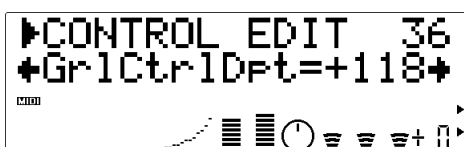

Sets the amount of variation produced by the controller assigned to growl. The higher the value the greater the variation. Positive values cause an increase in growl effect in response to higher controller values (e.g. increased breath pressure or higher modulation wheel position), while minus values cause a decrease in growl effect in response to higher controller values. The “Depth” setting is reflected in the graph at the bottom of the display — the horizontal axis represents the controller value and the vertical axis represents growl.

### 37: Gr1 Curve (VOICE mode only)

- Growl Curve
- Settings: -16 ... +16

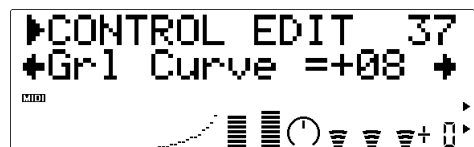

Determines the relationship between the controller value and growl. When set to “+00” the relationship is linear. That is, a change in the controller value produces a corresponding change in growl. As the curve value increases the lower end of the controller range has relatively little effect on the sound while higher controller values produce more dramatic changes. Negative curve values have the opposite effect: the sound changes dramatically at low controller values while higher values produce relatively little effect. The “Curve” setting is reflected in the graph at the bottom of the display — the horizontal axis represents the controller value and the vertical axis represents growl.

## Throat Formant

### 38(24): Thr CC No.

- Throat Formant Control Change Number
- Settings: off... 95, AT, VEL, PB

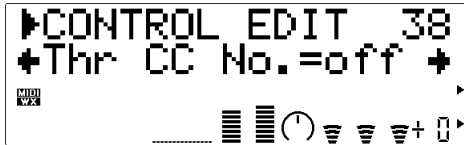

“Throat Formant” controls the characteristics of the simulated player’s lungs, trachea, and oral cavity. Can add a realistic “roughness” to the sound. The “Thr CC No.” parameter specifies the controller to be used for throat formant control. When set to “off”, no throat formant variation can be produced via a controller, but a continuous throat formant value is determined by the “39(25): ThrCtrlDpt” parameter, below (negative values increase the throat formant level).

- The “ThrCtrlDpt” parameter, below, must be set to an appropriate value (higher than “+01” or lower than “-01”) for throat formant control to have any effect.
- Throat Formant only applies to some reed-type voices.

### 39(25): ThrCtrlDpt

- Throat Formant Control Depth
- Settings: -127 ... +127 (VL-XG Mode: -64 ... +63)

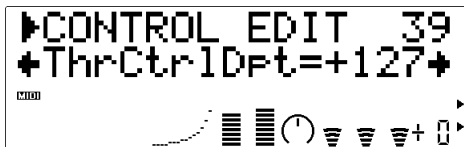

Sets the amount of variation produced by the controller assigned to throat formant. The higher the value the greater the variation. Positive values cause an increase in throat formant effect in response to higher controller values (e.g. increased breath pressure or higher modulation wheel position), while minus values cause a decrease in throat formant effect in response to higher controller values. The “Depth” setting is reflected in the graph at the bottom of the display — the horizontal axis represents the controller value and the vertical axis represents throat formant depth.

### 40: Thr Curve (VOICE mode only)

- Throat Formant Curve
- Settings: -16 ... +16

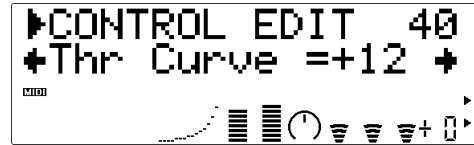

Determines the relationship between the controller value and throat formant depth. When set to “+00” the relationship is linear. That is, a change in the controller value produces a corresponding change in throat formant depth. As the curve value increases the lower end of the controller range has relatively little effect on the sound while higher controller values produce more dramatic changes. Negative curve values have the opposite effect: the sound changes dramatically at low controller values while higher values produce relatively little effect. The “Curve” setting is reflected in the graph at the bottom of the display — the horizontal axis represents the controller value and the vertical axis represents throat formant depth.

## Harmonic Enhancer

### 41(26): Hrm CC No.

- Harmonic Enhancer Control Change Number
- Settings: off ... 95, AT, VEL, PB

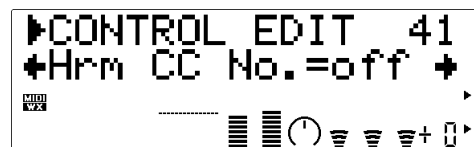

The Harmonic Enhancer can vary the harmonic structure of the sound over a wide range. The “Hrm CC No.” parameter specifies the controller to be used for harmonic enhancer depth (wet/dry balance) control. When set to “off” no harmonic enhancer depth variation can be applied via a controller.

- The “HrmCtrlDpt” parameter, below, must be set to an appropriate value (higher than “+01”

or lower than “-01”) for harmonic enhancer control to have any effect.

- Since most VL70-m voices have sufficient natural harmonic content, the Harmonic Enhancer is actually only used on a few voices. Therefore changing the controller destination with many voices will produce either no change in the sound or a simple change in amplitude. For detailed harmonic enhancer programming use the VL70-m Expert Editor software (page 25).

#### 42(27): HrmCtrlDpt

- Harmonic Enhancer Control Depth
- Settings: -127 ... +127 (VL-XG Mode: -64 ... +63)

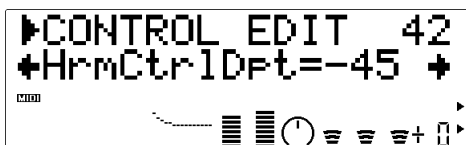

Sets the amount of variation produced by the controller assigned to the harmonic enhancer. The higher the value the greater the variation. Positive values cause an increase in harmonic enhancer depth in response to higher controller values (e.g. increased breath pressure or higher modulation wheel position), while minus values cause a decrease in harmonic enhancer depth in response to higher controller values. The “Depth” setting is reflected in the graph at the bottom of the display — the horizontal axis represents the controller value and the vertical axis represents harmonic enhancer depth .

#### 43: Hrm Curve (VOICE mode only)

- Harmonic Enhancer Curve
- Settings: -16 ... +16

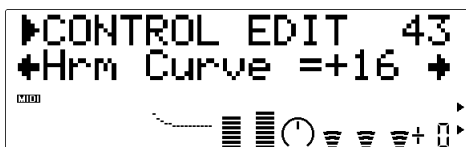

Determines the relationship between the controller value and harmonic enhancer depth. When set to “+00” the relationship is linear. That is, a change in the controller value produces a corresponding

change in harmonic enhancer depth. As the curve value increases the lower end of the controller range has relatively little effect on the sound while higher controller values produce more dramatic changes. Negative curve values have the opposite effect: the sound changes dramatically at low controller values while higher values produce relatively little effect. The “Curve” setting is reflected in the graph at the bottom of the display — the horizontal axis represents the controller value and the vertical axis represents harmonic enhancer depth.

## Damping

#### 44(28): Dmp CC No.

- Damping Control Change Number
- Settings: off... 95, AT, VEL, PB

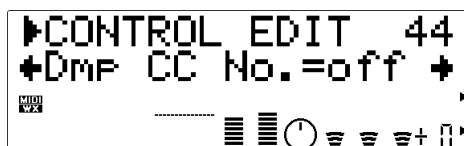

“Damping” simulates the effect of damping due to losses within the body of a wind instrument or in a string due to air friction. Affects both pitch and timbre. The “Dmp CC No.” parameter specifies the controller to be used for damping control. When set to “off” no damping variation can be applied via a controller.

- Please note that accurate keyboard pitch is produced only when damping is maximum.
- The “DmpCtrlDpt” parameter, below, must be set to an appropriate value (higher than “+01” or lower than “-01”) for damping control to have any effect.

#### 45(29): DmpCtrlDpt

- Damping Control Depth
- Settings: -127 ... +127 (VL-XG Mode: -64 ... +63)

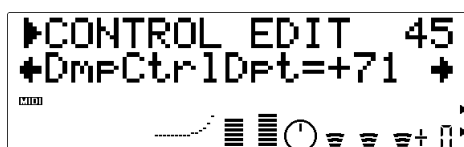

## Absorption

Sets the amount of variation produced by the controller assigned to damping. The higher the value the greater the variation. Positive values cause a decrease in damping in response to higher controller values (e.g. increased breath pressure or higher modulation wheel position), while minus values cause an increase in damping in response to higher controller values. The “Depth” setting is reflected in the graph at the bottom of the display — the horizontal axis represents the controller value and the vertical axis represents damping.

### 46: Dmp Curve (VOICE mode only)

- Damping Curve
- Settings: -16 ... +16

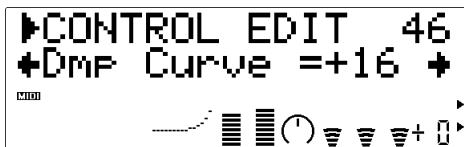

Determines the relationship between the controller value and damping. When set to “+00” the relationship is linear. That is, a change in the controller value produces a corresponding change in damping. As the curve value increases the lower end of the controller range has relatively little effect on the sound while higher controller values produce more dramatic changes. Negative curve values have the opposite effect: the sound changes dramatically at low controller values while higher values produce relatively little effect. The “Curve” setting is reflected in the graph at the bottom of the display — the horizontal axis represents the controller value and the vertical axis represents damping.

### 47(30): Abs CC No.

- Absorption Control Change Number
- Settings: off ... 95, AT, VEL, PB

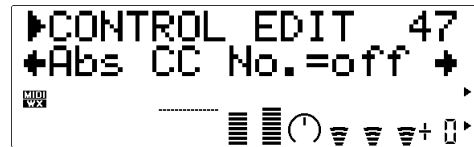

“Absorption” simulates the effect of high-frequency loss at the end of the air column or string. The “Abs CC No.” parameter specifies the controller to be used for absorption control. When set to “off” no absorption variation can be applied via a controller.

- Please note that accurate keyboard pitch is produced only at when absorption is maximum.
- The “AbsCtrlDpt” parameter, below, must be set to an appropriate value (higher than “+01” or lower than “-01”) for absorption control to have any effect.

### 48(31): AbsCtrlDpt

- Absorption Control Depth
- Settings: -127 ... +127 (VL-XG Mode: -64 ... +63)



Sets the amount of variation produced by the controller assigned to absorption. The higher the value the greater the variation. Positive values cause a decrease in absorption in response to higher controller values (e.g. increased breath pressure or higher modulation wheel position), while minus values cause an increase in absorption in response to higher controller values. The “Depth” setting is reflected in the graph at the bottom of the display — the horizontal axis represents the controller value and the vertical axis represents absorption.

---

#### 49: Abs Curve (VOICE mode only)

- Absorption Curve
- Settings: -16 ... +16

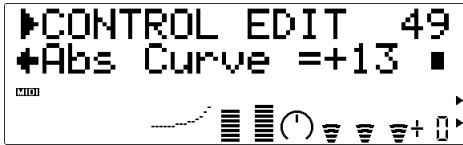

Determines the relationship between the controller value and absorption. When set to “+00” the relationship is linear. That is, a change in the controller value produces a corresponding change in absorption. As the curve value increases the lower end of the controller range has relatively little effect on the sound while higher controller values produce more dramatic changes. Negative curve values have the opposite effect: the sound changes dramatically at low controller values while higher values produce relatively little effect. The “Curve” setting is reflected in the graph at the bottom of the display — the horizontal axis represents the controller value and the vertical axis represents absorption.

- Absorption control can have a significant effect on pitch.

---

# Filter & Envelope Generator Editing

The VL70-m has two envelope generators which can be independently programmed to produce time-based variations in the sound.

## ● Amplitude & Filter EG

The Amplitude & Filter Envelope Generator controls both the amplitude of the sound and the cutoff frequency of the VL70-m filter from note attack to release. This envelope generator has three parameters which can be edited via the VL70-m panel: attack time, decay time, and release time. Amplitude control defines the basic “shape” of the notes produced, while filter control makes it possible to create a variety of dynamic timbral sweeps.

### ■ NOTES

- *Most voices use the low-pass filter type, but some use the bandpass, high-pass, or band eliminate types. The filter type cannot be edited via the VL70-m panel controls. For detailed filter parameter programming use the VL70-m Expert Editor software (page 25).*
- *Very little filter processing is used on some voices. In such cases, the effect of the filter may be barely noticeable.*
- *The effect of editing the Amplitude & Filter envelope generator parameters may not always be as expected — particularly with plucked string instrument voices such as guitar or bass. This is because the VL70-m actually simulates the plucking, free oscillation, and muting of the strings rather than simply using an EG to approximate these events.*

## ● Pitch & Embouchre EG

The Pitch EG controls both the pitch of the note and the embouchre applied to the note from attack to release. Initial level, attack time, release level, and release time parameters make it possible to produce a wide range of pitch variations at note attack and release.

### ■ NOTES

- *Pitch control alone may not always produce the expected result with voices in which the internal parameters emphasize embouchure rather than pitch. For detailed editing of all VL70-m parameters use the VL70-m Expert Editor software (page 25).*

---

## Accessing & Editing the Filter & EG Parameters

The FILTER & EG EDIT mode can be accessed from the PLAY mode as follows:

### 1. Press [EDIT]

Press the [EDIT] button to go to the EDIT sub-mode menu.



### 2. Select the FIL&EG Sub-mode

Use the SELECT [◀] and [▶] buttons to select the FIL&EG sub-mode, if necessary. The icon to the left of “FIL&EG” on the display will flash when the FIL&EG sub-mode is selected.

### 3. Press [ENTER]

Press the [ENTER] button to go to the FILTER & EG EDIT mode.

“FIL&EG EDIT” will appear at the top of the display along with the number of the currently selected control parameter.



### 4. Select a Parameter

Use the SELECT [◀] and [▶] buttons to select the parameter you want to edit (see “The Filter & EG Edit Parameters”, below). The name of the currently selected parameter and its current setting appear on the second line of the display. An arrow to the left and/or right of the parameter name/value indicates that the SELECT [◀] and/or [▶] buttons can be used to select more parameters in the indicated direction.



---

### 5. Edit the Selected Parameter

Use the VALUE [-] and [+] buttons to set the value of the selected parameter as required.



### 6. Repeat As Necessary

Repeat steps 4 and 5 to edit as many parameters as required.

### 7. Exit When Done

Press the [EXIT] button to return to the EDIT sub-mode menu, or the [PLAY] button to return to the PLAY mode when you're finished editing.

■ **IMPORTANT!**

- *If you want to keep the changes you made in the VOICE EDIT mode, be sure to store the edited voice to an appropriate INTERNAL voice number before selecting a new voice. All edited data will be lost if you select a new voice before storing the edited voice!*



---

## The Filter & EG Edit Parameters

Please note that a number of FIL&EG EDIT parameters which are available in the VOICE sound module mode are not available in the VL-XG sound module mode (page 28). The parameter numbers are therefore different in each mode.

### ● VOICE Sound Module Mode Filter & EG Edit Parameters

Refer to the page numbers listed for full details on each parameter.

<b>Filter</b> .....	<b>71</b>
01: CutoffFreq (Cutoff Frequency)	
02: Resonance (Resonance)	
03: FILEG Dept (Filter Envelope Generator Depth)	
04: CutoffScBP (Cutoff Scaling Breakpoint)	
05: CutoffScDpt (Cutoff Scaling Depth)	
06: Bass (Bass Tone Control)	
07: Treble (Treble Tone Control)	
<b>Amplitude &amp; Filter Envelope</b> .....	<b>72</b>
08: Attack Time (Amplitude & Filter Envelope Attack Time)	
09: Decay Time (Amplitude & Filter Envelope Decay Time)	
10: ReleaseTime (Amplitude & Filter Envelope Release Time)	
11: AmpLvlScBP (Amplitude Level Scaling Breakpoint)	
12: AmpLvlScDpt (Amplitude Level Scaling Depth)	
<b>Pitch &amp; Embouchure Envelope</b> .....	<b>73</b>
13: PEGInitLvl (Pitch & Embouchure Envelope Initial Level)	
14: PEGAtakTime (Pitch & Embouchure Envelope Attack Time)	
15: PEGReleLvl (Pitch & Embouchure Envelope Release Level)	
16: PEGReleTime (Pitch & Embouchure Envelope Release Time)	

---

## ● VL-XG Sound Module Mode Filter & EG Edit Parameters

Refer to the page numbers listed for full details on each parameter.

### **Filter ..... 71**

- 01: CutoffFreq (Cutoff Frequency)
- 02: Resonance (Resonance)
- 03: FILEG Dept (Filter Envelope Generator Depth)
- 04: Bass (Bass Tone Control)
- 05: Treble (Treble Tone Control)

### **Amplitude & Filter Envelope ..... 72**

- 06: Attack Time (Amplitude & Filter Envelope Attack Time)
- 07: Decay Time (Amplitude & Filter Envelope Decay Time)
- 08: ReleaseTime (Amplitude & Filter Envelope Release Time)

### **Pitch & Embouchure Envelope ..... 73**

- 09: PEGInitLvl (Pitch & Embouchure Envelope Initial Level)
- 10: PEGAtakTime (Pitch & Embouchure Envelope Attack Time)
- 11: PEGReleLvl (Pitch & Embouchure Envelope Release Level)
- 12: PEGReleTime (Pitch & Embouchure Envelope Release Time)

## ● Filter & EG Edit Parameter Descriptions

The small parameter numbers in parentheses apply in the VL-XG sound module mode.

### Filter

#### ● Example: low pass filter

- Resonance: minimum
- Resonance: maximum

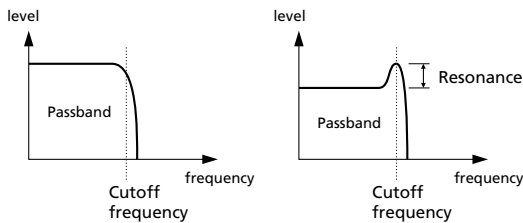

#### 01(01): CutoffFreq

- Cutoff Frequency
- Settings: -64 ... +63



Sets the cutoff frequency of the VL70-m filter.

#### 02(02): Resonance

- Resonance
- Settings: -64 ... +63



This parameter produces a resonant peak at the filter's cutoff frequency, thereby emphasizing frequency components at that frequency. When "Resoance" is set to its minimum value, the filter response rolls off sharply at the cutoff point. As the resonance value is increased, however, a peak of correspondingly increasing amplitude is produced at the cutoff frequency.

#### 03(03): FileG Dept

- Filter EG Depth
- Settings: -64 ... +63



The "FileG Dept" parameter determines to what degree the amplitude /filter envelope generator (see "08(06): Attack Time", "09(07): Decay Time", and "10(08): ReleaseTime", below) affects the filter's cutoff frequency. Higher values allow the envelope generator to vary the filter cutoff frequency over a wider range.

#### 04: CutoffScBP (VOICE mode only)

- Cutoff Scaling Breakpoint
- Settings: C-2 ... G8



Filter cutoff frequency "scaling" ( or "key scaling") produces natural timbre variations across the VL70-m note range by allowing an increasing or decreasing filter "depth" curve to be applied above or below a specified "breakpoint" note. The "CutoffScBP" parameter specifies the breakpoint note.

#### 05: CutoffScDpt (VOICE mode only)

- Cutoff Scaling Depth
- Settings: -64 ... +63



This parameter specifies the amount of filter cutoff frequency key scaling to be applied above or below

the breakpoint note specified by the “CutoffScBP” parameter, above. A setting of “+00” produces no key scaling. Positive values apply scaling to notes below the breakpoint (i.e. on a keyboard, notes to the left of the breakpoint), producing a gradual lowering of the cutoff frequency down the scale. Negative values apply scaling to notes above the breakpoint (i.e. on a keyboard, notes to the right of the breakpoint), producing a gradual lowering of the cutoff frequency up the scale. Higher positive or negative values produce a greater variation in the filter cutoff frequency.

#### 06(04): Bass

- Bass Tone Control
- Settings: -64 ... +63



Boosts or cuts the low frequencies. Positive values boost the lows while negative values cut the lows. A setting of “+00” produces no boost or cut.

#### 07(05): Treble

- Treble Tone Control
- Settings: -64 ... +63



Boosts or cuts the high frequencies. Positive values boost the highs while negative values cut the highs. A setting of “+00” produces no boost or cut.

### Amplitude & Filter Envelope

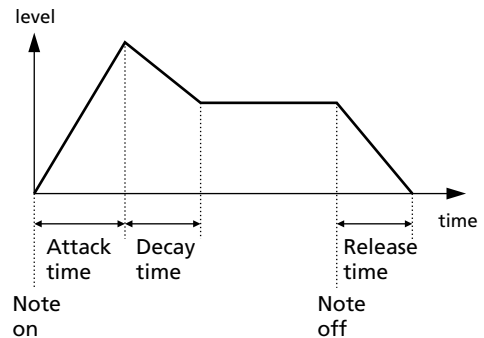

#### 08(06): Attack Time

- Amplitude & Filter Envelope Attack Time
- Settings: -64 ... +63



Sets the attack time of the amplitude & filter envelope generator. “Attack time” refers to the length of time it takes for the envelope to reach maximum level from the instant a note is played. Positive values produce a slower attack while negative values produce a faster attack.

#### 09(07): Decay Time

- Amplitude & Filter Envelope Decay Time
- Settings: -64 ... +63



Sets the decay time of the amplitude & filter envelope generator. “Decay time” refers to the length of time it takes for the envelope to fall to the sustain level after the maximum attack level has been reached. Positive values produce a slower decay while negative values produce a faster decay.

### 10(08): ReleaseTime

- Amplitude & Filter Envelope Release Time
- Settings: -64 ... +63



Sets the release time of the amplitude & filter envelope generator. “Release time” refers to the length of time it takes for the envelope to fall to “zero” level after the note has been released. Positive values produce a slower release while negative values produce a faster release.

### 11: AmpLvlScBP (VOICE mode only)

- Amplitude Level Scaling Breakpoint
- Settings: C-2 ... G8



Amplitude level “scaling” ( or “key scaling”) produces natural level variations across the VL70-m note range by allowing an increasing or decreasing amplitude “depth” curve to be applied above or below a specified “breakpoint” note. The “AmpLvlScBP” parameter specifies the breakpoint note.

### 12: AmpLvlScDpt (VOICE mode only)

- Amplitude Level Scaling Depth
- Settings: -64 ... +63



This parameter specifies the amount of amplitude level key scaling to be applied above or below the breakpoint note specified by the “AmpLvlScBP” parameter, above. A setting of “+00” produces no key scaling. Positive values apply scaling to notes below the breakpoint (i.e. on a keyboard, notes to the left of the breakpoint), producing a gradual

lowering of amplitude level down the scale. Negative values apply scaling to notes above the breakpoint (i.e. on a keyboard, notes to the right of the breakpoint), producing a gradual lowering of amplitude level up the scale. Higher positive or negative values produce a greater variation in the amplitude level.

## Pitch & Embouchure Envelope

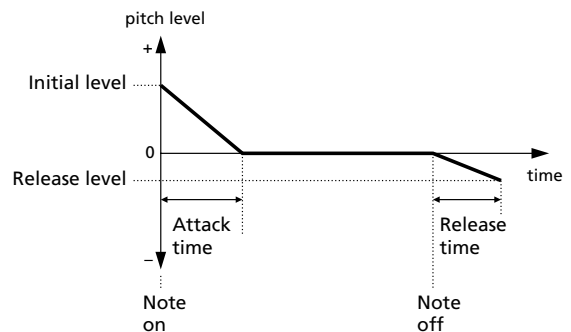

### 13(09): PEGinitLvl

- Pitch & Embouchure Envelope Initial Level
- Settings: -64 ... +63



Sets the initial level of the pitch & embouchure envelope generator. A setting of “+00” starts the pitch envelope at normal pitch. Positive values raise the initial pitch while negative values lower the initial pitch in relation to normal pitch.

---

#### 14(10): PEGAtakTime

- Pitch & Embouchure Envelope Attack Time
- Settings: -64 ... +63



Sets the attack time of the pitch & embouchure envelope generator. In this case “attack time” refers to the length of time it takes for the pitch envelope to reach normal pitch (“+00” level) from the instant a note is played. Positive values produce a slower attack while negative values produce a faster attack.

#### 15(11): PEGReleLvl

- Pitch & Embouchure Envelope Release Level
- Settings -64 ... +63



Sets the final pitch to be reached after a note is released. A setting of “+00” produces normal pitch. Positive values raise the final pitch while negative values lower the final pitch in relation to normal pitch.

#### 16(12): PEGReleTime

- Pitch & Embouchure Envelope Release Time
- Settings: -64 ... +63



Sets the release time of the pitch & embouchure envelope generator. “Release time” refers to the length of time it takes for the pitch envelope to reach the release level specified by the “PEGReleLvl” parameter (above) after a note is released. Positive values produce a slower release while negative values produce a faster release.

#### ■ NOTES

- The effect of the Pitch & Embouchure EG settings may be less noticeable on voices in which the embouchure is changed.

---

# Other Edit Parameters

The OTHERS EDIT mode provides access to a range of editable voice parameters that do not fall into the CONTROLLER or FILTER & EG categories.

## Accessing & Editing the “Others” Parameters

The OTHERS EDIT mode can be accessed from the PLAY mode as follows:

1. Press [EDIT]

Press the [EDIT] button to go to the EDIT sub-mode menu.



2. Select the OTHERS Sub-mode

Use the SELECT [◀] and [▶] buttons to select the OTHERS sub-mode, if necessary. The icon to the left of “OTHERS” on the display will flash when the OTHERS sub-mode is selected.

3. Press [ENTER]

Press the [ENTER] button to go to the OTHERS EDIT mode. “OTHERS” will appear at the top of the display along with the number of the currently selected control parameter.



4. Select a Parameter

Use the SELECT [◀] and [▶] buttons to select the parameter you want to edit (see “The Others Parameters”, below). The name of the currently selected parameter and its current setting appear on the second line of the display. An arrow to the left and/or right of the parameter name/value indicates that the SELECT [◀] and/or [▶] buttons can be used to select more parameters in the indicated direction.



---

### 5. Edit the Selected Parameter

Use the VALUE [-] and [+] buttons to set the value of the selected parameter as required.



### 6. Repeat As Necessary

Repeat steps 4 and 5 to edit as many parameters as required.

### 7. Exit When Done

Press the [EXIT] button to return to the EDIT sub-mode menu, or the [PLAY] button to return to the PLAY mode when you're finished editing.

#### ■ IMPORTANT!

- *If you want to keep the changes you made in the VOICE EDIT mode, be sure to store the edited voice to an appropriate INTERNAL voice number before selecting a new voice. All edited data will be lost if you select a new voice before storing the edited voice!*



---

## The “Others” Edit Parameters

Please note that a number of OTHERS EDIT parameters which are available in the VOICE sound module mode are not available in the VL-XG sound module mode (page 28). The parameter numbers are therefore different in each mode.

### ● VOICE Sound Module Mode “Others” Edit Parameters

Refer to the page numbers listed for full details on each parameter.

<b>Vibrato</b> .....	<b>79</b>
01: Vib Rate (Vibrato Rate)	
02: Vib Depth (Vibrato Depth)	
03: Vib Delay (Vibrato Delay)	
<b>Detune &amp; Voice Level</b> .....	<b>79</b>
04: Detune (Detune)	
05: VoiceLevel (Voice Level)	
<b>Assignment &amp; Expansion</b> .....	<b>80</b>
06: Mono/Poly (Monophonic/Polyphonic Mode)	
07: AssignMode (Assign Mode)	
08: PolyExpnd (Polyphonic Expansion)	
<b>Velocity Sensitivity</b> .....	<b>81</b>
09: VelSensDpt (Velocity Sensitivity Depth)	
10: VelSensOfs (Velocity Sensitivity Offset)	
<b>Note Limits</b> .....	<b>81</b>
11: NoteLimitL (Low Note Limit)	
12: NoteLimitH (High Note Limit)	
<b>Portamento</b> .....	<b>82</b>
13: Porta Mode (Portamento Mode)	
14: Porta Sw (Portamento Switch)	
15: Porta Time (Portamento Time)	
<b>Dry Level &amp; Voice Name</b> .....	<b>82</b>
16: Dry Level (Dry Output Level)	
17: Voice Name (Voice Name)	

---

## ● VL-XG Sound Module Mode “Others” Edit Parameters

Refer to the page numbers listed for full details on each parameter.

<b>Vibrato</b> .....	<b>79</b>
01: Vib Rate (Vibrato Rate)	
02: Vib Depth (Vibrato Depth)	
03: Vib Delay (Vibrato Delay)	
<b>Detune</b> .....	<b>79</b>
04: Detune (Detune)	
<b>Assignment</b> .....	<b>80</b>
05: Mono/Poly (Monophonic/Polyphonic Mode)	
<b>Velocity Sensitivity</b> .....	<b>81</b>
06: VelSensDpt (Velocity Sensitivity Depth)	
07: VelSensOfs (Velocity Sensitivity Offset)	
<b>Note Limits</b> .....	<b>81</b>
08: NoteLimitL (Low Note Limit)	
09: NoteLimitH (High Note Limit)	
<b>Portamento</b> .....	<b>82</b>
10: Porta Sw (Portamento Switch)	
11: Porta Time (Portamento Time)	
<b>Dry Level</b> .....	<b>82</b>
12: Dry Level (Dry Output Level)	

## ● “Others” Edit Parameter Descriptions

The small parameter numbers in parentheses apply in the VL-XG sound module mode.

### Vibrato

#### 01(01): Vib Rate

- Vibrato Rate
- Settings: -64 ... +63



The vibrato effect produces a cyclic variation in pitch and embouchure. The “Vib Rate” parameter sets the speed of the vibrato effect. Positive values produce a faster vibrato, while negative values produce a slower vibrato.

- In the VL70-m extremely realistic vibrato effects are produced by simultaneously modulating the pitch, embouchure, and pressure parameters.

#### 02(02): Vib Depth

- Vibrato Depth
- Settings: -64 ... +63



Sets the depth of the vibrato effect. The higher the value the greater the vibrato depth. Positive values produce greater vibrato depth while negative values result in reduced vibrato depth.

#### 03(03): Vib Delay

- Vibrato Delay
- Settings: -64 ... +63

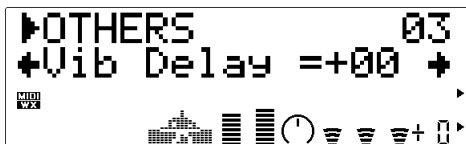

Sets the delay time between the beginning of a note and the beginning of the vibrato effect. Positive values produce longer delays while negative values result in shorter delays.

### Detune & Voice Level

#### 04(04): Detune

- Detune
- Settings: -12.8 ... +12.7 Hz

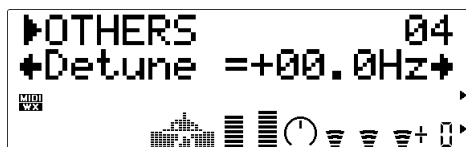

The “Detune” parameter allows the pitch of the VL70-m to be shifted slightly upward or downward to produce detune effects in relation to other VL70-m units or other tone generators being used with the VL70-m. Positive values shift the pitch upward by the indicated amount in Hertz, and negative values shift the pitch downward.

#### 05: Voice Level (VOICE mode only)

- Voice Level
- Settings: 000 ... 127



Sets the level (volume) of the voice. The higher the value the higher the volume. The minimum setting of “000” will result in no sound.

## Assignment & Expansion

### 06(05): Mono/Poly

- Monophonic/Polyphonic Mode
- Settings: mono, poly



Selects the VL70-m monophonic or polyphonic note mode. When the “mono” mode is selected note output will always be generated as long as a MIDI note-on message is being received. For example, if you play key “A” on your keyboard and then, while still holding “A”, play key “B”, note “B” will sound but will switch back to note “A” the instant key “B” is released. In the “poly” mode however, sound output will stop the instant key “B” is released.

- When “mono” is selected and the “14(10): Porta Sw” parameter is turned “on”, the “single-trigger” mode is engaged (i.e. the EG is not re-triggered if a new note is played while a previous note is held). In all other cases (e.g. the “poly” mode is selected or the “14(10): Porta Sw” parameter is turned “off”) the “multi-trigger” mode is engaged and the EG will be re-triggered every time a note is played.

### 07: AssignMode (VOICE mode only)

- Assign Mode
- Settings: Botm, Top, Last



Determines which note will be played when more than one note is played at a time. When “Botm” (Bottom) is selected only the lowest note in a group of notes played simultaneously will sound. When “Top” is selected only the highest note in a group of notes played simultaneously will sound. The “Last” setting causes only the last note played to sound.

### 08: PolyExpnd (VOICE mode only)

- Polyphonic Expansion
- Settings: Off, 02>01, 02>02, 03>01, 03>02, 03>03 ... 32>32



This parameter is used when several VL70-m units are used together to increase the number of notes which can be played simultaneously (polyphony). The number preceding the “>” should be set to correspond to the number of VL70-m units to be used. The number following the “>” should be set to a different consecutive number for each VL70-m unit. For example, if you use four VL70-m units their “PolyExpnd” parameters should be set as follows:

VL70-m Unit No.	PolyExpnd Setting
1	04>01
2	04>02
3	04>03
4	04>04

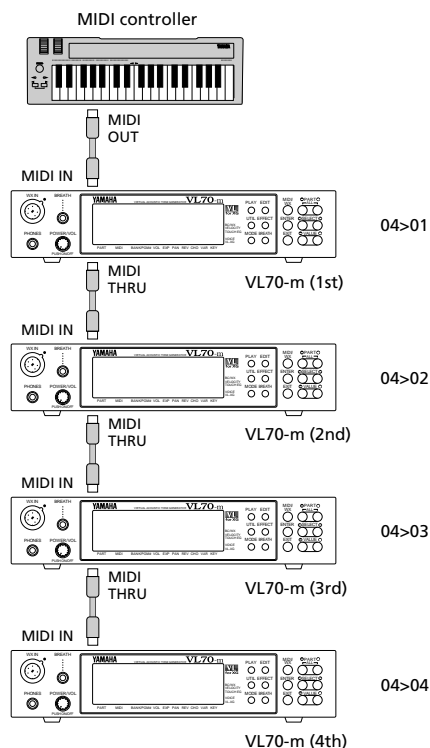

- Polyphonic Expansion will not function when the “06(05): Mono/Poly” parameter is set to “mono”.
- When using Polyphonic Expansion be sure to set the “07: AssignMode” parameter to “Last”.

The horizontal axis represents keyboard velocity and the vertical axis represents output level.

## Velocity Sensitivity

### 09(06): VelSensDpt

- Velocity Sensitivity Depth
- Settings: 000 ... 127

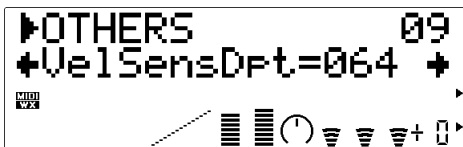

Determines how the VL70-m responds to keyboard velocity. When set to “000”, keyboard velocity (i.e. how fast or hard the keyboard is played) has no effect on the sound. At values higher than “001”, however, high keyboard velocities will increase the level of the sound and low keyboard velocities will decrease the level of the sound. The higher the value the greater the effect of keyboard velocity on the voice level. The graph at the bottom of the display indicates the current velocity sensitivity response as determined by the “09(06): VelSensDpt” and “10(07): VelSensOfs” parameters. The horizontal axis represents keyboard velocity and the vertical axis represents output level.

### 10(07): VelSensOfs

- Velocity Sensitivity Offset
- Settings: 000 ... 127

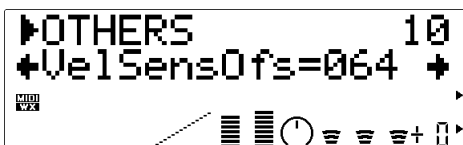

Specifies an offset value that will apply to the lowest keyboard velocity level. The graph at the bottom of the display indicates the current velocity sensitivity response as determined by the “09(06): VelSensDpt” and “10(07): VelSensOfs” parameters.

## Note Limits

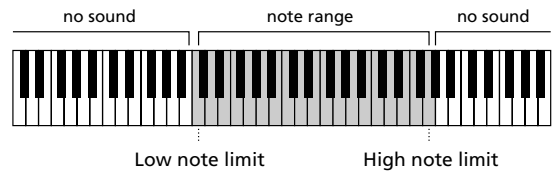

### 11(08): NoteLimitL

- Low Note Limit
- Settings: C-2 ... G8



Specifies the lowest note that will be produced by the VL70-m. This and the “NoteLimitH” parameter, below, specify the VL70-m note range.

### 12(09): NoteLimitH

- High Note Limit
- Settings: C-2 ... G8



Specifies the highest note that will be produced by the VL70-m. This and the “NoteLimitL” parameter, above, specify the VL70-m note range.

## Portamento

### 13: Porta Mode (VOICE mode only)

- Portamento Mode
- Settings: Full, Fngr



Portamento produces a “slide” effect between subsequently played notes. The “Portamento Mode” parameter determines how the portamento slide is produced. When “Full” is selected the portamento slide will occur between any two subsequent notes when the “14(10): Porta Sw” parameter, below, is “on” even if the first note is released before the second is played. When “Fngr”(Fingered) is selected the portamento slide will only occur if the first note is still held when the second note is played.

- Portamento may not produce a perfectly smooth slide with voices in which the driver characteristics affect pitch (brass instruments, for example).

### 14(10): Porta Sw

- Portamento Switch
- Settings: off, on



Turns portamento “on” or “off”. When “on” the portamento effect will produced as determined by the “13: Porta Mode” and “15: Porta Time” parameters.

- This parameter also selects the “single-trigger” or “multi-trigger” mode. Refer to “06(05): Mono/Poly” on page 80.

### 15(11): Porta Time

- Portamento Time
- Settings: 000 ... 127



The “Time” parameter sets the portamento time (i.e. the length of the slide between notes). A setting of “000” produces the fastest portamento time; “127” produces the longest portamento slide effect.

## Dry Level & Voice Name

### 16(12): Dry Level

- Dry Output Level
- Settings: 000 ... 127



Sets the output level of the VL70-m “dry” (i.e. without effects) sound. The higher the value the higher the dry output level. Increased dry levels produce a relative reduction in the perceived “depth” of any applied effects.

- This parameter display will not appear when the VARIATION EDIT mode “VarConnect” parameter is set to “INS” (Insertion Effect).

---

## 17: Voice Name (VOICE mode only)

- Voice Name
- Settings: A voice name of up to 8 characters.



To enter a voice name first select the “Voice Name” parameter and press the [ENTER] button. The current voice name will appear between square brackets on the display with the first character flashing (the flashing character is selected for editing). Use the VALUE [-] and [+] buttons to select a new character for the current edit location, as required, then use the SELECT [◀] and/or [▶] buttons to move to the next character to be edited, and repeat until done. When the voice name is complete press [EXIT] to return to the OTHERS edit mode.



### ● Character List

(space) ! " # \$ % & ' ( ) \* + , - . / 0 1 2 3 4 5 6 7  
8 9 : ; < = > ? @  
A B C D E F G H I J K L M N O P Q R S T U V W  
X Y Z [ ¥ ] ^ \_ `   
a b c d e f g h i j k l m n o p q r s t u v w x y z  
{ | } → ←

---

# The Store Function

Once you've created a new voice in the edit mode, it's necessary to store the voice to one of the VL70-m INTERNAL memory locations otherwise the edited data will be lost when a new voice is selected.

## ■ NOTES

- Any previous data in the memory location to which the new voice is stored will be erased. If you want to keep the previous data, save it to an external MIDI data storage device via the UTILITY mode DUMP OUT function (page 100).
- The STORE function is not available in the VL-XG sound module mode.

## Storing an Edited Voice

The STORE function mode can be accessed from the VOICE PLAY mode as follows:

### 1. Press [EDIT]

Press the [EDIT] button to go to the EDIT sub-mode menu.



### 2. Select the STORE Sub-mode

Use the SELECT [◀] and [▶] buttons to select the STORE sub-mode, if necessary. The icon to the left of “STORE” on the display will flash when the STORE sub-mode is selected.

### 3. Press [ENTER]

Press the [ENTER] button to go to the STORE function. “Store Voice” will appear at the top of the display along with the flashing number of the currently selected INTERNAL voice number.



### 4. Select a Destination Voice Number

Use the VALUE [-] and [+] buttons to select the number of the INTERNAL memory location you want to store the edited voice to (I01" through "I64").





**5. Press [ENTER] to Store**

Press the [ENTER] button to store the voice. "Executing" will appear on the display briefly while the data is being stored, then the VL70-m will return to the EDIT sub-mode menu. Press [EXIT] rather than [ENTER] if you want to abort the store operation.

# Effects & Effect Editing

The VL70-m features a versatile internal effects system which consists of four independent effect stages: REVERB, CHORUS, VARIATION, and DISTORTION. Of these the REVERB and CHORUS stages function as “system effects”, the VARIATION stage can be used either as a system or “insertion” effect, and the DISTORTION stage always functions as an insertion effect. See the signal-flow diagrams below for the different between “system” and “Insertion” effects.

## ■ NOTES

- When the VOICE sound module mode is selected (page 27) effect edits can be stored with each individual voice.

## Effect Signal Flow

The following diagrams should help you to understand how the VL70-m effect stages relate to overall signal flow.

### ● When the Variation Stage is an Insertion Effect

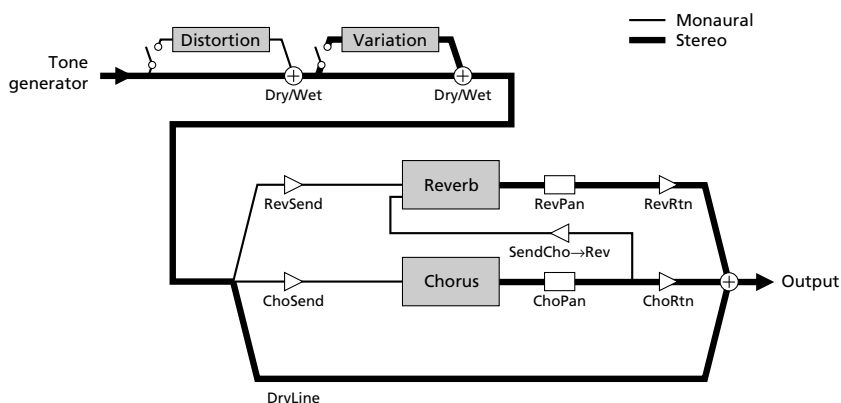

In this case the output from the tone generator is first sent to the distortion stage, and the distortion effect signal is then mixed back into the main signal line via the corresponding “Dry/Wet” parameter. Next is the variation stage, with the same “Dry/Wet” mixing capability. In this connection mode the distortion and variation stages are both functioning as insertion effects. After the insertion effects the signal can be sent to the reverb and chorus stages via the “RevSend” and “ChoSend” parameters available in the PLAY mode (pages 35 and 39). The output from both of these stages is stereo, and the effect signal can be mixed back in with the main signal line via the “RevRtn” and “ChoRtn”

parameters available in the PLAY mode (pages 32 and 41). The “SendCho→Rev” parameter (page 91) can be used to send some or all of the output from the chorus stage to the reverb stage. If the the “SendCho→Rev” parameter is set to maximum and the “ChoRtn” parameter is set to “000”, the chorus stage and reverb stage are effectively connected in series.

## ● When the Variation Stage is a System Effect

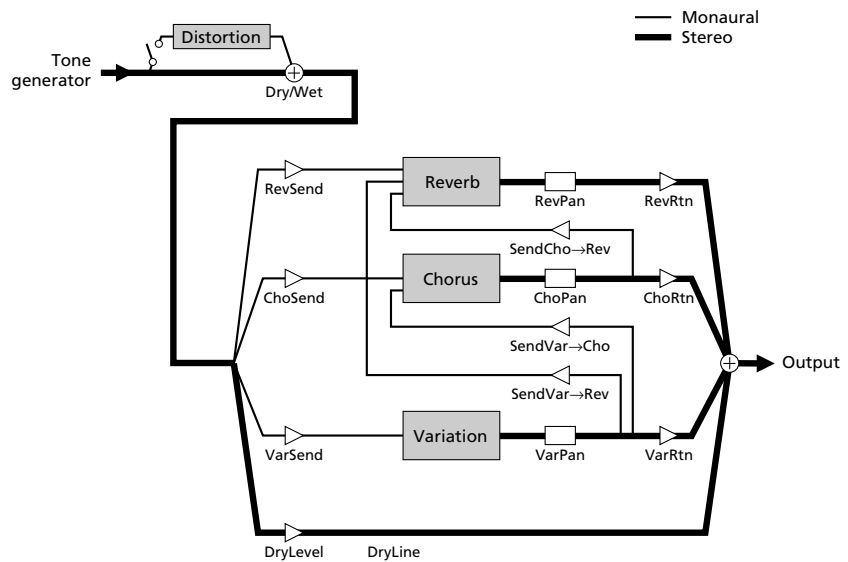

In this case the output from the tone generator is first sent to the distortion stage, and the distortion effect signal is then mixed back into the main signal line via the corresponding “Dry/Wet” parameter. In this connection mode only the distortion stage is functioning as an insertion effect. After the distortion stage the signal can be sent to the reverb, chorus and variation stages via the “RevSend”, “ChoSend”, and “VarSend” parameters available in the PLAY mode (pages 35 and 39). The output from all three of these stages is stereo, and the effect signal can be mixed back in with the main signal line via the “RevRtn”, “ChoRtn”, and “VarRtn” parameters available in the PLAY mode (pages 32, 33 and 41). The “SendCho→Rev” parameter (page 32) can be used to send some or all of the output from the chorus stage to the reverb stage. If the “SendCho→Rev” parameter is set to maximum and the “ChoRtn” parameter is set to “000”, the chorus stage and reverb stage are effectively connected in series. The “SendVar→Rev” and “SendVar→Cho” parameters (page 93) can be used to send some or all of the output from the variation stage to the reverb and chorus stages, respectively.

---

## Accessing & Editing the Effect Parameters

The EFFECT sub-modes — REV, CHO, VAR, and DIST — and the parameters they contain can be accessed from the PLAY mode as follows:

### 1. Press [EFFECT]

Press the [EFFECT] button to go to the EFFECT sub-mode menu.



### 2. Select the Desired Sub-mode

Use the SELECT [◀] and [▶] buttons to select the REV (reverb), CHO (chorus), VAR (variation), or DIST (distortion) sub-mode. The icon to the left of the name of the selected sub-mode will flash when the corresponding sub-mode is selected.

### 3. Press [ENTER]

Press the [ENTER] button to go to the selected sub-mode. “REVERB EDIT”, “CHORUS EDIT”, “VARIATION EDIT”, or “DISTORTAION EDIT” will appear at the top of the display, depending on the selected sub-mode.



### 4. Select a Parameter

Use the SELECT [◀] and [▶] buttons to select the parameter you want to edit (see the parameter descriptions, below). The name of the currently selected parameter and its current setting appear on the second line of the display. An arrow to the left and/or right of the parameter name/value indicates that the SELECT [◀] and/or [▶] buttons can be used to select more parameters in the indicated direction.



### 5. Edit the Selected Parameter

Use the VALUE [-] and [+] buttons to set the value of the selected parameter as required.

---

## 6. Repeat As Necessary

Repeat steps 4 and 5 to edit as many parameters as required.

## 7. Exit When Done

Press the [EXIT] button to return to the EFFECT sub-mode menu, or the [PLAY] button to return to the PLAY mode when you're finished editing.

### ■ **IMPORTANT!**

- *If you want to keep the changes you made in the VOICE EDIT mode, be sure to store the edited voice to an appropriate INTERNAL voice number before selecting a new voice. All edited data will be lost if you select a new voice before storing the edited voice!*

---

## The Reverb Parameters

The reverb effects are essential to give your sound ambience and a sense of dimension, adding warmth and depth to an otherwise dry sound.

### Type

- Reverb Type
- Settings: NO EFFECT, HALL 1, HALL 2, ROOM 1, ROOM 2, ROOM 3, STAGE 1, STAGE 2, PLATE, WHITE ROOM, TUNNEL, CANYON, BASEMENT



Selects the reverb type, or “NO EFFECT” if no reverb effect is required. Refer to the separate “List Book” for brief descriptions of each of the reverb types.

### Type-Specific Reverb Parameters

- See separate “List Book”



Each of the reverb types, selected via the “Type” parameter, above, has a different set of parameters that specify the actual reverb sound. Refer to the separate “List Book” for information on the individual parameters for each reverb type.

### Rev Pan

- Reverb Pan
- Settings: L63 ... C ... R63

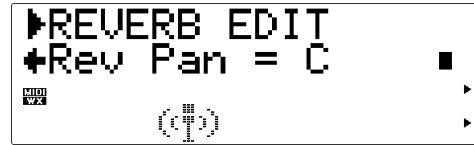

Sets the pan position of the reverb sound — i.e. the perceived position of the reverb sound within the stereo sound field. A setting of “L63” sets the reverb sound full left, “R63” sets the sound full right, and “C” places the sound in the center. Intermediate settings pan the reverb sound to corresponding positions in the stereo sound field.

---

## The Chorus Parameters

The VL70-m chorus stage actually includes a number of modulation-type effects that can be used to give your sound extra animation and life.

### Type

- Chorus Type
- Settings: NO EFFECT, CHORUS 1, CHORUS 2, CHORUS 3, CELESTE 1, CELESTE 2, CELESTE 3, FLANGER 1, FLANGER 2, SYMPHONIC, PHASER



Selects the chorus type, or “NO EFFECT” if no chorus effect is required. Refer to the separate “List Book” for brief descriptions of each of the chorus types.

### Type-Specific Chorus Parameters

- See separate “List Book”

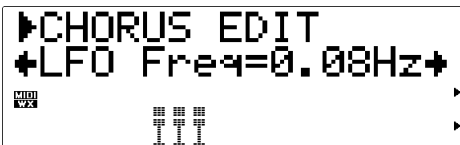

Each of the chorus types, selected via the “Type” parameter, above, has a different set of parameters that specify the actual chorus sound. Refer to the separate “List Book” for information on the individual parameters for each chorus type.

### Cho Pan

- Chorus Pan
- Settings: L63 ... C ... R63

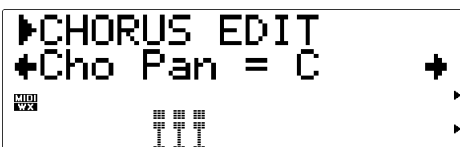

Sets the pan position of the chorus sound — i.e. the perceived position of the chorus sound within the stereo sound field. A setting of “L63” sets the chorus sound full left, “R63” sets the sound full

right, and “C” places the sound in the center. Intermediate settings pan the chorus sound to corresponding positions in the stereo sound field.

### SendCho→Rev

- Chorus-to-Reverb Send Level
- Settings: 000 ... 127



Sets the amount of signal sent from the output of the chorus effect stage back to the input of the reverb effect stage (see diagram on pages 86 and 87). The higher the value, the more chorus signal is sent to the reverb stage. If this parameter and the PLAY mode “ChoRtn” parameter are both set to values higher than “001”, the output of the chorus stage will be sent in corresponding amounts to the input of the reverb stage and the main outputs.

---

## The Variation Parameters

The variation stage includes reverb, delay, echo, modulation, distortion, wah, and a range of other effects.

### Type

- Variation Type
- Settings: NO EFFECT, HALL 1, HALL 2, ROOM 1, ROOM 2, ROOM 3, STAGE 1, STAGE 2, PLATE, DELAY LCR, DELAY L,R, ECHO, CROSSDELAY, ER1, ER2, GATE REV, REVRS GATE, KARAOKE 1, KARAOKE 2, KARAOKE 3, CHORUS 1, CHORUS 2, CHORUS 3, CELESTE 1, CELESTE 2, CELESTE 3, FLANGER 1, FLANGER 2, SYMPHONIC, ROTARY SP, TREMOLO, AUTO PAN, PHASER, DISTORTION, OVERDRIVE, AMP SIM, 3-BAND EQ, 2-BAND EQ, AUTO WAH, PITCH CHNG, AURAL EXCT\*, TOUCH WAH, WAH+DIST, COMPRESSOR, NOISE GATE, THRU



Selects the variation type, or “NO EFFECT” if no variation effect is required. Refer to the separate “List Book” for brief descriptions of each of the variation types.

- \* Aural Exciter® is a registered trademark of and is manufactured under license from Aphex Systems Ltd.

### Type-Specific Variation Parameters

- See separate “List Book”

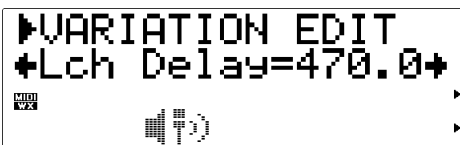

Each of the variation types, selected via the “Type” parameter, above, has a different set of parameters that specify the actual variation effect sound. Refer to the separate “List Book” for information on the individual parameters for each variation type.

### AT VarCtrl

- Aftertouch Variation Control
- Settings: -64 ... +63

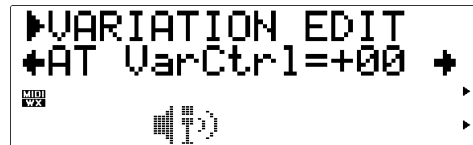

This parameter only becomes available when the “VarConnect” parameter (page 93) is set to “INS” (i.e. when the variation stage is connected as an insertion effect). Aftertouch variation control allows one of the selected variation effect parameters to be controlled in real time via keyboard aftertouch pressure. The parameter which can be controlled is individually preset for each variation effect type (see the separate “List Book”). The “AT VarCtrl” parameter determines to what degree the effect parameter is affected by aftertouch pressure. For example, if the TREMOLO effect is selected aftertouch controls the “LFO Frequency” parameter. In this case higher positive “AT VarCtrl” values cause increased aftertouch pressure to increase the LFO speed, while higher negative values cause increased aftertouch pressure to decrease the LFO speed. If this parameter is set to “+00” aftertouch control has no effect.

### AC1VarCtrl

- Assignable Controller 1 Variation Control
- Settings: -64 ... +63



This parameter only becomes available when the “VarConnect” parameter (page 93) is set to “INS” (i.e. when the variation stage is connected as an insertion effect). Assignable Controller variation



control allows one of the selected variation effect parameters to be controlled in real time via assignable controller 1 (page 54). The parameter which can be controlled is individually preset for each variation effect type (see the separate “List Book”). The “AC1VarCtrl” parameter determines to what degree the effect parameter is affected by the controller. For example, if the TREMOLO effect is selected the controller affects the “LFO Frequency” parameter. In this case higher positive “AC1VarCtrl” values cause increased controller settings to increase the LFO speed, while higher negative values cause increased controller settings to decrease the LFO speed. If this parameter is set to “+00” assignable controller 1 has no effect.

### Var Pan

- Variation Pan
- Settings: L63 ... C ... R63

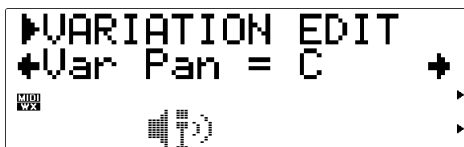

Sets the pan position of the variation effect sound — i.e. the perceived position of the variation effect sound within the stereo sound field. A setting of “L63” sets the variation sound full left, “R63” sets the sound full right, and “C” places the sound in the center. Intermediate settings pan the variation effect sound to corresponding positions in the stereo sound field. This parameter becomes available when the “VarConnect” parameter is set to “SYS” (i.e. when the variation stage is connected as a system effect.)

### SendVar→Cho

- Variation-to-Chorus Send Level
- Settings: 000 ... 127



Sets the amount of signal sent from the output of the variation effect stage back to the input of the chorus effect stage (see diagram on page 87). The

higher the value, the more variation signal is sent to the chorus stage. If this parameter and the PLAY mode “VarRtn” parameter are both set to values higher than “001”, the output of the variation stage will be sent in corresponding amounts to the input of the chorus stage and the main outputs. This parameter becomes available when the “VarConnect” parameter is set to “SYS” (i.e. when the variation stage is connected as a system effect.)

### SendVar→Rev

- Variation-to-Reverb Send Level
- Settings: 000 ... 127



Sets the amount of signal sent from the output of the variation effect stage back to the input of the reverb effect stage (see diagram on page 87). The higher the value, the more variation signal is sent to the reverb stage. If this parameter and the PLAY mode “VarRtn” parameter are both set to values higher than “001”, the output of the variation stage will be sent in corresponding amounts to the input of the reverb stage and the main outputs. This parameter becomes available when the “VarConnect” parameter is set to “SYS” (i.e. when the variation stage is connected as a system effect.)

### VarConnect

- Variation Connection Mode
- Settings: INS, SYS



Determines whether the variation effects stage functions as an insertion effect (“INS”) or as a system effect (“SYS”). See the diagrams and explanations on pages 86 and 87 for the difference between these connection modes.

---

## The Distortion Parameters

Distortion is an excellent way to drastically change a sound — although subtle distortion settings can produce surprisingly delicate variations.

### Type

- Distortion Type
- Settings: THRU, DISTORTION, OVERDRIVE, 3-BAND EQ



Selects the distortion type, or “THRU” if no distortion effect is required. Refer to the separate “List Book” for brief descriptions of each of the distortion types.

### Type-Specific Distortion Parameters

- See separate “List Book”



Each of the distortion types, selected via the “Type” parameter, above, has a different set of parameters that specify the actual distortion sound. Refer to the separate “List Book” for information on the individual parameters for each distortion type.

### AT DstCtrl

- Aftertouch Distortion Control
- Settings: -64 ... +63



Aftertouch distortion control allows one of the selected distortion effect parameters to be controlled in real time via keyboard aftertouch pressure. The parameter which can be controlled is individually preset for each distortion effect type (see the separate “List Book”). The “AT DstCtrl” parameter determines to what degree the effect parameter is affected by aftertouch pressure. For

example, if the OVERDRIVE effect is selected aftertouch controls the “Drive” parameter. In this case higher positive “AT DstCtrl” values cause increased aftertouch pressure to increase the amount of drive, while higher negative values cause increased aftertouch pressure to decrease the amount of drive. If this parameter is set to “+00” aftertouch control has no effect.

### AC1DstCtrl

- Assignable Controller 1 Distortion Control
- Settings: -64 ... +63



Assignable Controller variation control allows one of the selected distortion effect parameters to be controlled in real time via assignable controller 1 (page 54). The parameter which can be controlled is individually preset for each distortion effect type (see the separate “List Book”). The “AC1DstCtrl” parameter determines to what degree the effect parameter is affected by the controller. For example, if the OVERDRIVE effect is selected the controller affects the “Drive” parameter. In this case higher positive “AC1DstCtrl” values cause increased controller settings to increase the amount of drive, while higher negative values cause increased controller settings to decrease the amount of drive. If this parameter is set to “+00” assignable controller 1 has no effect.

### Dist Part

- Distortion Part
- Settings: off, on



Turns the distortion effect stage “on” or “off”.

---

# Breath Settings

The Breath Setting includes a number of setting that determine how the VL70-m responds to breath control from a breath controller, a Yamaha WX-series Wind MIDI controller, or MIDI.

## Accessing & Editing the Breath Parameters

The BREATH parameters can be accessed and edited from the PLAY mode as follows:

### 1. Press [BREATH]

Press the [BREATH] button to go to the Breath Setting.



### 2. Select a Parameter

Use the SELECT [◀] and [▶] buttons to select the parameter you want to edit (see “The Breath Parameters”, below). The name of the currently selected parameter and its current setting will appear on the top line of the display while the parameter’s current setting appears on the second line. An arrow to the left and/or right of the parameter name indicates that the SELECT [◀] and/or [▶] buttons can be used to select more parameters in the indicated direction.



### 3. Edit the Selected Parameter

Use the VALUE [-] and [+] buttons to set the value of the selected parameter as required.

### 4. Repeat As Necessary

Repeat steps 2 and 3 to edit as many parameters as required.

### 5. Exit When Done

Press the [EXIT] or [PLAY] button to return to the PLAY mode when you’re finished editing.

---

# The Breath Parameters

## Breath Mode

- Settings: BC/WX, Velocity, Touch EG



Sets the control source to be used for “breath” control. This parameter should be set to “BC/WX” when a breath controller or Yamaha WX-series Wind MIDI Controller is being used (page 18). When set to “Velocity”, breath variation is controlled by keyboard initial touch response. When “Touch EG” is selected breath variation is controlled by a combination if initial keyboard touch response and aftertouch pressure. Initial key velocity sets the initial breath level, then aftertouch pressure determines the shape of the subsequent breath envelope.

- The icon of the “Breath Mode”, “Breath Control” and “Breath Setting Lock” parameters indicates which “Breath Mode” parameter setting is selected.

## Breath Control

- Settings: BC, Exp



Specifies the MIDI control change number to be used for breath control when breath control is applied from a breath controller, WX-series Wind MIDI Controller, or via the VL70-m MIDI IN connector. When “BC” is selected control change number “02” (breath control) is used for breath control. When “Exp” is selected control change number “11” (expression) is used for breath control. This setting also affects both MIDI and HOST output from the VL70-m.

## Breath Curve

- Settings: -16 ... +16

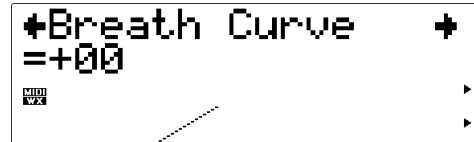

Determines the relationship between breath control data received from a breath controller, WX-series Wind MIDI Controller, or via the MIDI IN connector, and the actual amount of breath variation applied. Minus settings result in a large breath variation with a relatively small amount of breath pressure applied to the controller, while plus settings required a greater range of input breath control values to produce the same degree of breath variation. The graph at the bottom of the display represents this relationship: the horizontal axis is input breath pressure and the vertical axis is actual breath variation.

## Breath Setting Lock

- off, on



When this parameters is “off” the VL70-m “Breath Mode” parameter (above) will be automatically set to “BC/WX” whenever a MIDI “XG SYSTEM ON” or “VOICE MODE ON” message is received. At the same the “Breath Control” parameter (above) is set to “BC” and the “Breath Curve” parameter (also above) is set to +00”. Turn this parameter “on” if you do not want received MIDI messages to affect the breath setting parameters.

---

# The Utility Mode

The UTILITY mode provides access to a range of parameters that affect basic operation of the VL70-m, and some functions that contribute to system flexibility. Select the UTILITY sub-mode menu from the PLAY mode by pressing the [UTILITY] button. Four sub-modes are available:

<b>SYSTEM</b>	The SYSTEM sub-mode includes parameters that affect overall operation of the VL70-m. Page 98.
<b>DUMPOUT</b>	The Dump Out function allows VL70-m setup and system exclusive data to be transmitted to a second VL70-m or an external MIDI storage device such as the Yamaha MDF2 MIDI Data Filer via the MIDI OUT or TO HOST connector. Page 100.
<b>INITIAL</b>	The VL70-m Initialize function includes two sub-modes — “Factory Set” and “System Initialize”. “Factory Set” initialization restores all VL70-m data to the initial factory settings ... including all Custom and Internal voices. “System Initialize” restores all system setup parameters (page 98) to their default settings. Page 102.
<b>DEMO</b>	A “demonstration” function demonstrates some of the VL70-m voices and capabilities. The DEMO function is described in detail on page 24.

---

## The System Parameters

The UTILITY SYSTEM sub-mode includes parameters that affect overall operation of the VL70-m.

### M. Tune

- Master Tuning
- Settings: -102.4c ... +102.3c

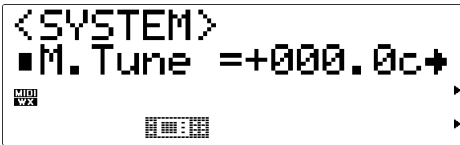

Fine tunes the overall pitch of the VL70-m in 0.1-cent steps (a “cent” is 1/100th of a semitone). The maximum minus and plus settings produce a downward or upward pitch shift of just over a semitone. A setting of “+000.0” produces no pitch change.

### RcvSysExcl

- System Exclusive Receive
- Settings: off, on

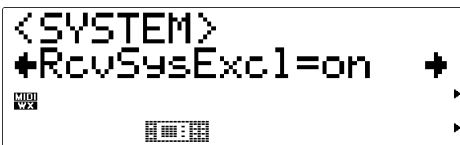

This parameter determines whether or not the VL70-m will receive MIDI system exclusive messages. System exclusive data is received when this parameter is “on”, and ignored when this parameter is “off”.

### TransmitCH

- MIDI Transmit Channel
- Settings: 1 ... 16



Selects the MIDI channel via which data corresponding to operation of a breath controller connected to the VL70-m will be transmitted.

### WX Lip

- WX Lip Mode
- Settings: Norm, Expd

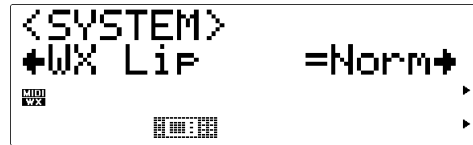

WX-series Wind MIDI Controllers produce pitch bend data ranging from “-16” to “+32” in response to lip (reed) pressure. The “WX Lip” parameter determines whether these values are used as is (“Norm”), or expanded to a full “-64” through “+63” range (“Expd”). When the “Expd” mode is selected, the expanded pitch bend data is also transmitted via the MIDI OUT and TO HOST connector. The “Expd” setting is recommended when using a WX controller in the “tight lip” mode. The “Norm” setting is recommended when using the WX controller “loose lip” mode.

### WX LipLock

- WX Lip Lock
- Settings: off, on

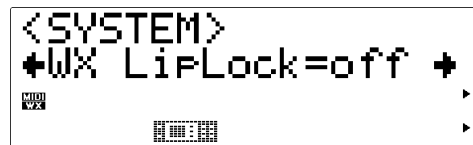

When this parameters is “off” the VL70-m “WX Lip” parameter (above) will be automatically set to “Norm” whenever a MIDI “XG SYSTEM ON” or “VOICE MODE ON” message is received. Turn this parameter “on” if you do not want received MIDI messages to affect the “WX Lip” setting.

---

## Contrast

- Display Contrast
- Settings: 1 ... 8

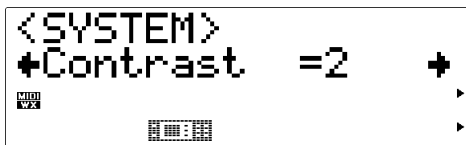

Sets the contrast of the VL70-m display for optimum visibility. The best setting will depend on your viewing angle and the ambient lighting conditions. A setting of “1” produces the strongest contrast, while a setting of “8” produces the “softest” contrast.

## DumpIntrval

- MIDI Bulk Dump Interval
- Settings: 50, 100, 150, 200, 300



Sets the length of time intervals to be inserted between data blocks during a “Dump Out” operation (page 100). The required interval will depend on the receiving MIDI device. The settings are in milliseconds: i.e. 50 milliseconds, 100 milliseconds, etc. Try adjusting this parameter if the receiving MIDI device generates an error message while receiving a bulk dump from the VL70-m.

## NoteFilter

- MIDI Note Filter
- Settings: ch01 ... ch16, Thru



This parameter can be used to prevent MIDI note on/off messages received on the specified channel from being re-transmitted via the MIDI OUT connector. Select the channel to be filtered out, or “Thru” to allow all data to pass.

- When the VL-XG sound module mode is selected and a program change number corresponding to a VL70-m voice is received, the “NoteFilter” parameter is automatically set to the channel on which the program change number was received. This does not occur in the VOICE sound module mode.
- When the VL70-m MIDI receive channel is changed via the panel controls (pages 34 and 38), the “NoteFilter” parameter is automatically set to the same channel if it is initially set to 01 ... 16, but not when it is set to “Thru”. This does not occur when the MIDI receive channel is changed via a MIDI system exclusive message.

---

## The Dump Out Function

The Dump Out function allows VL70-m setup and system exclusive data to be transmitted to a second VL70-m or an external MIDI storage device such as the Yamaha MDF2 MIDI Data Filer via the MID OUT or TO HOST connector.

### ■ NOTES

- The MIDI Device Number of the receiving device must be the same as that set via the VL70-m PLAY mode "DevNo." parameter (pages 32 and 41).
- You might have to try a few different DumpIntrval parameter (page 99) settings before the receiving device will receive the data from the VL70-m without errors.

### ● DUMPOUT Operation

When the DUMPOUT sub-mode is selected from the UTILITY mode menu, a second menu appears which allows you to choose the type of data to be transmitted: SYSTEM, CURRENT, CUSTOM, or INTERNAL. From this menu:



#### 1. Select a Data Type

Use the SELECT [◀] and [▶] buttons to select SYSTEM, CURRENT, CUSTOM, or INTERNAL. The icon to the left of the name of the selected data type will flash when selected.

<b>SYSTEM</b>	All "system" data, including system setup and breath setting data.
<b>CURRENT</b>	Transmits the currently selected voice (i.e. the voice that was selected immediately prior to engaging the UTILITY mode).
<b>CUSTOM</b>	Transmits all 6 CUSTOM bank voices, or a single specified CUSTOM bank voice. When "ALL" is selected all 6 CUSTOM voices are transmitted, and when "C1" through "C6" is selected the corresponding single CUSTOM voice is transmitted.
<b>INTERNAL</b>	Transmits all 64 INTERNAL bank voices, or a single specified INTERNAL bank voice. When "ALL" is selected all 64 INTERNAL voices are transmitted, and when "I01" through "I64" is selected the corresponding single INTERNAL voice is transmitted.



---

**2. Press [ENTER]**

Press the [ENTER] button to go to the confirmation/select display for the selected data type.



**3. Select "ALL" or a Single Voice for CUSTOM or INTERNAL**

If you have selected the CUSTOM or INTERNAL data type, you can use the VALUE [-] and [+] buttons at this point to specify whether you want to transmit "ALL" voices from the CUSTOM or INTERNAL bank, or a single voice: when the CUSTOM data type is specified select "C1" through C6, or when the INTRNL data type is specified select "I01" through "I64".



**4. Press [ENTER] to Dump**

Press the [ENTER] button to begin actual data transmission (or [EXIT] to abort). "Transmitting" will appear on the display while the data is being transmitted, then the display will return to the data type menu.

**5. Exit When Done**

Press the [EXIT] button to return to the UTILITY mode menu, or [PLAY] to return directly to the PLAY mode when done.

---

## The Initialize Function

The VL70-m Initialize function includes two sub-modes — “Factory Set” and “System Initialize”. “Factory Set” initialization restores all VL70-m data to the initial factory settings ... including all Custom and Internal voices. “System Initialize” restores all system setup parameters (page 98) to their default settings.

### 1. Select an Initialize Sub-mode

Use the SELECT [◀] and [▶] buttons to select Factory Set or System Initialize.



### 2. Press [ENTER]

Press the [ENTER] button to go to the confirmation display for the selected sub-mode.



### 3. Press [ENTER] to Initialize

Press the [ENTER] button to begin actual initialization (or [EXIT] to abort). “Executing” will appear on the display while the data is being initialized, then the display will return to the Initialize sub-mode menu.

### 4. Exit When Done

Press the [EXIT] button to return to the UTILITY mode menu, or [PLAY] to return directly to the PLAY mode when done.

# Appendix

## Show Control Change

This function displays the MIDI control change data string required to control the parameter currently displayed in the PLAY mode from an external MIDI device. The MIDI data is displayed in hexadecimal format.

To engage the Show Control Change function first select the desired parameter in the PLAY mode, then “double click” the [ENTER] button (i.e. press the [ENTER] button twice in rapid succession). The Show Control Change display will appear.

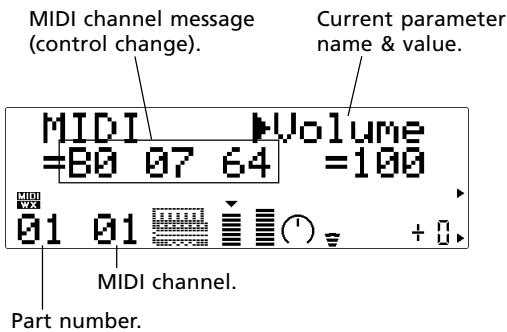

Depending on the selected parameter, system exclusive data may be displayed in place of control change data. This variation is described in the next section: “The Show Exclusive Function”.

While the Show Control Change function is engaged the VALUE [-] and [+] buttons can be used to change values, and the SELECT [◀] and [▶] buttons can be used to select different parameters.

Press the [EXIT] button to return to the previous display.

## Show Exclusive

This function displays the MIDI system exclusive data string required to control the currently-displayed parameter from an external MIDI device. The MIDI data is displayed in hexadecimal format.

To engage the Show Exclusive function first select the desired parameter, then “double click” the [ENTER] button (i.e. press the [ENTER] button twice in rapid succession). The Show Exclusive display will appear.



Depending on the selected parameter, control change data may be displayed in place of system exclusive data. This variation is described in the preceding section: “The Show Control Change Function”.

While the Show Exclusive function is engaged the VALUE [-] and [+] buttons can be used to change values, and the SELECT [◀] and [▶] buttons can be used to select different parameters.

Press the [EXIT] button to return to the previous display.

With the VL70-m it is possible to control just about any parameter via MIDI system exclusive messages from an external MIDI device. This makes it possible, for example, to change filter or EG settings while playing, to change the sound as required. You could also change effect settings, the pitch of individual drum instruments, or just about any other parameter to add life and variety to your music. Until now, however, the process of using this capability has been rather tedious: find the required parameter in the MIDI documentation, figure out what data string is required to perform the desired operation, and so on. The VL70-m Show Exclusive function shows the required data string for the selected parameter immediately.

## The Message Window

The VL70-m Message Window function makes it possible to display text messages up to 32 characters in length on the VL70-m display in the PLAY mode. The messages can be transmitted in the form of a data string from an external MIDI device, and will appear on the VL70-m display for about 3 seconds. A message could be placed at the beginning of a song data file, for example, so that the title of the song and other information appears on the display at the beginning of the song.

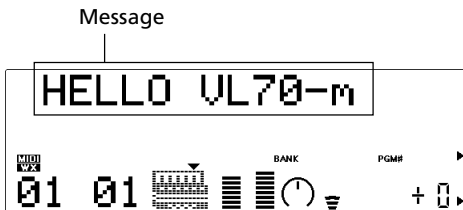

## Message Window Data Format

The format for message window data is as follows (hexadecimal format):

**F0 43 1n 4C 06 00 00 xx xx .... xx xx F7**

“n” is the device number minus one. If the VL70-m device number is set to “1”, for example, “n” should be “0”.

“xx xx .... xx xx” is the text data. Each character is represented by a single ASCII -code byte (2 hexadecimal digits). Refer to the chart below for the ASCII code for each displayable character. The numbers in the top row are the first digit and the numbers in the leftmost column are the second digit in the byte representing each character. The capital letter “A”, for example, is represented by hexadecimal byte “41”.

	0	1	2	3	4	5	6	7
0		(space)	0	@	P	`	p	
1		!	1	A	Q	a	q	
2		"	2	B	R	b	r	
3		#	3	C	S	c	s	
4		\$	4	D	T	d	t	
5		%	5	E	U	e	u	
6		&	6	F	V	f	v	
7		'	7	G	W	g	w	
8		(	8	H	X	h	x	
9		)	9	I	Y	i	y	
A		*	:	J	Z	j	z	
B		+	;	K	[	k	{	
C		,	<	L	¥	l	!	
D		-	=	M	]	m	}	
E		.	>	N	^	n	-	
F		/	?	O	_	o		

The message “HELLO VL70-m” would be displayed by transmitting the following data string to the VL70-m:

**F0 43 1n 4C 06 00 00 48 45 4C 4C 4F 20 56 4C 37 30 2D 6D F7**  
 H E L L O V L 7 0 - m

# Bitmap Window

The VL70-m Bitmap Window function makes it possible to display 16 x 16 dot icons and simple animation sequences on the VL70-m display in the PLAY mode. The bitmap data can be transmitted in the form of a data string from an external MIDI device, and will appear on the VL70-m display for about 3 seconds.

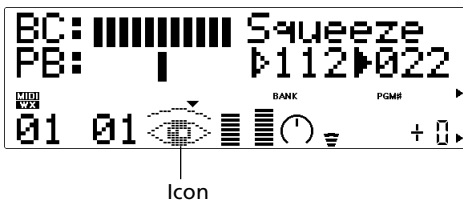

## Bitmap Window Data Format

The format for message window data is as follows (hexadecimal format):

**F0 43 1n 4C 07 00 00 xx xx .... xx xx F7**

“n” is the device number minus one. If the VL70-m device number is set to “1”, for example, “n” should be “0”.

“xx xx .... xx xx” is the bitmap data consisting of a string of 48 2-digit hexadecimal bytes.

## Creating Bitmap Data

- Block out the desired design on a 16 x 16 grid, as shown in the example below.

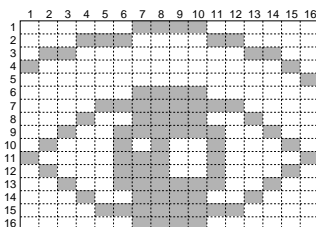

- Filled squares will be represented by ones, and empty squares by zeroes.

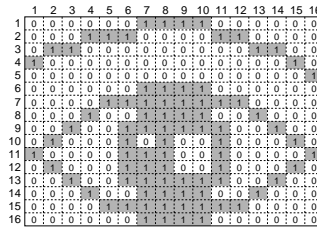

- Divide the design horizontally into three sections: two seven-columns and one two-columns in width. Add one column of squares the left of each section, and 5 columns to the right of the 2-column section, as shown in the example below. You now have 48 rows, each 8 columns in width.

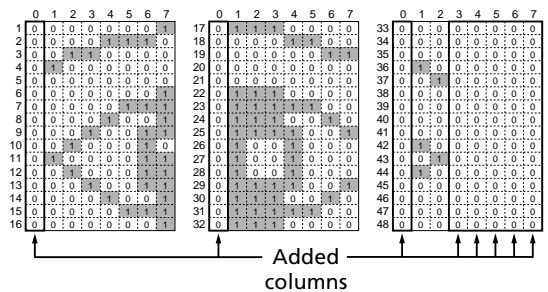

- Use the chart below to convert the ones and zeroes in each row from binary format to hexadecimal format. The “bits” in columns 0 through 3 become the first digit, and the bits in columns 4 through 7 become the second digit of each hexadecimal byte.

For example, the 11th row in the design can therefore be represented by hexadecimal byte “43”.

binary format	hexadecimal format	binary format	hexadecimal format
0000	0	1000	8
0001	1	1001	9
0010	2	1010	A
0011	3	1011	B
0100	4	1100	C
0101	5	1101	D
0110	6	1110	E
0111	7	1111	F

After converting all 48 rows in the example we have the following hexadecimal bytes:

```
01 0E 30 40 00 01 07 09 13 22 43 23 13 09 07 01
70 0C 03 00 00 70 7C 72 79 48 48 48 79 72 7C 70
00 00 00 40 20 00 00 00 00 40 20 40 00 00 00 00
```

5. Plug the data derived from the bitmap design into the “xx xx .... xx xx” portion of the bitmap window data format, and you have the data stream required to display the design on the VL70-m display.

## Checksum

Some VL70-m system exclusive message require a “checksum” — a data byte which is used to check for errors during MIDI data transfer. The checksum is calculated using the system exclusive message start address and data (data size). A method of calculating the checksum is given below, using a simple data format as an example.

1. Convert the hexadecimal start address and data bytes (underlined in the example) to decimal format using the chart below. Each two-digit hexadecimal byte becomes a decimal number.
- “mm”, the Model ID, is “57” when the VOICE sound module mode is selected, and “4C” when the VL-XG sound module mode is selected.

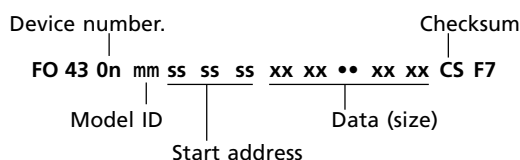

HEX	DEC	HEX	DEC	HEX	DEC	HEX	DEC
00	0	10	16	20	32	30	48
01	1	11	17	21	33	31	49
02	2	12	18	22	34	32	50
03	3	13	19	23	35	33	51
04	4	14	20	24	36	34	52
05	5	15	21	25	37	35	53
06	6	16	22	26	38	36	54
07	7	17	23	27	39	37	55
08	8	18	24	28	40	38	56
09	9	19	25	29	41	39	57
0A	10	1A	26	2A	42	3A	58
0B	11	1B	27	2B	43	3B	59
0C	12	1C	28	2C	44	3C	60
0D	13	1D	29	2D	45	3D	61
0E	14	1E	30	2E	46	3E	62
0F	15	1F	31	2F	47	3F	63

2. Add all the converted numbers.
3. Divide the total by 128 and note the remainder.
4. Subtract the remainder from 128. The result is the checksum.
5. Convert the decimal checksum back to hexadecimal format using the above chart.

## Troubleshooting

The VL70-m is a very versatile tone generator with many features and functions that affect operation. In many cases, what appears to be a fault with the VL70-m can actually be traced to an improperly set parameter or something as simple as a bad connection.

Here's how to determine if the problem is internal (e.g. parameter settings) or external (e.g. connections, amplifier, etc.):

- Listen via headphones. Plug a pair of headphones into the VL70-m and play. If the headphone sound is OK, then the problem is most likely in the amplifier or mixer you are using, or the audio connection cables.
- Try adjusting all operational controllers — modulation wheels, foot controllers, etc. In some cases extreme controller settings can cause unexpected sound or pitch ... or even no sound at all.
- Try selecting different voices. If the problem occurs only on one voice then the voice parameters are most likely at fault. If the problem occurs on all voices then a utility parameter should be suspected.

The following are some common problems and probable causes:

### Symptom

- No power.

### Possible Causes

- Is the AC adaptor properly connected to both the VL70-m and an AC wall outlet (page 15)?
- If the AC adaptor is connected to a switched AC outlet on another piece of equipment (an amplifier, for example) is that device switched on?

HEX	DEC	HEX	DEC	HEX	DEC	HEX	DEC
40	64	50	80	60	96	70	112
41	65	51	81	61	97	71	113
42	66	52	82	62	98	72	114
43	67	53	83	63	99	73	115
44	68	54	84	64	100	74	116
45	69	55	85	65	101	75	117
46	70	56	86	66	102	76	118
47	71	57	87	67	103	77	119
48	72	58	88	68	104	78	120
49	73	59	89	69	105	79	121
4A	74	5A	90	6A	106	7A	122
4B	75	5B	91	6B	107	7B	123
4C	76	5C	92	6C	108	7C	124
4D	77	5D	93	6D	109	7D	125
4E	78	5E	94	6E	110	7E	126
4F	79	5F	95	6F	111	7F	127

---

### Symptom

- No sound.

### Possible Causes

- Is the amplifier/mixer power turned on?
- Is the amplifier/mixer volume set to an appropriate level?
- Is the VL70-m volume control set to an appropriate level?
- Are the VL70-m outputs properly connected to the amplifier/mixer inputs?
- Are the connection cables shorted, open, or otherwise faulty?
- Is the HOST SELECT switch set appropriately for your system (page 20)?
- Is the echo back (or MIDI THRU) function on your computer or sequencer set properly?
- Is the VL70-m MIDI receive channel set properly (pages 34 and 38)?
- Is the PLAY mode Volume parameter set properly (pages 32 and 38)?
- Is the PLAY mode Master Volume parameter set properly (page 41)?
- Is the PLAY mode Expression parameter set properly (page 38)?
- Are the filter and EG attack times set to unusually long values (page 72)?
- Are the high and low note limit parameters in the “Others” edit mode set to appropriate values (page 81)?
- Is the Voice Level parameter in the “Others” edit mode set to an appropriate value (page 79)?
- Is the Breath Mode parameter set properly (page 96)?
- If a WX-series Wind MIDI Controller is unplugged from the VL70-m while no breath is applied to the controller, the breath value can get “stuck” at “0”, resulting in no sound output.

### Symptom

- Volume too low.

### Possible Causes

- Is the PLAY mode Volume parameter set properly (pages 32 and 38)?
- Is the PLAY mode Expression parameter set properly (page 38)?

- Is the PLAY mode Master Volume parameter set properly (page 41)?
- Is the Voice Level parameter in the “Others” edit mode set to an appropriate value (page 79)?
- Are the “Others” edit mode Velocity Depth and Velocity Offset parameters set to appropriate values (page 81)?

### Symptom

- Distorted sound.

### Possible Causes

- Is the VL70-m connected to a high-sensitivity microphone or instrument input on your amplifier or mixer? Try turning the VL70-m DOWN controls down to avoid overloading the amplifier/mixer inputs.
- Is a distortion-type effect being used (page 94)?

### Symptom

- Wrong pitch.

### Possible Causes

- Is the master tune parameter set properly (page 98)?
- Is the transpose or system transpose parameter set properly (pages 33 and 41)?
- Is the note shift parameter set properly (page 35)?
- Is the “Others” edit mode Detune parameter set properly (page 79)?
- Are inappropriate RPN Fine Tune or RPN Coarse Tune MIDI message being received from an external MIDI device?

### Symptom

- Can only play one note at a time (i.e. no polyphony).

### Possible Causes

- The VL70-m is a monophonic tone generator which is capable of producing only one note at a time.



---

**Symptom**

- No effects.

**Possible Causes**

- Are the effect send levels set properly (pages 35 and 39)?
- Are the effect return levels set properly (pages 32, 33 and 41)?
- Is “NO EFFECT” or “THRU” selected as the effect type (pages 90 – 92 and 94)?
- If distortion is being used, is the distortion part turned “off” (page 94)?

**Symptom**

- A connected breath controller has no effect.

**Possible Causes**

- Is the Breath Mode parameter set properly (page 96)?
- Is the breath control number set properly (page 96)?
- Are the parameters to be controlled by the breath controller set properly (page 48)?
- If the VL70-m is connected to a computer via the TO HOST connector, is the computer “echo back” function set properly (page 20)?
- Is the receive channel parameter set properly (pages 34 and 38)?

**Symptom**

- A connected WX-series controller has no effect.

**Possible Causes**

- If the VL70-m is connected to a computer via the TO HOST connector, make sure that the “WX” is selected via the [MIDI/WX] button (page 18).
- If the VL70-m is connected to a computer via the TO HOST connector, is the computer “echo back” function set properly (page 20)?
- Is the Breath Mode parameter set properly (page 96)?
- Is the breath control number set properly (page 96)?
- Are the parameters to be controlled by breath data from the WX-series controller set properly (page 48)?
- Is the receive channel parameter set properly (pages 34 and 38)?

**Symptom**

- Cannot receive MIDI bulk data.

**Possible Causes**

- Is the Receive System Exclusive parameter turned “on” (page 98)?
- Is the Device Number parameter set properly (pages 32 and 41)?

**Symptom**

- Song data is not played properly.

**Possible Causes**

- Is the WX Lip Lock parameter set properly (page 98)?
- Is the Breath Setting Lock parameter set properly (page 96)?
- In some cases song data which has not been specifically created for playback via the VL70-m, or song data which does not bear the “VL Extension for XG” logo, will not play back properly on the VL70-m.

---

## Answers to Some Common Questions

- 1. The VL70-m is a monophonic tone generator. Why is the “poly” mode initially selected when the VL-XG sound module mode is engaged?**

This is to provide compatibility between the current XG format and future polyphonic VL-series tone generators. It also provides a certain degree of compatibility to allow playback of VL-XG song data on existing tone generators which do not feature the VL-XG extension. Specifically, to switch the VL70-m to the mono mode a “mono mode” command (control change no.126, value 0-16) is embedded in the song data which, when received by a 32-note or 64-note polyphonic XG tone generator, switches the appropriate parts to the mono mode. The same will apply to future polyphonic VL-series tone generators, so no changes will be required. The VL70-m therefore has a “poly” which is automatically selected when a MIDI “XG on” system exclusive message is received.

- 2. Can the Treble and Bass parameters be edit during performance or playback?**

In fact, they are a valuable expressive tool. Although the Treble and Bass parameters are basically similar in effect to the corresponding controls on an amplifier, for example, their actual effect varies slightly from voice to voice. In many cases they also affect the critical mid-frequency range, making it possible to give a voice extra “presence”, as required. The Bass parameter, in particular, can be used to bring a voice “forward” in an ensemble.

- 3. Why do some voices sound as if they are in the original octave even when shifted down an octave?**

This is because Virtual Acoustic synthesis accurately simulates the acoustic behaviour of a

pipe or string. Simply stated, the harmonic balance of the voice when played in the normal octave is retained even when the voice is shifted down an octave. The change in timbre can be greater or less, depending on the selected voice.

- 4. Why does portamento produce more of a glissando effect on some voices?**

Trumpets and some other brass instruments tend to exhibit this phenomenon more than others. In a S/VA tone generator portamento is produced by lengthening or shortening the instrument’s pipe or string and changing the Embouchure. A trumpet is designed to emphasize the “modes” of the pipe(s) to produce notes over a wide range using only three valves. When portamento is applied to a trumpet voice, the pitch tends to jump from mode to mode, thus producing the observed glissando effect. The same effect occurs with some flute voices. Saxophone modes are not nearly as strong as trumpet modes, but some sax voices do have two definite modes which, when spanned by a portamento slide, can produce irregularities.

- 5. Why do the filter, EG, and other parameters have more effect on some voices than others?**

Most voices use the low-pass filter type, but some use the bandpass, high-pass, or band eliminate types. Some voices use very little filter processing at all. Changing the filter settings may not produce a particularly noticeable effect. Also the internal Breath Noise, Throat Formant, Growl, Harmonic Enhancer and Pitch EG parameter settings can have a significant effect on how much the parameters accessible via the VL70-m controls actually affect the sound. For detailed programming of all S/VA parameters, use the VL70-m Expert Editor software(page 25).

---

**6. Why do some bowed string instrument voices tend to “squeek”?**

As anyone who has played (or tried to play) a real violin knows, these instruments naturally tend to squeek if not properly controlled. The same occurs with S/VA synthesis. As with a real bowed string instrument, bow speed and pressure must be properly controlled in the VL70-m to produce the desired sound. Bow speed is usually controlled either via breath control or an expression pedal. Bow pressure is controlled via control number 13: “64” is medium pressure, lower values produced reduced bow pressure, and higher values produce increased bow pressure.

**7. Why are pitch bends produced by a pitch bend wheel not always accurate?**

Natural acoustic musical instruments have no “pitch parameter”. Pitch is determined by the properties of the instrument’s resonant body as well as the condition of the instrument’s driver. The same applies to Virtual Acoustic Synthesis: in the VL70-m pitch bend is simulated by manipulating the appropriate pipe/string length and driver characteristics. As a result, the pitch bend range may not always be “mathematically” accurate.

With reed instruments such as saxophone or clarinet, highly realistic pitch bends are produced by controlling both pitch and embouchure at the same time. Since the embouchure component of the pitch bend behaves with characteristics acoustic unpredictability, precise pitch bends are not always produced. If you want the kind of pitch-bend precision produced by conventional synthesizers, select the VOICE sound module mode, go to the CONTROL EDIT mode, and set the Embouchure Depth and Embouchure Depth parameters to “+00”. Then set the pitch bend range to the desired value. Other controller parameters assigned to “pitch bend” can affect pitch bend accuracy, so check to make sure that none are assigned.

**8. Why do some voices not respond as expected to EG edits?**

The effect of editing envelope generator parameters may not always be as expected — particularly with plucked string instrument voices such as guitar or bass. This is because the VL70-m actually simulates the plucking, free oscillation, and muting of the strings rather than simply using an EG to approximate these events. If the sound of a string voice decays naturally, for example, setting a long release time will have little or no effect on the actual sound of the voice. Since the attack and decay portions of the voice also have natural timbre variations, these can be unnaturally altered by inappropriate EG settings — which is OK if you’re trying to produce an unnatural effect. Trial and experimentation and the only sure ways to determine how the EG parameters are going to affect a particular voice.

---

## **Error Messages**

When an operational error or other problem occurs, the VL70-m will display one of the following error messages to inform you of the problem.

### **Battery Low!**

The internal backup battery needs to be replaced. Have the battery replaced by qualified Yamaha service personnel.

### **Illegal Data!**

A data error has occurred during MIDI data reception. Try receiving the data again.

### **MIDI Buffer Full!**

The MIDI receive buffer is full. Reduce the amount of data being transmitted to the VL70-m.

### **HOST is Offline!**

The cable connection to the host computer has been broken, or the computer power is off. Also check for proper operation of the computer driver and MIDI application software.

### **SysEx Adrs ERROR!**

The received system exclusive message address is wrong.

### **SysEx Data ERROR!**

The received system exclusive message data is wrong.

### **SysEx Size ERROR!**

The received system exclusive message size is wrong.

### **Check Sum ERROR!**

An error has been detected in the received MIDI data. Check the transmitting device, MIDI cables, MIDI data and Check Sum, and try again.

### **This Parameter isn't Excl Data**

The parameter selected for viewing using the Show Exclusive function can not be controlled via system exclusive data.

### **No Parameter**

The parameter selected for viewing using the Show Exclusive or Show Control Change function is not available.

### **Rcv CH is OFF!**

Since the part receive channel for the parameter selected via the Show Control Change function is turned off, the corresponding MIDI data could not be received. Set an appropriate receive channel.

---

# Specifications

## ■ Tone Generator

Type	S/VA (Self-oscillating Virtual Acoustic Synthesis: VLR Algorithm)
Modifiers	Harmonic Enhancer Dynamic Filter Equalizer Resonator
Effects	Reverb: 12 types Chorus: 10 types Variation: 44 types Distortion: 3 types
Polyphony	1 note (monophonic)
Sound Module Modes	Voice Mode VL-XG Mode (VL extension for XG)

## ■ Memory

Preset	256 voices (including 137 VL-XG voices)
Custom	6 voices
Internal	64 voices

## ■ Panel Switches

PLAY  
EDIT  
UTIL  
EFFECT  
MODE  
BREATH  
MIDI/WX  
ENTER  
EXIT  
PART [-], [+]  
SELECT [◀], [▶]  
VALUE [-], [+]  
HOST SELECT (rear panel)

## ■ Display

Custom backlit liquid crystal display  
6 LED indicators

## ■ Connectors

Front Panel	PHONES (stereo mini-jack) WX IN (WX11, WX7) BREATH (BC3, BC2, BC1)
Rear Panel	OUTPUT X 2 (L/MONO, R) MIDI IN MIDI OUT MIDI THRU TO HOST DC IN

## ■ Output Level

Line	+5.5 dBm into 10 k $\Omega$ .
Headphones	-2.0 dBm into 33 $\Omega$ .

## ■ Power Requirements

PA-3B AC Power Adaptor (supplied).

## ■ General

Dimensions (W x D x H)	220 x 212 x 46 mm. (8-11/16" x 8-3/8" x 1-13/16")
Weight	1.3 kg (2 lbs., 14 oz.)

## ■ Accessories

Owner's Manual  
List Book  
PA-3B AC Power Adaptor  
Demonstration Disk  
Demonstration Disk Song List

\* Specifications subject to change without notice.

---

# Index

## A

Absorption	45
Absorption Control Change Number	64
Absorption Control Depth	64
Absorption Curve	65
Aftertouch	43
Aftertouch Filter Control	53
Aftertouch LFO Pitch Modulation	53
Amplitude & Filter Envelope Attack Time	72
Amplitude & Filter Envelope Decay Time	72
Amplitude & Filter Envelope Release Time	73
Amplitude & filter EG	66
Amplitude	45
Amplitude Control Change Number	56
Amplitude Control Depth	56
Amplitude Curve	57
Amplitude Level Scaling Breakpoint	73
Amplitude Level Scaling Depth	73
Answers to some common questions	110
Assign Mode	80
Assignable Controller 1 Amplitude Control	54
Assignable Controller 1 Control Change Number	54
Assignable Controller 1 Filter Control	54
Assignable Controller 1 LFO Pitch Modulation	54
Assignable Controller 1 Variation control	92
Audio connections	22

## B

Bank number	32, 38
Bank pointer	35
Bass Tone Control	72
Bitmap window	105
BREATH button	12
Breath control	96
Breath controller	17, 43
Breath controller jack	12
Breath curve	96
Breath mode	18, 96
Breath Noise Control Change Number	60
Breath Noise Control Depth	60
Breath Noise Curve	60
Breath noise	45
Breath setting lock	96
Breath settings	95

## C

Checksum	106
Chorus pan	91
Chorus parameters, type specific	91
Chorus return	33, 41
Chorus send	35, 39
Chorus type	91
Chorus-to-reverb send level	91
Control change number assignments	43
Control editing	42
Control parameters, accessing and editing	46
Controller parameters	45
Controllers	9, 42

Custom voice bank	26
Cutoff Frequency	71
Cutoff Scaling Breakpoint	71
Cutoff Scaling Depth	71

## D

Damping	45
Damping Control Change Number	63
Damping Control Depth	63
Damping Curve	64
DC IN connector	14
Demo disk	25
Demo playback	24
Detune	79
Device number	32, 41
Display	12
Display contrast	99
Distortion control, aftertouch	94
Distortion control, assignable controller 1	94
Distortion parameters, type specific	94
Distortion part	94
Distortion type	94
Dry Output Level	82
Dump out function	100

## E

EDIT button	12
Editing software	25
EFFECT button	12
Effect editing	86
Effect signal flow	86
Embouchure	45
Embouchure Control Change Number	57
Embouchure Lower Control Depth	58
Embouchure Mode	58
Embouchure Upper Control Depth	57
ENTER button	13
Error messages	112
EXIT button	13
Expression	38
Expression Mode	54

## F

Filter	45
Filter and envelope generator editing	66
Filter Control Change Number	55
Filter Control Depth	56
Filter Curve	56
Filter Envelope Generator Depth	71

## G

G50 MIDI Guitar Converter	19
Growl	45
Growl Control Change Number	61
Growl Control Depth	61
Growl Curve	61

<b>H</b>	
Harmonic Enhancer Control Change Number . . . . .	62
Harmonic Enhancer Control Depth . . . . .	63
Harmonic Enhancer Curve . . . . .	63
Harmonic enhancer . . . . .	45
Headphones . . . . .	22
High Note Limit . . . . .	81
HOST SELECT switch . . . . .	14
<b>I</b>	
IBM PC, connecting to . . . . .	21
Initialize function . . . . .	102
Instrument . . . . .	8
Internal voice bank . . . . .	26
<b>L</b>	
Lip mode . . . . .	18
Low Note Limit . . . . .	81
<b>M</b>	
Macintosh, connecting to . . . . .	20
Manual, about the . . . . .	1
Master tuning . . . . .	98
Master Volume . . . . .	41
Message window . . . . .	104
MIDI bulk dump interval . . . . .	99
MIDI connections . . . . .	16
MIDI connectors . . . . .	14
MIDI note filter . . . . .	99
MIDI transmit channel . . . . .	98
MIDI/WX button . . . . .	13
MIDI/WX setting . . . . .	18
MODE button . . . . .	12
Modifiers . . . . .	10
Modulation Wheel LFO Filter Modulation . . . . .	53
Modulation Wheel LFO Pitch Modulation . . . . .	53
Modulation wheel . . . . .	43
Monophonic/Polyphonic Mode . . . . .	80
<b>N</b>	
NEC PC-9801/9821, connecting to . . . . .	21
Note shift . . . . .	35, 39
<b>O</b>	
Other Edit Parameters . . . . .	75
OUTPUT L/MONO and R jacks . . . . .	14
<b>P</b>	
Pan . . . . .	32, 38
PART buttons . . . . .	13
Personal computer, connecting to . . . . .	20
PHONES jack . . . . .	12
Pitch & Embouchure Envelope Attack Time . . . . .	74
Pitch & Embouchure Envelope Initial Level . . . . .	73
Pitch & Embouchure Envelope Release Level . . . . .	74
Pitch & Embouchure Envelope Release Time . . . . .	74
Pitch & embouchure EG . . . . .	66
Pitch Bend Control . . . . .	52
Pitch Bend LFO Pitch Modulation . . . . .	52
Pitch Bend Low Control . . . . .	52
Pitch bend wheel . . . . .	43
PLAY button . . . . .	12
Polyphonic Expansion . . . . .	80
Portamento Mode . . . . .	82
Portamento Switch . . . . .	82
Portamento Time . . . . .	82
Power supply . . . . .	15
Power-on procedure . . . . .	23
POWER/VOL control . . . . .	12
Precautions . . . . .	4
Preset voice banks . . . . .	26
Pressure . . . . .	45
Pressure Control Change Number . . . . .	55
Pressure Control Depth . . . . .	55
Pressure Curve . . . . .	55
Program number . . . . .	32, 38
Program pointer . . . . .	35
<b>R</b>	
Receive channel . . . . .	34, 38
Resonance . . . . .	71
Reverb pan . . . . .	90
Reverb parameters, type specific . . . . .	90
Reverb return . . . . .	32, 41
Reverb send . . . . .	35, 39
Reverb type . . . . .	90
<b>S</b>	
Scream . . . . .	45
Scream Control Change Number . . . . .	59
Scream Control Depth . . . . .	59
Scream Curve . . . . .	60
SELECT buttons . . . . .	13
Show control change . . . . .	103
Show exclusive . . . . .	103
Sound module mode . . . . .	18
Sound module modes . . . . .	27, 29
Specifications . . . . .	113
Stereo sound system . . . . .	22
Store function . . . . .	84
System exclusive receive . . . . .	98
System transpose . . . . .	33
<b>T</b>	
Throat Formant Control Change Number . . . . .	62
Throat Formant Control Depth . . . . .	62
Throat Formant Curve . . . . .	62
Throat formant . . . . .	45
TO HOST connectors . . . . .	14
Tonguing . . . . .	45
Tonguing Control Change Number . . . . .	58
Tonguing Control Depth . . . . .	59
Tonguing Curve . . . . .	59
Transpose . . . . .	41
Treble Tone Control . . . . .	72
Troubleshooting . . . . .	107

---

## U

UTIL button	12
Utility mode	97

## V

VALUE buttons	13
Variation connection mode	93
Variation pan	93
Variation parameters, type specific	92
Variation return	33, 41
Variation send	35, 39
Variation stage as insertion effect	86
Variation stage as system effect	87
Variation type	92
Variation-to-chorus send level	93
Variation-to-reverb send level	93
Velocity	43
Velocity Sensitivity Depth	81
Velocity Sensitivity Offset	81
Vibrato Delay	79
Vibrato Depth	79
Vibrato Rate	79
Virtual Acoustic Synthesis	6
VL Extension for XG	30
VL-XG play main control mode	37
VL-XG play mode	36
VL-XG play sub-control mode	40
VL-XG sound module mode	28
VL70-m model	7
Voice Level	79
Voice Name	83
Voice organization	26
Voice play main control mode	31
Voice play mode	31
Voice play sub-control mode	34
Voice sound module mode	27
Volume	32, 38

## W

WX IN jack	12
WX lip lock	98
WX lip mode	98
WX wind MIDI controller	18



---

---

For details of products, please contact your nearest Yamaha or the authorized distributor listed below.

Pour plus de détails sur les produits, veuillez-vous adresser à Yamaha ou au distributeur le plus proche de vous figurant dans la liste suivante.

Die Einzelheiten zu Produkten sind bei Ihrer unten aufgeführten Niederlassung und bei Yamaha Vertragshändlern in den jeweiligen Bestimmungsländern erhältlich.

Para detalles sobre productos, contacte su tienda Yamaha más cercana o el distribuidor autorizado que se lista debajo.

## NORTH AMERICA

### CANADA

**Yamaha Canada Music Ltd.**  
135 Milner Avenue, Scarborough, Ontario,  
M1S 3R1, Canada  
Tel: 416-298-1311

### U.S.A.

**Yamaha Corporation of America**  
6600 Orangethorpe Ave., Buena Park, Calif. 90620,  
U.S.A.  
Tel: 714-522-9011

## MIDDLE & SOUTH AMERICA

### MEXICO

**Yamaha De Mexico S.A. De C.V.,  
Departamento de ventas**  
Javier Rojo Gomez No.1149, Col. Gpe Del  
Moral, Deleg. Iztapalapa, 09300 Mexico, D.F.  
Tel: 686-00-33

### BRASIL

**Yamaha Musical Do Brasil LTDA.**  
Ave. Reboucas 2636, São Paulo, Brasil  
Tel: 011-853-1377

### PANAMA

**Yamaha De Panama S.A.**  
Edificio Interseco, Calle Elvira Mendez no.10,  
Piso 3, Oficina #105, Ciudad de Panama, Panama  
Tel: 507-69-5311

### OTHER LATIN AMERICAN COUNTRIES AND CARIBBEAN COUNTRIES

**Yamaha Music Latin America Corp.**  
6101 Blue Lagoon Drive, Miami, Florida 33126,  
U.S.A.  
Tel: 305-261-4111

## EUROPE

### THE UNITED KINGDOM

**Yamaha-Kemble Music (U.K.) Ltd.**  
Sherbourne Drive, Tilbrook, Milton Keynes,  
MK7 8BL, England  
Tel: 01908-366700

### IRELAND

**Danfay Ltd.**  
61D, Sallynoggin Road, Dun Laoghaire, Co. Dublin  
Tel: 01-2859177

### GERMANY/SWITZERLAND

**Yamaha Europa GmbH.**  
Siemensstraße 22-34, 25462 Rellingen,  
F.R. of Germany  
Tel: 04101-3030

### AUSTRIA

**Yamaha Music Austria**  
Schleiergasse 20, A-1100 Wien Austria  
Tel: 0222-60203900

### THE NETHERLANDS

**Yamaha Music Nederland**  
Kanaalweg 18G, 3526KL, Utrecht, The Netherlands  
Tel: 030-2828411

### BELGIUM

**Yamaha Music Belgium**  
Keiberg Imperiastraat 8, 1930 Zaventem, Belgium  
Tel: 02-7258220

### FRANCE

**Yamaha Musique France,  
Division Professionnelle**  
BP 70-77312 Marne-la-Valée Cedex 2, France  
Tel: 01-64-61-4000

## ITALY

**Yamaha Musica Italia S.P.A.,  
Combo Division**  
Viale Italia 88, 20020 Lainate (Milano), Italy  
Tel: 02-935-771

## SPAIN

**Yamaha-Hazen Electronica Musical, S.A.**  
Jorge Juan 30, 28001, Madrid, Spain  
Tel: 91-577-7270

## PORTUGAL

**Valentim de Carvalho CI SA**  
Estrada de Porto Salvo, Paço de Arcos 2780 Oeiras,  
Portugal  
Tel: 01-443-3398/4030/1823

## GREECE

**Philippe Nakas S.A.**  
Navarinou Street 13, P.Code 10680, Athens, Greece  
Tel: 01-364-7111

## SWEDEN

**Yamaha Scandinavia AB**  
J. A. Wettergrens Gata 1  
Box 30053  
S-400 43 Göteborg, Sweden  
Tel: 031 89 34 00

## DENMARK

**YS Copenhagen Liaison Office**  
Generatorvej 8B  
DK-2730 Herlev, Denmark  
Tel: 44 92 49 00

## FINLAND

**Warner Music Finland OY/Fazer Music**  
Aleksanterinkatu 11, P.O. Box 260  
SF-00101 Helsinki, Finland  
Tel: 0435 011

## NORWAY

**Narud Yamaha AS**  
Grini Næringspark 17  
N-1345 Østerås, Norway  
Tel: 67 14 47 90

## ICELAND

**Skifan HF**  
Skeifan 17 P.O. Box 8120  
IS-128 Reykjavik, Iceland  
Tel: 525 5000

## OTHER EUROPEAN COUNTRIES

**Yamaha Europa GmbH.**  
Siemensstraße 22-34, 25462 Rellingen, F.R. of  
Germany  
Tel: 04101-3030

## AFRICA

**Yamaha Corporation,  
International Marketing Division**  
Nakazawa-cho 10-1, Hamamatsu, Japan 430  
Tel: 053-460-2312

## MIDDLE EAST

### TURKEY/CYPRUS

**Yamaha Europa GmbH.**  
Siemensstraße 22-34, 25462 Rellingen,  
F.R. of Germany  
Tel: 04101-3030

### OTHER COUNTRIES

**Yamaha Corporation,  
International Marketing Division**  
Nakazawa-cho 10-1, Hamamatsu, Japan 430  
Tel: 053-460-2312

## ASIA

### HONG KONG

**Tom Lee Music Co., Ltd.**  
11/F., Silvercord Tower 1, 30 Canton Road,  
Tsimshatsui, Kowloon, Hong Kong  
Tel: 730-1098

### INDONESIA

**PT. Yamaha Music Indonesia (Distributor)  
PT. Nusantik**  
Gedung Yamaha Music Center, Jalan Jend. Gatot  
Subroto Kav. 4, Jakarta 12930, Indonesia  
Tel: 21-520-2577

### KOREA

**Cosmos Corporation**  
#131-31, Neung-Dong, Sungdong-Ku, Seoul  
Korea  
Tel: 02-466-0021~5

### MALAYSIA

**Yamaha Music Malaysia, Sdn., Bhd.**  
16-28, Jalan SS 2/72, Petaling Jaya, Selangor,  
Malaysia  
Tel: 3-717-8977

### PHILIPPINES

**Yupango Music Corporation**  
339 Gil J. Puyat Avenue, P.O. Box 885 MCPO,  
Makati, Metro Manila, Philippines  
Tel: 819-7551

### SINGAPORE

**Yamaha Music Asia Pte., Ltd.**  
Blk 17A Toa Payoh #01-190 Lorong 7  
Singapore 1231  
Tel: 354-0133

### TAIWAN

**Kung Hsue She Trading Co., Ltd.**  
No. 322, Section 1, Fu Hsing S. Road,  
Taipei 106, Taiwan. R.O.C.  
Tel: 02-709-1266

### THAILAND

**Siam Music Yamaha Co., Ltd.**  
865 Phornprapha Building, Rama I Road,  
Patumwan, Bangkok 10330, Thailand  
Tel: 2-215-3443

### THE PEOPLE'S REPUBLIC OF CHINA AND OTHER ASIAN COUNTRIES

**Yamaha Corporation,  
International Marketing Division**  
Nakazawa-cho 10-1, Hamamatsu, Japan 430  
Tel: 053-460-2317

## OCEANIA

### AUSTRALIA

**Yamaha Music Australia Pty. Ltd.**  
17-33 Market Street, South Melbourne, Vic. 3205,  
Australia  
Tel: 3-699-2388

### NEW ZEALAND

**Music Houses of N.Z. Ltd.**  
146/148 Captain Springs Road, Te Papapa,  
Auckland, New Zealand  
Tel: 9-634-0099

### COUNTRIES AND TRUST TERRITORIES IN PACIFIC OCEAN

**Yamaha Corporation,  
International Marketing Division**  
Nakazawa-cho 10-1, Hamamatsu, Japan 430  
Tel: 053-460-2317

**YAMAHA**  
YAMAHA CORPORATION