

So good, even
mother nature
would approve...

Thermal Bridge Calculations



econeKT
THE INTELLIGENT BUILDING SYSTEM

INSULATED CONCRETE FORMWORK (ICF)

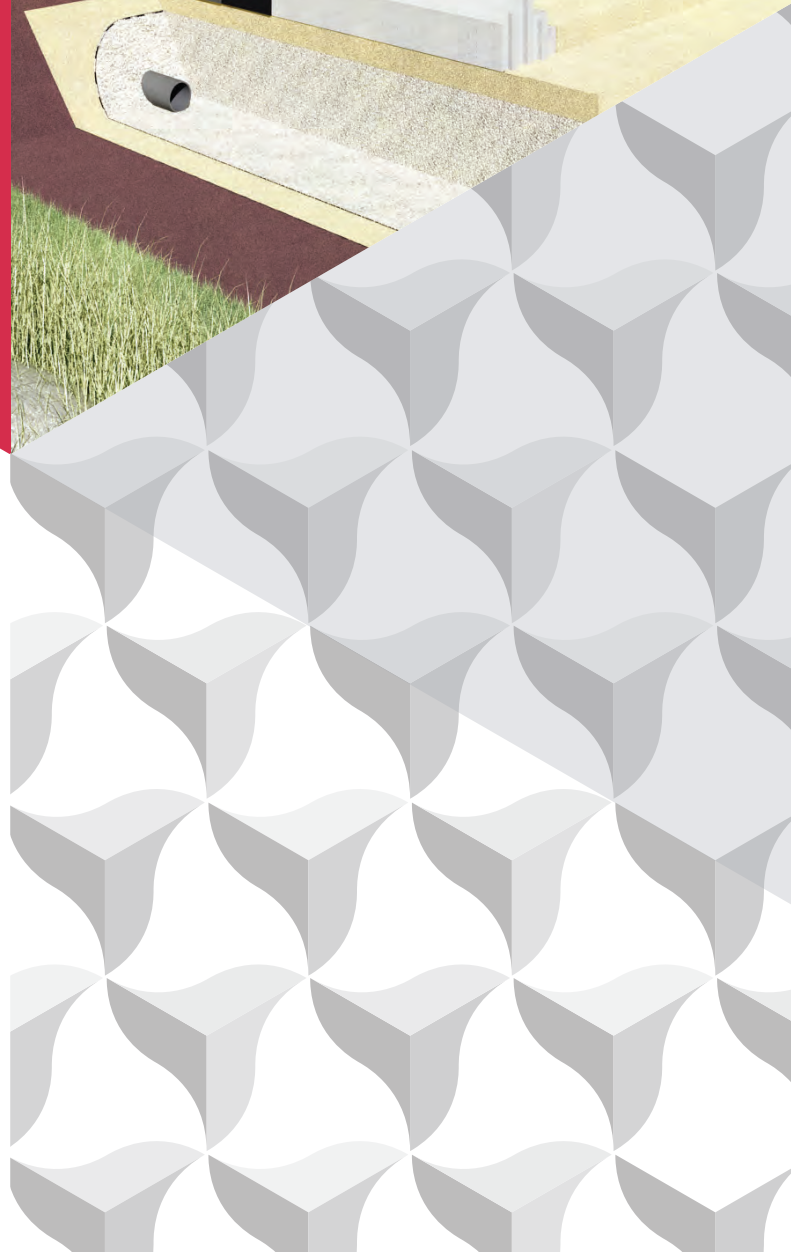

This document has been compiled in accordance with PN-EN ISO 10211 “Thermal bridges in building construction – Heat flows and surface temperatures - Detailed calculations” – calculations for selected details available in the Izodom technology, in accordance with the checklist published by the National Fund for Environmental Protection and Water Management.

Reference documents:

- a) “Determination of basic requirements necessary to achieve the anticipated energy standards for residential buildings and the manner of design review as well as inspection of completed energy-saving houses” – STAGE I, Guidelines for reviewing residential building designs conforming with the standard of the National Fund for Environmental Protection and Water Management. Author: Polish National Energy Conservation Agency, Warsaw, 23 August 2012
- b) Attachment no. 3 to the Priority Programme of 18 July 2013¹ – Guidelines establishing basic requirements necessary to achieve the anticipated energy standards for residential buildings and the manner of reviewing designs as well as the inspection of completed energy-saving houses.
- c) *Annexe A to Guidelines* – Checklist for reviewing building designs of single-family buildings – Priority Programme: Effective use of energy

Authors:

Marek Jabłoński (PhD), Department of Building Physics, Jakub Wójcik (MSc) – Izodom 2000 Polska Sp. z o.o., edited by prof. dr hab. inż. Dariusz Gawin, Faculty of Civil Engineering, Architecture and Environmental Engineering, al. Politechniki 6, 93-590 Łódź, tel: +42 631 35 00, fax: +42 631 35 02, e-mail: dariusz.gawin@p.lodz.pl, www.p.lodz.pl

January 2014
Łódź, Poland

Izodom 2000 Polska Spółka z o.o.

98-220 Zduńska Wola, ul. Ceramiczna 2a
tel. 043 823 23 68, fax. 043 823 41 88
e-mail: biuro@izodom.pl
www.izodom.pl

List of available publications:

- Issue No. 1:** Basic information on material and erection technology of the “Izodom 2000 Polska” system
- Issue No. 2:** Design and calculation guidelines for walls in the “Izodom 2000 Polska” system. “Richtlinien für die Berechnung und Konstruktion der Wände im System Izodom 2000 Polska”; [German version of Issue No. 2, based on German National Standards]
- Issue No. 3:** Floors in the “Izodom 2000 Polska” system
- Issue No. 4:** Halls, cold stores, warehouses in the “Izodom 2000 Polska” system
- Issue No. 5:** Design and calculation guidelines for tiny aggregate concrete walls in the “Izodom 2000 Polska” system
- Issue No. 6:** Design and calculation guidelines for swimming pools in the “Izodom 2000 Polska” system
- Issue No. 7:** Roofs in the “Izodom 2000 Polska” system. Rules of using thermal insulation on rafter and flat reinforced-concrete roofs
- Issue No. 8:** Slab foundations in the “Izodom 2000 Polska” system
- Issue No. 9:** Applying the “Izodom 2000 Polska” wall system in regions of seismic risk
- Issue No. 10:** Ground temperature distribution with the Izodom slab foundation
- Issue No. 11:** Catalogue of linear thermal bridges for selected structural details of the Izodom system
- Issue No. 12:** Thermal conductivity of space dividers in the Izodom technology. Foundations, walls and roofs

¹ <http://www.nfosigw.gov.pl/srodki-krajowe/doplaty-do-kredytow/doplaty-do-kredytow-na-domy-energooszczedne/wytyczne-do-programu-priorytetp/>

Table of Contents

1. Introduction.....	4
2.Connection between external wall and internal load-bearing wall (Super King Blok).....	9
3.Connection between external wall and internal load-bearing wall (King Blok).....	12
4.Connection between external wall and partition wall (Super King Blok).....	15
5.Connection between external wall and internal load-bearing wall (King Blok).....	18
6.Connection between external wall and flat roof (Super King Blok).....	21
7.Connection between external wall and flat roof (King Blok).....	25
8.Connection between external wall with flat roof and parapet wall (Super King Blok).....	29
9.Connection between external wall and flat roof (King Blok).....	33
10.Knee wall (Super King Blok).....	37
11.Knee wall (King Blok).....	41
12.Flat roof resting on external wall (Super King Blok).....	45
13.Flat roof resting on external wall (King Blok).....	49
14.Self-supporting balcony added to the building (Super King Blok).....	53
15.Self-supporting balcony added to the building (King Blok).....	56
16.Connection between door frame and jamb (Super King Blok).....	59
17.Connection between door frame and jamb (King Blok).....	64
18.Suspended floor slabs (Super King Blok).....	67
19.Suspended floor slabs (King Blok).....	70
20.Suspended floor slabs (Super King Blok) – option 2.....	73
21.Suspended floor slabs (King Blok) – option 2.....	76
22.Floor slabs above unheated basement (Super King Blok).....	79
23.Floor slabs above unheated basement (King Blok).....	83
24.Entrance door (Super King Blok).....	87
25.Entrance door (King Blok).....	90
26.Roller shutter box (Super King Blok).....	93
27.Roller shutter box (King Blok).....	97
28.Connection between external wall and foundation (Super King Blok).....	101
29.Connection between external wall and foundation (King Blok).....	104
30.Collective table for single-family buildings.....	107
31.Collective table for multifamily buildings.....	108
32.Determination of declared and design thermal values.....	110
33.Attachment no. 1 – Test report on thermal conductivity.....	116

1. Introduction

This document presents the results of the calculation of linear thermal transmittance in thermal bridges in contact with the ground. The calculations are performed using the software Therm, the calculation methodology of which complies with the requirements provided in PN-EN ISO 10211:2008 "Thermal bridges in building construction — Heat flows and surface temperatures — Detailed calculations". The calculations relate to selected structural details available in the Izodom system.

Calculation method for linear thermal transmittance

Values of linear thermal transmittance Ψ_e [W/mK] are calculated in terms of external dimensions in accordance with PN-EN ISO 10211:2008.

The values of linear thermal transmittance Ψ_e [W/mK] are calculated in terms of external dimensions using with the following relationship:

$$\Psi_e = L^{2D} - \sum_{j=1}^N U_j l_j$$

where

L^{2D} — linear thermal coupling coefficient

U_j — thermal transmittance for a 1-D component j separating to environments under consideration [W/m²K],

l_j — length within a 2-D geometrical model, the length at which the value of U_j [m] applies,

N - number of 1-D components

The principle of modelling, planes of geometrical model cross-sections and their arrangement for all models are determined in accordance with PN-EN ISO 10211:2008.

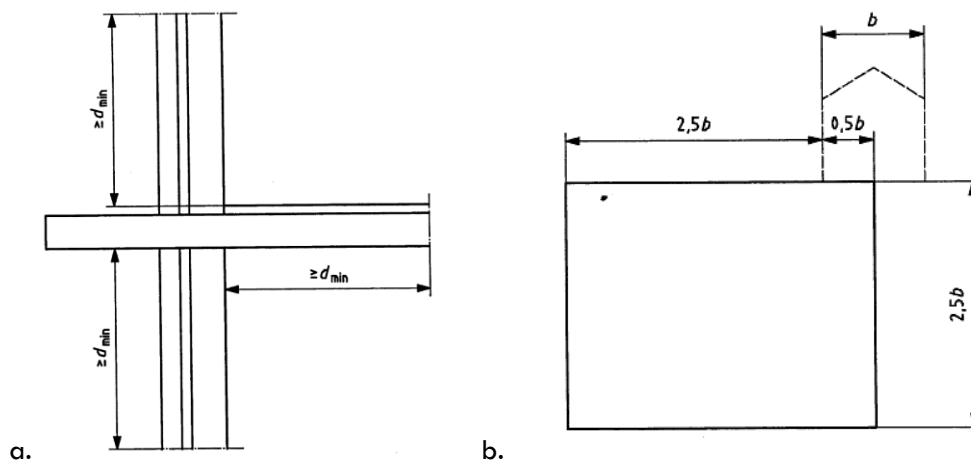

Fig. 1. Arrangement of cross-section planes in relation to the central element (a) and in the ground (b) in a 2-D geometrical model.

d_{min} — the assumed value is 1 m,

b — the assumed value is 8 m.

In order to determine linear thermal transmittance of the floor slab above an unheated basement, the procedure described in Annexe C to PN-EN ISO 10211:2008 and in PN-EN ISO 13370:2008 is followed. For the calculations, the diagram presented in Fig. 2 is used.

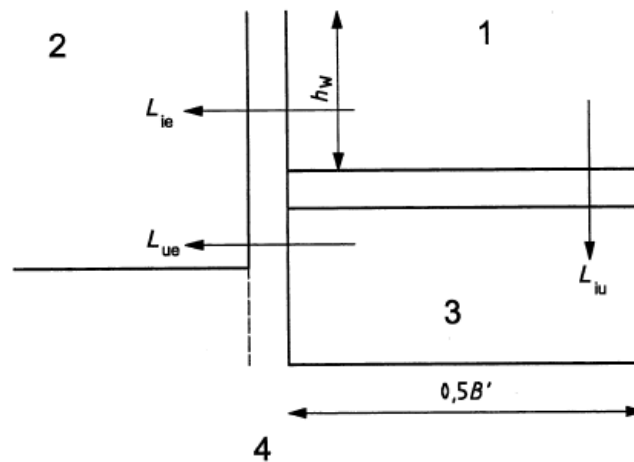

Fig. 2. Diagram for calculating the linear thermal coupling coefficient for a raised floor.

- 1 – internal environment, θ_i
- 2 – external environment, θ_e
- 3 – space below the floor, θ_u
- 4 – ground
- B' – characteristic dimension of the floor
- h_w – length of the space divider above the floor to the cross-section plane
- L_{ie} – linear thermal coupling coefficient between the internal and external environments
- L_{iu} – linear thermal coupling coefficient between the internal environment and the space below the floor
- L_{ue} – linear thermal coupling coefficient between the space below the floor and the external environment

Boundary conditions for calculating the linear thermal coupling coefficient L^{2D} are presented in Table 1.

Table 1. Boundary conditions for calculating the linear thermal coupling coefficient

Calculation No.	θ_i °C	θ_e °C	θ_u °C	Calculation result
1	1	0	0	$L_1 = L_{ie} + L_{iu}$
2	0	1	0	$L_2 = L_{ie} + L_{ue}$
3	0	0	1	$L_3 = L_{iu} + L_{ue}$

$$L_{iu} = 0.5 * (L_1 - L_2 + L_3)$$

$$L_{ie} = 0.5 * (L_1 + L_2 - L_3)$$

$$L_{ue} = 0.5 * (L_2 + L_3 - L_1)$$

Once the values L_{ie} , L_{iu} and L_{ue} are determined, the linear thermal coupling coefficient L^{2D} is calculated using with the following relationship:

$$L_{2D} = \left(\frac{L_{iu}L_{ue}}{L_{iu} + L_{ue}} + L_{ie} \right)$$

The values of linear thermal transmittance Ψ_e [W/mK] are calculated in accordance with the formula provided in PN-EN ISO 10211:2008 (item 10.4):

$$\Psi_e = L^{2D} - (h_w + h_f) U_w - 0.5 * (B' + w) U_g$$

where

L^{2D} – linear thermal coupling coefficient [W/mK],

U_w – thermal transmittance for a wall above the ground [W/m²K],

h_w – length of the space divider above the ground to the cross-section plane [m],

h_f – floor height [m],

B' – floor characteristic dimension [m],

w – thickness of space divider [m],

U_g – thermal transmittance for the floor in contact with the ground [W/m²K].

Thermal transmittance U_g for the floor on the ground is determined in accordance with PN-EN ISO 13370:2008.

In order to determine linear thermal transmittance at the connection of wall/floor and entrance door, the procedure described in item 10.4 of PN-EN ISO 13370:2008 is followed. For the calculations, the diagram presented in Fig. 3 is used.

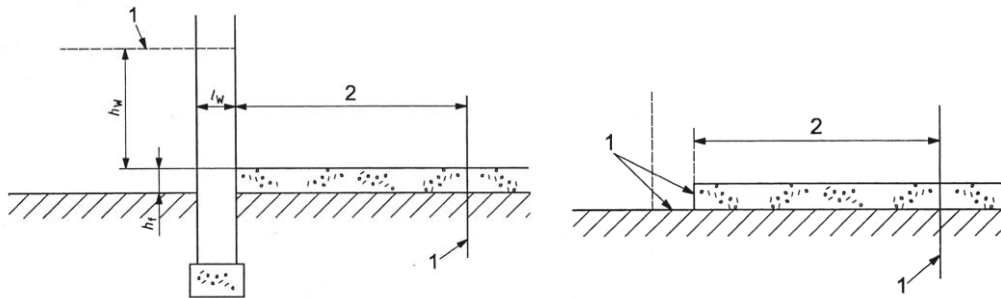

Fig. 3. Diagram for calculating the linear thermal coupling coefficient L^{2D} and $L^{2D,a}$

1 – adiabatic boundary conditions

2 – $0.5*B'$ or 4 m

h_f – height of the floor slab above the ground

h_w – minimum distance from the wall/floor connection to the cross-section plane

l_w – thickness of space divider

Linear transmittance of the wall/floor connection is calculated using the following relationship:

$$\Psi_e = L^{2D} - h_w U_w - L^{2D,a}$$

The Izodom system walls are characterised by their inhomogeneous horizontal cross-section, and therefore this document presents the calculation of linear thermal transmittance values for two characteristics cross-sections (1 – with continuous concrete layer, 2 – with concrete layer divided by expanded polystyrene “connectors”). The following step determines the mean thermal transmittance in accordance with the following relationship:

$$\Psi_{e, sr} = (\Psi_{e,1} h_1 + \Psi_{e,2} h_2) / (h_1 + h_2),$$

where:

$\Psi_{e,1}$ – linear thermal transmittance calculated for cross-section 1 [W/mK],

h_1 – height in external dimensions of cross-section 1 for which the transmittance $\Psi_{e,1}$ [m] is calculated,

$\Psi_{e,2}$ – linear thermal transmittance calculated for cross-section 2 [W/mK],

h_2 – height in external dimensions of cross-section 1 for which the transmittance $\Psi_{e,2}$ [m] is calculated.

The following boundary conditions are assumed:



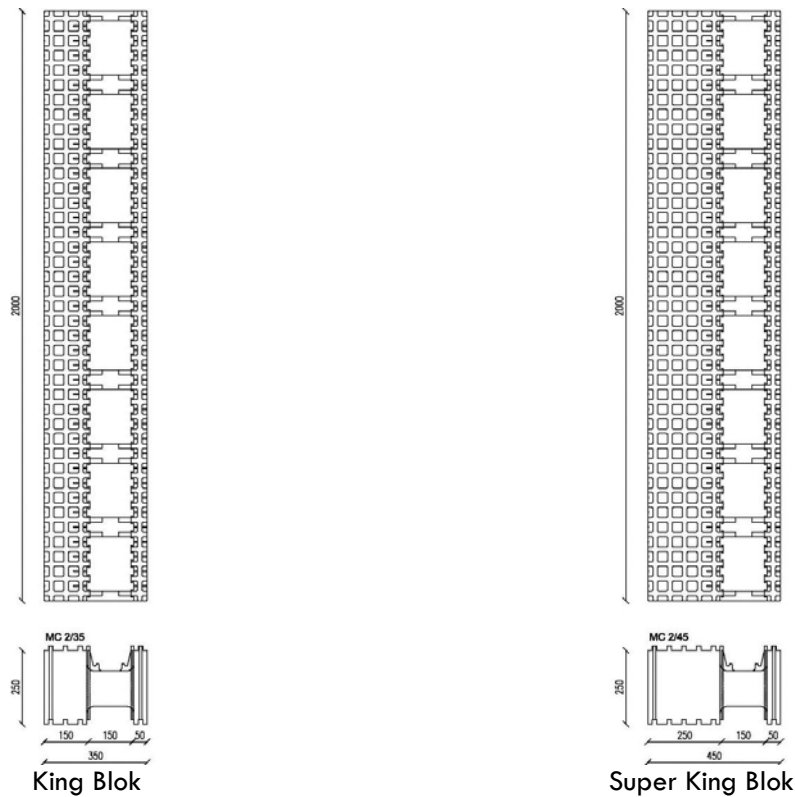









- internal temperature +20 °C, heat transfer coefficient acc. to PN-EN ISO 6946:2008
- external temperature -20 °C, heat transfer coefficient acc. to PN-EN ISO 6946:2008



Values of thermal conductivity λ [W/mK] for building materials, assumed for the calculation purposes, are presented in Table 2.

Table 2. Values of thermal conductivity λ [W/mK] assumed for individual building materials

	Thermal conductivity [W/mK]	Colour codes
Expanded polystyrene NEOPOR 30 g/l (Attachment 1)	0.031	
Expanded polystyrene EPS 25 g/l (Attachment 1)	0.034	

EPS board PERIPOR 40 g/l (Attachment 1)	0.034	
Concrete	1.7	
Gypsum plaster	0.4	
Thin-coat plaster	1.0	
Wood	0.16	
Roofing membrane	0.18	
Expanding foam	0.036	
Brick	0.77	
Foam glass	0.12	
Ground	1.5	
Sand	2.0	
Floor tiles	1.05	

As required by PN-EN ISO 13788:2005, in order to check the risk of condensation at the internal surface of space divider, the temperature factor $f_{R_{si}}$ must be determined, followed by a comparison with the design temperature factor at the internal surface.

For the estimated risk of mould growth, it is assumed that thermal resistance at the internal surface R_{si} is 0.25 [m²K/W] (PN-EN ISO 13788, item 4.3.1 and PN-EN ISO 10211-1, item 6.1.2). The corresponding h_{si} is 4.0 [W/m²K].

If the condition $f_{R_{si}} \leq f_{R_{si \max}}$ is met, there are conditions favour mould growth. Alternatively, if $f_{R_{si}} > f_{R_{si \max}}$ is met, there are no conditions favouring mould growth.

where

$f_{R_{si}}$ – design temperature factor at the internal surface,

$f_{R_{si, \max}}$ – maximum design temperature factor at the internal surface at the critical point.

Design temperature factor at the internal surface:

$$f_{R_{si}} = (\theta_{si} - \theta_e) / (\theta_i - \theta_e)$$

where

θ_{si} – minimum temperature at the internal surface of wall

θ_e – external temperature [°C]

θ_i – internal temperature [°C]

2.Connection between external wall and internal load-bearing wall (Super King Blok)

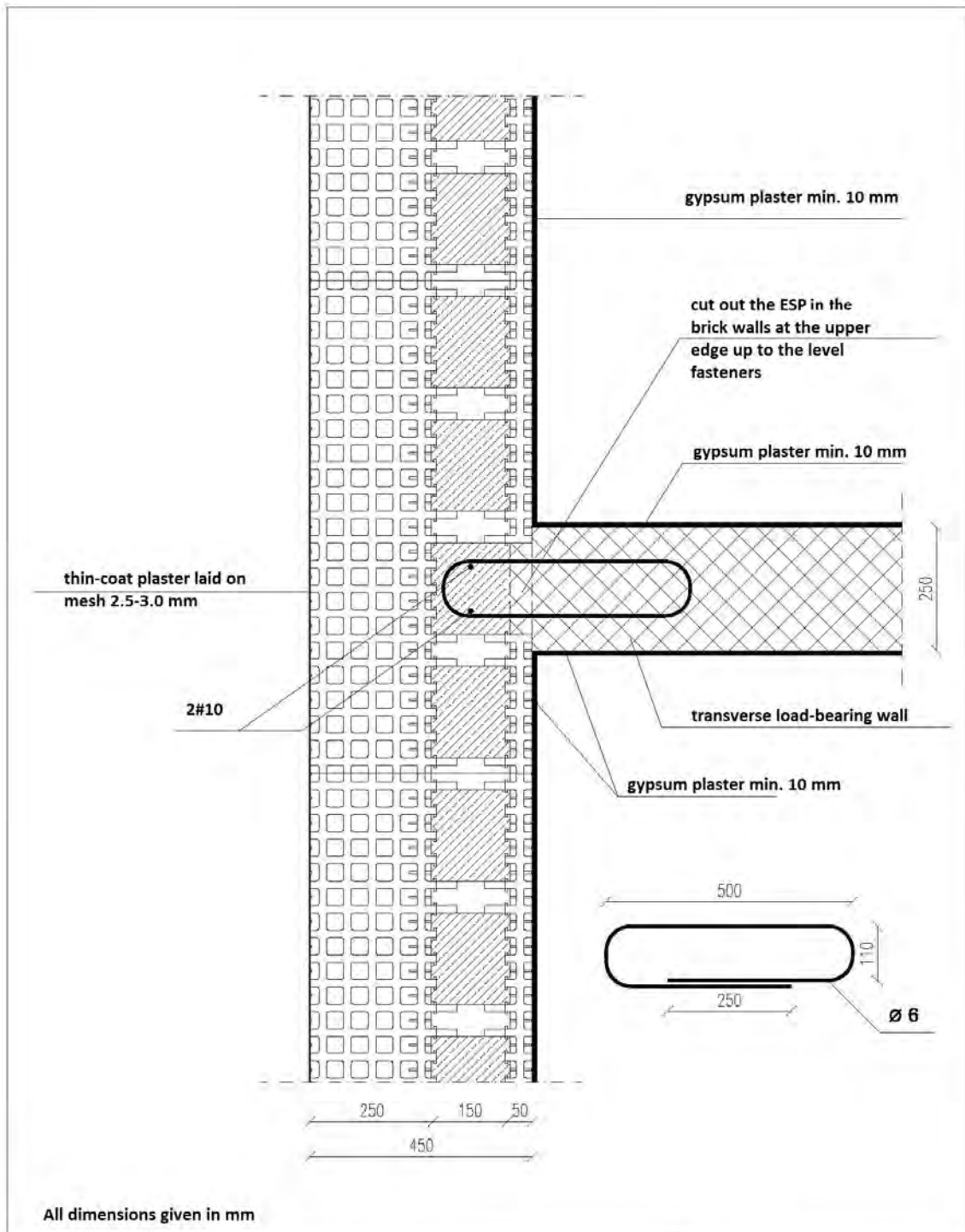

<p>IZODOM 2000 POLSKA</p>	<p>Attachment no.</p>
<p>THERMAL BRIDGES-DETAIL</p> <p>Connection between external wall and internal load-bearing wall (SUPER KING BLOK)</p>	

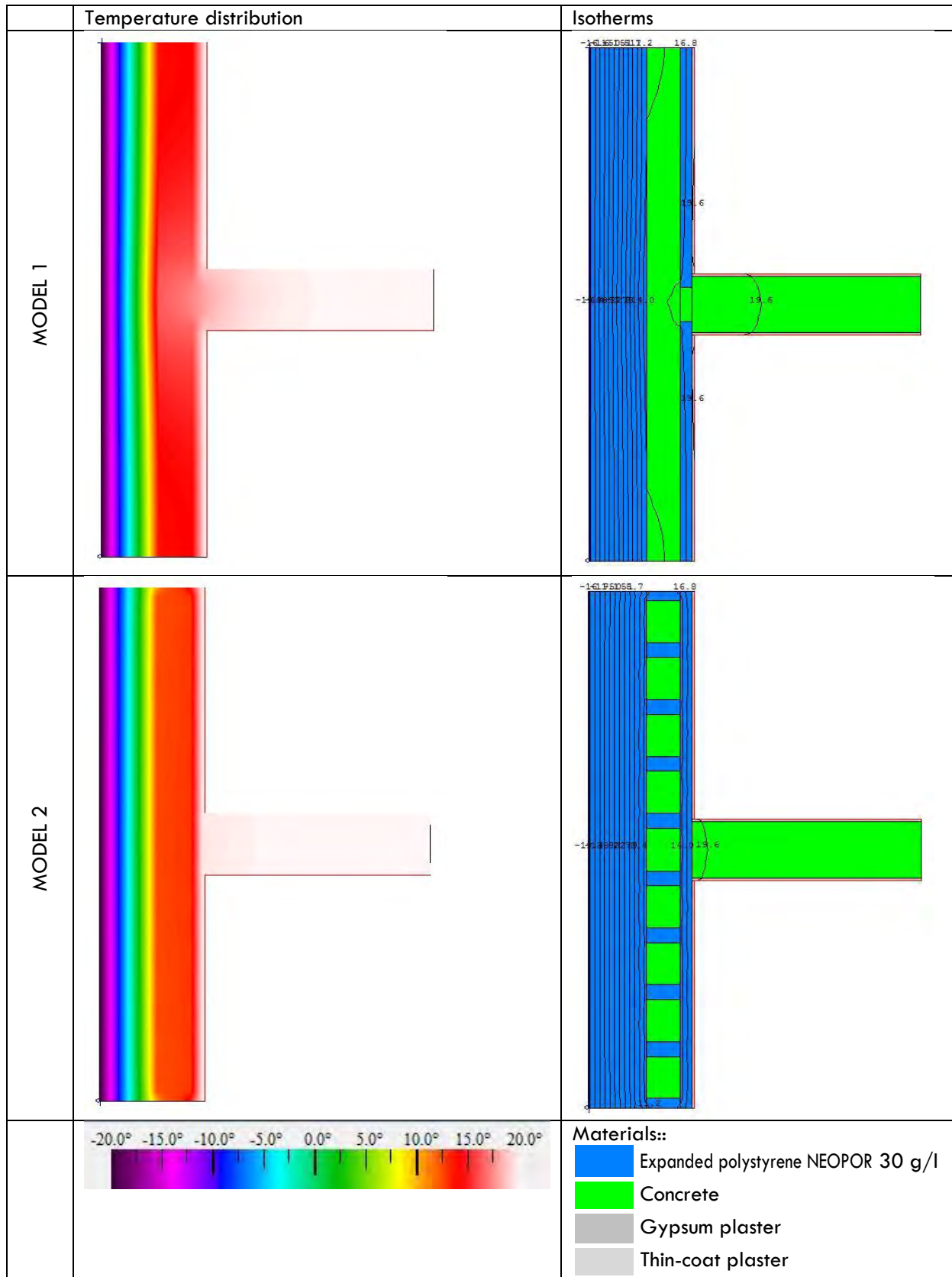

Value of thermal transmittance U_A at the external wall for model 1:

Description	d	λ	R	U
	[m]	[W/mK]	[m ² K/W]	[W/m ² K]
Thermal resistance on the internal side			0.13	
Gypsum plaster	0.01	0.4	0.025	
Expanded polystyrene NEOPOR 30 g/l	0.05	0.031	1.613	
Concrete	0.15	1.7	0.088	
Expanded polystyrene NEOPOR 30 g/l	0.25	0.031	8.065	
Thin-coat mineral plaster	0.005	1.0	0.005	
Thermal resistance on the external side			0.04	
Total thickness	0.47		9.966	0.100

Value of linear thermal transmittance Ψ_1 calculated for model 1:

	U-factor W/m ² K	delta T C	Length mm
Edge	0.1072	40.0	2270

U = 0.107 [W/m²K]
L = 2.27 [m]

$U_A = 0.100$ [W/m²K]
 $L_A = 2.27$ [m]

$$\Psi_1 = 0.107 * 2.27 - 0.100 * 2.27 = 0.016 \text{ [W/mK]}$$

Value of thermal transmittance U at the external wall for model 2:

Total thermal resistance

	R-Value m ² K/W	delta T C	Length mm
Edge	10.0231	40.0	2270

R = 10.0231 m²K/W

	U-factor W/m ² K	delta T C	Length mm
Edge	0.0998	40.0	2270

$U_A = 1 / R = 0.0998$ W/m²K

Value of linear thermal transmittance Ψ_2 calculated for model 2:

	U-factor W/m ² K	delta T C	Length mm
Edge	0.0998	40.0	2270

U = 0.0998 [W/m²K]
L = 2.27 [m]
 $U_A = 0.0998$ [W/m²K]
 $L_A = 2.27$ [m]

Length (width) at which the bridge occurs for model 2
 $l_2 = 0.12$ m

$$\Psi_e = (\Psi_1 * l_1 + \Psi_2 * l_2) / (l_1 + l_2) = (0.016 * 0.12 + 0.0 * 0.13) / (0.12 + 0.13)$$

$$\Psi_e = 0.008 \text{ [W/mK]}$$

$$\Psi_2 = 0.0998 * 2.27 - 0.0998 * 2.27 = 0.0 \text{ [W/mK]}$$

Resultant linear thermal transmittance Ψ_e for the entire element (weighted with the length, at which the bridge occurs):

Length (width) at which the bridge occurs for model 1 $l_1 = 0.13$ m

Design temperature factor at the internal surface f_{Rsi} :

The minimum temperature θ_{si} at the internal surface of wall, obtained from the software, is 18.5 °C.

$$f_{Rsi} = (\theta_{si} - \theta_e) / (\theta_i - \theta_e) = (18.5 - (-20)) / (20 - (-20)) = 38.5 / 40$$

$$f_{Rsi} = 0.963$$

3. Connection between external wall and internal load-bearing wall (King Blok)

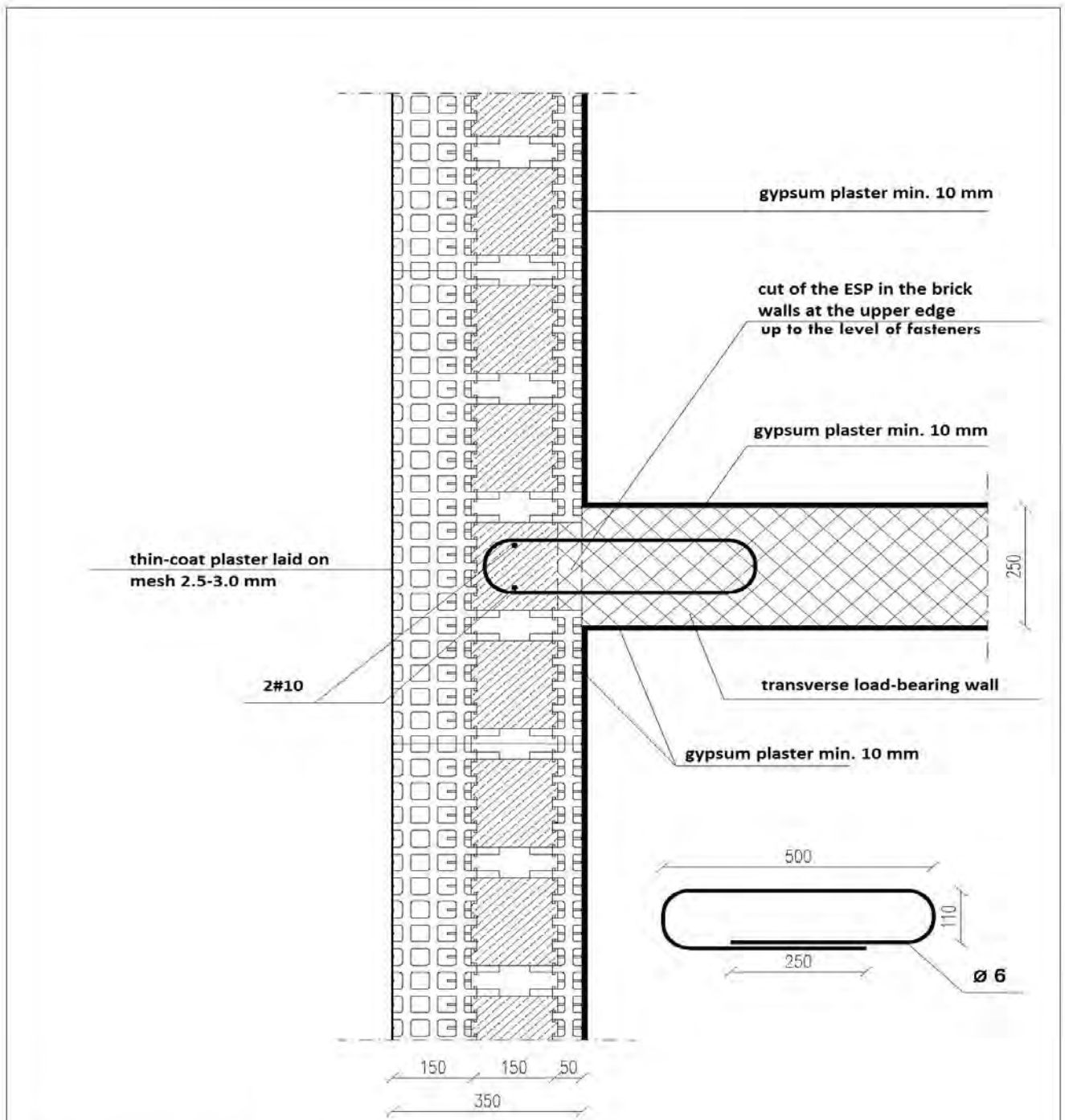

All dimensions given in mm

<p>IZODOM 2000 POLSKA</p>	<p>Attachment no.</p>
<p>THERMAL BRIDGES-DETAIL</p> <p>Connection between external wall and internal load-bearing wall (KING BLOK)</p>	

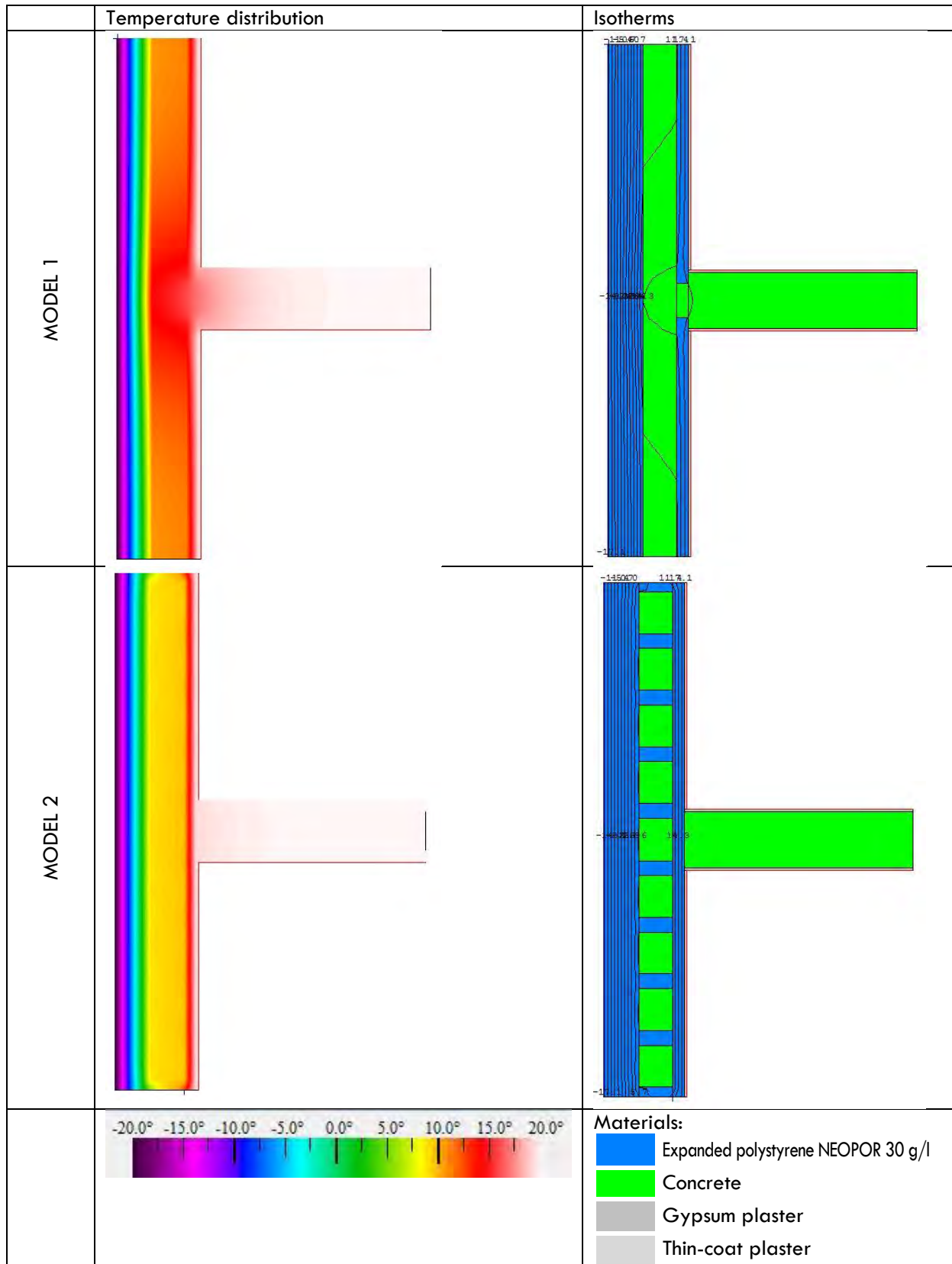

Value of thermal transmittance U_A at the external wall for model 1:

Description	d	λ	R	U
	[m]	[W/mK]	[m ² K/W]	[W/m ² K]
Thermal resistance on the internal side			0.13	
Gypsum plaster	0.01	0.4	0.025	
Expanded polystyrene NEOPOR 30 g/l	0.05	0.031	1.613	
Concrete	0.15	1.7	0.088	
Expanded polystyrene NEOPOR 30 g/l	0.15	0.031	4.839	
Thin-coat mineral plaster	0.005	1.0	0.005	
Thermal resistance on the external side			0.04	
Total thickness	0.47		6.740	0.148

Value of linear thermal transmittance Ψ_1 calculated for model 1:

	U-factor W/m ² K	delta T C	Length mm
Edge	0.1638	40.0	2270

U = 0.164 [W/m²K]
L = 2.27 [m]

$U_A = 0.148$ [W/m²K]
 $L_A = 2.27$ [m]

$$\Psi_1 = 0.164 * 2.27 - 0.148 * 2.27 = 0.036 \text{ [W/mK]}$$

Value of thermal transmittance U at the external wall for model 2:

Total thermal resistance

	R-Value m ² K/W	delta T C	Length mm
Edge	6.8086	40.0	2270

R = 6.8086 m²K/W

	U-factor W/m ² K	delta T C	Length mm
Edge	0.1469	40.0	2270

$U_A = 1 / R = 0.147$ W/m²K

Value of linear thermal transmittance Ψ_2 calculated for model 2:

	U-factor W/m ² K	delta T C	Length mm
Edge	0.1470	40.0	2270

U = 0.147 [W/m²K]
L = 2.27 [m]
 $U_A = 0.147$ [W/m²K]
 $L_A = 2.27$ [m]

$$\Psi_2 = 0.15 * 2.27 - 0.15 * 2.27 = 0.0 \text{ [W/mK]}$$

Resultant linear thermal transmittance Ψ_e for the entire element (weighted with the length, at which the bridge occurs):

Length (width) at which the bridge occurs for model 1 $l_1 = 0.13$ m

Length (width) at which the bridge occurs for model 2 $l_2 = 0.12$ m

$$\Psi_e = (\Psi_1 * l_1 + \Psi_2 * l_2) / (l_1 + l_2) = (0.036 * 0.13 + 0.0 * 0.12) / (0.13 + 0.12)$$

$$\Psi_e = 0.017 \text{ [W/mK]}$$

Design temperature factor at the internal surface f_{Rsi} :

The minimum temperature θ_{si} at the internal surface of wall, obtained from the software, is 17.7 °C.

$$f_{Rsi} = (\theta_{si} - \theta_e) / (\theta_i - \theta_e) = (17.7 - (-20)) / (20 - (-20)) = 37.7 / 40$$

$$f_{Rsi} = 0.943$$

4.Connection between external wall and partition wall (Super King Blok)

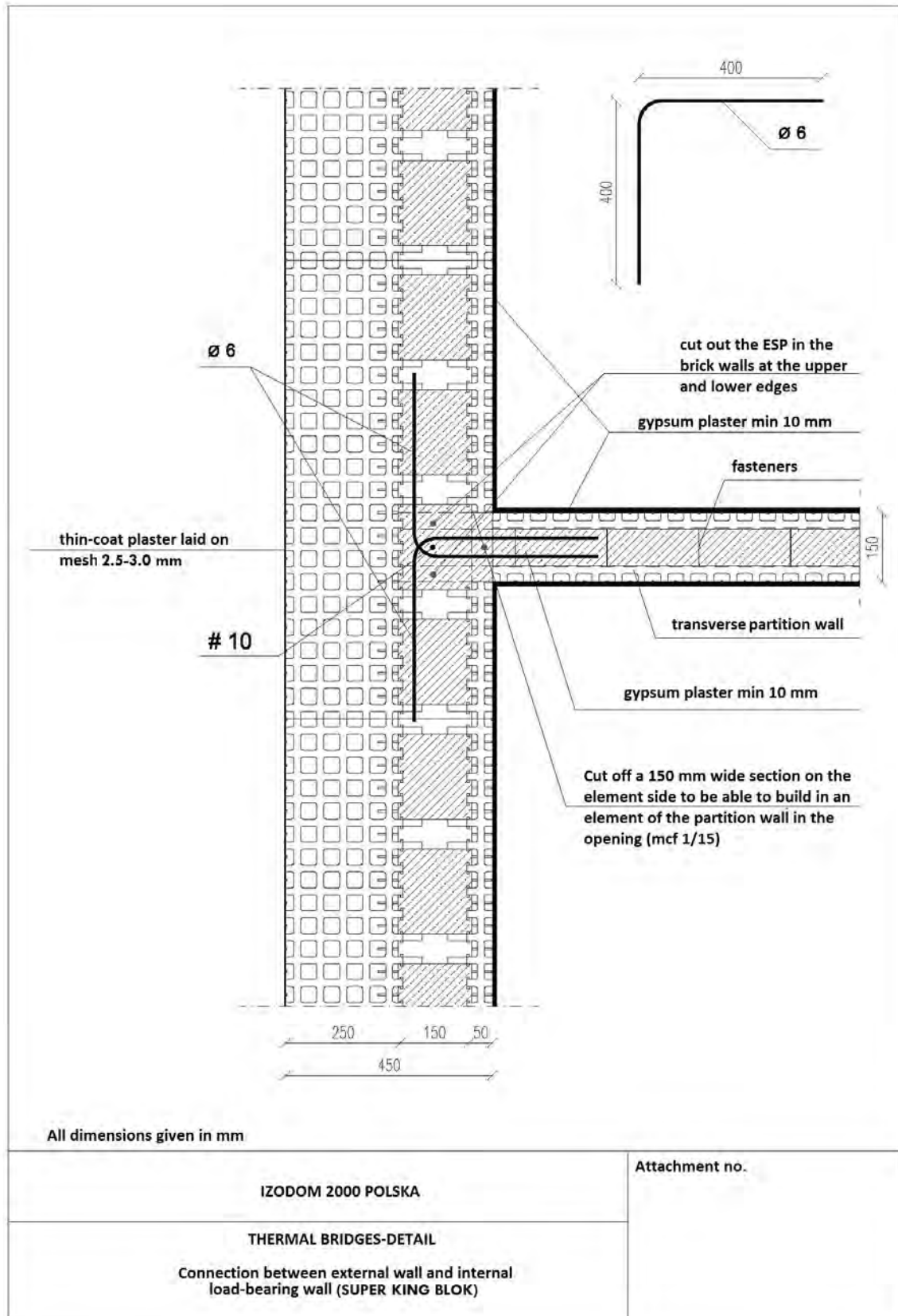

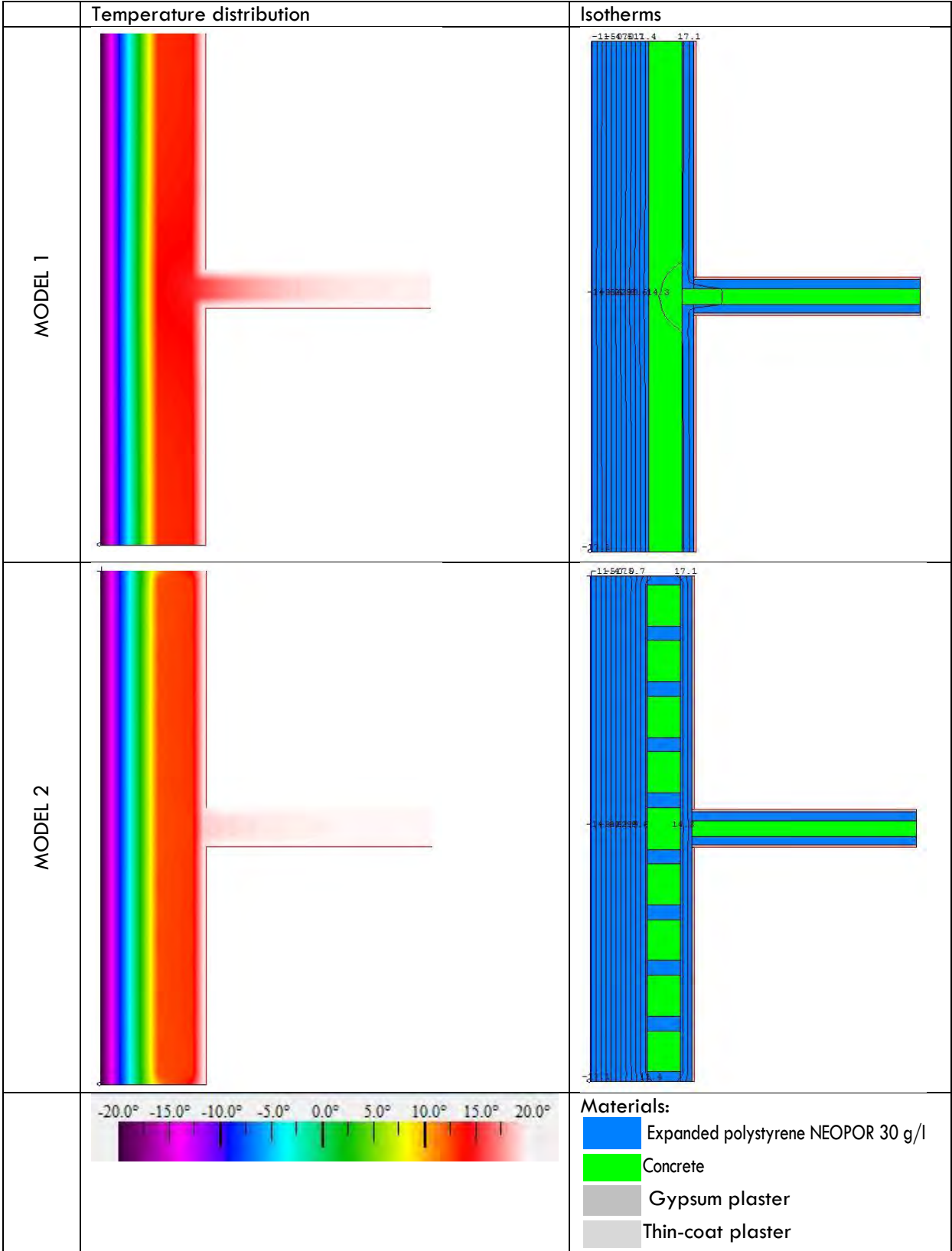

Value of thermal transmittance U_A at the external wall for model 1:

Description	d	λ	R	U
	[m]	[W/mK]	[m ² K/W]	[W/m ² K]
Thermal resistance on the internal side			0.13	
Gypsum plaster	0.01	0.4	0.025	
Expanded polystyrene NEOPOR 30 g/l	0.05	0.031	1.613	
Concrete	0.15	1.7	0.088	
Expanded polystyrene NEOPOR 30 g/l	0.25	0.031	8.065	
Thin-coat mineral plaster	0.005	1.0	0.005	
Thermal resistance on the external side			0.04	
Total thickness	0.47		9.966	0.100

Value of linear thermal transmittance Ψ_1 calculated for model 1:

	U-factor W/m ² K	delta T C	Length mm
Edge	0.1032	40.0	2270

L = 2.27 [m]
 $U_A = 0.103$ [W/m²K]
 $L_A = 2.27$ [m]

$U = 0.100$ [W/m²K]

$$\Psi_1 = 0.100 * 2.27 - 0.103 * 2.27 = -0.007 \text{ [W/mK]}$$

Value of thermal transmittance U at the external wall for model 2:

Total thermal resistance

	R-Value m ² K/W	delta T C	Length mm
Edge	10.0231	40.0	2270

$R = 10.0231$ m²K/W

	U-factor W/m ² K	delta T C	Length mm
Edge	0.0998	40.0	2270

$U_A = 1 / R = 0.0998$ W/m²K

Value of linear thermal transmittance Ψ_2 calculated for model 2:

	U-factor W/m ² K	delta T C	Length mm
Edge	0.0997	40.0	2270

$U = 0.0998$ [W/m²K]

$L = 2.27$ [m]

$U_A = 0.0997$ [W/m²K]

$L_A = 2.27$ [m]

$$\Psi_2 = 0.0998 * 2.27 - 0.0997 * 2.27 = 0,0 \text{ [W/mK]}$$

Resultant linear thermal transmittance Ψ_e for the entire element (weighted with the length, at which the bridge occurs):

Length (width) at which the bridge occurs for model 1 $l_1 = 0.13$ m

Length (width) at which the bridge occurs for model 2 $l_2 = 0.12$ m

$$\Psi_e = (\Psi_1 * l_1 + \Psi_2 * l_2) / (l_1 + l_2) = (-0.007 * 0.13 + 0 * 0.12) / (0.13 + 0.12)$$

$$\Psi_e = -0.003 \text{ [W/mK]}$$

Design temperature factor at the internal surface f_{Rsi} :

The minimum temperature θ_{si} at the internal surface of wall, obtained from the software, is 18.9 °C.

$$f_{Rsi} = (\theta_{si} - \theta_e) / (\theta_i - \theta_e) = (18.9 - (-20)) / (20 - (-20)) = 38.9 / 40$$

$$f_{Rsi} = 0.973$$

5.Connection between external wall and internal load-bearing wall (King Blok)

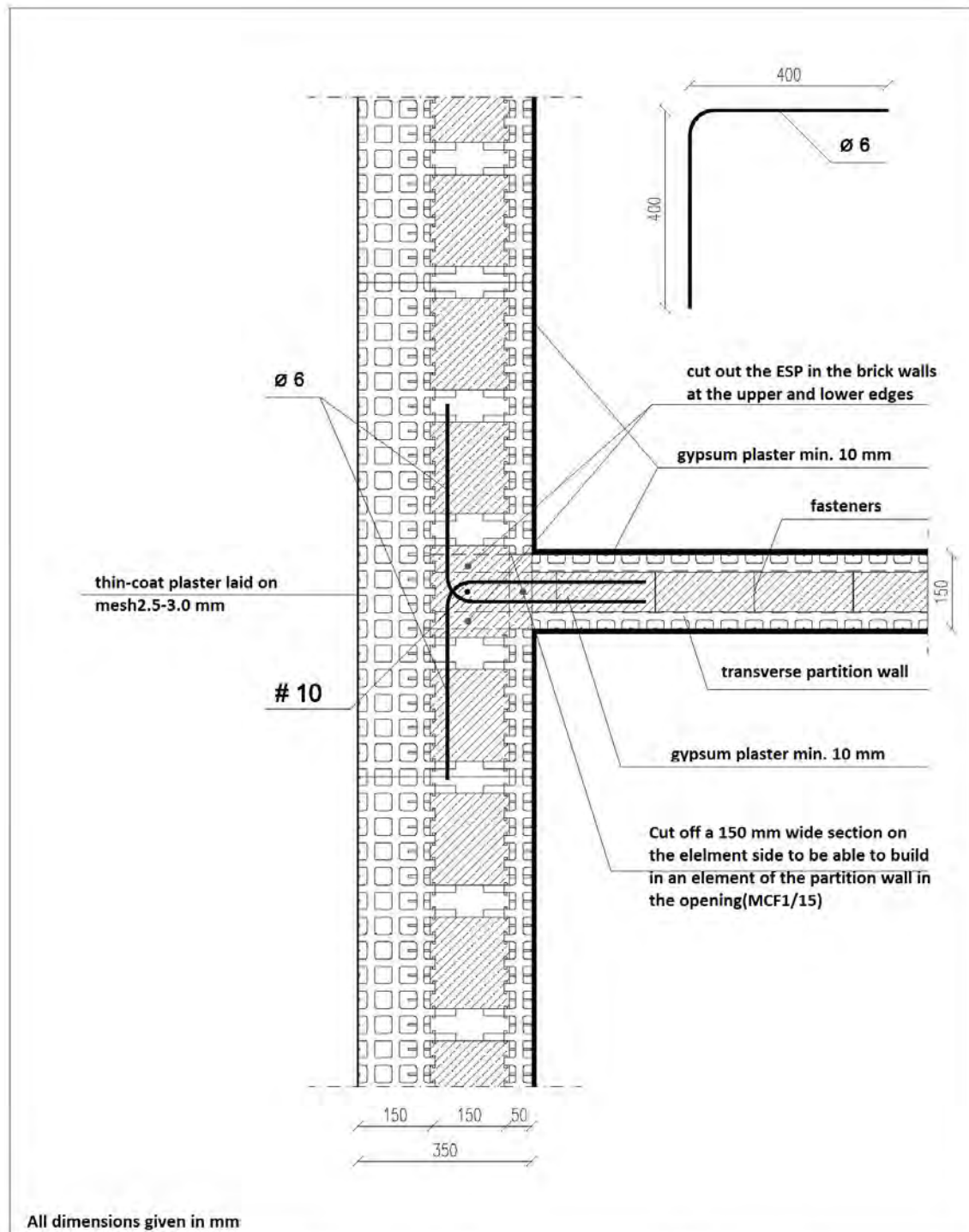

<p>IZODOM 2000 POLSKA</p>	<p>Attachment no.</p>
<p>THERMAL BRIDGES-DETAIL</p> <p>Connection between external wall and internal load-bearing wall (KING BLOK)</p>	

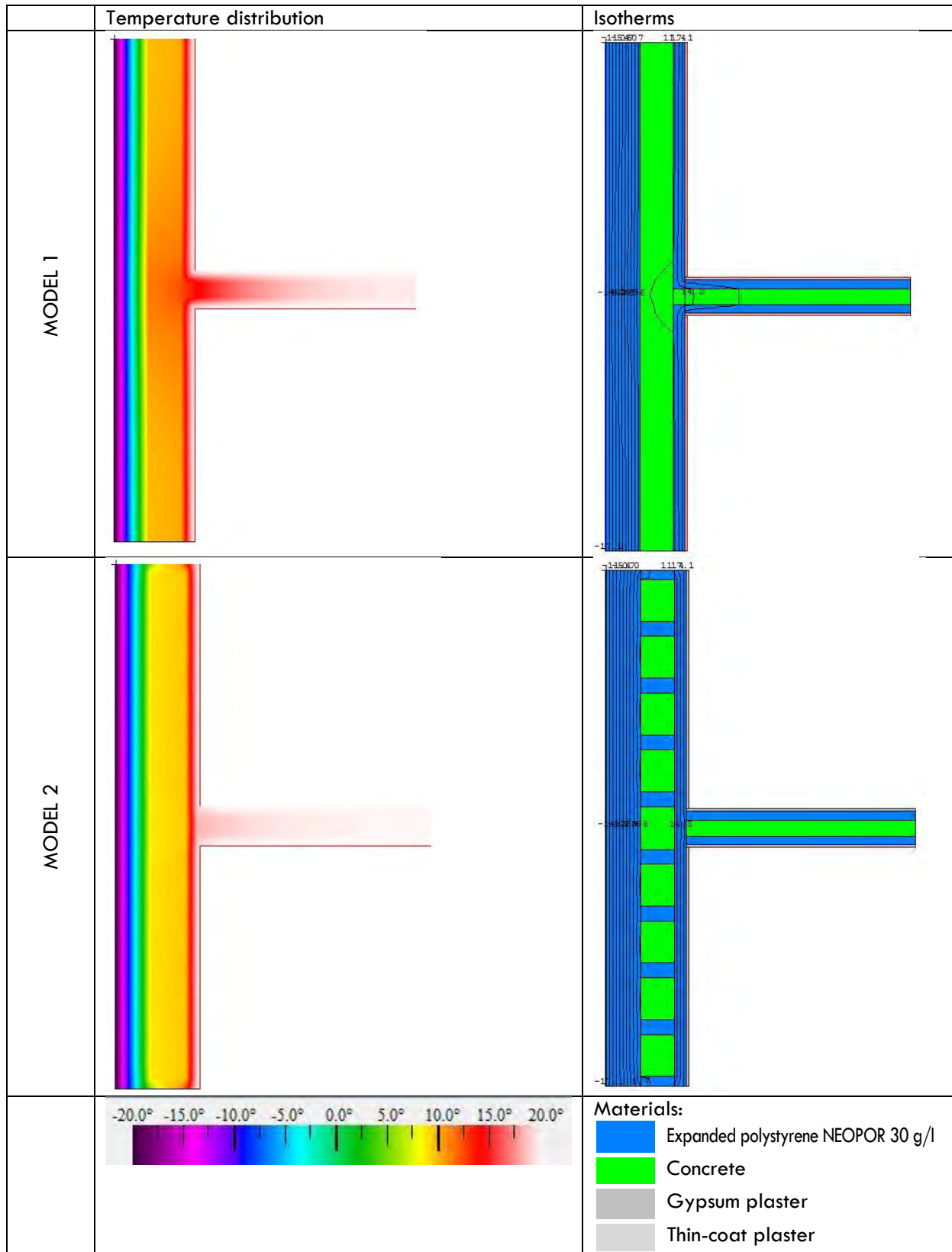

Value of thermal transmittance U_A at the external wall for model 1:

Description	d	λ	R	U
	[m]	[W/mK]	[m ² K/W]	[W/m ² K]
Thermal resistance on the internal side			0.13	
Gypsum plaster	0.01	0.4	0.025	
Expanded polystyrene NEOPOR 30 g/l	0.05	0.031	1.613	
Concrete	0.15	1.7	0.088	
Expanded polystyrene NEOPOR 30 g/l	0.15	0.031	4.839	
Thin-coat mineral plaster	0.005	1.0	0.005	
Thermal resistance on the external side			0.04	
Total thickness	0.47		6.740	0.148

Value of linear thermal transmittance Ψ_1 calculated for model 1:

	U-factor W/m ² K	delta T C	Length mm
Edge	0.1547	40.0	2270

$$U = 0.155 \text{ [W/m}^2\text{K]}$$

$$L = 2.27 \text{ [m]}$$

$$U_A = 0.148 \text{ [W/m}^2\text{K]}$$

$$L_A = 2.27 \text{ [m]}$$

$$\Psi_1 = 0.155 * 2.27 - 0.148 * 2.27 = 0.016 \text{ [W/mK]}$$

Value of thermal transmittance U at the external wall for model 2:

Total thermal resistance

	R-Value m ² K/W	delta T C	Length mm
Edge	6.8086	40.0	2270

$$R = 6.8086 \text{ m}^2\text{K/W}$$

	U-factor W/m ² K	delta T C	Length mm
Edge	0.1469	40.0	2270

$$U_A = 1 / R = 0.147 \text{ W/m}^2\text{K}$$

Value of linear thermal transmittance Ψ_2 calculated for model 2:

	U-factor W/m ² K	delta T C	Length mm
Edge	0.1470	40.0	2270

$$U = 0.147 \text{ [W/m}^2\text{K]}$$

$$L = 2.27 \text{ [m]}$$

$$U_A = 0.147 \text{ [W/m}^2\text{K]}$$

$$L_A = 2.27 \text{ [m]}$$

$$\Psi_2 = 0.147 * 2.27 - 0.147 * 2.27 = 0,0 \text{ [W/mK]}$$

Resultant linear thermal transmittance Ψ_e for the entire element (weighted with the length, at which the bridge occurs):

Length (width) at which the bridge occurs for model 1 $l_1 = 0.13 \text{ m}$

Length (width) at which the bridge occurs for model 2 $l_2 = 0.12 \text{ m}$

$$\Psi_e = (\Psi_1 * l_1 + \Psi_2 * l_2) / (l_1 + l_2) = (0,016*0.13+0.0*0.12)/(0.13+0.12)$$

$$\Psi_e = 0.008 \text{ [W/mK]}$$

Design temperature factor at the internal surface f_{Rsi} :

The minimum temperature θ_{si} at the internal surface of wall, obtained from the software, is 18.4 °C.

$$f_{Rsi} = (\theta_{si} - \theta_e) / (\theta_i - \theta_e) = (18.5 - (-20)) / (20 - (-20)) = 38.4 / 40$$

$$f_{Rsi} = 0.960$$

6.Connection between external wall and flat roof (Super King Blok)

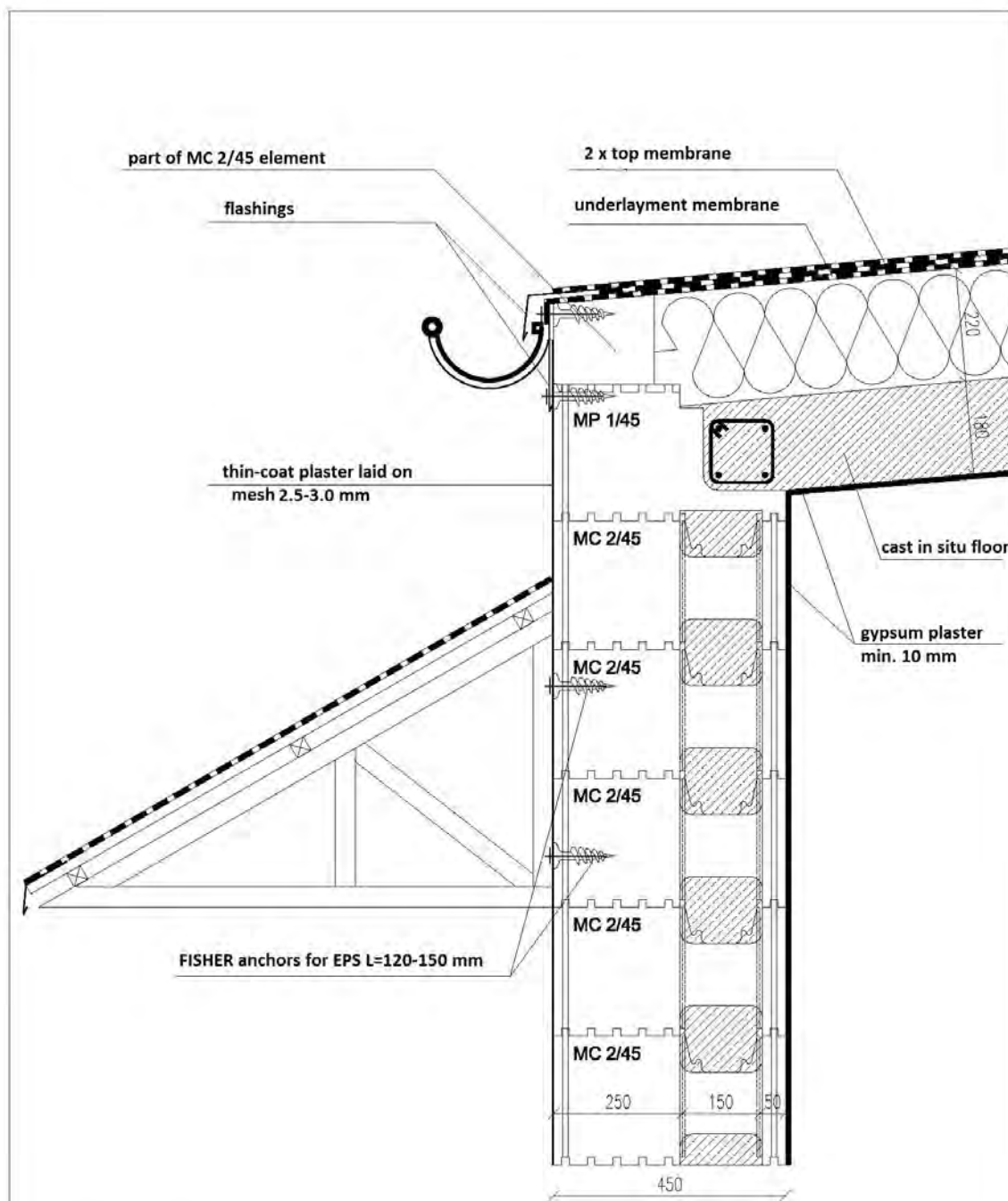

All dimensions given in mm

<p>IZODOM 2000 POLSKA</p>	<p>Attachment no.</p>
<p>THERMAL BRIDGES-DETAIL</p> <p>Connection between external wall and flat roof (SUPER KING BLOK)</p>	

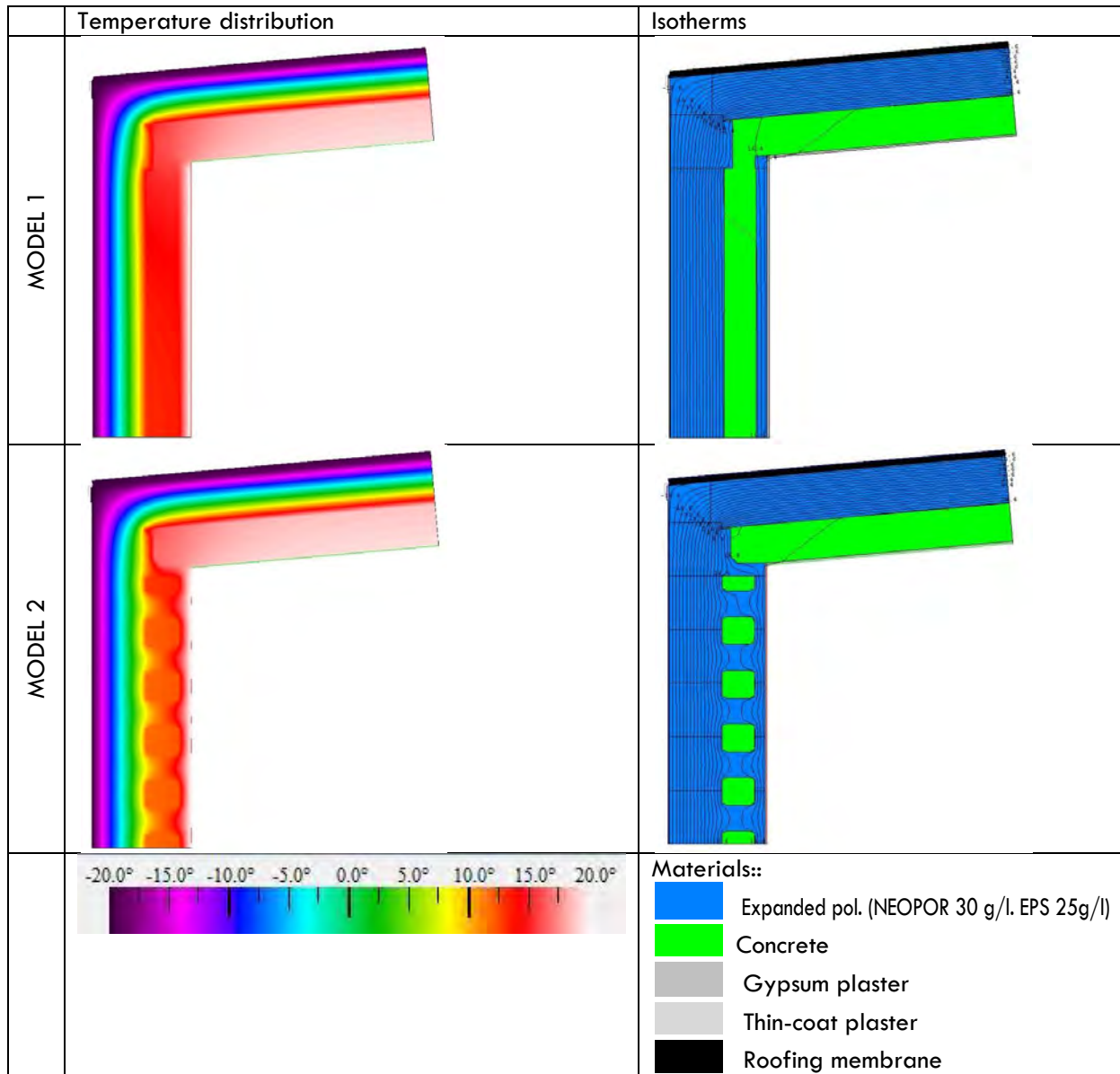

Value of thermal transmittance U_A at the external wall for model 1:

Description	d	λ	R	U
	[m]	[W/mK]	[m ² K/W]	[W/m ² K]
Thermal resistance on the internal side			0.13	
Gypsum plaster	0.01	0.4	0.025	
Expanded polystyrene NEOPOR 30 g/l	0.05	0.031	1.613	
Concrete	0.15	1.7	0.088	
Expanded polystyrene NEOPOR 30 g/l	0.25	0.031	8.065	
Thin-coat mineral plaster	0.005	1.0	0.005	
Thermal resistance on the external side			0.04	
Total thickness	0.47		9.966	0.100

Value of thermal transmittance U_B at the slab roof for model 1:

Description	d	λ	R	U
	[m]	[W/mK]	[m ² K/W]	[W/m ² K]
Thermal resistance on the internal side			0.10	
Gypsum plaster	0.01	0.4	0.025	
Concrete	0.18	1.7	0.106	
Expanded polystyrene EPS 25 g/l	0.22	0.034	6.471	
3 x roofing membrane	0.03	0.18	0.167	
Thin-coat mineral plaster	0.005	1.0	0.005	
Thermal resistance on the external side			0.04	
Total thickness	0.45		6.913	0.145

Value of linear thermal transmittance Ψ_1 calculated for model 1:

	U-factor W/m ² K	delta T C	Length mm
Edge	0.1090	40.0	3281.09

$$U_A = 0.100 \text{ [W/m}^2\text{K]}$$

$$L_A = 1.705 \text{ [m]}$$

$$U_B = 0.145 \text{ [W/m}^2\text{K]}$$

$$L_B = 1.576 \text{ [m]}$$

$$U = 0.109 \text{ [W/m}^2\text{K]}$$

$$L = 3.28 \text{ [m]}$$

$$\Psi_1 = 0.109 * 3.28 - 0.100 * 1.705 - 0.145 * 1.576 = -0.042 \text{ [W/mK]}$$

Value of thermal transmittance U at the external wall for model 2:

Total thermal resistance

	R-Value m ² K/W	delta T C	Length mm
Edge	10.6938	40.0	1250

$$R = 10.6938 \text{ m}^2\text{K/W}$$

	U-factor W/m ² K	delta T C	Length mm
Edge	0.0935	40.0	1250

$$U_A = 1 / R = 0.094 \text{ W/m}^2$$

Value of thermal transmittance U_B at the slab roof for model 2:

Description	d	λ	R	U
	[m]	[W/mK]	[m ² K/W]	[W/m ² K]
Thermal resistance on the internal side			0.10	
Gypsum plaster	0.01	0.4	0.025	
Concrete	0.18	1.7	0.106	
Expanded polystyrene EPS 25 g/l	0.22	0.034	6.471	
3 x roofing membrane	0.03	0.18	0.167	
Thin-coat mineral plaster	0.005	1.0	0.005	
Thermal resistance on the external side			0.04	
Total thickness	0.45		6.913	0.145

Value of linear thermal transmittance Ψ_2 calculated for model 2:

	U-factor W/m ² K	delta T C	Length mm
Edge	0.1055	40.0	3278.73

$$U = 0.106 \text{ [W/m}^2\text{K]}$$

$$L = 3.28 \text{ [m]}$$

$$U_A = 0.094 \text{ [W/m}^2\text{K]}$$

$$L_A = 1.705 \text{ [m]}$$

$$U_b = 0.145 \text{ [W/m}^2\text{K]}$$

$$L_b = 1.576 \text{ [m]}$$

$$\Psi_2 = 0.106 * 3.28 - 0.094 * 1.705 - 0.145 * 1.576 = -0.041 \text{ [W/mK]}$$

Resultant linear thermal transmittance Ψ_e for the entire element (weighted with the length, at which the bridge occurs):

Length (width) at which the bridge occurs for model 1 $l_1 = 0.185 \text{ m}$

Length (width) at which the bridge occurs for model 2 $l_2 = 0.065 \text{ m}$

$$\Psi_e = (\Psi_1 * l_1 + \Psi_2 * l_2) / (l_1 + l_2) = (-0.042 * 0.185 - 0.041 * 0.065) / (0.185 + 0.065)$$

$$\Psi_e = -0.042 \text{ [W/mK]}$$

Design temperature factor at the internal surface f_{Rsi} :

The minimum temperature θ_{si} at the internal surface of wall, obtained from the software, is $16.6 \text{ }^\circ\text{C}$.

$$f_{Rsi} = (\theta_{si} - \theta_e) / (\theta_i - \theta_e) = (16,6 - (-20)) / (20 - (-20)) = 36.6 / 40$$

$$f_{Rsi} = 0.908$$

7.Connection between external wall and flat roof (King Blok)

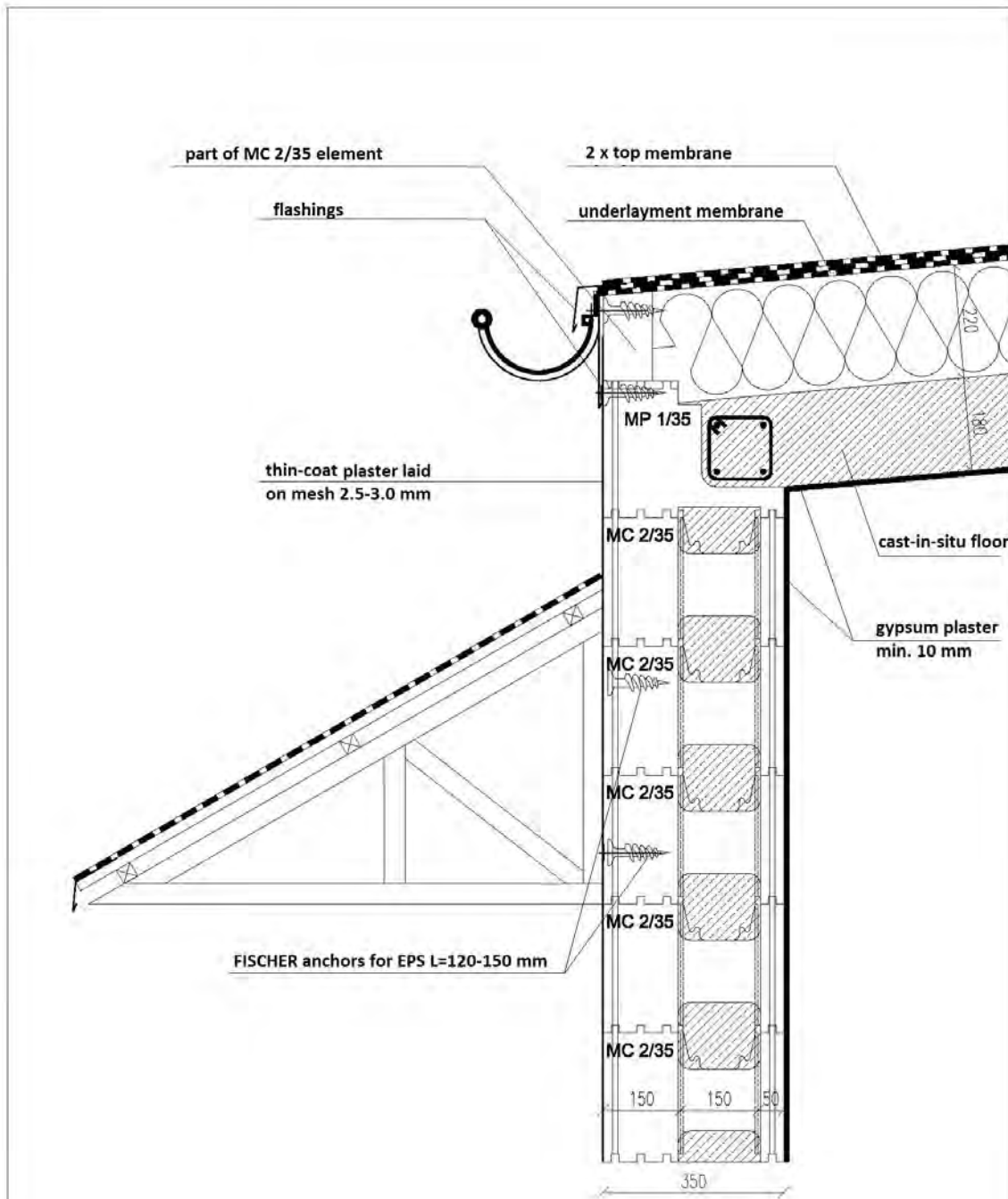

All dimensions given in mm

<p>IZODOM 2000 POLSKA</p>	<p>Attachment no.</p>
<p>THERMAL BRIDGES-DETAIL</p> <p>Connection between external wall and flat roof (KING BLOK)</p>	

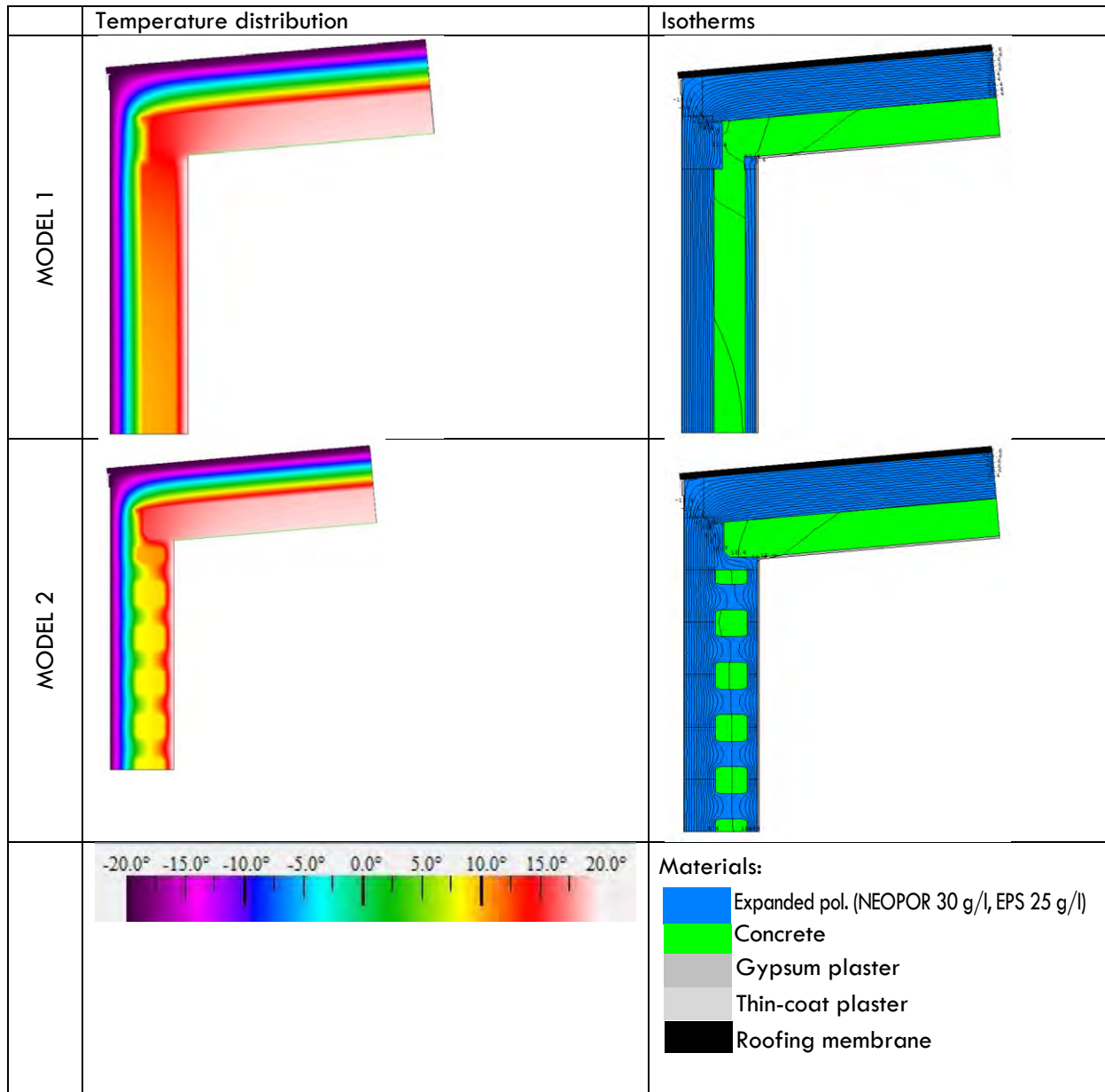

Value of thermal transmittance U_A at the external wall for model 1:

Description	d	λ	R	U
	[m]	[W/mK]	[m ² K/W]	[W/m ² K]
Thermal resistance on the internal side			0.13	
Gypsum plaster	0.01	0.4	0.025	
Expanded polystyrene NEOPOR 30 g/l	0.05	0.031	1.613	
Concrete	0.15	1.7	0.088	
Expanded polystyrene NEOPOR 30 g/l	0.15	0.031	4.839	
Thin-coat mineral plaster	0.005	1.0	0.005	
Thermal resistance on the external side			0.04	
Total thickness	0.37		6.740	0.148

Value of thermal transmittance U_B at the slab roof for model 1:

Description	d	λ	R	U
	[m]	[W/mK]	[m ² K/W]	[W/m ² K]
Thermal resistance on the internal side			0.10	
Gypsum plaster	0.01	0.4	0.025	
Concrete	0.18	1.7	0.106	
Expanded polystyrene EPS 25 g/l	0.22	0.034	6.471	
3 x roofing membrane	0.03	0.18	0.167	
Thin-coat mineral plaster	0.005	1.0	0.005	
Thermal resistance on the external side			0.04	
Total thickness	0.45		6.913	0.145

Value of linear thermal transmittance Ψ_1 calculated for model 1:

	U-factor W/m ² K	delta T C	Length mm
Edge	0.1360	40.0	3205.53

$$\begin{aligned}
 U_A &= 0.148 \text{ [W/m}^2\text{K]} \\
 L_A &= 1.71 \text{ [m]} \\
 U_B &= 0.145 \text{ [W/m}^2\text{K]} \\
 L_B &= 1.48 \text{ [m]}
 \end{aligned}$$

$$\begin{aligned}
 U &= 0.136 \text{ [W/m}^2\text{K]} \\
 L &= 3.21 \text{ [m]}
 \end{aligned}$$

$$\Psi_1 = 0.136 * 3.21 - 0.148 * 1.71 - 0.145 * 1.48 = -0.031 \text{ [W/mK]}$$

Value of thermal transmittance U at the external wall for model 2:

Total thermal resistance

	R-Value m ² K/W	delta T C	Length mm
Edge	7.4674	40.0	1250

$$R = 7.2443 \text{ m}^2\text{K/W}$$

	U-factor W/m ² K	delta T C	Length mm
Edge	0.1339	40.0	1250

$$U_A = 1 / R = 0.134 \text{ W/m}^2\text{K}$$

Value of thermal transmittance U_B at the slab roof for model 2:

Description	d	λ	R	U
	[m]	[W/mK]	[m ² K/W]	[W/m ² K]
Thermal resistance on the internal side			0.10	
Gypsum plaster	0.01	0.4	0.025	
Concrete	0.18	1.7	0.106	
Expanded polystyrene EPS 25 g/l	0.22	0.034	6.471	
3 x roofing membrane	0.03	0.18	0.167	
Thin-coat mineral plaster	0.005	1.0	0.005	
Thermal resistance on the external side			0.04	
Total thickness	0.45		6.913	0.145

Value of linear thermal transmittance Ψ_2 calculated for model 2:

	U-factor W/m ² K	delta T C	Length mm
Edge	0.1275	40.0	3204.66

$$U = 0.128 \text{ [W/m}^2\text{K]}$$

$$L = 3.2 \text{ [m]}$$

$$U_A = 0.134 \text{ [W/m}^2\text{K]}$$

$$L_A = 1.71 \text{ [m]}$$

$$U_B = 0.145 \text{ [W/m}^2\text{K]}$$

$$L_B = 1.48 \text{ [m]}$$

$$\Psi_2 = 0.128 * 3.2 - 0.134 * 1.71 - 0.145 * 1.48 = -0.034 \text{ [W/mK]}$$

Resultant linear thermal transmittance Ψ_e for the entire element (weighted with the length, at which the bridge occurs):

Length (width) at which the bridge occurs for model 1 $l_1 = 0.185 \text{ m}$

Length (width) at which the bridge occurs for model 2 $l_2 = 0.065 \text{ m}$

$$\Psi_e = (\Psi_1 * l_1 + \Psi_2 * l_2) / (l_1 + l_2) = (-0.031 * 0.185 - 0.034 * 0.065) / (0.185 + 0.065) \\ \Psi_e = -0.032 \text{ [W/mK]}$$

Design temperature factor at the internal surface f_{Rsi} :

The minimum temperature θ_{si} at the internal surface of wall, obtained from the software, is 15.7 °C.

$$f_{Rsi} = (\theta_{si} - \theta_e) / (\theta_i - \theta_e) = (15.7 - (-20)) / (20 - (-20)) = 35.7 / 40$$

$$f_{Rsi} = 0.893$$

8.Connection between external wall with flat roof and parapet wall (Super King Blok)

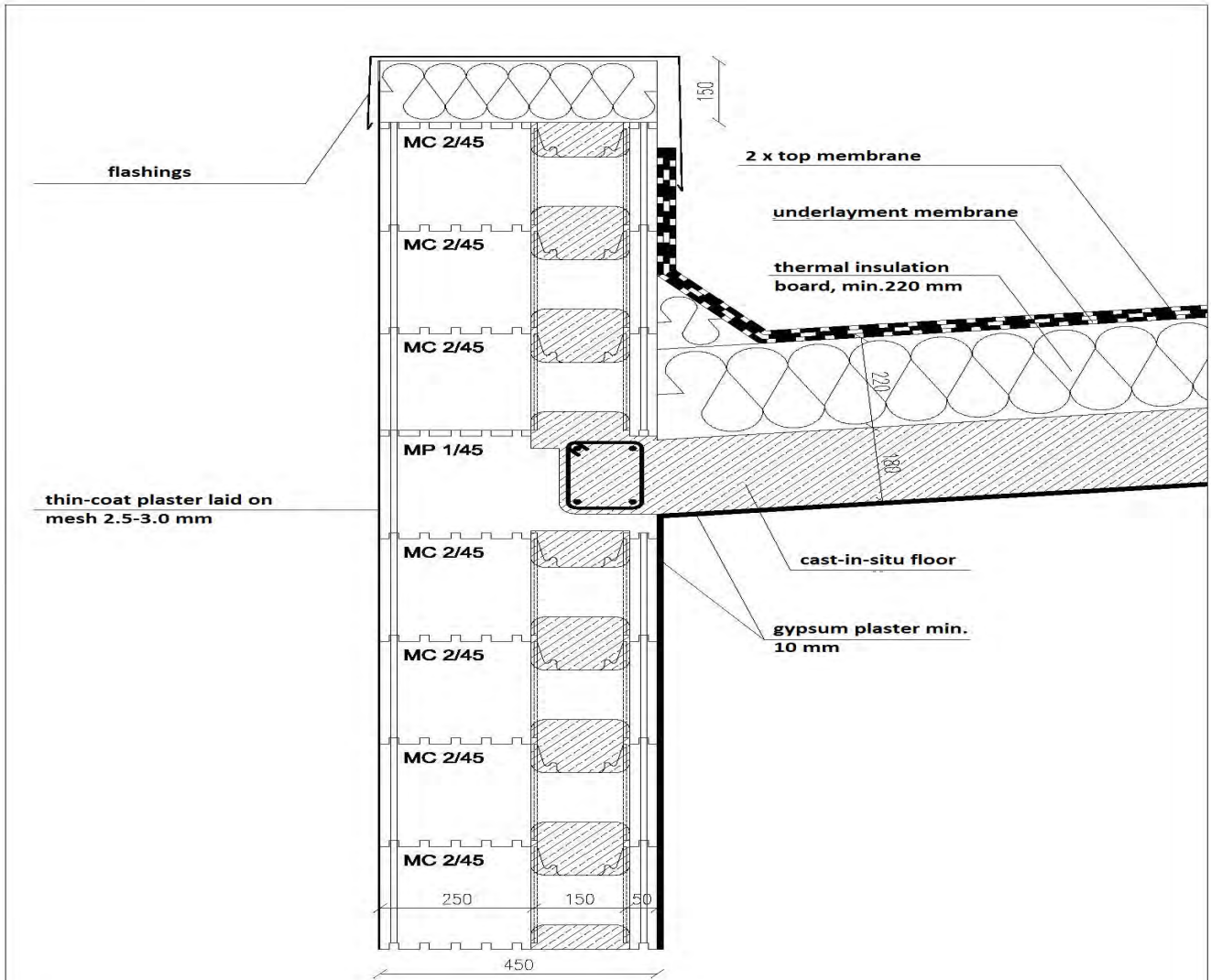

All dimensions given in mm

<p>IZODOM 2000 POLSKA</p>	<p>Attachment no.</p>
<p>THERMAL BRIDGES-DETAIL Connection between external wall flat roof and parapet wall (SUPER KING BLOK)</p>	

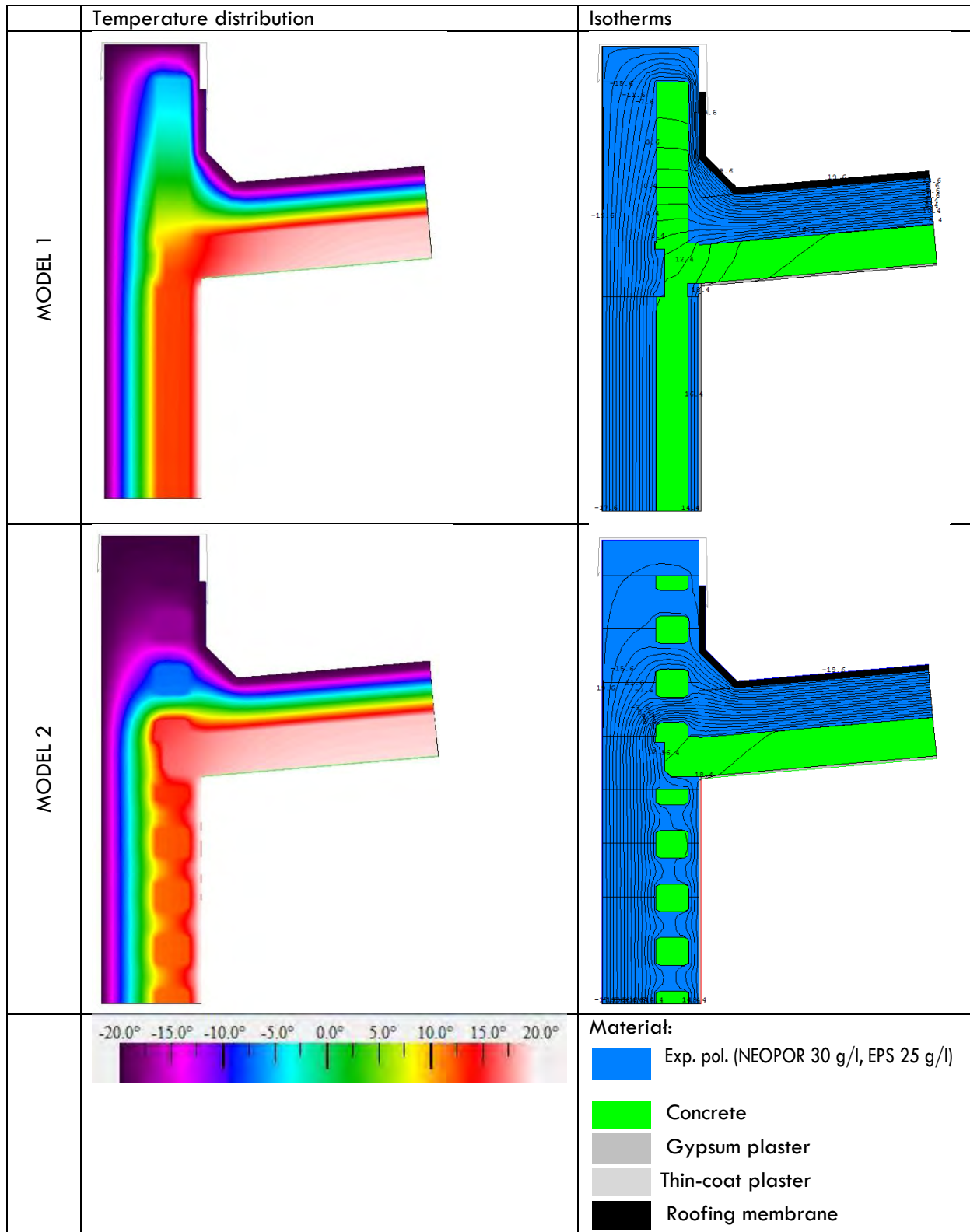

Value of thermal transmittance U_A at the external wall for model 1:

Description	d	λ	R	U
	[m]	[W/mK]	[m ² K/W]	[W/m ² K]
Thermal resistance on the internal side			0.13	
Gypsum plaster	0.01	0.4	0.025	
Expanded polystyrene NEOPOR 30 g/l	0.05	0.031	1.613	
Concrete	0.15	1.7	0.088	
Expanded polystyrene NEOPOR 30 g/l	0.25	0.031	8.065	
Thin-coat mineral plaster	0.005	1.0	0.005	
Thermal resistance on the external side			0.04	
Total thickness	0.47		9.966	0.100

Value of thermal transmittance U_B at the slab roof for model 1:

Description	d	λ	R	U
	[m]	[W/mK]	[m ² K/W]	[W/m ² K]
Thermal resistance on the internal side			0.10	
Gypsum plaster	0.01	0.4	0.025	
Concrete	0.18	1.7	0.106	
Expanded polystyrene EPS 25 g/l	0.22	0.034	6.471	
3 x roofing membrane	0.03	0.18	0.167	
Thin-coat mineral plaster	0.005	1.0	0.005	
Thermal resistance on the external side			0.04	
Total thickness	0.45		6.913	0.145

Value of linear thermal transmittance Ψ_1 calculated for model 1:

	U-factor W/m ² K	delta T C	Length mm
Edge	0.2125	40.0	2154.67

$$U = 0.213 \text{ [W/m}^2\text{K]}$$

$$L = 2.15 \text{ [m]}$$

$$U_A = 0.100 \text{ [W/m}^2\text{K]}$$

$$L_A = 2.17 \text{ [m]}$$

$$U_B = 0.145 \text{ [W/m}^2\text{K]}$$

$$L_B = 1.53 \text{ [m]}$$

$$\Psi_1 = 0.213 * 2.15 - 0.100 * 2.17 - 0.145 * 1.53 = 0.019 \text{ [W/mK]}$$

Value of thermal transmittance U at the external wall for model 2:

Total thermal resistance

	R-Value m ² K/W	delta T C	Length mm
Edge	10.6938	40.0	1250

$$R = 10.6938 \text{ m}^2\text{K/W}$$

	U-factor W/m ² K	delta T C	Length mm
Edge	0.0935	40.0	1250

$$U_A = 1 / R = 0.094 \text{ W/m}^2\text{K}$$

Value of thermal transmittance U_B at the slab roof for model 2:

Description	d	λ	R	U
	[m]	[W/mK]	[m ² K/W]	[W/m ² K]
Thermal resistance on the internal side			0.10	
Gypsum plaster	0.01	0.4	0.025	
Concrete	0.18	1.7	0.106	
Expanded polystyrene EPS 25 g/l	0.22	0.034	6.471	
3 x roofing membrane	0.03	0.18	0.167	
Thin-coat mineral plaster	0.005	1.0	0.005	
Thermal resistance on the external side			0.04	
Total thickness	0.45		6.913	0.145

Value of linear thermal transmittance Ψ_2 calculated for model 2:

	U-factor W/m ² K	delta T C	Length mm
Edge	0.1463	40.0	2154.67

$U = 0.146$ [W/m²K]
 $L = 2.15$ [m]
 $U_A = 0.10$ [W/m²K]
 $L_A = 2.17$ [m]
 $U_B = 0.15$ [W/m²K]
 $L_B = 1.53$ [m]

$$\Psi_2 = 0.146 * 2.15 - 0.094 * 2.17 - 0.145 * 1.53 = -0.112 \text{ [W/mK]}$$

Resultant linear thermal transmittance Ψ_e for the entire element (weighted with the length, at which the bridge occurs):

Length (width) at which the bridge occurs for model 1 $l_1 = 0.185$ m

Length (width) at which the bridge occurs for model 2 $l_2 = 0.065$ m

$$\Psi_e = (\Psi_1 * l_1 + \Psi_2 * l_2) / (l_1 + l_2) = (0.019 * 0.185 - 0.112 * 0.065) / (0.185 + 0.065)$$

$$\Psi_e = -0.015 \text{ [W/mK]}$$

Design temperature factor at the internal surface f_{Rsi} :

The minimum temperature θ_{si} at the internal surface of wall, obtained from the software, is 13.9 °C.

$$f_{Rsi} = (\theta_{si} - \theta_e) / (\theta_i - \theta_e) = (16.1 - (-20)) / (20 - (-20)) = 33.9 / 40$$

$$f_{Rsi} = 0.848$$

9.Connection between external wall and flat roof (King Blok)

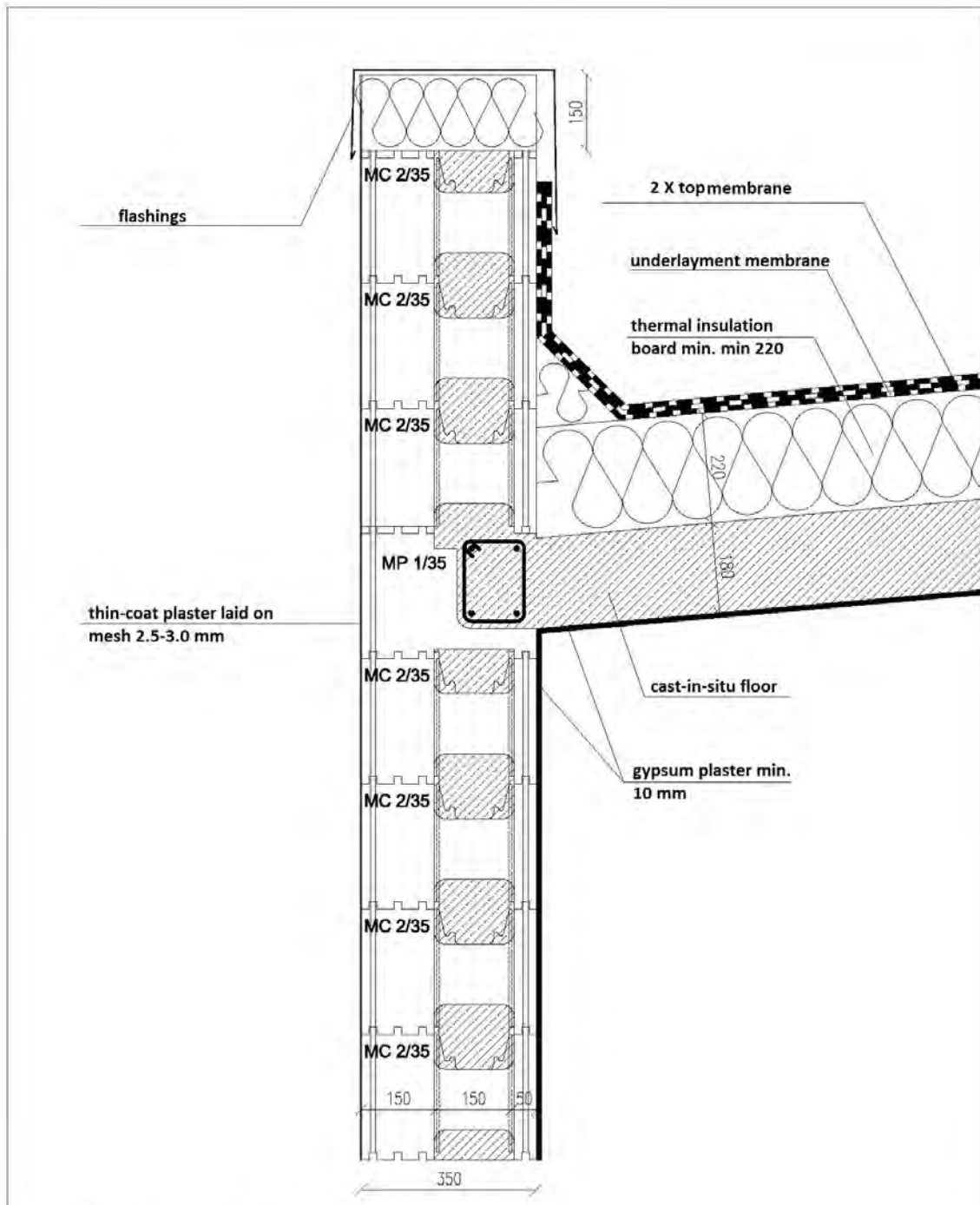

All dimensions given in mm

<p>IZODOM 2000 POLSKA</p>	<p>Attachment no.</p>
<p>THERMAL BRIDGES-DETAIL</p> <p>Connection between external wall with flat roof and parapet wall (KING BLOK)</p>	

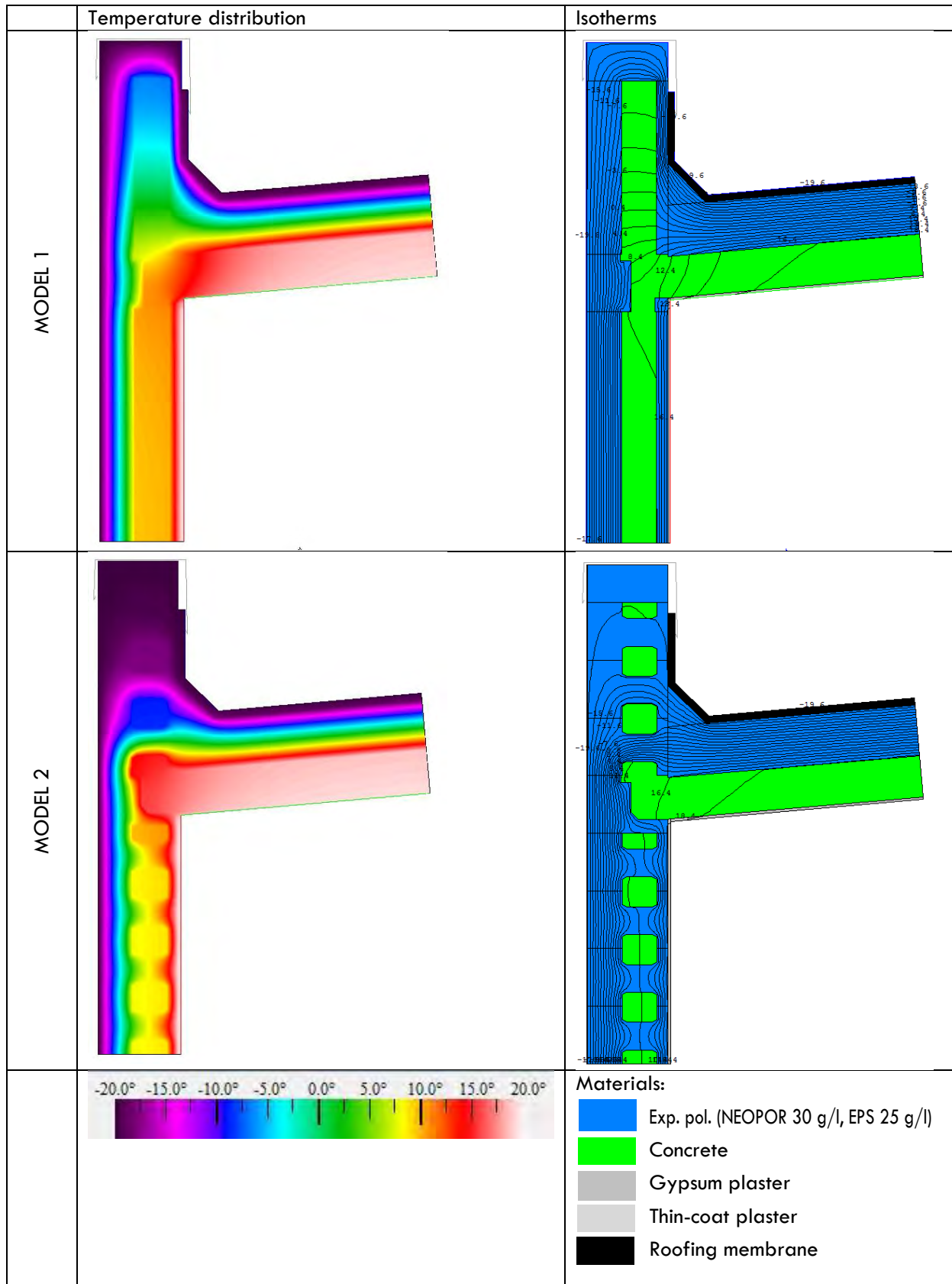

Value of thermal transmittance U_A at the external wall for model 1:

Description	d	λ	R	U
	[m]	[W/mK]	[m ² K/W]	[W/m ² K]
Thermal resistance on the internal side			0.13	
Gypsum plaster	0.01	0.4	0.025	
Expanded polystyrene NEOPOR 30 g/l	0.05	0.031	1.613	
Concrete	0.15	1.7	0.088	
Expanded polystyrene NEOPOR 30 g/l	0.15	0.031	4.839	
Thin-coat mineral plaster	0.005	1.0	0.005	
Thermal resistance on the external side			0.04	
Total thickness	0.37		6.740	0.148

Value of thermal transmittance U_B at the slab roof for model 1:

Description	d	λ	R	U
	[m]	[W/mK]	[m ² K/W]	[W/m ² K]
Thermal resistance on the internal side			0.10	
Gypsum plaster	0.01	0.4	0.025	
Concrete	0.18	1.7	0.106	
Expanded polystyrene EPS 25 g/l	0.22	0.034	6.471	
3 x roofing membrane	0.03	0.18	0.167	
Thin-coat mineral plaster	0.005	1.0	0.005	
Thermal resistance on the external side			0.04	
Total thickness	0.45		6.913	0.145

Value of linear thermal transmittance Ψ_1 calculated for model 1:

	U-factor W/m ² K	delta T C	Length mm
Edge	0.2460	40.0	2154.67

$U_A = 0.148$ [W/m²K]
 $L_A = 2.17$ [m]
 $U_B = 0.145$ [W/m²K]
 $L_B = 1.43$ [m]

$U = 0.246$ [W/m²K]
 $L = 2.15$ [m]

$$\Psi_1 = 0.246 * 2.15 - 0.148 * 2.17 - 0.145 * 1.43 = 0.00 \text{ [W/mK]}$$

Value of thermal transmittance U at the external wall for model 2:

Total thermal resistance

	R-Value m ² K/W	delta T C	Length mm
Edge	7.4674	40.0	1250

$R = 7.2443$ m²K/W

	U-factor W/m ² K	delta T C	Length mm
Edge	0.1339	40.0	1250

$U_A = 1 / R = 0.134$ W/m²K

Value of thermal transmittance U_B at the slab roof for model 2:

Description	d	λ	R	U
	[m]	[W/mK]	[m ² K/W]	[W/m ² K]
Thermal resistance on the internal side			0.10	
Gypsum plaster	0.01	0.4	0.025	
Concrete	0.18	1.7	0.106	
Expanded polystyrene EPS 25 g/l	0.22	0.034	6.471	
3 x roofing membrane	0.03	0.18	0.167	
Thin-coat mineral plaster	0.005	1.0	0.005	
Thermal resistance on the external side			0.04	
Total thickness	0.45		6.913	0.145

Value of linear thermal transmittance Ψ_2 calculated for model 2:

	U-factor W/m ² K	delta T C	Length mm
Edge	0.1745	40.0	2154.67

$U = 0.175$ [W/m²K]
 $L = 2.15$ [m]
 $U_A = 0.134$ [W/m²K]
 $L_A = 2.17$ [m]
 $U_B = 0.145$ [W/m²K]
 $L_B = 1.43$ [m]

$$\Psi_2 = 0.175 * 2.15 - 0.134 * 2.17 - 0.145 * 1.43 = -0.122 \text{ [W/mK]}$$

Resultant linear thermal transmittance Ψ_e for the entire element (weighted with the length, at which the bridge occurs)

Length (width) at which the bridge occurs for model 1 $l_1 = 0.185$ m

Length (width) at which the bridge occurs for model 2 $l_2 = 0.065$ m

$$\Psi_e = (\Psi_1 * l_1 + \Psi_2 * l_2) / (l_1 + l_2) = (0.00 * 1.185 - 0.122 * 0.065) / (0.185 + 0.065)$$

$$\Psi_e = -0.032 \text{ [W/mK]}$$

Design temperature factor at the internal surface f_{Rsi} :

The minimum temperature θ_{si} at the internal surface of wall, obtained from the software, is 12.8 °C.

$$f_{Rsi} = (\theta_{si} - \theta_e) / (\theta_i - \theta_e) = (12.8 - (-20)) / (20 - (-20)) = 32.8 / 40$$

$$f_{Rsi} = 0.820$$

10.Knee wall (Super King Blok)

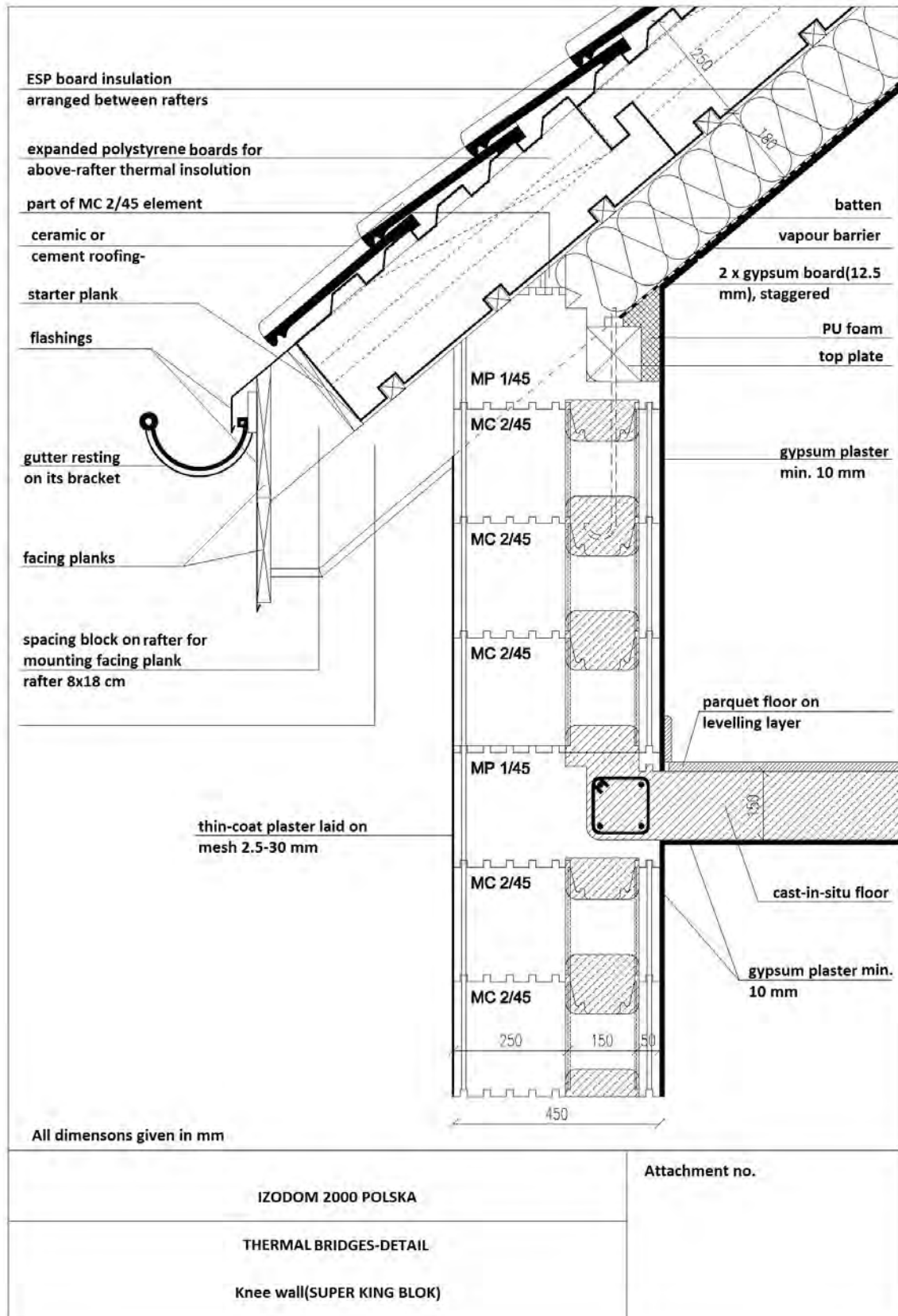

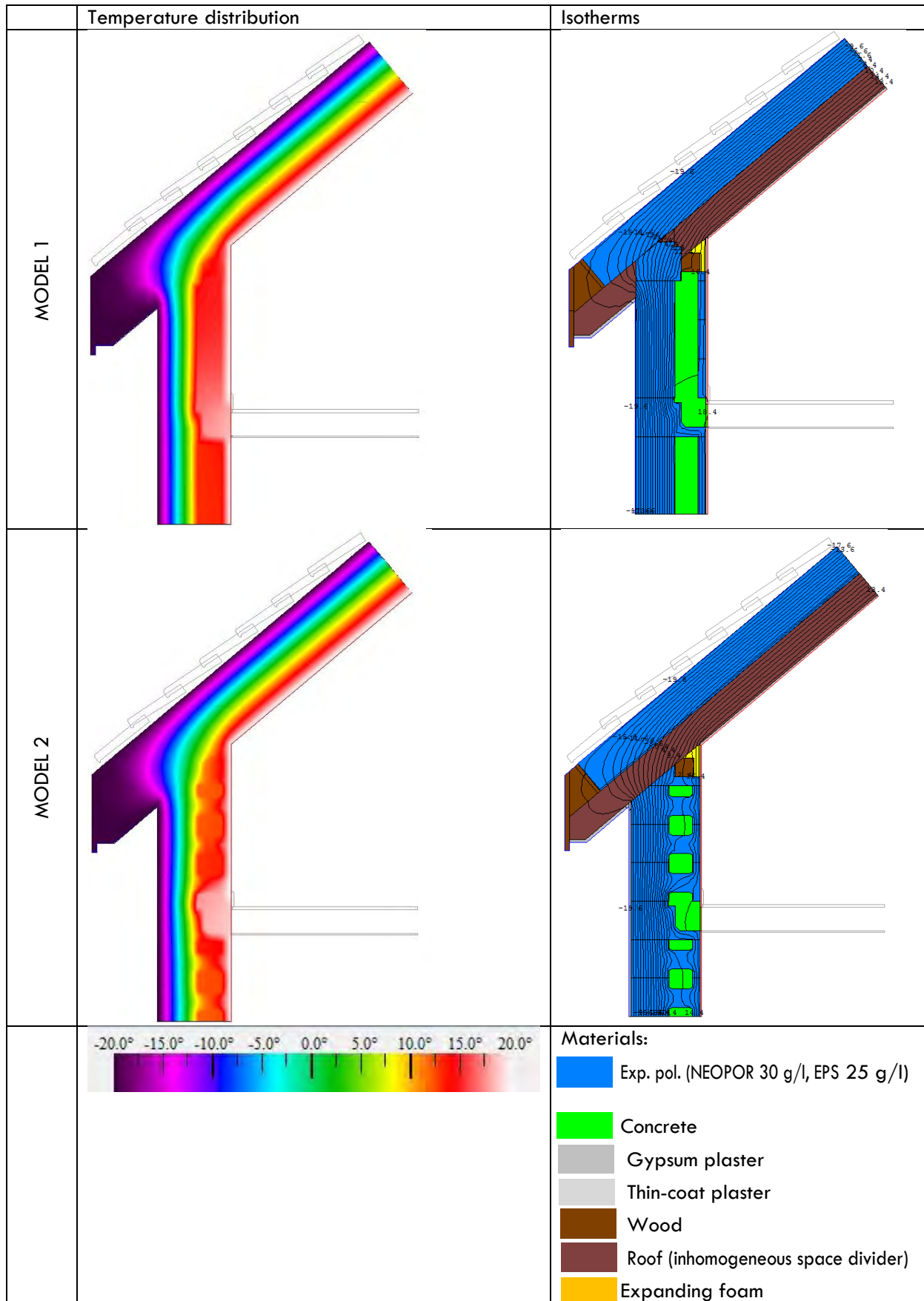

Value of thermal transmittance U_A at the external wall for model 1:

Description	d	λ	R	U
	[m]	[W/mK]	[m ² K/W]	[W/m ² K]
Thermal resistance on the internal side			0.13	
Gypsum plaster	0.01	0.4	0.025	
Expanded polystyrene NEOPOR 30 g/l	0.05	0.031	1.613	
Concrete	0.15	1.7	0.088	
Expanded polystyrene NEOPOR 30 g/l	0.25	0.031	8.065	
Thin-coat mineral plaster	0.005	1.0	0.005	
Thermal resistance on the external side			0.04	
Total thickness	0.47		9.966	0.100

Value of thermal transmittance U_B at the roof for model 1:

Description	d	λ	R	U
	[m]	[W/mK]	[m ² K/W]	[W/m ² K]
Thermal resistance on the internal side			0.10	
2 x gypsum board	0.0125	0.4	0.031	
Steep-sloped roof (inhomogeneous space divider)	0.18	0.041	4.390	
Expanded polystyrene EPS 25 g/l	0.22	0.034	6.471	
Thermal resistance on the external side			0.04	
Total thickness	0.4125		11.032	0.091

Value of linear thermal transmittance Ψ_1 calculated for model 1:

	U-factor W/m ² K	delta T C	Length mm
Edge	0.0997	40.0	3271.68

U = 0.0997 [W/m²K]
L = 3.27 [m]

$U_A = 0.100$ [W/m²K]
 $L_A = 1.77$ [m]
 $U_B = 0.091$ [W/m²K]
 $L_B = 2.31$ [m]

$$\Psi_1 = 0.0997 * 3.27 - 0.100 * 1.77 - 0.091 * 2.31 = -0.061 \text{ [W/mK]}$$

Value of thermal transmittance U at the external wall for model 2:

Total thermal resistance

	R-Value m ² K/W	delta T C	Length mm
Edge	10.6938	40.0	1250

R = 10.6938 m²K/W

	U-factor W/m ² K	delta T C	Length mm
Edge	0.0935	40.0	1250

$U_A = 1 / R = 0.094$ W/m²K

Value of thermal transmittance U_b at the roof for model 2:

Description	d	λ	R	U
	[m]	[W/mK]	[m ² K/W]	[W/m ² K]
Thermal resistance on the internal side			0.10	
2 x gypsum board	0.0125	0.4	0.031	
Steep-sloped roof (inhomogeneous space divider)	0.18	0.041	4.390	
Expanded polystyrene EPS 25 g/l	0.22	0.034	6.471	
Thermal resistance on the external side			0.04	
Total thickness	0.4125		11.032	0.091

Value of linear thermal transmittance Ψ_2 calculated for model 2:

	U-factor W/m ² K	delta T C	Length mm
Edge	0.0960	40.0	3284.57

$U = 0.096$ [W/m²K]
 $L = 3.28$ [m]
 $U_A = 0.094$ [W/m²K]
 $L_A = 1.77$ [m]
 $U_B = 0.091$ [W/m²K]
 $L_B = 2.31$ [m]

$$\Psi_2 = 0,096 * 3,28 - 0,094 * 1,77 - 0,091 * 2,31 = -0,063 \text{ [W/mK]}$$

Resultant linear thermal transmittance Ψ_e for the entire element (weighted with the length, at which the bridge occurs):

Length (width) at which the bridge occurs for model 1 $l_1 = 0.185$ m

Length (width) at which the bridge occurs for model 2 $l_2 = 0.065$ m

$$\Psi_e = (\Psi_1 * l_1 + \Psi_2 * l_2) / (l_1 + l_2) = (-0.061 * 0.185 - 0.063 * 0.065) / (0.185 + 0.065)$$

$$\Psi_e = -0.062 \text{ [W/mK]}$$

Design temperature factor at the internal surface f_{Rsi} :

The minimum temperature θ_{si} at the internal surface of wall, obtained from the software, is 18.5 °C.

$$f_{Rsi} = (\theta_{si} - \theta_e) / (\theta_i - \theta_e) = (18.5 - (-20)) / (20 - (-20)) = 38.5 / 40$$

$$f_{Rsi} = 0.963$$

11.Knee wall (King Blok)

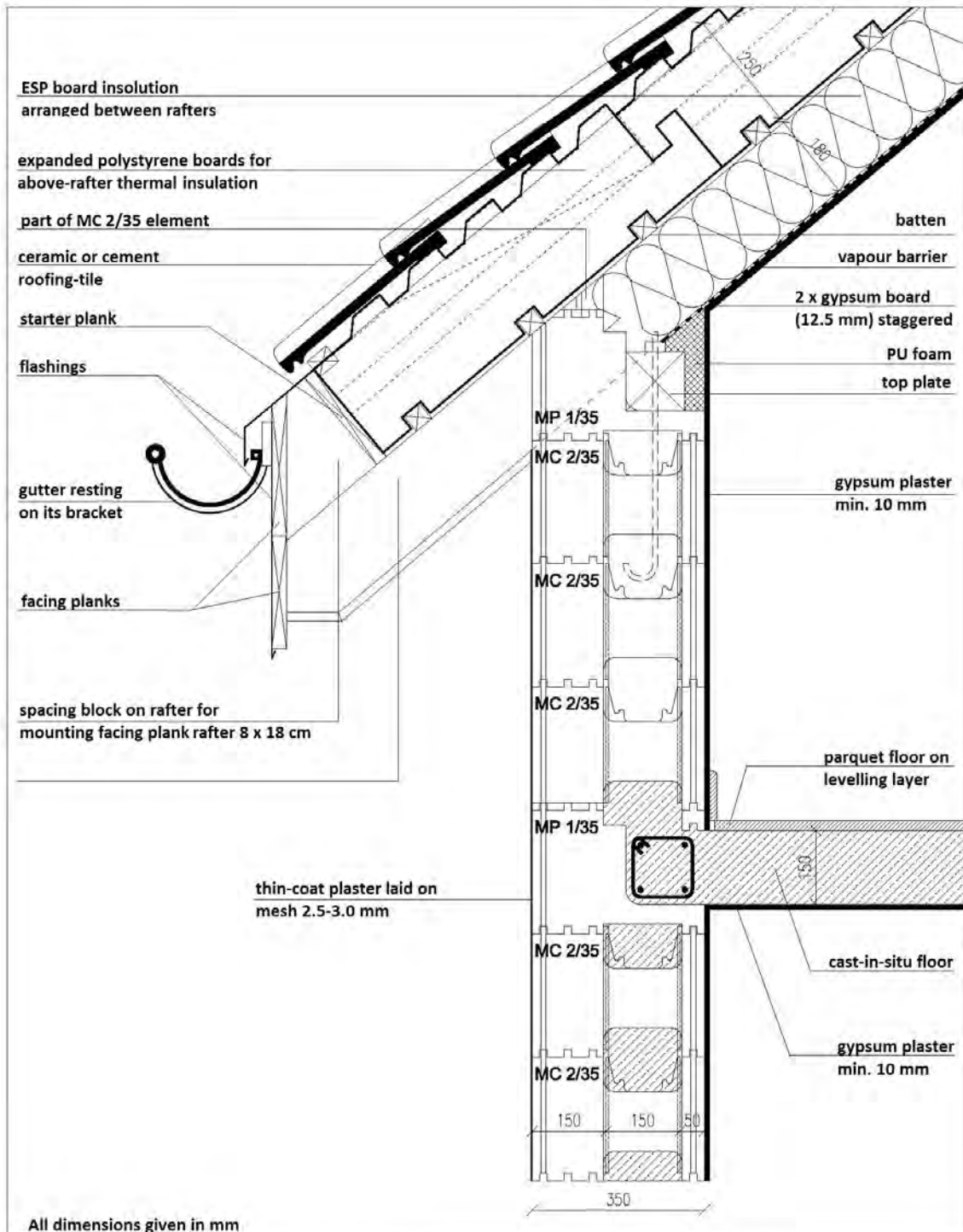

IZODOM 2000 POLSKA	Attachment no.
THERMAL BRIDGES - DETAIL	
Knee wall (King Blok)	

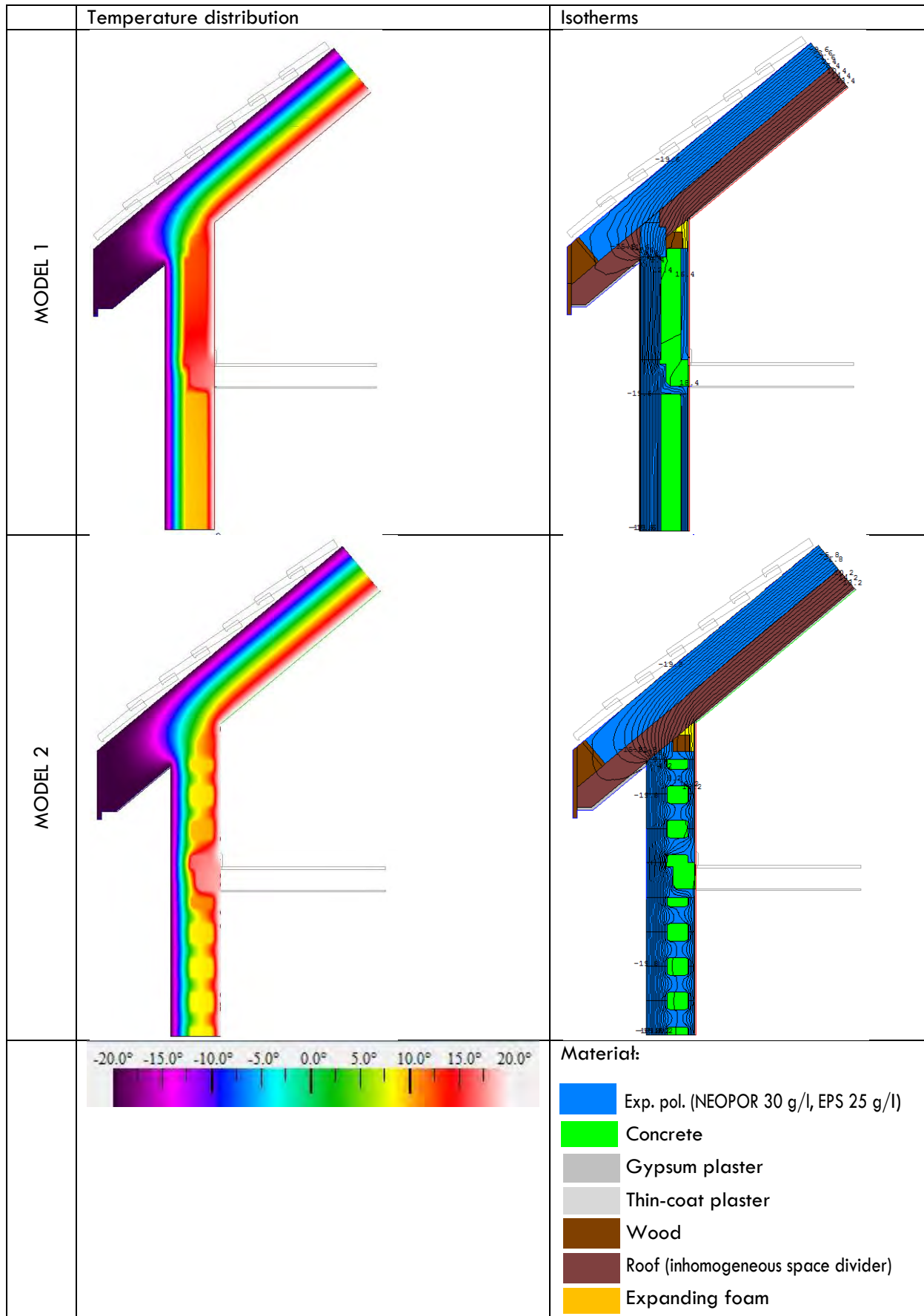

Value of thermal transmittance U_A at the external wall for model 1:

Description	d	λ	R	U
	[m]	[W/mK]	[m ² K/W]	[W/m ² K]
Thermal resistance on the internal side			0.13	
Gypsum plaster	0.01	0.4	0.025	
Expanded polystyrene NEOPOR 30 g/l	0.05	0.031	1.613	
Concrete	0.15	1.7	0.088	
Expanded polystyrene NEOPOR 30 g/l	0.15	0.031	4.839	
Thin-coat mineral plaster	0.005	1.0	0.005	
Thermal resistance on the external side			0.04	
Total thickness	0.37		6.740	0.148

Value of thermal transmittance U_B at the roof for model 1:

Description	d	λ	R	U
	[m]	[W/mK]	[m ² K/W]	[W/m ² K]
Thermal resistance on the internal side			0.10	
2 x gypsum board	0.0125	0.4	0.031	
Steep-sloped roof (inhomogeneous space divider)	0.18	0.041	4.390	
Expanded polystyrene EPS 25 g/l	0.22	0.034	6.471	
Thermal resistance on the external side			0.04	
Total thickness	0.4125		11.032	0.091

Value of linear thermal transmittance Ψ_1 calculated for model 1:

	U-factor W/m ² K	delta T C	Length mm
Edge	0.1283	40.0	3771.68

U = 0.128 [W/m²K]
L = 3.77 [m]

$U_A = 0.148$ [W/m²K]
 $L_A = 2.27$ [m]
 $U_B = 0.091$ [W/m²K]
 $L_B = 2.31$ [m]

$$\Psi_1 = 0.128 * 3.77 - 0.148 * 2.27 - 0.091 * 2.31 = -0.064 \text{ [W/mK]}$$

Value of thermal transmittance U at the external wall for model 2:

Total thermal resistance

	R-Value m ² K/W	delta T C	Length mm
Edge	7.4674	40.0	1250

R = 7.467 m²K/W

	U-factor W/m ² K	delta T C	Length mm
Edge	0.1339	40.0	1250

$U_A = 1 / R = 0.134$ W/m²K

Value of thermal transmittance U_B at the roof for model 2:

Description	d	λ	R	U
	[m]	[W/mK]	[m ² K/W]	[W/m ² K]
Thermal resistance on the internal side			0.10	
2 x gypsum board	0.0125	0.4	0.031	
Steep-sloped roof (inhomogeneous space divider)	0.18	0.041	4.390	
Expanded polystyrene EPS 25 g/l	0.22	0.034	6.471	
Thermal resistance on the external side			0.04	
Total thickness	0.4125		11.032	0.091

Value of linear thermal transmittance Ψ_2 calculated for model 2:

	U-factor W/m ² K	delta T C	Length mm
Edge	0.1208	40.0	3771.68

$U = 0.121$ [W/m²K]
 $L = 3.77$ [m]
 $U_A = 0.13$ [W/m²K]
 $L_A = 2.27$ [m]
 $U_B = 0.091$ [W/m²K]
 $L_B = 2.31$ [m]

$$\Psi_2 = 0.121 * 3.77 - 0.134 * 2.27 - 0.091 * 2.31 = -0.058 \text{ [W/mK]}$$

Resultant linear thermal transmittance Ψ_e for the entire element (weighted with the length, at which the bridge occurs):

Length (width) at which the bridge occurs for model 1 $l_1 = 0.185$ m

Length (width) at which the bridge occurs for model 2 $l_2 = 0.065$ m

$$\Psi_e = \Psi_1 * l_1 + \Psi_2 * l_2 / (l_1 + l_2) = (-0.064 * 0.185 - 0.058 * 0.065) / (0.185 + 0.065)$$

$$\Psi_e = -0.062 \text{ [W/mK]}$$

Design temperature factor at the internal surface f_{Rsi} :

The minimum temperature θ_{si} at the internal surface of wall, obtained from the software, is 18.4 °C.

$$f_{Rsi} = (\theta_{si} - \theta_e) / (\theta_i - \theta_e) = (18.4 - (-20)) / (20 - (-20)) = 38.4 / 40$$

$$f_{Rsi} = 0.960$$

12.Flat roof resting on external wall (Super King Blok)

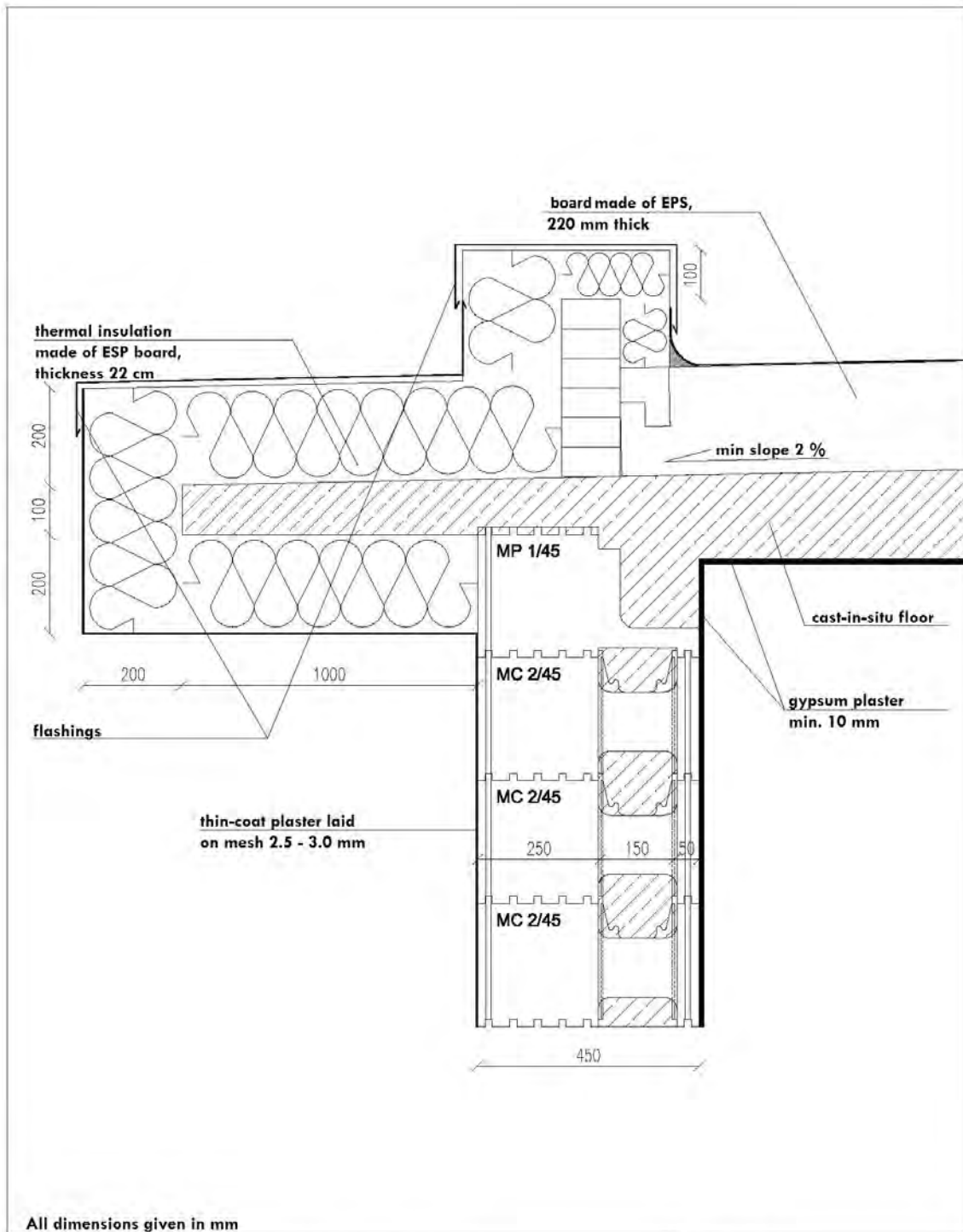

All dimensions given in mm

IZODOM 2000 POLSKA	Attachment no .
THERMAL BRIDGES - DETAIL	
Flat roof resting on external wall (SUPER KING BLOK)	

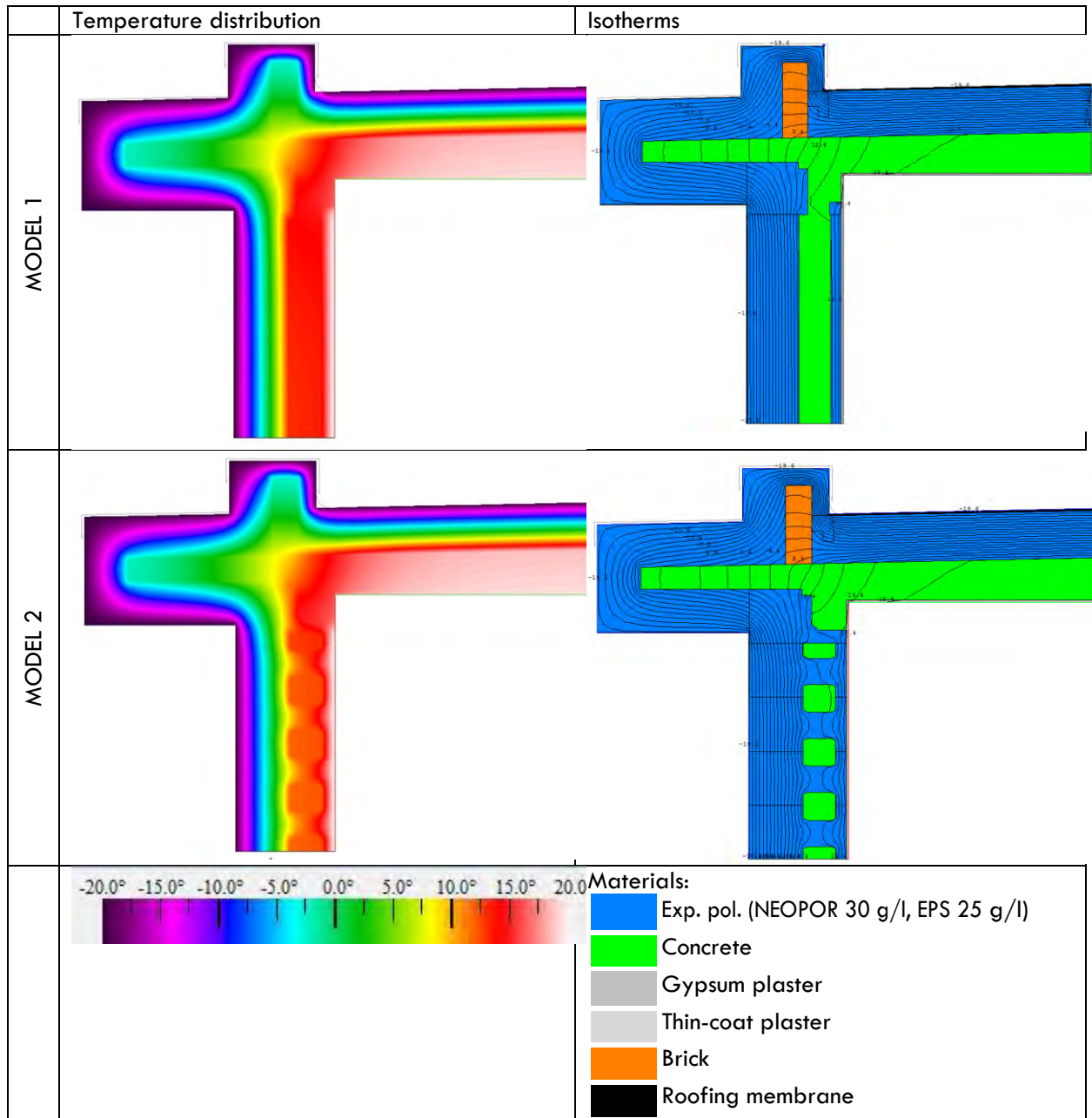

Value of thermal transmittance U_A at the external wall for model 1:

Description	d	λ	R	U
	[m]	[W/mK]	[m ² K/W]	[W/m ² K]
Thermal resistance on the internal side			0.13	
Gypsum plaster	0.01	0.4	0.025	
Expanded polystyrene NEOPOR 30 g/l	0.05	0.031	1.613	
Concrete	0.15	1.7	0.088	
Expanded polystyrene NEOPOR 30 g/l	0.25	0.031	8.065	
Thin-coat mineral plaster	0.005	1.0	0.005	
Thermal resistance on the external side			0.04	
Total thickness	0.47		9.966	0.100

Value of thermal transmittance U_B at the slab roof for model 1:

Description	d	λ	R	U
	[m]	[W/mK]	[m ² K/W]	[W/m ² K]
Thermal resistance on the internal side			0.10	
Gypsum plaster	0.01	0.4	0.025	
Concrete	0.18	1.7	0.106	
Expanded polystyrene EPS 25 g/l	0.22	0.032	6.471	
Roofing membrane	0.007	0.18	0.039	
Thermal resistance on the external side			0.04	
Total thickness	0.417		6.780	0.148

Value of linear thermal transmittance Ψ_1 calculated for model 1:

	U-factor W/m ² K	delta T C	Length mm
Edge	0.2150	40.0	2380

U = 0.215 [W/m²K]
L = 2.38 [m]

$U_A = 0.100$ [W/m²K]
 $L_A = 1.56$ [m]
 $U_B = 0.148$ [W/m²K]
 $L_B = 1.65$ [m]

$$\Psi_1 = 0.215 * 2.38 - 0.100 * 1.56 - 0.148 * 1.65 = 0.112 \text{ [W/mK]}$$

Value of thermal transmittance U at the external wall for model 2::

Total thermal resistance

	R-Value m ² K/W	delta T C	Length mm
Edge	10.3698	40.0	1250

R = 10.3698 m²K/W

	U-factor W/m ² K	delta T C	Length mm
Edge	0.0964	40.0	1250

$U_A = 1 / R = 0.096$ W/m²K

Value of thermal transmittance U_B at the slab roof for model 2:

Description	d	λ	R	U
	[m]	[W/mK]	[m ² K/W]	[W/m ² K]
Thermal resistance on the internal side			0.10	
Gypsum plaster	0.01	0.4	0.025	
Concrete	0.18	1.7	0.106	
Expanded polystyrene EPS 25 g/l	0.22	0.034	6.471	
Roofing membrane	0.007	0.18	0.039	
Thermal resistance on the external side			0.04	
Total thickness	0.417		6.780	0.148

Value of linear thermal transmittance Ψ_2 calculated for model 2:

	U-factor W/m ² K	delta T C	Length mm
Edge	0.2118	40.0	2380

$$U = 0.212 \text{ [W/m}^2\text{K]}$$

$$L = 2.38 \text{ [m]}$$

$$U_A = 0.096 \text{ [W/m}^2\text{K]}$$

$$L_A = 1.56 \text{ [m]}$$

$$U_B = 0.148 \text{ [W/m}^2\text{K]}$$

$$L_B = 1.65 \text{ [m]}$$

$$\Psi_2 = 0.212 * 2.38 - 0.096 * 1.56 - 0.148 * 1.65 = 0.111 \text{ [W/mK]}$$

Resultant linear thermal transmittance Ψ_e for the entire element (weighted with the length, at which the bridge occurs):

Length (width) at which the bridge occurs for model 1 $l_1 = 0.185 \text{ m}$

Length (width) at which the bridge occurs for model 2 $l_2 = 0.065 \text{ m}$

$$\Psi_e = (\Psi_1 * l_1 + \Psi_2 * l_2) / (l_1 + l_2) = (0.112 * 0.185 + 0.111 * 0.065) / (0.185 + 0.065)$$

$$\Psi_e = 0.111 \text{ [W/mK]}$$

Design temperature factor at the internal surface f_{Rsi} :

The minimum temperature θ_{si} at the internal surface of wall, obtained from the software, is 14.0 °C.

$$f_{Rsi} = (\theta_{si} - \theta_e) / (\theta_i - \theta_e) = (14.0 - (-20)) / (20 - (-20)) = 34.0 / 40$$

$$f_{Rsi} = 0.850$$

13.Flat roof resting on external wall (King Blok)

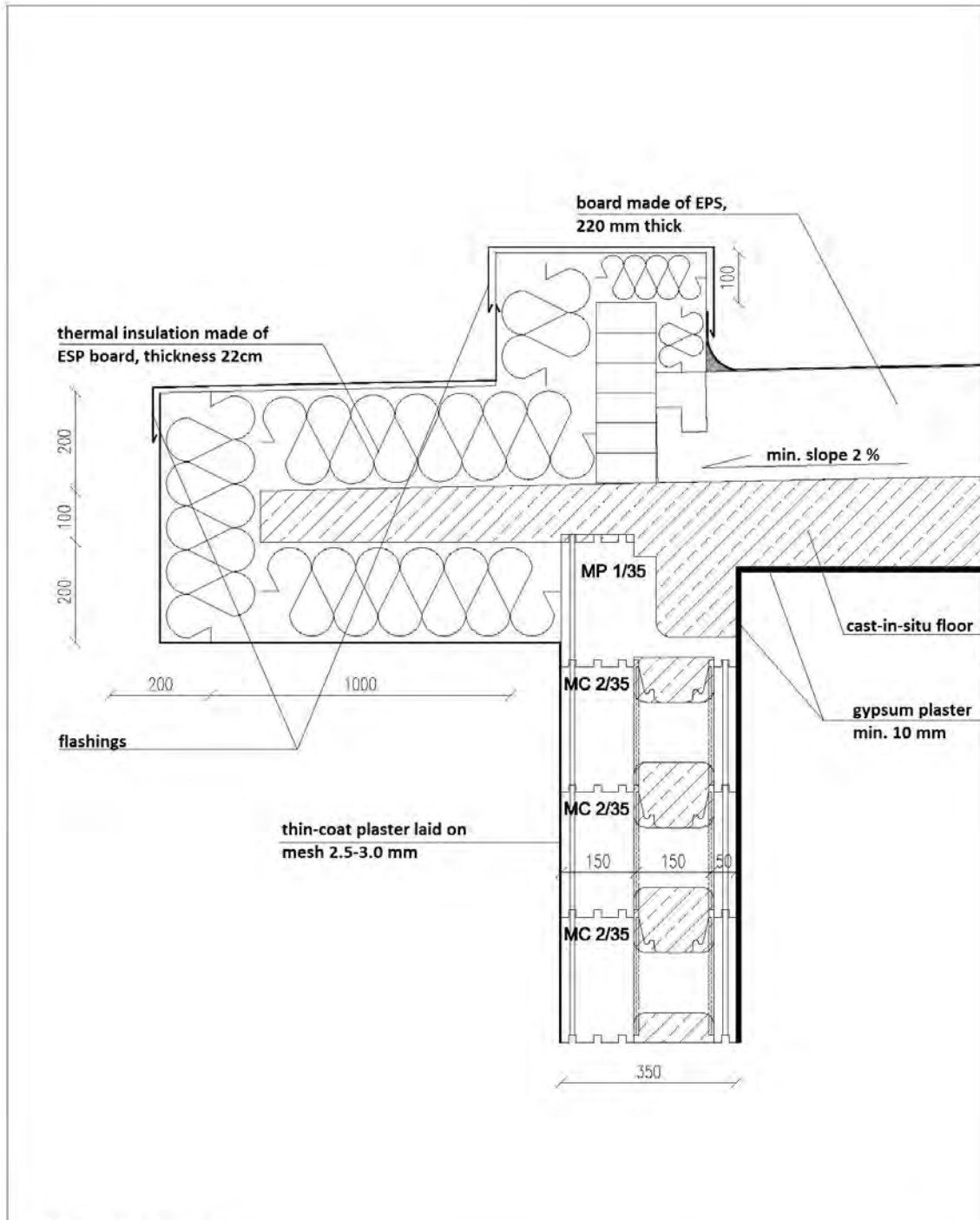

All dimensions given in mm

<p>IZODOM 2000 POLSKA</p>	<p>Attachment no.</p>
<p>THERMAL BRIDGES - DETAIL</p> <p>Flat roof resting on external wall (KING BLOK)</p>	

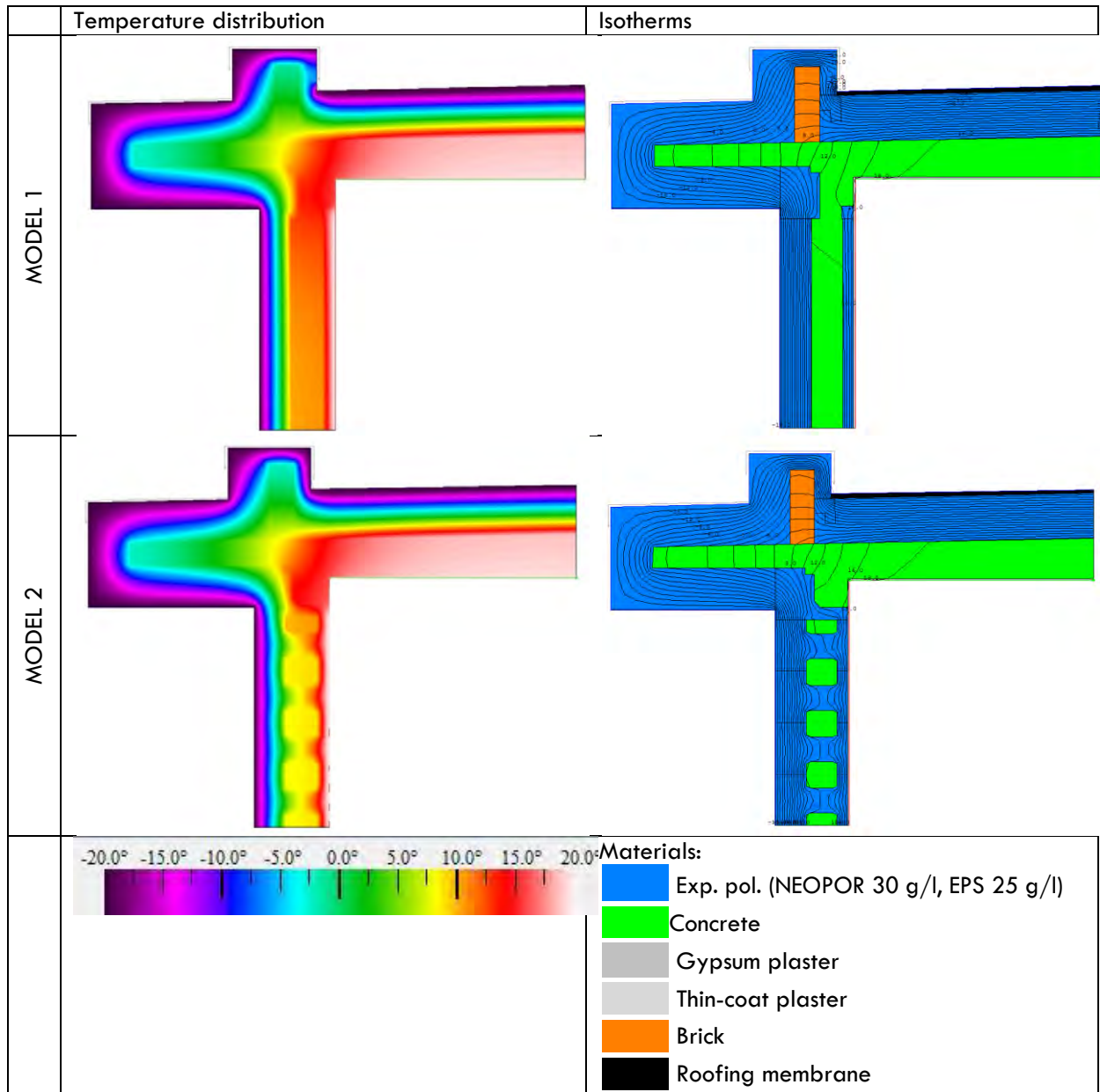

Value of thermal transmittance U_A at the external wall for model 1:

Description	d	λ	R	U
	[m]	[W/mK]	[m ² K/W]	[W/m ² K]
Thermal resistance on the internal side			0.13	
Gypsum plaster	0.01	0.4	0.025	
Expanded polystyrene NEOPOR 30 g/l	0.05	0.031	1.613	
Beton	0.15	1.7	0.088	
Concrete	0.15	0.031	4.839	
Expanded polystyrene NEOPOR 30 g/l	0.005	1.0	0.005	
Thermal resistance on the external side			0.04	
Total thickness	0.37		6.740	0.148

Value of thermal transmittance U_B at the slab roof for model 1:

Description	d	λ	R	U
	[m]	[W/mK]	[m ² K/W]	[W/m ² K]
Thermal resistance on the internal side			0.10	
Gypsum plaster	0.01	0.4	0.025	
Concrete	0.18	1.7	0.106	
Expanded polystyrene EPS 25 g/l	0.22	0.034	6.471	
Roofing membrane	0.007	0.18	0.039	
Thermal resistance on the external side			0.04	
Total thickness	0.417		6.780	0.148

Value of linear thermal transmittance Ψ_1 calculated for model 1:

	U-factor W/m ² K	delta T C	Length mm
Edge	0.2378	40.0	2380

$$U_A = 0.148 \text{ [W/m}^2\text{K]}$$

$$L_A = 1.56 \text{ [m]}$$

$$U_B = 0.148 \text{ [W/m}^2\text{K]}$$

$$L_B = 1.65 \text{ [m]}$$

$$U = 0.238 \text{ [W/m}^2\text{K]}$$

$$L = 2.38 \text{ [m]}$$

$$\Psi_1 = 0.238 * 2.38 - 0.148 * 1.56 - 0.148 * 1.65 = 0.091 \text{ [W/mK]}$$

Value of thermal transmittance U at the external wall for model 2:

Total thermal resistance

	R-Value m ² K/W	delta T C	Length mm
Edge	7.2443	40.0	1250

$$R = 7.2443 \text{ m}^2\text{K/W}$$

	U-factor W/m ² K	delta T C	Length mm
Edge	0.1380	40.0	1250

$$U_A = 1 / R = 0.138 \text{ W/m}^2\text{K}$$

Value of thermal transmittance U_B at the slab roof for model 2:

Description	d	λ	R	U
	[m]	[W/mK]	[m ² K/W]	[W/m ² K]
Thermal resistance on the internal side			0.10	
Gypsum plaster	0.01	1.4	0.025	
Concrete	0.18	1.7	0.106	
Concrete	0.22	0.034	6.471	
Roofing membrane	0.007	0.18	0.039	
Thermal resistance on the external side			0.04	
Total thickness	0.417		7.185	0.148

Value of linear thermal transmittance Ψ_2 calculated for model 2:

	U-factor W/m ² K	delta T C	Length mm
Edge	0.2330	40.0	2380

$$U = 0.233 \text{ [W/m}^2\text{K]}$$

$$L = 2.38 \text{ [m]}$$

$$U_A = 0.138 \text{ [W/m}^2\text{K]}$$

$$L_A = 1.56 \text{ [m]}$$

$$U_B = 0.148 \text{ [W/m}^2\text{K]}$$

$$L_B = 1.65 \text{ [m]}$$

$$\Psi_2 = 0.233 * 2.38 - 0.138 * 1.56 - 0.148 * 1.65 = 0.095 \text{ [W/mK]}$$

Resultant linear thermal transmittance Ψ_e for the entire element (weighted with the length, at which the bridge occurs):

Length (width) at which the bridge occurs for model 1 $l_1 = 0.185 \text{ m}$

Length (width) at which the bridge occurs for model 2 $l_2 = 0.065 \text{ m}$

$$\Psi_e = (\Psi_1 * l_1 + \Psi_2 * l_2) / (l_1 + l_2) = (0.091 * 0.185 + 0.095 * 0.065) / (0.185 + 0.065)$$

$$\Psi_e = 0.092 \text{ [W/mK]}$$

Design temperature factor at the internal surface f_{Rsi} :

The minimum temperature θ_{si} at the internal surface of wall, obtained from the software, is 13.6 °C.

$$f_{Rsi} = (\theta_{si} - \theta_e) / (\theta_i - \theta_e) = (13.6 - (-20)) / (20 - (-20)) = 33.6 / 40$$

$$f_{Rsi} = 0.840$$

14. Self-supporting balcony added to the building (Super King Blok)

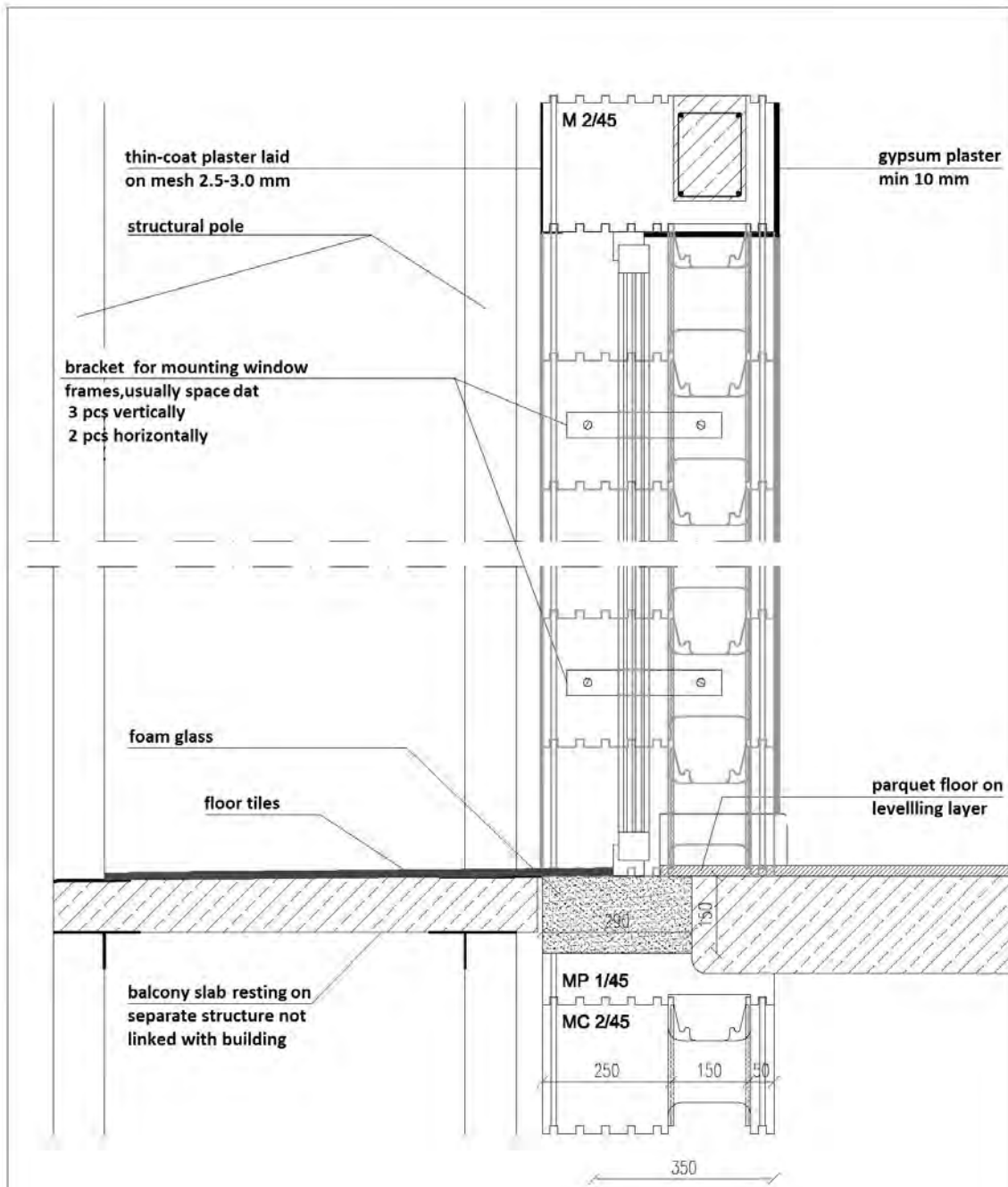

All dimensions given in mm

IZODOM 2000 POLSKA	Attachment no.
THERMAL BRIDGES-DETAIL	
Balcony slab (SUPER KING BLOK)	

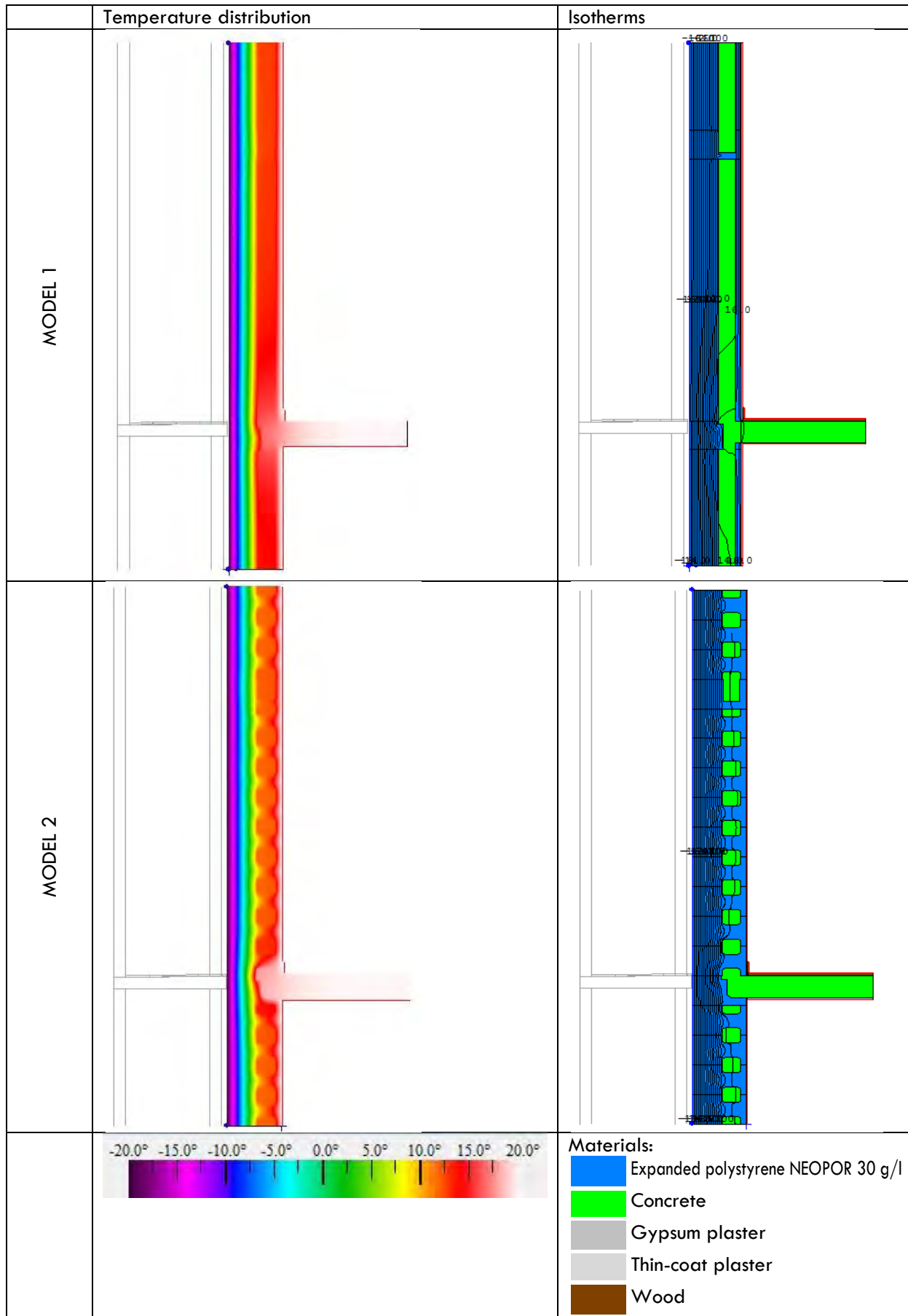

Value of thermal transmittance U_A at the external wall for model 1:

Description	d	λ	R	U
	[m]	[W/mK]	[m ² K/W]	[W/m ² K]
Thermal resistance on the internal side			0.13	
Gypsum plaster	0.01	0.4	0.025	
Expanded polystyrene NEOPOR 30 g/l	0.05	0.031	1.613	
Concrete	0.15	1.7	0.088	
Expanded polystyrene NEOPOR 30 g/l	0.25	0.031	8.065	
Thin-coat mineral plaster	0.005	1.0	0.005	
Thermal resistance on the external side			0.04	
Total thickness	0.47		9.966	0.100

Value of linear thermal transmittance Ψ_1 calculated for model 1:

	U-factor W/m ² K	delta T C	Length mm
Edge	0.1033	40.0	4500

$$U_A = 0.100 \text{ [W/m}^2\text{K]}$$

$$L_A = 4.50 \text{ [m]}$$

$$\Psi_1 = 0.103 * 4.5 - 0.100 * 4.5 = 0.013 \text{ [W/mK]}$$

$$U = 0.103 \text{ [W/m}^2\text{K]}$$

$$L = 4.50 \text{ [m]}$$

Value of thermal transmittance U at the external wall for model 2:

Total thermal resistance

	R-Value m ² K/W	delta T C	Length mm
Edge	10.3698	40.0	1250

$$R = 10.3698 \text{ m}^2\text{K/W}$$

	U-factor W/m ² K	delta T C	Length mm
Edge	0.0964	40.0	1250

$$U_A = 1 / R = 0.096 \text{ W/m}^2\text{K}$$

Value of linear thermal transmittance Ψ_2 calculated for model 2:

	U-factor W/m ² K	delta T C	Length mm
Edge	0.0953	40.0	4500

$$U = 0.095 \text{ [W/m}^2\text{K]}$$

$$L = 4.50 \text{ [m]}$$

$$U_A = 0.096 \text{ [W/m}^2\text{K]}$$

$$L_A = 4.50 \text{ [m]}$$

$$\Psi_2 = 0.095 * 4.5 - 0.096 * 4.5 = -0.005 \text{ [W/mK]}$$

Resultant linear thermal transmittance Ψ_e for the entire element (weighted with the length, at which the bridge occurs):

Length (width) at which the bridge occurs for model 1 $l_1 = 0.185 \text{ m}$

Length (width) at which the bridge occurs for model 2 $l_2 = 0.065 \text{ m}$

$$\Psi_e = (\Psi_1 * l_1 + \Psi_2 * l_2) / (l_1 + l_2) = (0.013 * 0.185 - 0.005 * 0.065) / (0.185 + 0.065)$$

$$\Psi_e = 0.008 \text{ [W/mK]}$$

Design temperature factor at the internal surface f_{Rsi} :

The minimum temperature θ_{si} at the internal surface of wall, obtained from the software, is 17.9 °C.

$$f_{Rsi} = (\theta_{si} - \theta_e) / (\theta_i - \theta_e) = (17.9 - (-20)) / (20 - (-20)) = 37.9 / 40$$

$$f_{Rsi} = 0.948$$

15. Self-supporting balcony added to the building (King Blok)

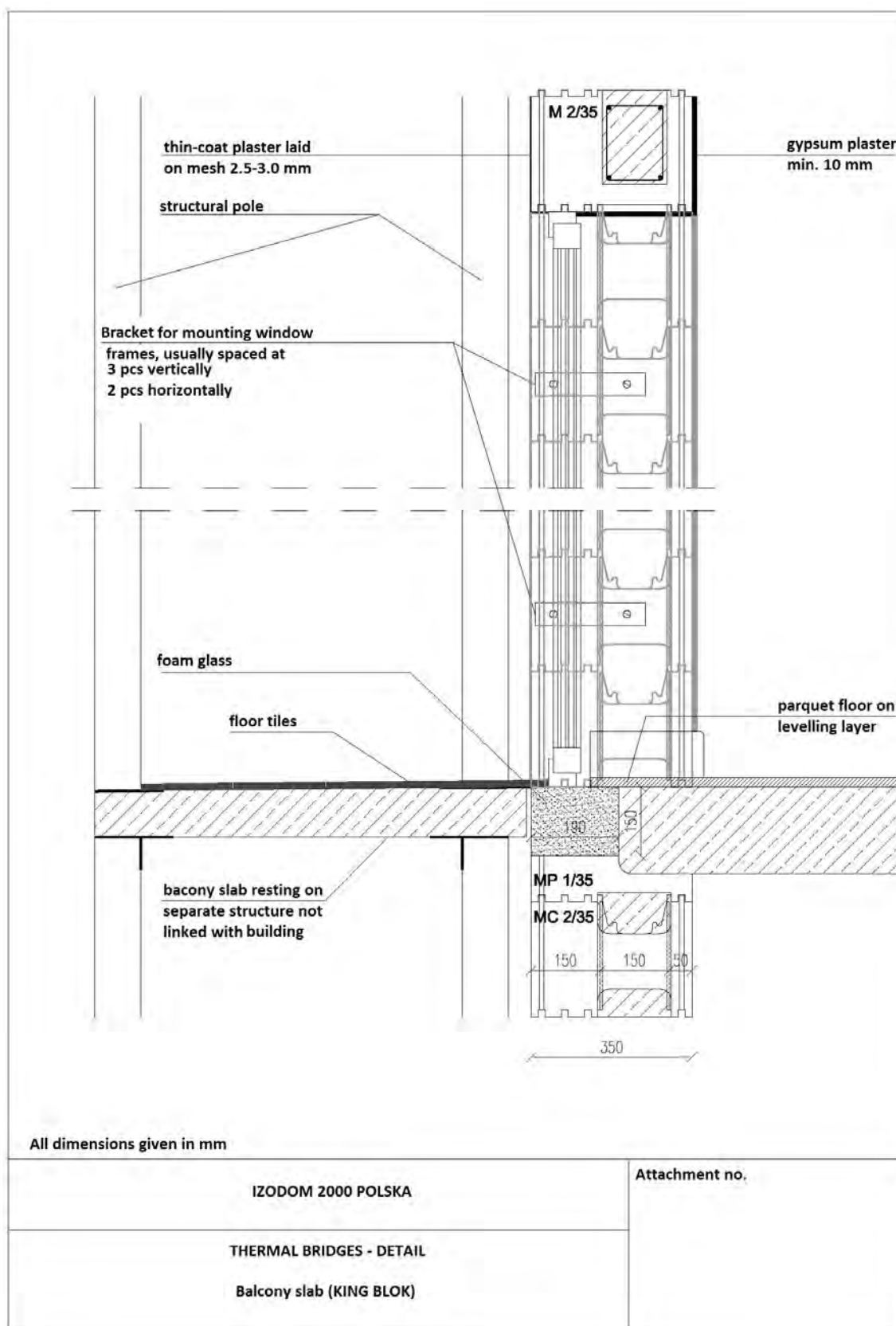

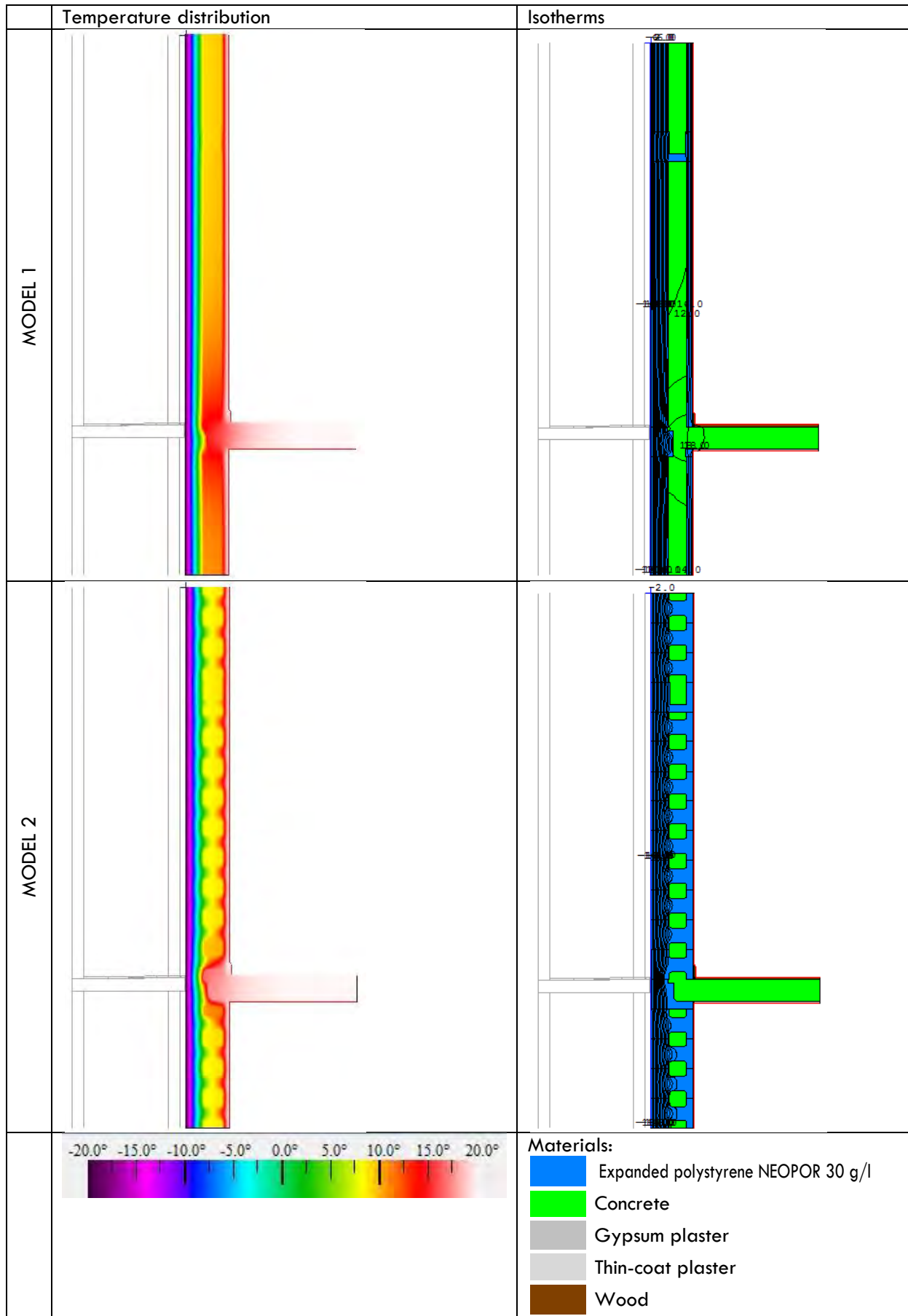

Value of thermal transmittance U_A at the external wall for model 1:

Description	d	λ	R	U
	[m]	[W/mK]	[m ² K/W]	[W/m ² K]
Thermal resistance on the internal side			0.13	
Gypsum plaster	0.01	0.4	0.025	
Expanded polystyrene NEOPOR 30 g/l	0.05	0.031	1.613	
Concrete	0.15	1.7	0.088	
Expanded polystyrene NEOPOR 30 g/l	0.15	0.031	4.839	
Thin-coat mineral plaster	0.005	1.0	0.005	
Thermal resistance on the external side			0.04	
Total thickness	0.37		6.740	0.148

Value of linear thermal transmittance Ψ_1 calculated for model 1:

	U-factor W/m ² -K	delta T C	Length mm
Edge	0.1553	40.0	4500

U = 0.155 [W/m²K]
L = 4.50 [m]

$U_A = 0.148$ [W/m²K]
 $L_A = 4.50$ [m]

$$\Psi_1 = 0.155 * 4.5 - 0.148 * 4.5 = 0.032 \text{ [W/mK]}$$

Value of thermal transmittance U at the external wall for model 2:

Total thermal resistance

	R-Value m ² -K/W	delta T C	Length mm
Edge	7.2443	40.0	1250

R = 7.2443 m²K/W

	U-factor W/m ² -K	delta T C	Length mm
Edge	0.1380	40.0	1250

$U_A = 1 / R = 0.138$ W/m²K

Value of linear thermal transmittance Ψ_2 calculated for model 2:

	U-factor W/m ² -K	delta T C	Length mm
Edge	0.1378	40.0	4500

U = 0.14 [W/m²K]
L = 4.50 [m]
 $U_A = 0.14$ [W/m²K]
 $L_A = 4.50$ [m]

$$\Psi_2 = 0.138 * 4.5 - 0.138 * 4.5 = 0.0 \text{ [W/mK]}$$

Resultant linear thermal transmittance Ψ_e for the entire element (weighted with the length, at which the bridge occurs):

Length (width) at which the bridge occurs for model 1 $l_1 = 0.185$ m

Length (width) at which the bridge occurs for model 2 $l_2 = 0.065$ m

$$\Psi_e = \Psi_1 * l_1 + \Psi_2 * l_2 / (l_1 + l_2) = (0.032 * 0.185 + 0.00 * 0.065) / (0.185 + 0.065)$$

$$\Psi_e = 0.024 \text{ [W/mK]}$$

Design temperature factor at the internal surface f_{Rsi} :

The minimum temperature θ_{si} at the internal surface of wall, obtained from the software, is 17.0 °C.

$$f_{Rsi} = (\theta_{si} - \theta_e) / (\theta_i - \theta_e) = (17.0 - (-20)) / (20 - (-20)) = 37.0 / 40$$

$$f_{Rsi} = 0.925$$

16.Connection between door frame and jamb (Super King Blok)

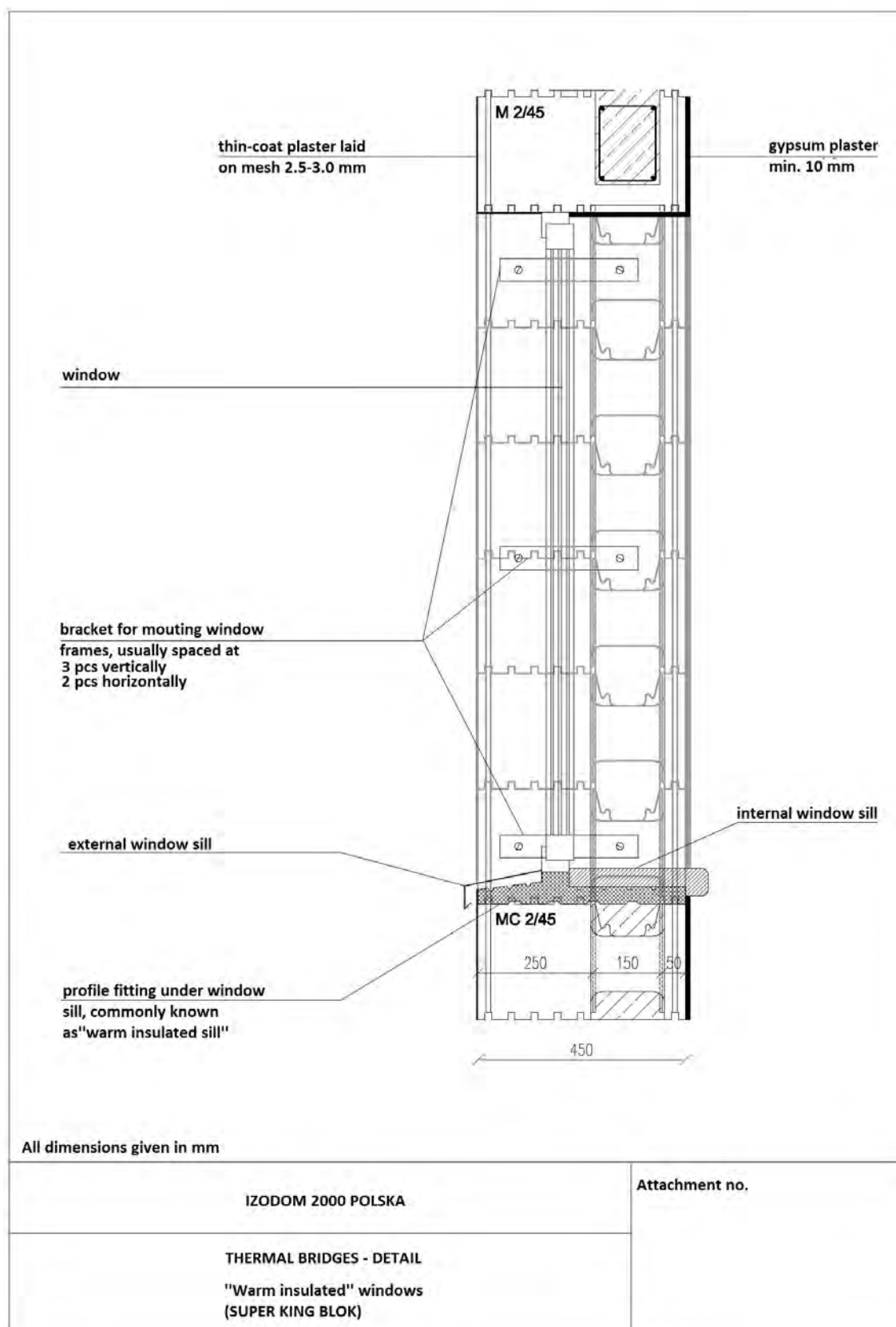

Insulation not overlapping the window frame

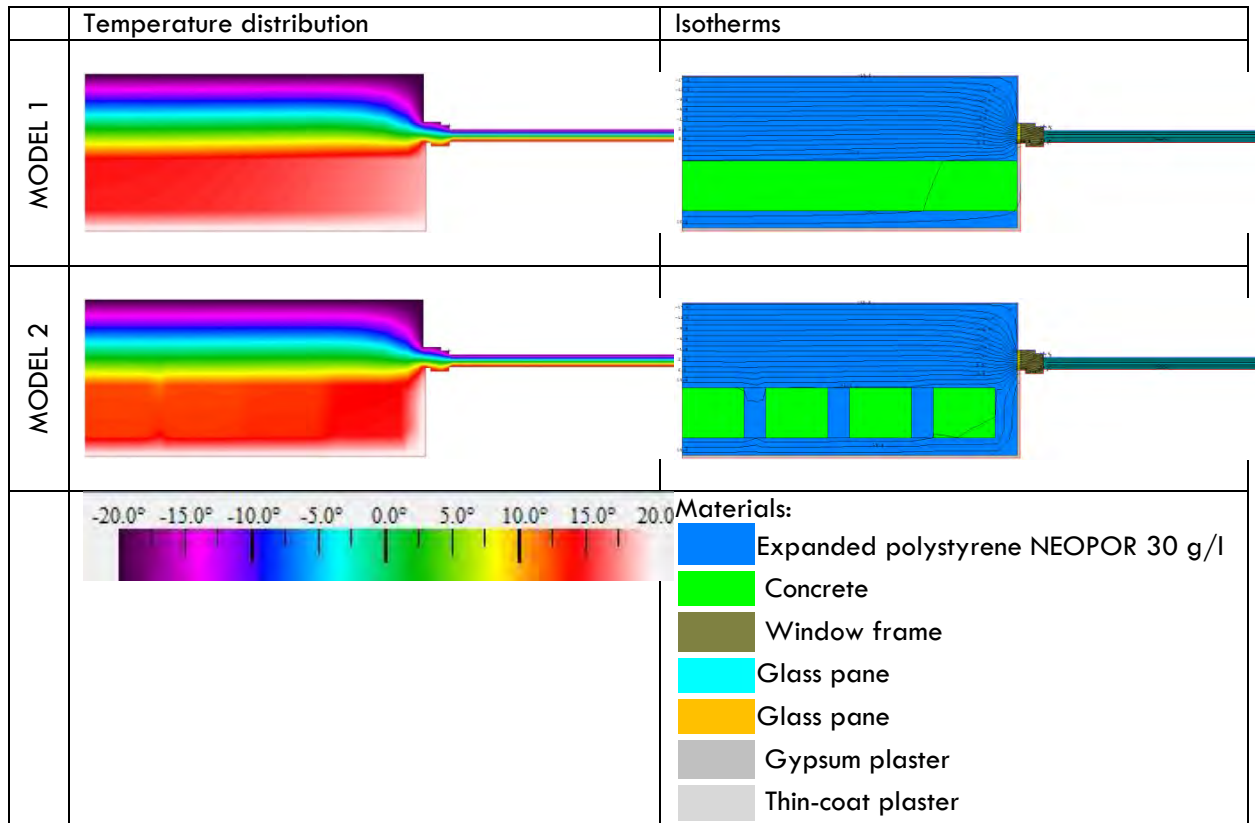
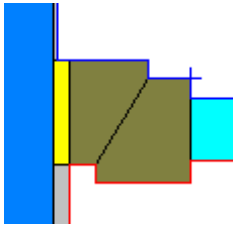

Value of thermal transmittance UA at the external wall for model 1:

Description	d	λ	R	U
	[m]	[W/mK]	[m ² K/W]	[W/m ² K]
Thermal resistance on the internal side			0.13	
Gypsum plaster	0.01	0.4	0.025	
Expanded polystyrene NEOPOR 30 g/l	0.05	0.031	1.613	
Concrete	0.15	1.7	0.088	
Expanded polystyrene NEOPOR 30 g/l	0.25	0.031	8.065	
Thin-coat mineral plaster	0.005	1.0	0.005	
Thermal resistance on the external side			0.04	
Total thickness	0.47		9.966	0.100

Value of linear thermal transmittance Ψ_1 calculated for model 1:

	U-factor W/m ² ·K	delta T C	Length mm
Edge	0.2985	40.0	1943

U = 0.299 [W/m²K]
 L = 1.94 [m]
 U_A = 0.100 [W/m²K]
 L_A = 1.0 [m]

Frame

U_B = 1.5 [W/m²K]
 L_B = 0.07 [m]

Glazing

U_C = 0.50 [W/m²K]
 L_C = 0.7 [m]

$$\Psi_1 = 0.299 * 1.94 - 0.100 * 1.0 - 1.5 * 0.07 - 0.50 * 0.7 = 0.025 \text{ [W/mK]}$$

Value of thermal transmittance U at the external wall for model 2:

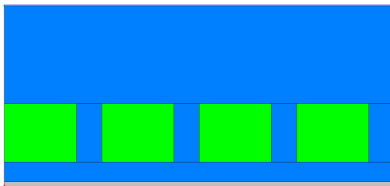

	U-factor W/m ² ·K	delta T C	Length mm
Edge	0.1015	40.0	1000

$$U_A = 1 / R = 0.10 \text{ W/m}^2\text{K}$$

Value of linear thermal transmittance Ψ_2 calculated for model 2:

	U-factor W/m ² ·K	delta T C	Length mm
Edge	0.2956	40.0	1943

U = 0.296 [W/m²K]
 L = 1.94 [m]

Frame

U_B = 1.5 [W/m²K]
 L_B = 0.07 [m]

Glazing

U_C = 0.5 [W/m²K]
 L_C = 0.7 [m]

$$\Psi_2 = 0.296 * 1.94 - 0.10 * 1.0 - 1.5 * 0.07 - 0.5 * 0.7 = 0.019 \text{ [W/mK]}$$

Resultant linear thermal transmittance Ψ_e for the entire element (weighted with the length, at which the bridge occurs):

Length at which the bridge occurs for model 1
 l₁ = 0.13 m

Length at which the bridge occurs for model 2
 l₂ = 0.12 m

$$\Psi_e = (\Psi_1 * l_1 + \Psi_2 * l_2) / (l_1 + l_2) = (0.025 * 0.13 + 0.019 * 0.12) / (0.13 + 0.12)$$

$$\Psi_e = 0.022 \text{ [W/mK]}$$

Design temperature factor at the internal surface f_{Rsi}:

The minimum temperature θ_{si} at the connection between the frame with the jamb, obtained from the software, is 12.2 °C.

$$f_{Rsi} = (\theta_{si} - \theta_e) / (\theta_i - \theta_e) = (12.2 - (-20)) / (20 - (-20)) = 32.2 / 40$$

$$f_{Rsi} = 0.805$$

Insulation overlapping the window frame

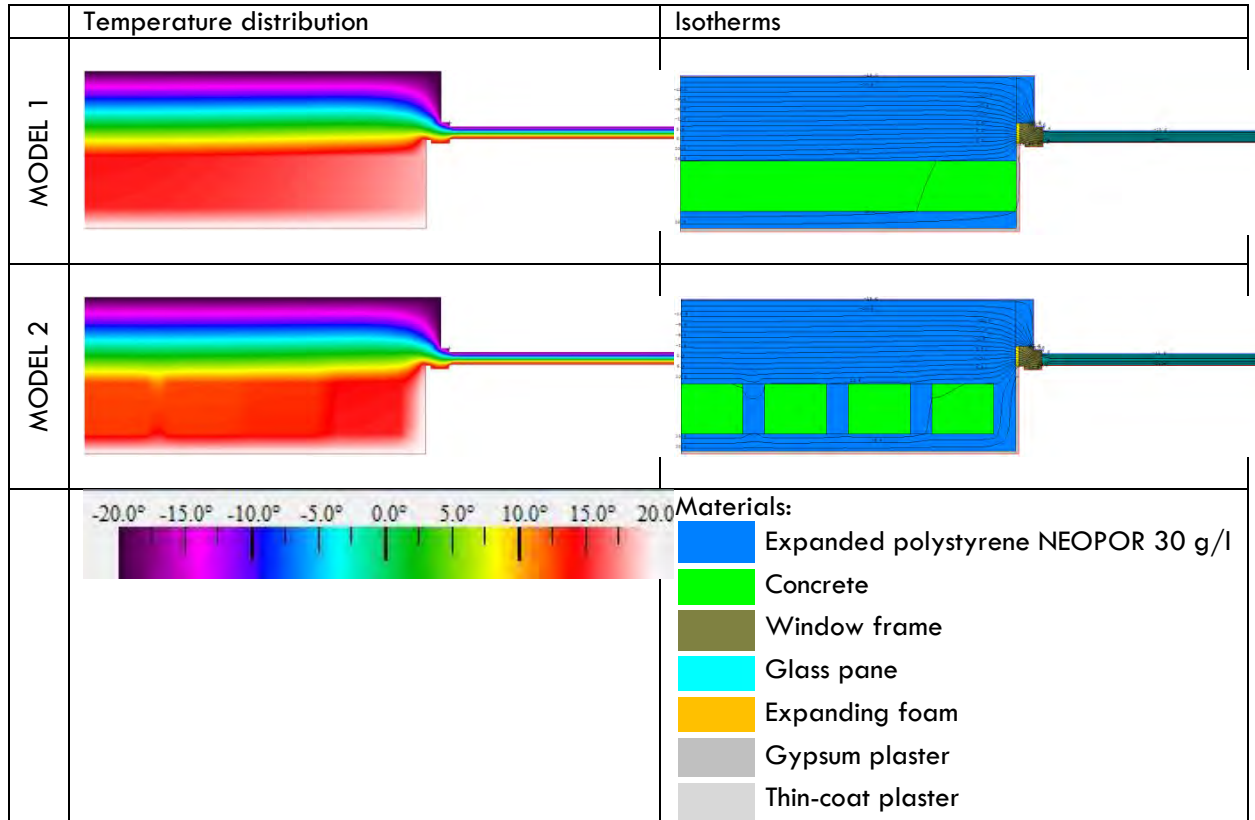
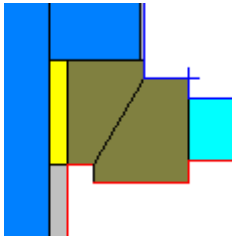

Value of thermal transmittance U_A at the external wall for model 1:

Description	d	λ	R	U
	[m]	[W/mK]	[m ² K/W]	[W/m ² K]
Thermal resistance on the internal side			0.13	
Gypsum plaster	0.01	0.4	0.025	
Expanded polystyrene NEOPOR 30 g/l	0.05	0.031	1.613	
Concrete	0.15	1.7	0.088	
Expanded polystyrene NEOPOR 30 g/l	0.25	0.031	8.065	
Thin-coat mineral plaster	0.005	1.0	0.005	
Thermal resistance on the external side			0.04	
Total thickness	0.47		9.966	0.100

Value of linear thermal transmittance Ψ_1 calculated for model 1:

	U-factor W/m ² K	delta T C	Length mm
Edge	0.2865	40.0	1943

U = 0.287 [W/m²K]
 L = 1.94 [m]
 U_A = 0.100 [W/m²K]
 L_A = 1.0 [m]

Frame

U_B = 1.5 [W/m²K]
 L_B = 0.07 [m]

Glazing

U_C = 0.50 [W/m²K]
 L_C = 0.7 [m]

$$\Psi_1 = 0.287 * 1.94 - 0.100 * 1.0 - 1.5 * 0.07 - 0.50 * 0.7 = 0.002 \text{ [W/mK]}$$

Value of thermal transmittance U at the external wall for model 2:

	U-factor W/m ² K	delta T C	Length mm
Edge	0.1015	40.0	1000

$$U_A = 1 / R = 0.10 \text{ W/m}^2\text{K}$$

Value of linear thermal transmittance Ψ_2 calculated for model 2:

	U-factor W/m ² K	delta T C	Length mm
Edge	0.2832	40.0	1943

U = 0.283 [W/m²K]
 L = 1.94 [m]

Frame

U_B = 1.5 [W/m²K]
 L_B = 0.07 [m]

Glazing

U_C = 0.5 [W/m²K]
 L_C = 0.7 [m]

$$\Psi_2 = 0.283 * 1.94 - 0.100 * 1.0 - 1.5 * 0.07 - 0.5 * 0.7 = -0.006 \text{ [W/mK]}$$

Resultant linear thermal transmittance Ψ_e for the entire element (weighted with the length, at which the bridge occurs):

Length at which the bridge occurs for model 1
 l₁ = 0.13 m

Length at which the bridge occurs for model 2
 l₂ = 0.12 m

$$\Psi_e = (\Psi_1 * l_1 + \Psi_2 * l_2) / (l_1 + l_2) = (0.002 * 0.13 - 0.006 * 0.12) / (0.13 + 0.12)$$

$$\Psi_e = -0.002 \text{ [W/mK]}$$

Design temperature factor at the internal surface f_{Rsi}:

The minimum temperature θ_{si} at the connection between the frame and the jamb, obtained from the software, is 13.4 °C.

$$f_{Rsi} = (\theta_{si} - \theta_e) / (\theta_i - \theta_e) = (13.4 - (-20)) / (20 - (-20)) = 33.4 / 40$$

$$f_{Rsi} = 0.835$$

17.Connection between door frame and jamb (King Blok)

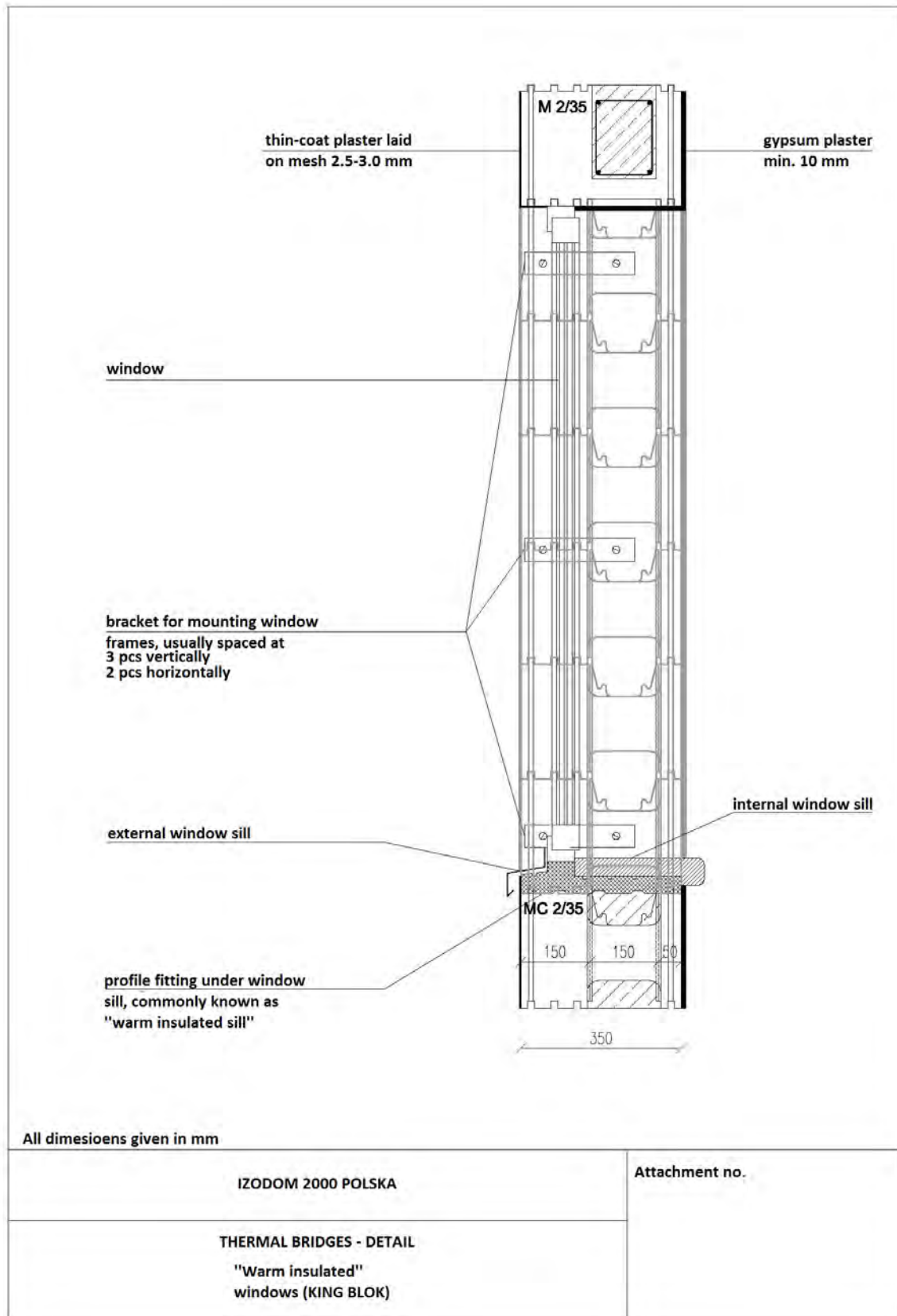

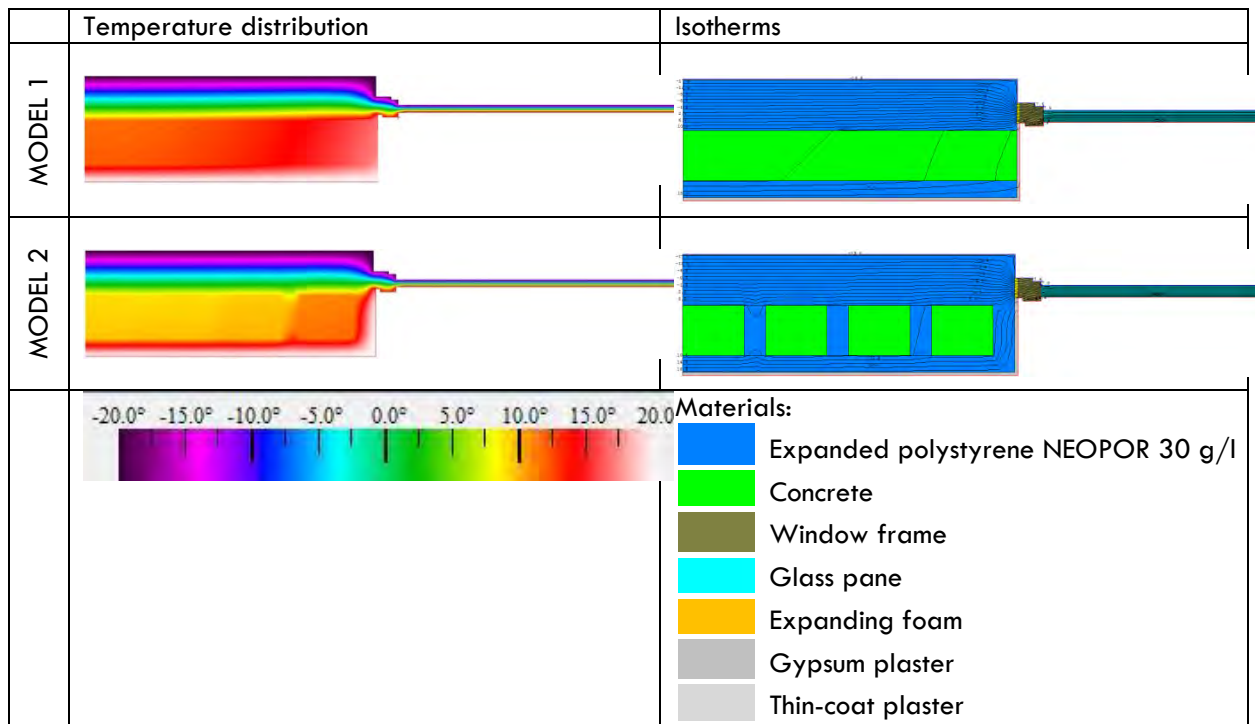

Value of thermal transmittance U_A at the external wall for model 1:

Description	d [m]	λ [W/mK]	R [m ² K/W]	U [W/m ² K]
Thermal resistance on the internal side			0.13	
Gypsum plaster	0.01	0.4	0.025	
Expanded polystyrene NEOPOR 30 g/l	0.05	0.031	1.613	
Concrete	0.15	1.7	0.088	
Expanded polystyrene NEOPOR 30 g/l	0.15	0.031	4.839	
Thin-coat mineral plaster	0.005	1.0	0.005	
Thermal resistance on the external side			0.04	
Total thickness	0.37		6.740	0.148

Value of linear thermal transmittance Ψ_1 calculated for model 1:

	U-factor W/m ² K	delta T C	Length mm
Edge	0.3409	40.0	1873

$U = 0.341$ [W/m²K]
 $L = 1.87$ [m]
 $U_A = 0.148$ [W/m²K]
 $L_A = 1.0$ [m]

Frame

$U_B = 1.5$ [W/m²K]
 $L_B = 0.07$ [m]

Glazing

$U_C = 0.50$ [W/m²K]
 $L_C = 0.7$ [m]

$$\Psi_1 = 0.341 * 1.87 - 0.148 * 1.0 - 1.5 * 0.07 - 0.50 * 0.7 = 0.035$$
 [W/mK]

Value of thermal transmittance U at the external wall for model 2:

	U-factor W/m ² ·K	delta T C	Length mm
Edge	0.1487	40.0	1000

$$U_A = 1 / R = 0.149 \text{ W/m}^2\text{K}$$

Value of linear thermal transmittance Ψ_2 calculated for model 2:

	U-factor W/m ² ·K	delta T C	Length mm
Edge	0.3312	40.0	1873

$$U = 0.331 \text{ [W/m}^2\text{K]}$$

$$L = 1.87 \text{ [m]}$$

$$U_A = 0.149 \text{ [W/m}^2\text{K]}$$

$$L_A = 1.0 \text{ [m]}$$

Frame

$$U_B = 1.5 \text{ [W/m}^2\text{K]}$$

$$L_B = 0.07 \text{ [m]}$$

Glazing

$$U_C = 0.50 \text{ [W/m}^2\text{K]}$$

$$L_C = 0.7 \text{ [m]}$$

$$\Psi_2 = 0.331 * 1.87 - 0.149 * 1.0 - 1.5 * 0.07 - 0.50 * 0.7 = 0.015 \text{ [W/mK]}$$

Resultant linear thermal transmittance Ψ_e for the entire element (weighted with the length, at which the bridge occurs):

Length at which the bridge occurs for model 1 $l_1 = 0.13 \text{ m}$

Length at which the bridge occurs for model 2 $l_2 = 0.12 \text{ m}$

$$\Psi_e = (\Psi_1 * l_1 + \Psi_2 * l_2) / (l_1 + l_2) = (0.035 * 0.13 + 0.015 * 0.12) / (0.13 + 0.12)$$

$$\Psi_e = 0.025 \text{ [W/mK]}$$

Design temperature factor at the internal surface f_{Rsi} :

The minimum temperature θ_{si} at the connection between the frame with the jamb, obtained from the software, is 11.7 °C.

$$f_{Rsi} = (\theta_{si} - \theta_e) / (\theta_i - \theta_e) = (11.7 - (-20)) / (20 - (-20)) = 31.7 / 40$$

$$f_{Rsi} = 0.793$$

18.Suspended floor slabs (Super King Blok)

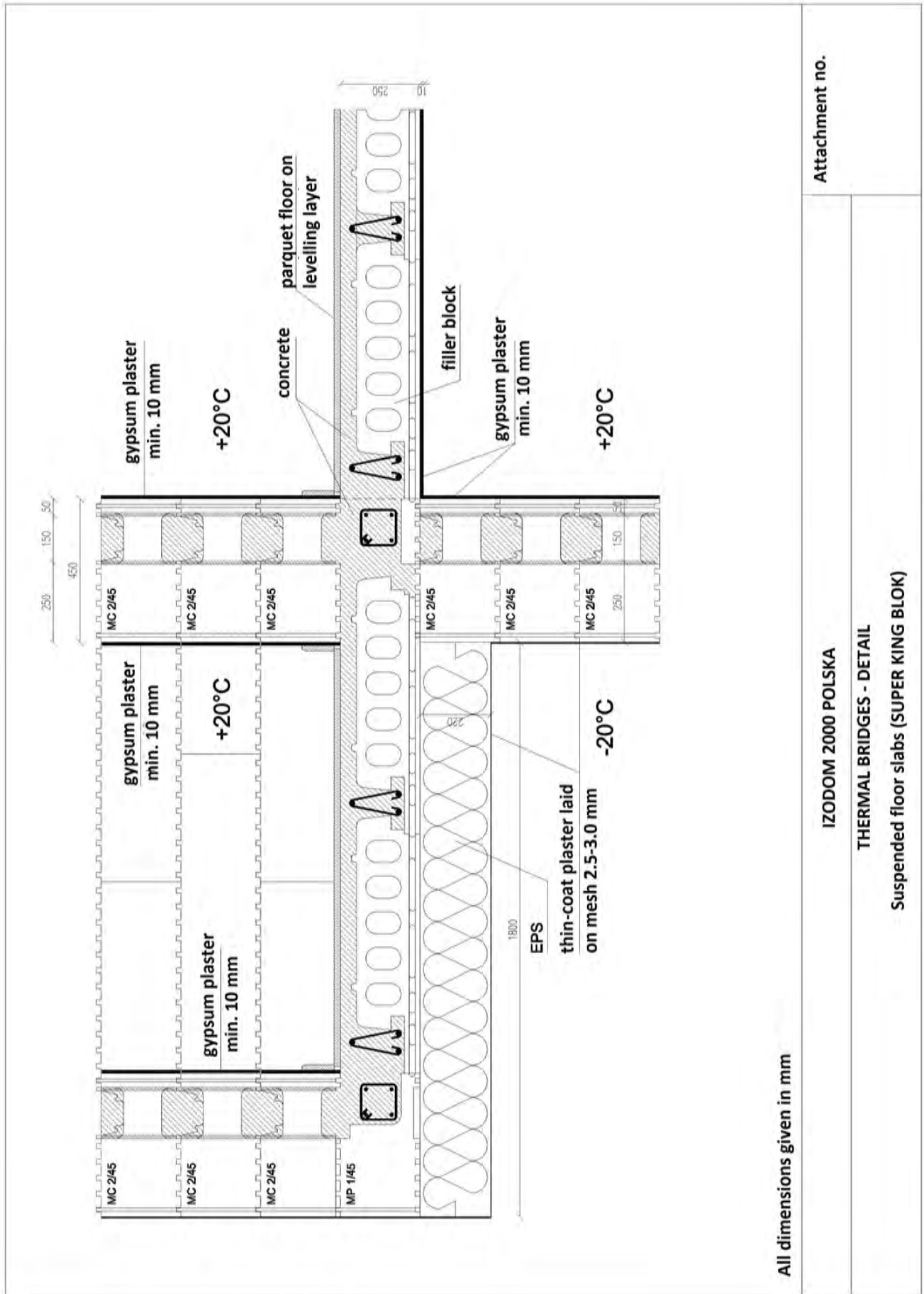

All dimensions given in mm

Attachment no.

IZODOM 2000 POLSKA

THERMAL BRIDGES - DETAIL

Suspended floor slabs (SUPER KING BLOK)

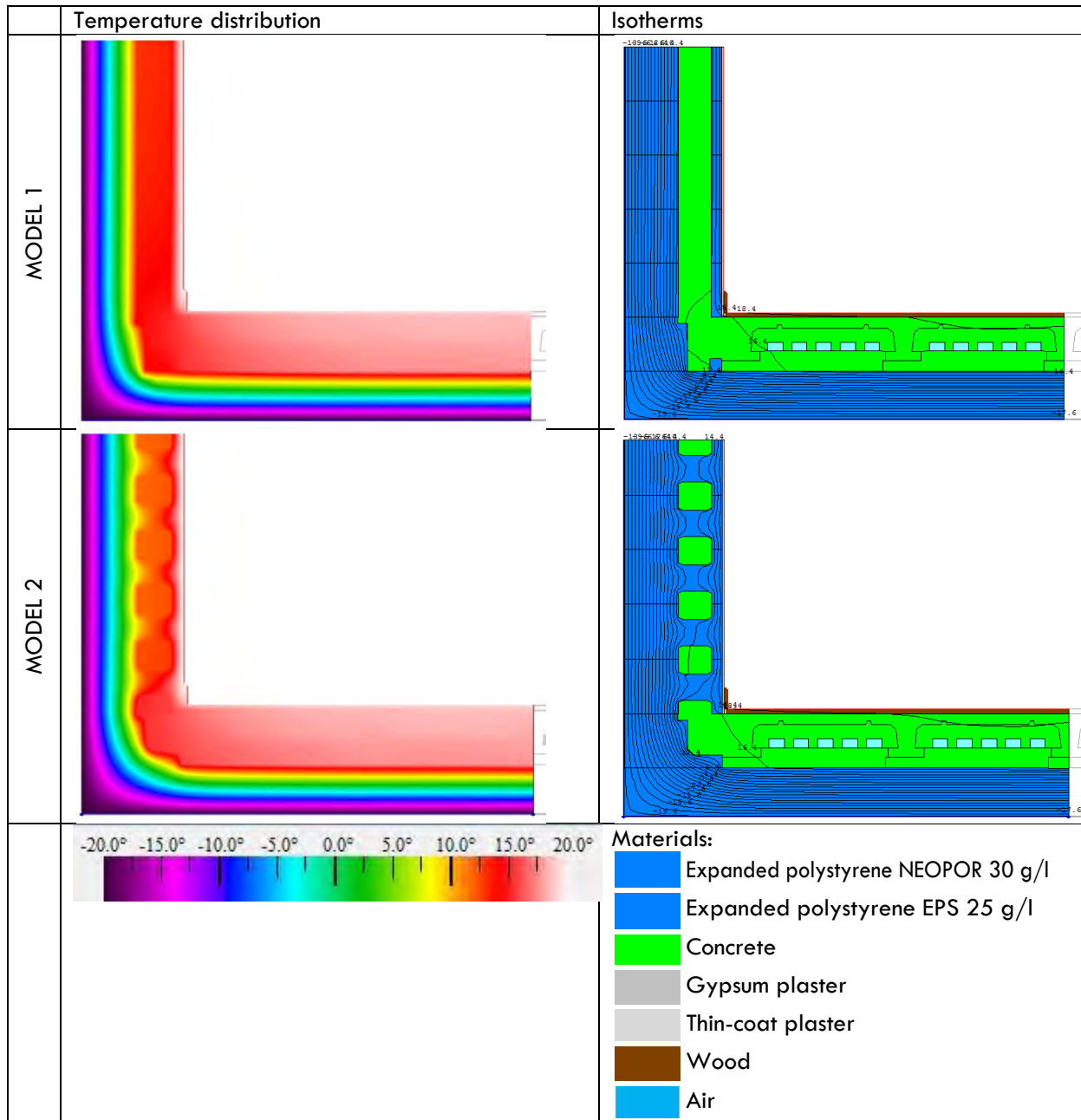

Value of thermal transmittance U_A at the floor slab for model 1:

Description	d	λ	R	U
	[m]	[W/mK]	[m ² K/W]	[W/m ² K]
Thermal resistance on the internal side			0.13	
Gypsum plaster	0.01	0.4	0.025	
Expanded polystyrene NEOPOR 30 g/l	0.05	0.031	1.613	
Concrete	0.15	1.7	0.088	
Expanded polystyrene NEOPOR 30 g/l	0.25	0.031	8.065	
Thin-coat mineral plaster	0.005	1.0	0.005	
Thermal resistance on the external side			0.04	
Total thickness	0.47		9.966	0.100

Value of thermal transmittance U_B at the slab for model 1:

Description	d	λ	R	U
	[m]	[W/mK]	[m ² K/W]	[W/m ² K]
Thermal resistance on the internal side			0.17	
Wooden floor	0.02	0.16	0.125	
Concrete	0.25	1.7	0.106	
Expanded polystyrene EPS 25 g/l	0.22	0.034	6.471	
Thin-coat mineral plaster	0.005	1.0	0.005	
Thermal resistance on the external side			0.04	
Total thickness	0.495		6.958	0.144

Value of linear thermal transmittance Ψ_1 calculated for model 1:

	U-factor W/m ² K	delta T C	Length mm
Edge	0.1106	40.0	3767.91

$$U = 0.111 \text{ [W/m}^2\text{K]}$$

$$L = 3.77 \text{ [m]}$$

$$U_A = 0.100 \text{ [W/m}^2\text{K]}$$

$$L_A = 1.72 \text{ [m]}$$

$$U_B = 0.144 \text{ [W/m}^2\text{K]}$$

$$L_B = 2.04 \text{ [m]}$$

$$\Psi_1 = 0.111 * 3.77 - 0.100 * 1.72 - 0.144 * 2.04 = -0.047 \text{ [W/mK]}$$

Value of thermal transmittance U at the external wall for model 2:

Całkowity opórcieplny

	R-Value m ² K/W	delta T C	Length mm
Edge	10.3698	40.0	1250

$$R = 10.3698 \text{ m}^2\text{K/W}$$

	U-factor W/m ² K	delta T C	Length mm
Edge	0.0964	40.0	1250

$$U_A = 1 / R = 0.096 \text{ W/m}^2\text{K}$$

Value of linear thermal transmittance Ψ_2 calculated for model 2:

	U-factor W/m ² K	delta T C	Length mm
Edge	0.1058	40.0	3767.31

$$U = 0.106 \text{ [W/m}^2\text{K]}$$

$$L = 3.77 \text{ [m]}$$

$$U_A = 0.096 \text{ [W/m}^2\text{K]}$$

$$L_A = 1.72 \text{ [m]}$$

$$U_B = 0.144 \text{ [W/m}^2\text{K]}$$

$$L_B = 2.04 \text{ [m]}$$

$$\Psi_2 = 0,106 * 3,77 - 0,096 * 1,72 - 0,1358 * 2,04 = -0,059 \text{ [W/mK]}$$

Resultant linear thermal transmittance Ψ_e for the entire element (weighted with the length, at which the bridge occurs):

Length (width) at which the bridge occurs for model 1 $l_1 = 0.185 \text{ m}$

Length (width) at which the bridge occurs for model 2 $l_2 = 0.065 \text{ m}$

$$\Psi_e = (\Psi_1 * l_1 + \Psi_2 * l_2) / (l_1 + l_2) = (-0.047 * 0.185 - 0.059 * 0.065) / (0.185 + 0.065)$$

$$\Psi_e = -0.050 \text{ [W/mK]}$$

Design temperature factor at the internal surface f_{Rsi} :

The minimum temperature θ_{si} at the internal surface of wall, obtained from the software, is $16.9 \text{ }^\circ\text{C}$.

$$f_{Rsi} = (\theta_{si} - \theta_e) / (\theta_i - \theta_e) = (16.9 - (-20)) / (20 - (-20)) = 36.9 / 40$$

$$f_{Rsi} = 0.923$$

19.Suspended floor slabs (King Blok)

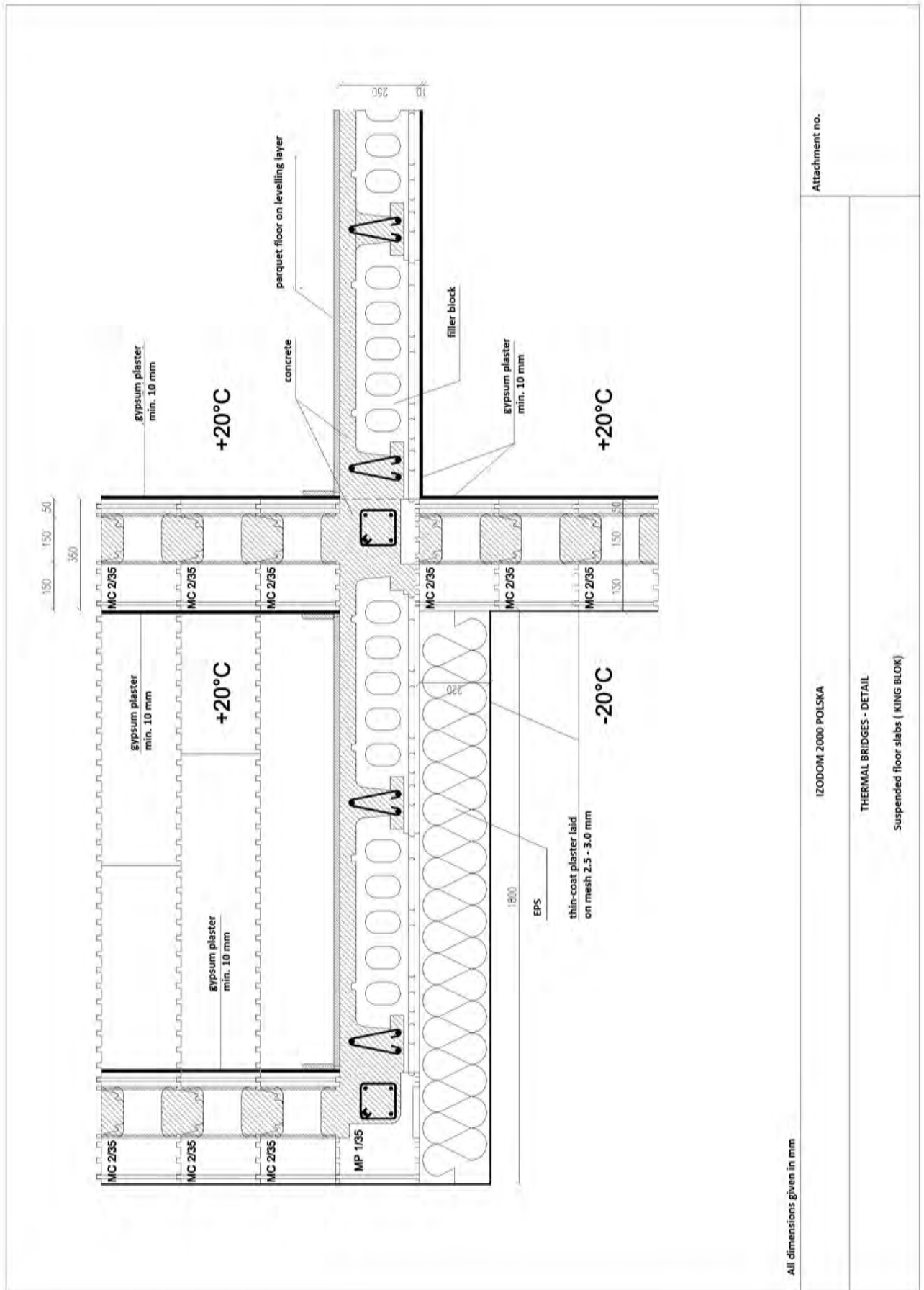

All dimensions given in mm

IZODOM 2000 POLSKA

THERMAL BRIDGES - DETAIL

Suspended floor slabs (KING BLOK)

Attachment no.

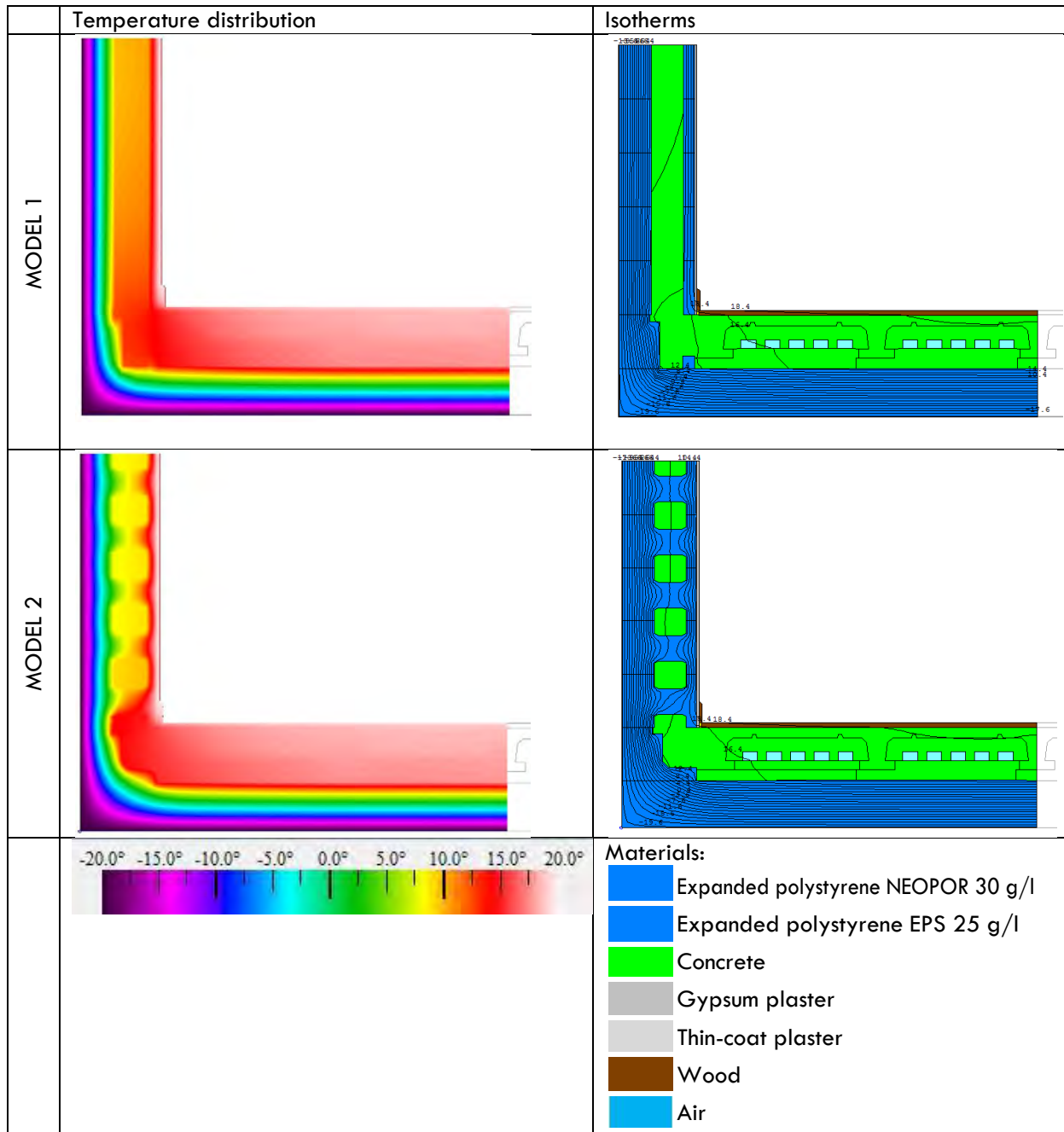

Value of thermal transmittance U_A at the external wall for model 1:

Description	d	λ	R	U
	[m]	[W/mK]	[m ² K/W]	[W/m ² K]
Thermal resistance on the internal side			0.13	
Gypsum plaster	0.01	0.4	0.025	
Expanded polystyrene NEOPOR 30 g/l	0.05	0.031	1.613	
Concrete	0.15	1.7	0.088	
Expanded polystyrene NEOPOR 30 g/l	0.15	0.031	4.839	
Thin-coat mineral plaster	0.005	1.0	0.005	
Thermal resistance on the external side			0.04	
Total thickness	0.37		6.740	0.148

Value of thermal transmittance U_B at the slab for model 1:

Description	d	λ	R	U
	[m]	[W/mK]	[m ² K/W]	[W/m ² K]
Thermal resistance on the internal side			0.17	
Wooden floor	0.02	0.16	0.125	
Concrete	0.25	1.7	0.106	
Expanded polystyrene EPS 25 g/l	0.22	0.034	6.471	
Thin-coat mineral plaster	0.005	1.0	0.005	
Thermal resistance on the external side			0.04	
Total thickness	0.495		6.958	0.144

Value of linear thermal transmittance Ψ_1 calculated for model 1:

	U-factor W/m ² -K	delta T C	Length mm
Edge	0.1342	40.0	3672.01

$$U_A = 0.148 \text{ [W/m}^2\text{K]}$$

$$L_A = 1.72 \text{ [m]}$$

$$U_B = 0.144 \text{ [W/m}^2\text{K]}$$

$$L_B = 1.95 \text{ [m]}$$

$$U = 0.134 \text{ [W/m}^2\text{K]}$$

$$L = 3.67 \text{ [m]}$$

$$\Psi_1 = 0.134 * 3.67 - 0.148 * 1.72 - 0.144 * 1.95 = -0.044 \text{ [W/mK]}$$

Value of thermal transmittance U at the external wall for model 2:

Total thermal resistance

	R-Value m ² -K/W	delta T C	Length mm
Edge	7.2443	40.0	1250

$$R = 7.2443 \text{ m}^2\text{K/W}$$

	U-factor W/m ² -K	delta T C	Length mm
Edge	0.1380	40.0	1250

$$U_A = 1 / R = 0.138 \text{ W/m}^2\text{K}$$

Value of linear thermal transmittance Ψ_2 calculated for model 2:

	U-factor W/m ² -K	delta T C	Length mm
Edge	0.1258	40.0	3672.27

$$U = 0.126 \text{ [W/m}^2\text{K]}$$

$$L = 3.67 \text{ [m]}$$

$$U_A = 0.138 \text{ [W/m}^2\text{K]}$$

$$L_A = 1.72 \text{ [m]}$$

$$U_B = 0.144 \text{ [W/m}^2\text{K]}$$

$$L_B = 1.95 \text{ [m]}$$

$$\Psi_2 = 0.126 * 3.67 - 0.138 * 1.72 - 0.144 * 1.95 = -0.056 \text{ [W/mK]}$$

Resultant linear thermal transmittance Ψ_e for the entire element (weighted with the length, at which the bridge occurs):

Length (width) at which the bridge occurs for model 1 $l_1 = 0.185 \text{ m}$

Length (width) at which the bridge occurs for model 2 $l_2 = 0.065 \text{ m}$

$$\Psi_e = (\Psi_1 * l_1 + \Psi_2 * l_2) / (l_1 + l_2) = (-0.044 * 0.185 - 0.056 * 0.065) / (0.185 + 0.065)$$

$$\Psi_e = -0.047 \text{ [W/mK]}$$

Design temperature factor at the internal surface f_{Rsi} :

The minimum temperature θ_{si} at the internal surface of wall, obtained from the software, is 16.9 °C.

$$f_{Rsi} = (\theta_{si} - \theta_e) / (\theta_i - \theta_e) = (16.9 - (-20)) / (20 - (-20)) = 36.9 / 40$$

$$f_{Rsi} = 0.923$$

20.Suspended floor slabs (Super King Blok) – option 2

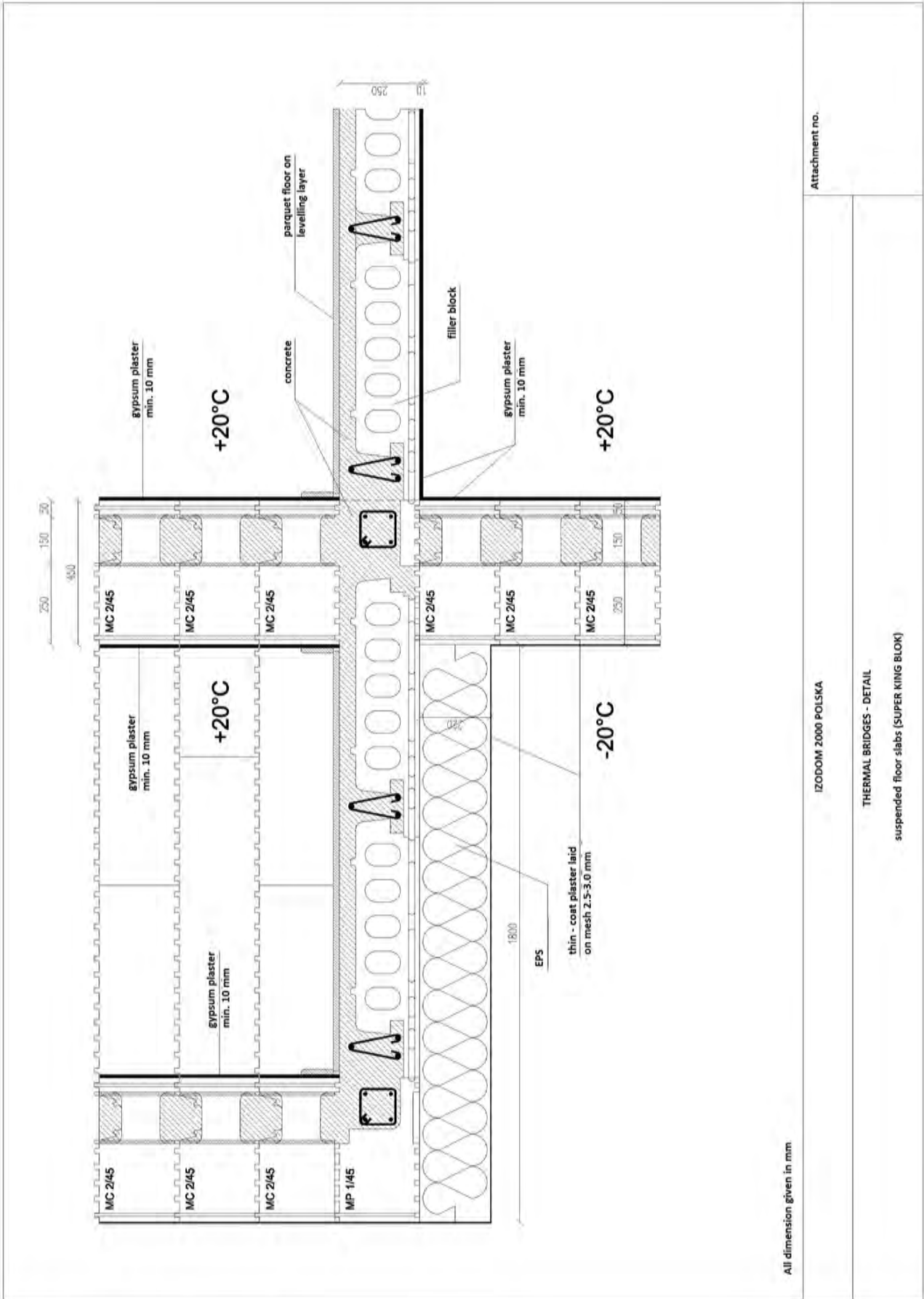

Attachment no.

IZODOM 2000 POLSKA

THERMAL BRIDGES - DETAIL

suspended floor slabs (SUPER KING BLOK)

All dimension given in mm

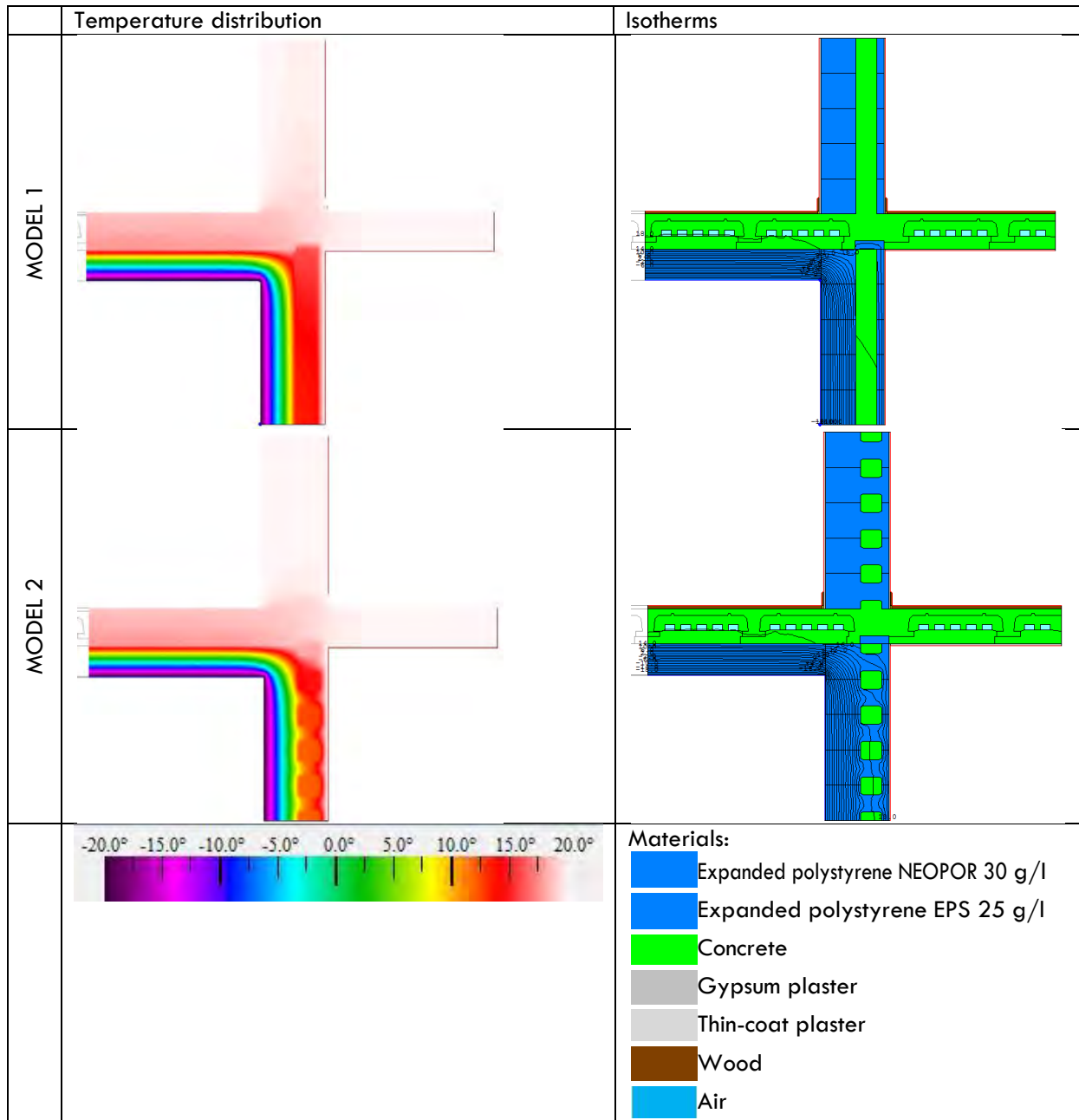

Value of thermal transmittance U_A at the external wall for model 1:

Description	d	λ	R	U
	[m]	[W/mK]	[m ² K/W]	[W/m ² K]
Thermal resistance on the internal side			0.13	
Gypsum plaster	0.01	0.4	0.025	
Expanded polystyrene NEOPOR 30 g/l	0.05	0.031	1.613	
Concrete	0.15	1.7	0.088	
Expanded polystyrene NEOPOR 30 g/l	0.25	0.031	8.065	
Thin-coat mineral plaster	0.005	1.0	0.005	
Thermal resistance on the external side			0.04	
Total thickness	0.47		9.966	0.100

Value of thermal transmittance U_B at the slab for model 1:

Description	d	λ	R	U
	[m]	[W/mK]	[m ² K/W]	[W/m ² K]
Thermal resistance on the internal side			0.17	
Wooden floor	0.02	0.16	0.125	
Concrete	0.25	1.7	0.106	
Expanded polystyrene EPS 25 g/l	0.22	0.034	6.471	
Thin-coat mineral plaster	0.005	1.0	0.005	
Thermal resistance on the external side			0.04	
Total thickness	0.495		6.958	0.144

Value of linear thermal transmittance Ψ_1 calculated for model 1:

	U-factor W/m ² K	delta T C	Length mm
Edge	0.1337	40.0	2274.09

$$U = 0.134 \text{ [W/m}^2\text{K]}$$

$$L = 2.27 \text{ [m]}$$

$$U_A = 0.100 \text{ [W/m}^2\text{K]}$$

$$L_A = 1.03 \text{ [m]}$$

$$U_B = 0.144 \text{ [W/m}^2\text{K]}$$

$$L_B = 1.25 \text{ [m]}$$

$$\Psi_1 = 0.134 * 2.27 - 0.100 * 1.03 - 0.144 * 1.25 = 0.021 \text{ [W/mK]}$$

Value of thermal transmittance U at the external wall for model 2:

Total thermal resistance

	R-Value m ² K/W	delta T C	Length mm
Edge	10.3698	40.0	1250

$$R = 10.3698 \text{ m}^2\text{K/W}$$

	U-factor W/m ² K	delta T C	Length mm
Edge	0.0964	40.0	1250

$$U_A = 1 / R = 0.096 \text{ W/m}^2\text{K}$$

Value of linear thermal transmittance Ψ_2 calculated for model 2:

	U-factor W/m ² K	delta T C	Length mm
Edge	0.1298	40.0	2279.89

$$U = 0.130 \text{ [W/m}^2\text{K]}$$

$$L = 2.28 \text{ [m]}$$

$$U_A = 0.096 \text{ [W/m}^2\text{K]}$$

$$L_A = 1.03 \text{ [m]}$$

$$U_B = 0.144 \text{ [W/m}^2\text{K]}$$

$$L_B = 1.25 \text{ [m]}$$

$$\Psi_2 = 0.130 * 2.28 - 0.096 * 1.03 - 0.144 * 1.25 = 0.016 \text{ [W/mK]}$$

Resultant linear thermal transmittance Ψ_e for the entire element (weighted with the length, at which the bridge occurs):

Length (width) at which the bridge occurs for model 1 $l_1 = 0.185 \text{ m}$

Length (width) at which the bridge occurs for model 2 $l_2 = 0.065 \text{ m}$

$$\Psi_e = (\Psi_1 * l_1 + \Psi_2 * l_2) / (l_1 + l_2) = (0.021 * 0.185 + 0.016 * 0.065) / (0.185 + 0.065)$$

$$\Psi_e = 0.020 \text{ [W/mK]}$$

Design temperature factor at the internal surface f_{Rsi} :

The minimum temperature θ_{si} at the internal surface of wall, obtained from the software, is 19.1 °C.

$$f_{Rsi} = (\theta_{si} - \theta_e) / (\theta_i - \theta_e) = (19.1 - (-20)) / (20 - (-20)) = 39.1 / 40$$

$$f_{Rsi} = 0.978$$

21.Suspended floor slabs (King Blok) – option 2

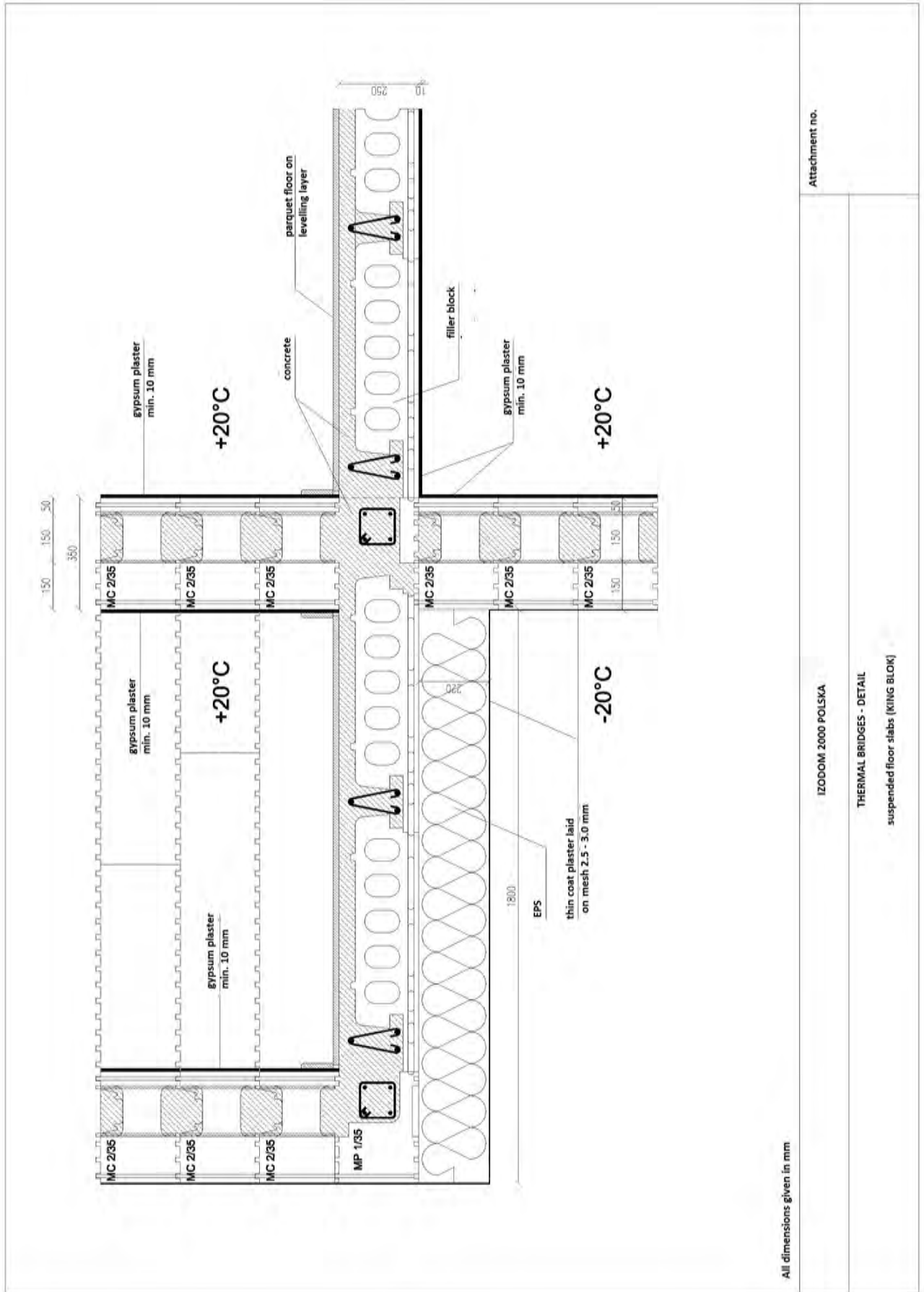

All dimensions given in mm

Attachment no.

IZODOM 2000 POLSKA

THERMAL BRIDGES - DETAIL

suspended floor slabs (KING BLOK)

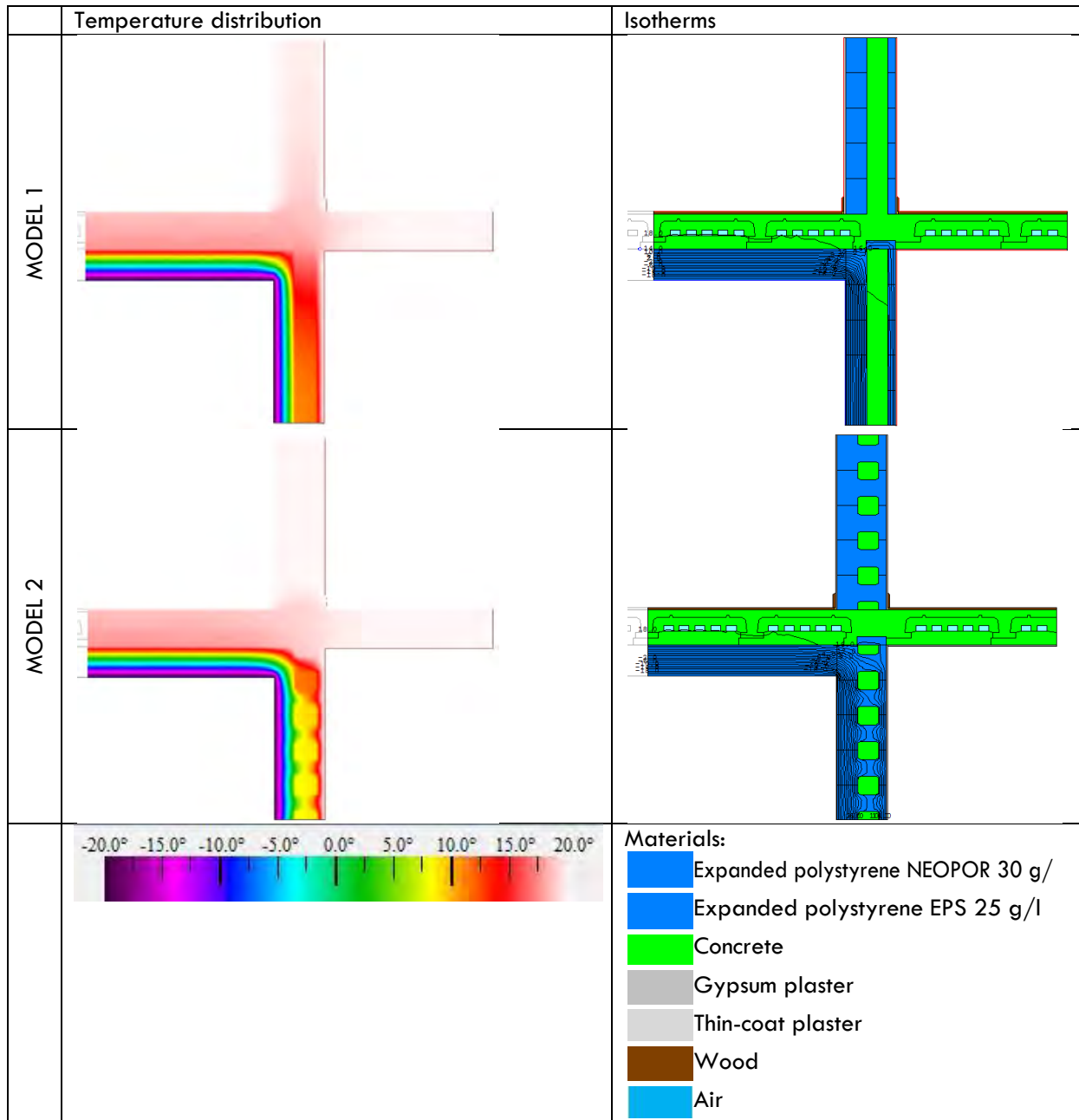

Value of thermal transmittance U_A at the external wall for model 1:

Description	d	λ	R	U
	[m]	[W/mK]	[m ² K/W]	[W/m ² K]
Thermal resistance on the internal side			0.13	
Gypsum plaster	0.01	0.4	0.025	
Expanded polystyrene NEOPOR 30 g/l	0.05	0.031	1.613	
Concrete	0.15	1.7	0.088	
Expanded polystyrene NEOPOR 30 g/l	0.15	0.031	4.839	
Thin-coat mineral plaster	0.005	1.0	0.005	
Thermal resistance on the external side			0.04	
Total thickness	0.47		6.740	0.148

Value of thermal transmittance U_B at the slab for model 1:

Description	d	λ	R	U
	[m]	[W/mK]	[m ² K/W]	[W/m ² K]
Thermal resistance on the internal side			0.17	
Wooden floor	0.02	0.16	0.125	
Concrete	0.25	1.7	0.106	
Expanded polystyrene EPS 25 g/l	0.22	0.034	6.471	
Thin-coat mineral plaster	0.005	1.0	0.005	
Thermal resistance on the external side			0.04	
Total thickness	0.495		6.958	0.144

Value of linear thermal transmittance Ψ_1 calculated for model 1:

	U-factor W/m ² K	delta T C	Length mm
Edge	0.1571	40.0	2378.42

U = 0.157 [W/m²K]
L = 2.38 [m]

$U_A = 0.148$ [W/m²K]
 $L_A = 1.03$ [m]
 $U_B = 0.144$ [W/m²K]
 $L_B = 1.34$ [m]

$$\Psi_1 = 0.157 * 2.38 - 0.148 * 1.03 - 0.144 * 1.34 = 0.028 \text{ [W/mK]}$$

Value of thermal transmittance U at the external wall for model 2:

Total thermal resistance

	R-Value m ² K/W	delta T C	Length mm
Edge	7.2443	40.0	1250

R = 7.2443 m²K/W

	U-factor W/m ² K	delta T C	Length mm
Edge	0.1380	40.0	1250

$U_A = 1 / R = 0.138$ W/m²K

Value of linear thermal transmittance Ψ_2 calculated for model 2:

	U-factor W/m ² K	delta T C	Length mm
Edge	0.1483	40.0	2371.35

U = 0.148 [W/m²K]
L = 2.37 [m]
 $U_A = 0.138$ [W/m²K]
 $L_A = 1.03$ [m]
 $U_B = 0.144$ [W/m²K]
 $L_B = 1.34$ [m]

$$\Psi_2 = 0.148 * 2.37 - 0.138 * 1.03 - 0.144 * 1.34 = 0.016 \text{ [W/mK]}$$

Resultant linear thermal transmittance Ψ_e for the entire element (weighted with the length, at which the bridge occurs):

Length (width) at which the bridge occurs for model 1 $l_1 = 0.185$ m

Length (width) at which the bridge occurs for model 2 $l_2 = 0.065$ m

$$\Psi_e = (\Psi_1 * l_1 + \Psi_2 * l_2) / (l_1 + l_2) = (0.028 * 0.185 + 0.016 * 0.065) / (0.185 + 0.065)$$

$$\Psi_e = 0.025 \text{ [W/mK]}$$

Design temperature factor at the internal surface f_{Rsi} :









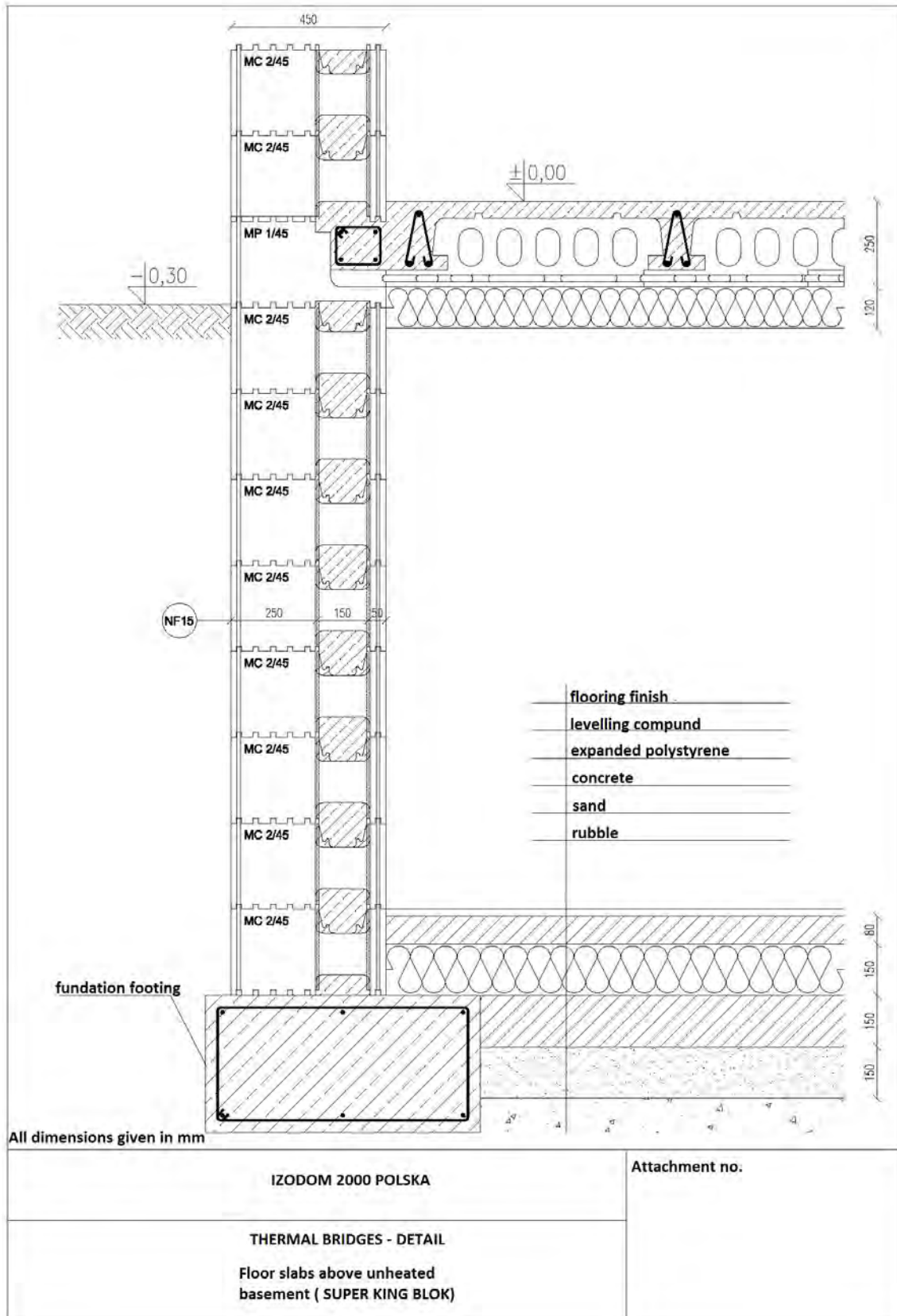

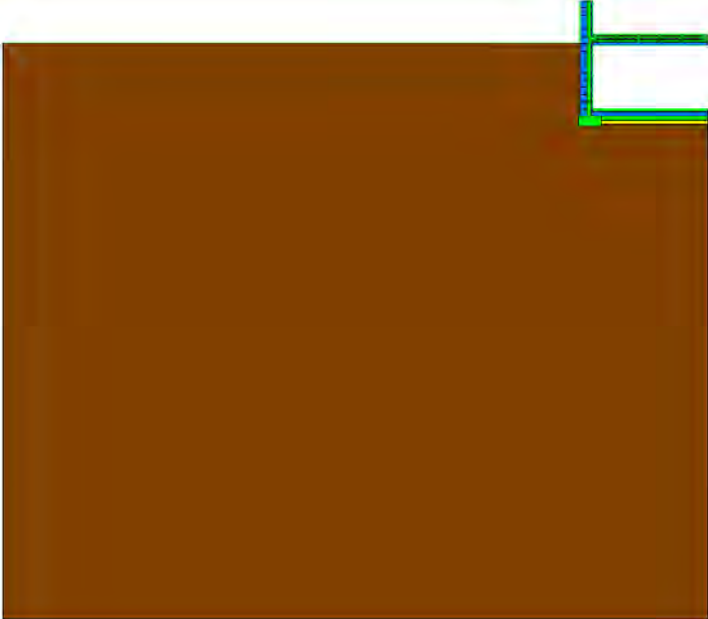

















The minimum temperature θ_{si} at the internal surface of wall, obtained from the software, is 19.1 °C.

$$f_{Rsi} = (\theta_{si} - \theta_e) / (\theta_i - \theta_e) = (19.1 - (-20)) / (20 - (-20)) = 39.1 / 40$$

$$f_{Rsi} = 0.978$$

22. Floor slabs above unheated basement (Super King Blok)



MODEL 1																					
MODEL 2																					
Materials:	<table border="0"> <tr> <td data-bbox="264 1469 363 1525"></td> <td data-bbox="368 1480 778 1525">Expanded polystyrene NEOPOR 30 g/l</td> <td data-bbox="823 1469 922 1525"></td> <td data-bbox="927 1480 1018 1525">Ground</td> </tr> <tr> <td data-bbox="264 1532 363 1588"></td> <td data-bbox="368 1543 778 1588">Expanded polystyrene EPS 25 g/l</td> <td data-bbox="823 1532 922 1588"></td> <td data-bbox="927 1543 991 1588">Sand</td> </tr> <tr> <td data-bbox="264 1594 363 1650"></td> <td data-bbox="368 1606 475 1650">Concrete</td> <td data-bbox="823 1594 922 1650"></td> <td data-bbox="927 1606 967 1650">Air</td> </tr> <tr> <td data-bbox="264 1657 363 1713"></td> <td data-bbox="368 1668 560 1713">Gypsum plaster</td> <td data-bbox="823 1657 922 1713"></td> <td data-bbox="927 1668 1038 1713">Floor tiles</td> </tr> <tr> <td data-bbox="264 1720 363 1776"></td> <td data-bbox="368 1731 576 1776">Thin-coat plaster</td> <td></td> <td></td> </tr> </table>		Expanded polystyrene NEOPOR 30 g/l		Ground		Expanded polystyrene EPS 25 g/l		Sand		Concrete		Air		Gypsum plaster		Floor tiles		Thin-coat plaster		
	Expanded polystyrene NEOPOR 30 g/l		Ground																		
	Expanded polystyrene EPS 25 g/l		Sand																		
	Concrete		Air																		
	Gypsum plaster		Floor tiles																		
	Thin-coat plaster																				

CALCULATIONS FOR MODEL 1:

Assuming the calculation conditions provided in Annexe C to PN-EN ISO 10211:2008 (Table 1), the following values are obtained:

$$L_1 = 5.16 \text{ m} * 0.2555 \text{ [W/m}^2\text{K]} = 1.318 \text{ [W/mK]}$$

$$L_2 = 21.467 \text{ m} * 0.0447 \text{ [W/m}^2\text{K]} = 0.960 \text{ [W/mK]}$$

$$L_3 = 10.16 \text{ m} * 0.1894 \text{ [W/m}^2\text{K]} = 1.924 \text{ [W/mK]}$$

The linear thermal coupling coefficients between individual environments are as follows:

$$L_{iv} = 1.142 \text{ [W/mK]}$$

$$L_{ie} = 0.177 \text{ [W/mK]}$$

$$L_{ue} = 0.783 \text{ [W/mK]}$$

The linear thermal coupling coefficient L^{2D} is equal to:

$L^{2D} = 0.641 \text{ [W/mK]}$

Value of thermal transmittance U_w at the external wall for model 1:

Description	d	λ	R	U
	[m]	[W/mK]	[m ² K/W]	[W/m ² K]
Thermal resistance on the internal side			0.13	
Gypsum plaster	0.01	0.4	0.025	
Expanded polystyrene NEOPOR 30 g/l	0.05	0.031	1.613	
Concrete	0.15	1.7	0.088	
Expanded polystyrene NEOPOR 30 g/l	0.25	0.031	8.065	
Thin-coat mineral plaster	0.005	1.0	0.005	
Thermal resistance on the external side			0.04	
Total thickness	0.47		9.966	0.100

Thermal transmittance at space dividers in contact with the ground U_g for model 1 is calculated using the method specified in PN-EN ISO 13370:2008.

$$U_g = 0.148 \text{ [W/m}^2\text{K]}$$

The final value of linear thermal transmittance Ψ_e [W/mK] is equal to:

$$\Psi_{e1} = L^{2D} - (h_w + h_f) U_w - 0.5 * (B' + w) U_g = 0.641 - 1.47 * 0.100 - 4.46 * 0.148 = \mathbf{-0.166 \text{ [W/mK]}}$$

CALCULATIONS FOR MODEL 2:

Assuming the calculation conditions provided in Annexe C to PN-EN ISO 10211:2008 (Table 1), the following values are obtained:

$$L_1 = 5.16 \text{ m} * 0.224 \text{ [W/m}^2\text{K]} = 1.156 \text{ [W/mK]}$$

$$L_2 = 21.467 \text{ m} * 0.040 \text{ [W/m}^2\text{K]} = 0.859 \text{ [W/mK]}$$

$$L_3 = 10.16 \text{ m} * 0.169 \text{ [W/m}^2\text{K]} = 1.715 \text{ [W/mK]}$$

The linear thermal coupling coefficient L^{2D} is equal to:

$L^{2D} = 0.566 \text{ [W/mK]}$

The linear thermal coupling coefficients between individual environments are as follows:

$$L_{iv} = 1.006 \text{ [W/mK]}$$

$$L_{ie} = 0.150 \text{ [W/mK]}$$

$$L_{ue} = 0.709 \text{ [W/mK]}$$

Value of thermal transmittance U_w at the external wall for model 2:

	U-factor W/m ² K	delta T C	Length mm
Edge	0.0935	40.0	1250

$$U_w = 0.094 \text{ W/m}^2\text{K}$$

Thermal transmittance at space dividers in contact with the ground U_g for model 1 is calculated using the method specified in PN-EN ISO 13370:2008.

$$U_g = 0.147 \text{ [W/m}^2\text{K]}$$

The final value of linear thermal transmittance Ψ_e [W/mK] is equal to:

$$\Psi_{e2} = L^{2D} - (h_w + h_f) U_w - 0.5 * (B' + w) U_g = 0,566 - 1.47 * 0.094 - 4.46 * 0.147 = -0.231 \text{ [W/mK]}$$

Resultant linear thermal transmittance Ψ_e for the entire element (weighted with the length, at which the bridge occurs):

Length (width) at which the bridge occurs for model 1 $l_1 = 0.185 \text{ m}$

Length (width) at which the bridge occurs for model 2 $l_2 = 0.065 \text{ m}$

$$\Psi_e = (\Psi_{e1} * l_1 + \Psi_{e2} * l_2) / (l_1 + l_2) = (-0.166 * 0.185 - 0.231 * 0.065) / (0.185 + 0.065)$$

$$\Psi_e = -0.183 \text{ [W/mK]}$$

Design temperature factor at the internal surface f_{Rsi} :



The minimum temperature θ_{si} at the internal surface of wall, obtained from the software, is 17.6°C .

$$f_{Rsi} = (\theta_{si} - \theta_e) / (\theta_i - \theta_e) = (17.6 - (-20)) / (20 - (-20)) = 37.6 / 40$$

$$f_{Rsi} = 0.940$$

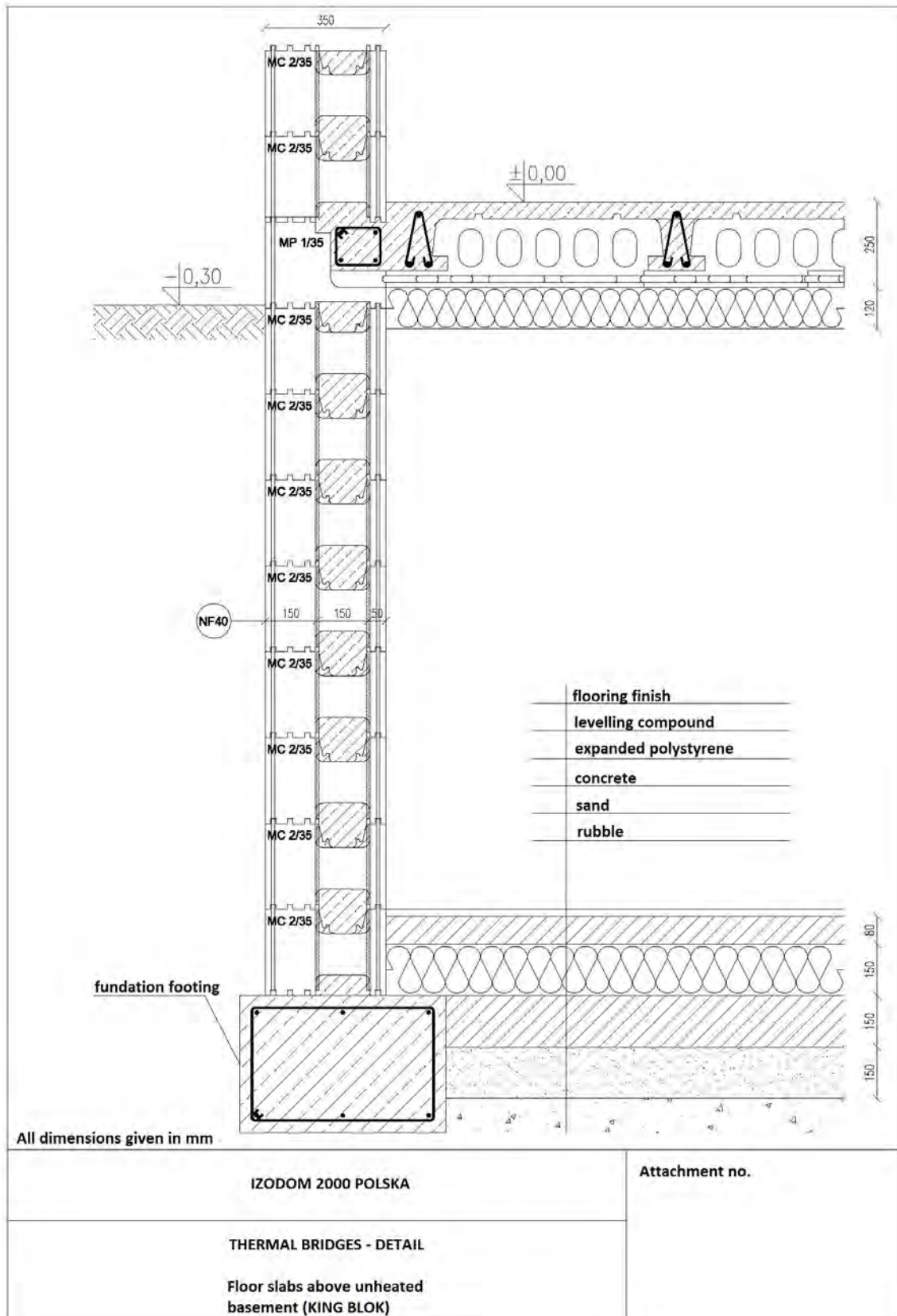
23. Floor slabs above unheated basement (King Blok)



MODEL 1			
MODEL 2			
Materials:	<table style="width: 100%; border: none;"> <tr> <td style="width: 50%; vertical-align: top;"> <ul style="list-style-type: none"> Expanded polystyrene NEOPOR 30 g/l Expanded polystyrene EPS 25 g/l Concrete Gypsum plaster Thin-coat plaster </td> <td style="width: 50%; vertical-align: top;"> <ul style="list-style-type: none"> Ground Sand Air Floor tiles </td> </tr> </table>	<ul style="list-style-type: none"> Expanded polystyrene NEOPOR 30 g/l Expanded polystyrene EPS 25 g/l Concrete Gypsum plaster Thin-coat plaster 	<ul style="list-style-type: none"> Ground Sand Air Floor tiles
<ul style="list-style-type: none"> Expanded polystyrene NEOPOR 30 g/l Expanded polystyrene EPS 25 g/l Concrete Gypsum plaster Thin-coat plaster 	<ul style="list-style-type: none"> Ground Sand Air Floor tiles 		

CALCULATIONS FOR MODEL 1:

Assuming the calculation conditions provided in Annexe C to PN-EN ISO 10211:2008 (Table 1), the following values are obtained:

$$L_1 = 5.16 \text{ m} * 0.2685 \text{ [W/m}^2\text{K]} = 1.385 \text{ [W/mK]}$$

$$L_2 = 21.467 \text{ m} * 0.0519 \text{ [W/m}^2\text{K]} = 1.114$$

[W/mK]
 $L_3 = 10.16 \text{ m} * 0.1942 \text{ [W/m}^2\text{K]} = 1.973 \text{ [W/mK]}$

$L_{iv} = 1.122 \text{ [W/mK]}$
 $L_{ie} = 0.263 \text{ [W/mK]}$
 $L_{ue} = 0.851 \text{ [W/mK]}$

The linear thermal coupling coefficients between individual environments are as follows:

The linear thermal coupling coefficient L^{2D} is equal to:

$L^{2D} = 0.747 \text{ [W/mK]}$

Value of thermal transmittance U_w at the external wall for model 1:

Description	d	λ	R	U
	[m]	[W/mK]	[m ² K/W]	[W/m ² K]
Thermal resistance on the internal side			013	
Gypsum plaster	0.01	0.4	0.025	
Expanded polystyrene NEOPOR 30 g/l	0.05	0.031	1.613	
Concrete	0.15	1.7	0.088	
Expanded polystyrene NEOPOR 30 g/l	0.15	0.031	4.839	
Thin-coat mineral plaster	0.005	1.0	0.005	
Thermal resistance on the external side			0.04	
Total thickness	0.47		6.740	0.148

Thermal transmittance at space dividers in contact with the ground U_g for model 1 is calculated using the method specified in PN- EN ISO 13370:2008.

$U_g = 0.152 \text{ [W/m}^2\text{K]}$

The final value of linear thermal transmittance Ψ_e [W/mK] is equal to:

$\Psi_{e1} = L^{2D} - (h_w + h_f) U_w - 0.5 * (B' + w) U_g$
 $= 0.747 - 1.47 * 0.148 - 4.36 * 0.152$
 $= -0.133 \text{ [W/mK]}$

CALCULATIONS FOR MODEL 2:

Assuming the calculation conditions provided in Annexe C to PN-EN ISO 10211:2008 (Table 1), the following values are obtained:

$L_1 = 5.16 \text{ m} * 0.236 \text{ [W/m}^2\text{K]} = 1.217 \text{ [W/mK]}$
 $L_2 = 21.467 \text{ m} * 0.0465 \text{ [W/m}^2\text{K]} = 0.998 \text{ [W/mK]}$
 $L_3 = 10.16 \text{ m} * 0.175 \text{ [W/m}^2\text{K]} = 1.781 \text{ [W/mK]}$

The linear thermal coupling coefficients between individual environments are as follows:

$L_{iv} = 1.000 \text{ [W/mK]}$
 $L_{ie} = 0.217 \text{ [W/mK]}$
 $L_{ue} = 0.781 \text{ [W/mK]}$

The linear thermal coupling coefficient L^{2D} is equal to:

$L^{2D} = 0.656 \text{ [W/mK]}$

Value of thermal transmittance U_w at the external wall for model 2:

	U-factor W/m ² K	delta T C	Length mm
Edge	0.1339	40.0	1250

$U_w = 0.134 \text{ W/m}^2\text{K}$

Thermal transmittance at space dividers in contact with the ground U_g for model 1 is calculated using the method specified in PN- EN ISO 13370:2008.

$U_g = 0.151 \text{ [W/m}^2\text{K]}$

The final value of linear thermal transmittance Ψ_e [W/mK] is equal to:

$$\Psi_{e2} = L^{2D} - (h_w + h_f) U_w - 0.5 * (B' + w) U_g = 0,656 - 1.47*0.134 - 4.36*0.151 = -0.200 \text{ [W/mK]}$$

Resultant linear thermal transmittance Ψ_e for the entire element (weighted with the length, at which the bridge occurs):

Length (width) at which the bridge occurs for model 1 $l_1 = 0.185 \text{ m}$

Length (width) at which the bridge occurs for model 2 $l_2 = 0.065 \text{ m}$

$$\Psi_e = (\Psi_{e1} * l_1 + \Psi_{e2} * l_2) / (l_1 + l_2) = (-0.133*0.185 - 0.200*0.065) / (0.185 + 0.065)$$

$$\Psi_e = -0.151 \text{ [W/mK]}$$

Design temperature factor at the internal surface f_{Rsi} :

The minimum temperature θ_{si} at the internal surface of wall, obtained from the software, is 16.7 °C.

$$f_{Rsi} = (\theta_{si} - \theta_e) / (\theta_i - \theta_e) = (16.7 - (-20)) / (20 - (-20)) = 36.7 / 40$$

$$f_{Rsi} = 0.918$$

24. Entrance door (Super King Blok)

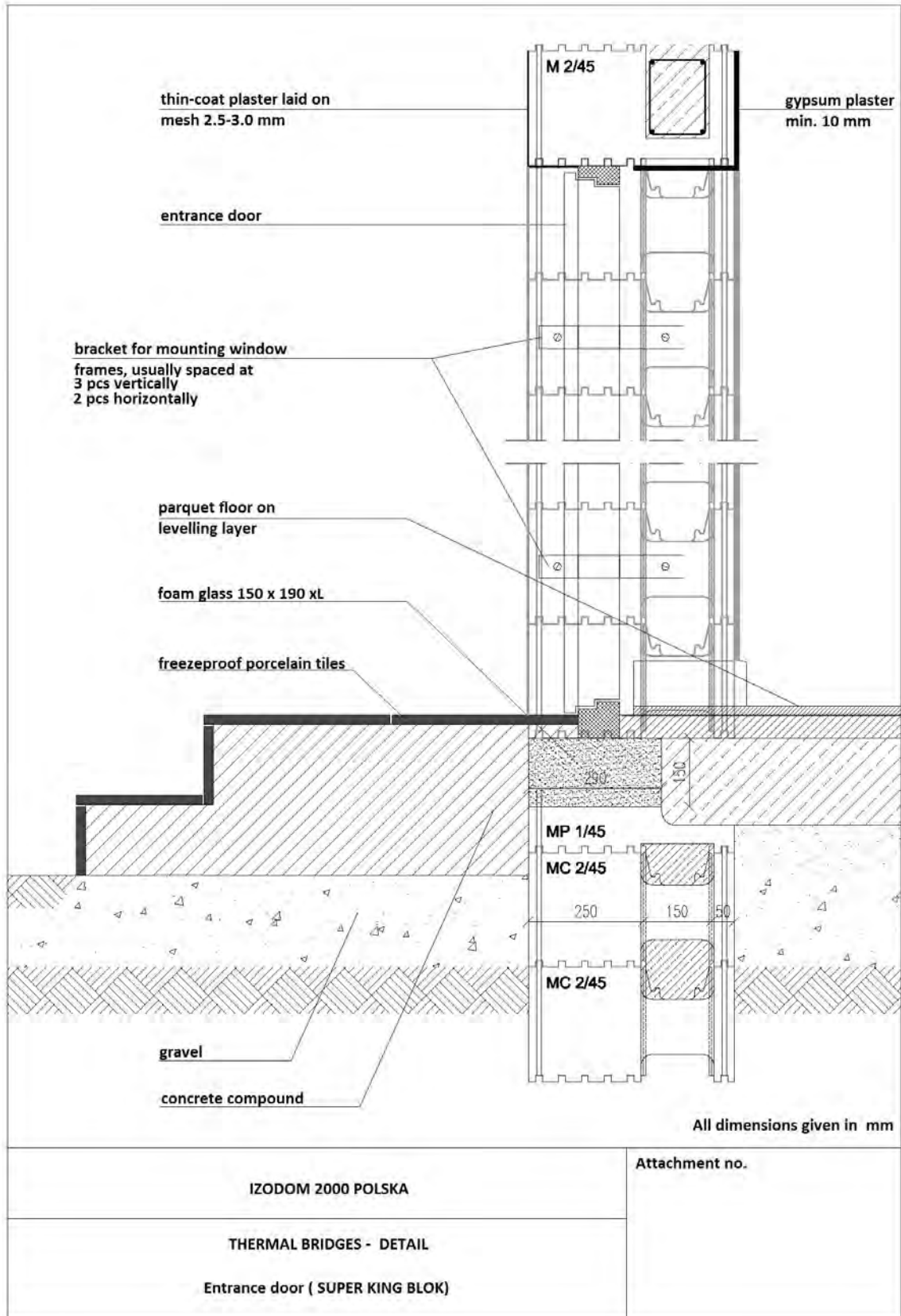

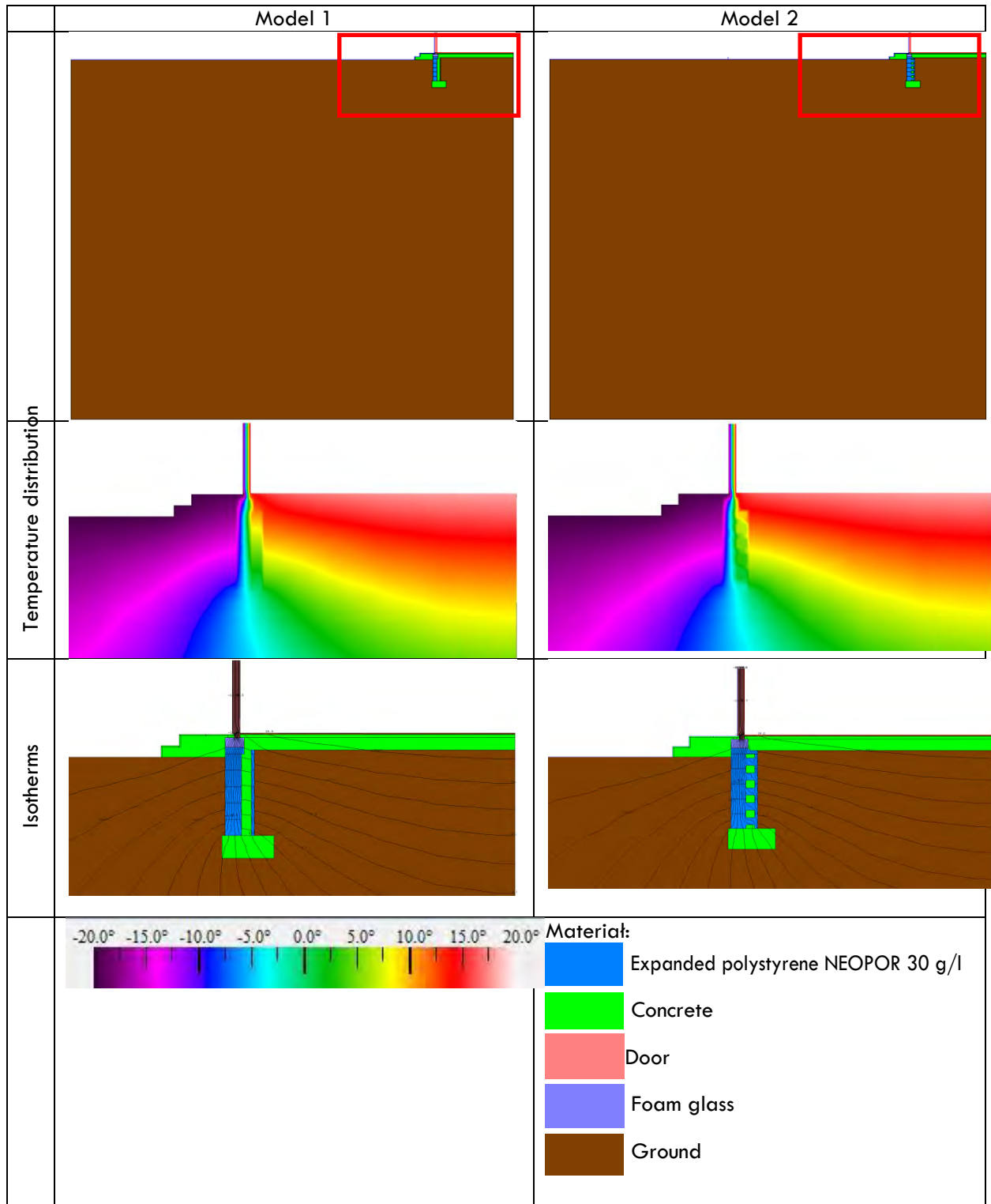

CALCULATIONS FOR MODEL 1:

The linear thermal coupling coefficient L^{2D} is equal to:

$$L^{2D} = 5.332 \text{ m} * 0.3474 \text{ [W/m}^2\text{K]} = 1.852 \text{ [W/mK]}$$

The linear thermal coupling coefficient $L^{2D,a}$ is equal to:

$$L^{2D,a} = 4.222 \text{ m} * 0.2698 \text{ [W/m}^2\text{K]} = 1.139 \text{ [W/mK]}$$

CALCULATIONS FOR MODEL 2:

The linear thermal coupling coefficient L^{2D} is equal to:

$$L^{2D} = 5.332 \text{ m} * 0.3422 \text{ [W/m}^2\text{K]} = 1.825 \text{ [W/mK]}$$

The linear thermal coupling coefficient $L^{2D,a}$ is equal to:

$$L^{2D,a} = 4.222 \text{ m} * 0.2631 \text{ [W/m}^2\text{K]} = 1.111 \text{ [W/mK]}$$

Value of thermal transmittance U_w at the door for model 1:

$$U_w = 0.600 \text{ [W/m}^2\text{K]}$$

$$h_w = 1.18 \text{ [m]}$$

Value of thermal transmittance U_w at the door for model 1:

$$U_w = 0.600 \text{ [W/m}^2\text{K]}$$

$$h_w = 1.18 \text{ [m]}$$

The final value of linear thermal transmittance Ψ_e [W/mK] is equal to:

$$\Psi_{e1} = L^{2D} - h_w U_w - L^{2D,a} = 1.852 - 1.18 * 0.600 - 1.139 = 0.005 \text{ [W/mK]}$$

The final value of linear thermal transmittance Ψ_e [W/mK] is equal to:

$$\Psi_{e1} = L^{2D} - h_w U_w - L^{2D,a} = 1.825 - 1.18 * 0.600 - 1.111 = 0.006 \text{ [W/mK]}$$

Resultant linear thermal transmittance Ψ_e for the entire element (weighted with the length, at which the bridge occurs):

Length (width) at which the bridge occurs for model 1 $l_1 = 0.185 \text{ m}$

Length (width) at which the bridge occurs for model 2 $l_2 = 0.065 \text{ m}$

$$\Psi_e = (\Psi_{e1} * l_1 + \Psi_{e2} * l_2) / (l_1 + l_2) = (0.005 * 0.185 + 0.006 * 0.048) / (0.185 + 0.065)$$

$$\Psi_e = 0.005 \text{ [W/mK]}$$

Design temperature factor at the internal surface f_{Rsi} :

The minimum temperature θ_{si} at the internal surface of the connection between the frame and the floor, obtained from the software, is 13.3 °C .

$$f_{Rsi} = (\theta_{si} - \theta_e) / (\theta_i - \theta_e) = (13.3 - (-20)) / (20 - (-20)) = 33.3 / 40$$

$$f_{Rsi} = 0.833$$

25. Entrance door (King Blok)

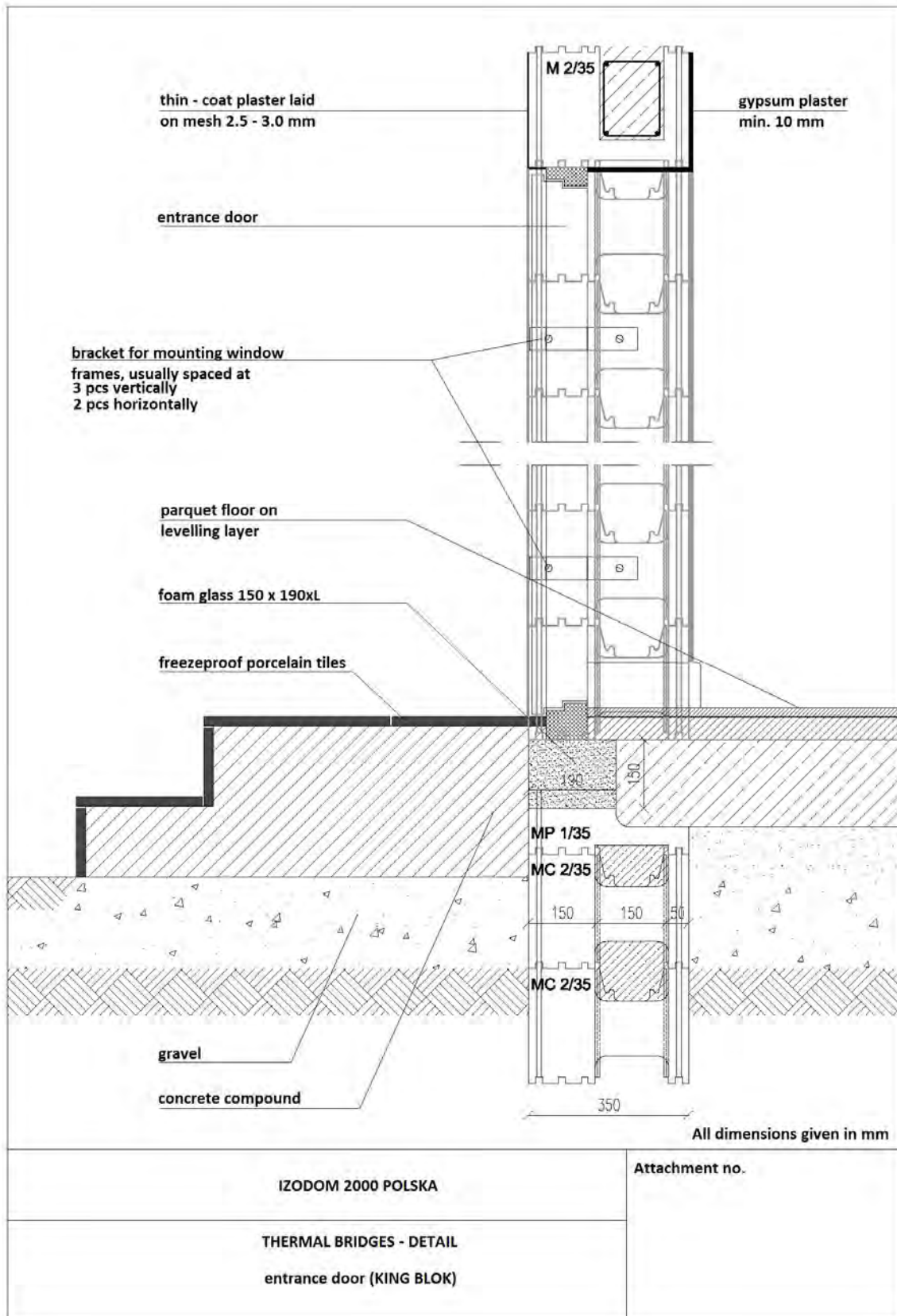

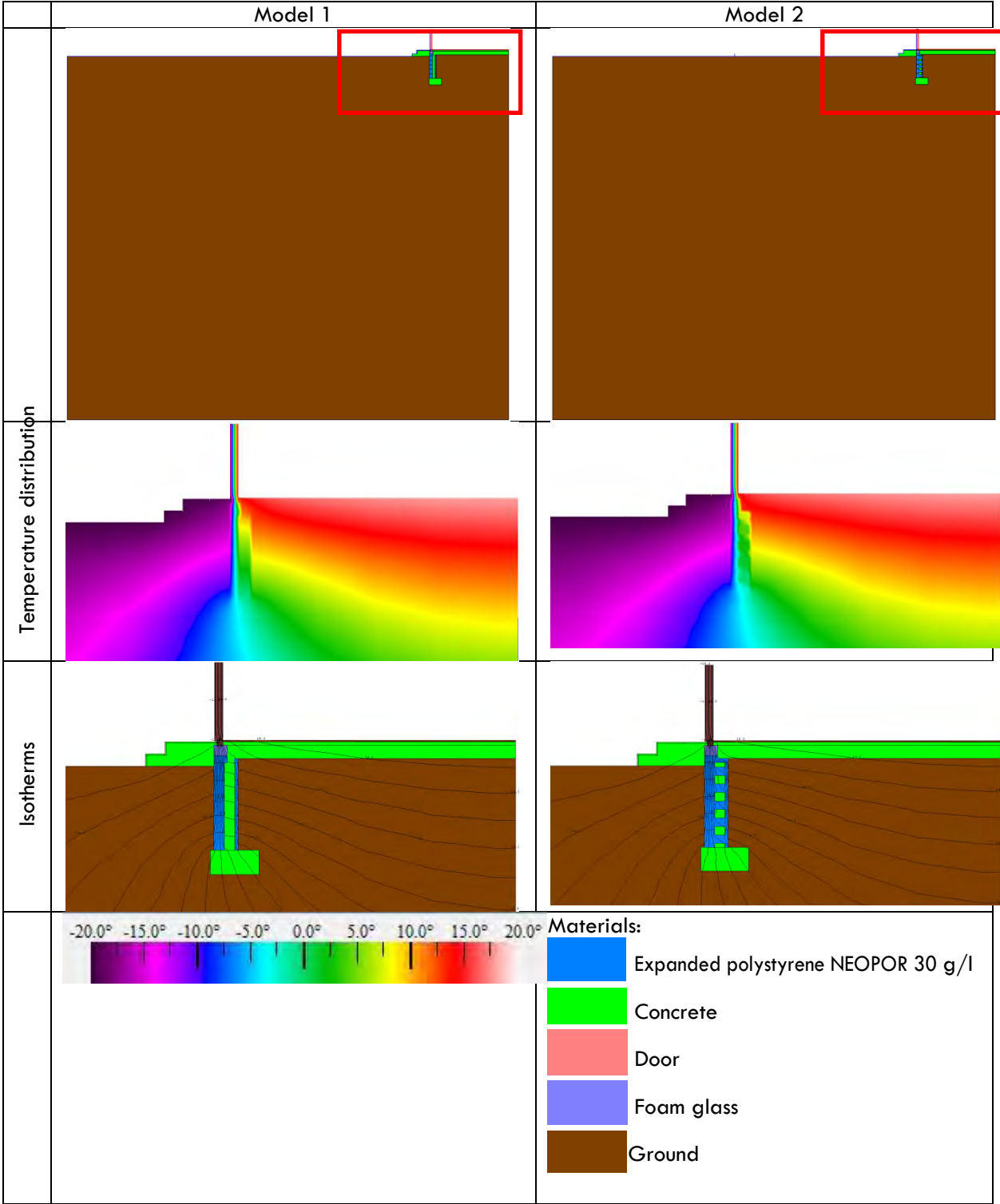

CALCULATIONS FOR MODEL 1:

The linear thermal coupling coefficient L^{2D} is equal to:

$$L^{2D} = 5.332 \text{ m} * 0.3556 \text{ [W/m}^2\text{K]} = 1.896 \text{ [W/mK]}$$

The linear thermal coupling coefficient $L^{2D,a}$ is equal to:

$$L^{2D,a} = 4.222 \text{ m} * 0.2813 \text{ [W/m}^2\text{K]} = 1.188 \text{ [W/mK]}$$

Value of thermal transmittance U_w at the door for model 1:

$$U_w = 0.600 \text{ [W/m}^2\text{K]}$$

$$h_w = 1.18 \text{ [m]}$$

The final value of linear thermal transmittance Ψ_e [W/mK] is equal to:

$$\Psi_{e1} = L^{2D} - h_w U_w - L^{2D,a} = 1.896 - 1.18 * 0.600 - 1.188 = 0.00 \text{ [W/mK]}$$

CALCULATIONS FOR MODEL 2:

The linear thermal coupling coefficient L^{2D} is equal to:

$$L^{2D} = 5.332 \text{ m} * 0.3498 \text{ [W/m}^2\text{K]} = 1.865 \text{ [W/mK]}$$

The linear thermal coupling coefficient $L^{2D,a}$ is equal to:

$$L^{2D,a} = 4.222 \text{ m} * 0.2734 \text{ [W/m}^2\text{K]} = 1.154 \text{ [W/mK]}$$

Value of thermal transmittance U_w at the door for model 1:

$$U_b = 0.600 \text{ [W/m}^2\text{K]}$$

$$h_w = 1.18 \text{ [m]}$$

The final value of linear thermal transmittance Ψ_e [W/mK] is equal to:

$$\Psi_{e1} = L^{2D} - h_w U_w - L^{2D,a} = 1.865 - 1.18 * 0.600 - 1.154 = 0.003 \text{ [W/mK]}$$

Resultant linear thermal transmittance Ψ_e for the entire element (weighted with the length, at which the bridge occurs):

Length (width) at which the bridge occurs for model 1 $l_1 = 0.185 \text{ m}$

Length (width) at which the bridge occurs for model 2 $l_2 = 0.065 \text{ m}$

$$\Psi_e = (\Psi_{e1} * l_1 + \Psi_{e2} * l_2) / (l_1 + l_2) = (0.00 * 0.185 + 0.003 * 0.048) / (0.185 + 0.065) \\ \Psi_e = 0.001 \text{ [W/mK]}$$

Design temperature factor at the internal surface f_{Rsi} :

The minimum temperature θ_{si} at the internal surface of the connection between the frame and the floor, obtained from the software, is 13.2 °C.

$$f_{Rsi} = (\theta_{si} - \theta_e) / (\theta_i - \theta_e) = (13.2 - (-20)) / (20 - (-20)) = 33.2 / 40$$

$$f_{Rsi} = 0,830$$

26. Roller shutter box (Super King Blok)

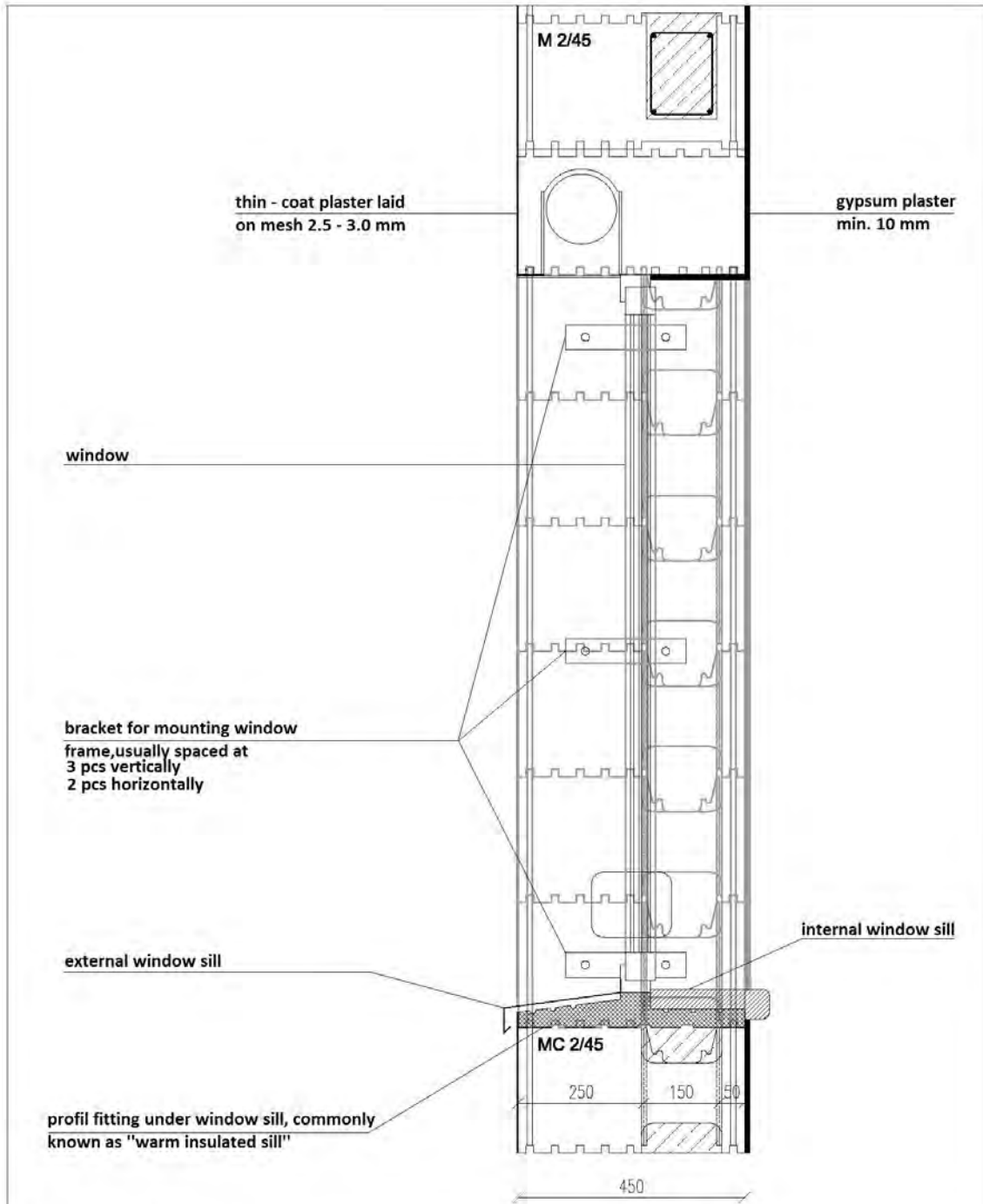

All dimensions given in mm

<p>IZODOM 2000 POLSKA</p>	<p>Attachment no.</p>
<p>THERMAL BRIDGES - DETAIL "Warm insulated" windows with roller blind (SUPER KING BLOK)</p>	

Value of thermal transmittance U_A at the external wall for model 1:

Description	d	λ	R	U
	[m]	[W/mK]	[m ² K/W]	[W/m ² K]
Thermal resistance on the internal side			0.13	
Gypsum plaster	0.01	0.4	0.025	
Expanded polystyrene NEOPOR 30 g/l	0.05	0.031	1.613	
Concrete	0.15	1.7	0.088	
Expanded polystyrene NEOPOR 30 g/l	0.25	0.031	8.065	
Thin-coat mineral plaster	0.005	1.0	0.005	
Thermal resistance on the external side			0.04	
Total thickness	0.47		9.966	0.100

Value of linear thermal transmittance Ψ_1 calculated for model 1:

	U-factor W/m ² K	delta T C	Length mm
Edge	0.2093	40.0	2422

$U = 0.209$ [W/m²K]
 $L = 2.42$ [m]
 $U_A = 0.100$ [W/m²K]
 $L_A = 1.51$ [m]

Frame

$U_b = 1.50$ [W/m²K]
 $L_b = 0.07$ [m]

Glazing

$U_c = 0.50$ [W/m²K]
 $L_c = 0.635$ [m]

$$\Psi_1 = 0.209 * 2.42 - 0.100 * 1.51 - 1.50 * 0.07 - 0.50 * 0.635 = -0.068 \text{ [W/mK]}$$

Value of thermal transmittance U at the external wall for model 2:

Total thermal resistance

	R-Value m ² K/W	delta T C	Length mm
Edge	10.3698	40.0	1250

$R = 10.3698$ m²K/W

	U-factor W/m ² K	delta T C	Length mm
Edge	0.0964	40.0	1250

$U_A = 1 / R = 0.096$ W/m²K

Value of linear thermal transmittance Ψ_2 calculated for model 2:

	U-factor W/m ² K	delta T C	Length mm
Edge	0.2031	40.0	2422

$U = 0.203$ [W/m²K]
 $L = 2.42$ [m]
 $U_A = 0.096$ [W/m²K]
 $L_A = 1.51$ [m]

Frame

$U_b = 1.50$ [W/m²K]
 $L_b = 0.07$ [m]

Glazing

$U_c = 0.50$ [W/m²K]
 $L_c = 0.635$ [m]

$$\Psi_2 = 0.203 * 2.42 - 0.096 * 1.51 - 1.50 * 0.07 - 0.50 * 0.635 = -0.076 \text{ [W/mK]}$$

Resultant linear thermal transmittance Ψ_e for the entire element (weighted with the length, at which the bridge occurs):

Length (width) at which the bridge occurs for model 1 $l_1 = 0.185$ m

Length (width) at which the bridge occurs for model 2 $l_2 = 0.065$ m

$$\Psi_e = (\Psi_1 * l_1 + \Psi_2 * l_2) / (l_1 + l_2) = (-0.068 * 0.185 - 0.076 * 0.065) / (0.185 + 0.065)$$

$$\Psi_e = -0.070 \text{ [W/mK]}$$

Design temperature factor at the internal surface f_{Rsi} :

The minimum temperature θ_{si} at the internal surface of the connection between the frame and the roller shutter box, obtained from the software, is 9.5 °C.

$$f_{Rsi} = (\theta_{si} - \theta_e) / (\theta_i - \theta_e) = (9.5 - (-20)) / (20 - (-20)) = 29.5 / 40$$

$$f_{Rsi} = 0.738$$

27. Roller shutter box (King Blok)

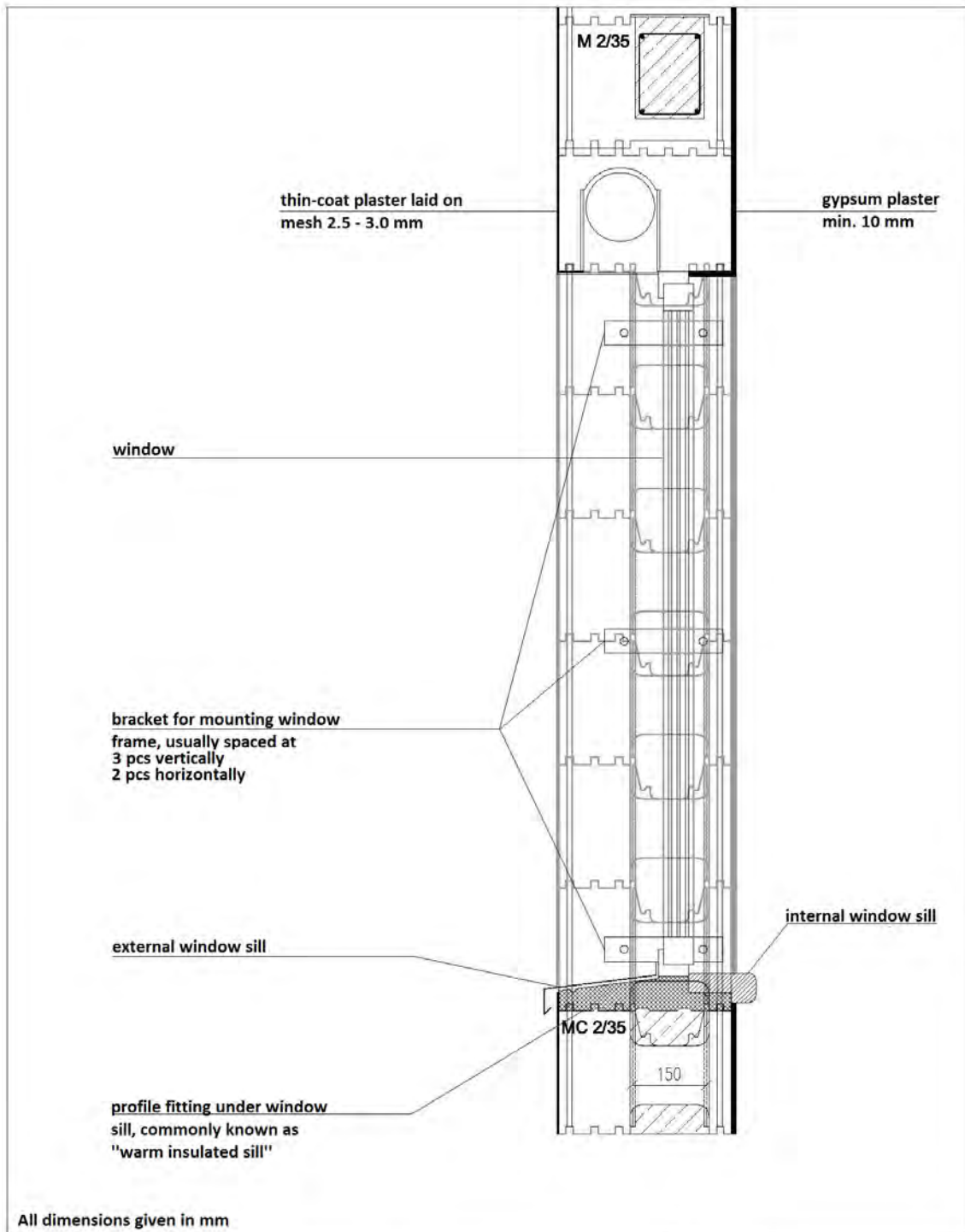

<p>IZODOM 2000 POLSKA</p>	<p>Attachment no.</p>
<p>THERMAL BRIDGES - DETAIL</p> <p>"Warm insulated" windows with roller blind (KING BLOK)</p>	

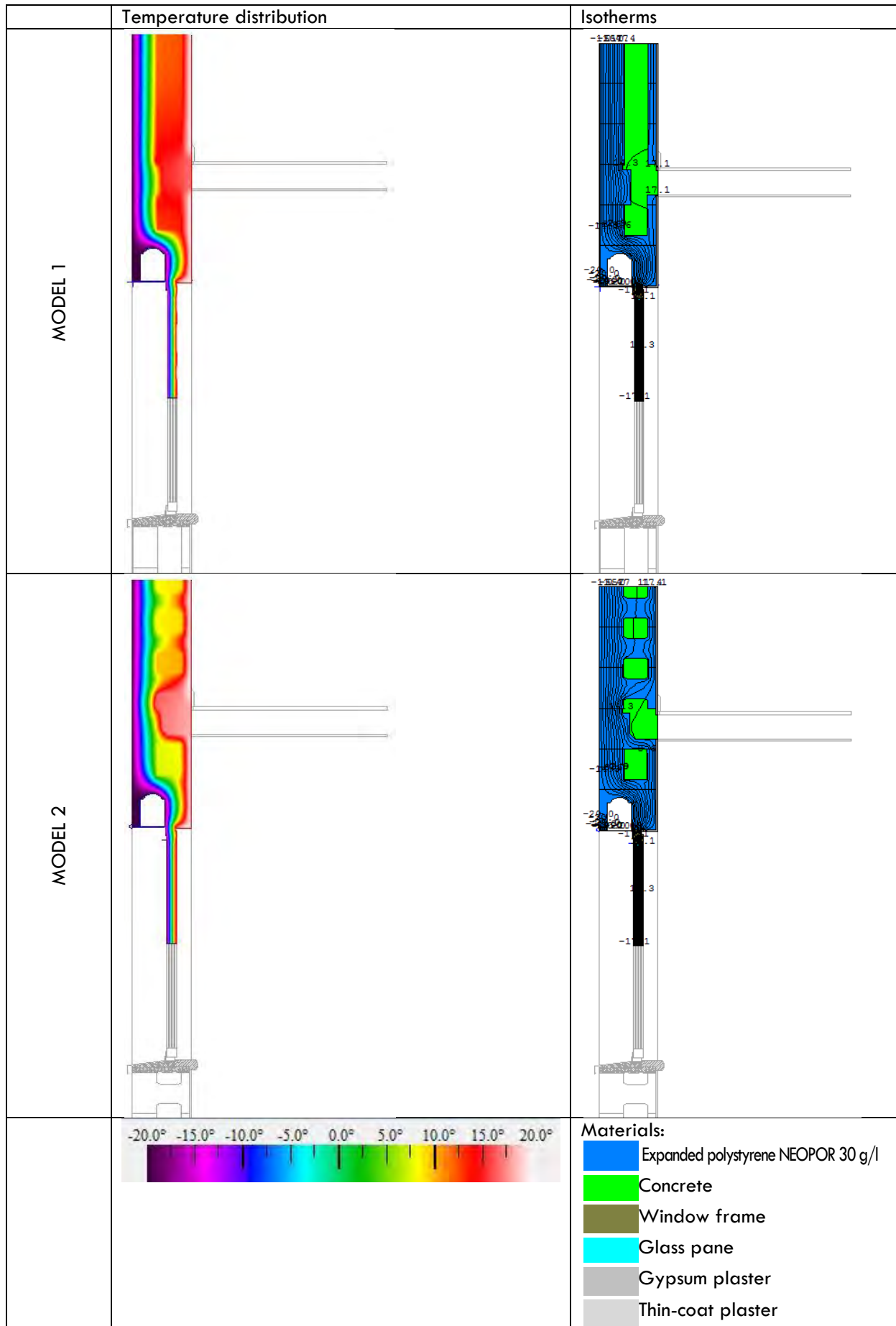

Value of thermal transmittance U_A at the external wall for model 1:

Description	d	λ	R	U
	[m]	[W/mK]	[m ² K/W]	[W/m ² K]
Thermal resistance on the internal side			0.13	
Gypsum plaster	0.01	0.4	0.025	
Expanded polystyrene NEOPOR 30 g/l	0.05	0.031	1.613	
Concrete	0.15	1.7	0.088	
Expanded polystyrene NEOPOR 30 g/l	0.15	0.031	4.839	
Thin-coat mineral plaster	0.005	1.0	0.005	
Thermal resistance on the external side			0.04	
Total thickness	0.37		6.740	0.148

Value of linear thermal transmittance Ψ_1 calculated for model 1:

	U-factor W/m ² K	delta T C	Length mm
Edge	0.2556	40.0	2322

$$U = 0.256 \text{ [W/m}^2\text{K]}$$

$$L = 2.32 \text{ [m]}$$

$$U_A = 0.148 \text{ [W/m}^2\text{K]}$$

$$L_A = 1.51 \text{ [m]}$$

Frame

$$U_b = 1.50 \text{ [W/m}^2\text{K]}$$

$$L_b = 0.07 \text{ [m]}$$

Glazing

$$U_c = 0.50 \text{ [W/m}^2\text{K]}$$

$$L_c = 0.635 \text{ [m]}$$

$$\Psi_1 = 0.256 * 2.32 - 0.148 * 1.51 - 1.50 * 0.07 - 0.50 * 0.635 = -0.052 \text{ [W/mK]}$$

Value of thermal transmittance U at the external wall for model 2:

Total thermal resistance

	R-Value m ² K/W	delta T C	Length mm
Edge	7.2443	40.0	1250

$$R = 7.2443 \text{ m}^2\text{K/W}$$

	U-factor W/m ² K	delta T C	Length mm
Edge	0.1380	40.0	1250

$$U_A = 1 / R = 0.138 \text{ W/m}^2\text{K}$$

Value of linear thermal transmittance Ψ_2 calculated for model 2:

	U-factor W/m ² K	delta T C	Length mm
Edge	0.2431	40.0	2322

$$U = 0.243 \text{ [W/m}^2\text{K]}$$

$$L = 2.32 \text{ [m]}$$

$$U_A = 0.138 \text{ [W/m}^2\text{K]}$$

$$L_A = 1.51 \text{ [m]}$$

Frame

$$U_b = 1.50 \text{ [W/m}^2\text{K]}$$

$$L_b = 0.07 \text{ [m]}$$

Glazing

$$U_c = 0.50 \text{ [W/m}^2\text{K]}$$

$$L_c = 0.635 \text{ [m]}$$

$$\Psi_2 = 0.243 * 2.32 - 0.138 * 1.51 - 1.50 * 0.07 - 0.50 * 0.635 = -0.067 \text{ [W/mK]}$$

Resultant linear thermal transmittance Ψ_e for the entire element (weighted with the length, at which the bridge occurs):

Length (width) at which the bridge occurs for model 1 $l_1 = 0.185$ m

Length (width) at which the bridge occurs for model 2 $l_2 = 0.065$ m

$$\Psi_e = (\Psi_1 * l_1 + \Psi_2 * l_2) / (l_1 + l_2) = (-0.052 * 0.185 - 0.067 * 0.065) / (0.185 + 0.065)$$

$$\Psi_e = -0.056 \text{ [W/mK]}$$

Design temperature factor at the internal surface f_{Rsi} :

The minimum temperature θ_{si} at the wall internal surface of the connection between the frame and the roller shutter box, obtained from the software, is 9.9 °C

$$f_{Rsi} = (\theta_{si} - \theta_e) / (\theta_i - \theta_e) = (9.9 - (-20)) / (20 - (-20)) = 29.9 / 40$$

$$f_{Rsi} = 0.748$$

28.Connection between external wall and foundation (Super King Blok)

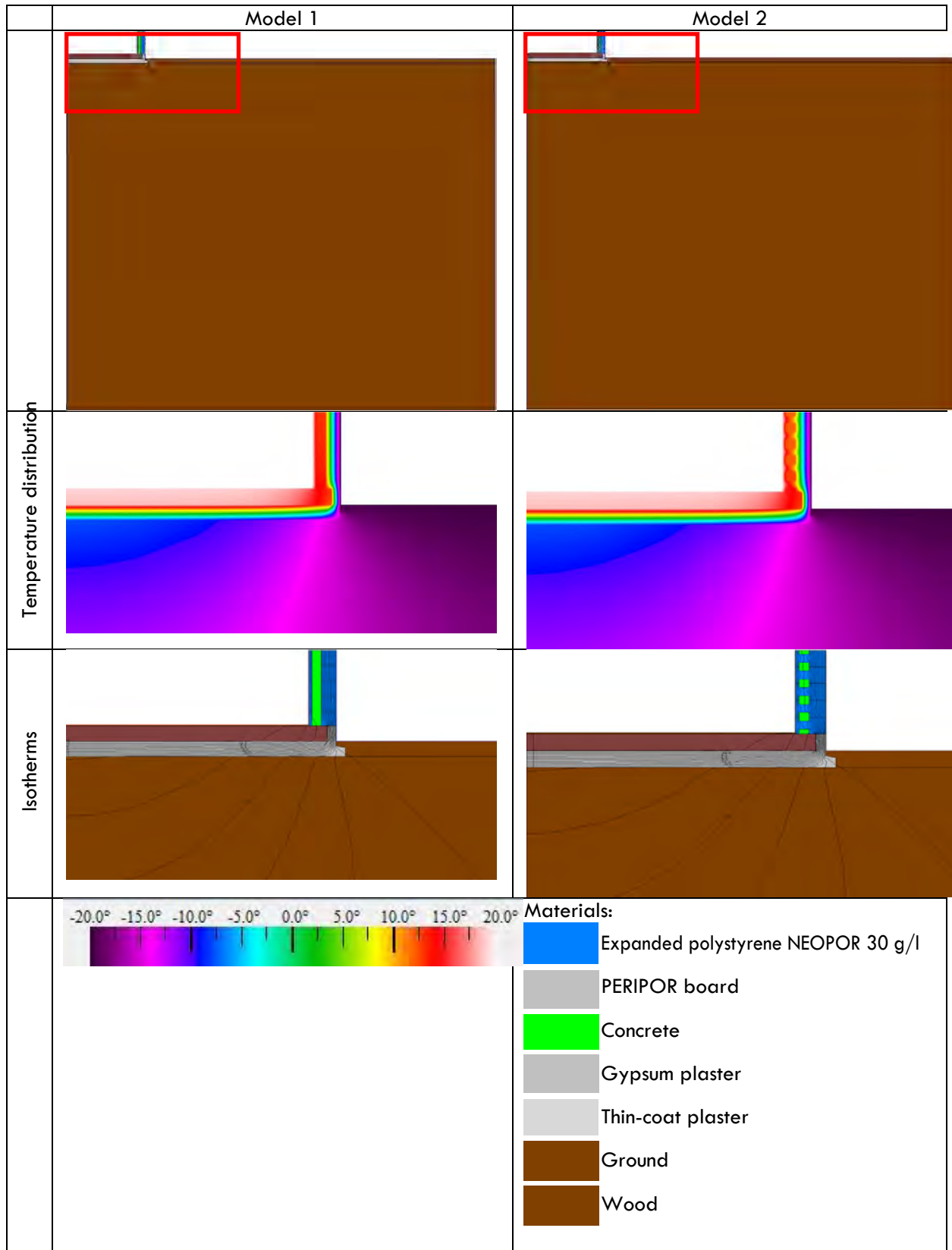

CALCULATIONS FOR MODEL 1:

The linear thermal coupling coefficient L^{2D} is equal to:

$$L^{2D} = 5.23 \text{ m} * 0.1153 \text{ [W/m}^2\text{K]} = 0.603 \text{ [W/mK]}$$

The linear thermal coupling coefficient $L^{2D,\alpha}$ is equal to:

$$L^{2D,\alpha} = 4.00 \text{ m} * 0.1175 \text{ [W/m}^2\text{K]} = 0.470 \text{ [W/mK]}$$

Value of thermal transmittance U_w at the external wall for model 1:

Description	d	λ	R	U
	[m]	[W/mK]	[m ² K/W]	[W/m ² K]
Thermal resistance on the internal side			0.13	
Gypsum plaster	0.01	0.4	0.025	
Expanded polystyrene NEOPOR 30 g/l	0.05	0.031	1.613	
Concrete	0.15	1.7	0.088	
Expanded polystyrene NEOPOR 30 g/l	0.25	0.031	8.065	
Thin-coat mineral plaster	0.005	1.0	0.005	
Thermal resistance on the external side			0.04	
Total thickness	0.47		9.966	0.100

The final value of linear thermal transmittance Ψ_e [W/mK] is equal to:

$$\Psi_{e1} = L^{2D} - h_w U_w - L^{2D,\alpha} = 0.603 - 1.23 * 0.100 - 0.470 = 0.010 \text{ [W/mK]}$$

CALCULATIONS FOR MODEL 2:

The linear thermal coupling coefficient L^{2D} is equal to:

$$L^{2D} = 5.23 \text{ m} * 0.1139 \text{ [W/m}^2\text{K]} = 0.596 \text{ [W/mK]}$$

The linear thermal coupling coefficient $L^{2D,\alpha}$ is equal to:

$$L^{2D,\alpha} = 4.00 \text{ m} * 0.1175 \text{ [W/m}^2\text{K]} = 0.470 \text{ [W/mK]}$$

Value of thermal transmittance U_A at the external wall for model 2:

	U-factor W/m ² K	delta T C	Length mm
Edge	0.0935	40.0	1250

$$U_w = 0.094 \text{ W/m}^2\text{K}$$

$$\Psi_{e2} = L^{2D} - h_w U_w - L^{2D,\alpha} = 0.596 - 1.23 * 0.094 - 0.470 = 0.010 \text{ [W/mK]}$$

Resultant linear thermal transmittance Ψ_e for the entire element (weighted with the length, at which the bridge occurs):

Length (width) at which the bridge occurs for model 1 $l_1 = 0.185 \text{ m}$

Length (width) at which the bridge occurs for model 2 $l_2 = 0.065 \text{ m}$

$$\Psi_e = (\Psi_{e1} * l_1 + \Psi_{e2} * l_2) / (l_1 + l_2) = (0.010 * 0.185 + 0.010 * 0.065) / (0.185 + 0.065)$$

$$\Psi_e = 0.010 \text{ [W/mK]}$$

Design temperature factor at the internal surface f_{Rsi} :

The minimum temperature θ_{si} at the internal surface of wall, obtained from the software, is 16.9 °C.

$$f_{Rsi} = (\theta_{si} - \theta_e) / (\theta_i - \theta_e) = (16.9 - (-20)) / (20 - (-20)) = 36.9 / 40$$

$$f_{Rsi} = \mathbf{0.923}$$

29.Connection between external wall and foundation (King Blok)

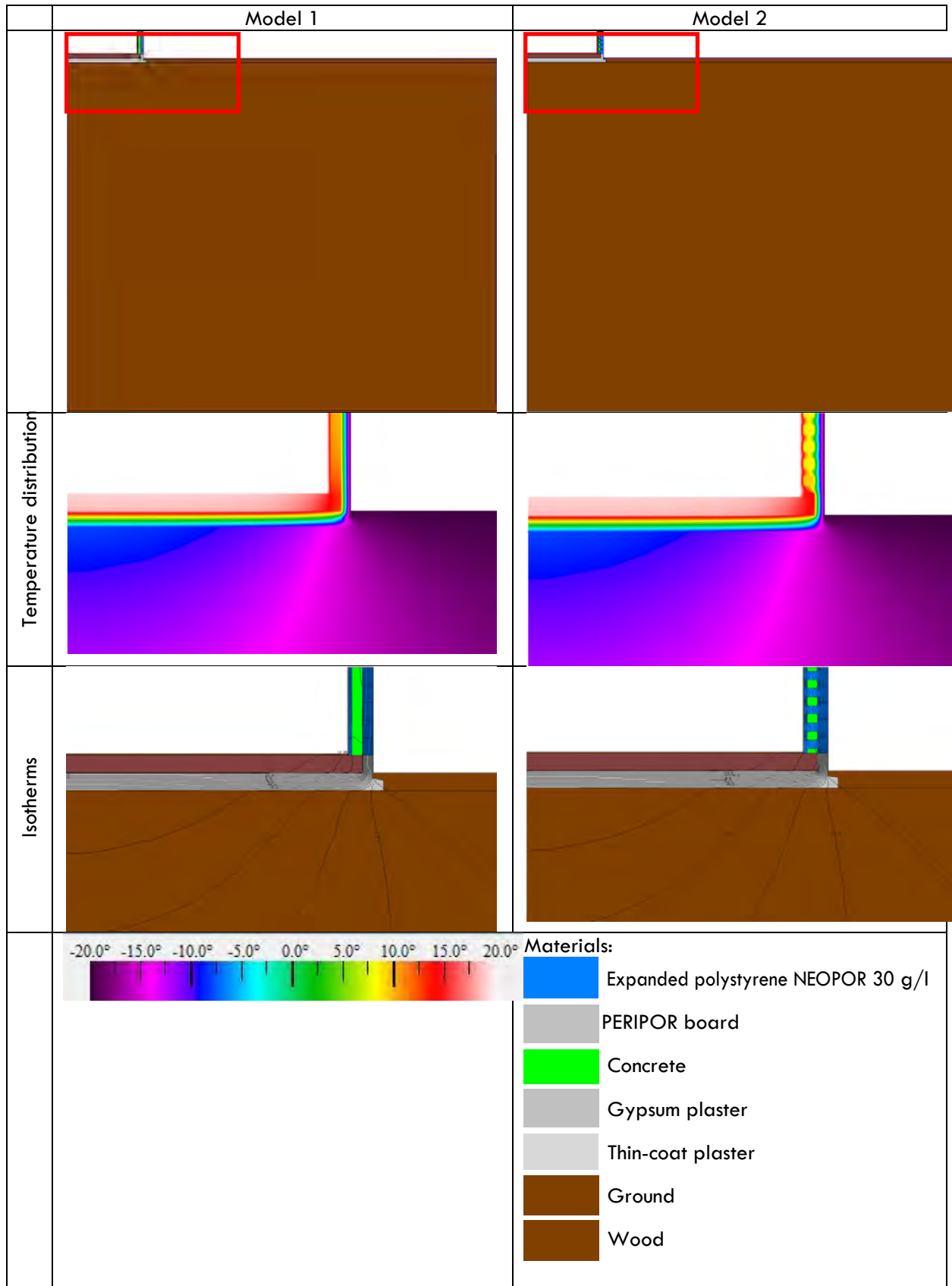

CALCULATIONS FOR MODEL 1:

The linear thermal coupling coefficient L^{2D} is equal to:

$$L^{2D} = 5.23 \text{ m} * 0.1261 \text{ [W/m}^2\text{K]} = 0.660 \text{ [W/mK]}$$

The linear thermal coupling coefficient $L^{2D,\alpha}$ is equal to

$$L^{2D,\alpha} = 4.00 \text{ m} * 0.1168 \text{ [W/m}^2\text{K]} = 0.467 \text{ [W/mK]}$$

Value of thermal transmittance U_w at the external wall for model 1:

Description	d	λ	R	U
	[m]	[W/mK]	[m ² K/W]	[W/m ² K]
Thermal resistance on the internal side			0.13	
Gypsum plaster	0.01	0.4	0.025	
Expanded polystyrene NEOPOR 30 g/l	0.05	0.031	1.613	
Concrete	0.15	1.7	0.088	
Expanded polystyrene NEOPOR 30 g/l	0.15	0.031	4.839	
Thin-coat mineral plaster	0.005	1.0	0.005	
Thermal resistance on the external side			0.04	
Total thickness	0.37		6.740	0.148

The final value of linear thermal transmittance Ψ_e [W/mK] is equal to:

$$\Psi_{e1} = L^{2D} - h_w U_w - L^{2D,\alpha} = 0.660 - 1.23 * 0.148 - 0.467 = 0.010 \text{ [W/mK]}$$

CALCULATIONS FOR MODEL 2:

The linear thermal coupling coefficient L^{2D} is equal to:

$$L^{2D} = 5.23 \text{ m} * 0.1216 \text{ [W/m}^2\text{K]} = 0.636 \text{ [W/mK]}$$

The linear thermal coupling coefficient $L^{2D,\alpha}$ is equal to:

$$L^{2D,\alpha} = 4.00 \text{ m} * 0.1168 \text{ [W/m}^2\text{K]} = 0.467 \text{ [W/mK]}$$

Value of thermal transmittance U at the external wall for model 2:

	U-factor W/m ² -K	delta T C	Length mm
Edge	0.1339	40.0	1250

$$U_w = 0.134 \text{ W/m}^2\text{K}$$

The final value of linear thermal transmittance Ψ_e [W/mK] is equal to:

$$\Psi_{e2} = L^{2D} - h_w U_w - L^{2D,\alpha} = 0.636 - 1.23 * 0.134 - 0.467 = 0.004 \text{ [W/mK]}$$

Resultant linear thermal transmittance Ψ_e for the entire element (weighted with the length, at which the bridge occurs):

Length (width) at which the bridge occurs for model 1 $l_1 = 0.185 \text{ m}$

Length (width) at which the bridge occurs for model 2 $l_2 = 0.065 \text{ m}$

$$\Psi_e = (\Psi_{e1} * l_1 + \Psi_{e2} * l_2) / (l_1 + l_2) = (0.010 * 0.185 + 0.004 * 0.065) / (0.185 + 0.065)$$

$$\Psi_e = 0.008 \text{ [W/mK]}$$

Design temperature factor at the internal surface f_{Rsi} :

The minimum temperature $\theta_{s,i}$ at the internal surface of wall, obtained from the software, is 16.5 °C .

$$f_{Rsi} = (\theta_{si} - \theta_e) / (\theta_i - \theta_e) = (16.5 - (-20)) / (20 - (-20)) = 36.5 / 40$$

$$\mathbf{f_{Rsi} = 0.913}$$

30. Collective table for single-family buildings

Calculation	Case under consideration	Value of linear thermal transmittance Ψ_e	f_{Rsi}	Complies with
2.	Connection between external wall and internal load-bearing wall (Super King Blok)	0.008	0.963	NF15 NF40
3.	Connection between external wall and internal load-bearing wall (King Blok)	0.017	0.943	NF40
4.	Connection between external wall and partition wall (Super King Blok)	-0.003	0.973	NF15 NF40
5.	Connection between external wall and partition wall (King Blok)	0.008	0.960	NF15 NF40
6.	Connection between external wall and flat roof (Super King Blok)	-0.041	0.908	NF15 NF40
7.	Connection between external wall and flat roof (King Blok)	-0.032	0.893	NF15 NF40
8.	Connection between external wall with flat roof and parapet wall (Super King Blok)	-0.015	0.848	NF15 NF40
9.	Connection between external wall with flat roof and parapet wall (King Blok)	-0.032	0.820	NF15 NF40
10.	Knee wall (Super King Blok)	-0.062	0.963	NF15 NF40
11.	Knee wall (King Blok)	-0.062	0.960	NF15 NF40
12.	Flat roof resting on external wall (Super King Blok)	0.111	0.850	-
13.	Flat roof resting on external wall (King Blok)	0.092	0.840	NF40
14.	Self-supporting balcony added to the building (King Blok)	0.008	0.948	NF15 NF40
15.	Self-supporting balcony added to the building (King Blok)	0.024	0.925	NF40
16.	Connection between door frame and jamb (Super King Blok)	0.022 – insulation not overlapping the door frame -0.002 – insulation overlapping the door frame	0.885 0.835	NF40 NF15 NF40
17.	Connection between door frame and jamb (King Blok)	0.025	0.793	NF40
18.	Suspended floor slabs (Super King Blok)	-0.050	0.923	NF15 NF40
19.	Suspended floor slabs (King Blok)	-0.047	0.923	NF15 NF40
20.	Suspended floor slabs (Super King Blok) – option 2	0.020	0.978	NF40
21.	Suspended floor slabs (King Blok) – option 2	0.025	0.978	NF40
22.	Floor slab above unheated basement (Super King Blok)	-0.183	0.940	NF15 NF40
23.	Floor slab above unheated basement (King Blok)	-0.151	0.918	NF15 NF40

24.	Entrance door (Super King Blok)	0.005	0,833	NF15 NF40
25.	Entrance door (King Blok)	0.001	0.830	NF15 NF40
26.	Roller shutter box (Super King Blok)	-0.070	0.738	NF15 NF40
27.	Roller shutter box (King Blok)	-0.056	0.748	NF15 NF40
28.	Connection between external wall and foundation (Super King Blok)	0.010	0.923	NF15 NF40
29.	Connection between external wall and foundation (King Blok)	0.008	0.913	NF15 NF40

31. Collective table for multifamily buildings

Calculation No.	Case under consideration	Value of linear thermal transmittance Ψ_e	f_{Rsi}	Complies with
2.	Connection between external wall and internal load-bearing wall (Super King Blok)	0.008	0.963	NF15 NF40
3.	Connection between external wall and internal load-bearing wall (King Blok)	0.017	0.943	NF40
4.	Connection between external wall and partition wall (Super King Blok)	-0.003	0.973	NF15 NF40
5.	Connection between external wall and partition wall (King Blok)	0.008	0.960	NF15 NF40
6.	Connection between external wall and flat roof (Super King Blok)	-0.041	0.908	NF15 NF40
7.	Connection between external wall and flat roof (King Blok)	-0.032	0.893	NF15 NF40
8.	Connection between external wall with flat roof and parapet wall (Super King)	-0.015	0.848	NF15 NF40
9.	Connection between external wall with flat roof and parapet wall (King Blok)	-0.032	0.820	NF15 NF40
10.	Knee wall (Super King Blok)	-0.062	0.963	NF15 NF40
11.	Knee wall (King Blok)	-0.062	0.960	NF15 NF40
12.	Flat roof resting on external wall (Super King Blok)	0.111	0.850	-
13.	Flat roof resting on external wall (King Blok)	0.092	0.840	NF40
14.	Self-supporting balcony added to the building (Super King Blok)	0.008	0.948	NF15 NF40
15.	Self-supporting balcony added to the building (King Blok)	0.024	0.925	NF40
16.	Connection between door frame and jamb (Super King Blok)	0.022 – insulation not overlapping the door frame -0.002 – insulation overlapping the door frame	0.885 0.835	NF40 NF15 NF40

17.	Connection between door frame and jamb (King Blok)	0.025	0.793	NF40
18.	Suspended floor slabs (Super King Blok)	-0.050	0.923	NF15 NF40
19.	Suspended floor slabs (King Blok)	-0.047	0.923	NF15 NF40
20.	Suspended floor slabs (Super King Blok) – option 2	0.020	0.978	NF40
21.	Suspended floor slabs (King Blok) – option 2	0.025	0.978	NF40
22.	Floor slab above unheated basement (Super King Blok)	0.005	0.940	NF15 NF40
23.	Floor slab above unheated basement (King Blok)	0.012	0.918	NF40
24.	Entrance door (Super King Blok)	-0.025	0.815	NF15 NF40
25.	Entrance door (King Blok)	-0.028	0.818	NF15 NF40
26.	Roller shutter box (Super King Blok)	-0.070	0.738	NF15 NF40
27.	Roller shutter box (King Blok)	-0.056	0.748	NF15 NF40
28.	Connection between external wall and foundation (Super King Blok)	-0.028	0.923	NF15 NF40
29.	Connection between external wall and foundation (King Blok)	-0.057	0.913	NF15 NF40

32.Determination of declared and design thermal values

Declared value of thermal conductivity

The declared value of thermal conductivity for expanded polystyrene containing the NEOPOR graphite is calculated on the basis of the results obtained from tests with 10 samples, tested using the FOX 314 meter. The determination, which complies with PN-ISO 8301:1998 “Thermal insulation — Determination of steady-state thermal resistance and related properties — Heat flow meter apparatus”, has been performed at the Department of Building Physics and Building Materials at the Lodz University of Technology. All samples have been collected at an average temperature of 10 °C, and additionally, three samples were tested at an average temperature of 10, 20 and 30 °C to have the temperature conversion factor determined. The samples were kept air-conditioned in a laboratory at 23±2 °C and an air relative humidity of 50±5 %.

For the tested expanded polystyrene, humidity sorption on four levels of an air relative humidity of 32, 54, 75, and 95% at a constant temperature of 20°C has been determined as well.

The declared value applies at a temperature of 10 °C and moisture content equal to the material in equilibrium with air at a temperature of 23 °C and a relative humidity of 50 %.

Table 1. Measured thermal conductivity λ [W/(mK)]

Sample No.	1	2	3	4	5	6	7	8	9	10
Measured thermal conductivity λ [W/(mK)]	0.030 65	0.030 68	0.030 72	0.030 59	0.030 55	0.030 68	0.030 79	0.030 74	0.030 68	0.030 78

The declared value shall be the 90 % quantile at a confidence level of 90 %. The statistical formula used to determine the limit of this one-sided statistical tolerance L_s is as follows (according to ISO 16269-6:2005, Annexe A):

$$L_s = \lambda + k_2 \cdot (n;p;1 - \alpha) \cdot s$$

where

- λ mean value,
- k_2 coefficient used to determine L_s when the standard deviation is estimated for one-sided statistical tolerance,
- n number of samples
- p quantile providing the minimum proportion of the population assumed to be within the statistical tolerance interval,
- $1 - \alpha$ confidence level for the assertion that the proportion of the population lying within the tolerance interval is greater or equal to the specified level p ,
- s sample standard deviation

The mean value of thermal conductivity λ is calculated as follows:

$$\lambda = (\sum \lambda_i) / 10 = 0.03069 \text{ [W/(mK)]}$$

where:

- λ_i i th measured value

In PN-EN ISO 10456:2009+AC:2010 (Annexe C), the factor k_2 is equal to 2.07 for $n = 10$ samples. The standard deviation s is calculated as follows:

$$s = \sqrt{(\sum(\lambda_i - \lambda)^2) / (n-1)} = 0.00008$$

The limit value of the tolerance interval is equal to:

$$L_s = 0.030\ 69 + 2.07 \cdot 0.000\ 08 = 0.030\ 85 \text{ [W/(m}\cdot\text{K)]}$$

The value is converted for a temperature of 10°C, using the following equation:

$$\lambda_2 = \lambda_1 \cdot F_T$$

The conversion factor is calculated using the following equation:

$$F_T = e^{f_T (T_2 - T_1)}$$

The conversion factor f_T for standard boards made of expandable polystyrene is specified in PN-EN ISO 10456:2009+AC:2010 in Table A2. For the tested material, the parameter is determined by experiment, using the following relationship:

$$\lambda(T_2) = \lambda(T_1) \cdot e^{(f_T)(T_2 - T_1)}$$

Hence:

$$f_T = (\ln \lambda(T_2) - \ln \lambda(T_1)) / (T_2 - T_1)$$

or in other words, the conversion factor is the slope of a straight line towards the X-axis and is equal to $f_T = 0.0031$ for the temperature difference from 0 to 20 °C relative to the test temperature $T_1 = 10^\circ\text{C}$

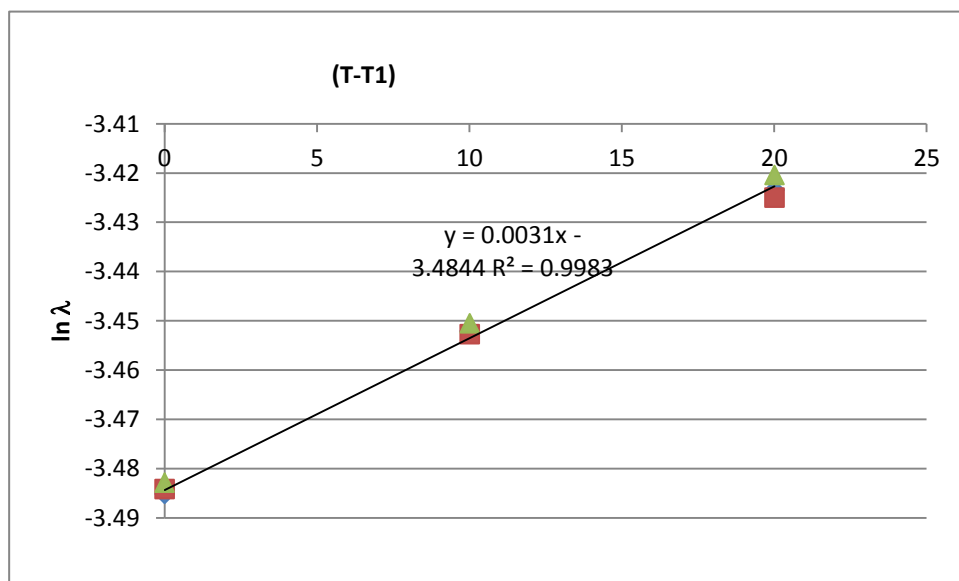

Fig. 1. Logarithmic relationship of the λ value to the temperature difference

For the tested expanded polystyrene containing the NEOPOR graphite, the conversion factor at a temperature of 10°C is:

$$F_T = e^{(0.0031)(10-10)} = 1.0$$

The converted value is:

$$\lambda_2 = \lambda_1 \cdot F_T = 0.03085 \cdot 1.0 = 0.030\ 85 \text{ [W/(mK)]}$$

The declared thermal conductivity with an accuracy of 0.001 [W/(mK)] is equal to:

$$\lambda = 0.031 \text{ [W/(mK)]}$$

For example, for the tested expanded polystyrene containing the NEOPOR graphite, the conversion factor at a temperature of 20°C is:

$$F_T = e^{(0.0031(20-10))} = 1.0315$$

The converted value is:

$$\lambda_2 = \lambda_1 \cdot F_T = 0.03085 \cdot 1.0315 = 0.03182 \text{ [W/(mK)]}$$

The declared with an accuracy of 0.001 [W/(mK)] is equal to:

$$\lambda = 0.032 \text{ [W/(mK)]}$$

For the tested expanded polystyrene containing the NEOPOR graphite, the conversion factor at a temperature of 30°C is:

$$F_T = e^{(0.0031(30-10))} = 1.0640$$

The converted value is: $\lambda_2 = \lambda_1 \cdot F_T = 0.03085 \cdot 1.0640 = 0.03282 \text{ [W/(mK)]}$

The declared with an accuracy of 0.001 [W/(mK)] is equal to:

$$\lambda = 0.033 \text{ [W/(mK)]}$$

Determination of the design value using the declared value

A block made of expanded polystyrene can be used under conditions in which the moisture content not equal to 0. For the expanded polystyrene NEOPOR, humidity sorption on four levels of an air relative humidity of 32, 54, 75, and 95 % at a constant temperature of 20 °C has been tested as well. The test results are presented on the graph, given as the ratio of moisture volume to the ESP volume [m³/m³] at various values of air relative humidity.

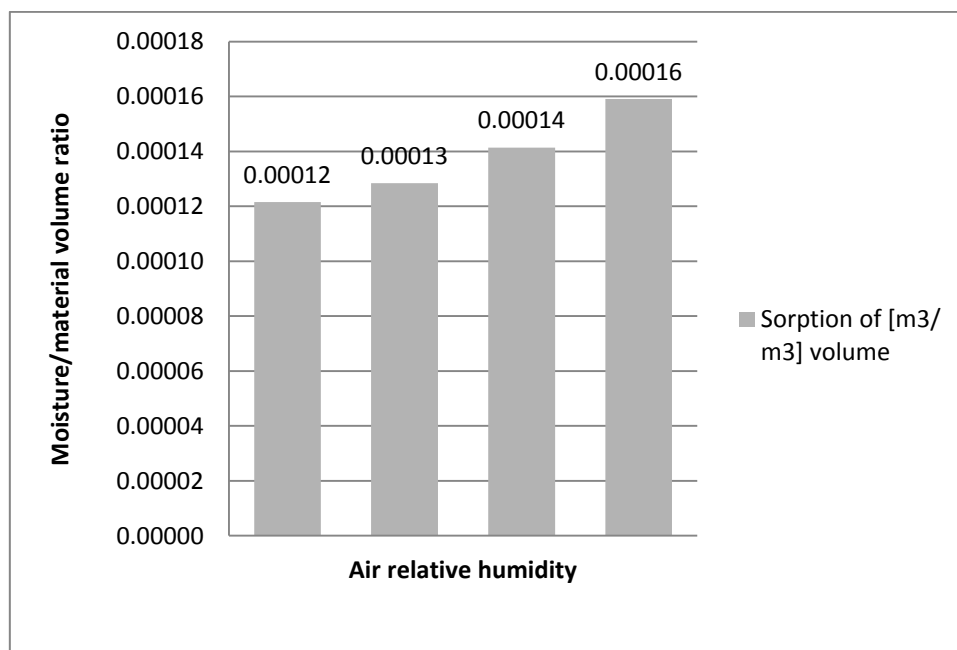

Fig. 2. Testing humidity sorption on four levels of air relative humidity

For the highest value of air relative humidity, i.e. 95 %, the moisture content in the expanded polystyrene NEOPOR is 0.00016 m³/m³. The declared thermal conductivity for this product, for which a value of 90/90 is given, is equal to 0.031 W/(mK).

There are two various design values required, i.e. a value representing the same quantile as the declared value, and a value representing the mean value.

Quantile 90 %

The conversion is required only due to the moisture content. The conversion factor is calculated using the following equation:

$$F_m = e^{f_\psi (\psi^{2-\psi} - 1)}$$

The conversion factor due to the moisture content, as specified in PN-EN ISO 10456:2009+AC:2010 in Table 4, is:

$$f_\psi = 4.0$$

Hence, the conversion factor F_m required due to the moisture and the converted thermal conductivity are:

$$F_m = e^{(4.0(0.00016-0))} = 1.00064$$

$$\lambda_2 = \lambda_1 \cdot F_m = 0.031 \cdot 1.00064 \text{ [W/(mK)]}$$

The design value with an accuracy of 0.001 [W/(mK)] is equal to:

$$\lambda = 0.031 \text{ [W/(mK)]}$$

For NEOPOR, it can be assumed that the impact of material moisture on thermal conductivity is negligible.

Mean value

The mean value can be calculated using the following equation:

$$\lambda = \lambda_{90} - \Delta\lambda$$

The value can be calculated provided that at least the number of measurements and an estimated standard deviation are known. Standard deviation $\Delta\lambda = 0.00008$

$$\lambda = 0.031 - 0.00008 = 0.03092$$

Hence, the conversion factor F_m required due to the moisture and the converted thermal conductivity are:

$$F_m = e^{(4.0(0.00016-0))} = 1.00064$$

$$\lambda_2 = \lambda_1 \cdot F_m = 0.03092 \cdot 1.00064 = 0.03094 \text{ [W/(mK)]}$$

The design value with an accuracy of 0.001 [W/(mK)] is equal to:

$$\lambda = 0.031 \text{ [W/(mK)]}$$

Determination of properties at water vapour permeation

The determination of properties at water vapour permeation is performed in accordance with PN-EN 12086:2001. The principle of measurement consists in attaching the tested sample to the open side of the vessel filled with a water solution of potassium nitrate.

Next the test unit is placed in the conditioning chamber with a controlled temperature of $23 \pm 2^\circ \text{C}$ and a relative humidity of $50 \pm 5\%$. Water vapour flows through the tested sample due to the difference of partial pressure of water vapour in the test unit and the test atmosphere. In order to determine the density of water vapour flow rate in steady-state, the test unit is weighted from time to time.

The test has been conducted under C-class conditions, i.e. at a temperature of $23 \pm 2^\circ \text{C}$ and an air relative humidity (when dry) of $50 \pm 5\%$, when wet $93 \pm 3\%$ (obtained using a water solution of potassium nitrate KNO_3 ensuring that the air relative humidity is 94%).

The mass change in every tested sample at a time interval, given in milligrams per hour, is calculated using the following formula:

$$G_{(1/2)} = (m_2 - m_1) / (t_2 - t_1)$$

m_1 – mass of the test unit at the time t_1 in milligrams,

m_2 – mass of the test unit at the time t_2 in milligrams

t_1, t_2 – test time given in hours.

Sample No.	1	2	3	4	5
G 1/2	11.3 mg/h	10.4 mg/h	10.8 mg/h	10.0 mg/h	9.6 mg/h

The density g of water vapour flow rate in milligram per square metre per hour is calculated using the following equation:

$$g = G/A$$

A – exposed area (arithmetic mean of exposed upper and lower area) at the tested samples, given in square metres.

Sample No.	1	2	3	4	5
g	2250 (mg/m ² ·h)	2083(mg/m ² ·h)	2167(mg/m ² ·h)	2000(mg/m ² ·h)	1917(mg/m ² ·h)

Water vapour permeability W in milligrams per square metre per hour per pascal is calculated using the following equation:

$$W = G / (A \times \Delta p)$$

ΔP – differential pressure of water vapour in pascals, equal to $23-50/95$ under the test conditions, $\Delta p = 1210 \text{ Pa}$.

Sample No.	1	2	3	4	5
W	1.86 (mg/m ² ·h·Pa)	1.72 (mg/m ² ·h·Pa)	1.79 (mg/m ² ·h·Pa)	1.65 (mg/m ² ·h·Pa)	1.58 (mg/m ² ·h·Pa)

Water vapour diffusion resistance Z in square metres multiplied by hour by pascal per milligram is calculated using the following equation:

$$Z = 1/W$$

Sample No.	1	2	3	4	5
Z	0.54 (m ² ·h·Pa/mg)	0.58 (m ² ·h·Pa/mg)	0.56 (m ² ·h·Pa/mg)	0.61 (m ² ·h·Pa/mg)	0.63 (m ² ·h·Pa/mg)

Water vapour permeability in milligrams per metre per hour per pascal is calculated using the following equation:

$$\delta = W \times d$$

d – sample thickness, in metres.

Sample No.	1	2	3	4	5
d	0.0119 m	0.0118 m	0.0127 m	0.0119 m	0.0115 m
	0.022 (mg/m·h·Pa)	0.020 (mg/m·h·Pa)	0.023 (mg/m·h·Pa)	0.020 (mg/m·h·Pa)	0.018 (mg/m·h·Pa)

The water vapour diffusion resistance (dimensionless) is calculated using the following equation:

$$\mu = \delta_{\text{air}} / \delta$$

δ_{air} – permeability of water vapour in air (dependent on the mean atmospheric pressure during the test)

Sample No.	1	2	3	4	5
	32.1	34.9	31.1	36.2	38.9

Mean water vapour diffusion resistance μ

$$\mu = 35$$

Thickness of the air layer equivalent to water vapour diffusions s_d (in metres) is calculated using the following formula:

$$s_d = \mu \times d$$

Sample No.	1	2	3	4	5
s_d	0.38 m	0.41 m	0.39 m	0.42 m	0.44 m

The mean value of the thickness of air layer equivalent to water vapour diffusion s_d (relative diffusion resistance) of an ESP layer with an average thickness of 12 mm is equal to:

$$s_d = 0.41 \text{ m}$$

The aforesaid parameters may be applied to the description of characteristic physical properties of the NEOPOR expandable polystyrene.

33.Attachment no. 1 – Test report on thermal conductivity



POLSKIE CENTRUM BADAŃ I CERTYFIKACJI S.A.
02-699 Warszawa, ul. Kłobucka 23 A
Oddział Badań i Certyfikacji w Gdańsku
Laboratorium Wytwarzania Budowlanych
ul. Wejhera 18 a, 80-346 Gdańsk
tel. 58 511 06 27, tel./fax 58 511 06 26
e-mail: labmb@pcbc.gda.pl



TEST REPORT **No. 320/T/2013**

Gdańsk, 9 September 2013

- 1. Description of the test subject:** wall elements of the Izodom 2000 Polska system – expanded polystyrene boards (white, 25 g/l) acc. to PN-EN 13163:2009 “Thermal insulation products for buildings. Factory made expanded polystyrene (EPS) products. Specification”
- 2. Employer’s name and address:** Izodom 2000 Polska Sp. z o.o., ul. Ceramiczna 2A, 98-220 Zduńska-Wola
- 3. Manufacturer’s name and address:** Izodom 2000 Polska Sp. z o.o., ul. Ceramiczna 2A, 98-220 Zduńska-Wola
- 4. Order number and date:** 14 September 2013
- 5. Ordered scope of testing:** Verification of thermal conductivity and thermal resistance at a temperature of 10 °C
- 6. Sampling date:** samples collected by the Manufacturer
- 7. Sampling method:** samples collected by the Manufacturer
- 8. Samples delivered to the laboratory:** 16 August 2013
- 9. Deviations from the test methods:** none
- 10. Tests completed on:** 5 September 2013

Page 1 of 2

FGL-07 Issue XI, June 2013

-
1. The results refer to the tested items only.
 2. This report may be copied in its entirety, or otherwise consent granted by the laboratory is required.
 3. Any complaints relating to the performance of the tests can be submitted within one month upon receipt of this report.

11. Test results:

11.1. Verification of thermal conductivity and thermal resistance at a temperature of 10 °C – testing procedure according to PN-EN 12667:2002 "Thermal performance of building materials and products. Determination of thermal resistance by means of guarded hot plate and heat flow meter methods. Products of high and medium thermal resistance"

Sample No.	Date of manufacture	Thermal conductivity [W/mK]	Thermal resistance [m ² K/W]
1	11-08-2013	0.0323	1.62
2	19-09-2012	0.0324	1.60
3	19-09-2012	0.0328	1.58
4	11-08-2013	0.0329	1.58
5	11-08-2013	0.0330	1.63
6	11-08-2013	0.0324	1.59
7	12-08-2013	0.0327	1.64
8	12-08-2013	0.0332	1.57
9	12-08-2013	0.0328	1.59
10	12-08-2013	0.0324	1.60
mean value		0.0327	1.60
standard deviation		0.0003	0.03
k		2.07	2.07
declared values		0.034	1.50

Detailed test results are presented in Attachments to this Test Report.

Prepared by:

Laboratory Head

Anna Kuliś



Approved by:

Deputy Laboratory Head

Ewa Bohdanowicz



POLSKIE CENTRUM BADAŃ I CERTYFIKACJI S.A.

02-699 Warszawa, ul. Kłobucka 23 A
Oddział Badań i Certyfikacji w Gdańsku
Laboratorium Wytrobów Budowlanych
ul. Wejhera 18 a, 80-346 Gdańsk
tel. 58 511 06 27, tel./fax 58 511 06 26
e-mail: labmb@pcbc.gda.pl



AB 011



TEST REPORT

No. 321/T/2013

Gdańsk, 10 September 2013

- 1. Description of the test subject:** wall elements of the Izodom 2000 Polska system – grey expanded polystyrene boards containing graphite (NEOPOR) 30 g/l acc. to PN-EN 13163:2009 “Thermal insulation products for buildings. Factory made expanded polystyrene (EPS) products. Specification”
- 2. Employer’s name and address:** Izodom 2000 Polska Sp. z o.o., ul Ceramiczna 2A, 98-220 Zduńska-Wola
- 3. Manufacturer’s name and address:** Izodom 2000 Polska Sp. z o.o., ul. Ceramiczna 2A, 98-220 Zduńska-Wola
- 4. Order number and date:** 14 September 2013
- 5. Ordered scope of testing:** Verification of thermal conductivity and thermal resistance at a temperature of 10 °C
- 6. Sampling date:** samples collected by the Manufacturer
- 7. Sampling method:** samples collected by the Manufacturer
- 8. Samples delivered to the laboratory:** 16 August 2013
- 9. Deviations from the test methods:** none
- 10. Tests completed on:** 10 September 2013

Page 1 of 2

FGL-07 Issue XI, June 2013

1. The results refer to the tested items only.
2. This report may be copied in its entirety, or otherwise consent granted by the laboratory is required.
3. Any complaints relating to the performance of the tests can be submitted within one month upon receipt of this report.

11. Test results:

11.1. Verification of thermal conductivity and thermal resistance at a temperature of 10 °C – testing procedure according to PN-EN 12667:2002 "Thermal performance of building materials and products. Determination of thermal resistance by means of guarded hot plate and heat flow meter methods. Products of high and medium thermal resistance"

Sample No.	Date of manufacture	Thermal conductivity [W/mK]	Thermal resistance [m ² K/W]
1	06-06-2013	0.0298	1.64
2	04-06-2013	0.0300	1.62
3	03-06-2013	0.0299	1.66
4	12-02-2013	0.0300	1.64
5	11-03-2013	0.0298	1.64
6	05-06-2013	0.0298	1.64
7	18-03-2013	0.0300	1.64
8	11-03-2013	0.0300	1.62
9	01-02-2013	0.0300	1.62
10	29-06-2013	0.0299	1.63
mean value		0.0303	1.64
standard deviation		0.0001	0.01
k		2.07	2.07
declared values		0.031	1.60

Detailed test results are presented in Attachments to this Test Report.

Prepared by:

Laboratory Head

Anna Kuliś



Approved by:

Deputy Laboratory Head

Ewa Bohdanowicz



POLSKIE CENTRUM BADAŃ I CERTYFIKACJI S.A.

02-699 Warszawa, ul. Kłobucka 23 A
Oddział Badań i Certyfikacji w Gdańsku
Laboratorium Wytrobów Budowlanych
ul. Wejhera 18 a, 80-346 Gdańsk
tel. 58 511 06 27, tel./fax 58 511 06 26
e-mail: labmb@pcbc.gda.pl



AB 011



TEST REPORT

No. 324/T/2013

Gdańsk, 9 September 2013

- Description of the test subject:** wall elements of the Izodom 2000 Polska system – green expanded polystyrene boards (PERIPOR) 40 g/l acc. to PN-EN 13163:2009 “Thermal insulation products for buildings. Factory made expanded polystyrene (EPS) products. Specification”
- Employer’s name and address:** Izodom 2000 Polska Sp. z o.o., ul Ceramiczna 2A, 98-220 Zduńska-Wola
- Manufacturer’s name and address:** Izodom 2000 Polska Sp. z o.o., ul. Ceramiczna 2A, 98-220 Zduńska-Wola
- Order number and date:** 14 September 2013
- Ordered scope of testing:** Verification of thermal conductivity and thermal resistance at a temperature of 10 °C
- Sampling date:** samples collected by the Manufacturer
- Sampling method:** samples collected by the Manufacturer
- Samples delivered to the laboratory:** 16 August 2013
- Deviations from the test methods:** none
- Tests completed on:** 4 September 2013

Page 1 of 2

FGL-07 Issue XI, June 2013

- The results refer to the tested items only.
- This report may be copied in its entirety, or otherwise consent granted by the laboratory is required.
- Any complaints relating to the performance of the tests can be submitted within one month upon receipt of this report.

11. Test results:

11.1. Verification of thermal conductivity and thermal resistance at a temperature of 10 °C – testing procedure according to PN-EN 12667:2002 “Thermal performance of building materials and products. Determination of thermal resistance by means of guarded hot plate and heat flow meter methods. Products of high and medium thermal resistance”

Sample No.	Date of manufacture	Thermal conductivity [W/mK]	Thermal resistance [m ² K/W]
1	25-04-2013	1.55	1.64
2	26-04-2013	1.56	1.62
3	29-04-2013	1.51	1.66
4	30-04-2013	1.53	1.64
5	10-05-2013	1.55	1.64
6	14-05-2013	1.51	1.64
7	11-06-2013	1.54	1.64
8	15-06-2013	1.52	1.62
9	19-06-2013	1.52	1.62
10	20-06-2013	1.52	1.63
mean value		0.0303	1.53
standard deviation		0.0001	0.02
k		2.07	2.07
declared values		0.031	1.45

Detailed test results are presented in Attachments to this Test Report.

Prepared by:

Laboratory Head

Anna Kuliś



Approved by:

Deputy Laboratory

Ewa Bohdanowicz



@econekt Econekt

T +44 (0)844 225 1680 / info@econekt.co.uk / econekt.co.uk