



# CEDIA™

## SMART HOME

## RECOMMENDED WIRING GUIDELINES

A guide to Smart Home cabling requirements for the modern home

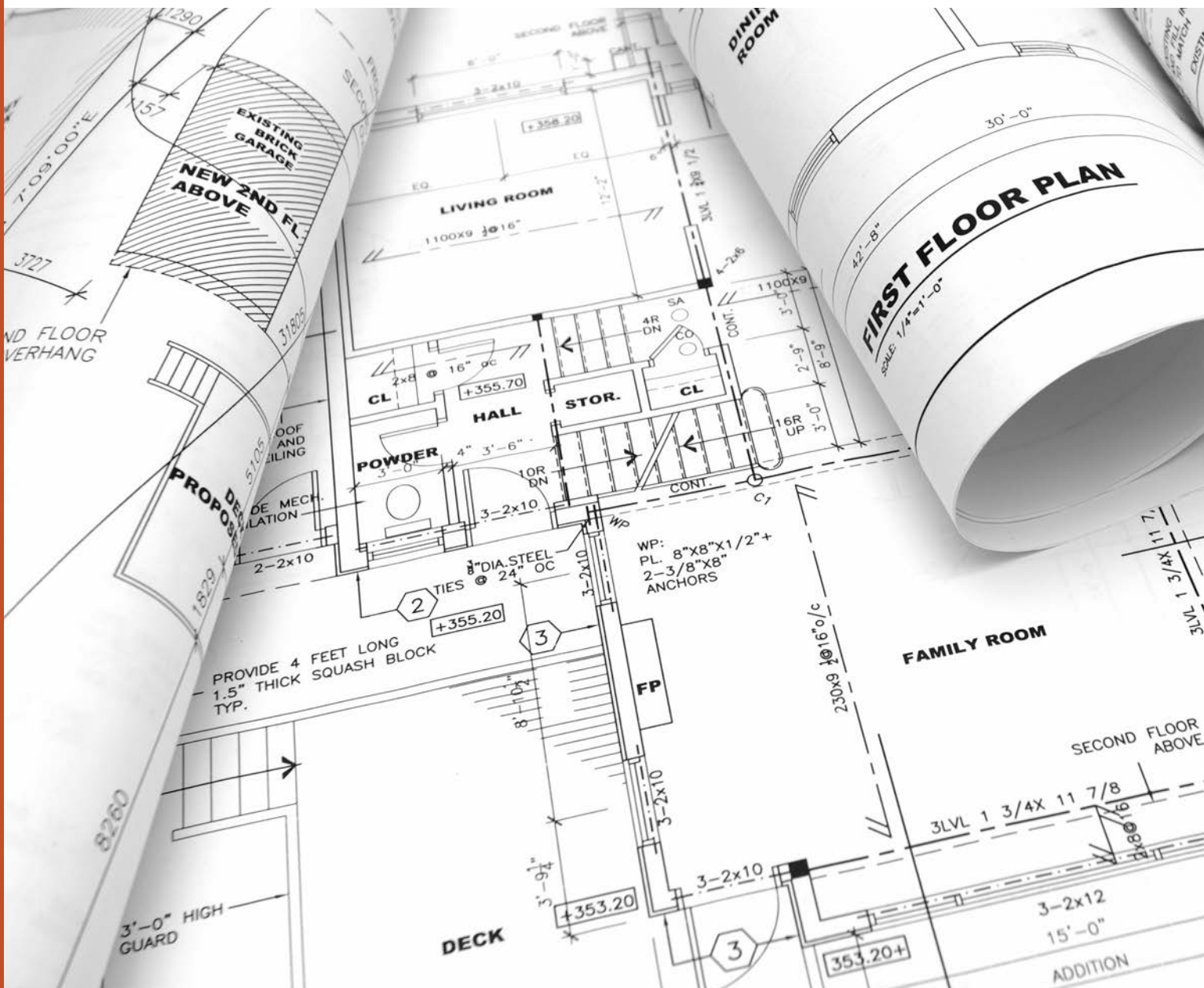



# RAISING STANDARDS AND AWARENESS OF THE HOME TECHNOLOGY MARKET



## WHO IS CEDIA?

The Custom Electronic Design and Installation Association (CEDIA) is the international trade organisation representing the home technology industry.

Our members specialise in the planning, design, supply and installation of technology for the modern, intelligent home. The Association was founded in 1989 and has more than 3,500 member companies worldwide.

CEDIA was created to develop and deliver educational programmes, certification and trade shows to make sure that the industry is kept up-to-date with skills and technology relevant to this specialist market. Core to CEDIA is also raising the awareness and profile of the industry and the Association's members to a wide variety of audiences.

Homeowners, builders, architects and interior designers, are increasingly recognising CEDIA members as the professional resource for home technology. CEDIA is governed by its members, many of whom volunteer generously to ensure their peers have the finest education and industry support possible.

# 01 INTRODUCTION

## AIM

The aim of these CEDIA Smart Home Recommended Wiring Guidelines is to provide homeowners, builders, electricians and developers with guidance for the installation of the cabling infrastructure that is important to support today's digital and connected lifestyles.

CEDIA understands that though we would always recommend that you talk to a CEDIA specialist as soon as possible in your project, you may wish to undertake the project yourself. If at any time there is ever ambiguity, uncertainty or you would like further advice, please contact a CEDIA member company ([www.cedia.org](http://www.cedia.org)). The most expensive cable that can be installed is the one that did not get installed in the first place. Mistakes can be costly so it is vital to get the cabling infrastructure correct the first time round.

## BENEFITS OF CORRECT CABLING

The benefits of installing a good infrastructure at a build or refurbishment stage are multifold and include:

- Having the ability to discretely integrate and distribute Internet, Entertainment (TV, satellite and music), Computer and Communication systems around the home without having to trail any additional wires.
- Enabling the home for future Digital Healthcare applications.
- Adding value to the home by ensuring that future buyers' home technology needs are met.
- Preserving the décor and structure of the home by planning for future needs (retro-fitting cables can be disruptive and costly).
- Providing the correct wired infrastructure to enable a robust wireless network.
- The ability to enjoy multi-room media systems throughout the home.

## YOUR PROJECT

A typical project cycle will contain the following steps:



It's important that you think about which services you wish to have in your home before the design and installation stage. This will help you to work out if what you want is achievable, with or without professional guidance.









## 02 CHOOSING YOUR SERVICES

### CHOOSING THE SERVICES FOR YOUR HOME

Any installation will require you to make decisions and choose which services you want to have available in each room of your home. Each of these services will require a minimum amount of cabling to ensure it works with today's technology and future technology.

CEDIA has defined two grades of recommended cabling infrastructure. The highest level beyond these grades will give the homeowner more flexibility and scope to install more sophisticated and integrated systems but may require professional guidance due to their customisable nature. Grades 1 and 2 may provide more than enough scope and flexibility for the homeowners system requirements, and will mean a simpler design and installation process. We recommend that every house that is being built or refurbished has a minimum of a Grade 1 cabling infrastructure installed.



	SERVICE DESCRIPTION	DESCRIPTION	GRADE 1	GRADE 2	BESPOKE
	<b>SATELLITE, RADIO, DIGITAL AND CABLE TV</b>	Cabling for Satellite television, Freeview TV and Radio. Also provision for cable TV.	✓	✓	✓
	<b>HOME NETWORK - BROADBAND AND WIRELESS INTERNET</b>	Cabling for a wired home network and a robust wireless network.	✓	✓	✓
	<b>TELEPHONE</b>	Cabling for telephone points and for devices requiring a telephone line connection (such as Sky).	✓	✓	✓
	<b>MULTI-ROOM AUDIO</b>	Cabling for speakers (such as in-ceiling) and audio control points from an AVHE (Audio Video Head End) location.		✓	✓
	<b>SCENE SETTING LIGHTING AND BLIND CONTROL</b>	Cabling for a lighting control system and automated blinds, cabling and systems can vary.			✓
	<b>HOME AUTOMATION</b>	Bespoke cabling to allow control of multiple systems within the home.			✓
	<b>CCTV AND SECURITY</b>	Bespoke cabling for CCTV and security coverage of the home, usually following a security risk assessment and design.			✓
	<b>MULTI-ROOM VIDEO</b>	Cabling for high definition video from an AVHE (Audio Video Head End) location.			✓
	<b>HOME CINEMA</b>	Bespoke cabling for the required level of home cinema design.			✓

# 03 WIRING GRADE REQUIREMENTS

## GRADES OF INSTALLATION

Each CEDIA wiring Grade has a minimum cabling requirement defined as a benchmark to correctly wire for the services within the home. As the Grade level increases so does the complexity of the cabling needed, and the level of product and technology level that is required to correctly specify and design a system. Grade 1 systems are simple enough that they can be installed by a homeowner with confident technical abilities, or by a qualified electrician. Grade 2 system cabling demands some additional input at the design stage, and can require a more complex installation depending on the multi-room equipment to be installed and so may need help from a specialist CEDIA member. Due to the customisable nature of bespoke systems it is always recommended that a CEDIA member is consulted as early as possible in the project lifecycle.

### GRADE 1

A Grade 1 cabling infrastructure involves installing a combination of twisted pair data cable (called Cat5e, Cat6 or Cat6a) in combination with TV & Satellite Coaxial cable (typically called CX100 or WF100) to most rooms in the house excluding lavatories and bathrooms. This will allow easy delivery of internet services, home networking, TV, satellite, radio, telephone, conferencing and other entertainment services to these rooms. Modern construction techniques are very unfriendly to high-speed wireless connections (Wi-Fi) and a cable infrastructure will allow the wireless equipment to be optimally located for good signal strength and speed.

#### MINIMUM CABLING

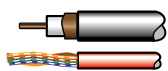

CX100 or  
Cat5e, Cat6 or  
Cat6a

#### INSTALLATION

A homeowner, qualified electrician or CEDIA member

### GRADE 2

A Grade 2 cabling infrastructure includes all the cables in a Grade 1 infrastructure in addition to cables designed to enable the installation of whole-house entertainment systems. These systems allow the use of discreetly hidden speakers and in-wall control points to deliver and control a wide range of entertainment options. Used in conjunction with the cables installed for Grade 1, a Grade 2 system can deliver high quality music and TV pictures around a home fed from a central equipment hub.

#### MINIMUM CABLING

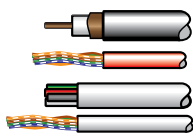

CX100 or  
Cat5e, Cat6 or  
Cat6a  
Cat5e/6/6a +  
4 core

#### INSTALLATION

A qualified electrician (with audio system installation experience) or CEDIA member

### BESPOKE

A bespoke system may encompass all the cables in Grades 1 and 2 in addition to cables designed for Home Automation. This functionality can include a lighting control system, motorised curtains and blinds, access control systems, CCTV networks, environmental and heating control, as well as systems that allow all of the above to be controlled and integrated by a single control system using in-wall controls and hand-held remote controls. Due to the bespoke nature of some of these systems, unlike Grades 1 and 2, generic recommendations cannot be made so it is essential to discuss your requirements for these advanced systems with a CEDIA member.

#### MINIMUM CABLING

Bespoke depending on design

#### INSTALLATION

CEDIA member only













# 04 PLANNING YOUR HOME

## PLANNING YOUR HOME

Any system will require planning before an installation ever begins. Whilst design changes can happen on-site during a project, these should always be based on an initial design. Multiple changes on-site due to lack of planning only serve to slow the installation process and add cost to the project. With only basic floorplans it is possible to plan which services you need prior to the design or installation stage.

## SAMPLE HOUSE PLAN

The example below shows communications, entertainment and multi-room audio locations.

SERVICE DESCRIPTION		SYMBOL
	<b>SATELLITE, RADIO, DIGITAL AND CABLE TV</b> (add where ever you want a entertainment outlet)	
	<b>BROADBAND AND WIRELESS INTERNET</b> (add where ever you want a home network outlet)	
	<b>TELEPHONE</b> (add where ever you want a communications outlet)	
	<b>MULTI-ROOM AUDIO</b> - speaker - control keypad	
		
	<b>SCENE SETTING LIGHTING AND BLIND CONTROL</b>	If you require Lighting or Blind Control, Home Automation, CCTV or Security then you should contact a CEDIA member. They will design and install your system to your requirement.
	<b>HOME AUTOMATION</b>	
	<b>CCTV AND SECURITY</b>	

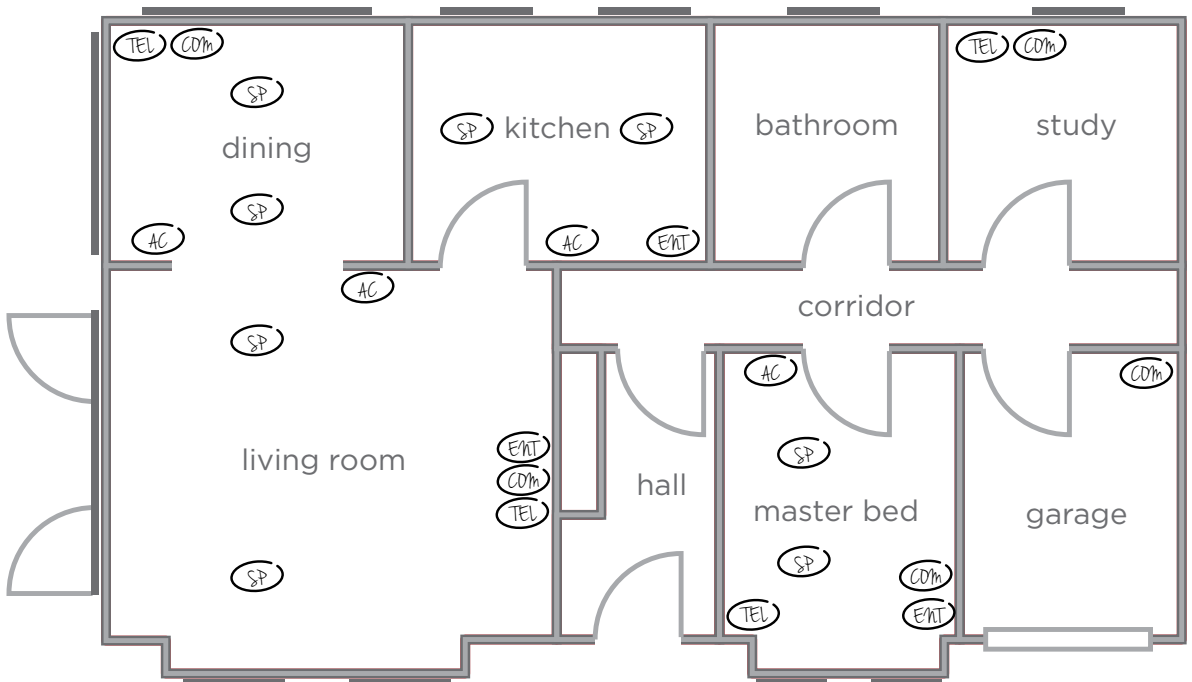

# 05 INCOMING SERVICES

An important area that can be overlooked in a project lifecycle are the incoming services to the home. It's important to ensure that the correct cable connections are in place for incoming services to be connected and distributed around the home. Different incoming services enter the property from different locations, but all should end in a common location within the property called the **Extra Low Voltage Head End (ELVHE)**.

Each incoming service will have to be commissioned by a service provider or specialist installer to be made live. It's advised to contact any service provider or arrange for any TV and Satellite dish installation early on into the project lifecycle so any work can be scheduled, and cable entry points can be identified to connect to the incoming services.

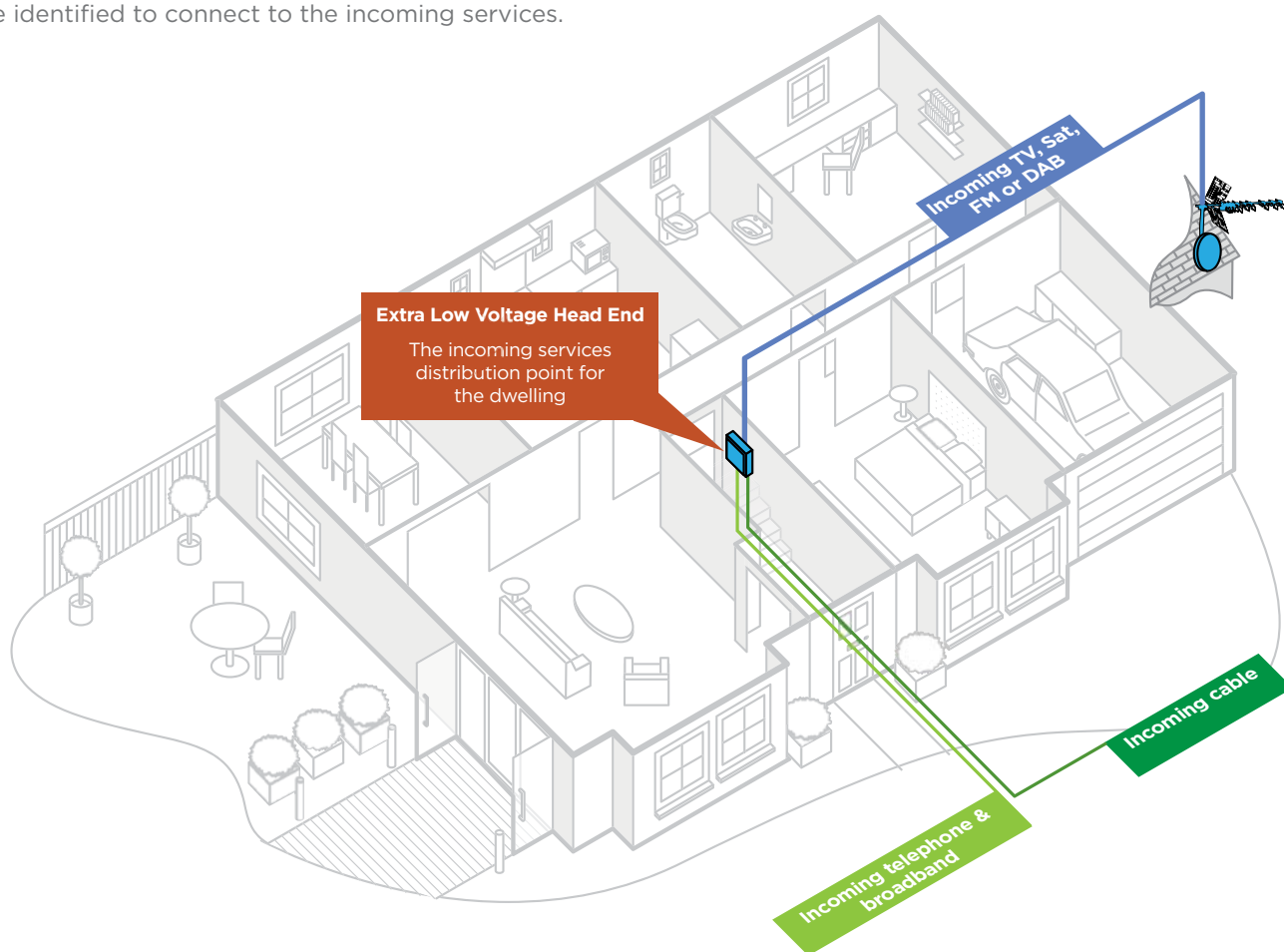



## SATELLITE DISH, TV (FM AND DAB) AERIAL

Typically installed at roof level and so it is recommended that a specialist TV aerial installer is contacted to install equipment at high levels. A bad dish or aerial installation will result in poor signal distribution around the home. Coaxial cables (and earth) should be run from the dish and aerial location to the ELVHE.

## CABLE TV SERVICES

Cable TV services require connection that typically enter the home from street level and can provide cable TV services, phone and broadband. Cat5e and Coaxial cable provision should be run from the entry location to the ELVHE.

## TELEPHONE AND BROADBAND

The telephone line can enter the home from high level or may enter from street level. A Cat5e connection should be run in provision from this location to the ELVHE.

## RECOMMENDED CABLING



5 x Coaxial cables (+ optional earth\*)

## MINIMUM CABLING

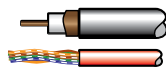

CX100 or Cat5e, Cat6 or Cat6a

## MINIMUM CABLING

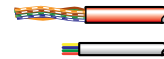

Cat5e, Cat6, Cat6a or CW1308 cable

# 06 GRADE 1 SYSTEM

## GRADE 1 SERVICES

To provide cabling to enable one or more of the following services.



**Satellite, radio, digital and cable TV**



**Broadband and wireless internet**



**Telephone**

## DESCRIPTION

The Grade 1 cables must all start from a single location, known as **ELVHE (Extra Low Voltage Head End)**.

The ELVHE should have all incoming services routed to it, to include cable TV, telephony, internet, digital TV, digital radio, and satellite TV.

A simple wiring hub should also be supplied as part of the design and in all instances cables should be tested, certified where applicable, and made live.

## MINIMUM CABLE REQUIREMENTS

In order to meet the CEDIA Grade 1 level a minimum number of outlets must be present in at least 4 rooms of the installation:

- 1 x Data outlet
- 1 x Telephone outlet
- 1 x TV/Sat/Radio
- plus incoming services

All cables listed are to meet a minimum performance specification for the application. Higher performance cables may be used.

## CABLE TYPES USED



Cat5e (reference standard - TIA/EIA-568A/B).



WF100 foam filled coax\* (reference standard).

\*air spaced dielectric cables are acceptable but will not meet CATV providers minimum requirements.



5 x WF100 foam filled coax\* cables (may be in a single sheath).



\*\*CW1308 may be used to interface to the telecoms network if BT does not provide the cable, but Cat5e would be perfectly suitable.

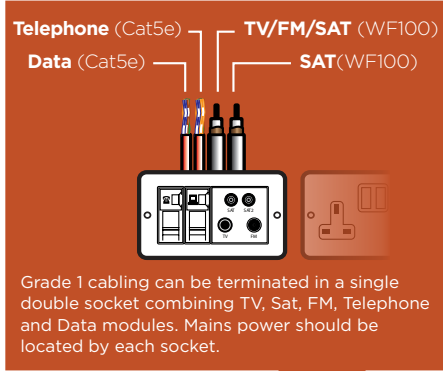

Consideration must be given to the location of satellite TV cables to ensure the dish location can point toward the relevant satellite.

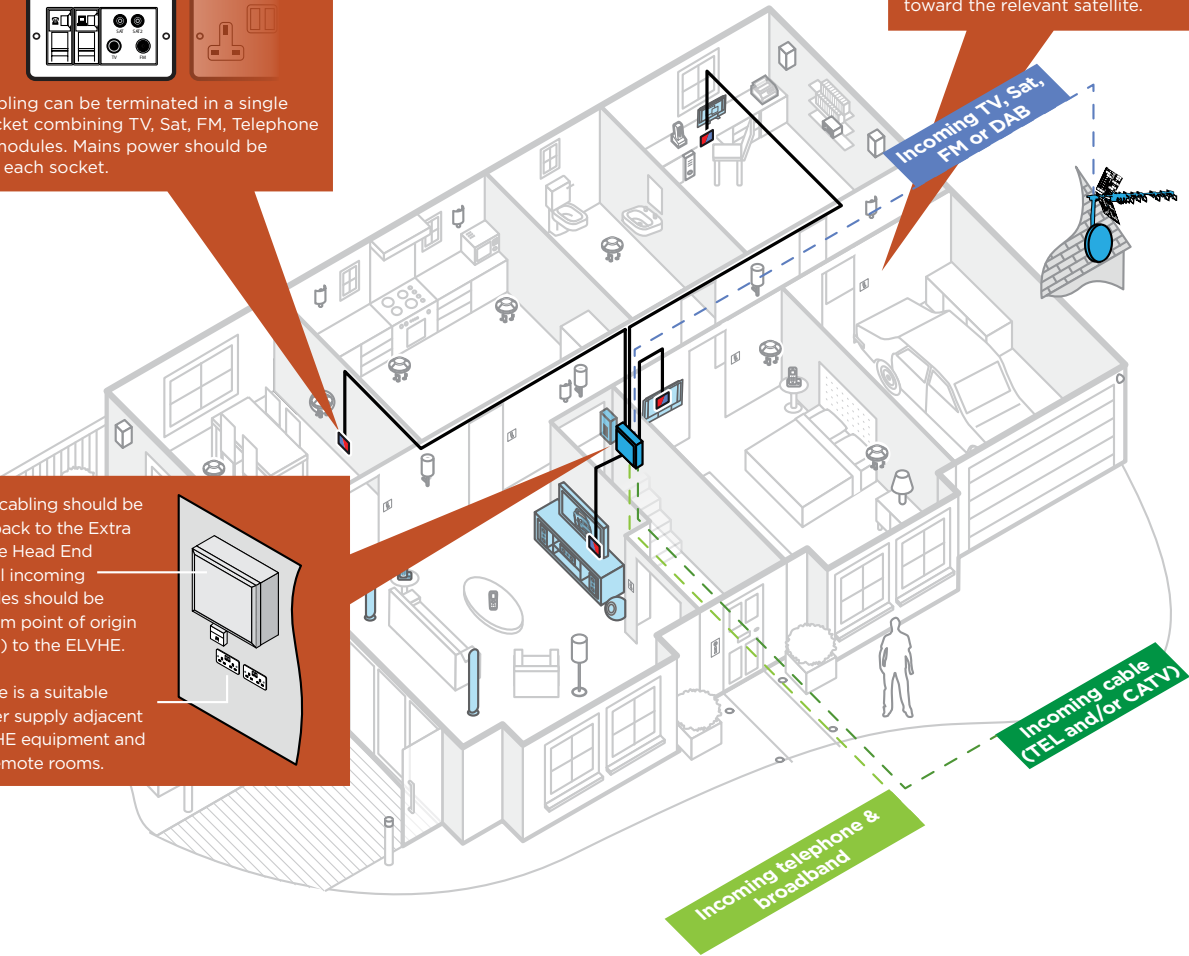
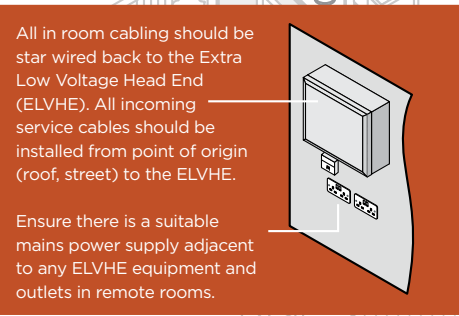

	DESCRIPTION	CABLING	CONNECTION (A to B)	
<b>DWELLING SERVICES</b>	TV / SAT / RADIO	2 X WF100 COAX*	TV / SAT / RADIO OUTLET	ELVHE
	DATA	1 X CAT5E	DATA OUTLET	ELVHE
	TELEPHONE	1 X CAT5E	TELEPHONE OUTLET	ELVHE
<b>INCOMING SERVICES</b>	DIGITAL TV & RADIO	1 X WF100	TV/FM AERIAL LOCATION	ELVHE
	CABLE TV	1 X RG6 OR SIAMESE CATV PROVIDER CABLE	INCOMING CABLE LOCATION	ELVHE
	SATELLITE	4 X WF100	SATELLITE DISH	ELVHE
	TELEPHONE & BROADBAND	BT CABLE TERMINATED AT NTPP**	INCOMING LINE LOCATION	ELVHE

# 07 GRADE 2 SYSTEM

## GRADE 2 SERVICES

In addition to services provided in Grade 1, a Grade 2 wired home includes the provision of wiring a number of multi-room audio zones.



## DESCRIPTION

Cabling as listed in Grade 1 *plus*:

Additional 4 core speaker + Cat5e cabling for a multi-room audio system.

Each speaker cable and Cat5e are run together, and provide wiring for an 'audio zone'. These cables must all start from a single location, known as the AVHE (Audio Video Head End). The AVHE is located at the ELVHE location.

Additional cabling must be run to a suitable main living space location where Grade 1 cabling has been terminated - e.g. the main lounge. This cabling is referred to as the 'Remote AVHE cabling\*', and provides links to the AVHE for additional audio sources.

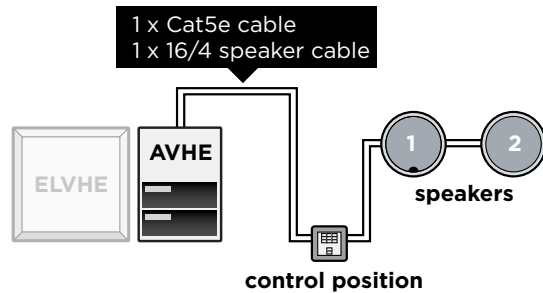

Each audio zone to be wired for multi-room audio will have a Cat5e + 4 core speaker cable run via a suitable control position (typically a switch level backbox), and then from the control position to the first speaker and then looped to the second speaker. This is the principle of the CEA/CEDIA 2030-A standard. Wiring in this way allows for the following options:

- (a) a remote keypad to be located in each room with a central amplifier.
- (b) a remote sensor installed at each speaker with a central amplifier.
- (c) a Cat5e based speaker (with internal amplifier) with the speaker cable being used for power.

\* Remote AVHE cabling - two additional Cat5e and two additional Coax cables should be run to the AVHE location from the ELVHE. Grade 1 cabling should also be available at this location.

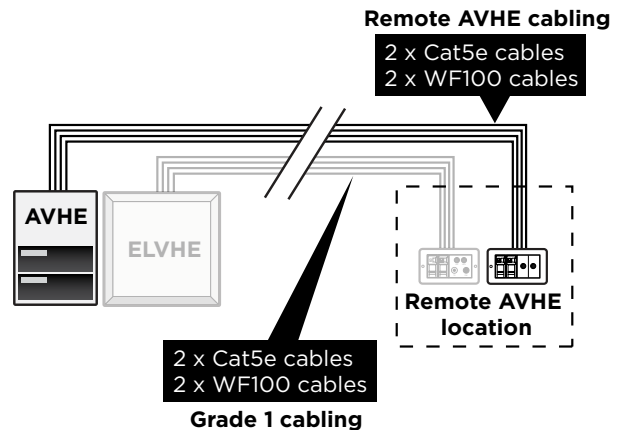

## AUDIO CABLING



Cat5e (reference standard - TIA/EIA-568A/B) and 4 core speaker cabling (4 core speaker cable with 4 cores of 16 gauge). A 'shotgun' Cat5e and 4 core speaker cable helps to minimise cable runs.

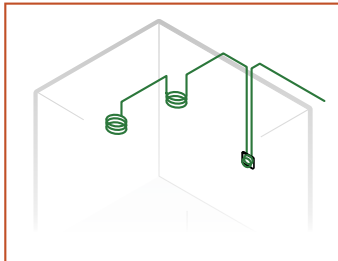

1.5m cable coils should be left at speaker pre-wire locations and 15cm coils in backboxes. All speaker locations should be accurately recorded for future installation.

In-ceiling speaker locations will need to be coordinated so that an unobstructed installation is possible. Avoid locating next to joist, beam or pipe work.



Minimum 200mm diameter void, 100mm clear depth required for installation of in-ceiling speakers

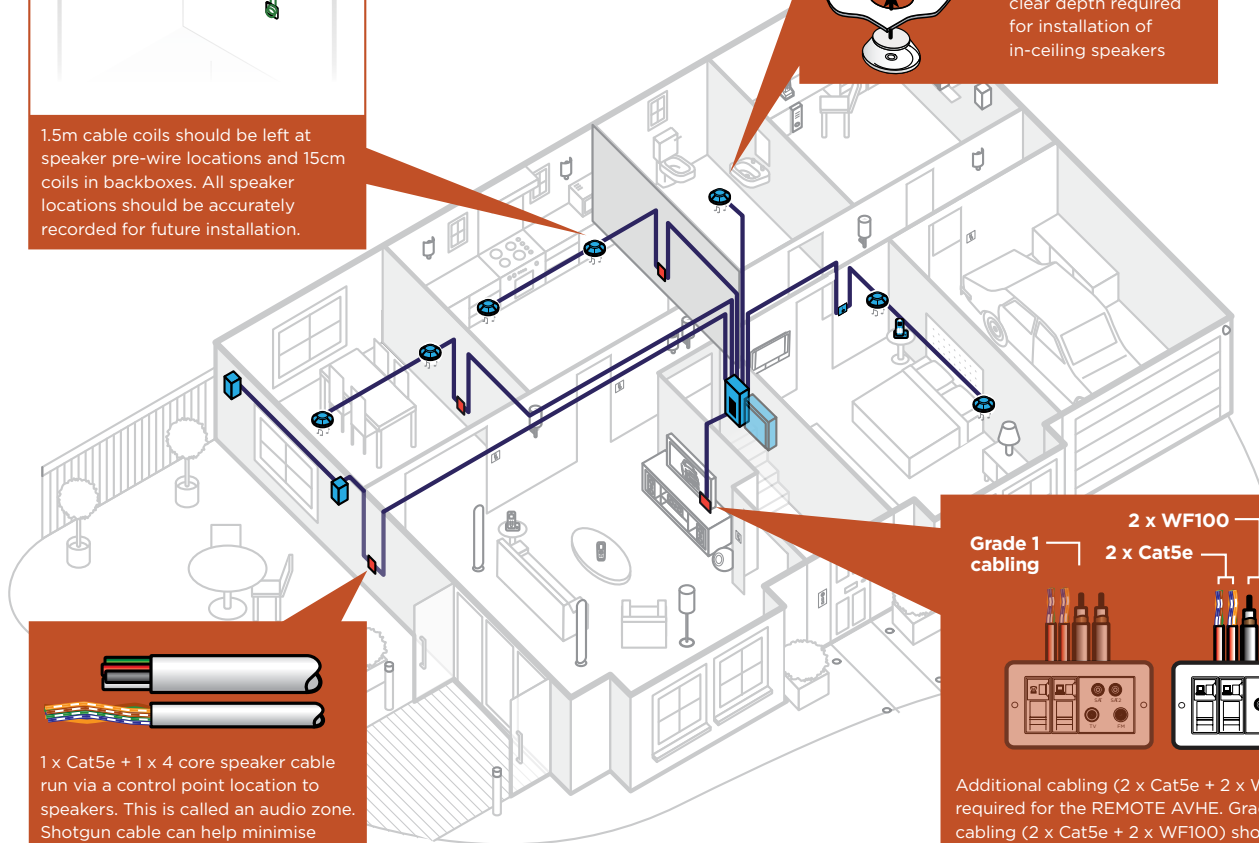

1 x Cat5e + 1 x 4 core speaker cable run via a control point location to speakers. This is called an audio zone. Shotgun cable can help minimise cable runs.

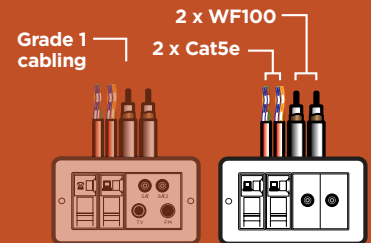

Additional cabling (2 x Cat5e + 2 x WF100) is required for the REMOTE AVHE. Grade 1 cabling (2 x Cat5e + 2 x WF100) should also be available here.

	DESCRIPTION	CABLING	CONNECTIONS (A to B)
<b>AUDIO ZONE</b>	2 X SPEAKERS LOCATIONS 1 X CONTROL POINT	1 X CAT5E 1 X 4 CORE SPEAKER 1 X WF100	SPEAKERS VIA CONTROL POINT → AVHE
<b>REMOTE AVHE</b>	ADDITIONAL CABLING FOR AUDIO SOURCES	2 X CAT5E 2 X WF100 + GRADE 1 CABLING	REMOTE AVHE LOCATION → AVHE

# 08 INSTALLATION

## WHAT SHOULD I DO NOW?

If you are the homeowner, property developer or electrician follow these simple steps:

1 - Decide on wiring for Grade 1 or Grade 2.

2 - Mark up house plans (where you want the 'stuff'). Record which rooms have which services within them in the table below. Record which room the ELVHE is located, and also the AVHE (if located in a remote location from the ELVHE).

3 - Begin the installation of cable, backboxes, sockets, ELVHE and AVHE equipment.

4 - Continuity check the cables and record any speaker coil locations for future reference before the walls are closed up.





5 - Finish installation of sockets, ELVHE and AVHE equipment.

6 - Mark up 'as built' drawings and installation for future reference (These must include dimensions showing where cables coils can be located within ceiling voids or wall voids).

7 - Get the cabling CEDIA verified.

8 - You're done.



Room Name	GRADE 1			GRADE 2	
	 Sat, TV	 Internet	 Phone	 Speaker	 Keypad

<b>ELVHE located in:</b>
<b>AVHE located in:</b>

# 09 CEDIA VERIFICATION

## HOW DOES IT WORK?

A qualified CEDIA Structured Cabling Assessor\* (CSCA) will verify or certify all of the cabling at the time of installation. This type of extra low voltage wiring is not covered under BS7671 regulations and therefore does not need to be signed off under the usual electrical certificate that is issued for a home.

The assessor will test all cabling, check the documentation is correct and when complete issue a CEDIA certificate of conformity for the home. This guarantees that the wiring is correct, ready to use, and safe when you move in. All you have to do is start plugging in equipment.

All CSCA individuals will be CEDIA ESC-T certified and will be carrying with them a photo ID card.

To meet the CEDIA Grade 1 cabling infrastructure a minimum number of cables must be present in the installation:

- 1 x Data outlet
- 1 x Telephone outlet
- 1 x TV/Sat/Radio
- plus incoming services

To meet the CEDIA Grade 2 cabling infrastructure a minimum number of cables must be present in the installation:

Grade 1 cabling (as above)

4 x 4 core speaker + Cat5e cables  
(to support 4 zones of audio)

**CERTIFICATE NUMBER**

## SMART HOME CABLING CERTIFICATE

Address: \_\_\_\_\_

.....

***This certificate validates that on the day of issue the property described above meets CEDIA's required standard for smart wiring technology and that:-***

- 1) The cabling, which has been tested as continuous, is functional and safe to use
- 2) The installation has been carried out using components which are suitable & compatible with Extra Low Voltage wiring technology
- 3) There is a design, or appropriate documentation, showing the layout and routing of the wiring and other components used in the installation
- 4) The minimum number of cables, outlets and functional terminals are installed to warrant our certificate
- 5) The system is either Grade 1 or Grade 2 in terms of design and installation complexity

It does not offer:

- 1) Any guarantee that the system and installation will remain compatible with, or suitable for, any particular type of technology
- 2) Capability for alteration, addition or variation
- 3) Compliance with any future standard or requirements
- 4) Any warranty by CEDIA as to performance or adaptability

Assessor Name	Company Name
.....	.....
Grade	Date of Assessment
.....	.....

info@cedia.co.uk +44 (0)1480 213744

www.cedia.org

\* Refresher courses are conducted periodically to ensure that all CSCA individuals maintain structured cabling best practices

# 10 RUNNING CABLES

## ELECTRICAL REQUIREMENTS

Low Voltage and Extra Low Voltage cabling requires some special consideration when being run around the property. Due to the type of signals they carry, they are susceptible to interference from mains and high voltage cabling. A qualified electrician will be able to run these cables with this in mind. Some guidelines are:

- Ensure all exposed cables (or those run underground) are sufficiently protected.
- If sockets are not to be terminated, leave tails on all cables - 3 metres at the equipment site, 30cm at a backbox.
- Label cables in a unique fashion and fix near the backbox.
- Use 47mm deep backboxes for sockets.
- Ensure cable entry into backboxes is from the bottom of or top of the backbox.
- Cables shouldn't run parallel to mains/lighting cables for any distance greater than 2m, unless at least 450mm apart. There are no problems if cables just cross at 90 degrees.

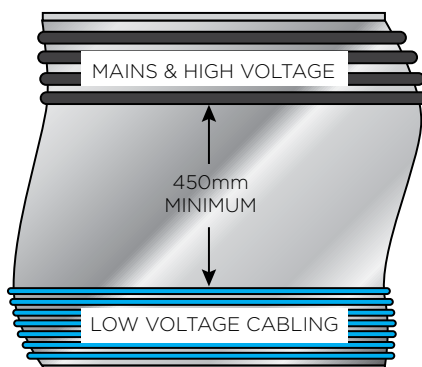

## CABLE DO'S AND DON'TS

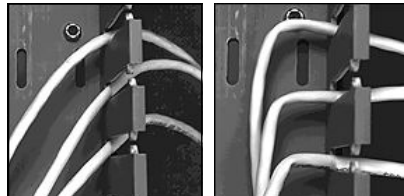

Don't allow the cable to form right angles or sharp bends. Use sweeping bends, no tighter than the curve of a can of Cola.

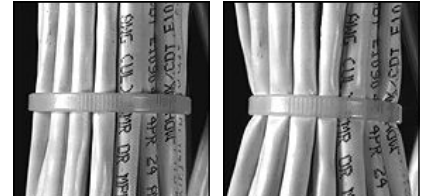

Use tie wraps loosely on large bundles. Do not overstress cables by over tightening cable ties, especially to the point where crush-stress is visible.

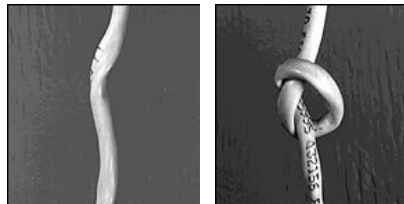

Don't allow the cable to kink, knot or snag while pulling it off the spool or out of the box; deforming the pair-twist will alter the performance of the cable.

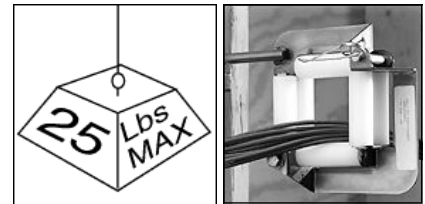

Use a cable pulling accessory. Pull cable using less than 25 pounds (11.3 kg) of pull-force.

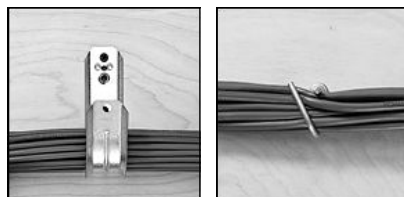

Use j-hooks or similar devices designed to support cables. Do not overstress cables by overloading.



Ensure 1.5m cable coils are left at speaker pre-wire locations to allow for easy installation. Record any pre-wire locations accurately.



# 11 ELVHE & AVHE PLANNING

## EXTRA LOW VOLTAGE HEAD END (ELVHE)

The ELVHE is where the incoming services and most cables will run back to. A location for this needs to be determined for the electrical contractor at an early stage. The ELVHE can be hidden away under the stairs or in a utility room, for example. It needs to be placed somewhere accessible and at an appropriate height from the floor so an electrician or engineer can safely work on it.

The panel needs 2 x 13 Amp double switched socket outlets located close to it. It is recommended that cable management be provided to run the cables to the ELVHE. Trunking can be used to feed cables directly into the cable knock-outs, or run alongside as indicated. The electrical contractor will decide the best way of managing the cables.

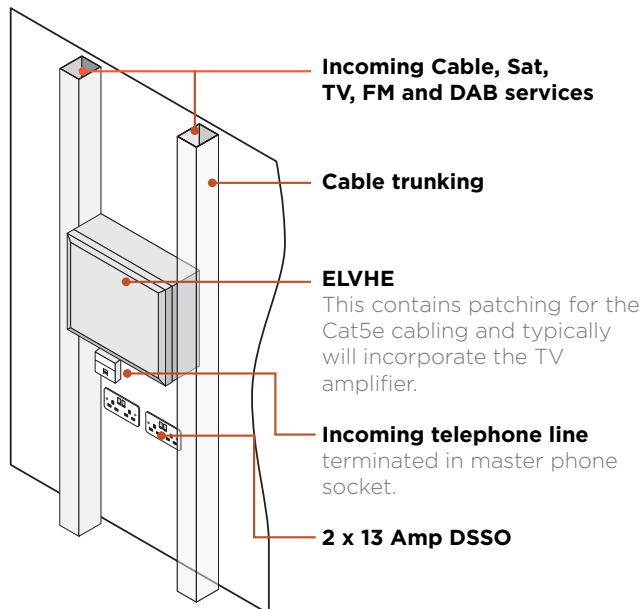

## AUDIO VIDEO HEAD END (AVHE)

The AVHE is located at the ELVHE. A suitable patch or enclosure panel may be installed or shelving could be provided for the equipment (with the cables being terminated in a backbox with a faceplate at the shelving location). Ensure there is appropriate mains power adjacent to any head end equipment. Any AVHE location will need to be suitably ventilated.



## BENEFITS OF CORRECT CABLING

The remote AVHE cabling should be co-located to the Grade 1 cabling termination point e.g. the main lounge. Consideration should be made as to where to house the audio sources and amplifier components - this may often be within a piece of joinery. Any equipment will need to be suitably ventilated.

\* Don't forget that suitable mains power supply will be required for the remote AVHE and any head end equipment.

# 12 TERMINATION

Use TIA/EIA-568B standard for wiring both sockets and plugs.

PIN	T568B COLOUR	PIN	T568B COLOUR
1	white/orange stripe	5	white/blue stripe
2	orange solid	6	green solid
3	white/green stripe	7	white/brown stripe
4	blue solid	8	brown solid

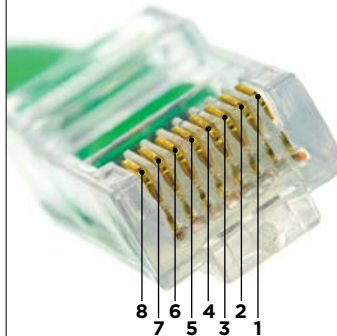

## TERMINATION - SOCKETS

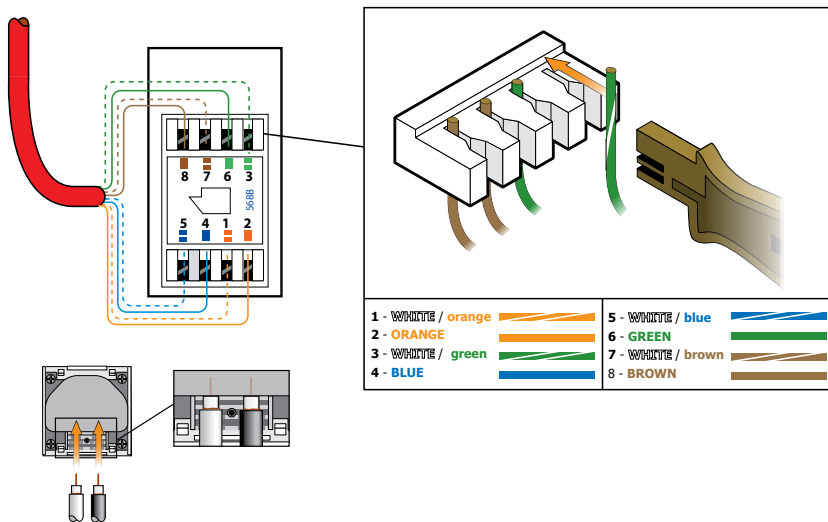

Ensure the core is fully pushed back into the IDC connector or it may result in no or a poor connection.

## TERMINATION - PLUGS

Crimp-style connectors have two parts: a ring (or crimp) and a terminator. They are typically more difficult to install, but can attain the greatest lengths and best connections when used correctly.

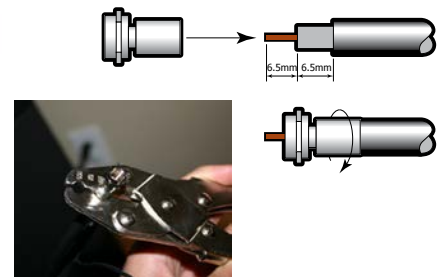

- Cut the cable flush.
- Trim the outer cover (usually black rubber) back 12mm.
- Be very careful not to cut into the metal braiding directly beneath the outer housing. The braiding may be both “loose” wire and a foil-like metal present in shielded wire.
- Carefully pull back the inner braiding (second channel) outside the outer cover. Check to make sure none of the braided wire gets wrapped around or touches the copper center conductor.
- Trim back the (usually white, but may be clear) dielectric plastic from the inner core cable.
- Be absolutely sure not to scratch or nick the center conductor. Any damage to this conductor can severely impact your signal.
- Push the connector down over the cable end so that the copper core of the coaxial cable sticks out.
- Be sure the dielectric (aluminum foil) is trimmed so that it does not enter into the terminator of the connector.
- Crimp or screw the connector into the end of the cable.

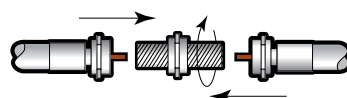

Use a F-Connector barrel adaptor to connect WM100 cables directly to one another.

## TERMINATION - PATCHBAYS

Patchbays come in a variety of sizes and mounting options. Most will be contained within a patch panel. Good patchbays should provide colour coded wiring information.

- Use an IDC Tool
- Use TIA/EIA-568A/B wiring
- Dress the cables from one side and run them in between the IDC blocks
- Align the pairs with the associated IDC
- Avoid untwisting the pairs as much as possible
- Punch down all the way and inspect each punch down to save time later
- Do not untwist the cable pairs more than 12mm or strip back more than 15mm of the cable jacket.

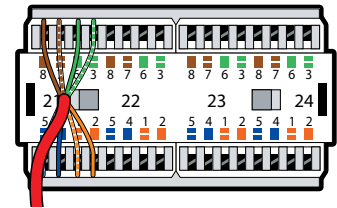

## ELVHE ENCLOSURE EXAMPLE



## COAXIAL CABLING - STANDARDS

Only CAI approved coaxial cabling should be used - WF100, WF125 and WF167.

Maximum cable run 50m.



## CAT5E CABLING - STANDARDS

Cat5e is supplied by a number of manufacturers. Always use a known brand as cheap imported cable can often be of a poor quality.



It is recommended that Cat5e wiring is completed to TIA/EIA-568A/B standard for wiring both sockets and plugs. Maximum cable run 90m.

# 13 DOCUMENTATION

It is important that all cables are documented and tested and a CEDIA member is well equipped to do this. This will allow homeowners, developers and builders to ensure that the user of the home can take full advantage of the installed cables. In today's digital driven lifestyle, this will enhance the value of the property and make it more desirable to potential purchasers.

The system should be documented as follows -

- The positions and type of all outlets should be marked on an architectural plan drawing of the property.
- There should be an accompanying schedule of cables describing cable type, termination type and locations of both ends of the cable. The identifications for the cables should tie in with the identifications on the plan drawing. The schedule should also act as the inspection and test sign-off sheet at time of commissioning.
- As an option, a schematic drawing showing the topology and connections of the installed cabling is recommended.
- The preparation of these documents could be carried out by the Architect, Electrical Contractor, Builder or ideally a CEDIA installer whose specialist field this is.



# 14 TESTING

## IMPORTANCE OF TESTING

“Fixing a fault at second fix is 10 times cheaper than fixing a fault at commissioning”.

Do not leave all the testing to the end – perform appropriate testing at each stage. After each Cat5e cable has been terminated it must be continuity tested and wire mapped.

There are three categories of testing:

### VERIFICATION

Verification answers the following question:

*“Do I have end-to-end continuity and a proper wiremap on the cable?”*

#### Verification Tools Provide:

- Basic continuity wiremap
- Identification of shorts or opens in a cable
- Length, and tone tracing



### QUALIFICATION

Qualification answers the following question:

*“Can this cabling link support the bandwidth requirements of the network and applications?”*

#### Qualification Tools Provide:

- Identification of links that will not support certain network speeds and technologies.
- Distance to performance faults like crosstalk.
- Assurance that existing cabling will support new technologies, like GBE and VoIP, before upgrading.



### CERTIFICATION

Certification answers the following question:

*“Does this cable comply with performance requirements of the International TIA or ISO standards?”*

The definition of performance and the level (“Category or Class”) of performance is defined by industry standards TIA/EIA-568A/B defines Cat5e, Cat6a, ISO/IEC 11801 and 61935 define Class C, D, E and F.

Industry standards specify a level of performance based on bandwidth analysis that is independent of a particular network technology.

## WIREFAPPING

The wiremap shows some common examples of incorrect terminations that can show up in testing. These are used for testing to make sure pin 1 on patch panel goes to pin 1 on outlet etc.

Additional testing is possible for: Continuity, Shorts, Crossed Pairs, Reversed Pairs. Split Pairs will not be detected by a simple wiremap test. A more sophisticated test is required to detect split pairs.

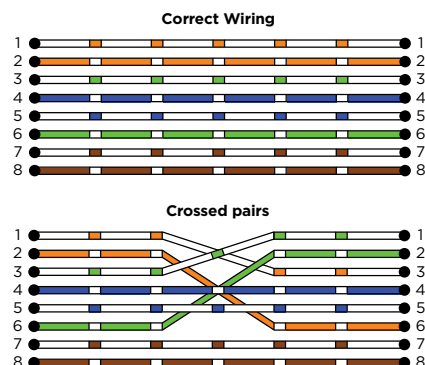

# 15 GLOSSARY OF TERMS

---

## 4 CORE SPEAKER CABLE (16/4)

A high current, 4 core loudspeaker cable designed to carry “speaker level” audio from amplifier outputs to loudspeakers. Each core is 16 American Wire Gauge (AWG) in size.

## AUDIO VIDEO HEAD END (AVHE)

A dedicated central location within the home where audio and video equipment is located alongside cable termination points connected to remote rooms.

## BROADBAND

High-speed data (typically an Internet connection) to the home via the telephone line, CATV, mobile phone network or a combination of satellite dish and telephone line.

## BT - BRITISH TELECOM (TELEPHONE PROVIDER)

The UK’s national supplier of physical phone lines into the home. Actual provider of services delivered over the phone line may be by third parties.

## CABLE TV (CATV)

Television, phone and data services delivered to the home together using an underground cable rather than aerial or satellite dish and separate from the usual telephone line. Typically uses a coax or fibre-optic cable.

## CAT5E

“Category 5 Enhanced” – a data cable consisting of 4 twisted pair conductors used for home networks but can also be deployed for telephone and other low voltage communications.

## CAT6

“Category 6” – as “Cat5e” but with additional physical spacing internally and thicker wire cores to allow faster data speed and /or longer cable lengths.

## CAT6A

“Category 6 Augmented” – as “Cat6” but with additional physical spacing internally and thicker wire cores to allow faster data speed and/or longer cable lengths.

## CCTV

“Closed Circuit Television” – Security cameras and connected monitors and recorders typically used for security purposes.

## COAXIAL CABLE

A two-core cable comprising a central conductor surrounded by an insulator and “wrap around” braid which acts as shield and ground return and an overall insulating outer sheath. Used for radio frequency signals such as television, radio, satellite and CCTV or analogue audio and video. Various types and specifications are available dependant on intended use.

## CROSSTALK

The amount of a signal in one wire or circuit that is unintentionally induced into an adjacent wire or circuit carrying a different signal.

## CW1308

4 pair solid core telecoms cable. Cat5e is generally preferred for CEDIA installations.

## DAB

“Digital Audio Broadcasting” or “Digital Radio” – modern replacement for “FM” radio using digital transmission. Popular in the UK and some parts of Europe.

## DSSO

“Double Switched Socket Outlet” - a UK standard wall mounted mains power outlet for appliances.

## ETHERNET

Network data communication using wired or wireless connections. Deploys the IEEE802 standards and is used for distributing Internet access, media and other communications around a home.

## EXTRA LOW VOLTAGE

Official terminology for electrical supplies of less than 50V AC or 120V DC.

## EXTRA LOW VOLTAGE HEAD END (ELVHE)

A dedicated central location within the home where network, data and other small signal communication equipment is located alongside cable termination points connected to remote rooms.

## FIBRE-OPTIC

A type of cable which uses light, rather than electricity, to pass data from one end to the other. Often made from a glass core surrounded by a protective covering, cheaper variants use a plastic material. Used for very high-speed data.

---

## FM

“Frequency Modulation” - an electrical method of using a high frequency “carrier” frequency to move lower frequency content. Used as a generalized term to describe VHF analogue radio services in the frequency range of 88MHz to 108MHz.

## GBE

“Giga Bit Ethernet” - the fastest form of Ethernet network currently in use within homes. Offers a maximum data speed of 1Gb/s.

## HOME AUTOMATION

The electronic connection and control of electrical and mechanical devices by a wider, unified control system, e.g. curtains, blinds, lighting, audio / video systems, heating telecoms, internet etc.

## IDC

“Insulation Displacement Connector” - a high bandwidth wire connection method for low power signal cables such as Cat5e. Used in computer network and telephone connections.

## LOW VOLTAGE

Official terminology for any electrical supply higher than those defined by “Extra Low Voltage” but less than 1000V AC or 1500V DC, including mains electricity.

## MULTI-ROOM AUDIO

A centralised audio system allowing music to be played in multiple rooms, each room having access to different sources and at different volume levels if required.

## ROUTER

A hardware device, often provided by an Internet Service provider (ISP), which establishes a home computer network (with wired and wireless connectivity) and passes data between devices within the home and externally to the Internet.

## SAT

“Satellite TV” - TV reception from geostationary satellites and received at the home using a small “dish” type antenna.

## SIAMESE (“SHOTGUN”) CABLE

A combined cable construction where two independent cables are laid side-by-side and then moulded together during manufacturing. Although electrically separate, their combined form is designed to reduce time when running multiple cables around the home.

## TRUNKING

Casing to enclose cabling when running on the exterior of an internal or external wall, external types are normally constructed to offer some weather proofing capabilities. Typically made from plastic or metal.

## VOIP

“Voice over Internet Protocol” - telephone services using the Internet to carry sound and pictures rather than the normal telephone service. Examples include Skype and Apple Facetime.

## WF100, WF125, WF167, RG6

Types of coaxial cable often used in residential wiring.

## WIRELESS INTERNET

Provides access to Internet services and other internal devices in the home via a wire-free connection to a home Router using short-range radio transmission.

# 16 REFERENCES & ASSOCIATIONS

## REFERENCES

The following were used as normative references during the compilation of these guidelines:

**ANSI/TIA 570-B** - Residential Telecommunications Infrastructure Standard (2004).

**British Standard BS 7671** - The national standard in the United Kingdom for low voltage electrical installations.

**CAI** - Code of Practice, Electrical Safety Requirements for Signal Reception Systems (excluding Community Antenna Television) CAI COP 03 - March 2010.

**CAI** - Code of Practice for the Installation of Aerials/ Antennas and Receiving Equipment in the Single Dwelling Unit.

**CAI** - Code of Practice for the Installation of Terrestrial and Satellite TV Reception Systems.

**CEA/CEDIA 2030-A** - Multi-Room Audio Cabling Standard (2010).

**CEDIA** Advanced Electronic Residential Systems.

**CENELEC EN 50173** - The European cabling standard (the British version is BS EN 50173).

**IEC 61935** - Specifies reference measurement procedures for cabling parameters and the requirements for field tester accuracy to measure cabling parameters identified in ISO/IEC 11801.

**ISO/IEC 11801** - The international standard specifies general-purpose telecommunication cabling systems (structured cabling) that are suitable for a wide range of applications. It covers both balanced copper cabling and optical fibre cabling.

**TIA/EIA-568A** - This is the American standard and was the first to be published (1991).

**TIA/EIA-568B** - First published in 2001 this is an alternative termination standard to 568A.

## ASSOCIATIONS

**BSIA** - The British Security Industry Association is the trade association for the private security industry in the UK. [www.bsia.co.uk](http://www.bsia.co.uk)

**ECA** - The Electrical Contractors' Association is the trade association representing the interests of contractors who design, install, inspect, test and maintain electrical and electronic equipment and services. [www.eca.co.uk](http://www.eca.co.uk)

**CAI** - The "Confederation of Aerial Industries" Trade body for the domestic Aerial installation and manufacturing industry. [www.cai.org.uk](http://www.cai.org.uk)

**CEDIA** - Custom Electronic Design and Installation Association, is the leading global authority in the home technology industry. [www.cedia.org](http://www.cedia.org)

**HBF** - The Home Builders Federation is the voice of the home building industry in England and Wales. Their members deliver around 80% of the new homes built each year. [www.hbf.co.uk](http://www.hbf.co.uk)

**NHBC** - The National House-Building Council is the warranty and insurance provider and standards setter for UK house-building for new and newly converted homes. As a non-profit distributing company, it reinvests all income in achieving its primary purpose; improving quality in housebuilding to protect homeowners. [www.nhbc.co.uk](http://www.nhbc.co.uk)

**NICEIC** - The NICEIC is an independent voluntary body offering certification services, Building Regulations Schemes, products and support to electrical contractors and many other trades within the construction industry. [www.niceic.com](http://www.niceic.com)

**NSI** - The National Security Inspectorate is the specialist approvals and certification body that inspects companies providing home security, business security and fire safety services. [www.nsi.org.uk](http://www.nsi.org.uk)

**RDI** - The Registered Digital Institute is the digital installation sectors professional body and trade organisation for the digital sector. [www.rdi-online.co.uk](http://www.rdi-online.co.uk)



TO FIND YOUR NEAREST CEDIA INSTALLER VISIT WWW.CEDIA.ORG

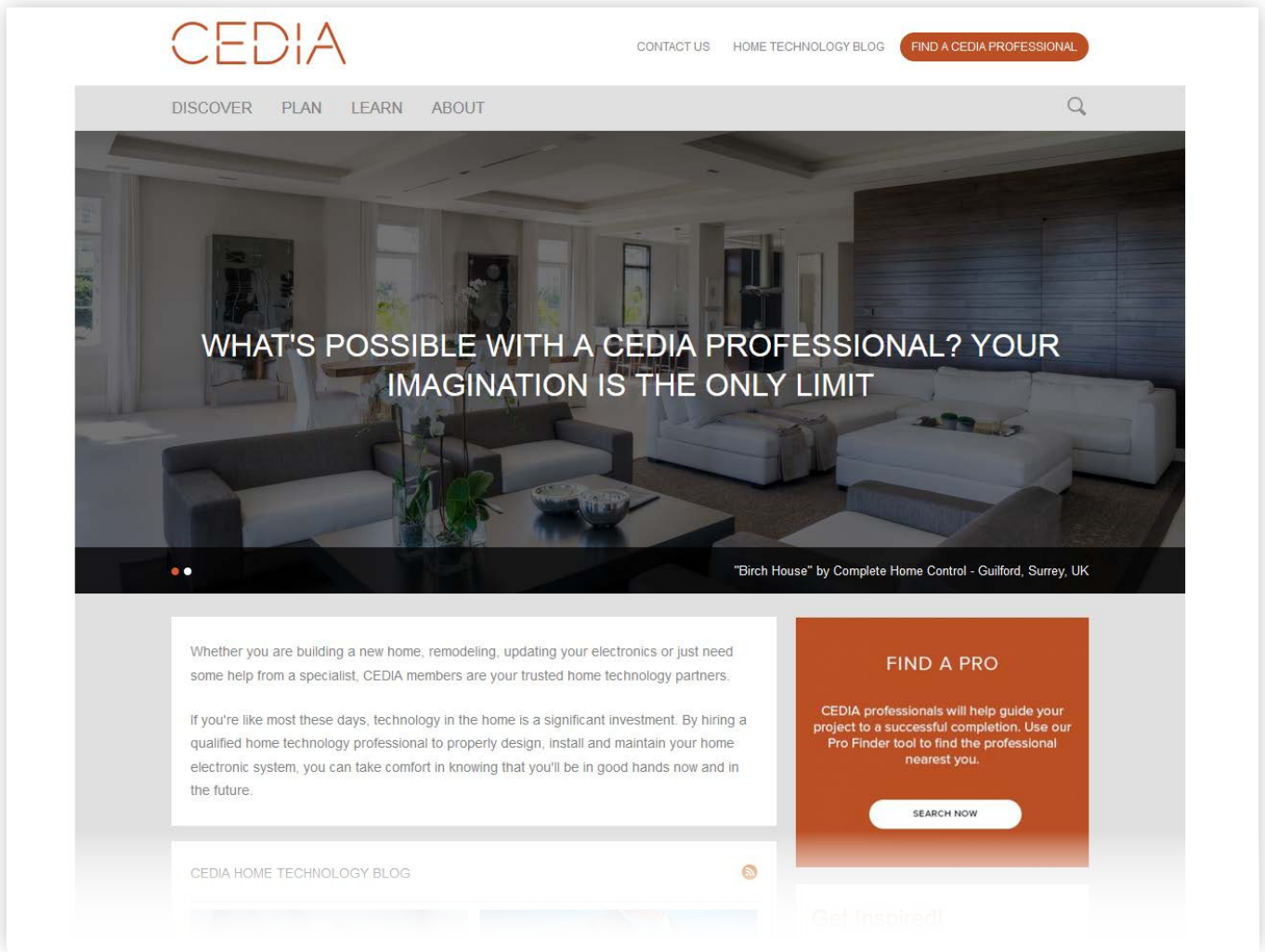

## DISCLAIMER

The information provided by this literature is for general guidance only. CEDIA accepts no liability for loss or damage howsoever arising from any installation of smart wiring technology. CEDIA recommends that all installations are planned, managed and implemented by a CEDIA approved installer and that all installations are verified with a CEDIA test certificate.

# 18 NOTES

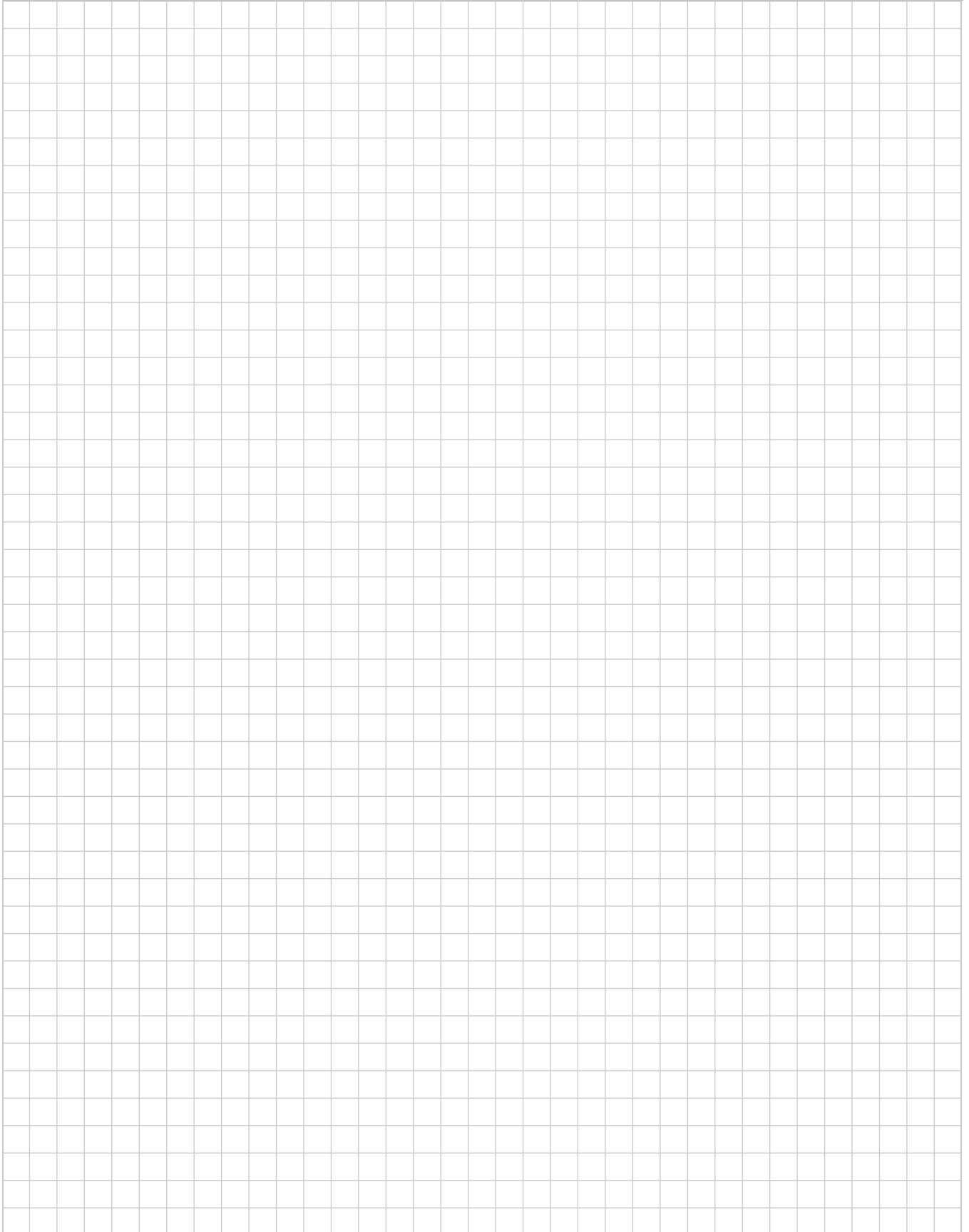

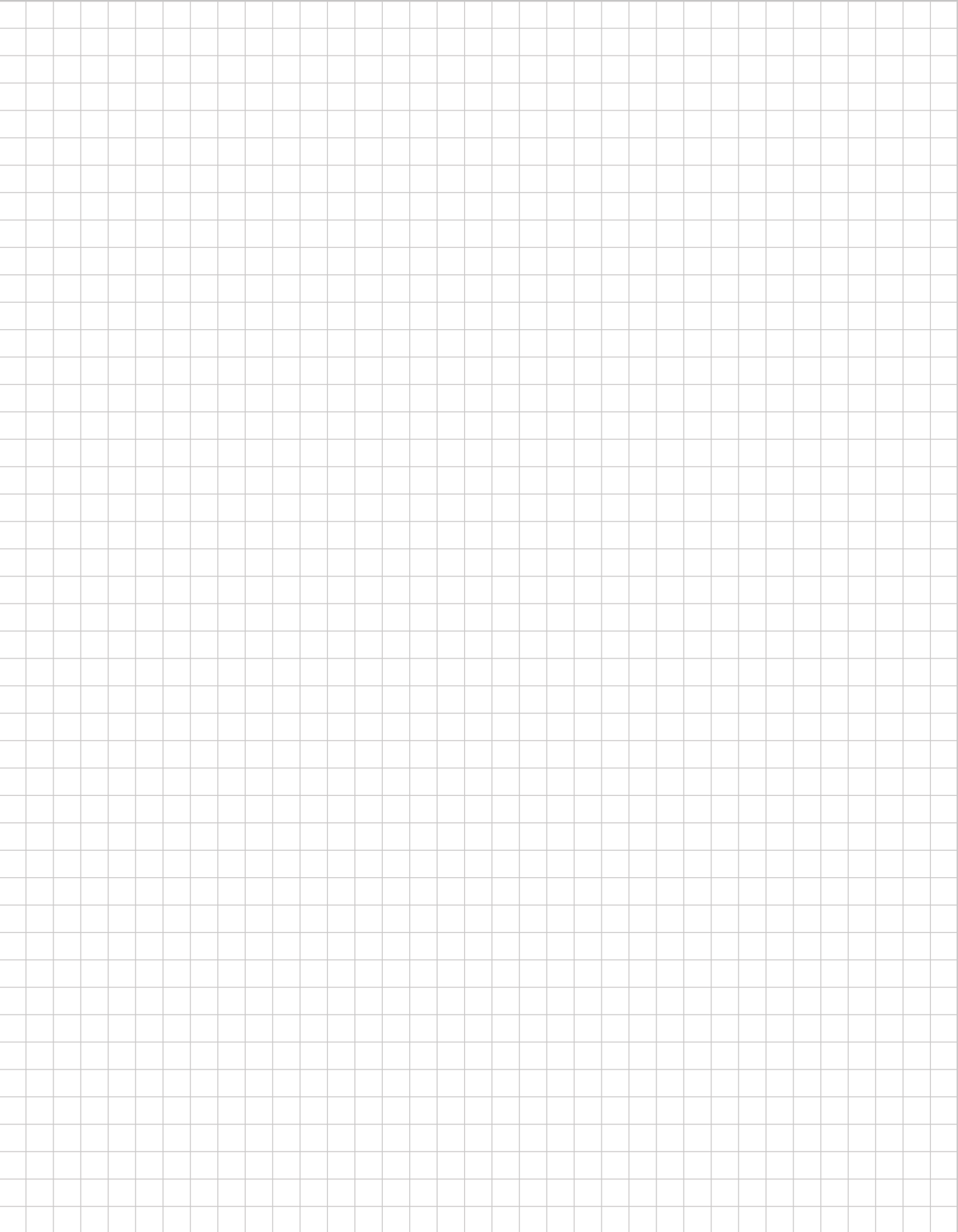



Unit 2, Phoenix Park, St Neots,  
Cambridgeshire, PE19 8EP, United Kingdom

+44 (0)1480 213 744  
[info@cedia.co.uk](mailto:info@cedia.co.uk)  
[www.cedia.co.uk](http://www.cedia.co.uk)