



**FRANCIS PLUMBING & HEATING
CLIMATECARE.**

VIESSMANN



Your Local Viessmann Experts:

Francis Plumbing & Heating ClimateCare

phone: 613-224-0041

email: office@francisplumbing.com

chat on our website: www.FrancisPlumbing.com

Application Guide

Vitodens 100-W B1HA/B1KA
Residential Boiler

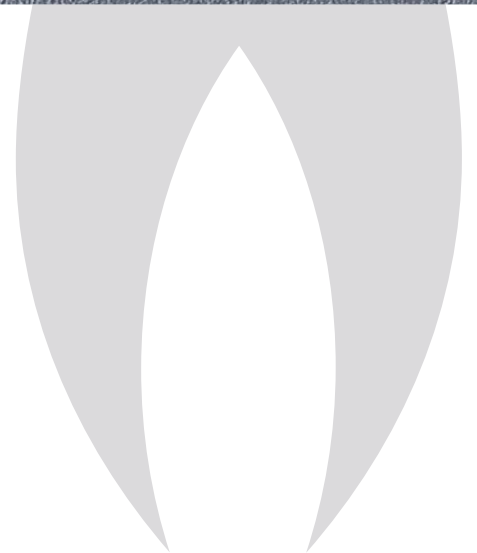

APPLICATION GUIDE

The application examples contained in this document serve as a guideline only. These are not engineered drawings and are not intended to replace project designs provided by a professional engineer. It is the responsibility of the installing contractor to ensure all aspects of the system comply with the local authorities having jurisdiction.

Your Local Viessmann Experts:



**FRANCIS PLUMBING & HEATING
CLIMATECARE.**

Francis Plumbing & Heating ClimateCare

phone: 613-224-0041

email: office@francisplumbing.com

chat on our website: www.FrancisPlumbing.com

© 2017 by Viessmann. All rights reserved.

No part of this book may be used or reproduced in any manner whatsoever without prior written permission.

For information, contact:

Viessmann Manufacturing Company Inc.
750 McMurray Road
Waterloo ON, N2V 2G5, Canada

Phone: 519-885-6300
Toll Free: 800-387-7373

www.viessmann.ca

VIESSMANN

PRE-FACE / OVERVIEW

Each day Viessmann heating systems face a wide variety of requirements and challenges here in North America, and around the world. Whether in historically protected homes, modern commercial buildings, or in large facilities, Viessmann products meet every demand and offer solutions for all your needs: wood, oil, or gas fired boilers for both residential and commercial use, from 12,000 BTU to 100,000 MBH (4 kW to 29,307 kW), domestic hot water storage tanks, solar collectors, Biogas technologies, and much more.

Viessmann also sets the standard for operational reliability, operating comfort, environmental friendliness and a long service life. All Viessmann products have one thing in common: they are based on a modular technology strategy with one common platform. This way, different product versions can be created to fulfill each customer's specific requirements. In short, Viessmann takes care of all your needs, from start to finish.

Part of that is a comprehensive support program: A knowledgeable Viessmann sales representative network, technical training academy, and technical support personnel assist you right from the planning stage through to the installation and start-up phase of a project.

With Viessmann you are witnessing intelligent, high-tech boiler technology at work. We have selected some of the most interesting Viessmann applications from across North America for your reference.





IDENTIFYING BOILER NOMENCLATURE

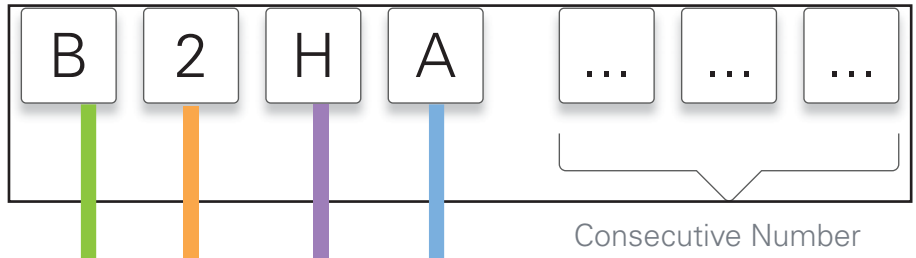

Fuel Types

Gas Oil

Efficiency

- Low Temperature A F
- Condensing B J
- CHP C

Generation of Boiler

A B C ...

	Series	P
Segment	100	1
	200	2
	300	3

	Heat Only	Circuit	Combi	Combi Comfort	Coiled Tubing Tank	Stratified Loading Tank	Solar Heating For DHW	Solar Heating
Wall-Mounted	G	H	J	K	-	L	-	-
Floor Standing	-	R	-	-	S	T	U	V

IDENTIFYING APPLICATION CODES

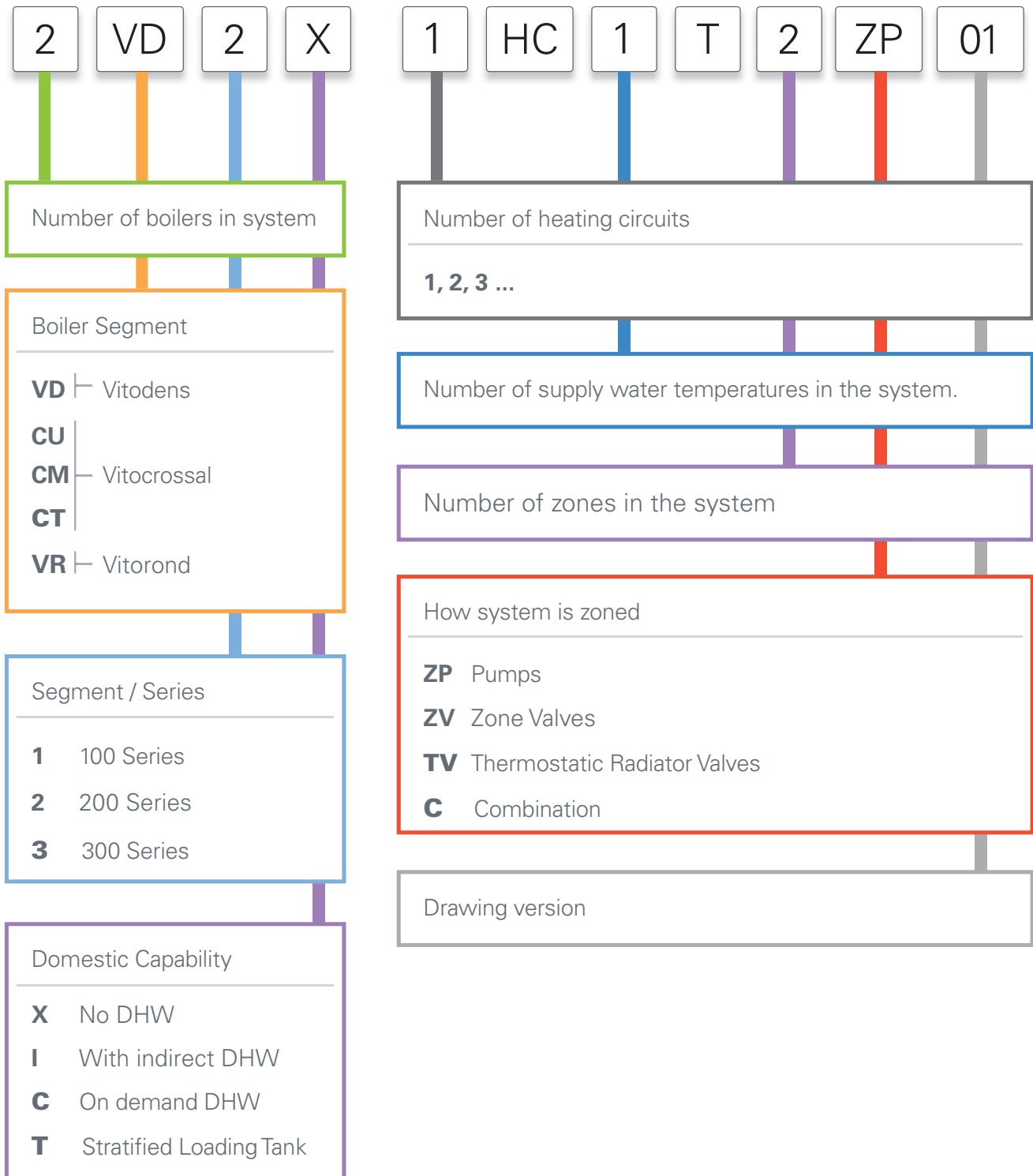

RECOMMENDED PRODUCT APPLICATIONS

Application	Typical Supply Temperature	Vitodens 100	Vitodens 200/222-F	Vitocrossal 300 CU3A	Vitorond 100
	High 160 -190 °F	◆ ¹	◆ ¹	★	★
	Medium 140 -160 °F	★	★	★	◆ ²
	Medium 120 -160 °F	★	★	★	◆ ²
	Low 80 -120 °F	★	★	★	●
	High 160 -190 °F	◆ ¹	◆ ¹	★	★
	Medium 120 -180 °F	★	★	★	★

★ **Best Choice**

◆ Possible with limitations

● Not recommended

1- Limited maximum boiler supply water temperature.

2- Ensure boiler protection to prevent against low return water temperature

Refer to Technical Data Manual of each product for applicable certifications. Technical information subject to change without notice.



COMPONENT INDEX

Hydronic Components



Vitodens 100 accessories kit with pressure relief and purge valves.



Ball valve



Circulator with isolation flanges



Low loss header



Thermostatic mixing valve

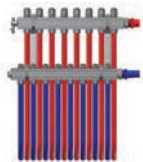

Radiant infloor manifold



Panel radiator



Flow check valve



Hot water baseboard radiator



Boiler water feed with double back check valve



Air eliminator



Expansion tank



Purge assembly:
(sediment faucet and ball valve)



Zone valve



Hydronic air handler



Towel radiator



Viessmann 3-way mixing valve with actuator motor



Plate and frame heat exchanger

Electrical Components



Aquastat



Secondary low water cut-off



Motorized mixing valve



Outdoor temperature sensor

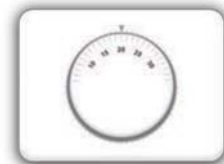

Thermostat



Temperature sensor



Viessmann vitotrol



Multi-zone control

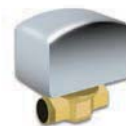

24V Zone valve



Circulator



120 Volt power



VITODENS 100

Application #	Application Code	Page
Application 1 -	VD2T 1HC1T1ZP.01	18
Application 2 -	VD2T 1HC1T4ZV.01	22
Application 3 -	VD2T 1HC1T4ZP.01	26
Application 4 -	VD2T 2HC2T2ZP.01	30
Application 5 -	VD2T 3HC3T3ZP.01	34

PRODUCT INFORMATION

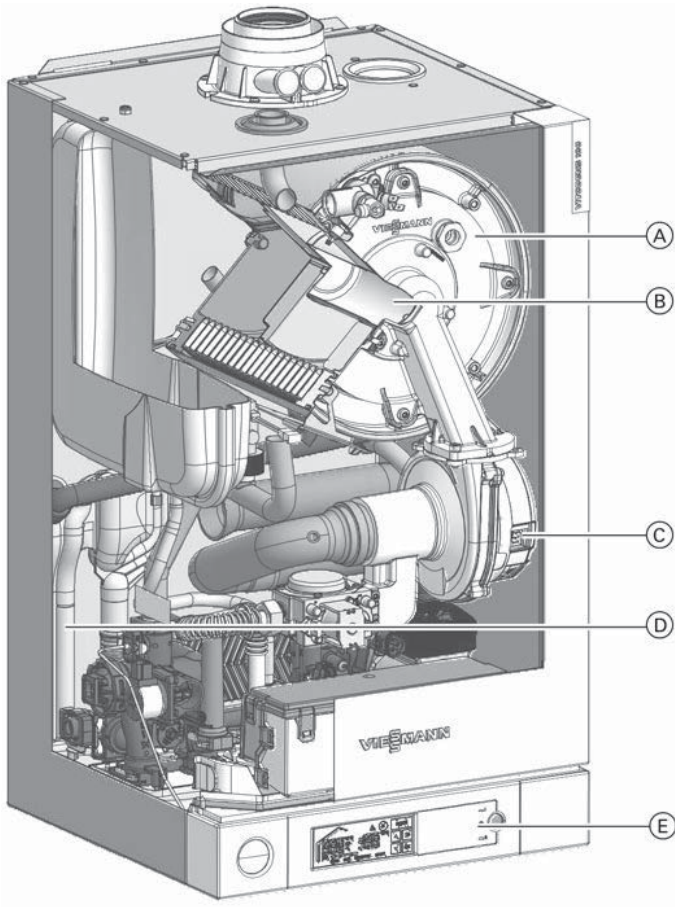

Standard Equipment:

Wall-mount boiler and installation fittings c/w 30 psi pressure relief valve, pressure gage, gas shut-off valve, two fill/drain valves, all mounting hardware, outdoor temperature sensor, and LP conversion kit.

Boiler cross-section

Legend

- (A) Inox-Radial stainless steel heat exchanger
- (B) Stainless steel Matrix cylinder burner
- (C) Burner blower
- (D) Gas and hydronic connections
- (E) Boiler control

PRODUCT INFORMATION

Standard heating boiler

		Boiler Model No.	B1HA 26, 94	B1HA 35, 125	B1HA 35, 125
CSA input Natural gas (NG)	MBH		21-94	21-125	21-125
	kW		6.2-27.5	6.2-36.6	6.2-36.6
CSA input Liquid propane Gas (LPG)	MBH		31-94	31-125	31-125
	kW		9.1-27.5	9.1-36.6	9.1-36.6
CSA output/DOE ¹ heating capacity NG	MBH		20-87	20-116	20-116
	kW		5.7-25.6	5.7-34.1	5.7-34.1
CSA output/DOE ¹ heating capacity LPG	MBH		29-87	29-116	29-116
	kW		8.4-25.6	8.4-34.1	8.4-34.1
Net AHRI rating ²	MBH		76	101	101
Heat exchanger surface area	ft. ²		12.96	12.96	12.96
	m ²		1.2	1.2	1.2
Min. gas supply pressure					
Natural gas	"w.c.		4	4	4
LPG	"w.c.		10	10	10
Max. gas supply pressure ³					
Natural gas and LPG	"w.c.		14	14	14
A.F.U.E.	%		95.0	95.0	95.0
Weight	lbs		79.4	79.4	90.0
	kg		36	36	41
Shipping weight	lbs		88.2	88.2	99.2
	kg		40	40	45
Boiler water content	USG		1.02	1.02	1.02
	L		3.88	3.88	3.88
Boiler max. flow rate ⁴	GPM		6.2	6.2	6.2
	L/h		1400	1400	1400
Max. operating pressure (max. allowable working pressure) at 210°F (99°C)					
	psig		45	45	45
	bar		3	3	3
Boiler water temperature					
- Adjustable high limit (AHL) range					
- space heating (steady state)	°F (°C)		86 to 176 (30 to 80)		
- DHW production (set-point)	°F (°C)		176 (80)		
- Fixed high limit (FHL)	°F (°C)		210 (99)		
Boiler connections					
Boiler heating supply and return	NPTM (male)		3/4"	3/4"	3/4"
Pressure relief valve	NPTF (female)		3/4"	3/4"	3/4"
DHW tank heating supply/return	NPTM (male)		3/4"	3/4"	--
DHW heating	NPTM (male)		--	--	1/2"
Drain valve	(male thread)		3/4"	3/4"	3/4"
Dimensions					
Overall depth	inches		15 ³ / ₄	15 ³ / ₄	15 ³ / ₄
	mm		400	400	400
Overall width	inches		15 ³ / ₄	15 ³ / ₄	15 ³ / ₄
	mm		400	400	400
Overall height	inches		30 ¹ / ₄	30 ¹ / ₄	30 ¹ / ₄
	mm		768	768	768

¹ Output based on 140°F (60°C), 120°F (49°C) system supply / return temperature.

² Net AHRI rating based on piping and pick-up allowance of 1.15.

³ If the gas supply pressure exceeds the maximum gas supply pressure value, a separate gas pressure regulator must be installed upstream of the heating system.

PRODUCT INFORMATION

Boiler Model No.		B1HA 26, 94	B1HA 35, 125	B1HA 35, 125
Gas supply connection		NPTM (male)		
		3/4"	3/4"	3/4"
Flue gas ⁵				
Temperature at boiler return temperature of 86°F (30°C)				
- at rated full load	°F (°C)	113 (45)	113 (45)	113 (45)
- at rated partial load	°F (°C)	95 (35)	95 (35)	95 (35)
Temperature at boiler return temperature of 140°F (60°C)				
	°F (°C)	167 (75)	172 (78)	172 (78)
Flue gas value				
Mass flow rate (of flue gas)				
- at rated full load	lbs/h	79.2	100.1	100.1
	kg/h	36.0	45.5	45.5
- at rated partial load	lbs/h	33.0	33.0	33.0
	kg/h	15.0	15.0	15.0
Available draught	Pa	100	100	100
	mbar	1.0	1.0	1.0
Flue gas temperature sensor limit		°F (°C)		
		230 (110)	230 (110)	230 (110)
Average condensate flow rate ⁶				
with natural gas				
- Ts/TR = 122 / 86°F (50 / 30°C)	USG/day	1.95-2.3	2.5-2.8	2.5-2.8
	L/day	8-9	9.4-10.5	9.4-10.5
Condensate connection ⁷		hose nozzle		
		Ø in		
		1	1	1
Boiler flue gas connection ⁸		Ø in (mm)		
		2 3/8 (60)	2 3/8 (60)	2 3/8 (60)
Combustion air supply connection ⁸		coaxial outer Ø in (mm)		
		4 (100)	4 (100)	4 (100)
		2 3/8 (60)	2 3/8 (60)	2 3/8 (60)
Noise level (at 1 meter)		(dB)		
- at full load	(dB)	47	49	49
- at partial load	(dB)	40	42	42
High altitude (factory set) ⁹		ft. (m)		
		0-5,000 (0-1,500)		

⁵ Measured flue gas temperature with a combustion air temperature of 68°F (20°C).

⁶ Based on typical boiler cycles, including partial load conditions.

⁷ Requires 1"(25) mm tubing. See Vitodens 100-W Installation Instructions for details.

⁸ For detailed information refer to the Vitodens Venting System Installation Instructions.

⁹ For 5,000 to 10,000 ft. (1,500 to 3,000 m) operation, a control programming change is required. Refer to the Installation and Service Instructions for details.

Note: For altitude operation up to 4,999 feet, derate the input capacity by 3%/1000 ft. (305 m).

For operation from 5,000 to 10,000 ft. (1,500 to 3,000 m), with the electronic altitude adjustment made, derate the input capacity by 3% for every 1000 ft. (305 m) starting at 5000 ft. (1,500 m) for a total of 15%.

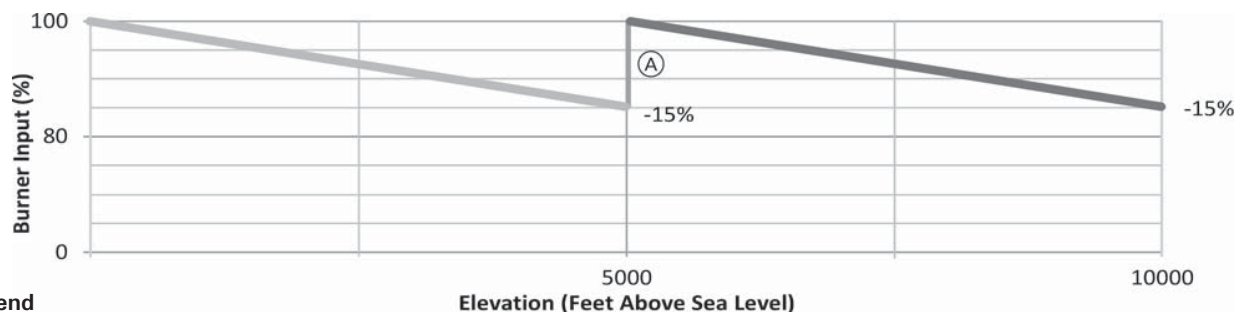

Legend

(A) Input capacity after electronic altitude adjustment is made.

PRODUCT INFORMATION

B1KA on demand hot water operation

	Boiler Model No.	B1HA 35, 125
Max. Input NG and LPG (DHW production only)	MBH	149
	kW	43.6
Max. boiler temperature (during DHW production)	°F (°C)	176 (80)
DHW supply temperature	°F (°C)	140 (60)
Continuous draw rate *1 at $\Delta t = 77^{\circ}\text{F}$ (43K)	USG/min.	3.3
	L/h	750
Max. flow through heat exchanger	USG/min.	3.7
	L/h	840
Maximum allowable working pressure (potable water)	psi	150
Test pressure	psi	300
Integrated pump flow rate DHW production @ 23 ft. (9.8 m) Head pressure	USG/min.	5.63
	L/h	1278
Heating system operation with system side additional drop in pressure of max. 6 ft. of water (1.8 m)	USG/min.	6.2
	L/h	1408

*1 DCW and DHW temperature rise would be proportional. Maximum DHW supply temperature is 140°F (60°C).

Your Local Viessmann Experts:
Francis Plumbing & Heating ClimateCare
phone: 613-224-0041
email: office@francisplumbing.com
chat on our website: www.FrancisPlumbing.com

BOILER DIMENSIONS

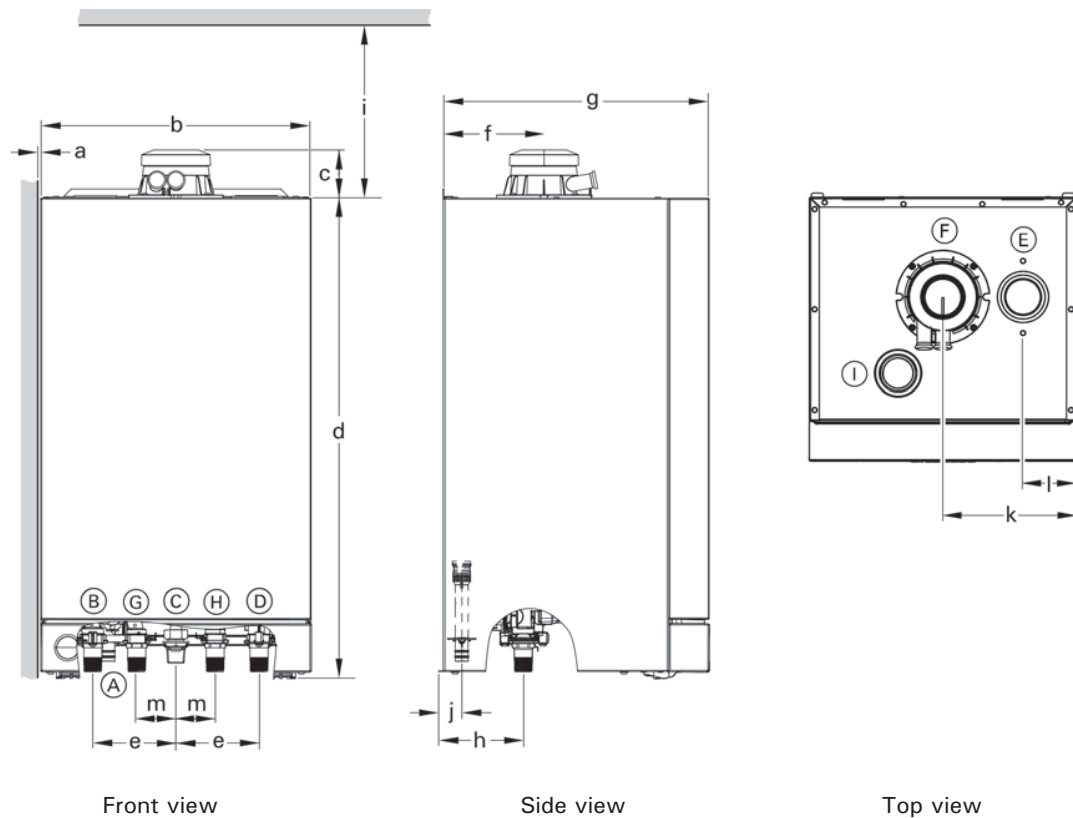

Vitodens 100-W, B1HA series and B1KA combi

Legend

- Ⓐ Condensate drain, plastic hose \varnothing 0.87" (\varnothing 22 mm)
- Ⓑ Boiler water supply, NPT $\frac{3}{4}$ " (male thread)
- Ⓒ Gas connection, NPT $\frac{3}{4}$ " (male thread)
- Ⓓ Boiler water return, NPT $\frac{3}{4}$ " (male thread)
- Ⓔ Combustion air opening for double pipe system
- Ⓕ Combustion air opening for coaxial system
- Ⓖ - For B1HA series, DHW tank heating supply
- For B1KA combi, DHW
- Ⓗ - For B1HA series, DHW tank heating return
- For B1KA combi, DCW
- Ⓛ Opening for pressure relief valve

Dimensions

- a $\frac{1}{4}$ " (6 mm) - both sides of the boiler
- b $15\frac{3}{4}$ " (400 mm)
- c $2\frac{5}{8}$ " (68 mm)
- d $27\frac{1}{2}$ " (700 mm)
- e $4\frac{7}{8}$ " (123 mm)
- f 6" (150 mm)
- g $15\frac{3}{4}$ " (400 mm)
- h 5" (125 mm)
- i $9\frac{3}{8}$ " (250 mm) minimum
- j $1\frac{1}{8}$ " (34 mm)
- k $7\frac{7}{8}$ " (200 mm)
- l $3\frac{1}{8}$ " (80 mm)
- m $2\frac{1}{4}$ " (58 mm)

BOILER DIMENSIONS

Piping connections for
Vitodens 100-W, B1HA
series and B1KA

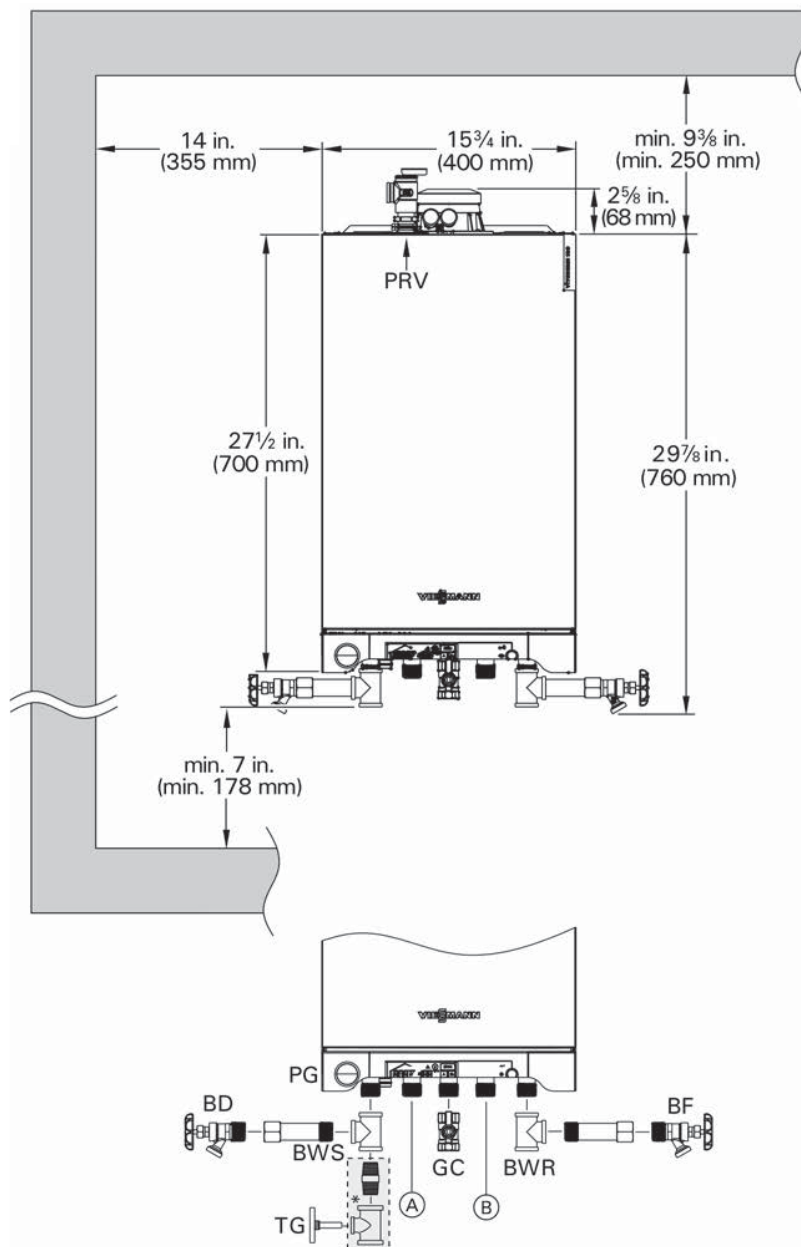

Legend

- Ⓐ - DHW tank heating supply for B1HA boilers
- DHW for B1KA boiler
- Ⓑ - DHW tank heating return for B1HA boilers
- DCW for B1KA boiler
- BWR Boiler water return
- BWS Boiler water supply
- BD Boiler drain
- BF Boiler fill
- GC Gas connection
- PRV Pressure relief valve
- PG Pressure gauge
- VC Venting connection
- TG Temperature gauge
- * Field supplied

HEATING CIRCUIT PUMPS

Waterside Flow (boiler circuit)

The Vitodens 100-W is designed only for closed loop, forced circulation hot water heating systems.

Pressure drop (primary circuit) of Vitodens 100-W

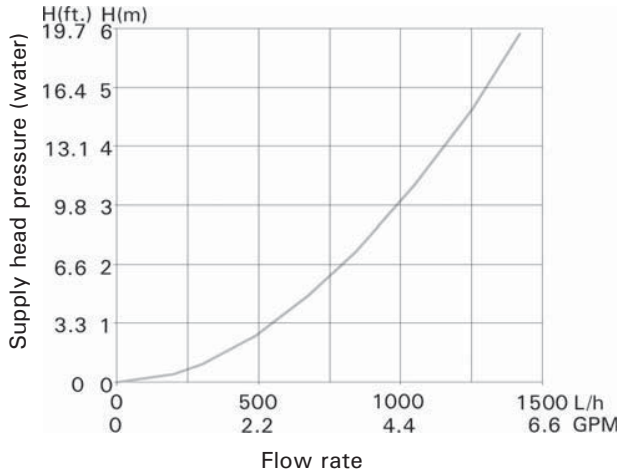

A low-loss header must be used when the system flow rate exceeds the maximum (or minimum) flow rate of the Vitodens 100-W boiler. An alternative method may be used, such as primary secondary piping using closely spaced tees.

A low-loss header offers additional benefits not provided by a pair of closely spaced tees. Viessmann strongly recommends and prefers the use of a low-loss header over closely spaced tees.

Heating circuit pumps

The Vitodens 100-W B1HA/B1KA comes with a built-in boiler pump.

All other pumps are field supplied and should be sized based on pressure drop.

IMPORTANT

Pump selection must be based on accurate system flow and pressure drop calculations (including DHW sizing).

Use standard friction loss method for pipe sizing. Observe boiler maximum and minimum flow rate limitations. If system flow rate exceeds boiler maximum flow rate or if system flow rate is unknown, Viessmann strongly recommends the installation of a low-loss header.

Domestic Hot Water Production via Instantaneous DHW Plate Heat Exchanger (B1KA)

The B1KA is equipped with an electronically controlled instantaneous DHW plate heat exchanger. The comfort control function (if selected) ensures that the instantaneous DHW plate heat exchanger is kept warm. This translates into immediate availability of domestic hot water at any required temperature level.

Technical Data DHW Plate Heat Exchanger

B1KA heat exchanger performance

DHW supply temperature for B1KA 35 (with mixed water)

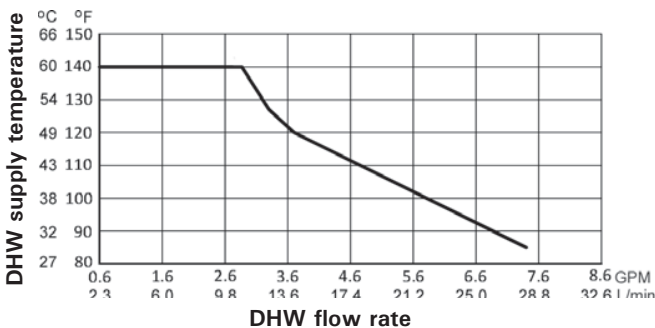

This chart illustrates the changes in the outlet temperature, subject to the flow rate at the tap.

If greater volume (max. flow rate through heat exchanger = 3.7 GPM) of water is required, cold water needs to be mixed which reduces the outlet temperature.

Curve is only applicable for a DCW inlet temperature of 50°F and a boiler input of 149,000 MBH (Vitodens 100-W, B1KA 35).

Max. recovery rate @ DHW temperature of 140°F = 3.3 GPM
 Min. flow through the heat exchanger for boiler start = 0.4 GPM

HEATING CIRCUIT PUMPS

Built-in pump

Grundfos UPS15-78 three speed heating circuit/DHW production pump for Vitodens 100-W B1HA 26/35 and B1KA 35 boilers (in the factory setting, the pump speed is preset to 'speed three')

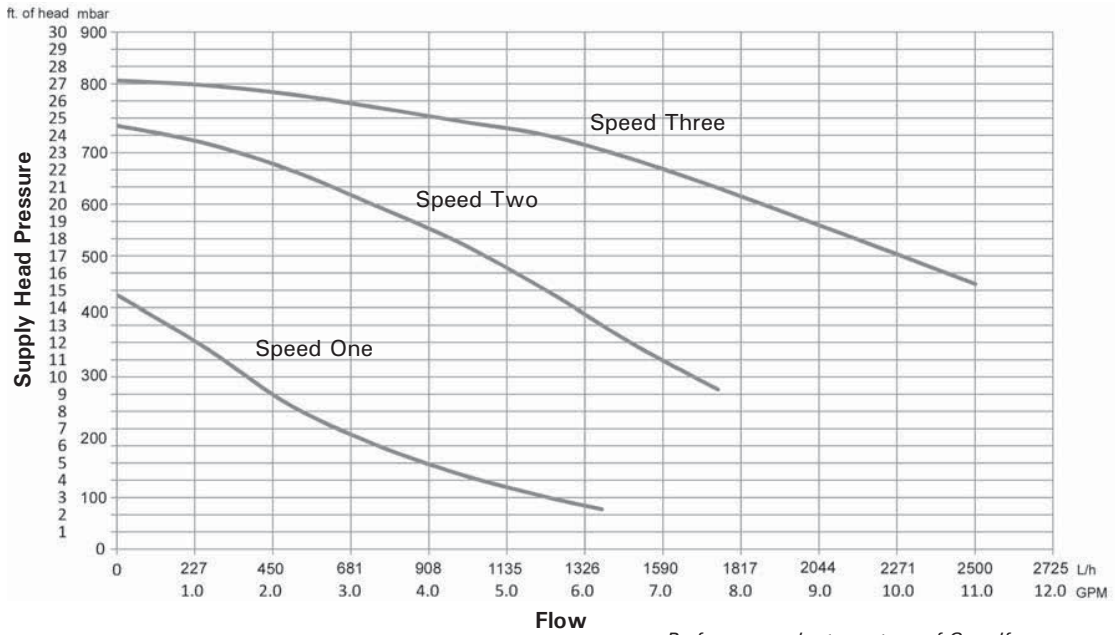

Performance chart courtesy of Grundfos

Pump Model	Grundfos UPS15-78	
Rated voltage	VAC	115
Rated current	A max.	1.15
	A min.	0.8
Capacitor	μF	8
Power consumption	W max.	130
	W min.	80

Built-in pump, Grundfos UPS15-78 residual head pressure

Residual head of built-in pump at speed 3 (factory set).

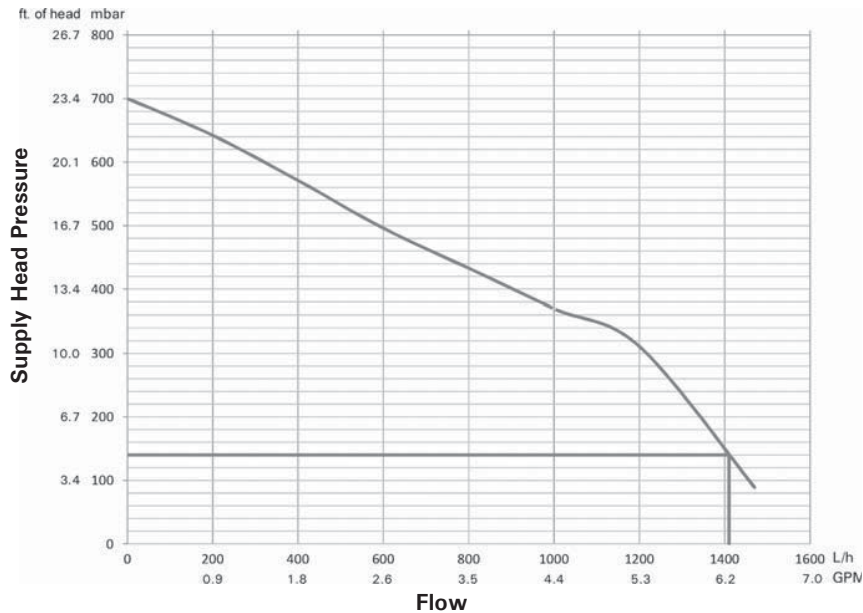

SYSTEM DESIGN CONSIDERATIONS

IN THE COMMONWEALTH OF MASSACHUSETTS...

- this product shall be installed by a licensed plumber or gas fitter.
- the flexible connector (if used) may not exceed 36".
- any level type shutoff used must be of tee handle type.

Boiler location

As a direct vent appliance, the Vitodens 100-W may be installed for room air independent operation (sealed combustion direct vent) regardless of size and ventilation method of the room in which it is located.

The Vitodens 100-W may be installed, for example, in the main living area of a house, in non-ventilated utility rooms, cupboards, closets and alcoves with no clearance required from combustible materials, as well as in attics with a direct outlet for the flue gas/fresh air system. Follow all local and national codes.

Flue gas system

Viessmann coaxial PPS (Polypropylene - flame retardant) concentric flue gas/fresh air systems and two-pipe stainless steel/CPVC systems for room air independent operation (sealed combustion) and side wall venting are tested to ANSI Z21.13 - CSA 4.9 standards (latest edition) and are certified together with the Vitodens 100-W boiler as a constructional unit. The Vitodens 100-W boiler may also be vented vertically or horizontally, using a metallic AL29-4C® special stainless steel, or non-metallic CPVC single-wall, room air dependent venting system (UL/ULC listed for category IV).

For a more detailed description of the direct vent and single-wall vent system, please refer to the Vitodens Venting System Installation Instructions.

Flue gas temperature protection

Viessmann coaxial PPS (Polypropylene - flame retardant) flue pipes used for the Vitodens 100-W are rated for max. flue gas temperatures of up to 230°F (110°C).

Flue gas temperature protection is also included although the maximum permissible flue gas temperature will not be exceeded in any operating condition or in the event of malfunctioning.

Low water cut-off

A low water cut-off may be required by local codes. If the boiler is installed above the radiation level, a low water cut-off device of approved type must be installed in all instances. An approved low water cut-off device that meets government and local regulations must be provided by the heating contractor.

Do not install an isolation valve between the boiler and the low water cut-off. The Vitodens 100-W boiler has a built-in flow switch, which may be accepted by local codes in lieu of a low water cut-off.

System layout

- The max. boiler water temperature for ...
 - space heating is 176°F (80°C).
 - DHW production is 176°F (80°C).

To minimize distribution losses, Viessmann recommends that the heating and domestic hot water systems be based on a maximum boiler supply temperature of 158°F (70°C).

- Due to the low return temperatures required for gas condensing, avoid the use of mixing valves in the heating circuit whenever possible.

If mixing valves are required, e.g. for multi-circuit systems or underfloor heating systems, only 3-way mixing valves may be used.

Do not use 4-way mixing valves in a system with condensing boilers.

Water connections

Vitodens 100-W boilers can be used in any fully pumped hot water heating system.

Minimum system pressure is 12 psig (0.8 bar).

Chemical corrosion protection products

Corrosion does not typically occur in sealed heating systems which have been correctly installed and are correctly operated.

Many manufacturers of plastic pipes recommend the use of chemical additives. In this case, only commercially available corrosion protection products that have been approved for boilers with domestic hot water heating via single-wall heat exchangers (instantaneous plate heat exchangers or DHW tanks) may be used.

Underfloor heating systems

For underfloor heating systems Viessmann recommends the use of plastic tubing with an oxygen diffusion barrier in order to prevent the diffusion of oxygen through tubing.

If plastic tubing without an oxygen diffusion barrier is used in underfloor heating systems, Viessmann recommends that such systems be separated from the boiler with a heat exchanger.

Water Conditions for DHW B1KA 35

Media: pH value 6.5 to 12, glycol max. 30%

DHW (max. hardness): Chloride up to 250 mg/L

Hardness up to 358 ppm
(= max. 0.278 kg/m³ lime deposit)

SYSTEM DESIGN CONSIDERATIONS

Oxygen diffusion barrier underfloor tubing

The boiler warranty does not cover leaks resulting from corrosion caused by the use of underfloor plastic tubing without an oxygen diffusion barrier. Such systems must have the non-oxygen diffusion barrier tubing separated from the boiler with a heat exchanger.

Viessmann recommends the use of underfloor plastic tubing with an oxygen diffusion barrier.

Water quality

Treatment for boiler feed water should be considered in areas of known problems, such as where a high mineral content and hardness exist. In areas where freezing might occur, an antifreeze may be added to the system water to protect the system. Please adhere to the specifications given by the antifreeze manufacturer.

Do not use automotive silicate based antifreeze. Please observe that an antifreeze/water mixture may require a backflow preventer within the automatic water feed and influence components such as diaphragm expansion tanks, radiation, etc. Maximum antifreeze content is 50% for the B1HA 26, 35 and 30% for the B1KA 35. Do not use antifreeze other than specifically made for hot water heating systems.

The system may also contain components which might be negatively affected by antifreeze.

Check total system frequently when filled with antifreeze. Advise system operator/ultimate owner that system is filled with a glycol mix.

The heating contractor must provide a MSDS (Material Safety Data Sheet) for the antifreeze used to the system operator/ultimate owner.

Total output (MBH)	Total Hardness (ppm as CaCO ₃)
> 1 Total ≤ 680	≤ 200
> 680 to ≤ 2050	≤ 150
> 2050	≤ 2

The pH value of the heating water should be between 8.2 and 9.5

Warranty

Our warranty does not cover damages resulting from the following:

- installation or service by unqualified and unlicensed personnel.
- attempting to perform any repair work on the boiler other than that mentioned in the boiler literature.
- tampering with or attempting to readjust the factory settings of the combination gas valve
- leaks resulting from corrosion caused by the use of underfloor plastic tubing without an oxygen diffusion barrier.

For detailed warranty information, please read warranty sheet supplied with product.

Your Local Viessmann Experts:
Francis Plumbing & Heating ClimateCare
phone: 613-224-0041
email: office@francisplumbing.com
chat on our website: www.FrancisPlumbing.com

Low Loss Header

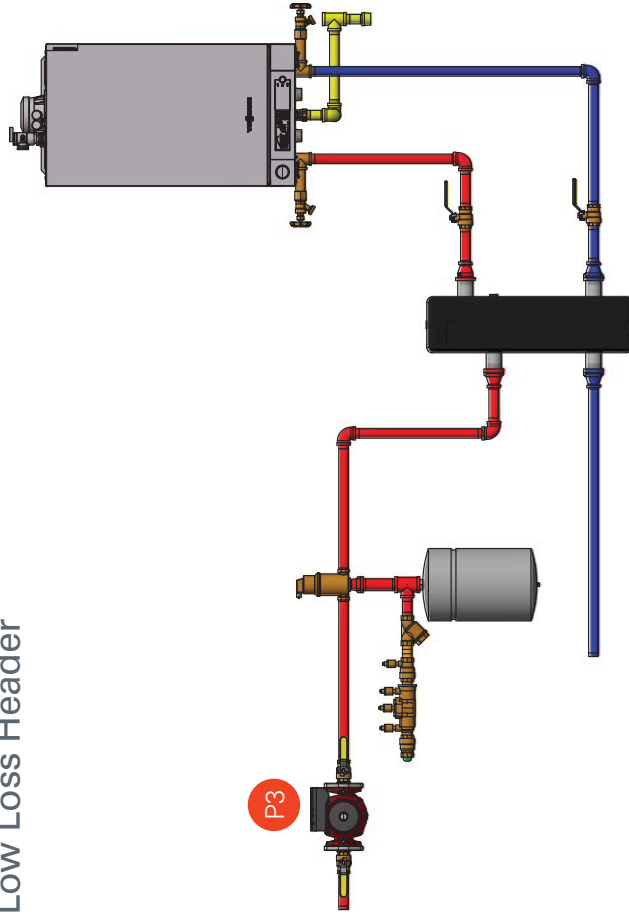

Closely Spaced Tees

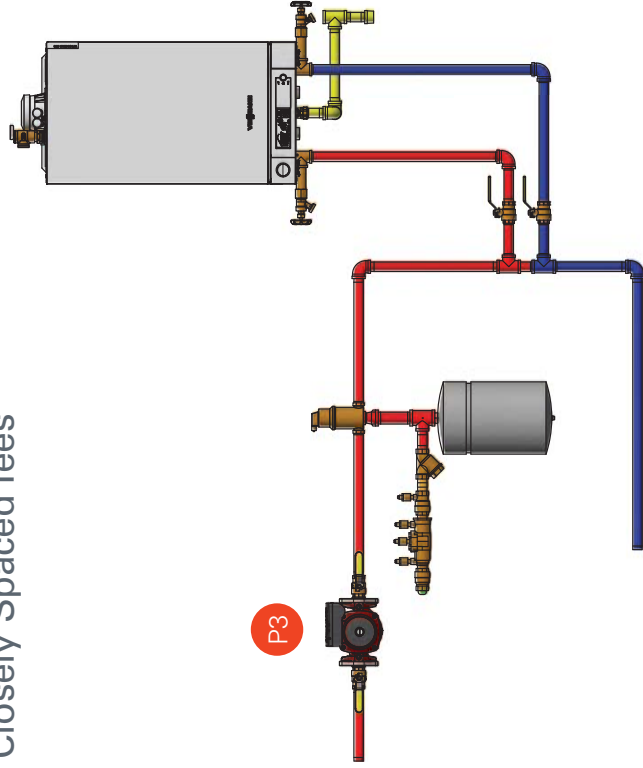

Notes/Comments

1. Hydraulically separating the flow of the boiler and system with closely spaced tees or a low loss header, ensures that the boiler and system flows do not affect each other.
2. Refer to component index on Page 5.
3. Since the primary circulator is integrated into boiler, field installation of a boiler circulator is not required.
4. If not using the DHW ports on the boiler, installer is required to cap before filling boiler.



Pressure Drop B1HA

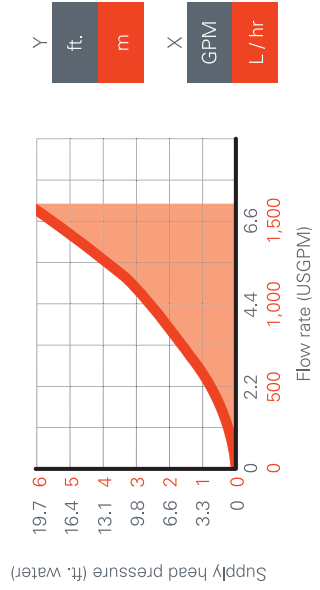

Application Code

VD1X 1HC1T1ZP:01

Pre-Wired

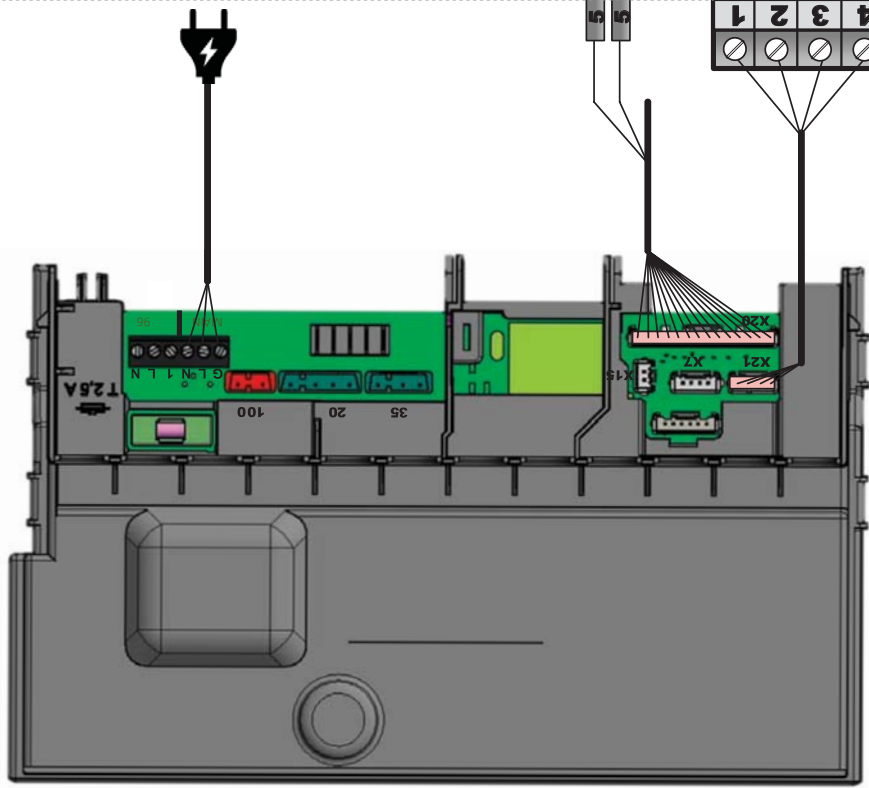

Field Wiring

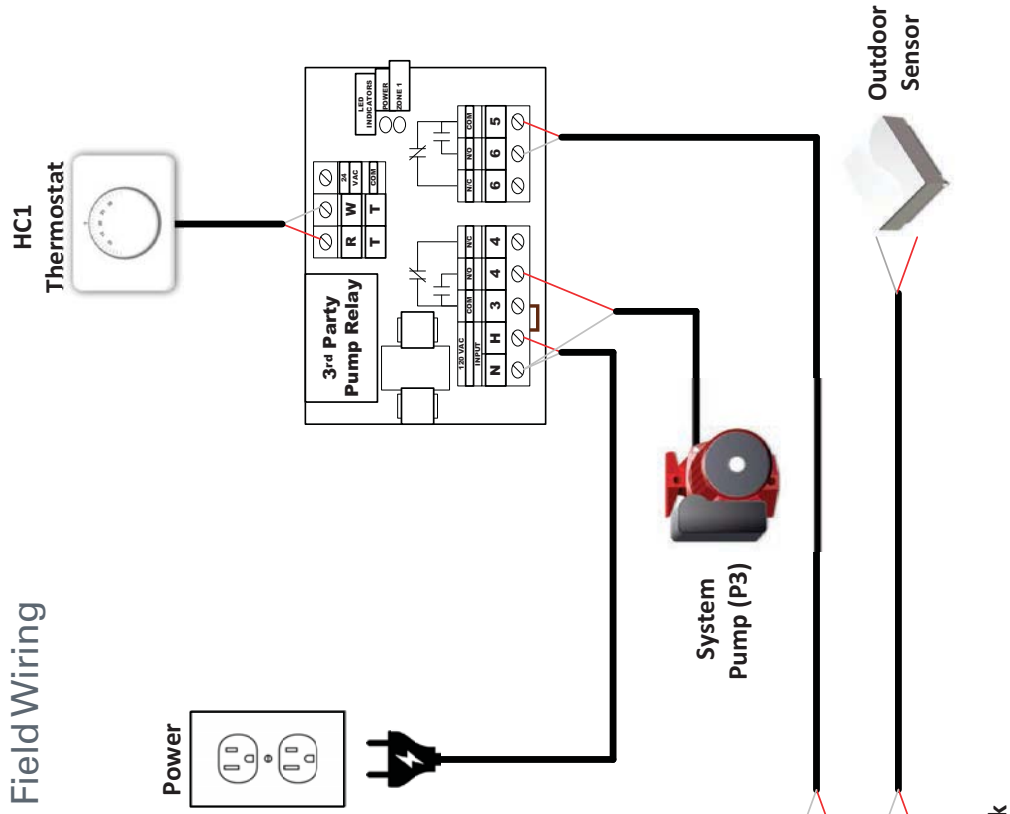

Notes/Comments



1. Items to the left of the dotted vertical line are factory wired connections. Items wired to the right of the line are field wired.
2. If outdoor weather compensation is not being used, installation of the outdoor temperature sensor is not necessary.



Application Code

VD1X 1HC1T1ZP:01





B1HA Boiler Setup

This particular application represents a low mass boiler with a single system loop. Because the system flow requirements may vary, or fall outside of the parameters of the boiler flow, it is recommended to hydraulically separate the system flow from the boiler flow. This can be achieved by using a low loss header or closely spaced tees on the system loop. Upon a call for heat from an external demand such as a thermostat the boiler circulator and the system circulator will be initiated. To program the boiler for this type of application, please complete the following procedure:

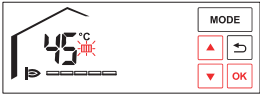
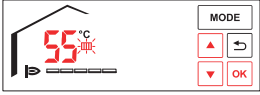

Application Code

VD1X 1HC1T1ZP.01

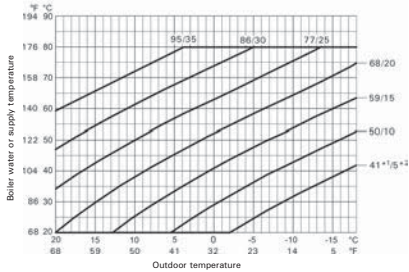
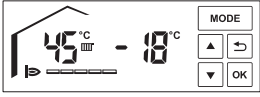
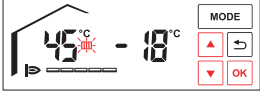
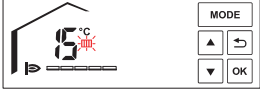
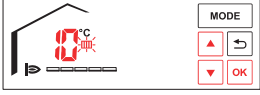
Function	Step #	Description	
Adjust the Boiler Setpoint Temperature: <i>(No Outdoor Sensor Connected)</i>	1 2 3 4	Tap the \uparrow/\downarrow button until the  begins flashing. Press OK . Press the \uparrow/\downarrow until the required boiler water temperature is displayed. Press OK to confirm.	  
Set and Outdoor Reset Curve: <i>(With Outdoor Sensor Connected)</i>	OR 1 2 3 4	Tap the \uparrow/\downarrow button until the  begins flashing. Press OK . Using the chart below, select the number of the desired reset curve for your application. <i>(value shown on the boiler display will depend on whether the boiler is set to °F or °C)</i>  Press the \uparrow/\downarrow until the required curve is selected and press OK .	   

*For more information on how to reconfigure the boiler, please reference page 40.



Notes/Comments

Your Local Viessmann Experts:



**FRANCIS PLUMBING & HEATING
CLIMATECARE.**

Francis Plumbing & Heating ClimateCare

phone: 613-224-0041

email: office@francisplumbing.com

chat on our website: www.FrancisPlumbing.com

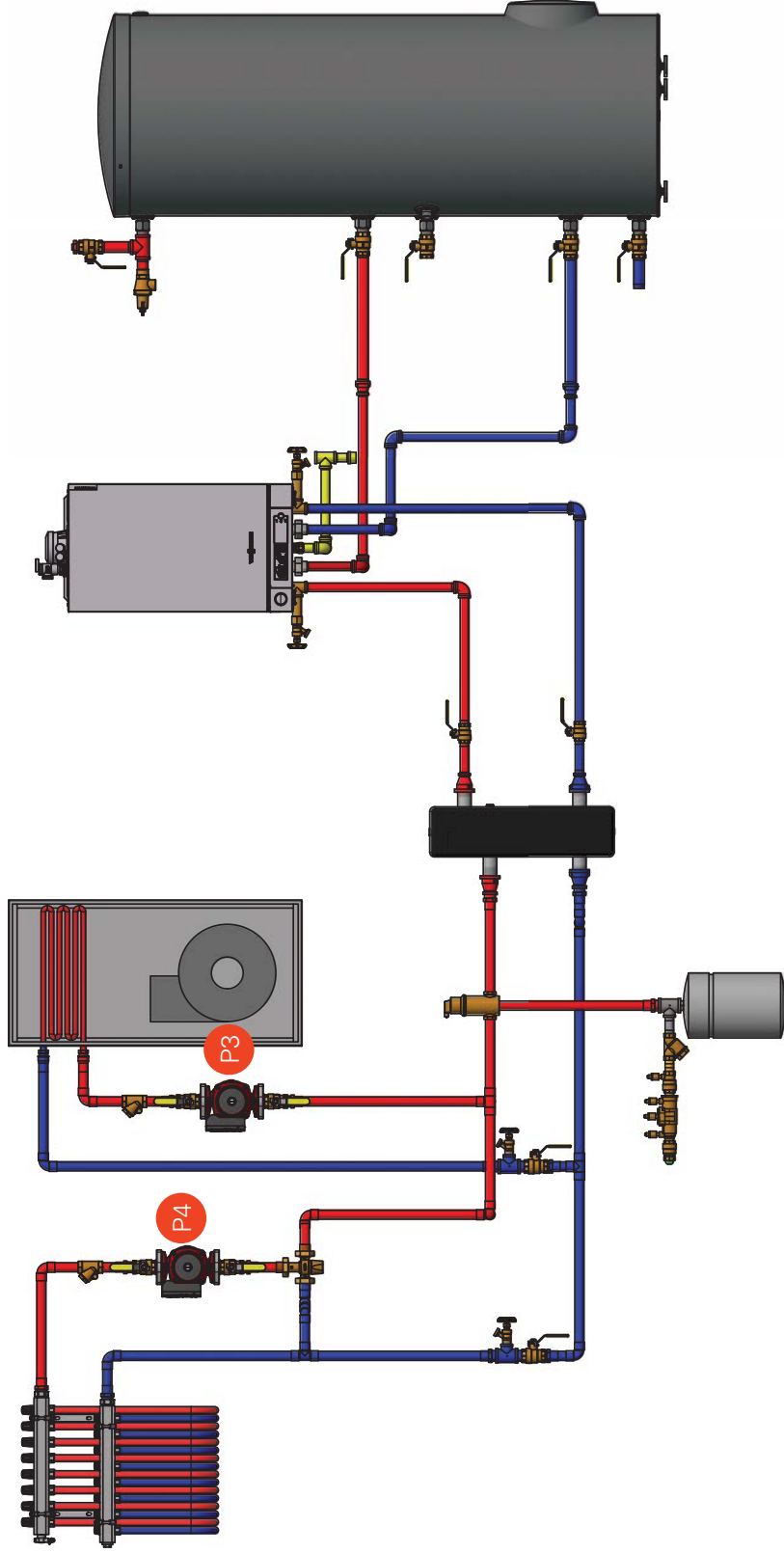

Notes/Comments

1. A thermostatic mixing valve should be installed to protect the radiant floor heating from receiving excessive hot water.
2. Component Index on pages 5.
3. Since the boiler circulator is integrated, field installation of a circulator is not required for the boiler or indirect DHW.
4. When using a Viessmann AirflowPLUS, the P3 circulator is integrated and controlled by the air handler.



Pressure Drop B1HA

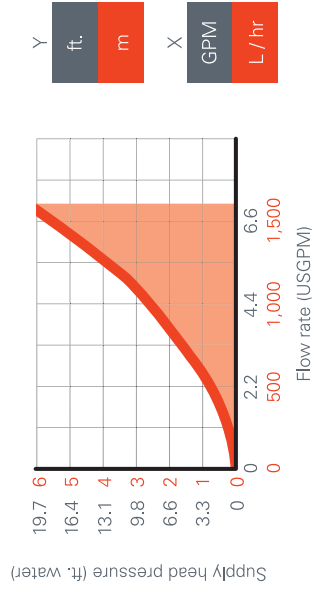

Application Code

VD11 2HC2T2ZP01

Pre-Wired

Field Wiring

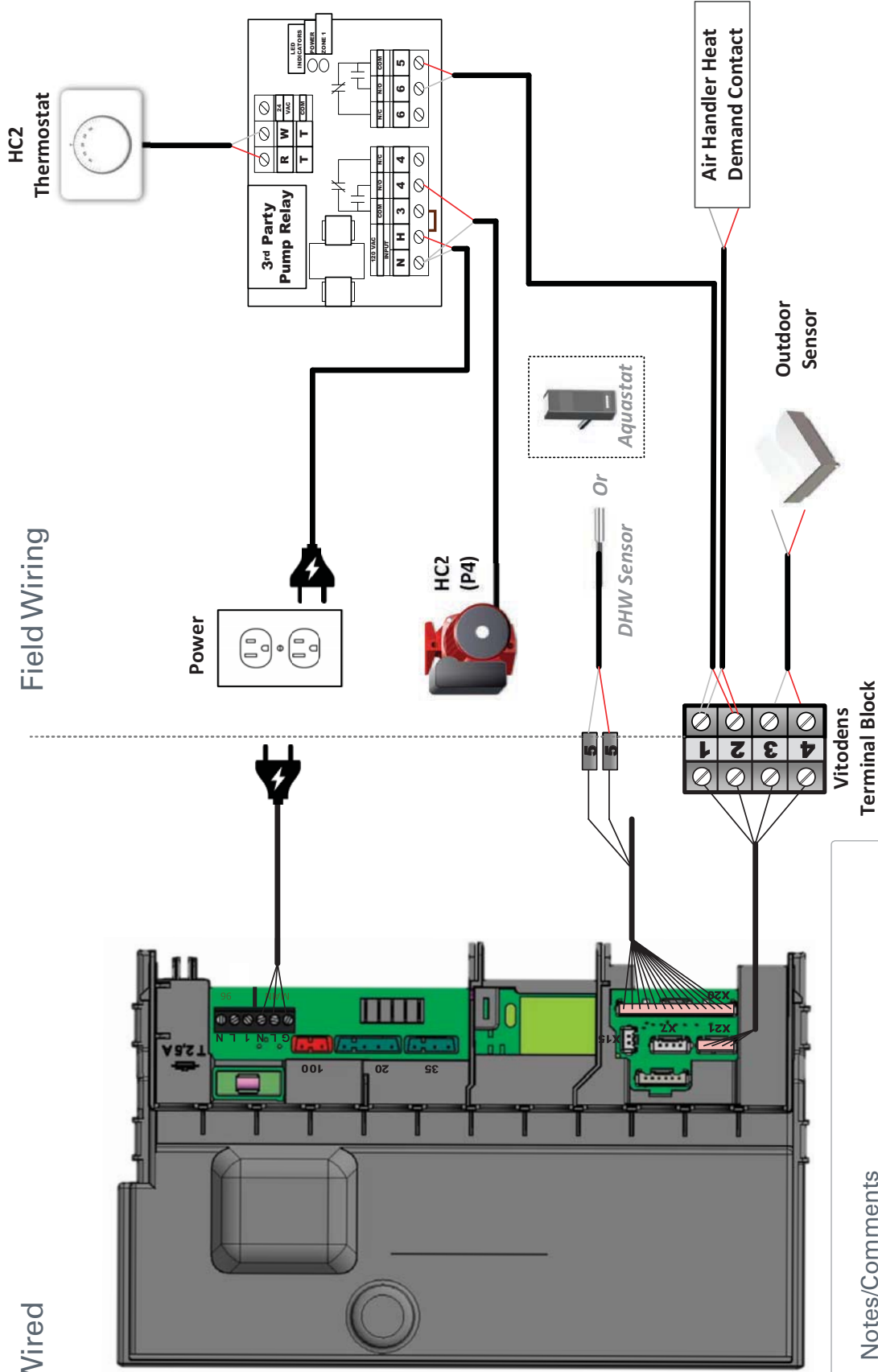

Notes/Comments

1. If an aquastat is being used instead of a DHW sensor, reconfiguration of the control will be necessary. Refer to page 40
2. If outdoor weather compensation is not being used, installation of the outdoor temperature sensor is not necessary.



Application Code

VD11 2HC2T2ZP:01

B1HA Boiler Setup

In this application, you can see a Vitodens 100 paired with an indirect water heater and 2 zones. A safety device such as a thermostatic mixing valve should be added to the infloor circuit to protect the radiant heating from the higher supply water temperatures required for the air handler. This application will prioritize the DHW by diverting flow from the system to the indirect DHW using the diverting valve integrated into the boiler. To set up the boiler for this application you will need to complete the following:



Application Code

VD1X 1HC1T1ZP01

Function	Step #	Description	
Adjust the Boiler Setpoint Temperature: <i>(No Outdoor Sensor Connected)</i>	1	Tap the button until the begins flashing.	
	2	Press OK .	
	3	Press the until the required boiler water temperature is displayed.	
	4	Press OK to confirm.	
OR			
Set and Outdoor Reset Curve: <i>(With Outdoor Sensor Connected)</i>	1	Tap the button until the begins flashing.	
	2	Press OK .	
	3	Using the chart below, select the number of the desired reset curve for your application. <i>(value shown on the boiler display will depend on whether the boiler is set to °F or °C)</i>	
	4	Press the until the required curve is selected and press OK .	
Set DHW Temperature: <i>(Not available if using an aquastat)</i>	1	Tap the button until the begins flashing.	
	2	Press OK .	
	3	Press the until the required DHW temperature is displayed.	
	4	Press OK to confirm.	

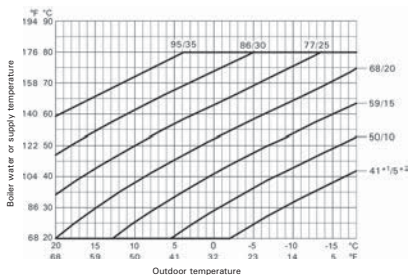

*For more information on how to reconfigure the boiler, please reference page 40.



Notes/Comments

Your Local Viessmann Experts:



**FRANCIS PLUMBING & HEATING
CLIMATECARE.**

Francis Plumbing & Heating ClimateCare

phone: 613-224-0041

email: office@francisplumbing.com

chat on our website: www.FrancisPlumbing.com

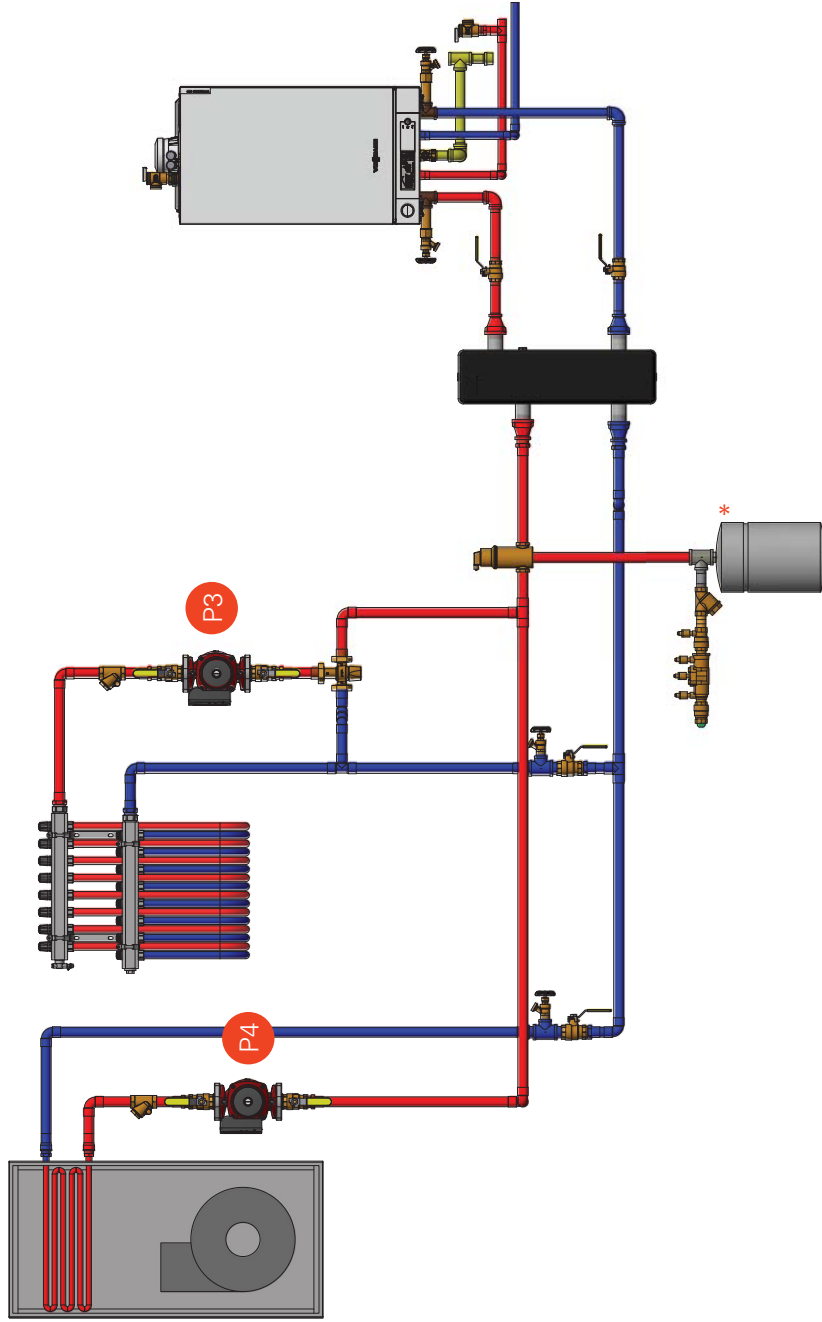

Notes/Comments

1. A thermostatic mixing valve should be installed to protect the radiant floor heating from receiving excessive hot water.
2. Component Index on pages 5.
3. Since the boiler circulator is integrated, field installation of a circulator is not required for the boiler or indirect DHW.
4. The B1KA has an integrated expansion vessel built into the boiler that will be sufficient for most systems. If your system requires a larger expansion tank, a secondary tank can be installed on the system. (*)



Pressure Drop B1HA

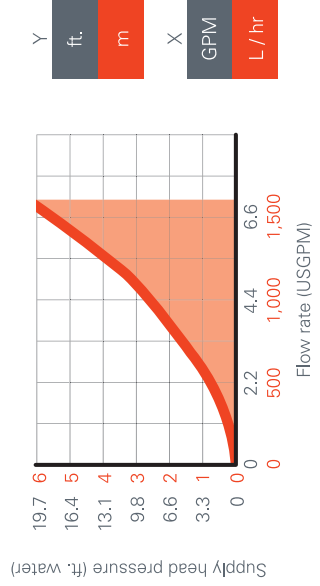

Y	ft.	m	X	GPM	L / hr
---	-----	---	---	-----	--------



Application Code

VD1C 2HC2T2ZP:01

Pre-Wired

Field Wiring

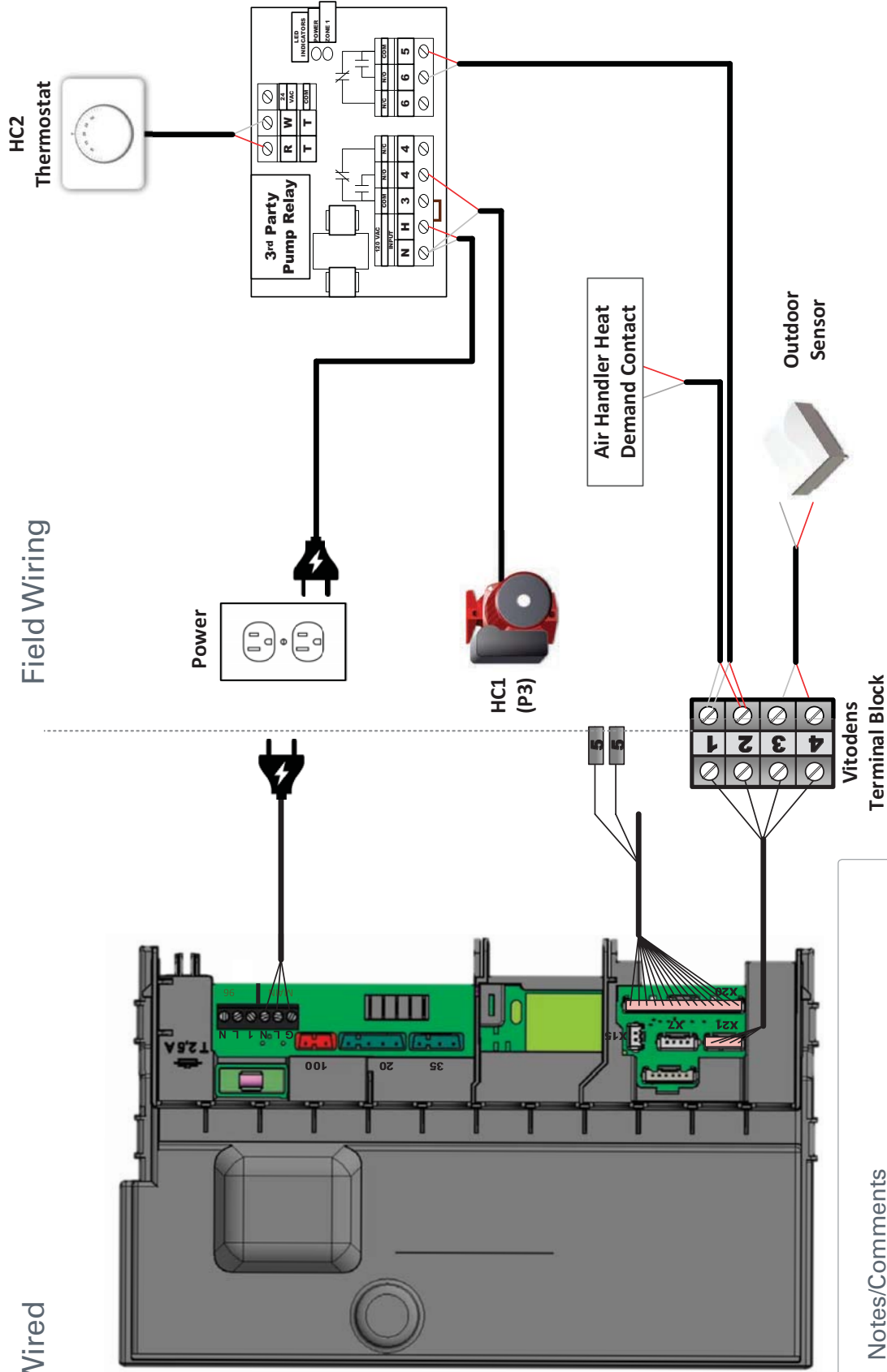

Notes/Comments

1. When using a Viessmann Airflow Plus, the P4 pump is integrated and controlled by the air handler.
2. If outdoor weather compensation is not being used, installation of the outdoor temperature sensor is not necessary.

 **Application Code**
 VD1C 2HC2T2ZP:01

B1HA Boiler Setup

Similar to the previous application, this system incorporates a Vitodens 100 Combi boiler. With on demand domestic hot water, this offers an alternative solution to installing a storage type indirect water heater. The integrated circulator and diverting valve allow the boiler to switch from heating and provide up to 3.7GPM of on-demand DHW. To set up the boiler for this application, you will need to complete the following steps:



Application Code

VD1C 2HC2T2ZP.01

Function	Step #	Description	
Adjust the Boiler Setpoint Temperature: <i>(No Outdoor Sensor Connected)</i>	1 2 3 4 OR	Tap the button until the begins flashing. Press OK . Press the until the required boiler water temperature is displayed. Press OK to confirm.	
Set and Outdoor Reset Curve: <i>(With Outdoor Sensor Connected)</i>	1 2 3 4	Tap the button until the begins flashing. Press OK . Using the chart below, select the number of the desired reset curve for your application. <i>(value shown on the boiler display will depend on whether the boiler is set to °F or °C)</i> Press the until the required curve is selected and press OK .	
Set DHW Temperature: <i>(Not available if using an aquastat)</i>	1 2 3 4	Tap the button until the begins flashing. Press OK . Press the until the required DHW temperature is displayed. Press OK to confirm.	

*For more information on how to reconfigure the boiler, please reference page 40.



Notes/Comments

Your Local Viessmann Experts:



**FRANCIS PLUMBING & HEATING
CLIMATECARE.**

Francis Plumbing & Heating ClimateCare

phone: 613-224-0041

email: office@francisplumbing.com

chat on our website: www.FrancisPlumbing.com

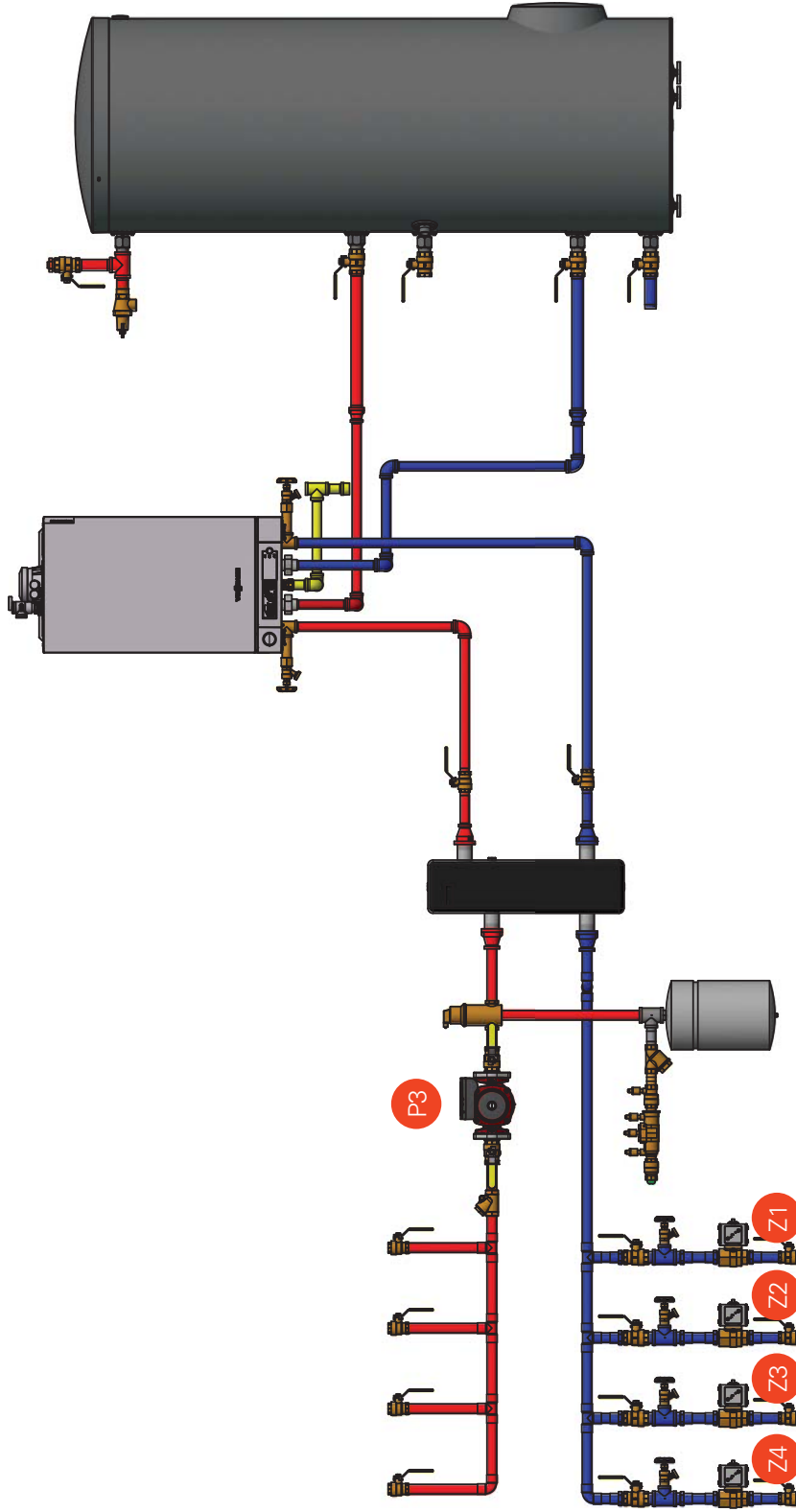

Notes/Comments

1. Component Index on pages 5.
2. A variable speed circulator will automatically adjust to opening and closing zones. This ensures proper flow regardless of how many zones are open.
3. If a fixed speed circulator is being used in this application, it would be necessary to install a differential pressure bypass valve. This ensures a correct flow through a zone under changing loads.



Pressure Drop B1HA

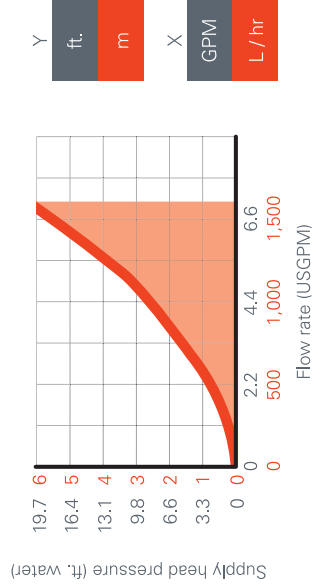

Application Code

VD11 1HC1T4ZV.01

Pre-Wired

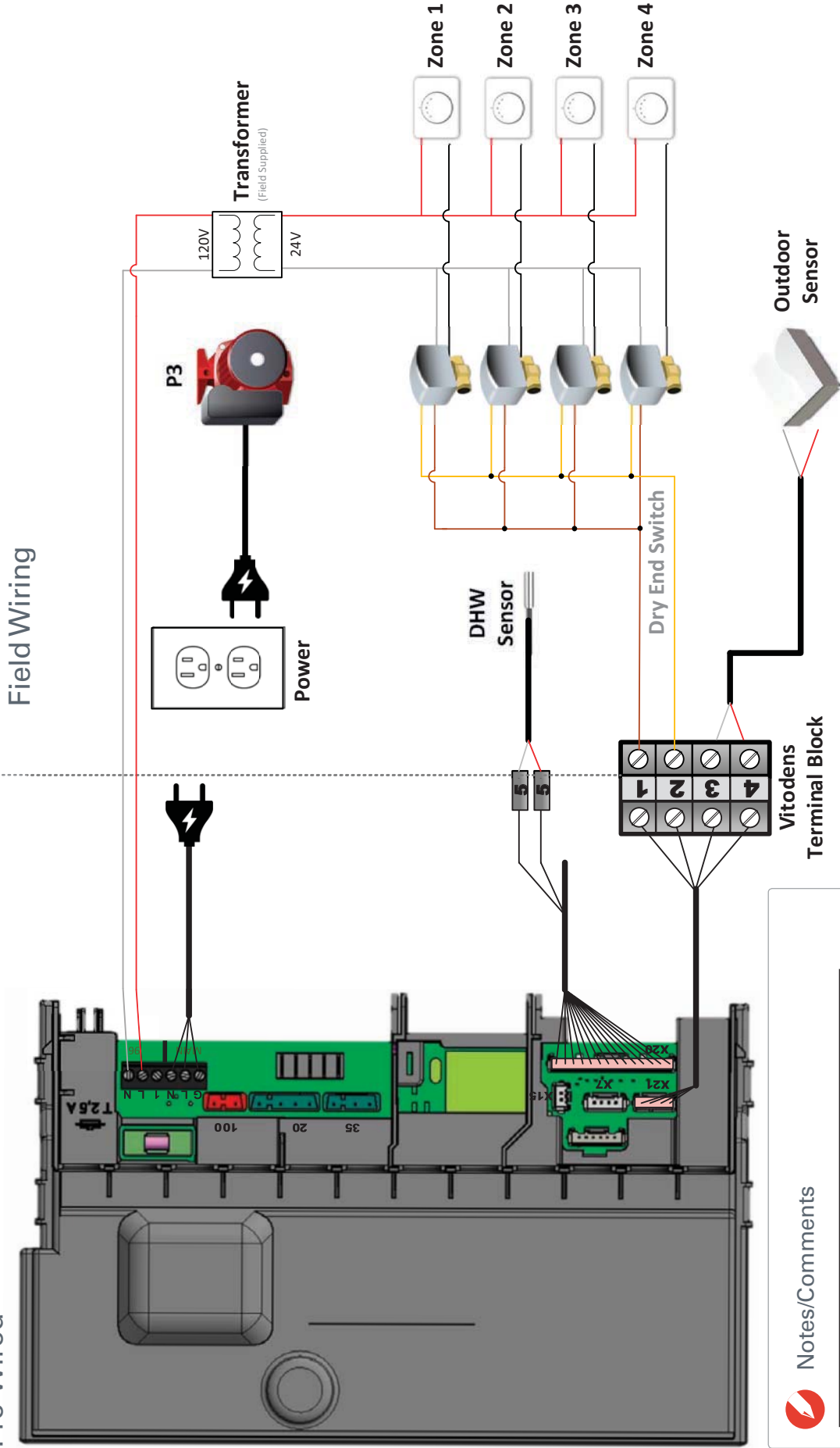

- Notes/Comments**
1. If using a fixed speed pump, it is recommended that a zone control relay be installed to control the operation of the pump and zone valves.
 2. If outdoor weather compensation is not being used, installation of the outdoor temperature sensor is not necessary.



Application Code

VD11 1HC1T4ZV.01

B1HA Boiler Setup

In this system you have a Vitodens 100 with indirect water heater and a four zone system controlled via zone valves. Upon a call for heat a zone valve opens, closing the end switch on the valve, and initiates the boiler. In the event there is a call for DHW, the boiler's internal pump and diverting valve, will redirect the water to the indirect water heater. This allows the boiler to commit all energy produced to the production of domestic hot water. Once satisfied, the diverting valve will return to its home position and continue supplying heat to the heating system until satisfied. To set up the boiler for this application you will need to complete the following:



Application Code

VD1I 1HC1T4ZV.01

Function	Step #	Description	
Adjust the Boiler Setpoint Temperature: (No Outdoor Sensor Connected)	1	Tap the \uparrow/\downarrow button until the begins flashing.	
	2	Press OK .	
	3	Press the \uparrow/\downarrow until the required boiler water temperature is displayed.	
	4	Press OK to confirm.	
OR			
Set and Outdoor Reset Curve: (With Outdoor Sensor Connected)	1	Tap the \uparrow/\downarrow button until the begins flashing.	
	2	Press OK .	
	3	Using the chart below, select the number of the desired reset curve for your application. (value shown on the boiler display will depend on whether the boiler is set to °F or °C)	
	4	Press the \uparrow/\downarrow until the required curve is selected and press OK .	
Set DHW Temperature: (Not available if using an aquastat)	1	Tap the \uparrow/\downarrow button until the begins flashing.	
	2	Press OK .	
	3	Press the \uparrow/\downarrow until the required DHW temperature is displayed.	
	4	Press OK to confirm.	

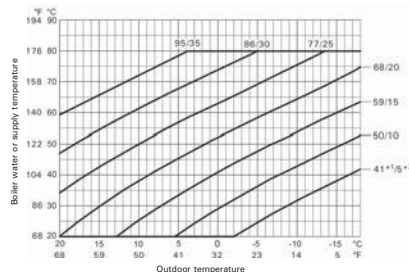

*For more information on how to reconfigure the boiler, please reference page 40.



Notes/Comments

Your Local Viessmann Experts:



**FRANCIS PLUMBING & HEATING
CLIMATECARE.**

Francis Plumbing & Heating ClimateCare

phone: 613-224-0041

email: office@francisplumbing.com

chat on our website: www.FrancisPlumbing.com

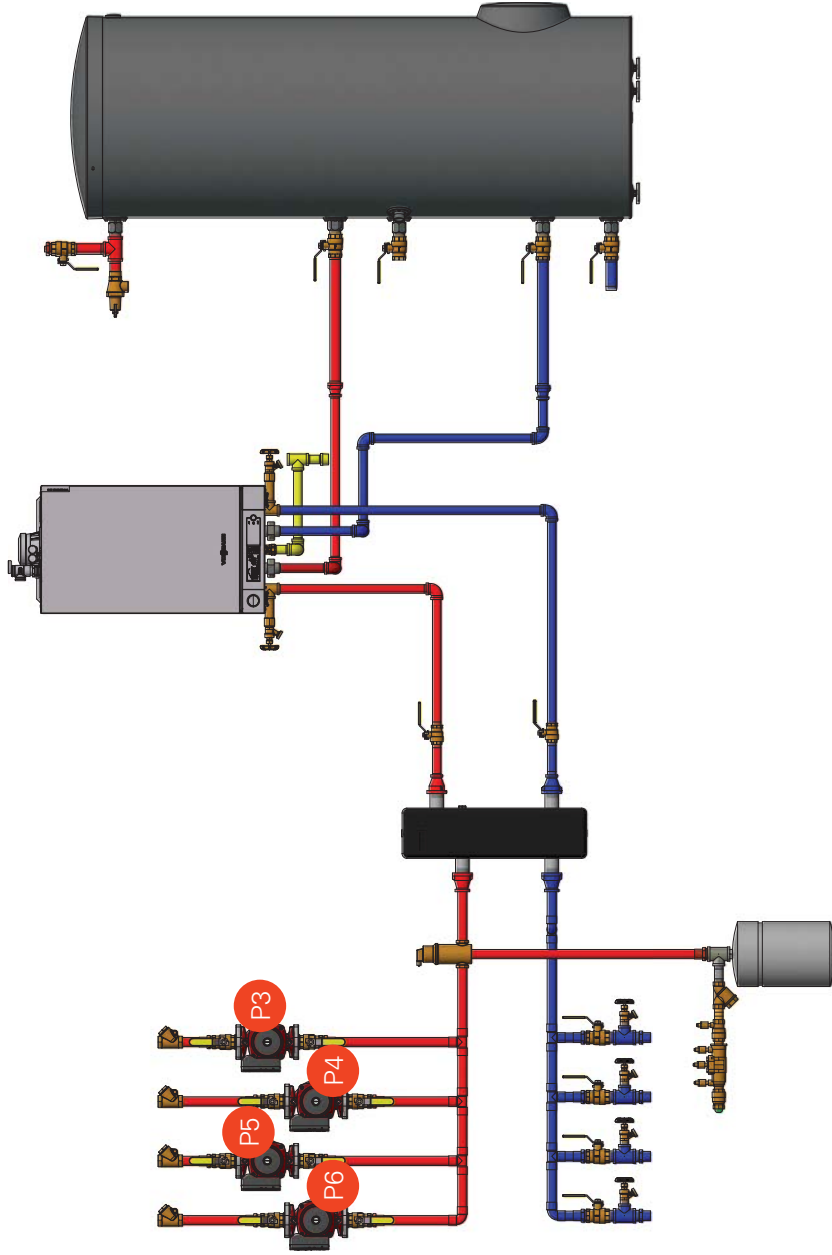

Notes/Comments

1. Component Index on pages 5.
2. Always consider the electrical consumption associated with zoning a system with circulators. Often there are more efficient alternatives which could be considered when designing a system.
3. Since the primary circulator is integrated into boiler, field installation of a boiler circulator is not required for the boiler and indirect DHW.



Pressure Drop B1HA

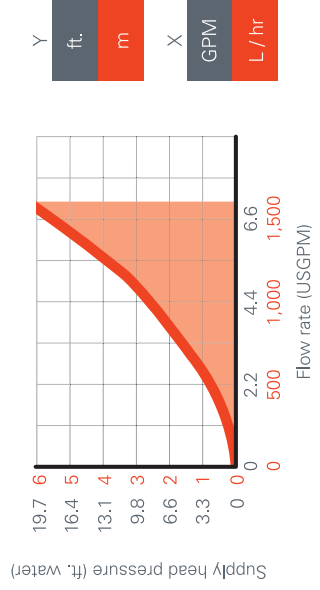

Y	X
ft.	GPM
m	L/hr



Application Code

VD11 1HC1T4ZP01

B1HA Boiler Setup

Similar to the previous application, this system utilizes circulators instead of zone valves. Upon a call for heat, the multizone control initiates the associated circulator and sends a signal to the boiler's. Once the boiler has received this signal, the integrated boiler pump starts and the boiler fires. If there is a call for DHW during a heating cycle, the boiler's integrated diverting valve will transition into DHW mode and a new target setpoint will be established. Once the DHW tank is satisfied, the diverting valve will switch back into heating mode and supply heat to the low loss header. To set up the boiler for this application you will need to complete the following:



Application Code

VD1I 1HC1T4ZP01

Function	Step #	Description	
Adjust the Boiler Setpoint Temperature: <i>(No Outdoor Sensor Connected)</i>	1	Tap the \uparrow/\downarrow button until the begins flashing.	
	2	Press OK .	
	3	Press the \uparrow/\downarrow until the required boiler water temperature is displayed.	
	4	Press OK to confirm.	
OR			
Set and Outdoor Reset Curve: <i>(With Outdoor Sensor Connected)</i>	1	Tap the \uparrow/\downarrow button until the begins flashing.	
	2	Press OK .	
	3	Using the chart below, select the number of the desired reset curve for your application. <i>(value shown on the boiler display will depend on whether the boiler is set to °F or °C)</i>	
	4	Press the \uparrow/\downarrow until the required curve is selected and press OK .	
Set DHW Temperature: <i>(Not available if using an aquastat)</i>	1	Tap the \uparrow/\downarrow button until the begins flashing.	
	2	Press OK .	
	3	Press the \uparrow/\downarrow until the required DHW temperature is displayed.	
	4	Press OK to confirm.	

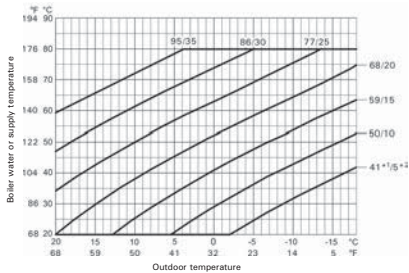

*For more information on how to reconfigure the boiler, please reference page 40.



Notes/Comments

Your Local Viessmann Experts:



Francis Plumbing & Heating ClimateCare
phone: 613-224-0041
email: office@francisplumbing.com
chat on our website: www.FrancisPlumbing.com

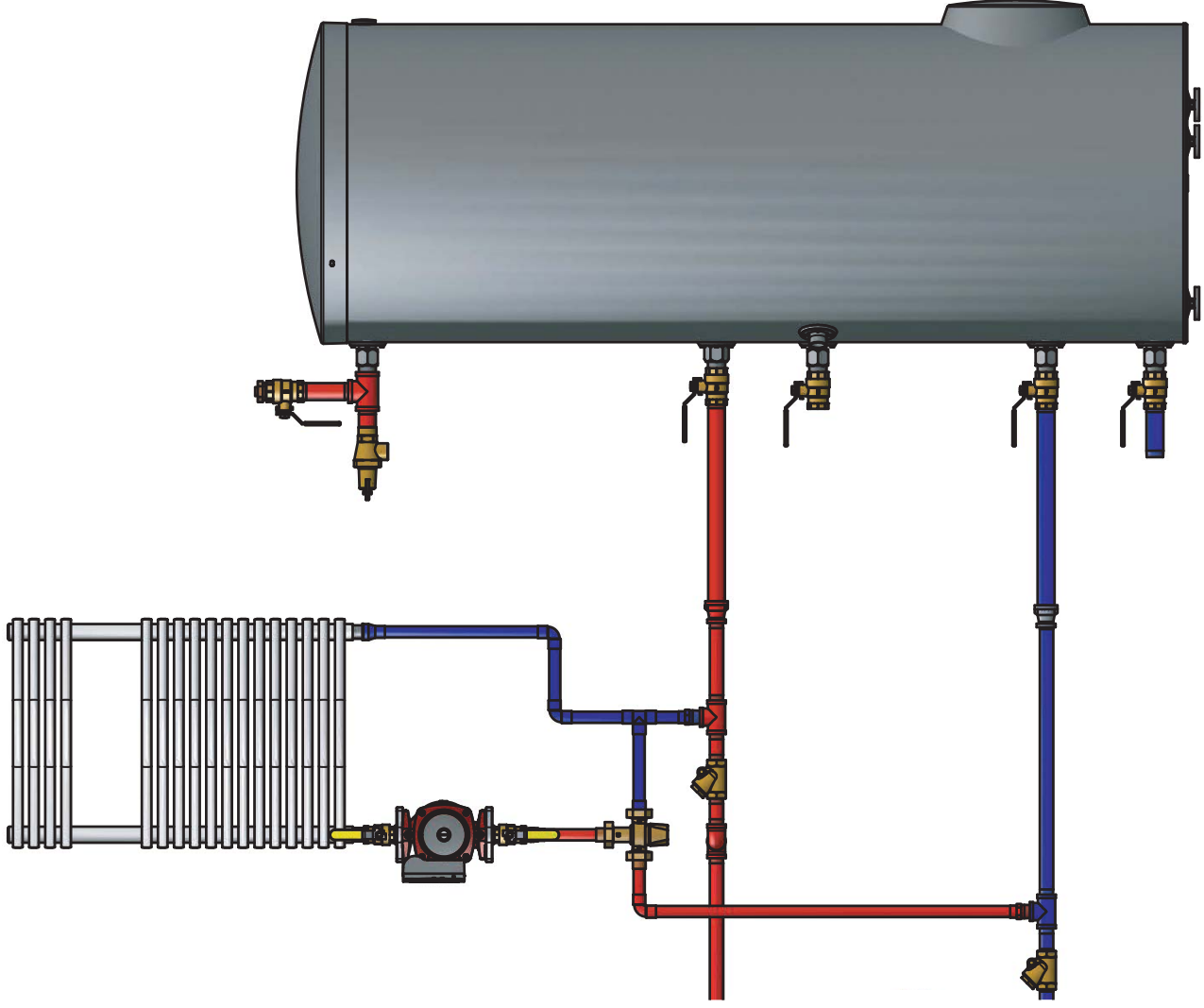

Application Code

Microload



Notes/Comments

1. Component Index on pages 5.
2. To ensure correct operation, install flow check valves according to this diagram heating and DHW.

What is a Microload?

A Microload is typically considered a zone that has an output substantially less than the boiler's lowest firing rate. Even when firing at its lowest input, the boiler will short cycle putting added stress on all the components and decreasing efficiency.

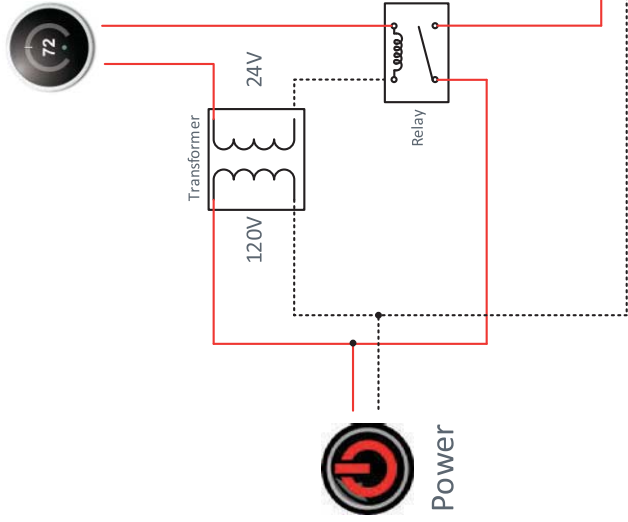

Application Code

Microload

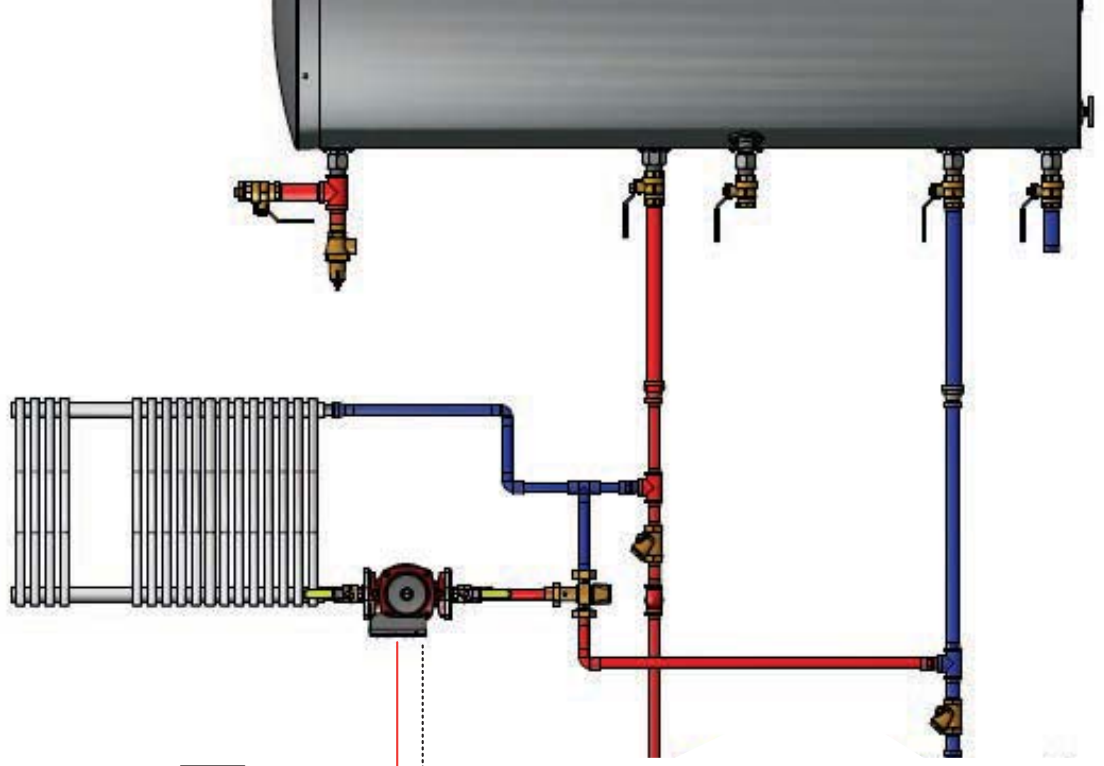

Solution

Piping a "Microload" in this manner, prevents the boiler from short cycling. Upon a call for heat, the circulator starts up and draws heat out of the indirect water heater. As the temperature in the water heater decreases, the boiler senses this drop in temperature and proceeds to heat the tank back up. Because of the larger volume of water, this extends the boiler's run cycle and allows it to operate at a more efficient state.

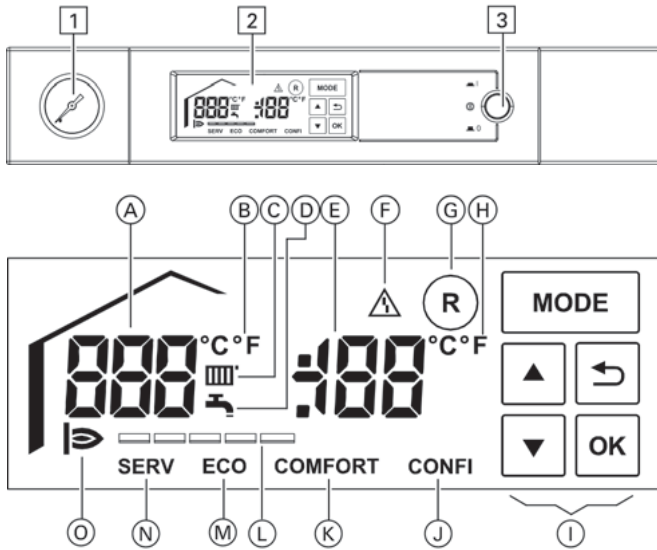





Legend

- 1 Pressure gage
- 2 LCD display unit
- 3 Power switch ON/OFF

Legend

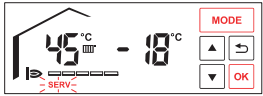
- A Display value or fault code
- B Temperature in °F/°C (with the display value)
- C Heating mode
- D DHW heating
- E Display value or fault code
- F Fault indicator
- G Burner fault reset
- H Temperature in °F/°C (with the display value)
- I On-screen buttons
- J Commissioning setting active (only for contractors)
- K DHW comfort function active (only for B1KA)
- L Current burner output (each bar = 20%)
- M DHW comfort function not active (only for B1KA)
- N Service setting active (only for B1HA)
- O Burner in operation

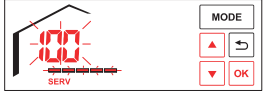
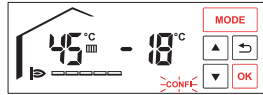
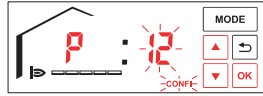
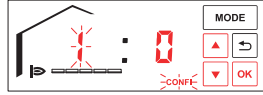
 Operation	Step #	 Description	
Put Boiler into Emissions Test/ Service Mode:	1 2 3 4 OR	Tap the MODE button until the SERV begins flashing. Press OK . Press the ↑/↓ until the required firing rate is displayed. Press OK to confirm.	  
Access 14 Parameter Options:	1 2 3	Press the MODE button until CONFI begins flashing. Press OK , and P will appear in the left hand display. Press the ↑/↓ until the display reaches 12 and press OK . This now gives the user access to the various functional changes below.	  

Item #	Function	Setting Options	Description	Default Setting
1	Filling	0 - Fill mode OFF	After pressing 'OK' the filling function is active. This process will automatically terminate after 30 min.	0
		1 - Fill mode ON		
2	Reduce max. heating output	00 -Low fire (25%)	"The max. heating output can be adjusted according to the requirements of the system. The adjusted heating output should be tested by measuring the gas throughput.	00
		26-99 - Modulation Range (26-99%)		
		100 - High fire (100%)		
3	Altitude setting	0 - < or = 5000 ft (1500 m)	"Adjusts the boiler for high altitude operation.	0
		1-5 - Do Not Adjust		
		6 - > 5000 ft (1500 m)		
5	Fuel Type	0 - Natural Gas	"The gas type can be converted from natural gas to LPG. Conversion kit is required.	0
		1 - LPG		
7	Parameter reset	1 - Vitodens 100-W B1KA-35	The parameter is fixed based on the boiler type and size. When replacing the boiler control, refer to boiler rating on the boiler to set model and size. After adjusting the parameter cycle the boiler power and verify the parameter setting.	#
		2 - Vitodens 100-W B1HA-26		
		3 - Vitodens 100-W B1HA-35		
		4-99 - Do Not Adjust		
8	Outdoor Temp. Sensor	0 - NTC 10K Ohm	"The right outside temp. sensor has to be adjusted.	0
		1 - Do not Adjust		
9	Button Tone	0 - On	"The signal tone for display operation can be switched off.	0
		1 - Off		
10	Backlight Display - Standby Mode	0 - Dimmed	"The display backlighting for standby is either dimmed or off.	0
		1 - Off (no back)		
11	Display Contrast	0-6	The display contrast is adjustable from 0 to 6. The higher the value, the greater the contrast.	3
12	Eco/Comfort (B1KA Only)	0 - Eco	"The comfort function makes DHW available faster at the selected set DHW temperature. Only available Vitodens 100-W B1KA	0
		1 - Comfort		
13	Temperature Unit	0 - °C	"The temperature displayed can be set to °C (Celsius) to °F (Fahrenheit).	1
		1 - °F		
14	DHW sensor type (B1HA)	0 - DHW Temp. Sensor (NTC 10K Ohm)	"The boiler either works with a tank sensor (NTC 10kOhm - Supplied) or with a tank aquastat (field supplied)	0
		1 - Aquastat (Dry Contact)		

The Viessmann Group

The Viessmann Group is one of the leading international manufacturers of heating, industrial and refrigeration systems. Founded in 1917, the family business employs approximately 12,000 employees worldwide and generates 2.25 billion Euro in annual group sales.

Viessmann has a strong international outlook – it maintains 22 production companies in 11 countries, subsidiaries and representatives in 74 countries, and a total of 120 sales offices worldwide. Exports account for 54 percent of sales.

For three generations, Viessmann has been providing comfortable, efficient and environmentally-responsible heating solutions, tailored to the needs of the market. With ongoing research and development and a focus on product innovation, Viessmann has pioneered technologies that have continuously set standards and made the company into a technological innovator and pacesetter of the entire industry.

With the current comprehensive product range, Viessmann is offering a multi-level program of high-tech, state-of-the-art heating products. Wall-mounted gas-fired condensing boilers, floor-standing oil – or gas-fired hot water heating boilers, solar thermal systems, control technology

and DHW storage tanks – all designed to achieve superior performance, reliability and energy savings.

Accountability for the environment and society, fairness when dealing with business partners as well as the pursuit of perfection and maximum efficiency in all business transactions are key values for Viessmann – as a company, and as individuals. This, together with the products and services we offer, allows us to offer our customers the benefit and added value of a strong brand.

Viessmann Manufacturing Company Inc.
750 McMurray Rd.
Waterloo, ON N2V 2G5, Canada
1-800-387-7373
info@viessmann.ca
www.viessmann.ca

Viessmann Manufacturing Company Inc.
6350 204th St.
Langley, BC V2Y 2V1, Canada
1-877-853-3288
info-bc@viessmann.ca
www.viessmann.ca

Viessmann Manufacturing Company Inc.
USA
45 Access Rd.
Warwick, RI 02886, USA
1-800-288-0667
info@viessmann-us.com
www.viessmann.com

Global presence, local commitment.



Langley
British Columbia



Waterloo
Ontario



Warwick
Rhode Island



Viessmann Manufacturing
Company Inc.
Waterloo, ON Canada
1-800-387-7373
www.viessmann.ca

Viessmann Manufacturing
Company Inc. USA
Warwick, RI 02886, USA
1-800-288-0667
info@viessmann-us.com
www.viessmann.com

Your Local Viessmann Experts:



**FRANCIS PLUMBING & HEATING
CLIMATECARE.**

Francis Plumbing & Heating ClimateCare
phone: 613-224-0041
email: office@francisplumbing.com
chat on our website: www.FrancisPlumbing.com