

# SCISSORS





# OPERATING SCISSORS

Chirurgische scheren

Tijeras quirúrgicas

Ciseaux chirurgicaux

Forbici per chirurgia



### STANDARD STRAIGHT

- 306-005-115 11.5 cm, 4 1/2"
- 306-006-130 13.0 cm, 5"
- 306-007-140 14.0 cm, 5 1/2"
- 306-008-150 15.0 cm, 6"
- 306-009-160 16.0 cm, 6 1/4"
- 306-010-175 17.5 cm, 7"
- 306-011-185 18.5 cm, 7 1/4"
- 306-012-200 20.0 cm, 8"

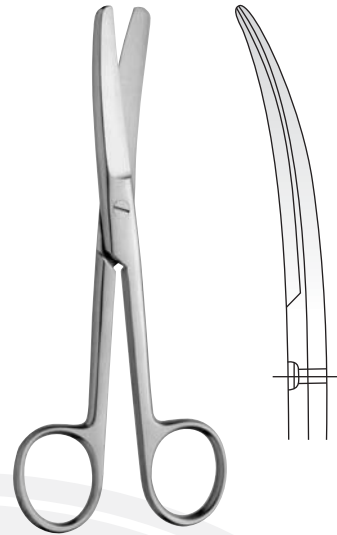

### STANDARD CURVED

- 306-015-115 11.5 cm, 4 1/2"
- 306-016-130 13.0 cm, 5"
- 306-017-140 14.0 cm, 5 1/2"
- 306-018-150 15.0 cm, 6"
- 306-019-160 16.0 cm, 6 1/4"
- 306-020-175 17.5 cm, 7"
- 306-021-185 18.5 cm, 7 1/4"
- 306-022-200 20.0 cm, 8"

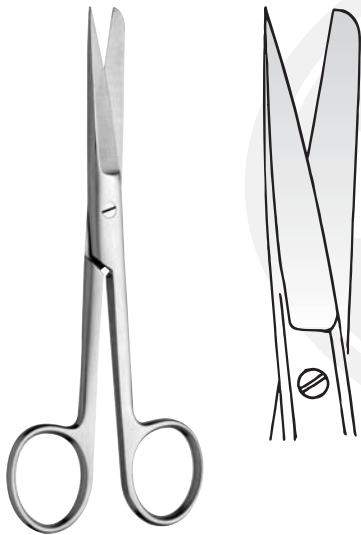

### STANDARD STRAIGHT

- 306-025-115 11.5 cm, 4 1/2"
- 306-026-130 13.0 cm, 5"
- 306-027-140 14.0 cm, 5 1/2"
- 306-028-150 15.0 cm, 6"
- 306-029-160 16.0 cm, 6 1/4"
- 306-030-175 17.5 cm, 7"
- 306-031-185 18.5 cm, 7 1/4"
- 306-032-200 20.0 cm, 8"

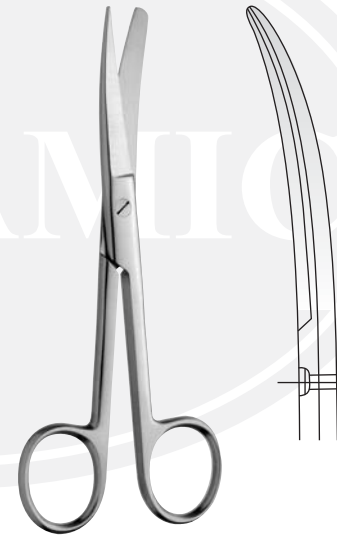

### STANDARD CURVED

- 306-035-115 11.5 cm, 4 1/2"
- 306-036-130 13.0 cm, 5"
- 306-037-140 14.0 cm, 5 1/2"
- 306-038-150 15.0 cm, 6"
- 306-039-160 16.0 cm, 6 1/4"
- 306-040-175 17.5 cm, 7"
- 306-041-185 18.5 cm, 7 1/4"
- 306-042-200 20.0 cm, 8"

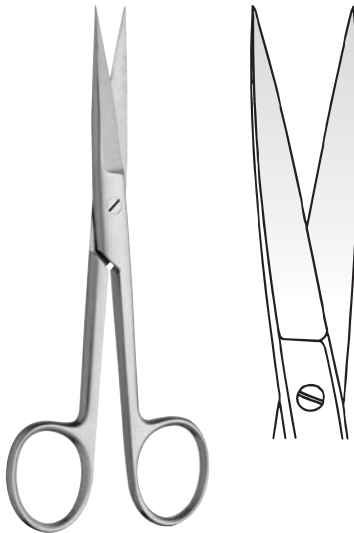

### STANDARD STRAIGHT

- 306-045-115 11.5 cm, 4 1/2"
- 306-046-130 13.0 cm, 5"
- 306-047-140 14.0 cm, 5 1/2"
- 306-048-150 15.0 cm, 6"
- 306-049-160 16.0 cm, 6 1/4"
- 306-050-175 17.5 cm, 7"
- 306-051-185 18.5 cm, 7 1/4"
- 306-052-200 20.0 cm, 8"

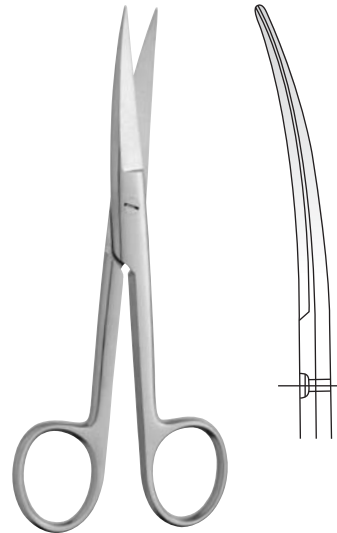

### STANDARD CURVED

- 306-055-115 11.5 cm, 4 1/2"
- 306-056-130 13.0 cm, 5"
- 306-057-140 14.0 cm, 5 1/2"
- 306-058-150 15.0 cm, 6"
- 306-059-160 16.0 cm, 6 1/4"
- 306-060-175 17.5 cm, 7"
- 306-061-185 18.5 cm, 7 1/4"
- 306-062-200 20.0 cm, 8"



# OPERATING SCISSORS

Chirurgische scheren

Tijeras quirúrgicas

Ciseaux chirurgicaux

Forbici per chirurgia



### STANDARD STRAIGHT

- 306-065-115 11.5 cm, 4 1/2"
- 306-066-130 13.0 cm, 5"
- 306-067-140 14.0 cm, 5 1/2"
- 306-068-150 15.0 cm, 6"
- 306-069-160 16.0 cm, 6 1/4"
- 306-070-175 17.5 cm, 7"
- 306-071-185 18.5 cm, 7 1/4"
- 306-072-200 20.0 cm, 8"

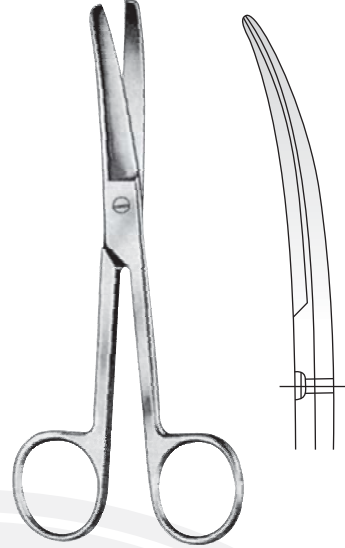

### STANDARD CURVED

- 306-075-115 11.5 cm, 4 1/2"
- 306-076-130 13.0 cm, 5"
- 306-077-140 14.0 cm, 5 1/2"
- 306-078-150 15.0 cm, 6"
- 306-079-160 16.0 cm, 6 1/4"
- 306-080-175 17.5 cm, 7"
- 306-081-185 18.5 cm, 7 1/4"
- 306-082-200 20.0 cm, 8"



### STANDARD STRAIGHT

- 306-085-115 11.5 cm, 4 1/2"
- 306-086-130 13.0 cm, 5"
- 306-087-140 14.0 cm, 5 1/2"
- 306-088-150 15.0 cm, 6"
- 306-089-160 16.0 cm, 6 1/4"
- 306-090-175 17.5 cm, 7"
- 306-091-185 18.5 cm, 7 1/4"
- 306-092-200 20.0 cm, 8"

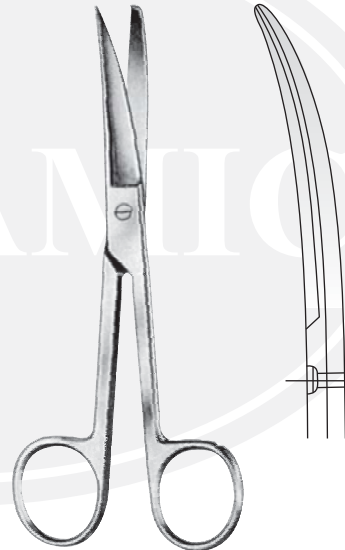

### STANDARD CURVED

- 306-095-115 11.5 cm, 4 1/2"
- 306-096-130 13.0 cm, 5"
- 306-097-140 14.0 cm, 5 1/2"
- 306-098-150 15.0 cm, 6"
- 306-099-165 16.0 cm, 6 1/4"
- 306-100-175 17.5 cm, 7"
- 306-101-185 18.5 cm, 7 1/4"
- 306-102-200 20.0 cm, 8"



### STANDARD STRAIGHT

- 306-105-115 11.5 cm, 4 1/2"
- 306-106-130 13.0 cm, 5"
- 306-107-140 14.0 cm, 5 1/2"
- 306-108-150 15.0 cm, 6"
- 306-109-160 16.0 cm, 6 1/4"
- 306-110-175 17.5 cm, 7"
- 306-111-185 18.5 cm, 7 1/4"
- 306-112-200 20.0 cm, 8"



### STANDARD CURVED

- 306-115-115 11.5 cm, 4 1/2"
- 306-116-130 13.0 cm, 5"
- 306-117-140 14.0 cm, 5 1/2"
- 306-118-150 15.0 cm, 6"
- 306-119-160 16.0 cm, 6 1/4"
- 306-120-175 17.5 cm, 7"
- 306-121-185 18.5 cm, 7 1/4"
- 306-122-200 20.0 cm, 8"



# OPERATING, DISSECTING SCISSORS

Chirurgische scheren, Präparierscheren

Tijeras quirúrgicas, Tijeras de disección

Ciseaux chirurgicaux, Ciseaux à dissection

Forbici per chirurgia, Forbici per dissezione

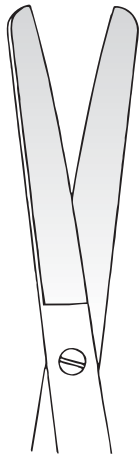

## GRAZIL STRAIGHT

306-105-130 13.0 cm, 5"  
306-106-145 14.5 cm, 5 3/4"

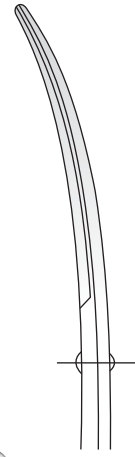

## GRAZIL CURVED

306-109-130 13.0 cm, 5"  
306-110-145 14.5 cm, 5 3/4"



## GRAZIL STRAIGHT

306-112-130 13.0 cm, 5"  
306-113-145 14.5 cm, 5 3/4"



## GRAZIL CURVED

306-115-130 13.0 cm, 5"  
306-116-145 14.5 cm, 5 3/4"

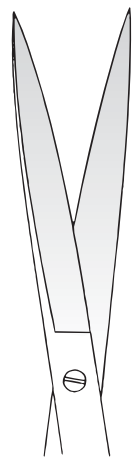

## GRAZIL STRAIGHT

306-119-130 13.0 cm, 5"  
306-120-145 14.5 cm, 5 3/4"

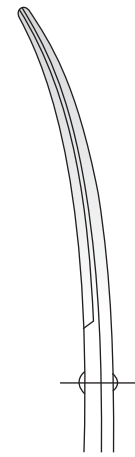

## GRAZIL CURVED

306-123-130 13.0 cm, 5"  
306-124-145 14.5 cm, 5 3/4"



# OPERATING, DISSECTING SCISSORS

Chirurgische scheren, Präparierscheren

Ciseaux chirurgicaux, Ciseaux à dissection

Tijeras quirúrgicas, Tijeras de disección

Forbici per chirurgia, Forbici per dissezione



**INCISION SCISSORS**  
306-126-130 13.0 cm, 5"  
306-127-145 14.5 cm, 5 1/2"



**INCISION SCISSORS**  
306-129-155  
15.5 cm, 6"



**RICHTER**  
306-131-145  
14.5 cm, 5 1/2"



**FERGUSSON**  
306-133-140 14.0 cm, 5 1/2"  
306-134-165 16.5 cm, 6 1/2"  
306-135-180 18.0 cm, 7"



**DEAVER**  
306-137-140  
14.0 cm, 5 1/2"

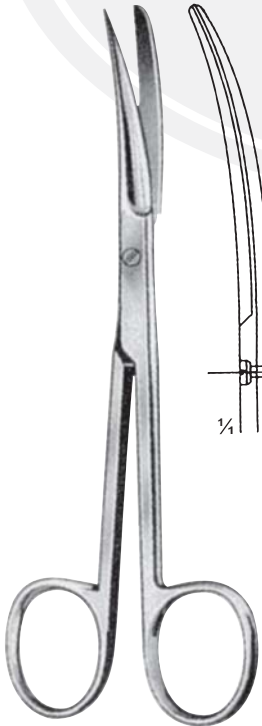

**DEAVER**  
306-140-140  
14.0 cm, 5 1/2"

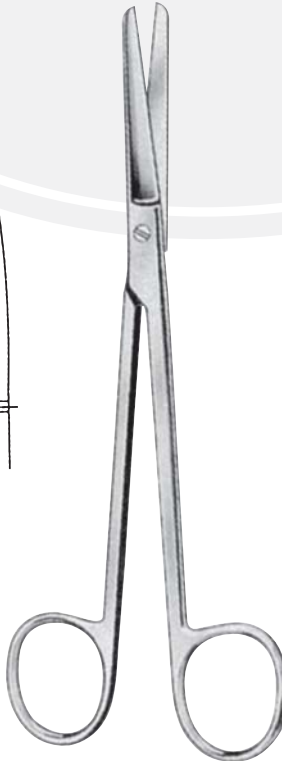

**MIXTER**  
306-142-155  
15.5 cm, 6"



**MIXTER**  
306-145-155  
15.5 cm, 6"

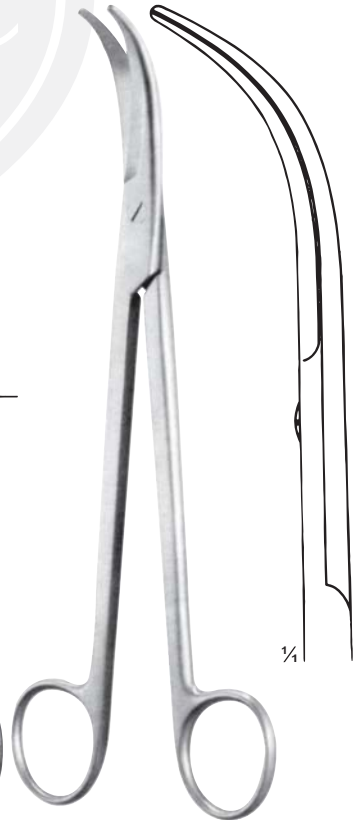

**JORGENSON**  
306-148-220  
22 cm, 8 1/2"  
Curved



# DISSECTING & GYNECOLOGICAL SCISSORS

Präparierscheren, Gynäkologische Scheren

Ciseaux à dissection, ciseaux à gynécologie

Tijeras de disección, Tijeras para ginecología

Forbici per dissezione, Forbici per ginecologia



**MAYO**  
**306-150-145** 14.5 cm, 5 1/2"  
**306-151-150** 15.0 cm, 6"  
**306-152-170** 17.0 cm, 6 3/4"

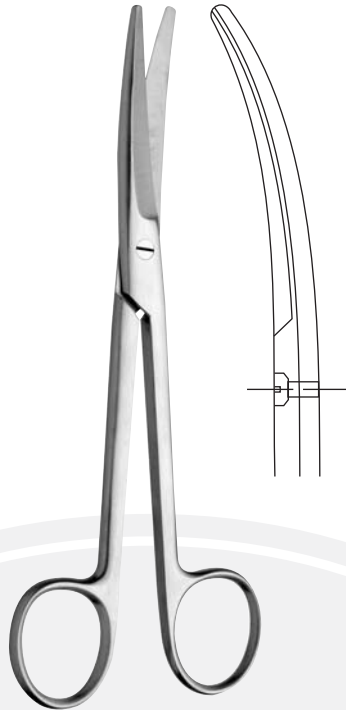

**MAYO**  
**306-155-145** 14.5 cm, 5 1/2"  
**306-156-150** 15.0 cm, 6"  
**306-157-170** 17.0 cm, 6 3/4"



**MAYO-STILLE**  
**306-160-150** 15.0 cm, 6"  
**306-161-170** 17.0 cm, 6 3/4"

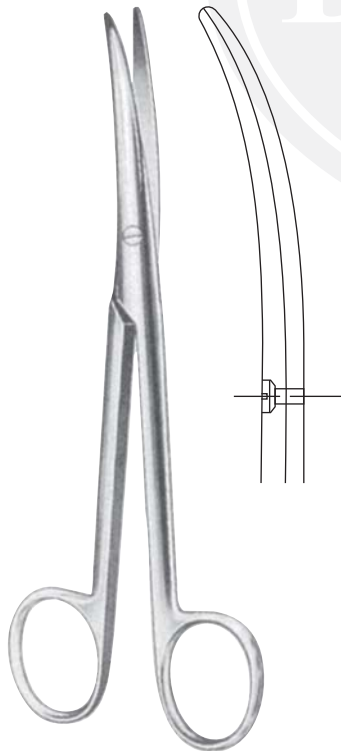

**MAYO-STILLE**  
**306-165-150** 15.0 cm, 6"  
**306-166-170** 17.0 cm, 6 3/4"



**MAYO-NOBLE**  
**306-168-170**  
 17.0 cm, 6 3/4"  
 Straight

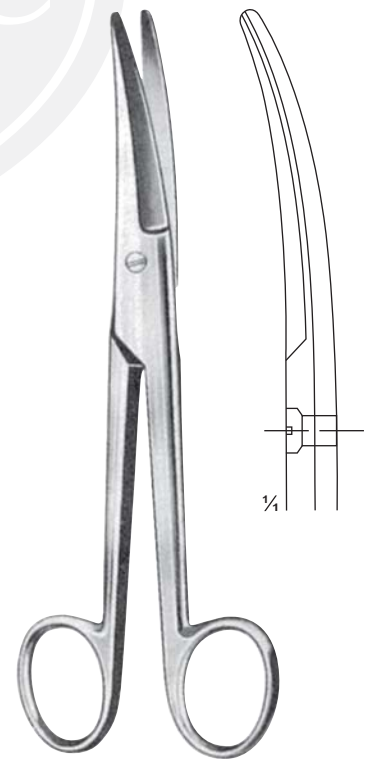

**MAYO-NOBLE**  
**306-170-170**  
 17.0 cm, 6 3/4"  
 Curved



# OPERATING, DISSECTING SCISSORS

Chirurgische scheren, Präparierscheren

Ciseaux chirurgicaux, Ciseaux à dissection

Tijeras quirúrgicas, Tijeras de disección

Forbici per chirurgia, Forbici per dissezione



**METZENBAUM**  
Blunt / Blunt

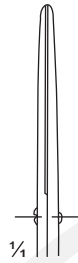

**306-172-145**  
14.5 cm, 5 3/4"

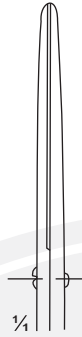

**306-175-180**  
18.0 cm, 7"

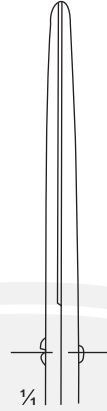

**306-178-200**  
20.0 cm, 8"

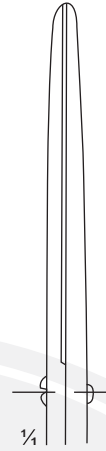

**306-181-230**  
23.0 cm, 9"

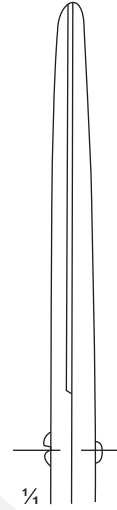

**306-184-250**  
25.0 cm, 10"

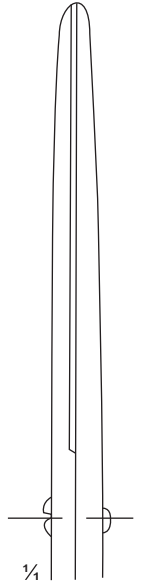

**306-186-280**  
28.0 cm, 11"

DYNAMIC

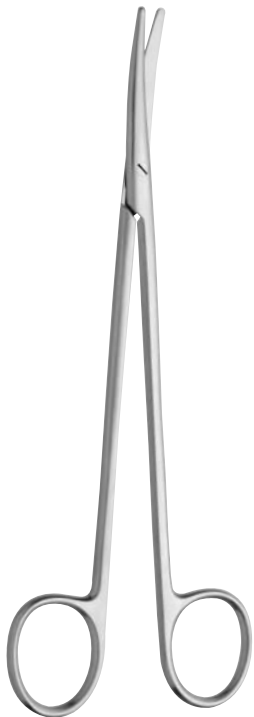

**METZENBAUM**  
Blunt / Blunt



**306-188-180**  
14.5 cm, 5 3/4"

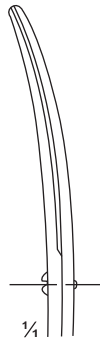

**306-190-180**  
18.0 cm, 7"

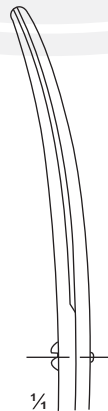

**306-192-200**  
20.0 cm, 8"

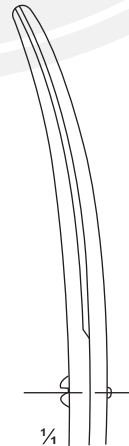

**306-194-230**  
23.0 cm, 9"

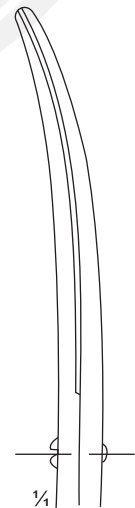

**306-196-250**  
25.0 cm, 10"

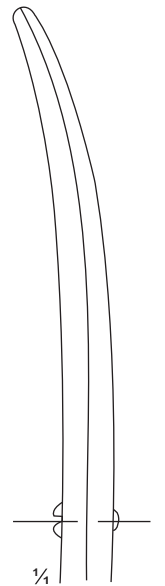

**306-198-280**  
28.0 cm, 11"



# DISSECTING SCISSORS

Präparierscheren

Tijeras de disección

Ciseaux à dissection

Forbici per dissezione

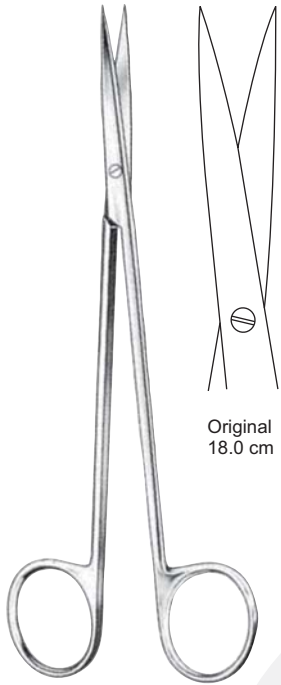

Original  
18.0 cm

**METZENBAUM**  
Sharp/Sharp, Str.

- 306-200-145 14.5 cm, 5 1/2"
- 306-201-180 18.0 cm, 7"
- 306-202-200 20.0 cm, 8"
- 306-203-230 23.0 cm, 9"
- 306-204-250 25.0 cm, 10"
- 306-205-280 28.0 cm, 11"
- 306-206-300 30.0 cm, 12"

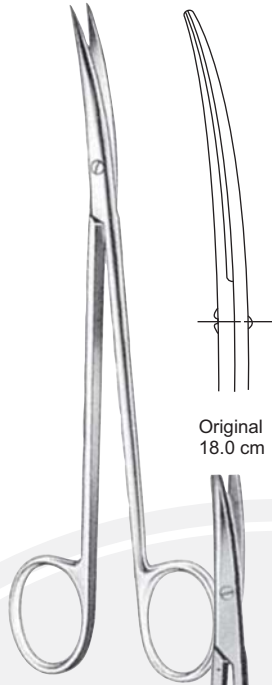

Original  
18.0 cm

**METZENBAUM**  
Sharp/Sharp, Cvd.

- 306-210-145 14.5 cm, 5 1/2"
- 306-211-180 18.0 cm, 7"
- 306-212-200 20.0 cm, 8"
- 306-213-230 23.0 cm, 9"
- 306-214-250 25.0 cm, 10"
- 306-215-280 28.0 cm, 11"
- 306-216-300 30.0 cm, 12"



**METZENBAUM**  
Sharp/Blunt, Str.

- 306-220-145 14.5 cm, 5 1/2"
- 306-221-180 18.0 cm, 7"
- 306-222-200 20.0 cm, 8"
- 306-223-230 23.0 cm, 9"
- 306-224-250 25.0 cm, 10"
- 306-225-280 28.0 cm, 11"
- 306-226-300 30.0 cm, 12"

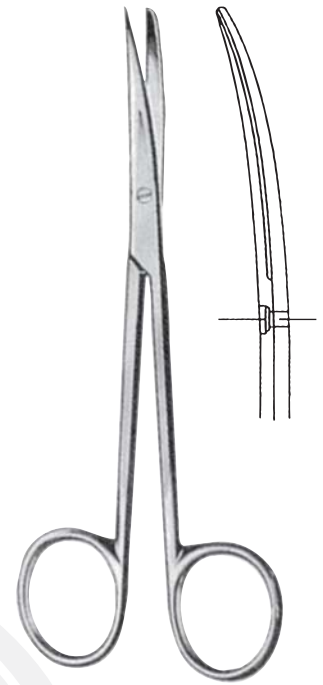

**METZENBAUM**  
Sharp/Blunt, Cvd.

- 306-230-145 14.5 cm, 5 1/2"
- 306-231-180 18.0 cm, 7"
- 306-232-200 20.0 cm, 8"
- 306-233-230 23.0 cm, 9"
- 306-234-250 25.0 cm, 10"
- 306-235-280 28.0 cm, 11"
- 306-236-300 30.0 cm, 12"



Blade length  
6.4 cm  
5.1 cm  
4.4 cm

**METZENBAUM DISSECTING**  
306-240-203 20.3 cm, 8"  
306-241-229 22.9 cm, 9"  
306-242-284 28.4 cm, 11"  
Curved

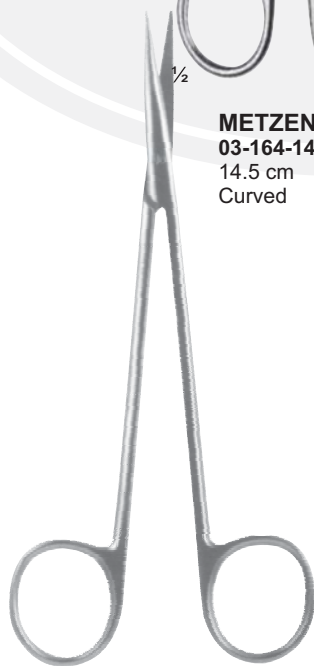

**METZENBAUM-JAMISON**  
306-245-152 15.25 cm, 6"

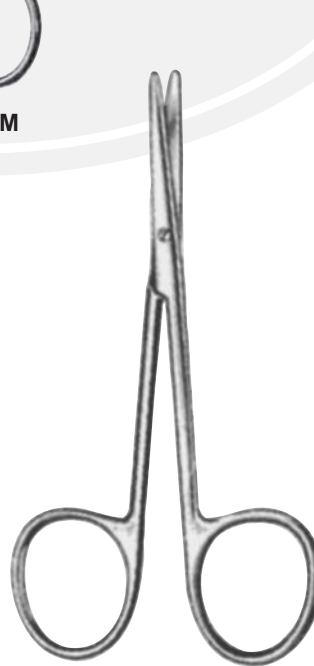

**METZENBAUM-BABY**  
306-248-115 11.5 cm, 4 1/2"

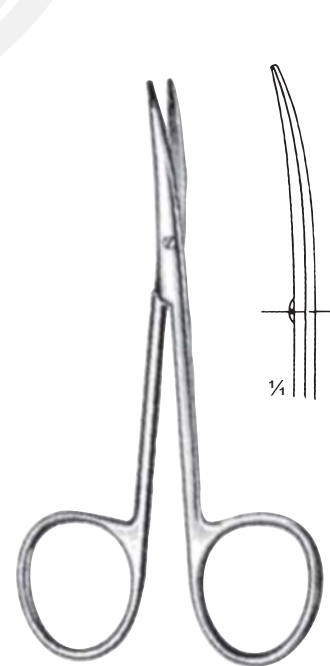

**METZENBAUM-BABY**  
306-250-115 11.5 cm, 4 1/2"

**METZENBAUM**  
03-164-145  
14.5 cm  
Curved





# FACE-LIFE, DISSECTING, NASAL SCISSORS

Face-lift , Präparierscheren, Nasenscheren

Face-lift, Ciseaux à dissection, Ciseaux nasaux

face-Lift, Tijeras de disección, Tijeras nasales

Face-lift, Forbici per dissezione, Forbici nasali

Nerve  
Dissecting  
Scissors

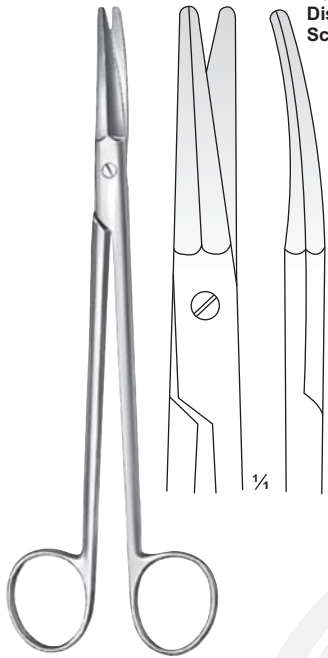

**KAYE FACE-LIFT  
SCISSORS**  
306-255-185  
18.5 cm, 7 1/4"

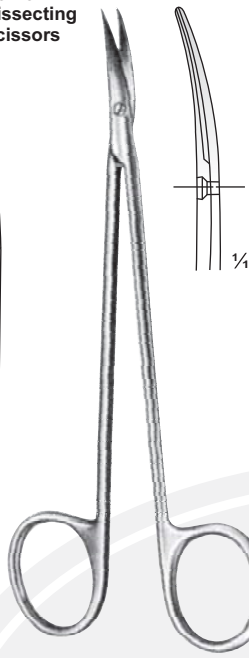

**Straight**  
306-258-150  
15.0 cm, 6"  
**Curved**  
306-261-150  
15.0 cm, 6"



**LEXER**  
306-264-160  
16.0 cm, 6 1/4"

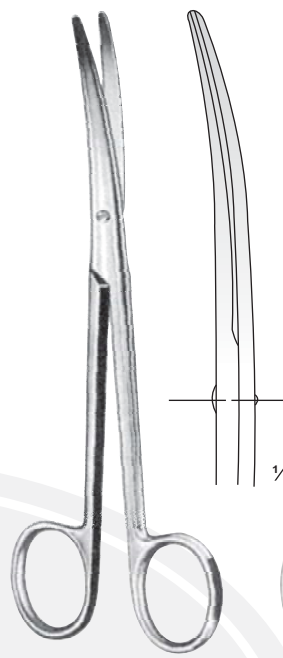

**LEXER**  
306-267-160  
16.0 cm, 6 1/4"

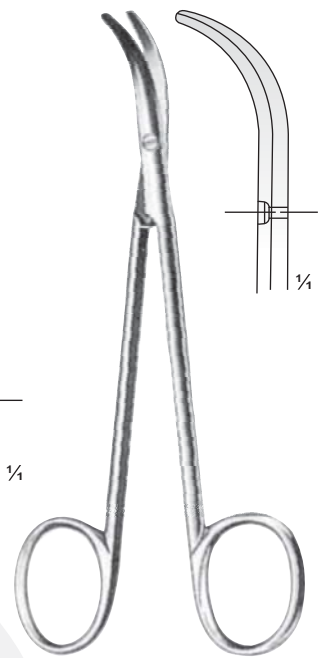

**FOMON**  
306-270-135  
13.5 cm, 5 1/4"



**THOREK-FELDMAN**  
Gall Bladder Scissor  
306-273-180  
18.0 cm, 7"

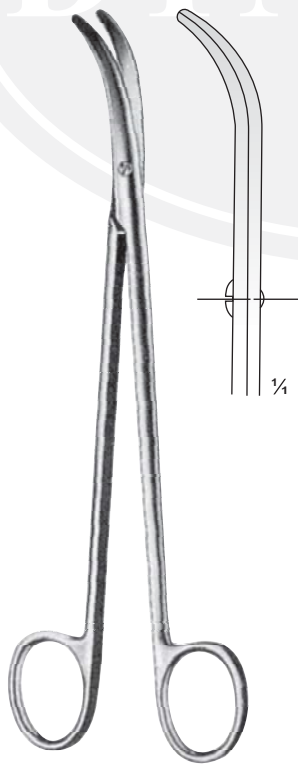

**THOREK**  
306-276-190  
19.0 cm, 7 1/2"



**LEXER-BABY**  
306-279-100  
10.0 cm, 4"

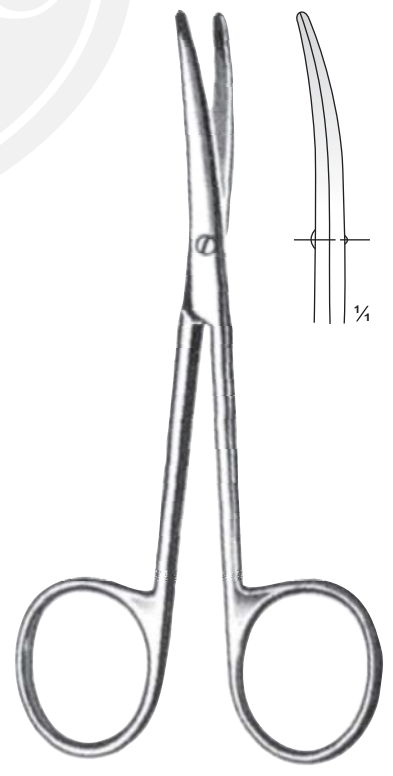

**LEXER-BABY**  
306-282-100  
10.0 cm, 4"



# OPERATING, DISSECTING SCISSORS

Chirurgische scheren, Präparierscheren

Ciseaux chirurgicaux, Ciseaux à dissection

Tijeras quirúrgicas, Tijeras de disección

Forbici per chirurgia, Forbici per dissezione

Plastic



**SANVENERO**  
306-285-140  
14.0 cm, 5 1/2"  
Str.

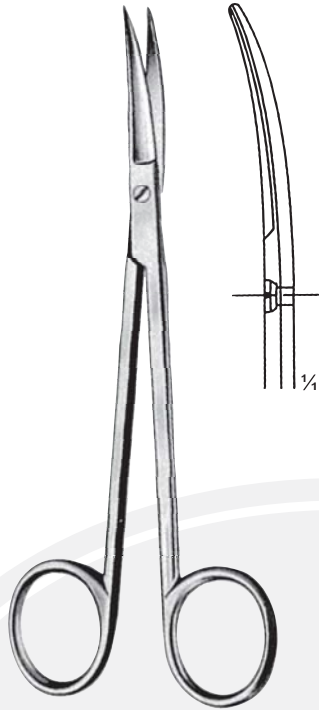

**SANVENERO**  
306-288-140  
14.0 cm, 5 1/2"  
Cvd.



**JOSEPH**  
306-291-140  
14.0 cm, 5 1/2"  
Str.

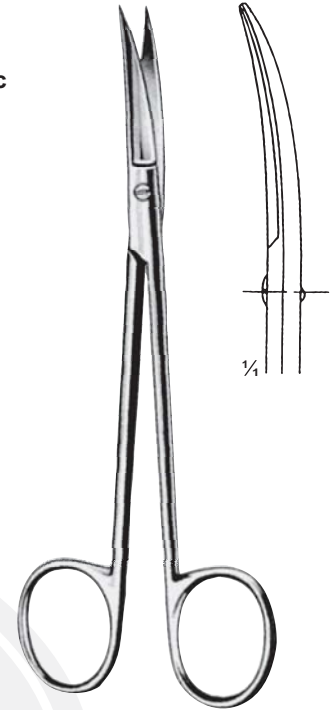

**JOSEPH**  
306-294-140  
14.0 cm, 5 1/2"  
Cvd.

Plastic



**KILNER**  
306-297-120 12.0 cm, 4 3/4"  
306-298-150 15.0 cm, 6"  
306-299-180 18.0 cm, 7"  
306-300-200 20.0 cm, 8"  
Str.

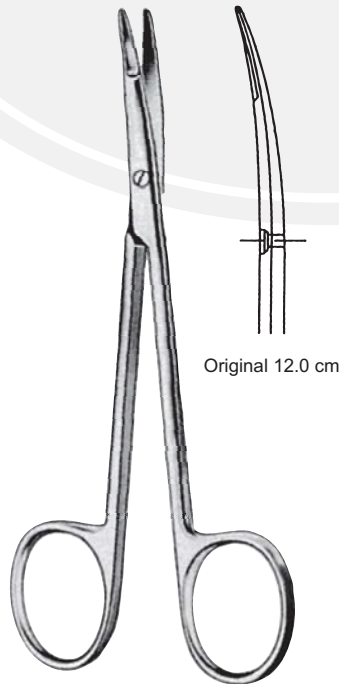

**KILNER**  
306-303-120 12.0 cm, 4 3/4"  
306-304-150 15.0 cm, 6"  
306-305-180 18.0 cm, 7"  
306-306-200 20.0 cm, 8"  
Cvd.

Original 12.0 cm



**REYNOLDS**  
306-310-150 15.0 cm, 6"  
306-311-180 18.0 cm, 7"  
Str.

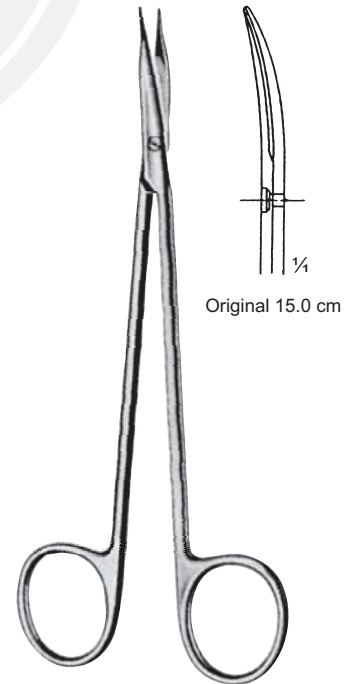

**REYNOLDS**  
306-314-150 15.0 cm, 6"  
306-315-180 18.0 cm, 7"  
Cvd.

Original 15.0 cm



# OPERATING, DISSECTING SCISSORS

Chirurgische scheren, Präparierscheren

Ciseaux chirurgicaux, Ciseaux à dissection

Tijeras quirúrgicas, Tijeras de disección

Forbici per chirurgia, Forbici per dissezione



**DOYEN**  
306-318-160  
16.0 cm, 6 1/4"  
S/B, Str.

**DOYEN**  
306-321-160  
16.0 cm, 6 1/4"  
B/B, Str.

**DOYEN**  
306-324-160  
16.0 cm, 6 1/4"  
B/B, Cvd.

**DOYEN**  
306-327-175  
17.5 cm, 6 3/4"  
B/B, Str.

**DOYEN**  
306-330-175  
17.5 cm, 6 3/4"  
B/B, Cvd.



**KELLY**  
306-333-160 16.0 cm, 6 1/4"  
306-334-180 18.0 cm, 7"  
Str.

**KELLY**  
306-337-160 16.0 cm, 6 1/4"  
306-338-180 18.0 cm, 7"  
Cvd.

**VEZIEN**  
306-341-180  
18.0 cm, 7"

**WETHEIM**  
306-344-145 14.5 cm, 5 3/4"  
306-345-195 19.5 cm, 7 3/4"  
306-346-225 22.5 cm, 8 3/4"

# DISSECTING & GYNECOLOGICAL SCISSORS

Präparierscheren, Gynäkologische Scheren

Ciseaux à dissection, ciseaux à gynécologie

Tijeras de disección, Tijeras para ginecología

Forbici per dissezione, Forbici per ginecologia



**306-355-200**  
20.0 cm, 8"  
**306-356-230**  
23.0 cm, 9"  
S/B



**306-359-200**  
20.0 cm, 8"  
**306-360-230**  
23.0 cm, 9"  
S/S



**SIMS**  
**306-363-200** 20.0 cm, 8"  
**306-364-230** 23.0 cm, 9"  
Curved, B/B



**306-367-200**  
20.0 cm, 8"  
**306-368-230**  
23.0 cm, 9"  
S/B



**306-371-200**  
20.0 cm, 8"  
**306-372-230**  
23.0 cm, 9"  
S/S

**SIMS**  
**306-350-200** 20.0 cm, 8"  
**306-351-230** 23.0 cm, 9"  
Straight, B/B

DYNAMIC



**DUBOIS**  
**306-375-270**  
27.0 cm, 10 3/4"



**DUBOIS**  
**306-378-270**  
27.0 cm, 10 3/4"



**SIEBOLD**  
**306-381-240**  
24.0 cm, 9 1/2"



S-curved

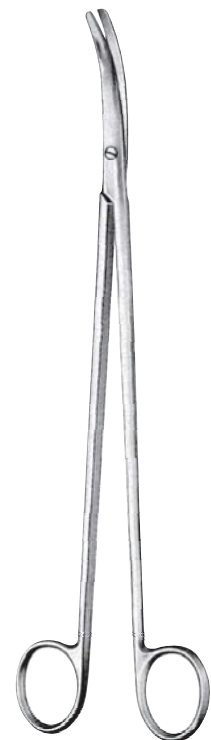

**CARDINALE**  
**306-385-280**  
28.0 cm, 11"



# IRIS, TENDON SCISSORS

Irisscheren, Schnenscheren

Ciseaux à iridectomie, Ciseaux à Ténotomie

Tijeras para Iridectomía, Tijeras para tendones

Forbici per iridectomia, Forbici per tenotomia

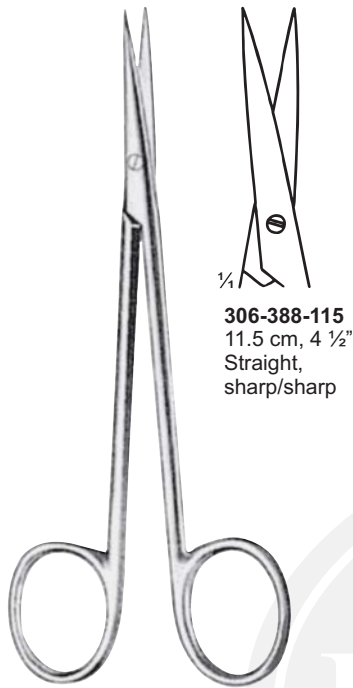

**306-388-115**  
11.5 cm, 4 1/2"  
Straight,  
sharp/sharp

**KILLNER**

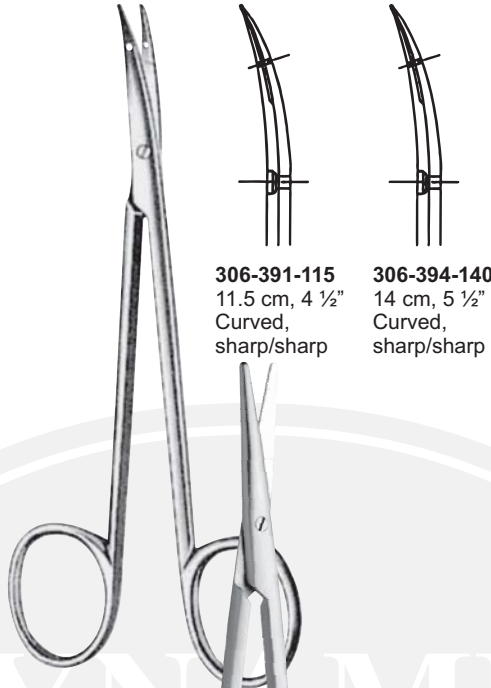

**306-391-115**  
11.5 cm, 4 1/2"  
Curved,  
sharp/sharp

**306-394-140**  
14 cm, 5 1/2"  
Curved,  
sharp/sharp

**LITTLER**

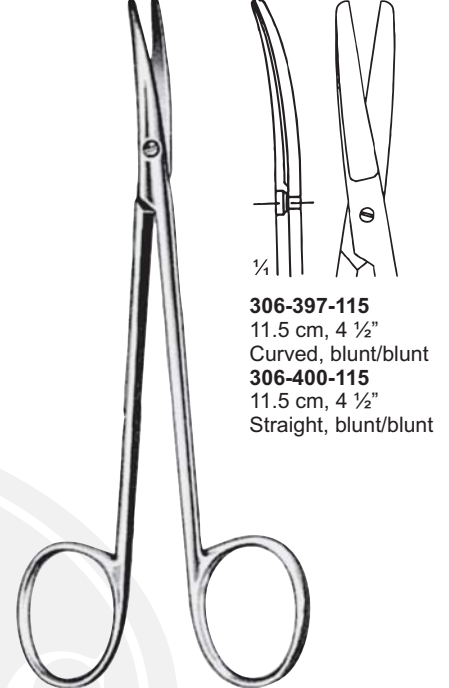

**306-397-115**  
11.5 cm, 4 1/2"  
Curved, blunt/blunt  
**306-400-115**  
11.5 cm, 4 1/2"  
Straight, blunt/blunt

**STRABISMUS**

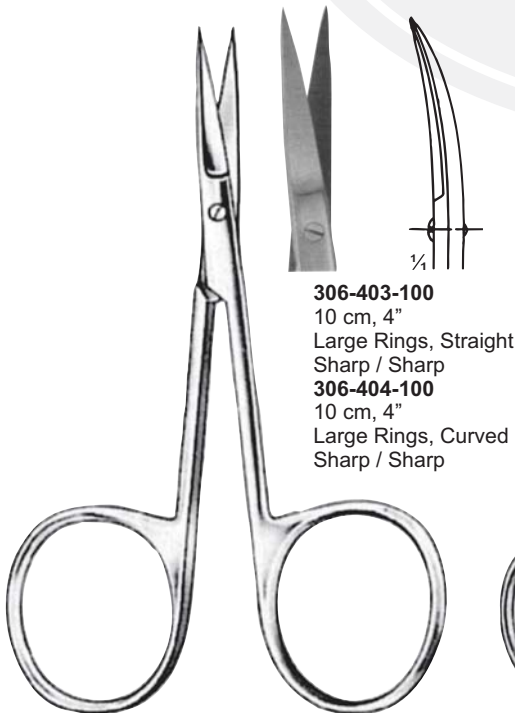

**306-403-100**  
10 cm, 4"  
Large Rings, Straight  
Sharp / Sharp  
**306-404-100**  
10 cm, 4"  
Large Rings, Curved  
Sharp / Sharp

**IRIS**

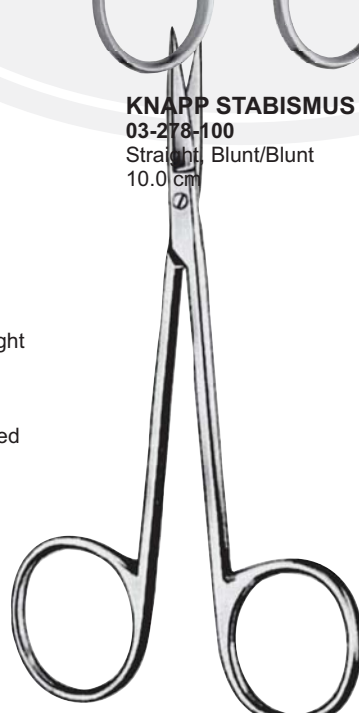

**KNAPP STABISMUS**  
**03-278-100**  
Straight, Blunt/Blunt  
10.0 cm

**IRIS SCISSORS**

Item	Description	Tip
306-407-090	09 cm, 3 1/2" Straight	Sharp/Sharp
306-408-105	10.5 cm, 4 1/4" Straight	Sharp/Sharp
306-409-115	11.5 cm, 4 1/2" Straight	Sharp/Sharp
306-410-120	12.0 cm, 4 3/4" Straight	Sharp/Sharp
306-411-090	09 cm, 3 1/2" Curved	Sharp/Blunt
306-412-105	10.5 cm, 4 1/4" Curved	Sharp/Blunt
306-413-115	11.5 cm, 4 1/2" Curved	Sharp/Blunt
306-414-120	12.0 cm, 4 3/4" Curved	Sharp/Blunt



# IRIS SCISSORS

Irisscheren

Tijeras para Iridectomía

Ciseaux à iridectomie

Forbici per iridectomia



**IRIS**  
306-420-110  
11cm 4 1/4"



Blades length  
3.5 cm

**KNAPP IRIS**  
306-423-102 Straight.  
306-424-102 Curved  
10.2 cm, 4"



**WILMER IRIS**  
306-427-089  
8.9 cm, 3 1/2"



**IRIS**  
306-430-114  
11.4 cm, 4 1/2"



**306-436-115**  
11.5 cm, 4 1/2"



**POTTS-REYNOLDS  
TENOTOMY**  
306-433-120  
12.0 cm, 4 3/4"  
Curved



**POTTS TENOTOMY**  
306-653-152 15.2 cm, 6"  
306-654-178 17.8 cm, 7"  
306-655-203 20.3 cm, 8"



# DISSECTING SCISSORS

Präparierscheren

Tijeras de disección

Ciseaux à dissection

Forbici per dissezione

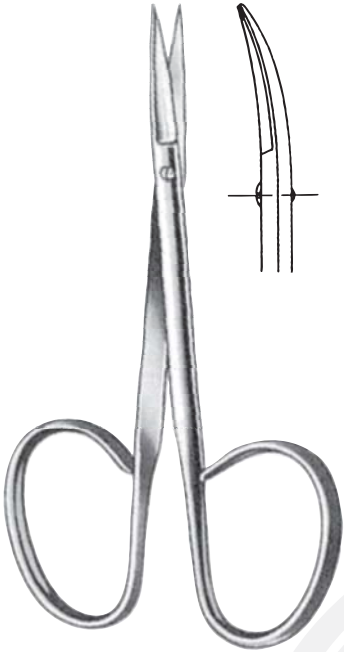

**306-440-100**  
10.0 cm, 4"  
Straight

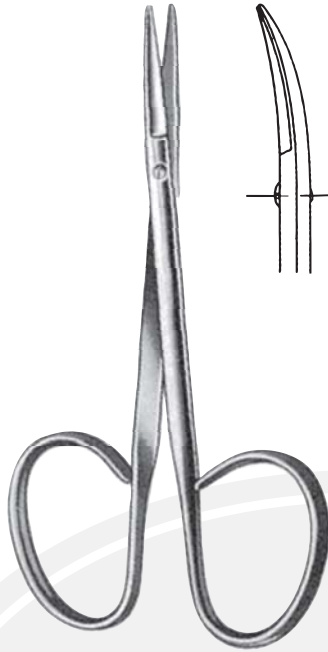

**306-441-100**  
10.0 cm, 4"  
Curved



**306-444-100**  
10.0 cm, 4"  
Straight

**306-445-100**  
10.0 cm, 4"  
Curved

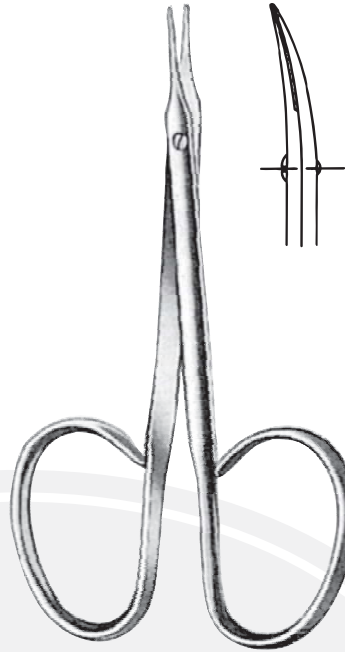

**TENOTOMY**  
**306-448-095**  
9.5 cm, 3 3/4"  
Curved-Ribbon  
Handles blunt/blunt

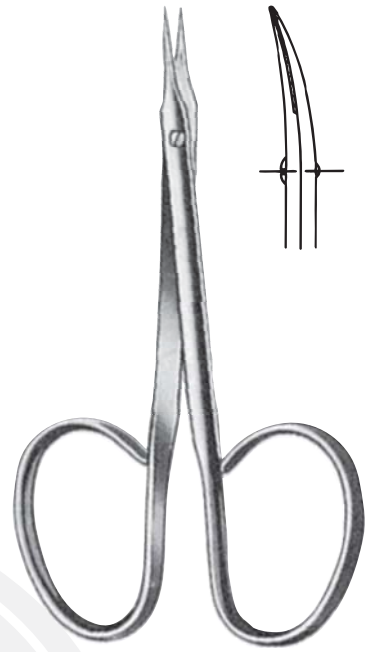

**306-451-095**  
9.5 cm, 3 3/4"  
Straight



**306-452-095**  
9.5 cm, 3 3/4"  
Curved

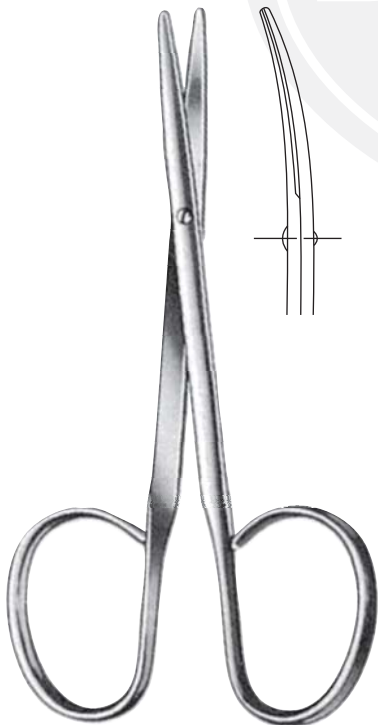

**306-455-100**  
10.0 cm, 4"  
Straight



**306-456-100**  
10.0 cm, 4"  
Curved



**306-459-095**  
9.5 cm, 3 3/4"  
Straight

**306-460-095**  
9.5 cm, 3 3/4"  
Curved



**TENOTOMY-STEVENS**  
**306-463-110** Straight  
**306-464-110** Curved  
11 cm, 4 1/4"

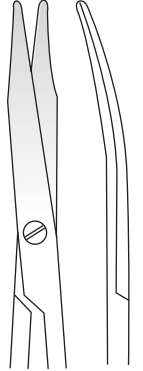



# DISSECTING SCISSORS

Präparierscheren

Tijeras de disección

Ciseaux à dissection

Forbici per dissezione



**GOLDMAN-FOX**  
306-467-130  
13.0 cm, 5"

**GOLDMAN-FOX**  
306-470-130  
13.0 cm, 5"

**GOLDMAN-FOX (Spezial)**  
306-473-130  
13.0 cm, 5"

**306-476-115**  
11.5 cm, 4 1/2"

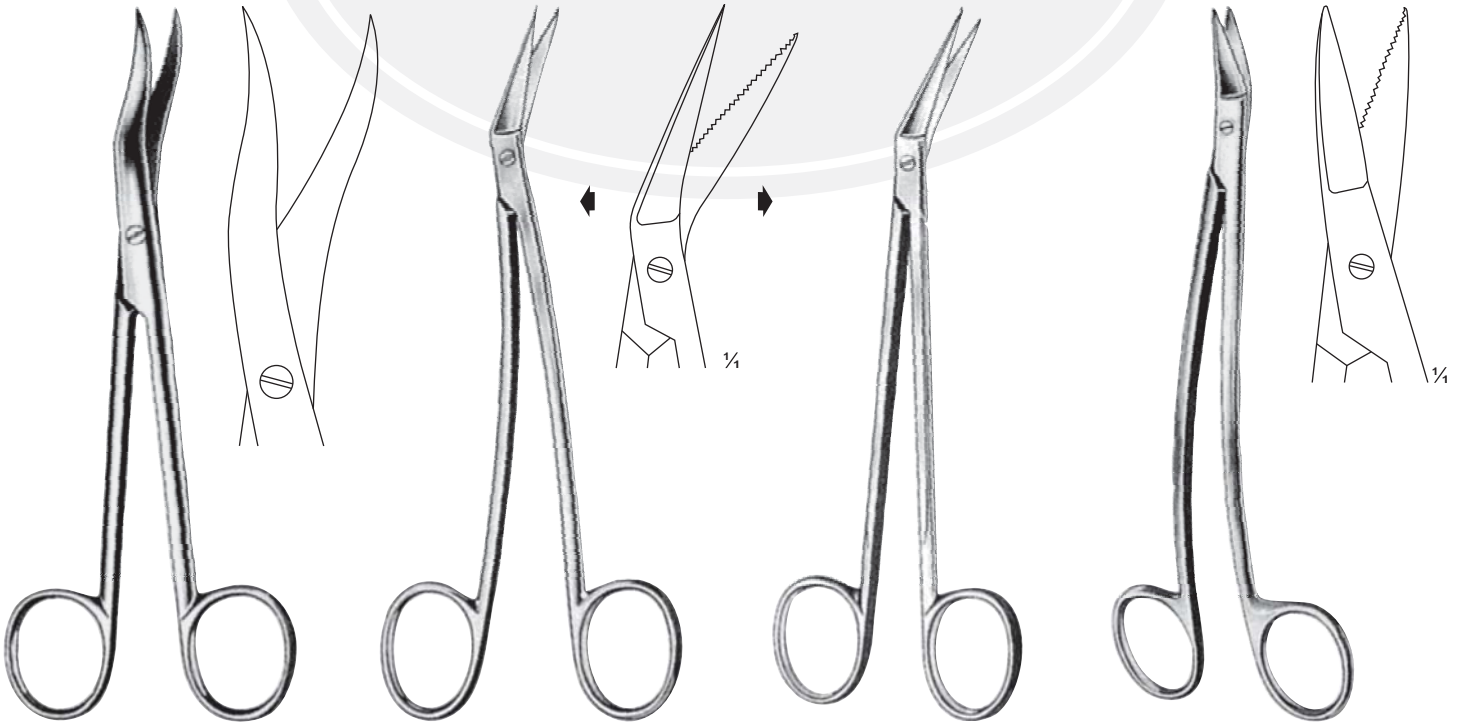

**306-479-160**  
16.0 cm, 6 1/4"

**LOCKLIN**  
306-481-165  
16.5 cm, 6 1/2"

**LOCKLIN**  
306-484-165  
16.5 cm, 6 1/2"

**DEAN-DELLICATE**  
306-487-170  
17.0 cm, 6 3/4"





# VASCULAR SCISSORS

Gefäßscheren

Ciseaux vasculaires

Tijeras vasculares

Forbici vascolari

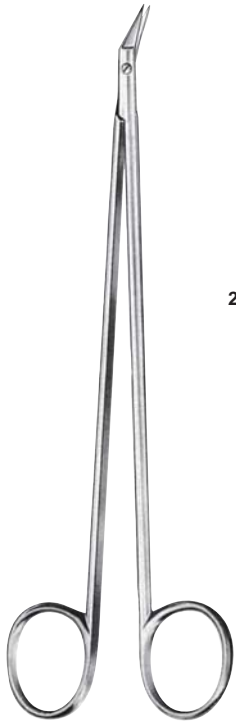

**HEGEMANN-DIETRICH**



25°

**306-490-160**  
16.0 cm, 6 1/4"  
**306-493-190**  
19.0 cm, 7 1/2"

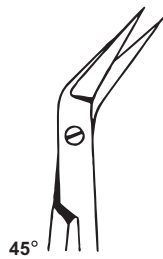

45°

**306-496-160**  
16.0 cm, 6 1/4"  
**306-499-190**  
19.0 cm, 7 1/2"



60°

**306-502-160**  
16.0 cm, 6 1/4"  
**306-505-190**  
19.0 cm, 7 1/2"

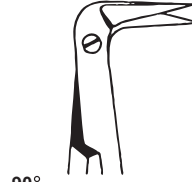

90°

**306-508-160**  
16.0 cm, 6 1/4"  
**306-511-190**  
19.0 cm, 7 1/2"



125°

**306-514-160**  
16.0 cm, 6 1/4"  
**306-517-190**  
19.0 cm, 7 1/2"



**306-520-190**  
19.0 cm, 7 1/2"



**COOLEY REVERSE  
Cut Scissors**  
**306-523-171**  
angled 120°  
17.1 cm, 6 3/4"

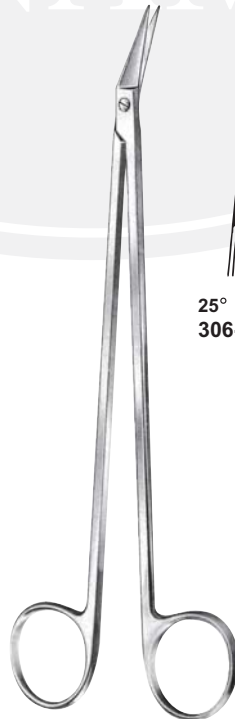

**POTTS-SMITH**  
19.0 cm, 7 1/2"



25°  
**306-526-190**



45°  
**306-527-190**

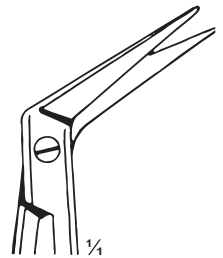

60°  
**306-528-190**



# VASCULAR SCISSORS

Gefäßscheren

Ciseaux vasculaires

Tijeras vasculares

Forbici vascolari



Blade Length  
13 mm

### POTTS-SMITH SCISSORS

306-530-133

Short.

Angled 45°

13.3 cm, 5 1/4"



Blade Length  
19 mm

### POTTS-SMITH SCISSORS

306-533-146

short blades

angled 45°

14.6 cm, 5 3/4"



Delicate Blade  
13 mm

### POTTS-SMITH

306-536-191 19.1 cm, 7 1/2" angled 25°

306-536-133 13.3 cm, 5 1/4" angled 45°

306-537-191 19.1 cm, 7 1/2" angled 45°

306-538-191 19.1 cm, 7 1/2" angled 60°

306-539-191 19.1 cm, 7 1/2" angled 90°



### POTTS-DE MARTEL

306-542-210

21.0 cm, 8 1/4"



### MILLS

306-545-210

21.0 cm, 8 1/4"



### FULTON

306-548-170

17.0 cm, 6 3/4"

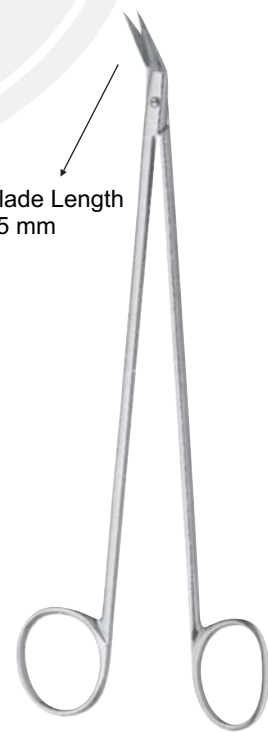

Blade Length  
25 mm

### POTTS-SMITH

306-581-197

19.7 cm, 8"  
angled on flat 50°



# VASCULAR SCISSORS

Gefäßscheren

Ciseaux vasculaires

Tijeras vasculares

Forbici vascolari



**COOLEY**  
angled 45°  
18.4 cm, 7 1/2"

**306-552-184**  
1 mm probe point on tip.  
**306-553-184**  
1.5 mm probe point on tip.



**O'BRIEN**  
**306-556-090**  
9.0 cm, 3 1/2"

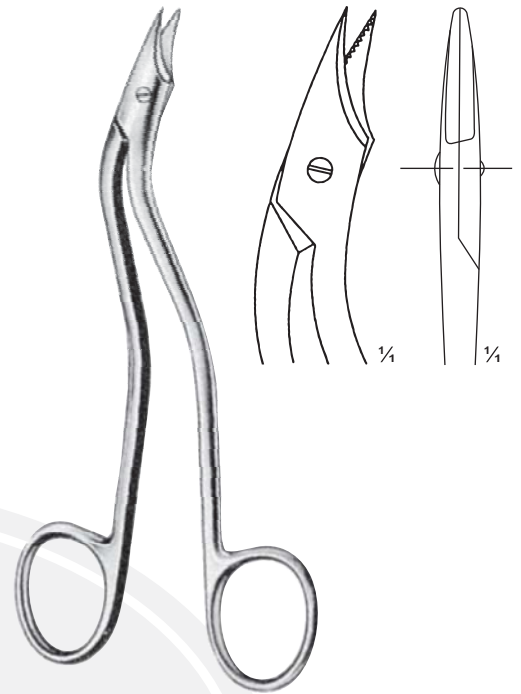

**HEATH**  
**306-559-150**  
15.0 cm, 6"



**DE BAKEY**



**306-562-160** 16.0 cm, 6 1/4"  
**306-563-190** 19.0 cm, 7 1/2"  
**306-564-230** 23.0 cm, 9"  
**306-565-280** 28.0 cm, 11"



**306-568-160** 16.0 cm, 6 1/4"  
**306-569-190** 19.0 cm, 7 1/2"  
**306-570-230** 23.0 cm, 9"  
**306-571-280** 28.0 cm, 11"

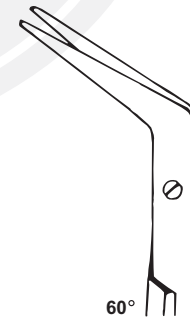

**306-575-160** 16.0 cm, 6 1/4"  
**306-576-190** 19.0 cm, 7 1/2"  
**306-577-230** 23.0 cm, 9"  
**306-578-280** 28.0 cm, 11"



## VASCULAR SCISSORS

Gefäßscheren

Tijeras vasculares

Ciseaux vasculaires

Forbici vascolari



### DEBAKEY-POTTS

**306-590-165** angled 20°  
**306-591-165** angled 45°  
**306-592-165** angled 60°  
16.5 cm, 6 1/2"



### DEBAKEY VASCULAR

**306-595-229** angled 25°  
**306-596-229** angled 45°  
**306-597-229** angled 60°  
**306-598-229** angled 45°  
22.9 cm, 9"



### LITWIN ANGLED

**306-604-184**  
18.4 cm, 7 1/4"  
Angled 45°



# VASCULAR SCISSORS

Gefäßscheren

Ciseaux vasculaires

Tijeras vasculares

Forbici vascolari

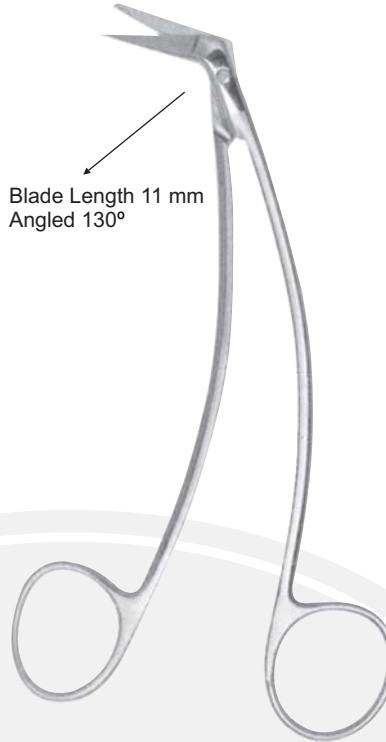

**COOLEY ARTERIOTOMY**  
306-607-184 18.4 cm, 7 1/4"  
306-608-229 22.9 cm, 9"  
306-609-273 27.3 cm, 11"

**SWEET ESOPHAGEAL**  
306-611-216  
21.6 cm, 8 1/2"

**FAVALORO CORONARY**  
306-614-171  
17.1 cm, 6 3/4"

**306-617-105**  
10.5 cm, 4"  
Angled 90°

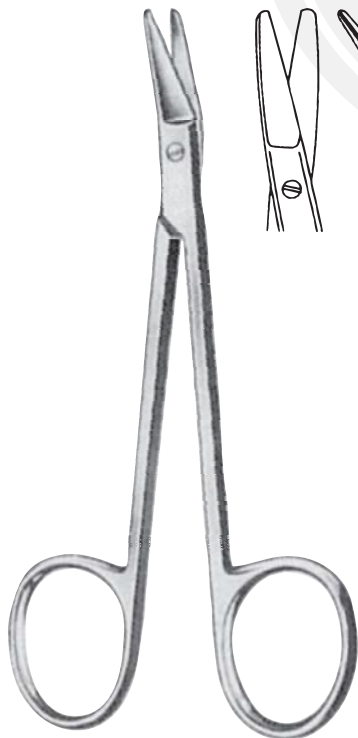

**306-620-105**  
10.5 cm, 4"

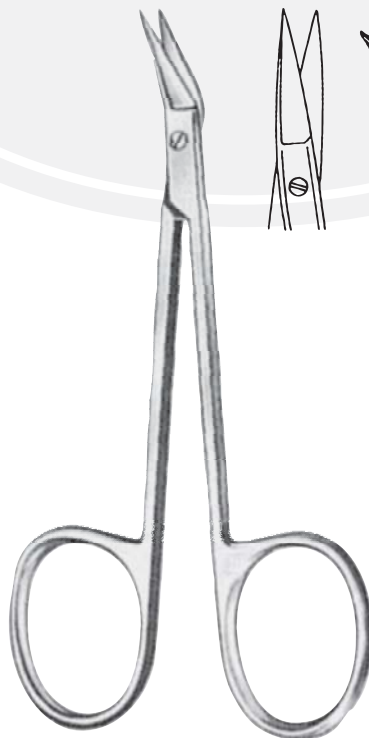

**306-623-100**  
10.0 cm, 4"

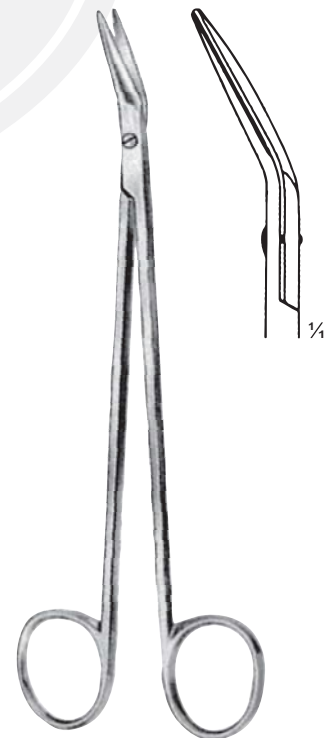

**CLASSON**  
306-626-170  
17.0 cm, 4"



## VASCULAR SCISSORS

Gefäßscheren

Tijeras vasculares

Ciseaux vasculaires

Forbici vascolari

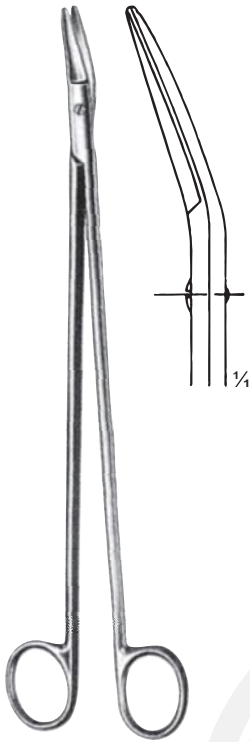

**FINOCHIETTO**  
306-630-270  
27.0 cm, 10 1/2"



**RESANO**  
306-633-250  
25.0 cm, 10"

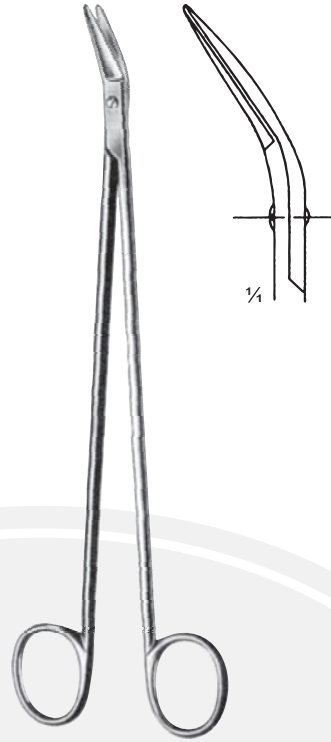

**POTTS-SMITH**  
306-636-195  
19.5 cm, 7 3/4"

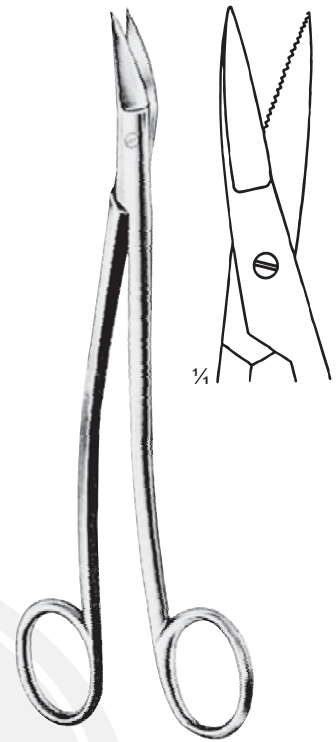

**ENT-DEAN**  
306-639-170  
17 cm, 6 3/4"  
Serrated



**COOLEY CARDIOVASCULAR**  
306-642-191 19.1 cm, 7 1/2"  
306-643-229 22.9 cm, 9"  
Curved



**CRAFOORD LOBECTOMY**  
306-646-305  
30.5 cm, 12"  
curved



**NELSON LUNG  
DISSECTING**  
306-649-229 Straight  
306-650-229 Curved  
22.9 cm, 9"



# VASCULAR SCISSORS

Gefäßscheren

Ciseaux vasculaires

Tijeras vasculares

Forbici vascolari



## MAYO-HARRINGTON DISSECTING

- 306-658-229 22.9 cm, 9" Straight.
- 306-659-279 27.9 cm, 11" Straight.
- 306-660-229 22.9 cm, 9" Curved.
- 306-661-279 27.9 cm, 11" Curved.



## TOENIS DISSECTING

- 306-664-184 Straight
- 18.4 cm, 7 1/4"
- 306-665-181 Curved.
- 18.1 cm, 7"
- Delicate

Blade Length  
2.9 cm



## DEMARTEL VASCULAR

- 306-668-171 17.1 cm, 6 3/4" Curved.
- 306-669-197 19.7 cm, 8" Straight.
- 306-670-171 17.1 cm, 6 3/4" Straight.



## DEBAKEY ENDARTERECTOMY

- 306-673-178
- 17.8 cm, 7"
- curved



## CARDIOVASCULAR

- 306-676-121
- 12.1 cm, 4 3/4"
- curved



## MORSE SCISSORS

- 306-679-178
- 17.8 cm, 7"
- curved



## LITWAK GENERAL UTILITY

- 306-682-117
- 11.7 cm, 4 3/4"



# VASCULAR SCISSORS

Gefäßscheren

Tijeras vasculares

Ciseaux vasculaires

Forbici vascolari



**306-685-115**  
11.5 cm, 4 1/2"

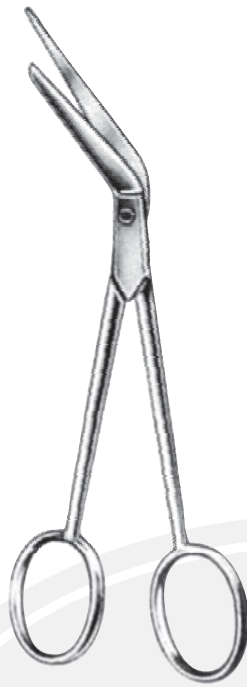

**306-688-145**  
14.5 cm, 5 3/4"



**306-691-145**  
14.5 cm, 5 3/4"

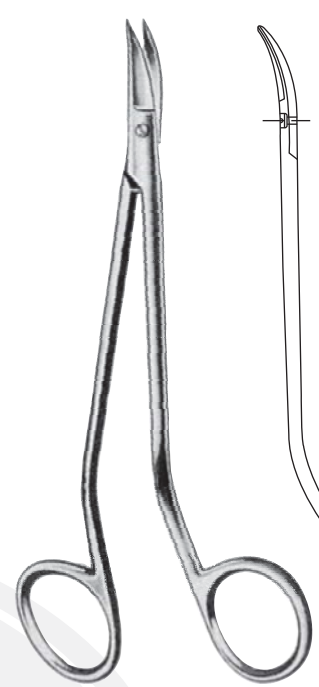

**NEUMANN**  
**306-694-125**  
12.5 cm, 5"

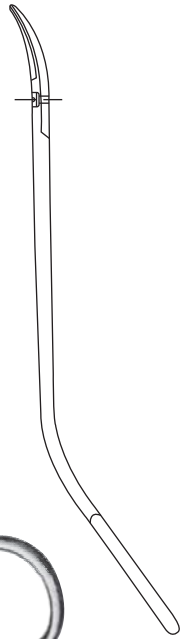

**STRULLY**  
**306-697-220**  
22.0 cm, 8 3/4"



**STRULLY**  
**306-700-220**  
22.0 cm, 8 3/4"

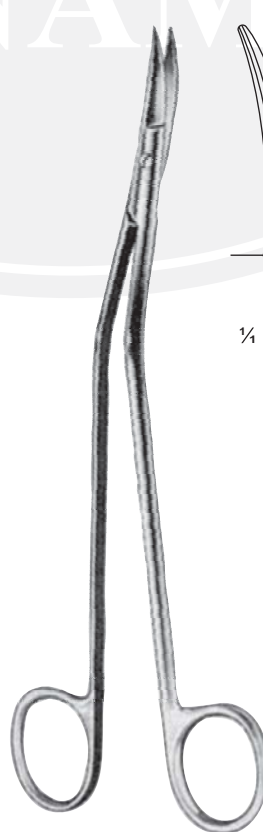

**DANDY**  
**306-703-170**  
17.0 cm, 6 3/4"



**FAVALORO**  
**306-706-150**  
15.0 cm, 6"







# VASCULAR SCISSORS

Gefäßscheren

Tijeras vasculares

Ciseaux vasculaires

Forbici vascolari

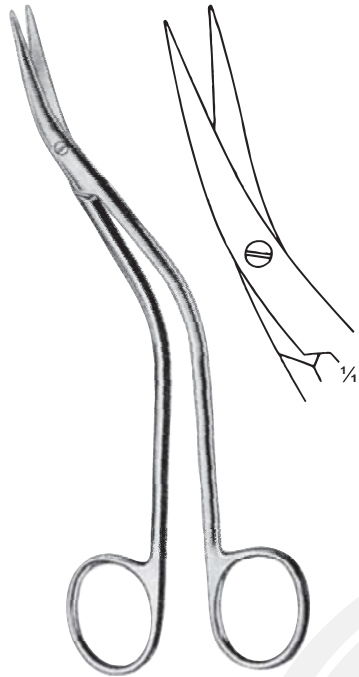

**DE BAKEY**  
306-709-155  
15.5 cm, 6"

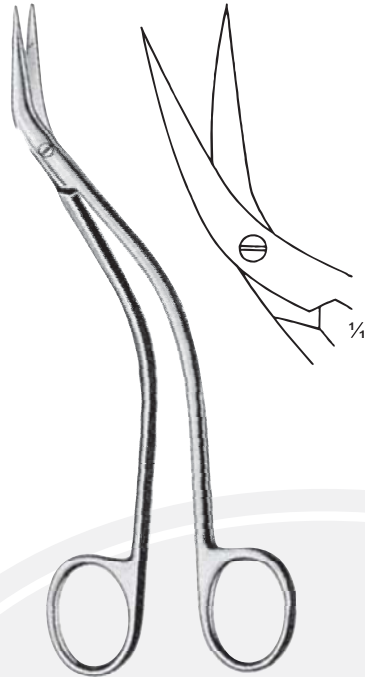

**DE BAKEY**  
306-711-155  
15.5 cm, 6"



**SCHMIEDEN-TAYLOR**  
306-713-145 14.5 cm, 5 3/4"  
306-714-175 17.5 cm, 6 3/4"

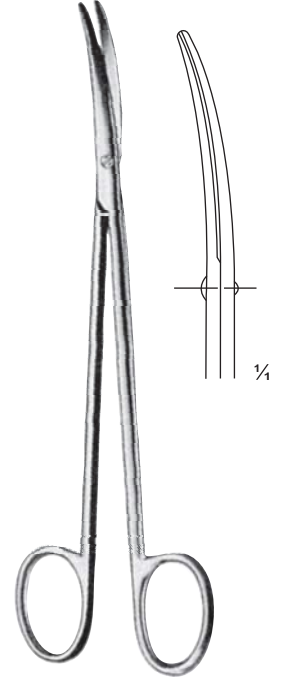

**TOENNIS-ADSON**  
306-717-175  
17.5 cm, 6 3/4"

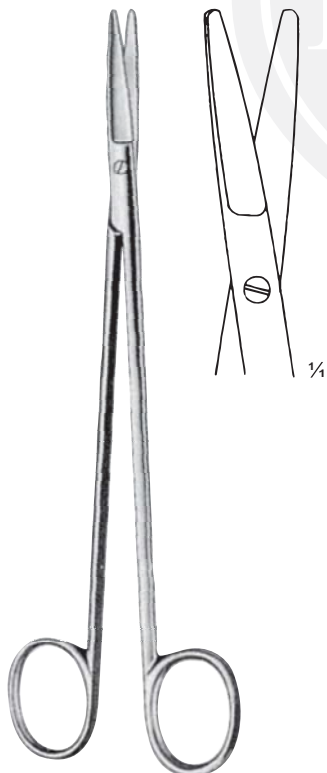

**TOENNIS**  
306-719-180  
18.0 cm, 7"



**TOENNIS**  
306-721-180  
18.0 cm, 7"



**QUINBY**  
306-723-120  
12.0 cm, 4 3/4"

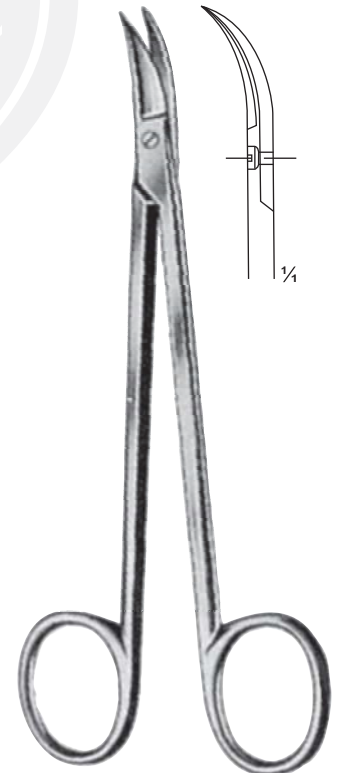

**QUINBY**  
306-725-120  
12.0 cm, 4 3/4"



# VASCULAR SCISSORS

Gefäßscheren

Tijeras vasculares

Ciseaux vasculaires

Forbici vascolari



**KLINKENBERGH-LOTH**  
306-728-230  
23.0 cm, 9"



**SATINSLY**  
306-731-245  
24.5 cm, 9 3/4"

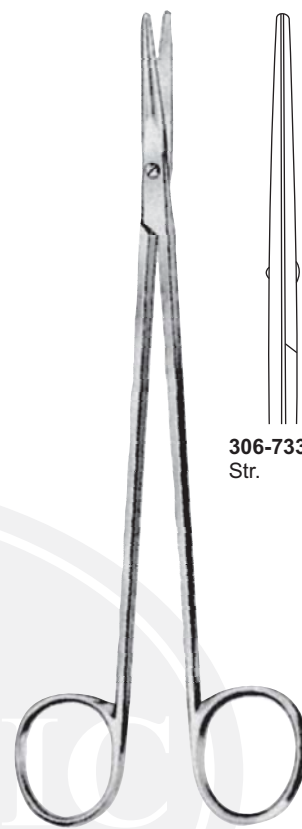

**LINCOLE**  
17.0 cm, 6 3/4"

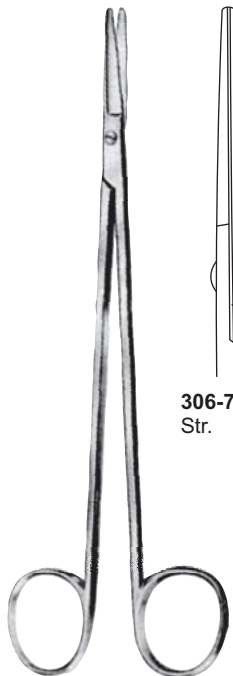
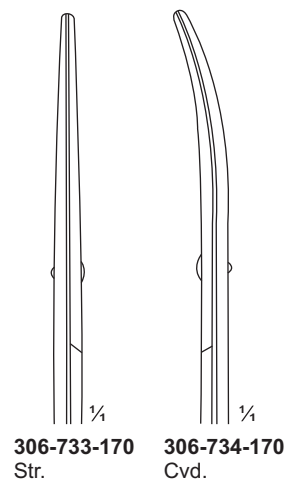

**CHURCH**  
17.0 cm, 6 3/4"

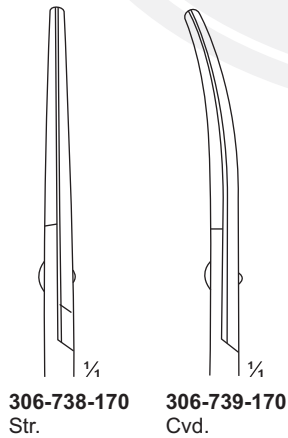

**OLIVECRONA**  
306-742-230  
23.0 cm, 9"



# VASCULAR, ENTEROTOMY SCISSORS

Gefäßscheren, Darmscheren

Ciseaux vasculaires, Ciseaux-entérotomes

Tijeras vasculares, Tijeras para intestino

Forbici vascolari, Forbici per enterotomia

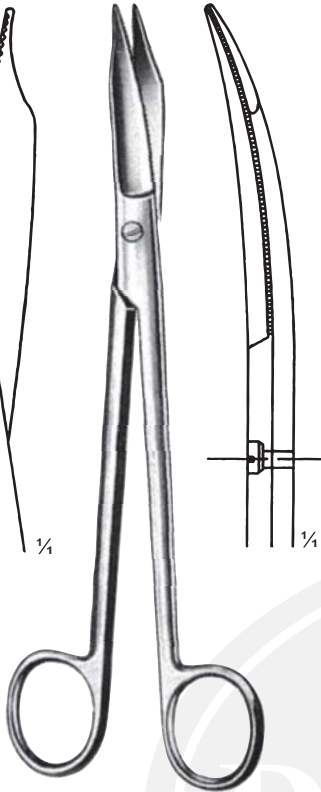
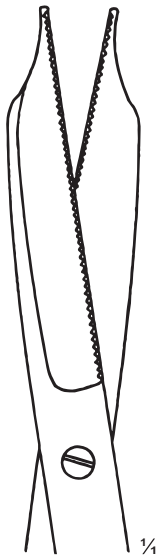

**MARTIN-CARTILAGE**  
306-745-200  
20.0 cm, 8"



**MC INDOE**  
306-748-190  
19.0 cm, 7 1/2"

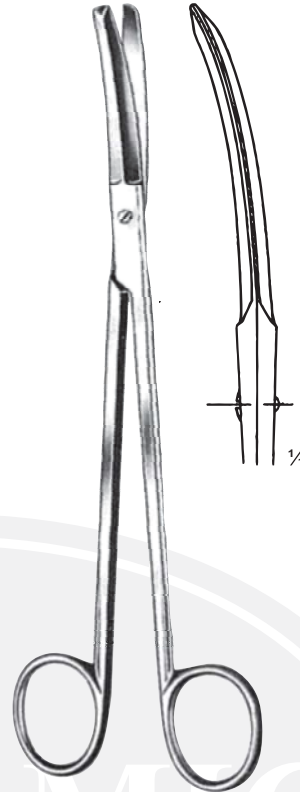

**POTTS-SMITH**  
306-751-190  
19.0 cm, 7 1/2"

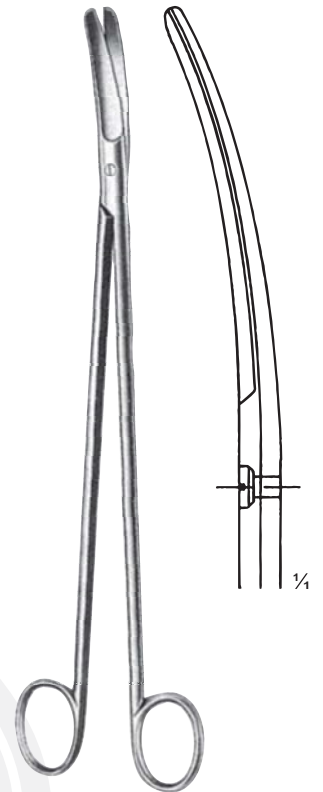

**CRAFOORD**  
306-753-300  
30.0 cm, 11 3/4"



**ENTEROTOMY**  
306-756-210  
21.0 cm, 8 1/4"



**ENTEROTOMY**  
306-759-210  
21.0 cm, 8 1/4"

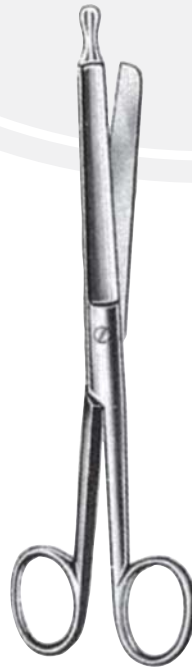

**ENTEROTOMY**  
306-761-210  
21.0 cm, 8 1/4"



**DISSECTING**  
306-763-110 11.5 cm, 4 1/4"  
306-764-130 13.0 cm, 5"  
306-765-140 14.0 cm, 5 1/2"



**DISSECTING**  
306-768-110 11.5 cm, 4 1/4"  
306-769-130 13.0 cm, 5"  
306-770-140 14.0 cm, 5 1/2"



# TONSIL, NASAL SCISSORS

Tonsillenscheren, Nasenscheren

Ciseaux pour less amygdales, Ciseaux nasaux

Tijeras para amigdalas, Tijeras nasales

Forbici per tonsille, Forbici nasali



**HEYMANN**  
306-773-180  
18 cm, 7"



**HEYMANN**  
306-776-195  
19.5 cm, 7 3/4"



**KNIGHT**  
306-779-180  
18.0 cm, 7"

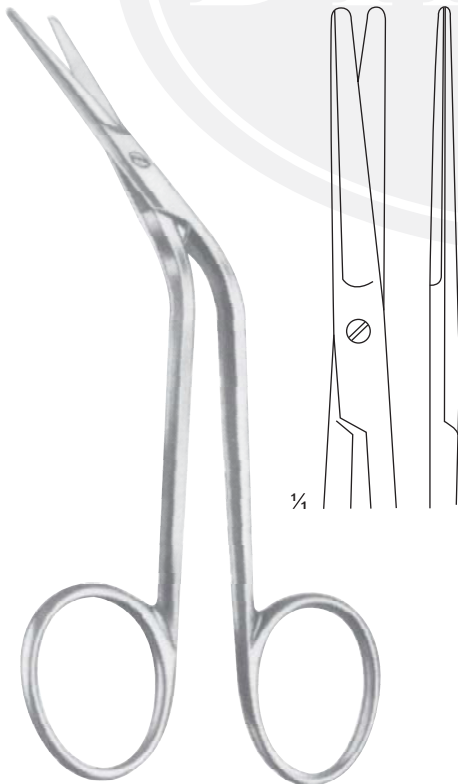

**COTTLE**  
306-782-160  
16 cm 6 1/4"

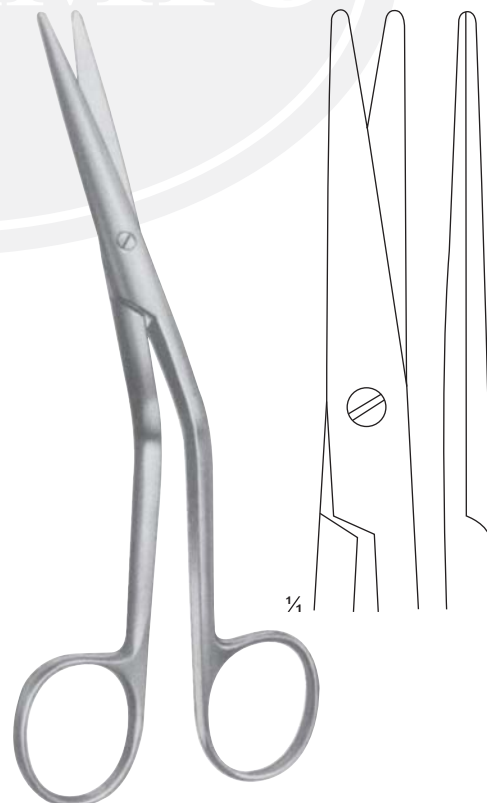

**FOMON**  
306-785-145  
14.5 cm 5 1/2"



# GUM, OPERATING SCISSORS

Zahnfleischscheren, Chirurgische Scheren

Tijeras para encías, Tijeras quirúrgicas

Ciseaux à gencives, Ciseaux chirurgicaux

Forbici per gengiva, Forbici per chirurgia



**GOOD**  
306-788-190  
19.0 cm, 7 1/2"



**PRINCE**  
306-790-175  
17.5 cm, 6 3/4"

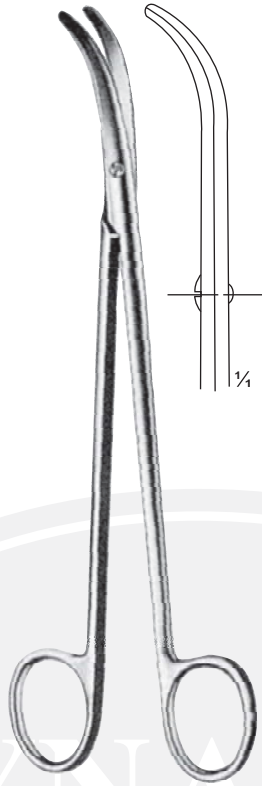

**HALLE**  
306-793-190  
19.0 cm, 7 1/2"

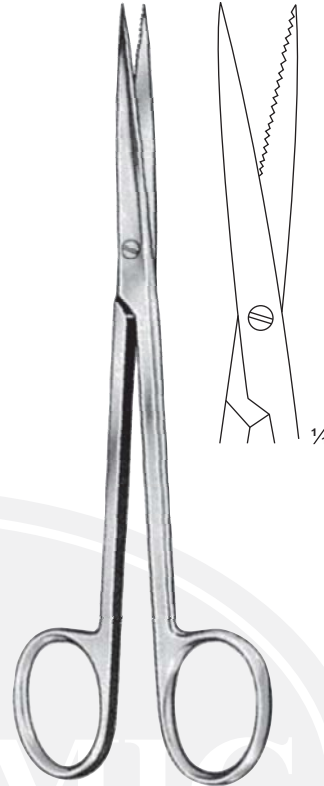

**SULLIVAN**  
306-796-145  
14.5 cm, 5 3/4"

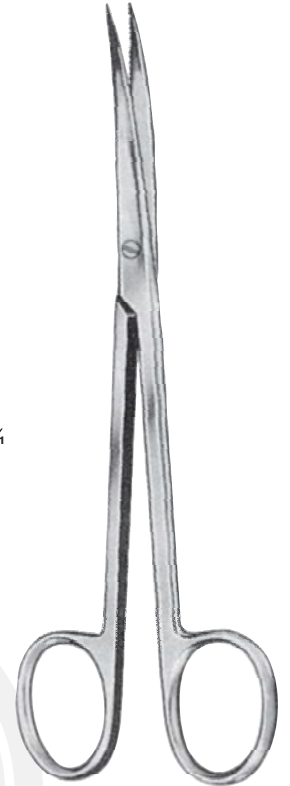

**SULLIVAN**  
306-799-145  
14.5 cm, 5 3/4"



**WAGNER  
GUM SCISSORS**  
12.0 cm, 4 3/4"

Straight



306-802-120  
B/B



306-805-120  
S/B



306-808-120  
S/S

Curved



306-811-120  
B/B



306-814-120  
S/B



306-817-120  
S/S

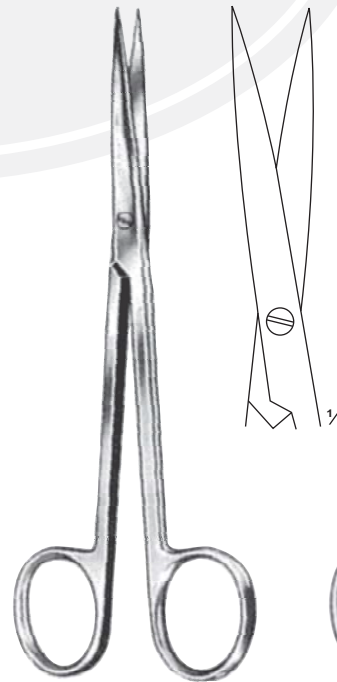

**BROPHY (SULLIVAN)**  
306-820-140  
14.0 cm, 5 1/2"  
Str.

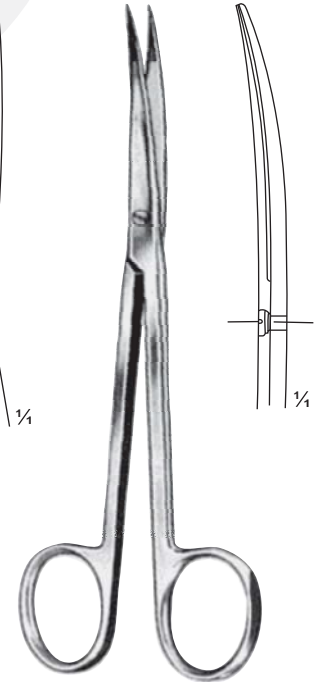

**BROPHY (SULLIVAN)**  
306-823-140  
14.0 cm, 5 1/2"  
Cvd.



# OPERATING SCISSORS

Chirurgische scheren

Ciseaux chirurgicaux

Tijeras quirúrgicas

Forbici per chirurgia



**OPERATING FINE**  
306-825-120 Straight  
306-826-120 Curved  
12 cm, 4 3/4"

**306-829-140**  
14.0 cm, 5 1/2"

**306-831-105**  
10.5 cm, 4"  
**306-832-115**  
11.5 cm, 4 1/2"

**306-835-105**  
10.5 cm, 4"  
**306-836-115**  
11.5 cm, 4 1/2"

**306-839-115**  
11.5 cm, 4 1/2"



**WALTON**  
306-841-100  
10.0 cm, 4"

**MOD. BONN**  
306-844-080  
8.0 cm, 3"

**MOD. BONN**  
306-846-080  
8.0 cm, 3"

**LANDOLT**  
306-848-125  
12.5 cm, 5"



# GUM & STITCH SCISSORS

Zahnfleischscheren, Fadenscheren,

Ciseaux à gencives, Ciseaux à ligatures,

Tijeras para encías, Tijeras para hilos,

Forbici per gengiva, Forbici per legature,



**LANDOLT**  
306-851-125  
12.5 cm, 5"

**LANDOLT**  
306-853-125  
12.5 cm, 5"

**LANDOLT**  
306-856-125  
12.5 cm, 5"

**SCHOEMAKER-LOTH**  
306-859-125  
12.5 cm, 5"

**EISELSBERG**  
306-862-110  
11.0 cm, 4 1/4"



**CHADWICK**  
306-865-110  
11 cm, 4 1/4"

**HARVEY**  
306-868-125  
12.5 cm, 5"  
Saw Edge

**ROUND CUT**  
306-871-235  
23.5 cm, 9"

**LE GRANGE**  
306-874-110  
11 cm, 4 1/4"



# STITCH SCISSORS

Fadenscheren

Tijeras para hilos

Ciseaux à ligatures

Forbici per legature

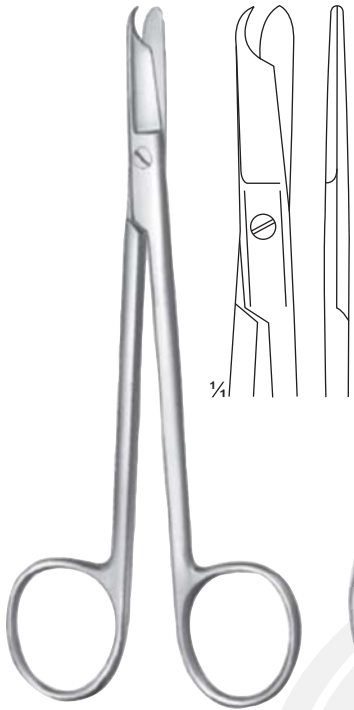

**SPENCER**  
306-877-090  
9 cm, 3 1/2"

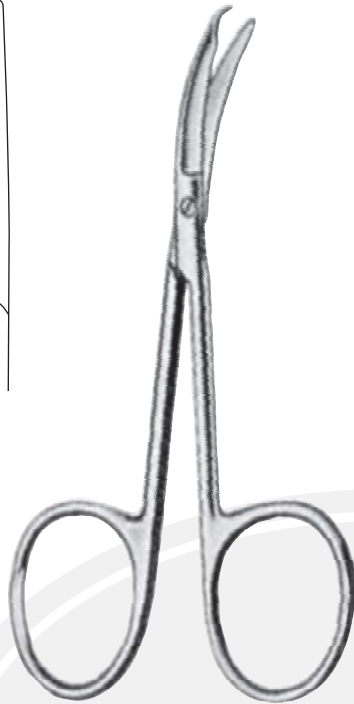

**SHORTBENT**  
306-880-090  
9 cm, 3 1/2"



**SPENCER / DELICATE**  
306-882-110  
11 cm, 4 1/2"



**306-885-115**  
11.5 cm, 4 3/4"

**Saw Edge**



**306-888-120**  
12.0 cm, 4 3/4"



**NORTHBENT**  
306-891-125  
12.5 cm, 5"



**LITTAUER**  
306-894-140  
14 cm, 5 1/2"

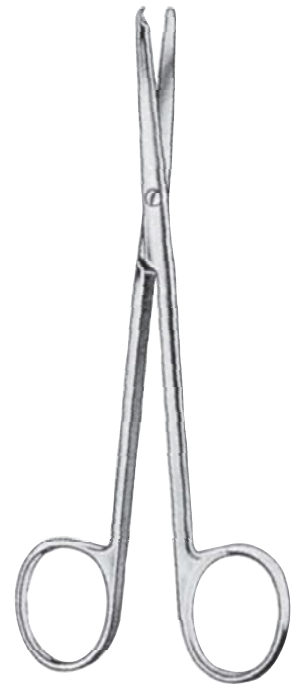

**BUCK**  
306-896-145 14.5 cm, 5 3/4"  
306-897-180 18.0 cm, 7"





## WIRE CUTTING SCISSORS

Drahtscheren

Tijeras para alambres

Cisailles à fils

Forbici per filo metallico

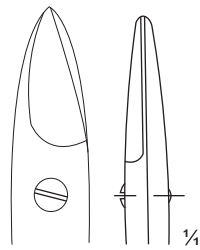

Saw Edge

**BEEBEE**  
306-899-120  
12.0 cm, 4 ¾"

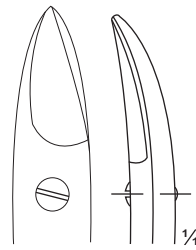

Saw Edge

**BEEBEE**  
306-900-120  
12.0 cm, 4 ¾"



**BEEBEE**  
306-902-105  
10.5 cm, 4"



**306-904-090**  
9.0 cm, 3 ½"



**306-906-090**  
9.0 cm, 3 ½"



**306-908-110**  
11.0 cm, 4 ¼"



**306-910-110**  
11.0 cm, 4 ¼"



# WIRE CUTTING SCISSORS

Drahtscheren

Tijeras para alambres

Cisailles à fils

Forbici per filo metallico

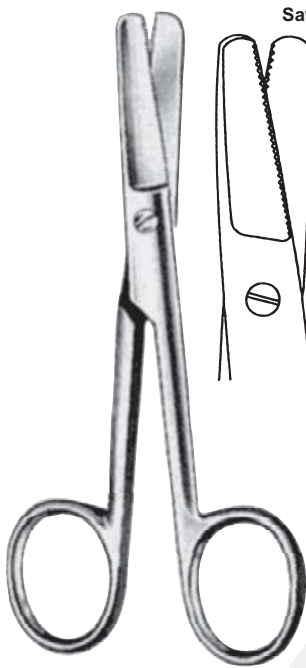

**HARVEY**  
306-912-125  
12.5 cm, 5"

Saw Edge

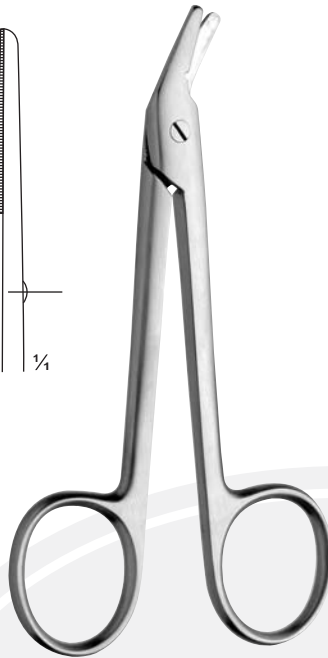
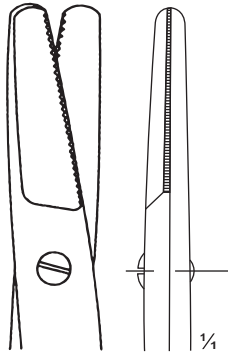

**WIRE CUTTING**  
306-914-115  
11.5 cm, 4 1/2"



**SCHUKNECHT**  
306-916-100  
10.0 cm, 4"

Saw Edge

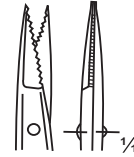

**306-918-110**  
11.0 cm, 4 1/4"



**SMITH**  
306-920-175  
17.5 cm, 6 3/4"



**BEEBEE**  
10.5 cm, 4"  
Straight

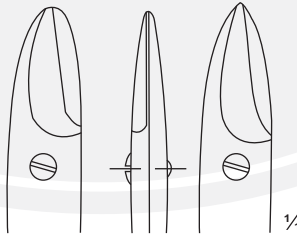

Blunt  
306-922-105

Pointed  
306-921-105



**BEEBEE**  
10.5 cm, 4"  
Curved

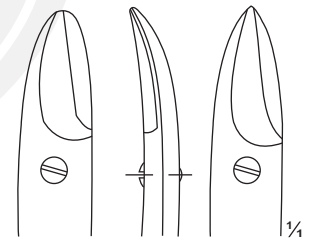

Blunt  
306-923-105

Pointed  
306-924-105



# SCISSORS

scheren

Ciseaux

Tijeras

Forbici



**NAIL SCISSORS**  
**306-926-090**  
9 cm, 3 1/2"  
Curved



**NAIL SCISSORS**  
**306-928-090**  
9 cm, 3 1/2"  
Curved



**NAIL SCISSORS**  
**306-930-090**  
9 cm, 3 1/2"  
Arrow Point  
Curved



**306-932-090**  
9.0 cm, 3 1/2"  
**306-933-105**  
10.5 cm, 4"

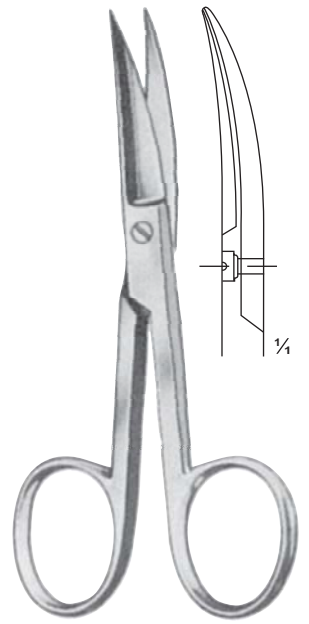

**306-935-090**  
9.0 cm, 3 1/2"  
**306-936-105**  
10.5 cm, 4"



**306-938-090**  
9.0 cm, 3 1/2"  
**306-939-105**  
10.5 cm, 4"

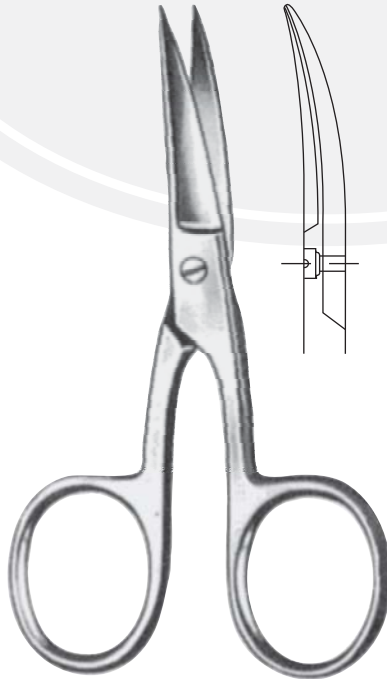

**306-941-090**  
9.0 cm, 3 1/2"  
**306-942-105**  
10.5 cm, 4"



**306-944-090**  
9.0 cm, 3 1/2"  
**306-945-105**  
10.5 cm, 4"



**306-947-130**  
13.0 cm, 5"  
**306-948-155**  
15.5 cm, 6"



# MICRO SCISSORS

Mikroscheren

Micro scissors

Micro-Ciseaux

Micro-Forbici

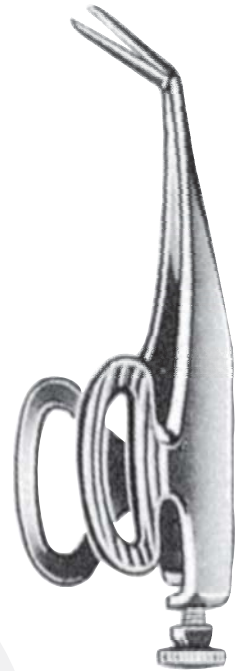
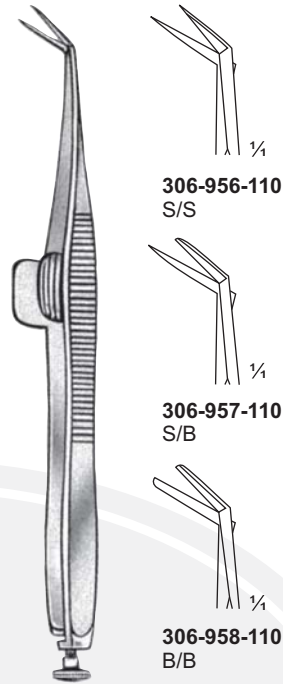
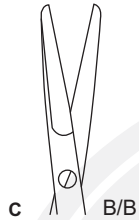
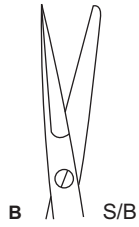
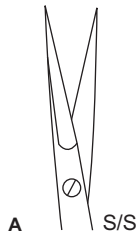

**NOYES**  
A 306-950-120  
B 306-951-120  
C 306-952-120  
12 cm, 4 3/4"

**NOYES**  
306-954-120  
12 cm, 4 3/4"

**WECKER**  
11.0 cm, 4 1/4"

**BARRAQUER**  
306-960-055  
306-961-055  
306-962-055  
5.5 cm, 2 1/4"

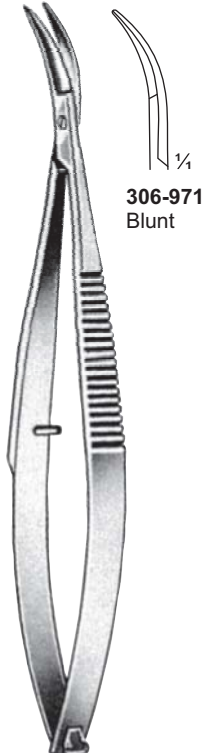
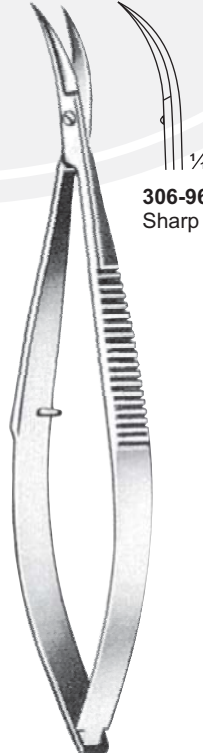

**306-964-090**  
B/B

**306-965-090**  
B/B

**306-969-100**  
Sharp

**306-971-100**  
Blunt

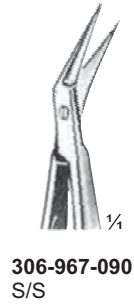
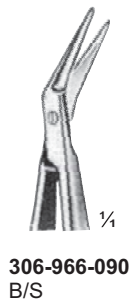

**306-966-090**  
B/S

**306-967-090**  
S/S

**CASTROVIEJO**  
9.0 cm, 3 1/2"

**CASTROVIEJO**  
10.0 cm, 4"

**CASTROVIEJO**  
10.0 cm, 4"



# MICRO SCISSORS

Mikroscheren

Micro scissors

Micro-Ciseaux

Micro-Forbici



**WESTCOTT**  
306-973-110  
11.0 cm, 4 1/4"



**WESTCOTT**  
306-975-110  
11.0 cm, 4 1/4"



**CASTROVIEJO**  
306-977-100  
10.0 cm, 4"

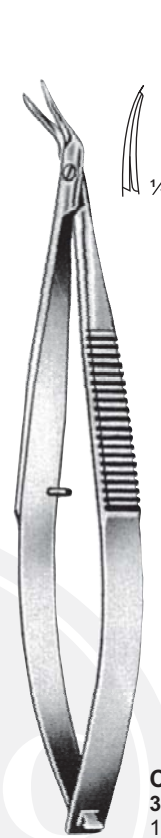

**CASTROVIEJO**  
306-979-100  
10.0 cm, 4"

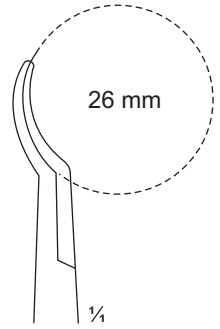

**CASTROVIEJO**  
306-981-110  
11.0 cm, 4 1/4"

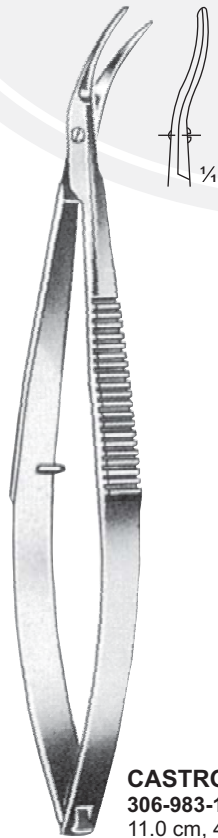

**CASTROVIEJO**  
306-983-110  
11.0 cm, 4 1/4"

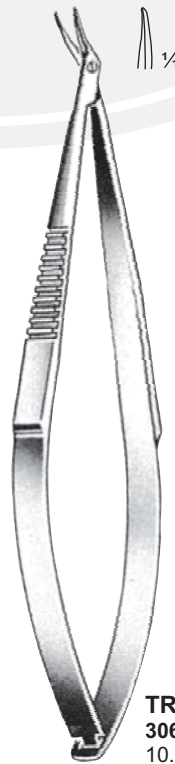

**TROUTMAN**  
306-985-100  
10.0 cm, 4"



**TROUTMAN**  
306-987-100  
10.0 cm, 4"



# MICRO SCISSORS

Mikroscheren

Micro scissors

Micro-Ciseaux

Micro-Forbici



**NOYES**  
306-989-150  
15.0 cm, 6"



**306-991-145**  
14.5 cm, 5 3/4"



14 cm

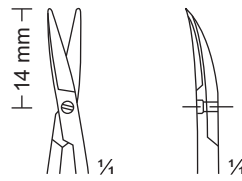

**DISSECTION**  
306-993-140

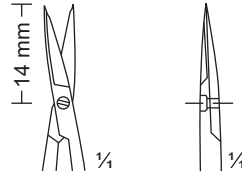

**ADVENTITIA**  
306-994-140

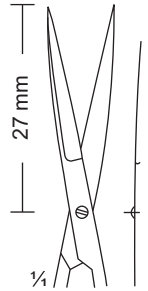

**MICRO SCISSOR**  
306-996-180  
18 cm, 7"



**306-998-120**  
12.0 cm, 4 3/4"



**WESTCOTT**  
306-1000-115  
11.5 cm, 4 1/2"



**WESTCOTT**  
306-1002-115  
11.5 cm, 4 1/2"



**WESTCOTT**



**306-1005-110** 11 cm, 4 1/4"  
Curved  
Sharp/Sharp  
**306-1006-110** 11 cm, 4 1/4"  
Curved-Micro  
Sharp/Sharp

**306-1007-110** 11 cm, 4 1/4"  
Curved  
Blunt/Blunt



# MICRO SCISSORS

Mikroscheren

Micro scissors

Micro-Ciseaux

Micro-Forbici



**306-1010-145**

14.5 cm, 5 3/4"

Str.

**306-1011-145**

14.5 cm, 5 3/4"

Cvd.



**306-1013-180**

18.0 cm, 7"



**306-1016-180**

18.0 cm, 7" Str.

**306-1017-180**

18.0 cm, 7" Cvd.



**DISSECTION**

**306-1019-180**

18 cm, 7" B/B

**ADVENTITIA**

**306-1020-180**

18 cm, 7" S/S

18 cm, 7"



# MICRO SCISSORS

Mikroscheren

Micro scissors

Micro-Ciseaux

Micro-Forbici



11.0 cm, 4 1/4"

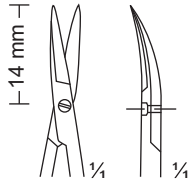

**DISSECTION**  
306-1023-110

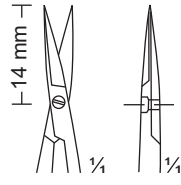

**ADVENTITIA**  
03-565-110



**DISSECTING SCISSORS**  
306-1026-110  
11 cm, 4 1/4"

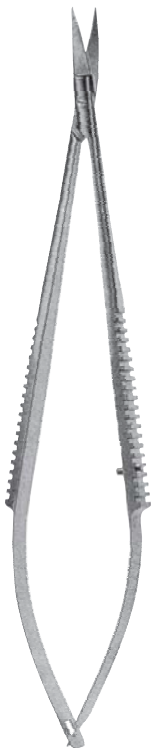

15.0 cm, 6"

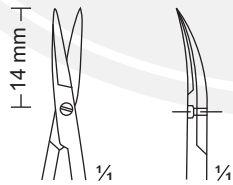

**DISSECTION**  
306-1029-150

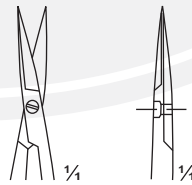

**ADVENTITIA**  
306-1030-150

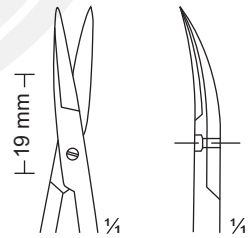

**DISSECTION**  
306-1031-150

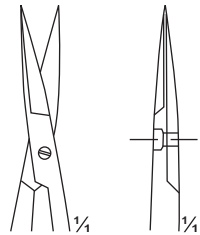

**ADVENTITIA**  
306-1032-150

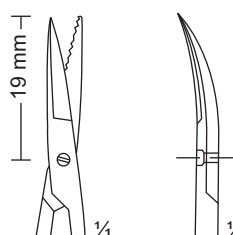

**DISSECTION**  
306-1033-150

-Nerve-

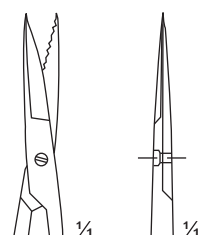

**ADVENTITIA**  
306-1034-150

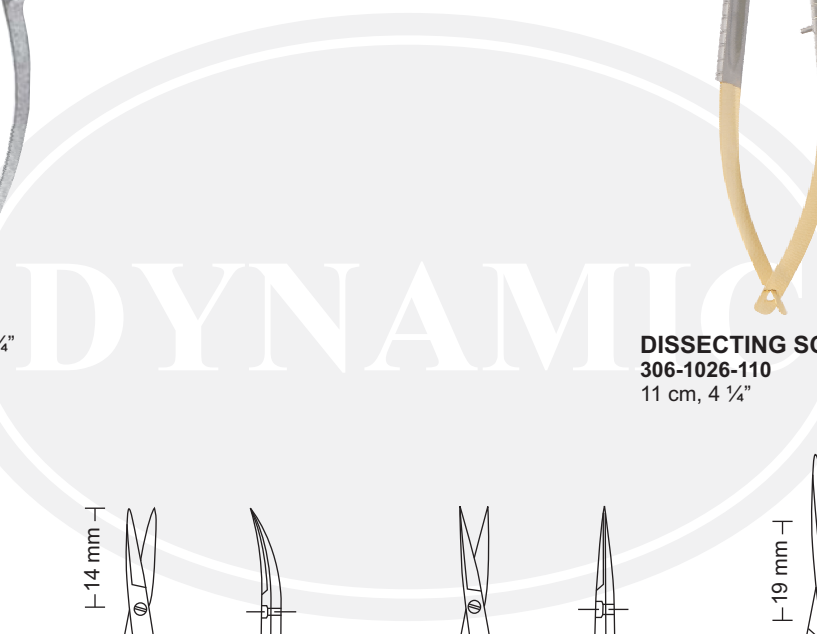





# MICRO SCISSORS

Mikroscheren

Micro scissors

Micro-Ciseaux

Micro-Forbici



18.0 cm, 7"

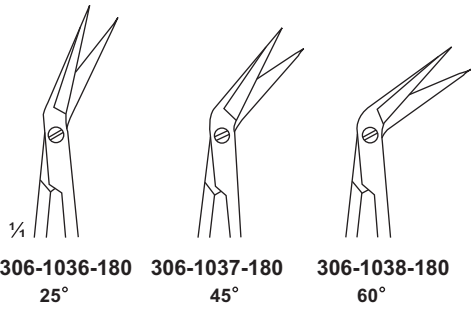

306-1036-180 25°  
306-1037-180 45°  
306-1038-180 60°

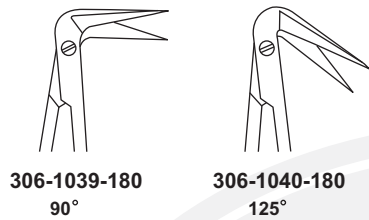

306-1039-180 90°  
306-1040-180 125°



18.0 cm, 7"

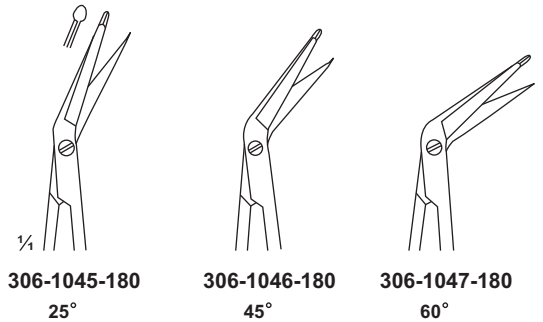

306-1045-180 25°  
306-1046-180 45°  
306-1047-180 60°

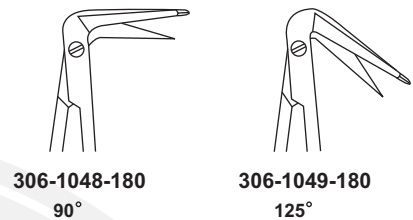

306-1048-180 90°  
306-1049-180 125°

DYNAMIC



18.5 cm, 7 1/4"

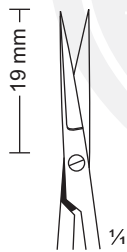

306-1055-185  
Str.



306-1056-185  
Cvd.



16 cm, 6 1/4"  
20 cm, 8"  
22 cm, 8 3/4"

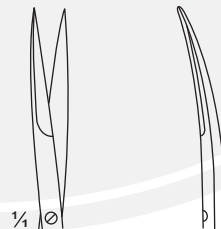

306-1060-160  
306-1061-200  
306-1062-220



306-1063-160  
306-1064-200  
306-1065-220



306-1066-160  
306-1067-200  
306-1068-220



306-1069-160  
306-1070-200  
306-1071-220



16 cm, 6 1/4"  
20 cm, 8"  
22 cm, 8 3/4"

306-1072-160  
306-1073-200  
306-1074-220



306-1075-160  
306-1076-200  
306-1077-220



# SCISSORS

scheren

Tijeras

Ciseaux

Forbici



**BABY METZENBAUM**  
306-1080-114  
11.4 cm, 4 1/2"  
straight

**BABY METZENBAUM**  
306-1084-114  
11.4 cm, 4 1/2"  
Curved

**IRIS**  
306-1088-090  
9.0 cm, 3 1/2"  
306-1089-114  
11.4 cm, 4 1/2"  
Straight

**IRIS**  
306-1095-090  
306-1096-090  
9.0 cm, 3 1/2"  
Curved

**IRIS**  
306-1100-114  
11.4 cm, 4 1/2"

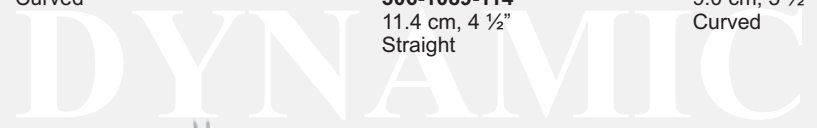

**SAFETY**  
306-1103-090 Straight  
306-1104-090 Curved  
9.0 cm, 3 1/2"



**GOLDMAN-FOX**  
306-1108-090 Straight  
306-1109-090 Curved  
9.0 cm, 3 1/2"



**STEVENS TENOTOMY**  
306-1112-090 Straight  
306-1113-090 Curved  
9.0 cm, 3 1/2"



**STEVENS TENOTOMY**  
306-1115-114 Straight  
306-1116-114 Curved  
11.4 cm, 4 1/2"



# SCISSORS

scheren

Tijeras

Ciseaux

Forbici



**STANDARD**  
**306-1120-140** 14 cm, 5 1/2"  
Straight



**STANDARD**  
**306-1123-140** 14 cm, 5 1/2"  
Curved



**METZENBAUM**  
**306-1126-140** 14 cm, 5 1/2"  
**306-1127-160** 16 cm, 6 1/4"  
**306-1128-180** 18 cm, 7"  
**306-1129-220** 20 cm, 8"  
**306-1130-230** 23 cm, 9"  
**306-1131-280** 28 cm, 11"  
**306-1132-300** 30 cm, 11 3/4"



**METZENBAUM**  
**306-1135-140** 14 cm, 5 1/2"  
**306-1136-180** 18 cm, 7"  
Straight



**METZENBAUM**  
**306-1139-140** 14 cm, 5 1/2"  
**306-1140-180** 18 cm, 7"  
Curved



**METZENBAUM**  
**306-1143-230** Straight  
**306-1144-230** Curved  
23 cm, 9"



**METZENBAUM**  
**306-1146-140**  
14 cm, 5 1/2"

DYNAMIC



# SCISSORS

scheren

Ciseaux

Tijeras

Forbici



### MAYO

- 306-1150-140 14 cm, 5 1/2"
- 306-1151-150 15 cm, 6"
- 306-1152-180 18 cm, 7"
- 306-1153-200 20 cm, 8"
- 306-1154-230 23 cm, 9"

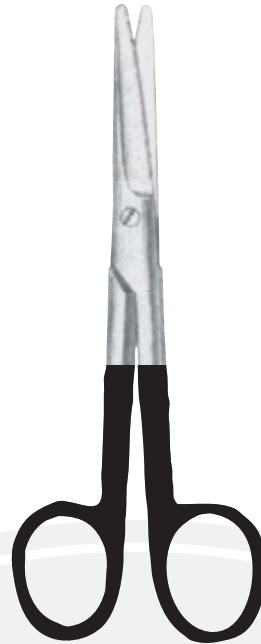

### MAYO

- 306-1158-140 14 cm, 5 1/2"
  - 306-1159-170 17 cm, 6 3/4"
- Straight



### MAYO

- 306-1162-140 14 cm, 5 1/2"
  - 306-1163-170 17 cm, 6 3/4"
- Curved



### MAYO

- 306-1165-230 23 cm, 9"
- Straight



### MAYO

- 306-1168-230 23 cm, 9"
- Curved



### JAMISON

- 306-1171-140 14.0 cm, 5 1/2"
  - 306-1172-178 17.8 cm, 7"
- Curved



### POTTS-SMITH

- 306-1175-178 Angled 25°
  - 306-1176-178 Angled 45°
  - 306-1177-178 Angled 60°
- 17.8 cm, 7"



# OPERATING SCISSORS

Chirurgische scheren

Ciseaux chirurgicaux

Tijeras quirúrgicas

Forbici per chirurgia



**STANDARD**

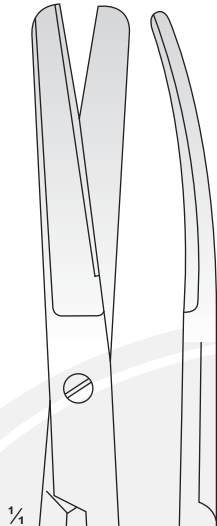

**306-1180-145**  
14.5 cm, 5 3/4" Straight  
**306-1181-145**  
14.5 cm, 5 3/4" Curved

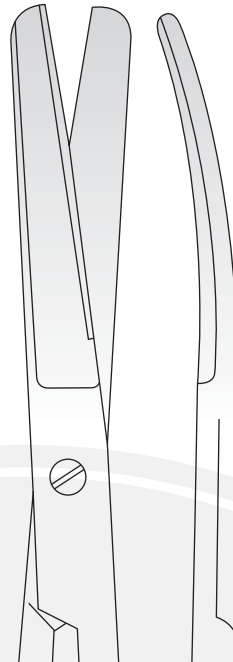

**306-1182-165**  
16.5 cm, 6 1/2" Straight  
**306-1183-165**  
16.5 cm, 6 1/2" Curved

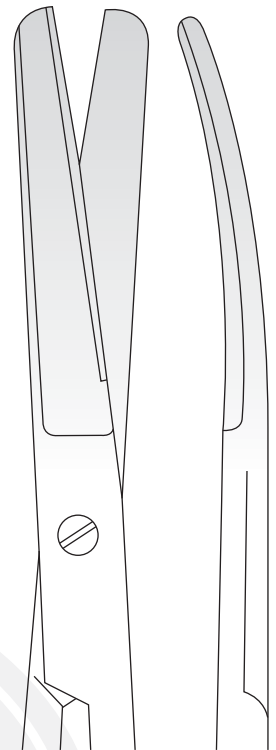

**306-1184-185**  
18.5 cm, 7 1/4" Straight  
**306-1185-185**  
18.5 cm, 7 1/4" Curved

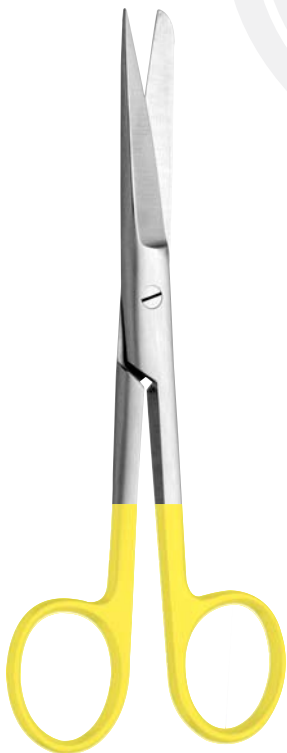

**STANDARD**

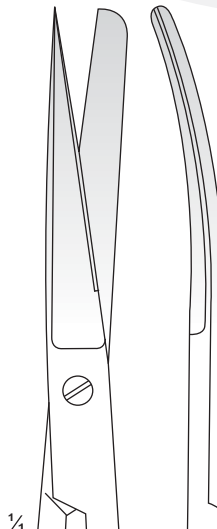

**306-1190-145**  
14.5 cm, 5 3/4" Straight  
**306-1191-145**  
14.5 cm, 5 3/4" Curved

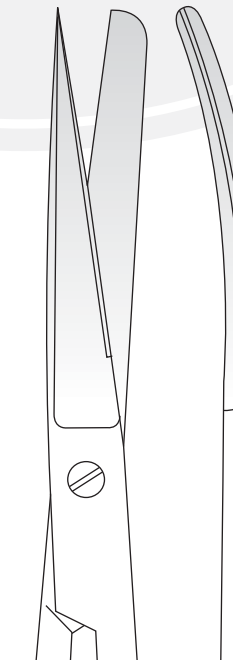

**306-1192-165**  
16.5 cm, 6 1/2" Straight  
**306-1193-165**  
16.5 cm, 6 1/2" Curved

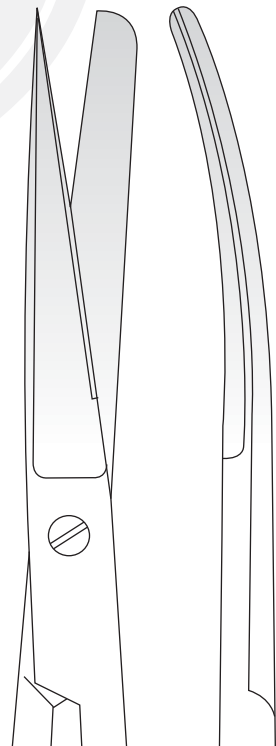

**306-1194-185**  
18.5 cm, 7 1/4" Straight  
**306-1195-185**  
18.5 cm, 7 1/4" Curved



# OPERATING SCISSORS

Chirurgische scheren

Ciseaux chirurgicaux

Tijeras quirúrgicas

Forbici per chirurgia

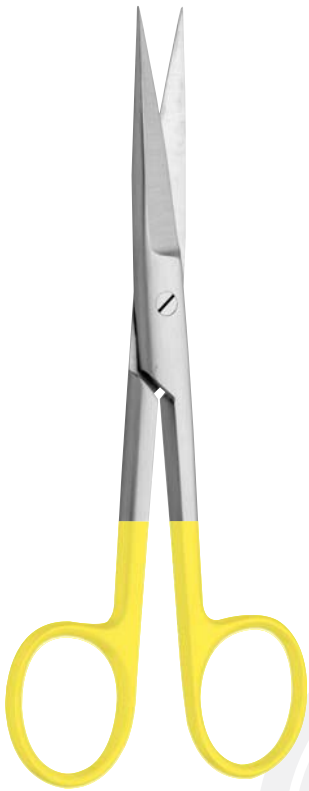

**STANDARD**

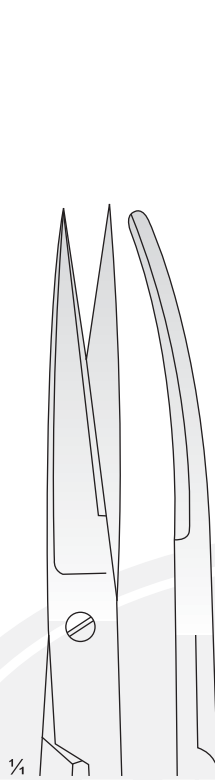

**306-1200-145**  
14.5 cm, 5 3/4" Straight  
**306-1201-145**  
14.5 cm, 5 3/4" Curved

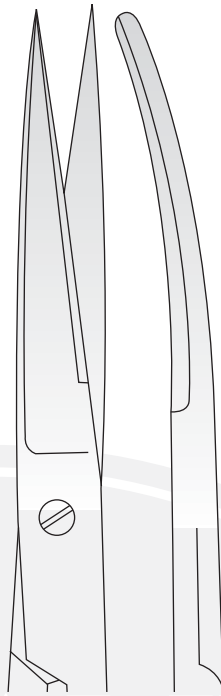

**306-1202-165**  
16.5 cm, 6 1/2" Straight  
**306-1203-165**  
16.5 cm, 6 1/2" Curved

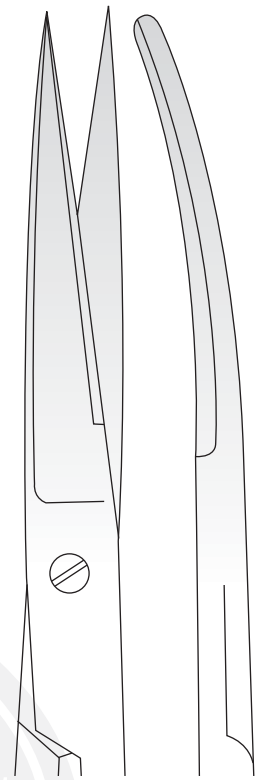

**306-1204-185**  
18.5 cm, 7 1/4" Straight  
**306-1205-185**  
18.5 cm, 7 1/4" Curved

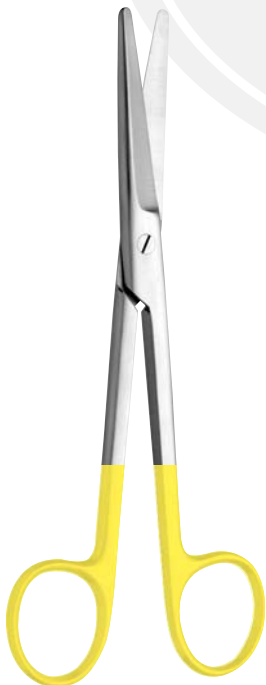

**MAYO**

**306-1209-140** 14 cm, 5 1/2"  
**306-1210-170** 17 cm, 6 3/4"  
**306-1211-230** 23 cm, 9"  
blunt/blunt

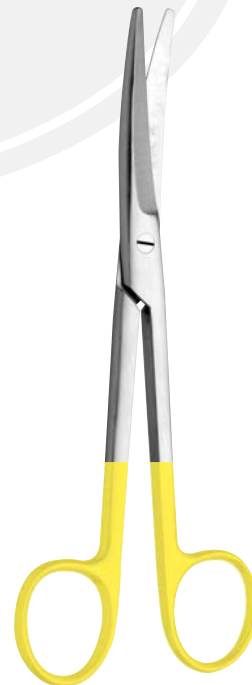
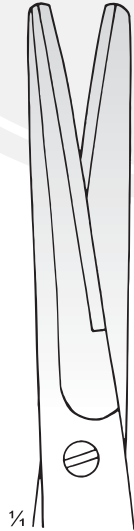

**MAYO**

**306-1215-140** 14 cm, 5 1/2"  
**306-1216-170** 17 cm, 6 3/4"  
**306-1217-230** 23 cm, 9"  
blunt/blunt, Cvd.





# OPERATING SCISSORS

Chirurgische scheren

Ciseaux chirurgicaux

Tijeras quirúrgicas

Forbici per chirurgia

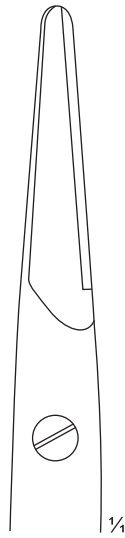
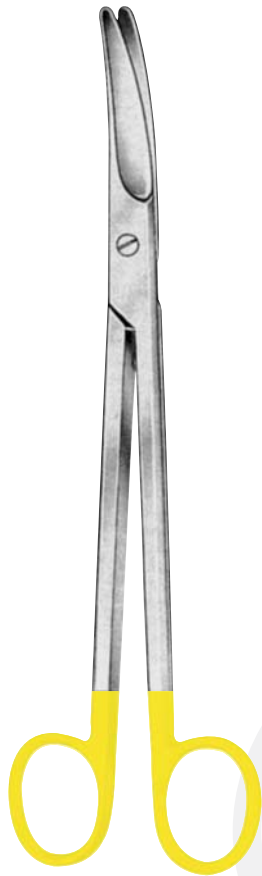

**306-1225-230**  
blunt/blunt, Str.



**306-1226-230**  
blunt/blunt, Cvd.

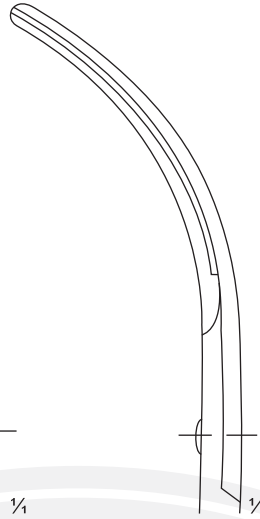

**306-1227-230**  
blunt/blunt, Full Cvd.

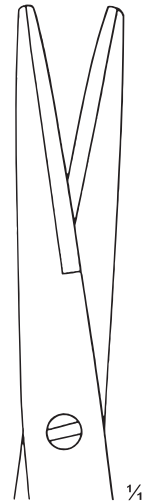

## MAYO-STILLE

**306-1230-150** 15 cm, 6"  
**306-1231-170** 17 cm, 6 3/4"  
blunt/blunt, Str.

## PARAMETRIUM

23 cm, 9"

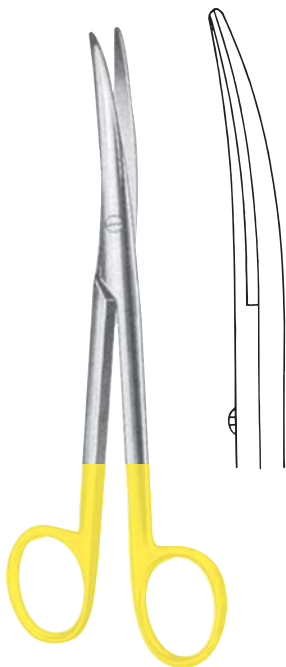

## MAYO-STILLE

**306-1234-150** 15 cm, 6"  
**306-1235-170** 17 cm, 6 3/4"  
blunt/blunt, Cvd.

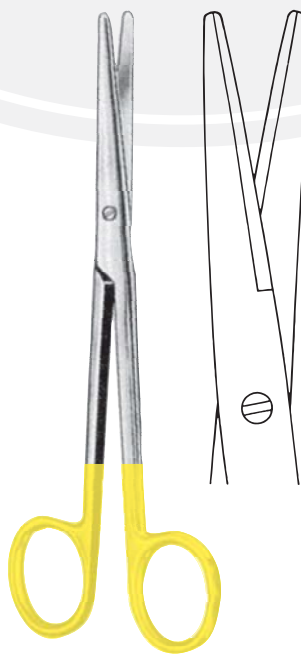

## LEXER

**306-1238-160** 16 cm, 6 1/4"  
**306-1239-215** 21.5 cm, 8 1/2"  
blunt/blunt, Str.



## LEXER

**306-1242-160** 16 cm, 6 1/4"  
**306-1243-215** 21.5 cm, 8 1/2"  
blunt/blunt, Cvd.



# OPERATING SCISSORS

Chirurgische scheren

Ciseaux chirurgicaux

Tijeras quirúrgicas

Forbici per chirurgia

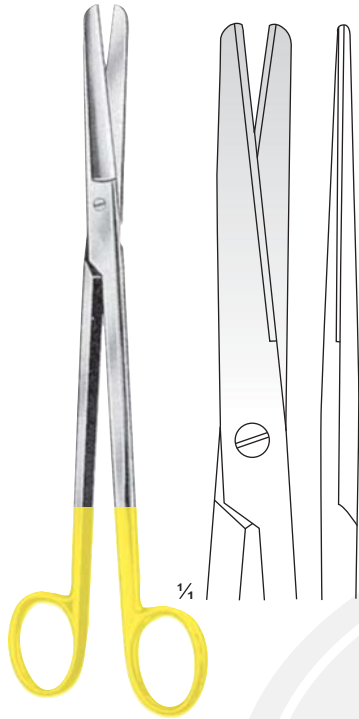

**SIMS**  
306-1246-230  
23.0 cm, 9"  
Straight



**SIMS**  
306-1248-230  
23.0 cm, 9"  
Curved

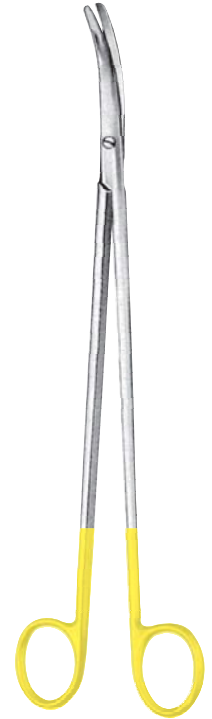

**CARDINALE**  
306-1251-280  
28.0 cm, 11"



**GOLDMAN-FOX**  
306-1254-130  
13.0 cm, 5"

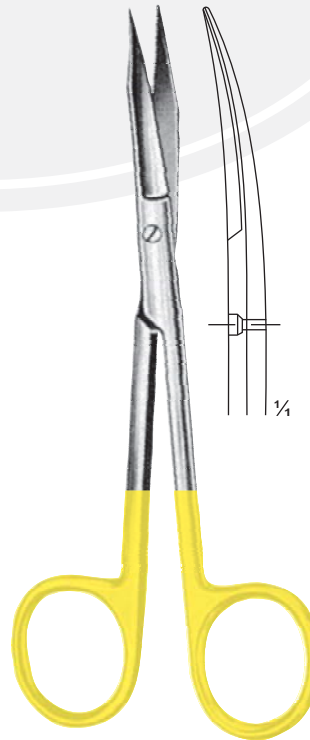

**GOLDMAN-FOX**  
306-1257-130  
13.0 cm, 5"





# DISSECTING SCISSORS

Präparierscheren

Ciseaux à dissection

Tijeras de disección

Forbici per dissezione



**METZENBAUM  
DELICATE**  
Blunt / Blunt  
Straight

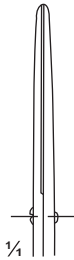

**306-1260-145**  
14.5 cm, 5 3/4"

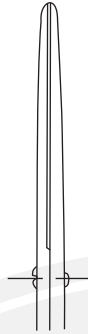

**306-1261-180**  
18.0 cm, 7"

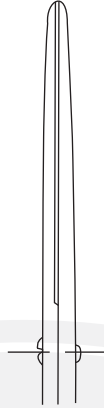

**306-1262-200**  
20.0 cm, 8"

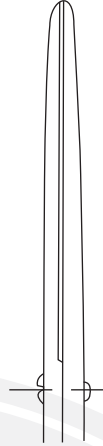

**306-1263-230**  
23.0 cm, 9"

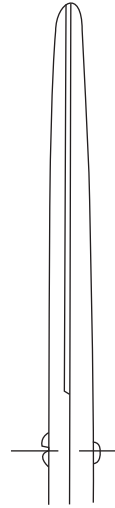

**306-1264-250**  
25.0 cm, 10"

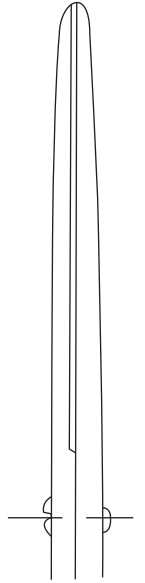

**306-1265-280**  
28.0 cm, 11"

# DYNAMIC

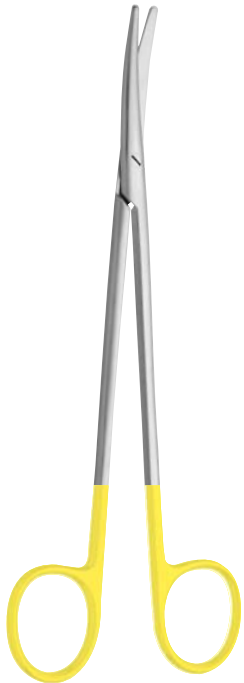

**METZENBAUM  
DELICATE**  
Blunt / Blunt  
Curved



**306-1270-180**  
14.5 cm, 5 3/4"

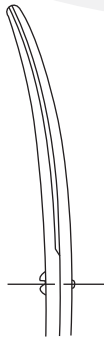

**306-1271-180**  
18.0 cm, 7"

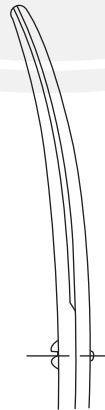

**306-1272-200**  
20.0 cm, 8"

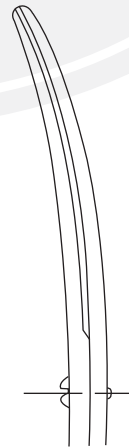

**306-1273-230**  
23.0 cm, 9"



**306-1274-250**  
25.0 cm, 10"



**306-1275-280**  
28.0 cm, 11"



# DISSECTING SCISSORS

Präparierscheren

Tijeras de disección

Ciseaux à dissection

Forbici per dissezione



**METZENBAUM  
DELICATE**  
Sharp / Sharp  
Straight

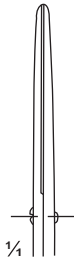

306-1278-145  
14.5 cm, 5 3/4"

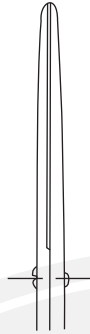

306-1279-180  
18.0 cm, 7"

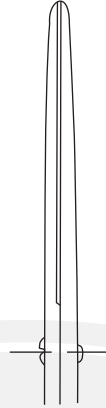

306-1280-200  
20.0 cm, 8"

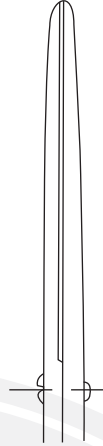

306-1281-230  
23.0 cm, 9"

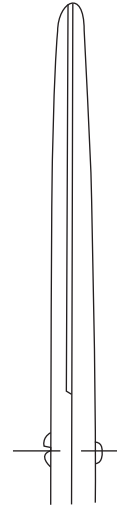

306-1282-250  
25.0 cm, 10"

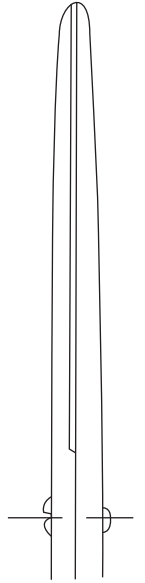

306-1283-280  
28.0 cm, 11"

# DYNAMIC



**METZENBAUM  
DELICATE**  
Sharp / Sharp  
Curved



306-1288-180  
14.5 cm, 5 3/4"

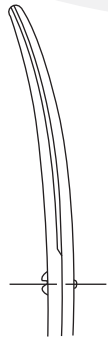

306-1289-180  
18.0 cm, 7"

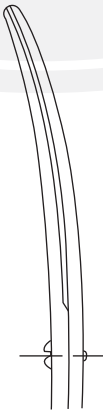

306-1290-200  
20.0 cm, 8"

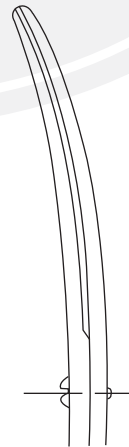

306-1291-230  
23.0 cm, 9"

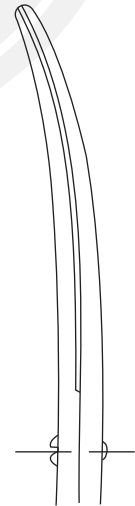

306-1292-250  
25.0 cm, 10"

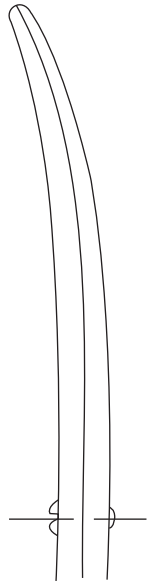

306-1293-280  
28.0 cm, 11"



# OPERATING, DISSECTING SCISSORS

Chirurgische scheren, Präparierscheren

Ciseaux chirurgicaux, Ciseaux à dissection

Tijeras quirúrgicas, Tijeras de disección

Forbici per chirurgia, Forbici per dissezione

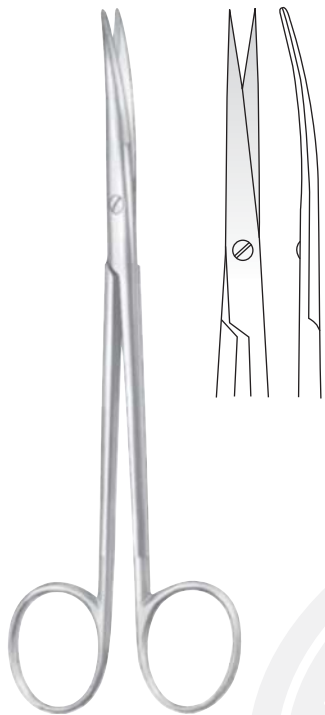

**METZENBAUM-LAHEY**  
**306-1296-140** 14.0 cm, 5 1/2" Sharp/Sharp  
**306-1297-205** 20.5 cm, 8" Blunt/Blunt  
**306-1298-230** 23.0 cm, 9" Blunt/Blunt

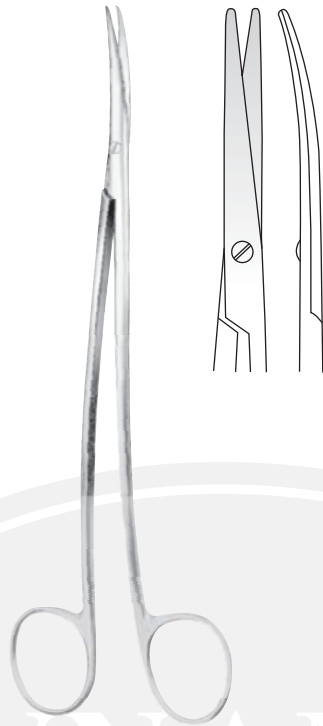

**METZENBAUM-LAHEY**  
**306-1301-180** 18.0 cm, 7" Str.  
**306-1302-205** 20.5 cm, 8" Cvd.  
**306-1303-230** 23.0 cm, 9" Cvd.

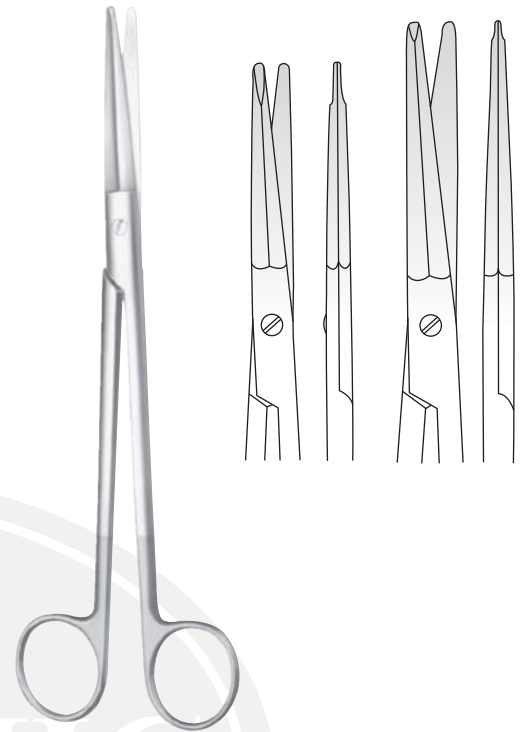

**GORNEY**  
**306-1306-200** 20 cm, 8"  
**306-1307-230** 23 cm, 9"



**REES**  
**306-1310-180**  
 18 cm, 7"



**KELLY**  
**306-1313-160**  
**306-1314-160**  
 16 cm, 6 1/4"

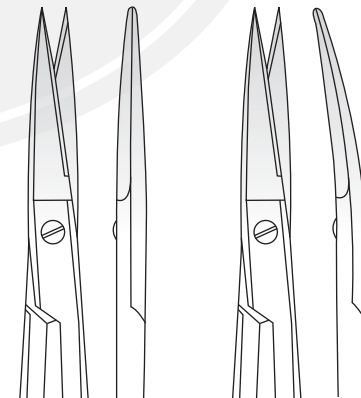

Straight

Curved



## VASCULAR, DISSECTING SCISSORS

Gefäßscheren, Präparierscheren

Tijeras vasculares, Tijeras de disección

Ciseaux vasculaires, Ciseaux à dissection

Forbici vascolari, Forbici per dissezione



**RAGNELL**  
306-1317-125  
12.5 cm, 5"



**DEAN**  
306-1320-175  
17.5 cm, 6 3/4"



**JOSEPH**  
306-1323-145  
14.5 cm, 5 3/4"



**GUM SCISSORS**  
Locklin  
306-1326-160  
16 cm, 6 1/4"

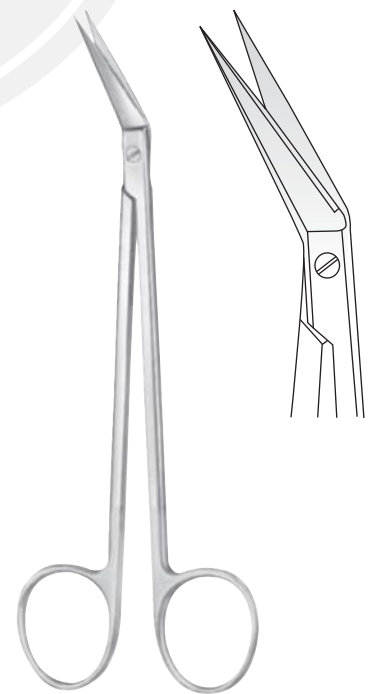

**GUM SCISSORS**  
Locklin  
306-1329-160  
16 cm, 6 1/4"



# VASCULAR, DISSECTING SCISSORS

Gefäßscheren, Präparierscheren

Ciseaux vasculaires, Ciseaux à dissection

Tijeras vasculares, Tijeras de disección

Forbici vascolari, Forbici per dissezione

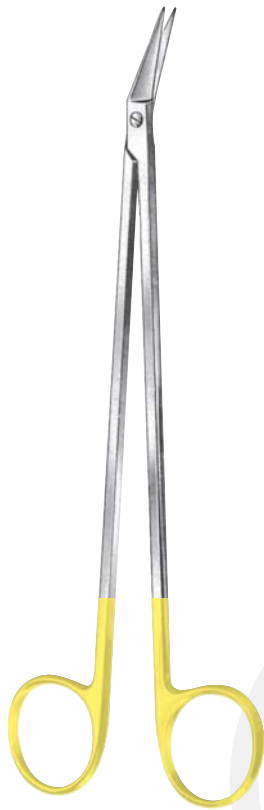

**POTTS-SMITH**  
19.0 cm, 7 1/2"

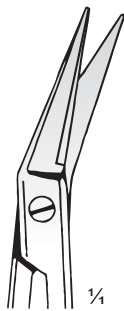

25°  
306-1332-190



45°  
306-1333-190

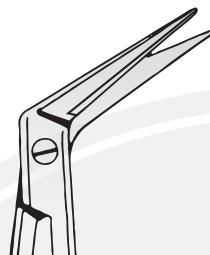
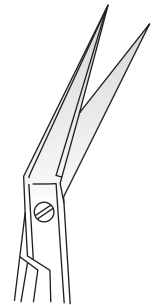

60°  
306-1334-190



**IRIS**  
306-1337-110  
11cm 4 1/2"



306-1340-165  
16.5 cm 6 1/2"

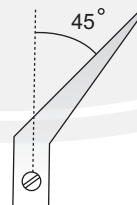

306-1341-180  
18.0 cm 7"

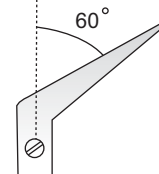

306-1342-185  
18.5cm 7 1/4"



**DEBAKEY**

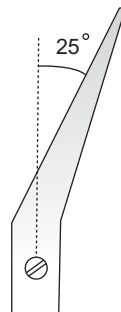

306-1343-190  
19.0 cm 7 1/2"

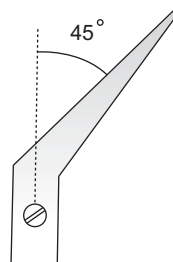

306-1344-220  
22.0 cm 8 3/4"

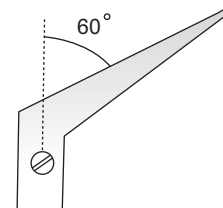

306-1345-230  
23.0 cm 9"



# IRIS SCISSORS

Irisscheren

Tijeras para Iridectomía

Ciseaux à iridectomie

Forbici per iridectomia



**IRIS**  
306-1350-115  
11.5cm 4 1/2"

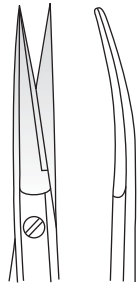

**IRIS**  
306-1354-115  
11.5 cm Straight  
306-1355-115  
11.5 cm Curved

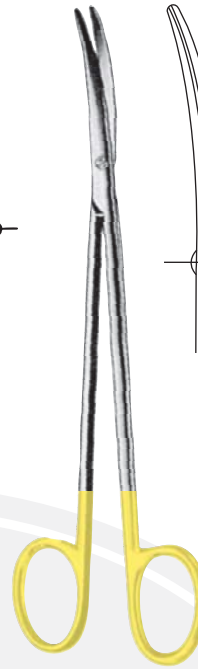

**TOENNIS-ADSON**  
306-1358-175  
17.5 cm, 6 3/4"

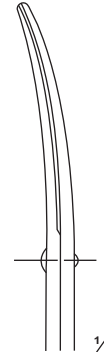

**STRABISMUS**  
306-1361-115  
11.5 cm, 4 1/2"  
Curved

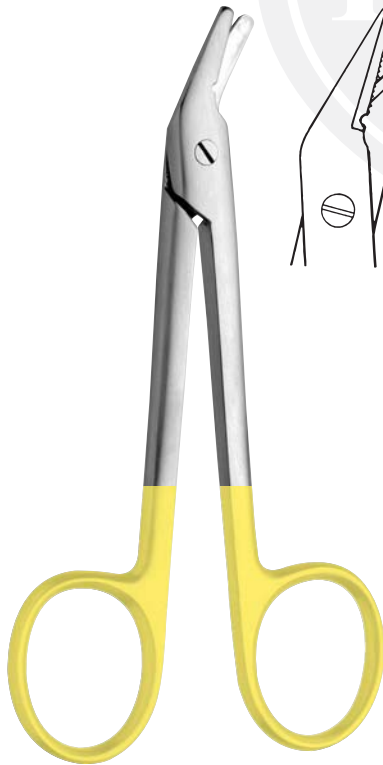

**WIRE CUTTING**  
306-162-115  
11.5 cm, 4 1/2"

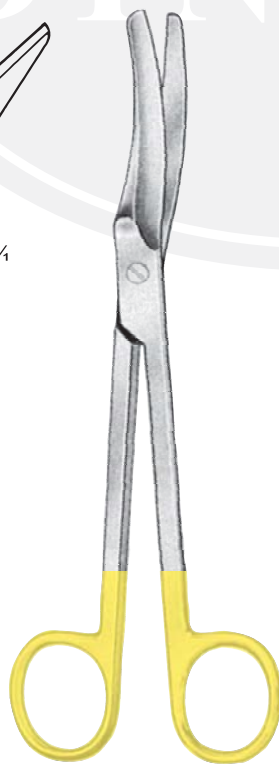

**306-1364-200**  
20.0 cm, 8"



**FOMON**  
306-1367-145  
14.5cm, 5 3/4"

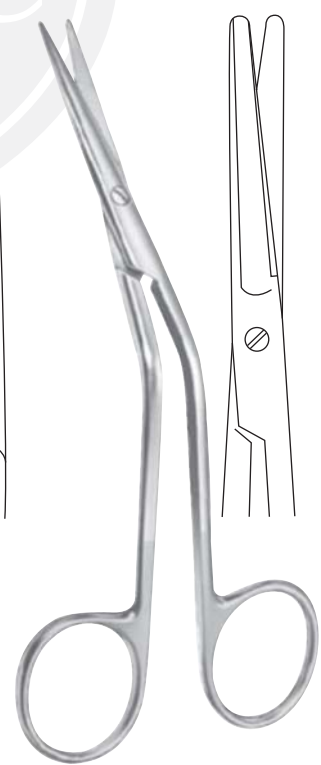
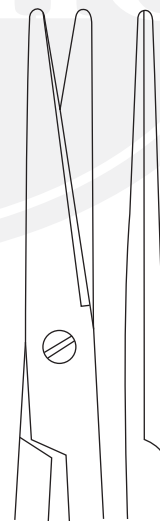

**COTTLE**  
306-1370-160  
16 cm, 6 1/4"

