

LiftSafe

LTD.
Specialist Materials Handling Solutions



WORKSHOP EQUIPMENTS



WORKTABLES 4-7



TOOL TROLLEYS 8



WORK SHOP TROLLEY 9



TOOL CABINET 11

RACKS AND STORAGE



SHELVS 20-21



SHELVING SYSTEMS 22-23



STEP STOOL & FILE TROLLEYS 24

TRANSPORT AND LIFTING



HAND TRUCKS 32-39



TROLLEYS 40-44



PALLET CAGES 44



TROLLEYS & TRANSPORT 45-47



PALLET TRUCKS 48-57

ENVIRONMENTAL HANDLING



DRUM LIFTERS 93-95



DRUM PALLETS 96-99



TOOL TROLLEY 100

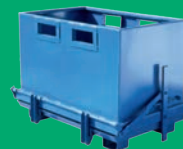

BOTTOM DISCHARGING CONTAINERS 100

WINTER PRODUCTS



PLOGHS 110-111



SNOW SHOVEL 112



SALT & SAND CARRIER 112



SNOW BLOWERS 113

PERSONAL TRANSPORT PRODUCTS



GOCYCLE GR2 114



PAUKOOL S2 115

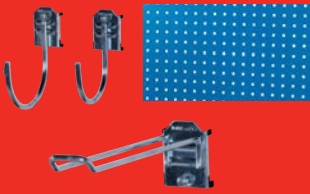

TOOL PANELS & HOOKS 12-17



COMPUTER CABINETS 18

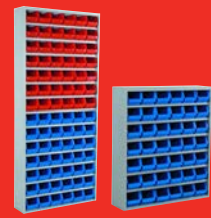

BIN CABINETS 19



KEY BOXES 25



LOCKERS 26-29



STORAGE CABINETS 30-31



SCISSOR LIFTS 58-59



LIFTING TABLES 60-63



LIFTERS & STACKERS 64-77



ACCESSORIES, LIFTING, TRANSPORT 78-92



REFUSE BINS 101



WORK CAGES 103



TILTING SKIPS 104-106



HEAVY DUTY TILTING SKIPS 108-109

We have a product range with more than 1000 articles for material handling.

Visit our website to explore all of our products and keep yourself updated with our latest news.

WORKSHOP EQUIPMENTS

STABLE WORKTABLE

Worktable with manual height adjustment between 720 and 970 mm. Perfectly adapted for assembly work.

20 mm thick table top of light grey laminate.
Maximum load of 150 kg evenly distributed over the surface of the table.



Item No 4230074302

<i>Item no.</i>	<i>Identification</i>	<i>Width mm</i>	<i>Depth mm</i>	<i>Min. height mm</i>	<i>Max height mm</i>
4230074302	Stable Worktable 16	1600	800	720	970
4230074304	Stable Worktable 20	2000	800	720	970

PACKING TABLE KIT

Suitable for worktable 4230074304

Cutting width 1,300 mm

NOTE: Table and packing material is not included.



Item No 4035074324

EXTRA STRONG WORKTABLES

Extra strong worktables for heavy handling with manual height adjustment of between 740 and 1100 mm.

Supplied with a hard-wearing 42 mm thick table top in order to cope even with really heavy and dirty work.

Maximum load of 500 kg evenly distributed over the surface of the table.

Supplied complete with a trestle.

SELECT TABLE TOP IN ACCORDANCE WITH THE TABLE!

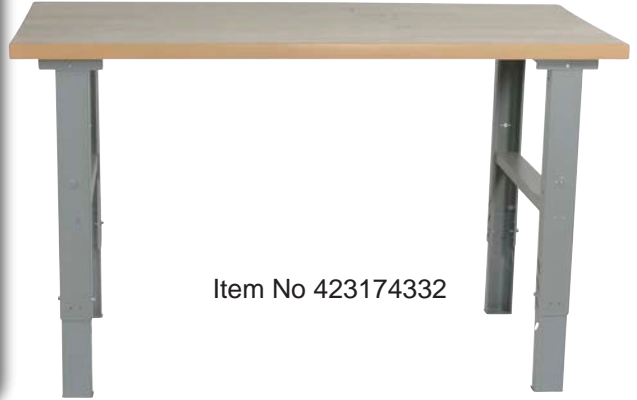

Item No 423174332

Item No	Identification	Width mm	Depth mm
4231743301	Oil-tempered board	1600	800
4231743302	Oak board	1600	800
4231743303	Steel	1600	800
4231743304	Vinyl	1600	800
4231743321	Oil-tempered board	2000	800
4231743322	Oak board	2000	800
4231743323	Steel	2000	800
4231743324	Vinyl	2000	8000



EXTRA STRONG WORKTABLES

Extra strong worktables for heavy handling. Supplied with a hard-wearing 42 mm thick table top in order to cope even with really heavy and dirty work.

Maximum load of 500 kg evenly distributed over the surface of the table.

The drawers are fitted with ball bearings and are 100% telescopic.

Supplied complete with a trestle, a drawer unit (Item No 4035074350) with 5 drawers 1x50, 2x100, 1x150 and 1x200 mm and a base panel. Capacity per drawer 40 kg.

SELECT TABLE TOP IN ACCORDANCE WITH THE TABLE!

Item No 423274334



Item No	Identification	Width mm	Depth mm
4232743341	Oil-tempered board	1600	800
4232743342	Oak board	1600	800
4232743343	Steel	1600	800
4232743344	Vinyl	1600	800
4232743351	Oil-tempered board	2000	800
4232743352	Oak board	2000	800
4232743353	Steel	2000	800
4232743354	Vinyl	2000	8000

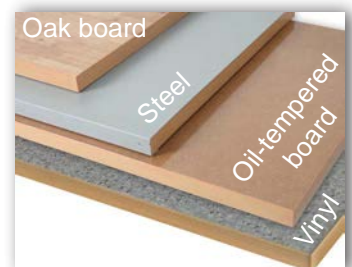

EXTRA STRONG WORKTABLES

Extra strong worktables for heavy handling. .
Supplied with a hard-wearing 42 mm thick table top in order to cope even with really heavy and dirty work.

Maximum load of 500 kg evenly distributed over the surface of the table.

The drawers are fitted with ball bearings and are 100% telescopic. Supplied complete with a trestle, a drawer unit (Item No 4035074352) with 6 drawers and a base panel. Drawer height: 6x100 mm. Capacity per drawer 40 kg.

SELECT TABLE TOP IN ACCORDANCE WITH THE TABLE!

Item No 4232743362



Item No	Identification	Length mm	Depth mm
4232743361	Oil-tempered board	1600	800
4232743362	Oak board	1600	800
4232743363	Steel	1600	800
4232743364	Vinyl	1600	800
4232743381	Oil-tempered board	2000	800
4232743382	Oak board	2000	800
4232743383	Steel	2000	800
4232743384	Vinyl	2000	800



DRAWER UNIT WITH A CENTRAL LOCK

The drawers are fitted with ball bearings and are 100 % telescopic.
Capacity per drawer 40 kg.
Max load in the whole drawer unit = 170 kg.

ACCESSORIES:

- Drawer unit top of sheet metal painted in grey = Item No. 4035074355
- Wheel set, 4 castors, 2 with brakes. = Item No 4035074356
- Rubber mat, black = Item No 8711074358

Item No	Identification	External dimensions: Width x Depth x Height mm	Internal dimensions: Width x Depth mm	Capacity in kg per drawer	Total capacity kg
4035074350	Drawer unit, 5 drawers	535x665x800	450x606	40	170
4035074352	Drawer unit, 6 drawers	535x665x800	450x606	40	170

Item No 4035074350



Item No 4035074352



Complete with
all accessories!

ATTACHMENT KIT

A ready package makes your worktable a complete workplace.

The package consists of:

- 3 perforated pillars
- 2 struts, 645 or 875 mm.
- 2 perforated panels 666x480 mm or 886x480 mm.
- 1 hook kit with 30 mixes hooks ,
(contents, see Item No 4038074113).

Item No 4035074320 is suitable for worktables with a width of 1,600 mm.

Item No 4035074322 is suitable for worktables with a width of 2,000 mm.

Item No 4035074320 / 4035074322

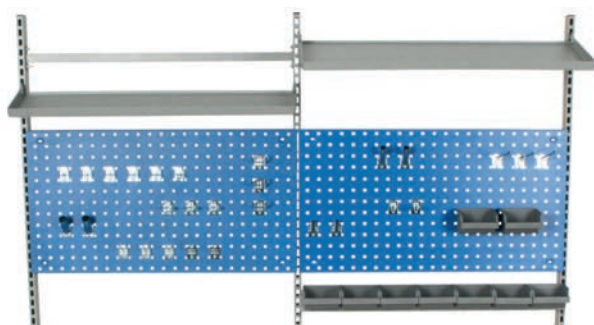

STORAGE DRAWER

Storage drawer for installation underneath the table top of the worktable.

Lockable, fitted with a cylinder lock and ball bearings and 100% telescopic.

Capacity per drawer 40 kg.

Item No 4035074310



Item No	Identification	Width mm	Depth mm	Height mm
4035074310	Storage drawer	535	665	100

DRAWER ORGANISER

Drawer organiser for drawer units and storage drawers (not suitable for 50-mm-high drawer).

Item No 4035074318

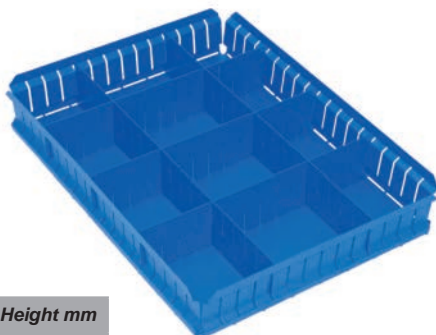

Item No	Identification	Width mm	Depth mm	Height mm
4035074318	Drawer organiser	445	600	95

TOOL TROLLEYS

Our range of portable mobile tool trolleys/work benches contains two different models.

The mobile tool trolleys/work benches have a working surface and four strong wheels, two of which swivel and have brakes and the other two are fixed. The trolley can be equipped with an extension kit (Item No 4033074040).

Both trolleys are supplied with individual drawer restraints. The drawers are fitted with ball bearings and are 100% telescopic. Drawer height: 1x200, 4x100 (Item No 4033074020)
Drawer height: 2x200, 8x100 (Item No 4033074030)

The attachment kit, Item No, consists of:

- 2 perforated pillars
- 1 perforated panel
- Hanging strip with 7 plastic bins
- 1 shelf
- 1 pack of 20 mixed hooks , (part no. 4038074112).

Item No 4033074020+4033074040

Item No 4033074030



Item No	Identification	Width mm	Depth mm	Height mm	Weight kg	Capacity in kg per drawer	Total capacity in kg	Wheel diameter x width mm
4033074020	Tool trolley Oak 5+1	1025	600	900	97	40	600	130x40
4033074021	Tool trolley Vinyl 5+1	1025	600	900	97	40	600	130x40
4033074030	Tool trolley Oak 5+5	1025	600	900	121	40	600	130x40
4033074031	Tool trolley Vinyl 5+5	1025	600	900	121	40	600	130x40
4033074040	Attachment kit	925		825	20			

WORKSHOP TROLLEY

The workshop trolley has a stable design with a cabinet of perforated steel and undercarriage in square pipe. The trolley also has four swivel wheels, two of which are lockable.

Supplied with a kit of 20 mixed hooks (Item No 4038074112).
Accessories: Drawer unit (Item No 4033074070 74070)

The drawers are fitted with ball bearings and are 100% telescopic.

Drawer height: 1x50, 2x150, 1x250.

Capacity per drawer 40 kg.

Item No 4033074060+4033074070



Item No 4033074060



Item No 4033074070



Item No	Identification	Width mm	Depth mm	Height mm	Cabinet height x depth x width mm	Wheel diameter x width mm	Weight kg
4033074060	Workshop trolley	600	400	1800	885x400x600	125x27 Rubber	32
4033074070	Drawer unit	544	400	693	693		30

MOBILE FLEX TROLLEY

Mobile storage trolley with perforated tool panels on the sides and 2 shelves. Equipped with four castors, two of which with brakes.

Item No 4033074010
+ 4033074011



Item No 4033074010



WRITING DESK

The writing desk is intended for installation on Item No 4033074010, on the wall or stand-alone. The writing desk has a hinged writing surface equipped with a raised edge and a paper storage unit.

Item No 4033074011

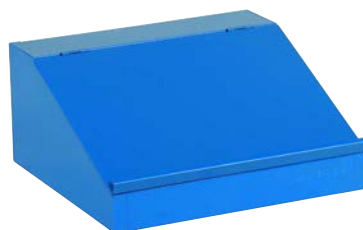

Item No	Width mm	Depth mm	Height back mm	Height front mm	Weight kg	Wheel diameter x width mm
4033074010 + 4033074011	490	445	1310	1175	44	75x20
4033074010	490	445	1080	1080	40	75x20
4033074011	490	445	230	100	4	

Item No 4012071400

MOBILE TOOL CABINET

Equipped with one fixed shelf, writing desk covered in rubber and a pen holder. Supplied with 4 solid rubber wheels with brakes. Both the door and the writing desk can be locked securely with cylinder locks. Powder coated for the best finish and durability.



Item No	Width mm	Depth mm	Height back mm	Height front mm	Weight kg	Wheel diameter x width mm
4012071400	500	500	1270	1100	29	100x30

TOOL CABINET

Stable welded tool cabinet in a very robust design in steel plate.

- Lockable
- Supplied complete with fittings as in the picture.
- Powder coated in blue and grey.

INCLUDES:

- Perforated panels in the back, walls and door.
- 2 fixed shelves.
- 1 telescopic shelf with ball bearings.
- 1 telescopic drawer with ball bearings.
- 1 drawer set with 6 drawers.
- Hanging strip with 7 plastic bins.
- 1 pcs Hook kit with 30 mixed hooks. (Item No 4038074113).
- Adjustable feet.

Item No 4032074000

Item No	Width mm	Depth mm	Height mm	Weight kg
4032074000	1020	540	2000	150



Item No 4038074100

TOOL PANELS

All perforated panels have 9 mm square holes with 38 mm spacing between holes for hanging of tool hooks. Panel 4038074100 and 4038074102 is equipped with integrated hanging attachments.

Panel 4038074105 is intended for wall mounting.

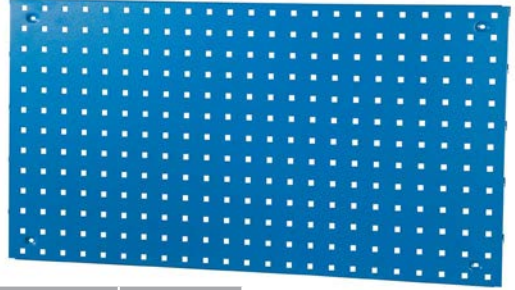

Item No	Identification	Width mm	Height mm	Depth mm	Number per package	Weight kg
4038074100	Tool panel	896	480	18	1	5
4038074102	Tool panel	666	480	18	1	3
4038074105	Tool panel	1950	900	18	1	15

HOOK SETS

Hook set 20 pack

Hanging hook 100 mm, 4 pieces.
 Single hook 50 mm, 6 pieces.
 Spring clip 12 mm, 3 pieces.
 Spring clip 18 mm, 3 pieces.
 Double hook 55 x 25 mm, 4 pieces.

Item No
 4038074112
 (20-pack)



Hook set 30 pack

Hanging hook 38 mm, 5 pieces.
 Hanging hook 200 mm, 3 pieces.
 Double hook 38x11 mm, 6 pieces.
 Double hook 64x11 mm, 2 pieces.
 Tool hook 23/44 mm, 3 pieces.
 Double angle hook 50 mm, 3 pieces.
 Box holder, incl. box, 2 pieces.
 Pipe holder 9 mm, 2 pieces.
 Pipe holder 16 mm, 2 pieces.
 Pipe holder 24 mm, 2 pieces.

Item No
 4038074113
 (30-pack)



Hook set 50 pack

Hanging hook 38 mm, 20 pieces.
 Double hook 38x11 mm, 10 pieces.
 Tool hook 23/44 mm, 5 pieces.
 Double angle hook 50 mm, 5 pieces.
 Ring hook 40 mm, 1 piece.
 Ring hook 60 mm, 1 piece.
 Spring clip 12 mm, 5 pieces.
 Pipe holder 16 mm, 2 pieces.
 Cup 82 mm, 1 piece.

Item No
 4038074115
 (50-pack)



ASSORTED HOOKS

Item No 4038074140-4038074153

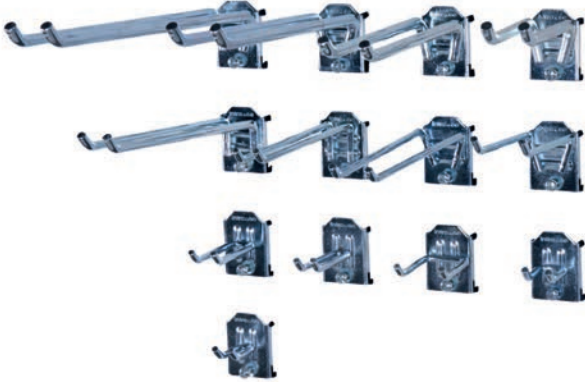

Item No 4038074128-4038074133



Item No 4038074138-4038074139



Item No 4038074155



Item No 4038074120



Item No 4038074170-4038074173



Item No 4038074135-4038074137



Item No 4038074195



Item No 4038074196



Item No 4038074191



Item No 4038074122-4038074125



Item No 4038074190



Item No 4038074160-4038074163



Item No 4038074175-4038074176



Item No 4038074183-4038074185



Item No 4038074188

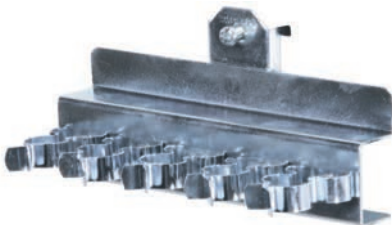

Item No 4038074167-4038074168



Item No 4038074214

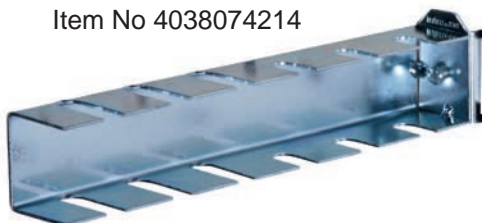

Item No 4038074220



Item No 4038074216-4038074217



Item No 4038074200-4038074203



Item No 4038074178



Item No 4038074165



Item No 4038074234



Item No 4038074212



Item No 4038074205



Item No 4038074207



Item No 4038074199



Item No 4038074228



Item No 4038074180-4038074181



Item No 4038074222



Item No 4038074236

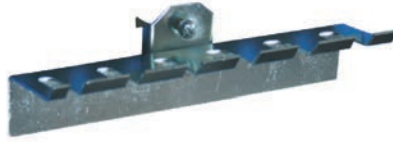

Item No 4038074230



Item No 4038074231



Item No 4038074225



Item No 4038074232



Item No 4038074210



Item No	Identification	Length mm	Width mm	Depth mm	Diameter mm	Height mm	Number per package
4038074120	Base plate	34				40	3
4038074122	Hanging hook	24			5		3
4038074123	Hanging hook	38			5		3
4038074124	Hanging hook	100			6		3
4038074125	Hanging hook	200			6		3
4038074128	Single hook	10			6		3
4038074129	Single hook	50			6		3
4038074130	Single hook	100			8		3
4038074131	Single hook	150			8		3
4038074132	Single hook	200			8		3
4038074133	Single hook	250			8		3
4038074135	Angled single hook	25			5		3
4038074136	Angled single hook	50			5		3
4038074137	Angled single hook	100			5		3
4038074138	Round hook				60		3
4038074139	Round hook				80		3
4038074140	Double hook	38	7		5		3

<i>Item No</i>	<i>Identification</i>	<i>Length mm</i>	<i>Width mm</i>	<i>Depth mm</i>	<i>Diameter mm</i>	<i>Height mm</i>	<i>Number per package</i>
4038074141	Double hook	38	11		5		3
4038074142	Double hook	55	25		5		3
4038074143	Double hook	64	7		5		3
4038074144	Double hook	64	11		5		3
4038074145	Double hook	100	25		5		3
4038074146	Double hook	150	25		5		3
4038074147	Double hook	150	10		5		3
4038074148	Double hook	200	15		6		3
4038074150	Double hook	100	20		8		3
4038074151	Double hook	150	20		8		3
4038074152	Double hook	200	20		8		3
4038074153	Double hook	250	20		8		3
4038074155	Packaging hook	170	29				2
4038074160	Ring hook				40		2
4038074161	Ring hook				60		2
4038074162	Ring hook				80		2
4038074163	Ring hook				110		1
4038074165	Bottle hook				80		1
4038074167	Tool hook		43	20			3
4038074168	Tool hook		65	35			3
4038074170	Angle hook	50	40				3
4038074171	Angle hook	50	60				3
4038074173	Angle hook	70	80				3
4038074175	Swivel joint wrench hook	28	9				3
4038074176	Swivel joint wrench hook	33	17				3
4038074178	Document clip		60				1
4038074180	Rubber clip	25	40				2
4038074181	Rubber clip	50	40				2
4038074183	Spring clip				12		3
4038074184	Spring clip				18		3
4038074185	Spring clip				25		3
4038074188	Spring clip strip,		150				1
4038074190	Box holder, incl. box		100				1
4038074191	Box holder, excl. box		100				1
4038074195	Tray strip, incl 5 trays		555				1
4038074196	Tray strip, excl. trays		555				1
4038074199	Wire basket	385		180		100	1
4038074200	Pipe holder	70			35		2
4038074201	Pipe holder	50			9		2
4038074202	Pipe holder	75			16		2
4038074203	Pipe holder	75			24		2
4038074205	Pipe holder, straight	60			34		2
4038074207	Cup				90	22	1
4038074210	Shelf	350		120			1
4038074212	Hose shelf			160	125		1
4038074214	Hook strip, 6 holes	220					1
4038074216	Hook bobbin	100	80				1
4038074217	Hook bobbin	200	105				1
4038074220	Screwdriver holder, 7 holes	220					1
4038074222	Screwdriver holder	238					1
4038074225	Drill bit holder	240			3 - 14 mm		1
4038074228	Spanner holder, vertical		70			290	1
4038074231	Spanner holder	200					1
4038074232	Box spanner holder	250					1
4038074234	Allen key holder		170	105		40	1
4038074236	Swivel joint wrench holder	170					1

COMPUTER CABINET / TERMINAL CABINET

Computer cabinet with self-ventilation. Supplied unassembled in a flat-pack in order to ensure the best transport possible from an economic and environmental perspective. The cabinet protects against dust and dirt. It provides good protection against unauthorised users and mechanical damage. Suitable for screens of up to 21 inches.

Powder coated for the best finish and durability.

Item No 4031071150

Item No	4031071150
Height mm	1730
Depth mm	545
Width mm	645
Weight kg	50



COMPUTER CABINET / TERMINAL CABINET

Computer cabinet for flat screens. It takes up little space as its depth is only 300 mm.

The hard disk is placed crosswise through the hatch on the short end.. There is a service hatch on the side. The cabinet is equipped with a keyboard shelf and a terminal window for screens of up to 21 inches. All doors are equipped with locks.

The keyboard shelf has a telescopic mouse board. The bottom cabinet contains one shelf.

Powder coated for the best finish and durability.

It is recommended to attach / anchor the computer cabinet to the wall.

Item No 4031074080

Item No	4031074080
Height mm	1630
Depth mm	300
Width mm	500
Weight kg	40



BIN CABINETS

Bin cabinet for the warehouse, storeroom, shop, etc. Complete bin cabinets offering great flexibility and maximum storage capacity. The bin cabinets are supplied furnished with module bins.

Item No 4036071230 is supplied complete with 6 shelves and 42 module bins.

Item No 4036071232 is supplied complete with 13 shelves and 84 module bins.

Plastic bin internal dimensions: LxWxH = 210x125x120 mm

Plastic bin external dimensions: LxWxH = 240x148x125 mm

Needs to be anchored to the wall!

Capacity of 40 kg evenly distributed per shelf.

Extra bins can be ordered seperated.

-Red bin : Item No 4036071235

-Blue bin: Item No 4036071236

Item No 4036071232



<i>Item No</i>	4036071230	4036071232
<i>Height mm</i>	1105	2170
<i>Width mm</i>	960	960
<i>Depth mm</i>	250	250
<i>Number of trays</i>	42	84
<i>Weight kg</i>	34	59

Item No 4036071230



RACKS AND STORAGE

SHELVING UNIT - LEO

Compact and smart shelving unit for the warehouse, workshop, archive, office, food industry, shop, etc. Assembled quickly and easily without any screws, nuts and bolts. Substantially reinforced shelves guaranteed for a load of 70 kg equally distributed over each shelf.

Available in a painted version in three different colours and galvanised steel or stainless steel to meet higher requirements, for example, in laboratories kitchens and in the food industry. Preferable to be anchored to the wall. Supplied complete with 5 shelves!

Item No 4051072000



Item No 4051072005



Item No 4051072010



Item No 4051072020



Item No 4051072030



Item No	4051072000	4051072005	4051072010	4051072020	4051072030
Identification	LEO – White	LEO - Galv	LEO – Orange	LEO - Blue	LEO - Stainless
Width mm	1000	1000	1000	1000	1000
Depth mm	400	400	400	400	400
Height mm	1850	1850	1850	1850	1850
RAL colour	White 9002	Galvanised	Orange 2001	Blue 5010	Stainless steel

UNIVERSAL SHELVES/ SHELVING SYSTEMS

Easily installed shelving units intended for large volume goods.

Easy and flexible to extend where required.

The units must be bolted to the floor.

Safety pins for locking beams to uprights.

Spacers must be used in the rear in the event of rear mounting.

The spacer for the universal shelves must be 200 mm (Item No 4050072082).

The spacer for the tyre shelves must be 300 mm (Item No 4050072084).

Recommendation: 3 spacers per upright.

Bolts and nuts are not included with the spacers!



19 mm thick chipboard!



BEAMS

Item No	4050072050	4050072051	4050072052
Identification	Beam	Beam	Beam
Length mm	1500	2000	2700
Max load kg	580 per pair	400 per pair	220 per pair

UPRIGHTS

Item No	4050072056	4050072058	4050072060	4050072062	4050072064	4050072066
Identification	Uprights 2000x450 mm (HxD)	Uprights 2500x450 mm (HxD)	Uprights 3000x450 mm (HxD)	Uprights 2000x600 mm (HxD)	Uprights 2500x600 mm (HxD)	Uprights 2500x600 mm (HxD)

CHIPBOARDS

Item No	4050072068	4050072070	4050072071	4050072072	4050072074	4050072076
Identification	Chipboard	Chipboard	Chipboard	Chipboard	Chipboard	Chipboard
Length x Width mm	1485x398	1985x398	2685x398	1458x550	1985x550	2685x550

SAFETY PIN



SPACER



SPACER

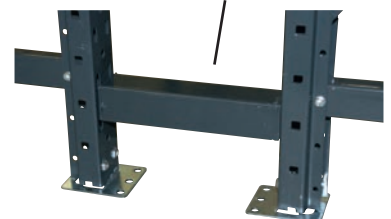

ACCESSORIES

Item No	4050072080	4050072082	4050072084
Identification	Safety pin	Spacer 200 mm	Spacer 300 mm
Quantity per package	2	1	1

Bolts and nuts are not included with the spacers!

TYRE SHELF

The same design as the Universal shelf (p. 20) but without chip-boards. The uprights for the tyre shelves must be 450 mm deep – adapted to the dimensions of the tyres.

Item No 1910057100



For more information, see page 39

Example

FIGURE 1 = 3 uprights (Item No 4050072058) + 12 beams (Item No 4050072051) = Capacity 60 tyres.

Item No 4210072200



SHELVING UNIT – T20A

Strong shelving unit for the warehouse, workshop, archive, office, food industry, shop, etc.

Strong shelving unit with chipboard shelves. Easily assembled without any screws.
Suitable for all purposes in offices, workshops, shops or elsewhere. Solid shelves guaranteed a load of 200 kg equally distributed over each shelf.
Supplied complete with 5 shelves!

Item No	4210072200
Identification	T20
Width mm	900
Depth mm	450
Height mm	1800
Colour	Grey

Item No 4072034300



Item No 4072034301



Item No 4072034302



STEP STOOL, 2 STEP

Step stool of painted sheet metal with spring-loaded wheels. The stool is stable and secure and you can move it easily by pushing it slightly with your foot. When pressure is applied to the stool, the spring-loaded wheels are pressed in and the stool remains steady. The steps are covered in ribbed rubber in order to minimise the risk of slipping. Suitable for, e.g. shops, warehouses and offices.

Item No 4072034303



Item No	4072034300	4072034301	40720 34302	4072034303
Ø mm Top	290	290	290	290
Ø mm Bottom	430	430	430	430
Maximum load Kg	150	150	150	150
Weight kg	4.5	4.5	4.5	4.5
Height mm	430	430	430	430
Colour	Grey	Black	Blue	Red

FILE TROLLEYS

Solid trolley with four swivel wheels, all of which are with brakes.

Capacity 80 A4 suspension files (not included).

Item No 4037071104 is lockable.

Item No 4037071104



Item No 4037071102

Item No	4037071102	4037071104
Identification	File trolley without cover	File trolley with cover
Capacity	80 A4 suspension files	80 A4 suspension files
Height mm	592	592
Width mm	655	655
Depth mm	368	457
Weight kg	6.8	7.5

KEY BOXES

Smart stable key boxes for secure key storage. Supplied complete with key tags. The boxes are equipped with cylinder locks, including 2 keys.

Powder coated for the best finish and durability.

Item No 4021071140



Item No 4021071130



Item No	4021071132	4021071130	4021071140	4021071134
Height mm	400	400	650	650
Depth mm	70	70	70	120
Width mm	350	350	350	350
Weight kg	4	6	8	12
Number of keys	30	60	100	200

Item No 4015071110



Item No 4015071120



SMALL STORAGE LOCKERS

Unassembled small storage lockers for storing personal belongings in workplaces, schools, hospitals, sports centres, shops, offices, etc. Supplied unassembled in flat-pack to ensure the best and cheapest transport.

Due to its very smart design, the lockers are assembled quick and easy without any tools and screws. The locker modules are provided with holes so that they can be assembled together in accordance with your own desires and, alternatively, for wall mounting. The lockers have recessed, hidden hinges and espagnolette locks for secure storage. Powder coated.

Item No	4015071110	4015071120
Height mm	275	455
Depth mm	275	275
Width mm	355	355
Weight kg	5	7

STORAGE LOCKERS

Due to their smart design, they are easily assembled without any screws and tools.

Sloping roof for simple cleaning.

- Cylinder locks.
- Powder coated door in blue or, red.

Base in grey.



Accessories: Base kit,
Item No 4091071390
Base height: 100 mm



Accessories: Bench,
Item No 4091071395
Bench height: 260 mm



Accessories: Latch
for padlocks
Item No 4090071392

Item No 4011071353



Item No 4011071340



Item No	4011071340	4011071350	4011071342	4011071352
Identification	Blue/Grey	Blue/Grey	Red/Grey	Red/Grey
Number of doors	4	5	4	5
Height front edge mm	1830	1830	1830	1830
Height back edge mm	1920	1920	1920	1920
Width mm	350	350	350	350
Depth mm	550	550	550	550
Weight kg	29	31	29	31

Item No	4011071341	4011071351	4011071343	4011071353
Identification	Blue/Grey	Blue/Grey	Red/Grey	Red/Grey
Number of doors	8	10	8	10
Height front edge mm	1830	1830	1830	1830
Height back edge mm	1920	1920	1920	1920
Width mm	700	700	700	700
Depth mm	550	550	550	550
Weight kg	55	70	55	70

LOCKERS

Due to its smart design, it is easily assembled without any screws and tools. Sloping roof for simple cleaning. Well-ventilated with a double ventilation grill.

- Cylinder locks.
- Powder coated door in blue or, alternatively, red.
- Base in grey.



Accessories: Base kit,
Item No 4091071390
Base height: 100 mm



Accessories: Bench,
Item No 4091071395
Bench height: 260 mm



Item No 4011071334

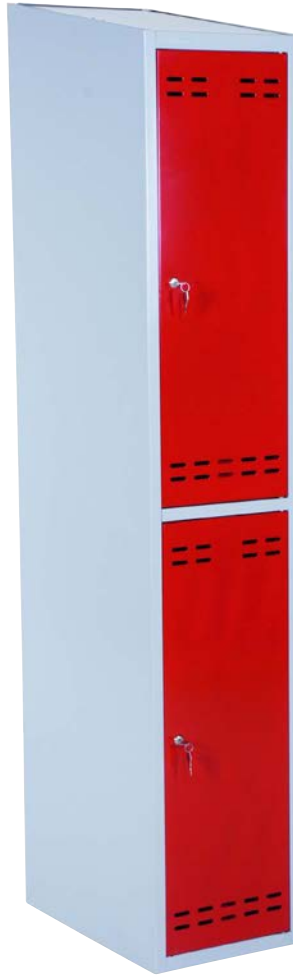

Item No 4011071332



Item No	4011071330	4011071332	4011071334	4011071336
Identification	Blue/Grey	Blue/Grey	Red/Grey	Red/Grey
Number of doors	2	4	2	4
Height front edge mm	1830	1830	1830	1830
Height back edge mm	1920	1920	1920	1920
Width mm	350	700	350	700
Depth mm	550	550	550	550
Weight kg	25	45	25	45

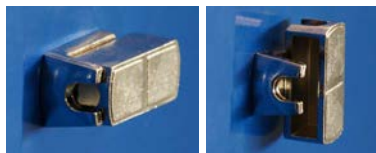

Accessories: Latch for padlocks
Item No 4090071392

LOCKERS

Due to their clever design, they are easily assembled without any screws and tools. Sloping roof for simple cleaning. Well-ventilated with a double ventilation grill.

- Cylinder locks.
- Powder coated door in blue or, alternatively, red.
- Base in grey.

Item No 4011071310

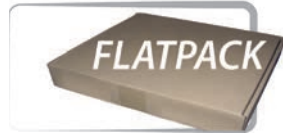

Item No 4011071321



Accessories: Base kit,
Item No 4091071390
Base height: 100 mm



Accessories: Bench,
Item No 4091071395
Bench height: 260 mm

Item No	4011071310	4011071320	4011071311	4011071321
Identification	SWED-1 Blue/Grey	SWED-2 Blue/Grey	SWED-1 Red/Grey	SWED-2 Red/Grey
Number of doors	1	2	1	2
Height front edge mm	1830	1830	1830	1830
Height back edge mm	1920	1920	1920	1920
Width mm	350	700	350	700
Depth mm	550	550	550	550
Weight kg	25	45	25	45

Accessories: Latch for padlocks
Item No 4090071392

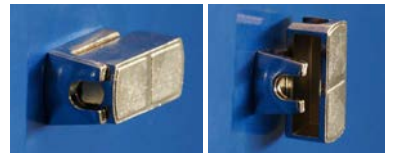

Z - LOCKERS

Due to its clever design, it is easily assembled without any screws and tools. Sloping roof for simple cleaning. Well-ventilated with a double ventilation grill.

- Cylinder locks.
- Powder coated door in blue or, alternatively, red.
- Base in grey.

Item No 4011071362



Item No 4011071364



Accessories: Base kit,
Item No 4091071390
Base height: 100 mm



Accessories: Bench,
Item No 4091071396
Bench height: 260 mm

Item No	4011071360	4011071362	4011071364	4011071366
Identification	Blue/Grey	Blue/Grey	Red/Grey	Red/Grey
Number of doors	2	4	2	4
Height front edge mm	1830	1830	1830	1830
Height back edge mm	1920	1920	1920	1920
Width mm	400	800	400	800
Depth mm	550	550	550	550
Weight kg	25	45	25	45



STORAGE CABINETS

FOR OFFICE, ARCHIVE AND WAREHOUSE

Stable unassembled steel cupboard. Due to its clever design, it is easily assembled without any screws and tools.

- Espagnolette lock with three locking points.
- Supplied with 4 shelves!
- Loading capacity of 70 kg evenly distributed per shelf.
- Powder coated in blue or, alternatively, grey.
- In order to attach the panels, holes must be drilled in the desired places and the panels must be screwed tight.

Accessories for cabinets

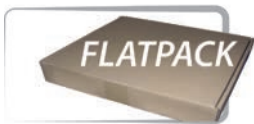

Item No	4091071212	4091071012	4038074100	4038074102
Identification	telescopic drawer	telescopic drawer	Panel	Panel
Height mm	70	80	480	480
Width mm	640	840	896	666
Depth mm	330	420	18	18

Item No 4010071220



Item No 4010071010



Item No	4010071210	4010071211	4010071220	4010071221	4010071010	4010071011	4010071020	4010071021
Identification	Swed-180 Blue	Extra shelf Blue	Swed-180 Grey	Extra shelf Grey	Swed-3 Blue	Extra shelf Blue	Swed-3 Grey	Extra shelf Grey
Height mm	1800	20	1800	20	2000	20	2000	20
Width mm	800	795	800	795	1000	995	1000	995
Depth mm	400	355	400	355	500	460	500	460
Weight kg	60	0,5	60	0,5	90	1	90	1

STORAGE CABINETS

FOR OFFICE, ARCHIVE AND WAREHOUSE

Stable unassembled steel cupboard. Due to its clever design, it is easily assembled without any screws and tools.

- Espagnolette lock with three locking points.
- Supplied with 2 shelves!
- Loading capacity of 70 kg evenly distributed per shelf.
- Powder coated in blue or, alternatively, grey.
- In order to attach the panels, holes must be drilled in the desired places and the panels must be screwed tight.



Item No	4010071015	4010071025	4010071215	4010071225
Identification	SWED 100 Blue	SWED 100 Grey	SWED 90 Blue	SWED 90 Grey
Height mm	1000	1000	900	900
Width mm	1000	1000	800	800
Depth mm	500	500	400	400
Weight kg	46	46	28	28

STORAGE CABINET ECONOMY

FOR OFFICE, ARCHIVE AND WAREHOUSE

Stable unassembled steel cupboard. Due to its clever design, it is easily assembled without any screws and tools.

- Espagnolette lock with three locking points.
- Supplied with 4 shelves!
- Loading capacity of 50 kg evenly distributed per shelf.
- Powder coated in blue with grey base or full grey.
- In order to attach the panels, holes must be drilled in the desired places and the panels must be screwed tight.



Item No	4010571601	4010571603
Identification	Economy-Blue	Economy-Grey
Height mm	1800	1800
Width mm	900	900
Depth mm	400	400
Weight kg	46	46

HAND TRUCK WITH LADDER

Practical, stable hand truck combined with ladder!
Perfect tool for the craftsman.

Item No 1910039101

Item No	1910039101
Opening size LxWxD mm	880x500x410
Folded size LxWxD mm	1054x500x80
Material:	Steel tube, Stair:PP + Fiber
Net weight kg	8.5
Load capacity kg	100 kg, (ladder : 100 kg)
Wheels mm	150x40 Rubber



ALUMINIUM HAND TRUCK

- Collapsible
- Extremely low weight
- Easy to transport

Item No 1910057019

Item No	1910057019
Identification	ALF
Loading capacity Kg	90
Height mm	1015
Width mm	495
Wheel diameter mm	200
Wheel type	Solid rubber
Weight kg	4



RuXXac HAND TRUCK

- Best available quality in the market!
- When folded, extremely space saving.
- Patented folding technology - Ready to use in seconds.
- Comfortable steering due to synthetic handle.
- Unique load-securing system fixes load perfectly on the cart.
- Load capacity 125 kg.
- Solid rubber tires.

Item No 1910057420

Item No 1910057430

Item No 1910057410

When folded



Item No 1910057440

Item No 1910057450

Item No 1910057460



Item No	1910057410	1910057420	1910057430	1910057440	1910057450	1910057460
Identification	Business	Business XL	Exclusive	Parcel Cart	Cross	Jumbo
Loading capacity Kg	125	125	125	125	75	250
Height open cm	103	113	113	112	111	125
Height folded cm	68,5	73,5	73,5	-	72	87
Width cm	49	49	49	49	61,5	65,5
Thickness folded cm	5,5	5,5	5,5	8	12	10
Platform cm	49x25	49x41	49x41	49x41	48x41	57x34,5
Weight kg	5,4	5,9	5,9	6	6,3	12,8
Wheel Ø mm	Solid rubber 180 mm Ø	Solid rubber 180 mm Ø	Solid rubber 180 mm Ø	Solid rubber 185 mm Ø	Extra wide 185 mm Ø	Pneumatic 220 mm Ø
Frame material	Aluminum	Aluminum	Stainless steel	Aluminum	Aluminum	Aluminum

ALUMINUM HAND TRUCK, TOP QUALITY!

A106s strength has made it the most affordable AL trolley for moving the industry.

It is the best use for all areas within cargo handling. It is equipped with a folding loading plate, filled tiers, handle with protection for the hands, slide rails for stair climbing, strengthened holders for handles.

Art nr 1910057390

Item No	1910057390
Identification	A106
Loading plate mm: 370x270	320
Width of wheels mm: 470	470
Width of handle (Max width) mm	840
Wheel diameter mm	260
Height mm	1310
Weight kg	12
Capacity kg	250



Slide rails for easy sliding down in stairs.

Filled tiers.

COMBI HAND TRUCK IN ALUMINUM

3-position trolley with extra long loadplate if necessary. Easy to change position.

Filled tiers.

Item No	1910057391
Identification	A107
Loading nose plate mm:	700x200
Width of wheels mm:	470
Width mm	527
Height mm	1303
Weight kg	16
Capacity 2 wheels kg	250
Capacity 4 wheels kg	350

Art nr 1910057391



MAGAZINE TRUCK

Magazine truck with a fixed and a collapsible load plate.
Greater width between handles for easier handling with tool belts.
Wheel type: Massive PU foam, Puncture proof.

Item No	1910057125
Identification	GPT
Loading capacity Kg	250
Height mm	1190
Width mm	590
Wheel diameter mm	260
Wheel type	Massive
Load plate mm	470x340
Toe plate mm	420x200
Weight kg	16

Item No 1910057125



DISTRIBUTION TRUCK

Strong and robust distribution truck. Collapsible which makes it flexible and easy to transport. Side protection gives the load stability.
Wheel type: Massive PU foam, Puncture proof.

Item No	1910057115
Identification	DT
Loading capacity Kg	150
Height mm	1060
Width mm	710
Wheel diameter mm	260
Wheel type	Massive
Load plate mm	470x320
Weight kg	16

Item No 1910057115



STANDARD TRUCK

Strong and robust standard truck.

Wheel type: Massive PU foam,
Puncture proof.



Item No 1910057130

Item No	1910057130
Identification	SST
Loading capacity Kg	250
Height mm	1150
Width mm	470
Wheel diameter mm	260
Wheel type	Massive
Load plate mm	420x350
Toe plate mm	450x70
Weight kg	18

MAGAZINE TRUCK

Strong and robust magazine truck.

Wheel type: Pneumatic rubber.



Item No 1910057005

Item No	1910057005
Identification	LSP20
Loading capacity Kg	350
Height mm	1200
Width mm	460
Wheel diameter mm	260
Wheel type	Massive
Load plate mm	330x250
Weight kg	16

STEP TRUCK

Strong and robust step truck with a Toe plate and a loading platform.

Item No	1910057140
Identification	TRK 200
Loading capacity Kg	200
Height mm	1250
Width mm	550
Wheel diameter mm	150
Wheel type	Solid rubber
Load plate mm	500x350
Weight kg	21

Item No 1910057140



STEP TRUCK

Strong and robust step truck with a Toe plate

Item No	1910057006
Identification	SSPN35
Loading capacity Kg	200
Height mm	1300
Width mm	460
Wheel diameter mm	160
Wheel type	Solid rubber
Load plate mm	300x250
Weight kg	22

Item No 1910057006



COMBI TRUCK

Strong and robust 3-position combi truck with a fixed loading platform.
Wheel type: Massive PU foam, Puncture proof.

Item No	1910057135
Identification	3W
Loading capacity Kg	250
Height mm	1310
Width mm	615
Wheel diameter mm	260
Wheel type	Massive
Load plate mm	580x330
Weight kg	20



Item No 1910057135

DRUM TRUCK

Strong and robust drum truck. Supplied with a strap for safe drum handling.

Item No	1915057110
Identification	BTS
Loading capacity Kg	250
Height mm	1350
Width mm	700
Wheel diameter mm	400
Wheel type	Pneumatic rubber
Weight kg	20



Item No 1915057110

TYRE TRUCK

Flexible and easy-to-handle tyre truck for safe tyre transport.

High handles for simple and ergonomic use of the truck in a transport mode.

Wheel type: Massive PU foam, Puncture proof.

Item No	1910057100
Identification	WT
Loading capacity Kg	200
Height mm	1665
Width mm	610
Wheel diameter mm	300
Wheel type	Massive
Weight kg	20

Item No 1910057100



Item No 1970057150



Item No	1970057150
Total width mm	800
Width mm	600
Wheel type	Pneumatic rubber
Wheel diameter mm	300
Volume L	35
Weight kg	16.5

SALT & SAND CARRIER

Extra wide carrier for salt, sand and grain, etc. Long service life and stable design. Collapsible support; the length of the handle is adjustable. Pneumatic rubber wheel adapted for winter weather conditions and terrains.

The flow can easily be adjusted to the desired amount. Plastic cover to keep sand and salt dry.

CLAX, THE CLEVER FOLDING CART!

For materials handling in stores, service and office areas. Indispensable for a mechanic or salesman. Handy for the supermarket shopping.

Clax, the clever folding trolley:

- Can be collapsed quickly and easily at the push of a button.
- Has many useful features such as block brake, holding device for boxes, upward folding load platform and removable wheels for space-saving storage.
- Has two large load platforms for folding plastic boxes or beverage containers.
- Comes complete with one Folding Box, Size: 500x340Wx260mm deep inside (46-liters)



Item No	1925056100
Identification	CLAX
Upper tray capacity kg:	20
Lower tray capacity kg:	40
Total capacity kg:	60
Size assembled mm:	890x550x1030
Size folded mm:	670x470x110
Unit weight kg:	7,3



COLLAPSIBLE PLATFORM TROLLEY

Collapsible platform trolley with a telescopic loading platform. A practical trolley which is suitable for all lighter goods handling. Flexibly collapsible, occupies little room when not used or when packed in a delivery van. Two fixed wheels and two castors with a diameter of 100 mm each. Nylon wheels.



Item No 1920057260

Item No	1920057260
Length mm	710
Height mm	950
Width mm	418
Capacity kg	150
Wheel diameter mm	100
Weight kg	8



SHOP AND STORAGE TROLLEY

Stackable shop and storage trolley. A stable and flexible trolley with two shelves which can cope with a load of up to 300 kg. The surface is galvanised and the handle is covered in plastic for more comfortable use. 4 rubber-covered 125 mm castors with ball bearings for silent and easy handling.

Item No 1920057250

Item No	1920057250
Length mm	1030
Height mm	1020
Width mm	530
Capacity kg	300
Wheel diameter mm	125
Weight kg	22



PLATFORM TROLLEYS

Strong and solid platform trolleys of the highest quality. Supplied in flat-pack to ensure the best transport economy. Quick and easy assembly! The trolley is supplied with 2 fixed and 2 swivel wheels with brakes. The wheels are in solid rubber with a black band, 125 mm in diameter.

Item No	1920057610	1920057612	1920057620	1920057622
Identification	BSL 11	BSS 11	BSL 22	BSS 22
Capacity kg bottom shelf	400	400	400	400
Capacity kg top shelf	-	-	100	100
Carrying surface mm	1000x700	850x500	1000x700	850x500
Total length mm	1125	985	1250	1110
Total width mm	700	500	700	500
Total height mm	950	930	950	930
Wheel Ø 125 mm	Solid rubber	Solid rubber	Solid rubber	Solid rubber
Weight kg	25	19	40	27

Item No 1920057620



Item No 1920057610



HEAVY DUTY TROLLEY

Strong trolleys of the absolutely highest quality. Well-adapted for heavy and frequent handling of goods in the industry, warehouses, shops, etc. Flexible, you can select your design in accordance with your own needs. Supplied with four 200 mm solid rubber wheel, two of which with brakes.



Basic design



Short side end piece

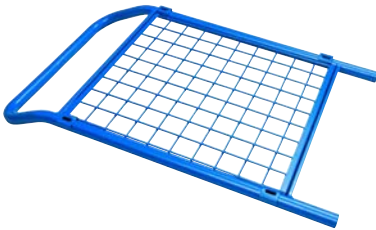

Long side end piece

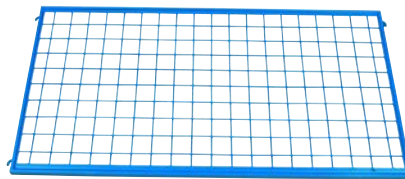

Item No	1920057310	1920057320	1920057330	1920057340
Capacity kg	800	800	800	800
Height without end pieces mm	285	285	285	285
Total height, incl. short side end piece	1050	1050	1050	1050
Total width, incl. short side end piece mm	890x520	1040x610	1040x710	1240x810
Load plate mm	835x455	985x555	985x655	1185x755
Wheel diameter mm	200x50 Solid rubber	200x50 Solid rubber	200x50 Solid rubber	200x50 Solid rubber
Weight without end pieces kg	15	20	25	35

ACCESSORIES SHORT SIDE END PIECE

Item No	1920057312	1920057322	1920057332	1920057342
Suitable for	1920057310	1920057320	1920057330	1920057340

ACCESSORIES LONG SIDE END PIECE

Item No	1920057314	1920057324	1920057344
Suitable for	1920057310	1920057320 / 1920057330	1920057340

PLATFORM TROLLEY

Platform trolley with two shelves. Solid steel frame and 10 mm-thick glued laminate board. Capacity of 150 kg evenly distributed per trolley. Supplied unassembled, incl. four rubber-covered castors, two of which with brakes.

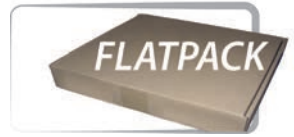

Item No 1920057210



Item No 1920057220



Item No 1920057230



Item No 1920057240



Item No.	1920057210	1920057220	1920057230	1920057240
Capacity kg bottom shelf	75	75	75	75
Capacity kg top shelf	75	75	75	75
Carrying surface per shelf mm	425x765	425x765	510x710	510x710
Total length mm	830	830	766	766
Total width mm	465	465	580	580
Total height mm	985	985	945	945
Height between shelves mm	515	515	355	355
Wheel Ø mm	125	125	125	125
Weight kg	14	14	18	18

PLATFORM TROLLEY

Platform trolley with two shelves. Solid steel frame and 10 mm thick glued laminate board. Capacity of 150 kg evenly distributed per shelf. Supplied unassembled, incl. four castors.

Item No 1920057200



Item No	1920057200
Capacity kg bottom shelf	75
Capacity kg top shelf	75
Carrying surface mm	425x765
Total length mm	830
Total width mm	465
Total height mm	985
Height between shelves mm	515
Wheel Ø mm	125
Weight kg	14

PALLET CAGE / PACKAGE CAGE

Strong and robust pallet cage. Easily and simply assembled without any tools.

You can save storage room by stacking the cages on top of each other.

Item No 2340059214



Item No	2340059210	2340059212	2340059214	2340059216
Capacity Kg:	500 per cage	500 per cage	500 per cage	500 per cage
External dimensions mm LxWxH	1200*800*800	1200*800*1000	1200*800*1200	1200*800*1600
Weight kg	25	30	35	40

CRATE / TRAY / CARTON TROLLEYS

Robust trolleys with a 600x400 mm carrying surface of durable ABS plastic for transportation of plastic crates, cartons, etc.

Item No 1925057634

Item No 1925057631



Item No	1925057630	1925057634	1925057631	1925057632
Identification:	PD 250A	PD 250A	PD 250B	PD 250C
Capacity Kg:	250	250	250	250
External dimensions: LxWxH	620x420x165 mm	620x420x165 mm	604x402x162 mm	605x402x162 mm
Weight kg:	2.8	2.8	3.8	9
Wheel diameter mm	Nylon 100 mm, 4 swivel wheels	Nylon 100 mm, 2 fixed wheels and 2 swivel wheels	Nylon 100 mm, 4 swivel wheels	Nylon 100 mm, 4 swivel wheels

TRAY / CARTON TROLLEYS

Strong galvanised crate and carton trolleys suitable for heavy and frequent use.

Available in designs with loading area dimensions: 600 x 400 and 800 x 600 mm.

4 swivel wheels.

Item No 1925057644

Item No 1925057640



Item No	1925057640	1925057644
Identification:	ZD 400A	ZD 400B
Capacity Kg:	400	400
External dimensions: LxWxH	620x420x150mm	820x620x150 mm
Weight kg:	7	9.5
Wheels:	Nylon 100 mm in diameter	Nylon 100 mm in diameter



MECHANICAL TRANSPORTER

Superb tool for moving machinery, furniture, cupboards and other bulky or heavy goods. Raised and lowered easily and safely using a crank.
Supplied in sets of two, straps included.

Item No 1951049506



Item No	1951049506
Capacity kg / set	600
Lifting height mm	300
Load plate dimensions mm	225x120

HYDRAULIC TRANSPORTER

For moving heavy machinery and furniture such as tool cupboards, safes or other heavy, cumbersome goods. The quality gearing in the pump handle makes it feel easy to lift all types of goods. The rubber-coated loading surface and the large easy-to-roll polyurethane wheels protect your goods!
Intelligently designed handle for best ergonomics and highest user protection.
Supplied in sets of two, straps included.

Item No 1951049518



Item No	1951049518
Capacity kg / set	1800
Lifting height mm	250
Load plate dimensions mm	600x60

TRANSPORT CORNER

For simple moving of furniture, machinery and other rectangular goods.
Equipped with a ribbed rubber surface to protect the goods during transport.
One set includes 4 corners.

Item No 1951049000



Item No	1951049000
Capacity kg	600
External dimensions mm	366x204x85
Load height above the floor mm	15
Wheel dimensions mm	50x20
Weight kg/set	8

PLATFORM SCOOTER

For quick indoor transport of personnel and goods. Scooter with parallel steering and solid rubber wheels with ball bearings. Footplate with anti-slip protection and a powerful foot brake for the rear wheel. Wheels: 200 mm rubber.

Platform size 690x585 mm. Turning radius 1200 mm. Total loading capacity 150 kg (incl. driver).

- Adjustable steering wheel

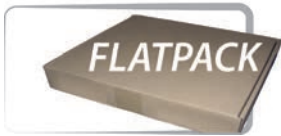

Item No 1918058020

FLEXIBLE ROLLER CONVEYOR

The flexible roller conveyor is adjustable and can easily be adapted as required. Vertically adjustable. Wheels with brakes. The rollers are a bit higher than the track, which means that goods wider than the track can be handled.

Item No 1211039000



Item No	1211039000
Max length / section mm	1295
Loading capacity kg / section	136
CC roller / roller max extension mm	170
Distance between rollers mm	125
Adjustable height mm	660 - 940
Weight kg/set	27

- Easy to assemble sections to achieve the desired length.
- Chrome-plated rollers 42 x 500 mm.
- Recessed 419 mm/section.
- 4 wheels with brakes Ø 100 mm.
- 9 rollers/section.

SHOP LIFTER

Shop lifter for flexible use of 1/4 pallets.

Mechanical raise/lower function with foot pedal.

Item No	1151041820
Min fork height mm	95
Max fork height mm	120
Fork length mm	580
Fork width mm	210
Capacity Kg	200
Weight kg	21

Item No 1151041820



MECHANICAL HAND PALLET TRUCK

Mechanical hand pallet truck, Lifts pallets quickly and flexibly by simply pulling the handle backWards.

- Collapsible
- Extremely low weight (26 kg).
- Easy to transport, e.g. by car.

Item No	1150041810
Capacity kg	300
Min lifting height mm	85
Max lifting height mm	145
Fork length mm	800
Fork width mm	420
Total height mm	1170
Steering wheel	80x40
Fork wheel	80x40
Weight kg	31
Wheels Ø 125 mm	Nylon

Item No 1150041810





HAND PALLET TRUCK DF 1600

The lightest and most flexible hydraulic hand pallet truck on the market, perfect for those handling lighter goods! You will feel the difference immediately due to its low weight of only 50 kg. Equipped with polyurethane bogie wheels for soft and quite transport, even on uneven surfaces.

Item No 1110041604

Item No	1110041604
Capacity kg	1600
Min lifting height mm	75
Max lifting height mm	190
Fork length mm	1150
Fork width mm	520
Fork size mm	150x50
Steering wheel	180x50 Polyurethane
Fork wheel	(75x55 mm) Polyurethane/Bogie
Weight kg	50



PT2 STANDARD PALLET TRUCK

- Compact and strong pump for long service life
- One-piece pressed forks for heavy handling
- Maintenance-free ball bearings
- Single climbing wheel
- Flexible to manoeuvre with 230° turning radius
- Overload valve
- 3-position control in the handle
- Lifts pallets in three pump strokes

Item No	1112040000	1112041504	1112041513
Capacity kg	2000	2000	2000
Max lifting height mm	200	200	200
Min lifting height mm	85	85	85
Fork length mm	1150	1150	915
Fork width mm	520	520	520
Fork size mm	160x60	160x60	160x60
Steering wheel 180x50	Nylon	Polyurethane	Polyurethane
Fork wheel	80x93 Nylon/Single	80x70 Poly/Bogie	80x93 Poly/Single
Weight kg	70	70	65

Item No 1112041504

STOP IT

Unique stop-it brake in rubber that holds all types of pallet trucks in place during transport or simply keeps them in a permanent place in the workplace when they are not in use.

Dimensions mm: 310x310x40



Item No 8710000100

PL 2000 QUICKLIFT

- Quicklift function for up to 150 kg
- Lifts pallets in one pump stroke
- Overload valve
- Double climbing wheel
- Rounded fork ends simplify the handling of all goods
- Maintenance-free ball bearings
- Turning radius of 230 degrees
- Comfortable, coated handle
- Available in several fork lengths and wheel alternatives
- Quicklift is most suitable for lighter loads.

Capacity 2000 kg.

Item No 1115040004



Item No	Max lifting height mm	Min lifting height mm	Fork length mm	Fork width mm	Fork size mm	Steering wheel 180x50 mm	Fork wheel mm	Weight Kg
1115040001	200	85	1150	520	160	Nylon	Nylon/Single 80x93 mm	75
1115040002	200	85	1150	520	160	Nylon	Nylon/Bogie 80x70 mm	75
1115040003	200	85	1150	520	160	Rubber	Poly/Single 80x93 mm	75
1115040004	200	85	1150	520	160	Rubber	Poly/Bogie 80x70 mm	75
1115041001	200	85	915	520	160	Nylon	Nylon/Single 80x93 mm	70
1115041002	200	85	915	520	160	Nylon	Nylon/Bogie 80x70 mm	70
1115041003	200	85	915	520	160	Rubber	Poly/Single 80x93 mm	70
1115041004	200	85	915	520	160	Rubber	Poly/Bogie 80x70 mm	70
1115041011	200	85	800	520	160	Nylon	Nylon/Single 80x93 mm	68
1115041013	200	85	800	520	160	Rubber	Poly/Single 80x93 mm	68
1115041021	200	85	650	520	160	Nylon	Nylon/Single 80x93 mm	65
1115041023	200	85	650	520	160	Rubber	Poly/Single 80x93 mm	65

LIFTWELL 22

- Chassis in accordance with own drawing
- Several grease nipples in strategic places
- Hydraulics with an overflow valve
- Ball bearings in the top for easier steering
- Large selection of lengths and wheel models
- Equipped with climbing wheels in front

Fork length 600 mm - 1150 = capacity 2000 kg.

Fork length 1520 - 2300 = capacity 1500 kg

Item No 1111300511



Item No	Max lifting height mm	Min lifting height mm	Fork length mm	Fork width mm	Fork size W x H mm	Steering wheels 180x50 mm	Fork wheel mm	Weight-Kg
1111300501	200	85	600	520	160x60	Nylon	Nylon/Single	58
1111300621	200	85	600	520	160x60	Polyurethane	Poly/Single	58
1111300516	200	85	810	520	160x60	Nylon	Nylon/Single	62
1111300534	200	85	810	520	160x60	Polyurethane	Poly/Single	62
1111300502	200	85	910	520	160x60	Nylon	Nylon/Single	65
1111300505	200	85	910	520	160x60	Nylon	Nylon/Bogie	65
1111300513	200	85	910	520	160x60	Polyurethane	Poly/Single	65
1111300514	200	85	910	520	160x60	Polyurethane	Poly/Bogie	65
1111300503	200	85	1150	520	160x60	Nylon	Nylon/Single	70
1111300504	200	85	1150	520	160x60	Nylon	Nylon/Bogie	70
1111300512	200	85	1150	520	160x60	Polyurethane	Poly/Single	70
1111300511	200	85	1150	520	160x60	Polyurethane	Poly/Bogie	70
1111300095	200	85	1520	520	160x60	Polyurethane	Poly/Bogie	85
1111300096	200	85	1820	520	160x60	Polyurethane	Poly/Bogie	92
1111300097	200	85	2100	520	160x60	Polyurethane	Poly/Bogie	105
1111300098	200	85	2300	520	160x60	Polyurethane	Poly/Bogie	112

HPT 2500

Professional and ideal transport help for all variety of manual transport tasks over short distances in stores and warehouses as well as factory plants. Reliable, sturdy, torsion-resistant due to its extremely strong high quality steel profile.

Item No	1125041032	1125041034	1125041036	1125041038
Capacity Kg	2500	2500	2500	2500
Max lifting height mm	200	200	200	200
Min lifting height	85	85	85	85
Fork length mm	1150	1150	800	1150
Fork width mm	540	540	540	540
Fork size mm	160x48	160x48	160x48	160x48
Steering wheel 180x50	Polyurethane	Nylon	Polyurethane	Nylon
Fork wheel 80x70 mm	Polyurethane/Bogie	Nylon/Bogie	Polyurethane/Single	Nylon/Single
Weight kg	72	72	70	72

Item No 1125041036



Item No 1125041038



Item No 1125041032



AM2200

The AM2200 hand pallet truck is the ideal warehouse aid for all manual transportation.

Here are a couple of advantages:

- * Quicklift by default
- * Very silent
- * Easy to handle
- * Robust and durable
- * Teflon-coated ball bearings make it very easy to roll
- * Patented handle, suitable for both right- and lefthanded users.

Capacity: 2200 kg.

Fork wheel single = 82x96 mm
Fork wheel bogie = 82x62 mm



Item No 1122064005

Item No	Max lifting height mm	Min lifting height mm	Fork length mm	Fork width mm	Fork size W x H mm	Steering wheel 170x50 mm	Fork wheel mm	Weight Kg
1122064032	205	83	795	520	150x53	Rubber	Rubber/Single	51
1122064033	205	83	795	520	150x53	Rubber	Rubber/Bogie	51
1122064004	205	83	1150	520	150x53	Nylon	Nylon/Single	58
1122064005	205	83	1150	520	150x53	Vulkollan	Vulkollan/Single	58
1122064006	205	83	1150	520	150x53	Vulkollan	Vulkollan/Bogie	58
1122064039	205	83	1150	520	150x53	Nylon	Nylon/Bogie	58
1122064040	205	83	1150	520	150x53	Rubber	Rubber/Single	58
1122064041	205	83	1150	520	150x53	Rubber	Vulkollan/Bogie	58

AC 3000

The most robust and strongest hand pallet truck on the market, perfect for those of you who regularly handle heavy and demanding goods! Its many reinforcements and smart design will make the difference visible immediately! The brake also guarantees you safety during transport; if you lose control over the load, press the brake and the truck will stop. Galvanised pump and brake. The standard version is supplied with a foot brake; smart when you park on a truck's loading platform or an uneven sloping surface. Double climbing wheel.

Item No 1130041204

Item No	1130041202	1130041204
Capacity kg	3000	3000
Fork length mm	1150	1800
Fork width mm	520	520
Max lifting height mm	200	200
Min lifting height mm	85	85
Fork wheel	Bogie/Pu* 80x70 mm	Bogie/Pu* 80x70 mm
Steering wheel 180x50	Polyurethane	Polyurethane
Weight kg	80	200



STRONGEST!
LIFTS UP TO 3000 KG. FOOT BRAKE!

LOW PROFILE HAND PALLET TRUCKS

For handling of special pallets.

Item No 1140040007

Item No	1140040007	1140040008
Capacity kg	1500	1000
Min lifting height mm	51	35
Max lifting height mm	175	90
Fork length mm	1150	1150
Fork width mm	520	520
Fork height mm	160	160
Steering wheel 180x50	Polyurethane	Polyurethane
Fork wheel (50x70 mm)	Polyurethane/ Bogie	Steel/Bogie
Weight kg	70	65



Item No 1140040008



GALVANISED AND STAINLESS HAND PALLET TRUCK

Galvanised and stainless steel trucks are designed for tough climates and work places with high cleanliness requirements.

Item No	1115040203	1145040205
Type	Galvanised	Stainless weighing truck
Capacity kg	2000	2000
Min lifting height mm	85	85
Max lifting height mm	200	200
Fork length mm	1150	1150
Fork width mm	520	520
Fork height mm	160	160
Steering wheel 180x50	Nylon	Nylon
Fork wheel (50x70 mm)	Nylon/Bogie	Nylon/Bogie
Weight kg	75	78

Stainless weighing truck
Tolerance: ± 20 Kg
Graduation: 5 kg
Battery: 2 pc AA included!



Item No 1115040203



Item No 1145040205



PL 2000 WEIGHING TRUCK, ACCURATE

Tolerance: ± 1 Kg
 Battery: 4 pcs, LR6 included!
 Single climbing wheel.



Item No 1820042001

Item No	1820042001
Type	Weighing
Capacity Kg	2000
Min lifting height mm	88
Max lifting height mm	200
Fork width mm	568
Fork length mm	1150
Fork size	160
Fork wheel \varnothing 74 x 70 mm	Pu*/Bogie
Steering wheel \varnothing 180 x 50 mm	Rubber
Weight kg	85

HP-ESE-D WEIGHING TRUCK, INDICATION

Tolerance: ± 20 Kg
 Graduation: 5 kg
 Battery: 2 pc AA included!

Check water level meter to confirm the correct weighing height.



Item No 1820042004

Item No	1820042004	1820042006	1820042007
Type	Weighing	Weighing	Weighing
Capacity Kg	2000	2000	2000
Min lifting height mm	85	85	85
Max lifting height mm	200	200	200
Fork width mm	540	540	540
Fork length mm	1150	1150	1150
Fork size	160x50	160x50	160x50
Fork wheel \varnothing 70 x 80 mm	Bogie/ Polyurethane	Singel/ Nylon	Bogie/ Nylon
Steering wheel \varnothing 180 x 50 mm	Polyurethane	Nylon	Nylon
Weight kg	75	74	75



- Saves storage space
- Protects the back and shoulders of the staff
- Less damaged goods
- Time gains
- Easier and faster handling
- Quick payback period

Item No 1891041700



We have been appointed a European distributor for a world-unique patented solution for hand and motorised pallet trucks which significantly simplifies the handling of the trucks, saves time and money and guards the backs and shoulders of the staff. Turn@bout is the marketing name of the product which comes from the English word for a complete turnaround. Turn@bout consists of two additional wheels which are installed on the fork and allow the truck to rotate freely on the site.

Cramped in the warehouse or on the truck platform? Difficult to put the hand truck in place in order to reach something? Install a Turn@bout manoeuvrability adapter to the hand truck and let the truck become an extension of your arm. The length of the truck becomes equal to the swing diameter and the space for manoeuvres improves by 72%. No more lifting, prizing and kicking in order to put the truck into position. The time gains realised through the easier and faster handling of the truck allow for a quick pay-off of the investment. In addition, you get less damaged goods, save storage space and guard the backs of your staff.



SUPPLIED COMPLETE AS IN THE PICTURE, INCL. INSTALLATION INSTRUCTIONS

**TURNING RADIUS FOR TURN@BOUT ON
HAND- AND MOTORISED PALLET TRUCK**

■ **STANDARD TURNING RADIUS \varnothing 2540 mm**

■ **WITH Turn@bout \varnothing 1540 mm**



■ **STANDARD TURNING RADIUS \varnothing 2980 mm**

■ **WITH Turn@bout \varnothing 1800 mm**



Turn@bout™

SCISSOR LIFT

Manual scissor lift with a telescopic cylinder.
Automatic quicklift, 38 mm/pump stroke up to 150 kg. 20 mm/pump stroke. 28-29 pump strokes to full height.

Above 150 kg the lift height per pump stroke is 20 mm.

Item No 1830043000



Item No	1830043000	1830043015
Piston type	Telescopic	Telescopic
Capacity Kg	1000	1000
Min lifting height mm	85	85
Max lifting height mm	800	795
Fork width mm	540	540
Fork length mm	1150	1500
Fork size	160	160
Fork wheel Ø 80 x 50 mm	Polyurethane	Polyurethane
Steering wheel Ø 180 x 50 mm	Rubber	Rubber
Weight kg	90	110

2-step piston, automatic quicklift.
With a fork length of 1150 mm or 1500 mm

SCISSOR LIFT

Manual scissor lift with a single cylinder.

Manual switchable quicklift
38 mm/pump stroke up to 150 kg.

Single piston, manual quicklift

Item No 1830043020



Item No	1830043020
Piston type	Single piston
Capacity Kg	1000
Min lifting height mm	85
Max lifting height mm	800
Fork width mm	540
Fork length mm	1150
Fork size	160x50
Fork wheel Ø 78 x 60 mm	Polyurethane
Steering wheel Ø 180 x 50 mm	Rubber
Weight kg	125

STAINLESS SCISSOR LIFT

Rust-proof scissor lift for tough climates and workplaces with high cleanliness requirements.

Item No	1830043002
Piston type	Telescopic
Capacity Kg	1000
Min lifting height mm	85
Max lifting height mm	800
Fork width mm	540
Fork length mm	1150
Fork size	160
Fork wheel Ø 80 x 100 mm	Nylon
Steering wheel Ø 180 x 50 mm	Nylon
Weight kg	90

Rust-proof scissor lift, 2-step piston

Item No 1830043002



SCISSOR LIFT

The compact design with a battery and a pump unit positioned between the chassis and cylinder provides superior manoeuvrability and accessibility.

Often used as an ergonomic aid for guarding the back, neck and shoulders. Possible to both pump and lower manually if the battery is run-down.

Lift without load - 11 sec.

Lift with load - 19 sec.

Electric scissor lift, single piston. Battery 12v/70 Ah. External charger 5 A/12 V
Operating voltage of 220 V.

Item No 1832043010

Item No	1832043010
Piston type	Single piston
Capacity Kg	1000
Min lifting height mm	85
Max lifting height mm	800
Fork width mm	540
Fork length mm	1150
Fork size	160
Fork wheel Ø 50 x 75 mm	Polyurethane
Steering wheel Ø 180 x 50 mm	Polyurethane
Weight kg	169



LIFTING TABLE PL LBM

Manual lifting table the height of which is adjusted with a crank. Two fixed wheels and two castors. Foot protection on the swivel wheels and brakes!

Item No 1860050301



Item No	1860050301
Identification	PL LBM
Capacity Kg	300
Min lifting height mm	450
Max lifting height mm	1050
Carrying surface mm	950x600
Load plate	Steel
Wheel Ø polyurethane	125
Cycles to max height	75
Weight kg	70

LIFTING TABLE PL150-500 LB

Hydraulic lifting table in three versions. Load capacity of 150 to 500 kg. The tables are equipped with a quicklift pump. The lifting is easily adjusted with a foot pump and the lowering with a manual hand lever control. Two fixed wheels and two castors. Foot protection on the swivel wheels and brakes!

Item No	1860051015	1860051030	1860051050
Identification	PL150 LB	PL 300 LB	PL 500 LB
Capacity Kg	150	300	500
Min lifting height mm	220	340	355
Max lifting height mm	720	880	880
Carrying surface mm	700x450	850x500	850x500
Load plate	3 mm, chrome-plated steel	3 mm, chrome-plated steel	3 mm, chrome-plated steel
Wheel Ø polyurethane	100	125	125
Cycles to max height	28	26	26
Handle -	Collapsible	Collapsible	Collapsible
Handle height mm	950	990	990
Weight kg	46	77	81

Item No 1860051030



LIFTING TABLE PL 750

Manual lifting table in two versions where the height is adjusted with a foot pump. The table is lowered with a manual hand lever control. Two fixed wheels and two castors. Foot protection on the swivel wheels and brakes!.

Item No 1860051075

Item No	1860051075
Identification	PL 750 LB
Capacity Kg	750
Min lifting height mm	420
Max lifting height mm	900
Carrying surface mm	1000x510
Load plate	3 mm, chrome-plated steel
Wheel Ø polyurethane	150
Cycles to max height	45
Handle	Fixed
Handle height mm	1000
Weight kg	125



LIFTING TABLE PL 350 LBD

Hydraulic lifting table with double scissors. Equipped with a quicklift pump. The raising is easily adjusted with a foot pump and the lowering with a manual hand lever control. Two fixed wheels and two castors. Foot protection on the swivel wheels and brakes!.

Item No 1860051035

Item No	1860051035
Identification	PL 350 LBD
Capacity Kg	350
Min lifting height mm	355
Max lifting height mm	1300
Carrying surface mm	910x500
Load plate	3 mm, chrome-plated steel
Wheel Ø polyurethane	125
Cycles to max height	53
Handle	Fixed
Handle height mm	975
Weight kg	105



ELECTRIC LIFTING TABLE

Electric lifting table on wheels. The table is lowered and raised with hand control. Two fixed wheels and two castors. Foot protection on the swivel wheels and brakes!



Item No 1865052050

Built-in 24V /4A charger
2x22 Ah battery

Item No	1865052050
Identification	PL 500-LB EL
Capacity Kg	500
Min lifting height mm	440
Max lifting height mm	1025
Carrying surface mm	1010x520
Load plate	3 mm chrome-plated steel
Wheel Ø polyurethane	150 x 48
Cycles to max height	12 sec
Handle	Fixed
Handle height mm	990
Lifting motor	0.8 kW/24V
Weight kg	160

STATIONARY LIFTING TABLES

Electric lifting tables for best ergonomics and working environment. The stationary electro-hydraulic lifting tables are suitable for all types of work and installations. Very useful in the industry and warehouses. 100% welded bottom frame and integrated hydraulics.

1321053150 & 1321053200 are equipped with double pistons.

We recommend to fix the table in the ground!

Item No	1321053100	1321053150	1321053200
Identification	PLN 1000	PLN 2000	PLN 3000
Capacity Kg	1000	2000	3000
Min table height mm	235	235	235
Max table height mm	1010	1010	1010
Carrying surface mm	1300x800	1300x800	1300x800
Lifting speed loaded mm/sec	40	22	30
Lowering speed loaded mm/sec	400 V/16Ah	400 V/16Ah	400 V/16Ah
Power supply	400 V/16Ah	400 V/16Ah	400 V/16Ah
Hydraulic motor	0.75 kW	0.75 kW	1.5 kW
Weight kg	220	280	320
External dimensions underframe mm	1260x710	1260x710	1260x710



Item No 1321053100

- Simple control unit
- Crush protection frame

STATIONARY U-SHAPED LIFTING TABLE

Electric lifting table for best ergonomics and working environment.

Stationary electro-hydraulic U-shaped lifting table which is suitable for all types of work and installations. Very useful in the industry and warehouses. 100% welded bottom frame and integrated hydraulics.

- Simple control unit
- Crush protection frame

Item No	1321054100
Identification	U-shaped lifting table
Capacity Kg	1000
Min table height mm	85
Max table height mm	760
Carrying surface mm	1450x1140
Lifting speed loaded mm/sec	42
Lowering speed loaded mm/sec	48
Power supply	400 V/16Ah
Hydraulic motor	1.5 kW
Weight kg	235
External dimensions underframe mm	1340x1070

Item No 1321054100



STATIONARY LIFTING TABLE WITH RAMP

Electric lifting table for best ergonomics and working environment.

Stationary electro-hydraulic lifting tables with ramps which are suitable for all types of work and installations. Very useful in the industry and warehouses. 100% welded bottom frame and integrated hydraulics.

- Included ramp
- Simple control unit
- Crush protection frame

Item No	1321053250
Identification	Lifting table with ramp
Capacity Kg	1000
Min table height mm	85
Max table height mm	760
Carrying surface mm	1450x1140
Lifting speed loaded mm/sec	42
Lowering speed loaded mm/sec	48
Power supply	400 V/16Ah
Hydraulic motor	1.5 kW
Weight kg with ramp 250	250
External dimensions ramp mm WxB	1140x885

Item No 1321053250



MINI STACKER MANUAL & ELECTRIC

Hydraulic stacker and mobile lifting table equipped with both forks and a detachable platform. Manual stacker with a foldable pump lever for lifting and a manual handle for lowering. The electrical stacker has a large battery and a built-in charger.

Item No 1841044211



Item No 1840044110



Item No	1840044080	1840044110	1840044115	1841044211	1841044215
Identification	PL-800 HST	PL-1100 HST	PL-1500 HST	PL-1100 HST-EL	PL 1500 HST-EL
Capacity Kg	400	400	400	400	400
Lifting height mm	85-850	85-1200	85-1500	85-1200	85-1500
Lifting speed loaded	20	20	20	80 mm/sec	80 mm/sec
Battery	-	-	-	12V/60Ah	12V/60Ah
Lifting motor	-	-	-	700 W	700 W
Fork width mm	550	550	550	550	550
Fork length mm	650	650	650	650	650
Fork wheel Ø mm Polyurethane	75x40	75x40	75x40	75x40	75x40
Steering wheel Ø mm Polyurethane	127x40	127x40	127x40	127x40	127x40
Weight kg	75	81	91	118 incl. battery	126 incl. battery
Total height mm	1074	1425	1725	1425	1725
Total width mm	600	600	600	600	600
Total length mm	1035	1035	1035	1100	1100

LIGHT LIFTER / LV-150

Light, flexible and easily manoeuvred lifting truck with a loading plate and forks underneath. It takes care of those lifts that are "harmful" to the body. Powerful when needed but occupies little place when not in use.

Suitable for many different applications in pharmacies, libraries, kitchens, shops, warehouses, the workshop industry, etc.

Supplied with an external charger (charging capacity 24V/1.8 Ah), operating voltage 220 V.

Item No 1843044000

Item No	1843044000
Identification	LV-150
Capacity Kg	150
Lifting height mm	1550
Lifting speed loaded	125 mm/sec
Lowering speed unloaded/loaded	85/101 mm/s
Battery	7 Ah/12V x 2
Lifting motor	24V drive motor
Load plate mm	460x520
Fork wheel Ø mm Polyurethane	75x32
Steering wheel Ø mm Polyurethane	100x32
Weight kg	58
Total height mm	1830
Total width mm	520
Total length mm	880



LIGHT LIFTER / E100A-E150A

Light, flexible and easily manoeuvred lifting truck with a load plate as a standard design. Designed to relieve the back and shoulders in connection with all types of lifting.

Available in 2 models with a capacity of 100 or 150 kg. The platform is 470x600 mm.

Equipped with Ø 75-mm swivel fork wheels and Ø 125-mm wheels with brakes.

Item No	1843044040	1843044042
Identification	E 100A	E150A
Capacity Kg	100	150
Lifting height mm	1700	1500
Lifting speed unloaded/loaded	83/70 mm/s	83/70 mm/s
Lowering speed unloaded/loaded	85/101 mm/s	85/101 mm/s
Battery	24V/12Ah	24V/12Ah
Lifting motor	24 V drive motor	24 V drive motor
Load plate mm	600x470	600x470
Fork wheel Ø mm Polyurethane	75	75
Steering wheel Ø mm Polyurethane	125	125
Weight kg	66	63
Total height mm	1990	1790
Total width mm	600	600
Total length mm	840	840



Item No 1843044040

Roll turner Item No 1233044046



V-Block Item No 1233044047

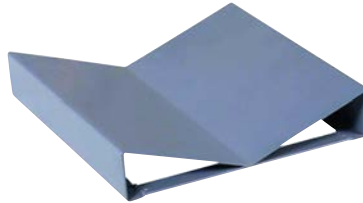

Double carpet boom Item No 1233044045



ACCESSORIES

Single roll pike:
Ø 47 mm, length 600 mm.

Double roll pike:
Ø 47 mm, length 450 mm.

V block:
400x400 mm, maximum height 80 mm

Roll turner:
Maximum size Ø 500 mm and depth 250 mm. Inner Ø 74-80 mm.

Single carpet boom Item No 1233044044



BALDER STACKER ELECTRICAL AND MANUAL

A compact stacker of a stable design with ergonomic tilt. The pallet is raised to the correct work height and the sideways tilt makes the work comfortable and ergonomic. Available in manual and electric versions. The tilt is manual on both types. The design is very compact and is, therefore, suitable for narrow spaces. Brakes on both wheels.

TILT ANGLE 40°

Item No 1841045511



Item No	1840045510	1841045511
Identification	Ergo – Manuell	Ergo - EL
Capacity Kg	800	800
Lifting height mm	900	900
Lifting capacity / during tilting:	800/400	800/400
Total height mm	1230	1420
Total width mm	730	730
Total length mm	1630	1690
Fork length mm	1140	1140
Width above forks mm	540	540
Fork width mm	150	150
Fork height lowered mm	87	87
Weight kg	218	230 (without battery)
Swing radius mm	1500	1500
Lifting height/pump stroke loaded	18 mm -	-
Steering wheel mm	200x50	200x50
Fork wheel mm	82x90	82x90
Tilt angle	40°	40°
Battery	-	2x12 V / 60 Ah
Charger	-	External 10A/12V
Lifting speed with load	18 mm per pump stroke	50 mm /sec
Hydraulic motor	-	700 w / 12 V

Item No 1840045510



MANUAL TILT



MANUAL STACKERS

Strong and robust stacker. Equipped with foot and hand pump for the best ergonomics.

Ergonomically designed stacker with a foot pump, protects both the back and the shoulders. It is also possible to use the handle to pump up the forks. The stackers are built for professional use and supplied with a foot brake on both wheels.

- Fork wheel & Steering wheel = Nylon

Item No 1840043160



Item No	1840043080	1840043160	1840043250
Identification	PL 800 ST	PL 1600 ST	PL 2500 ST
Capacity kg	1000	1000	1000
Min lifting height mm	85	85	85
Max lifting height mm	800	1600	2500
Total height max mm	1200	1980	3050
Total height min mm	1200	1980	1830
Total width mm	850	850	850
Total length mm	1980	1980	1980
Fork length mm	1150	1150	1150
Fork width mm	550	550	550
Fork wheel Ø mm	Bogie 74 x 55	Bogie 74 x 55	Single 74 x 55
Steering wheel Ø mm	180 x 50	180 x 50	180 x 50
Turning radius	1380 mm	1380 mm	1380 mm
Weight kg	180	220	300

SEMI ELECTRONIC STACKERS.

Manually moved stackers with a battery-powered lifting motor. Ergonomic handling for frequent heavy lifts. The stacker is completely adapted to its work tasks. Loading and unloading, as well as stacking of palletized goods. The powerful battery provides a long operating time per charge. Foot brakes on both steering wheels.

Easy-to-service construction of the hydraulics, distribution box and battery.

- Efficient and ergonomic lifting tool.
- Supplied complete with a battery and an external charger.
- Easy-to-read battery indicator for control of the capacity of the battery.
- Charger, 10 A/12V, operating voltage of 220 V.



Item No 1841043165

Item No	1841043085	1841043165	1841043255	1841043355
Identification	PL 800 ST-EL	PL 1600 ST-EL	PL 2500 ST-EL	PL 3350 ST-EL
Capacity kg	1000	1000	1000	1000
Lifting height mm	800	1600	2500	3350
Total height max mm	1200	1980	3070	3570
Total height min mm	1200	1980	1830	2250
Total width mm	770	770	770	770
Total length mm	1720	1720	1720	1720
Fork length mm	1150	1150	1150	1150
Fork width mm	570	570	570	570
Lifting motor	1.5 kW	1.5 kW	1.5 kW	1.5 kW
Lifting speed with load mm/s	90	90	90	90
Lowering speed with/without load mm/s	120/100	120/100	120/100	120/100
Battery	12V/85 Ah	12V/85 Ah	12V/85 Ah	12V/85 Ah
Charger	12V/20Ah	12V/20Ah	12V/20Ah	12V/20Ah
Fork wheel Ø mm bogie/nylon	74x70	74x70	74x70	74x70
Steering wheel Ø mm nylon	180x50	180x50	180x50	180x50
Weight kg incl. battery	300	350	410	430
Turning radius mm	1280	1280	1280	1280

EPT / SPT15N Motorised Pallet truck

Compact semi- or full electric pallet truck. Semi electric version lifts manually and run electrically. Full electric version run and lift electrically. Small like a normal manual hand pallet truck but saves the body from wear and tear thanks to its traction. Support wheels on the sides to prevent the truck to become unstable during transport of goods with a high gravity.

Item No	1415045018	1415045016
Identification	EPT 15	SPT15N
Capacity Kg	1500	1500
Min fork height mm	85	85
Lifting height mm	115	115
Centre of gravity separation	600	600
Fork width mm	540	540
Fork length mm	1150	1150
Driving speed with/without load km/h	4.2/4.6	4.2/4.6
Lifting speed with/without load mm/s	30/53	manual
Lowering speed with/without load mm/s	49/36	manual
Turning radius mm	1445	1507
Drive motor	0.45 kW	0.45 kW
Lifting motor	0.8 kW	manual
Battery V/Ah	2x12/64	2x12/38
Charger	Built-in	Built-in
Fork wheel Ø mm Polyurethane	80 x 70	80 x 70
Drive wheel Ø mm	220 x 70	220 x 70
Total width mm	560	560
Weight kg incl. battery and pedal	190	165



Item No 1415045018



ECL Pedestrian Stacker 1000 kg

The ECL is an economic walkie-electric stacker, with rated capacity of 1000kg an lifting high 1600mm, 2900mm and 3500mm. The compact and light design is suitable for a variety low duty applications in warehouses.

Item No 1615045006



Item No	1616045003	1615045004	1615045006
Identification	ECL1016	ECL 1029	ECL1035
Capacity Kg	1000	1000	1000
Min fork height mm	85	85	85
Lifting height mm	1530	2840	3440
Centre of gravity separation	600	600	600
Min support height	1950	1950	2250
Max support height	1950	3325	3925
Total width mm	800	800	800
Free lift mm	1530	70	70
Fork width mm	570	570	570
Fork length mm	1150	1150	1150
Driving speed without/with load km/h	4.5/4.3	4.5/4.3	4.5/4.3
Lifting speed without/with load mm/s	160/110	160/110	160/110
Lowering speed without/with load mm/s	110/130	110/130	110/130
Drive motor	0.45 kW	0.45 kW	0.45 kW
Lift motor	2.2 kW	2.2 kW	2.2 kW
Truck battery	85Ah/24V	85Ah/24V	85Ah/24V
Charger	Built-in	Built-in	Built-in
Fork wheel mm	Polyurethane 80 x 93	Polyurethane 80 x 93	Polyurethane 80 x 93
Drive wheel mm	220 x 70	220 x 70	220 x 70
Gradient capacity without/with load	5/10%	5/10%	5/10%
Brake	Electromagnetic	Electromagnetic	Electromagnetic
Speed regulation	Electronic ipulse	Electronic impulse	Electronic impulse
Weight kg including battery	430	510	540
Turning radius mm	1485	1485	1485
Overall length	1800	1800	1800
Ground clearance centre of wheelbase	29	29	29

PT15 Motorised Pallet Truck 1500 kg

The PT15 is the economical solution for all medium applications in transporting operations or delivery applications on lorries with tail lifts. It accelerates any occasional order picking operations. The PS10M based on the same reliable components and design-character as the PT15 with monomast for perfect view to the loads.

Item No	1413045014
Identification	PT15
Capacity Kg	1500
Min fork height mm	85
Lifting height mm	120
Centre of gravity separation	600
Fork width mm	520
Fork length mm	1150
Driving speed with/without load km/h	5.5/5.5
Lifting speed with/without load mm/s	27/35
Lowering speed with/without load mm/s	42/27
Turning radius mm	1480
Drive motor	0,9 kW
Lifting motor	0.8 kW
Battery V/Ah	2x12/85
Charger	Built-in
Fork wheel Ø mm Polyurethane	84 x 70
Drive wheel Ø mm	252 x 89
Total width mm	700
Weight kg incl. battery	288

Item No 1413045014



PS10M Pedestrian Stacker 1000 kg

The PT15 is the economical solution for all medium applications in transporting operations or delivery applications on lorries with tail lifts. It accelerates any occasional order picking operations. The PS10M based on the same reliable components and design-character as the PT15 with monomast for perfect view to the loads.

Item No	1616045005
Identification	PS10M
Capacity Kg	1000
Residual capacity Kg	1000
Min fork height mm	85
Lifting height mm	1530
Centre of gravity separation	600
Min support height	1970
Total width mm	692
Fork width mm	540
Fork length mm	1150
Driving speed without/with load km/h	5.5/5.5
Lifting speed without/with load mm/s	197/76
Lowering speed without/with load mm/s	106/110
Drive motor	0.9 kW
Lifting motor	1.2 kW
Battery V/Ah	2x12/106
Charger	Built-in
Fork wheel mm Polyurethane	84x70
Drive wheel mm	252/89
Gradient capacity without/with load	10/5 degrees
Brake	Electromagnetic
Speed regulation	AC-SpeedControl/ DC
Weight kg incl. battery	536
Turning radius mm	1360
Noise level, driver	70 dB
Mast type	Simplex



Item No 1616045005



PT20 Motorised Pallet Truck 2000 kg

Electric pallet truck with electronic power steering and stand on platform with side protections make the working day easier and safer. It does not get easier to handle goods in tight working areas than with this full electric pallet truck with power steering. Strong and robust with crucial details for the convenience of the user.

Item No	1413045021
Identification	PT20
Capacity Kg	2000
Min fork height mm	85
Lifting height mm	120
Centre of gravity separation	600
Fork width mm	540
Fork length mm	1150
Driving speed with/without load km/h	6.0/6.0
Lifting speed with/without load mm/s	27/35
Lowering speed with/without load mm/s	42/27
Turning radius mm	1585
Drive motor	1.3 kW
Lifting motor	0.8 kW
Battery V/Ah	2x12/200
Charger	Built-in
Fork wheel Ø mm Polyurethane	84 x 84
Drive wheel Ø mm	230 x 75
Total width mm	729
Weight kg incl. battery and pedal	638

POWER STEERING



Item No 1413045021



PT1534 FFL / PS16W Pedestrian Stacker

Electric power stackers for the really high lifts with electronic power steering and stand on platform with side protections makes the working days easier and safer. It does not get easier to handle goods in tight warehouses with high racking than with this full electric pallet stacker with power steering. Strong and robust with crucial details for the convenience of the user.

Item No 1613045461



Item No	1613045321	1613045461
Identification	PSB 1534 FFL	PS16W
Capacity Kg	1500	1600
Min fork height mm	85	85
Lifting height mm	3400	4600
Centre of gravity separation	600	600
Min support height	1695	2105
Max support height	3943	5112
Total width mm	910	1050
Free lift mm	1104	-
Fork width mm	570	570
Fork length mm	1150	1150
Driving speed without/with load km/h	6.0/6.0	6.0/6.0
Lifting speed without/with load mm/s	150/105	160/150
Lowering speed without/with load mm/s	110/130	95/120
Drive motor	1.3 kW	1.3 kW
Lift motor	3 kW	3 kW
Truck battery	210Ah/24V	280Ah/24V
Charger	External	External
Fork wheel mm	Polyurethane 80 x 70	Tandem 80 x 70
Drive wheel mm	252 x 88	252 x 88
Gradient capacity without/with load	6/12%	6/12%
Brake	Electromagnetic	Electromagnetic
Speed regulation	Electronic impulse	Electronic impulse
Weight kg including battery	1175	1450
Turning radius mm	1490	1640
Mast type	Triplex	Triplex
Overall length	1975	1995
Ground clearance centre of wheelbase	21	25

POWER STEERING

Item No	1613045500
Identification	PS 1550
Capacity Kg	1500
Min fork height mm	85
Lifting height mm	4915
Centre of gravity separation	600
Min support height	2220
Max support height	5520
Total width mm	1000
Free lift mm	1660
Fork width mm	575
Fork length mm	1150
Driving speed without/with load km/h	6.0/5.9
Lifting speed without/with load mm/s	212/141
Lowering speed without/with load mm/s	178/227
Drive motor	1.5 kW
Lift motor	3 kW
Truck battery	310Ah/24V
Charger	External
Fork wheel mm	Polyurethane 80 x 70
Drive wheel mm	230 x 75
Gradient capacity without/with load	6/12%
Brake	Electromagnetic
Speed regulation	Electronic impulse
Weight kg including battery	1596
Turning radius mm	1806
Mast type	Duplex
Overall length	2180
Ground clearance centre of wheelbase	25

PS 1550 Pedestrian Stacker 1500 kg

Electric power stackers for the really high lifts with electronic power steering and stand on platform with side protections makes the working days easier and safer. It does not get easier to handle goods in tight warehouses with high racking than with this full electric pallet stacker with power steering. Strong and robust with crucial details for the convenience of the user.

Item No 1613045500



POWER STEERING

Item No	1418048100
Identification	TE 10
Capacity towing Kg	1000
Axle loading, unladen front/rear kg	46/16
Driving speed with/without load km/h	4.2/4.5
Swing radius mm	475
Height of tiller in driving position min/max mm	750/1250
Centre of gravity separation	600
Drive motor	0.3 kW
Drawbar Pull unladen N	200
Max. Drawbar Pull unladen N	450
Battery	24Ah
Charger	Extrenal
Tire size rear Ø mm Polyurethane	75 x 80
Drive wheel Ø mm	250 x 80
Total width mm	460
Weight kg incl. battery and pedal	62

TE10 ELECTRIC Tow Tractor

To handling and pulling of differnt types of trolleys and other wheeled goods. Different connections follows each delivery.

Item No 1418048100



FORK EXTENSIONS BLACK OR GALVANIZED WITH COVERED BOTTOM

Strong truck forks with covered bottoms and pin for locking to the truck.
Recommended for frequent use.

Item No	2520032006	2520032007	2520032008	2520032009
Fork extensions for max LxHxW mm	1800x45x100	2200x45x100	1800x45x125	2200x45x125
Weight kg	40	50	50	60



Item No 2520032007

Item No 2520032221

Item No	Fork extensions for max LxHxW mm	Weight kg	Capacity ton
2520032215	1800x40x100	50	2,5
2520032216	2000x40x100	52	2,5
2520032227	2200x40x100	60	2,5
2520032217	2500x40x100	66	2,5
2520032218	2000x40x120	66	4
2520032225	2200x40x120	74	4
2520032219	2000x50x125	70	4
2520032220	2200x50x125	78	4
2520032221	2500x50x125	116	4
2520032222	3000x50x125	140	4
2520032223	2000x60x150	140	7
2520032228	2200x60x150	144	7
2520032224	2500x60x150	166	7
2520032231	3000x60x150	194	7
2520032229	2500x70x150	176	11
2520032230	3100x70x150	222	11

* All wheels for hand pallet trucks are supplied complete with bearings (6204 2RS) and 20-mm hub bores.

6220020983



6220020994



6220020973



6220020982



6220021000



6220021001



6220021005



6220021010



6220020988



6220020991



6220020989



6220020995



8613019070



8611019060



8612019055



8611019061



8612019056



8611019065



8612019066



Item No	Identification	Diameter mm	Width mm	Hub length	Colour Colour	Fälg
6220020983	Steering wheel Nylon	180	50	50	White	Nylon
6220020973	Steering wheel Rubber	180	50	50	Black	Aluminium
6220020994	Steering wheel Poly	175	50	50	Black	Aluminium
6220021010	Steering wheel Poly	200	50	50	Black	Cast iron
6220021005	Steering wheel Rubber	200	50	60	Black	Aluminium
6220021001	Steering wheel Poly	200	50	50	Black	Aluminium
6220021000	Steering wheel Nylon	200	50	50	White	Aluminium
6220020982	Steering wheel Vulkollan	180	50	50	Red	Cast iron
6220020989	Fork wheel Nylon Bogie	80	70		White	
6220020988	Fork wheel Nylon Single	80	93		White	
6220020991	Fork wheel Poly Bogie	80	70			
6220020995	Fork wheel Poly Single	80	93		Black	
8612019055	Fixed wheel Rubber	160	40	60	Black/Grey	Plastic
8612019056	Castor Rubber	160	40	60	Black/Grey	Plastic
8611019060	Fixed wheel Nylon	150	40	60	White	Plastic
8611019061	Castor Nylon	150	40	60	White	Plastic
8611019065	Castor Nylon with brake	150	40	60	White	Plastic
8612019066	Castor Rubber with brake	160	40	60	Black/Grey	Plastic
8613019070	Pneumatic rubber wheel	300	100	90	Black	Aluminium

Item No 8112085005, 8124085020



Item No 8112085010, 8124085015



Item No 8112085012



Item No 8124085025



Things that are good to know about charging of batteries:

- A shortened or aborted charge shortens the battery's service life.
- The charger must always emit a go-ahead signal before you use the battery.

Chargers 8112085005, 8112085010, 8124085015, 8124085020 are supplied with a coiled cord.

Item No	Identification	Mains voltage	Charge current in A	IP rating	Outer cover	Colour
8112085005	12V / 6Ah Plumbic acid batteries	230V	6Ah	65	Metal	Blue
8112085010	12V / 6Ah Gel batteries	230V	6Ah	65	Metal	Red
8112085012	12V / 3.8 Ah Plumbic acid/gel batteries	230V	4 Ah	65	Plastic	Grey
8124085015	24V / 11Ah Gel batteries	230V	11Ah	65	Metal	Red
8124085020	24V / 11Ah Plumbic acid batteries	230V	11Ah	65	Metal	Blue
8124085025	24V / 40Ah Plumbic acid batteries	230V	40Ah	-	Metal	Blue

Item No 8212086025



Item No 8212086010



Item No 8212086003



Item No 8212086028



Item No 8212086005



Item No 5212086020



Item No 8212086033



Item No 8212086015



Good to know:

- Charge cycle: The battery's life cycle corresponding to the number of charges and discharges calculated based on the IEC 254-1 standard
- Capacity (Ah): The battery's capacity is, to put it simply, the amount of energy contained in the battery. The capacity is usually measured at 5 Ah (C5). Thus, a battery of, e.g. 500 Ah can provide 100 Ah in 5 hours.
- Self-discharge: In addition to the normal discharge, the battery self-discharges 5 to 7% of its capacity per month.
- A fully charged battery should be approx. 12.9 V
- Battery without water = oxyhydrogen gas (Explosive)

Item No	Identification	Charge cycle	Capacity C5/C20	Length mm	Width mm	Height mm	Weight kg	Pole type
8212086003	Powerfit – Plumbic acid 7Ah			151	65	98	2.6	Flat pin
8212086005	Plumbic acid 60 Ah	390		230	173	222	15	Round
8212086010	Gel 33 Ah	450	32.5/38	210	175	175	14.6	Round
8212086015	Plumbic acid 85Ah	300	85/110	326	217	216	27	Round
8212086020	Plumbic acid 60Ah	300	60/80	278	175	190	17.3	Round
8212086025	Gel 22 Ah	450	22/24	167	176	126	9.6	Round
8212086028	Plumbic acid 44Ah	390		207	175	175	12	Round
8212086033	Plumbic acid 110Ah	900	110/132	345	174	218	39	Round

FORK TRUCK CRANE

Practical truck crane for, lifting heavy machinery, moving motors, etc. The crane can be adjusted vertically to 40°, in three positions from the horizontal one. Total length with the arm extended of 3600 mm. Total width of 500 mm. Fork tunnels internal – 160x60 mm. Equipped with a fork lock



Item No 1221046010



Item No	1221046010
Fork tunnels internal dimensions mm	160x60
Total length mm	3600
Total width mm	500
Weight kg	165

FORK TRUCK CRANE

Converts a forklift truck into a mobile hoisting crane in a couple of seconds. Equipped with a fork lock and a catch to ensure the highest level of safety.

Item No	1221046008
Fork tunnels internal dimensions mm	180x60
Total length collapsed mm	2108
Total length fully extended mm	3500
Total width mm	460
Total height mm	324
Weight kg	160

Item No 1221046008



WORKSHOP CRANE

- Quicklift/double acting pump.
- (Applies to Item No 1221046000).
- Chrome-plated piston.
- Safety valve.
- Easy to move.
- Easily collapsible for flexible storage
- (Applies to Item No 1221046000).



Item No 1221046000

Item No	1221046000	1221046005
Lifting capacity in 3-4 positions kg	700-800-1000	700-800-900-1000
Boom length in 3-4 positions mm	1225-1525-1735	1540-1760-1980-2200
Boom height mm	0 -1900	0 -2400
Weight kg	150	103

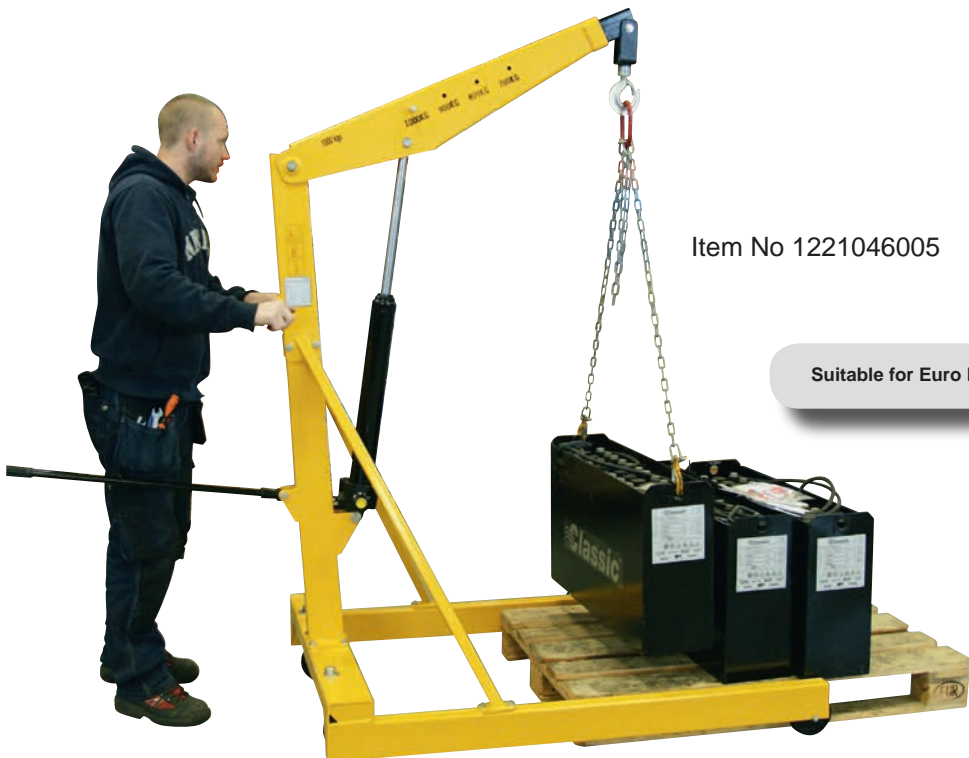

Item No 1221046005

Suitable for Euro Pallets



Item No 1221046030

CRANE FORKS

Self-balancing crane forks for handling of pallets with cranes, hoists, winches, etc. Both models have adjustable support heights and fork widths to suit all needs. The max goods height can be set at between 1300 and 2000 mm.

Item No	1221046015	1221046030
Identification	CY 15	CY 30
Capacity kg	1500	3000
Fork length mm	1000	1000
Fork width mm	Adjustable in 5 steps from 350 to 900 mm.	Adjustable in 5 steps from 450 to 900 mm.
Lifting eye height mm	Adjustable in 3 steps from 1655 to 2355 mm.	Adjustable in 3 steps from 1720 to 2420 mm.
Automatic setting minimum load kg	300	600
Weight kg	165	280



Item No 1221046044

LIFTING BLOCK

Strong lifting blocks for truck forks. Quickly transforms a fork lift truck into a mobile crane. Adjustable along the length of the forks. Attaches to the forks with a screw handle. The hook is fixed and equipped with a catch. Capacity of 1000 to 5000 kg.



Item No	1221046040	1221046042	1221046044
Identification	MK10	MK25	MK50
Capacity Kg	1000	2500	5000
Max fork dimension mm	135x50	160x60	185x75
Weight kg	14	26	49

Table of opportunities! There are load pallets everywhere. You can fasten the pallet legs in 20 seconds and get a stable worktable, exhibition table or platform.

Capacity – 500 kg.

Easy to move with a forklift truck or a stacker!
The Height is included the pallet!

Item No 2541010850



WHEELS FOR PALLET LEGS



Item No 8612019075



COVER FOR PALLET LEGS

Item No	Color	LxWxH mm	Material
2181103920	Black	1200x800x15	PVC Taspaulin textile
2181103922	Green	1200x800x15	PVC Taspaulin textile
2181103923	Red	1200x800x15	PVC Taspaulin textile
2181103924	Yellow	1200x800x15	PVC Taspaulin textile
2181103925	White	1200x800x15	PVC Taspaulin textile
2181103926	Blue	1200x800x15	PVC Taspaulin textile
2181103927	Grey	1200x800x15	PVC Taspaulin textile

Item No	2541010580	2541010730	2541010850
Identification	PB 580	PB 730	PB 850
Loading capacity kg	500	500	500
Height mm	580	730	850
Width mm	800	800	800
Material	Steel tube	Steel tube	Steel tube
Surface treatment	Zinc coating	Zinc coating	Zinc coating

Height 850 mm

Height 730 mm

Height 580 mm

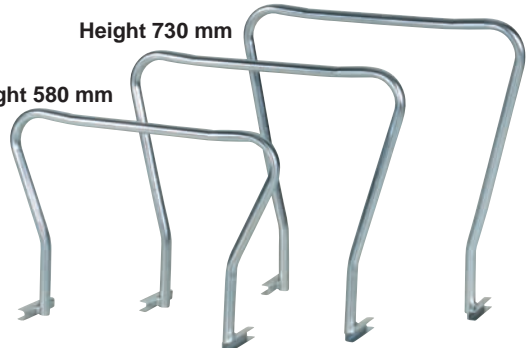

LARGE AND STRONG COLLISION AND MACHINE PROTECTION

To protect the workplace, machines, pallet racks, etc.
Block or mark. Painted yellow to ensure visibility.

Item No	2533033001	2533033002	2533033003
Identification	High-profile protection	Low-profile protection	Post
Height mm	1060	230	915
Length mm	1220	1220	114
Mounting plate mm	203x203	203x203	203x203
Pipe mm (Diameter)	114	114	114
Weight kg	47	27	27

Item No 2533033003



Item No 2533033001



Item No 2533033002

BICYCLE RACKS

Steady and stable bicycle rack for both wall and flat ground use.

- Galvanized frames.
- Location Distance c / c 320 mm.

Item No	2412001003	2412001005
Identification	Bicycle rack short	Bicycle rack long
Height mm	260	260
Length mm	730	1340
Depth mm	330	330
Own weight kg	5	9

Item No 2412001005



Item No 2412001003



Supplied in flat pack

SUPPORT STANDS

Strong support stands with 3 height positions.
Suitable, e.g. for lifting of forklift trucks, heavier machinery,
etc. Sold in pairs

Item No	2531057764	2531057766
Identification	HT-6	HT-9
Capacity	12 TON/Pair	18 TON/Pair
Lifting height mm	242-420	242-415
Weight kg	20	40



Item No 2531057764



Item No 2531057766

HYDRAULIC JACKS

Strong highcapacity jacks.
Extra low lifting height with 2-position lifting claw in order
to be able to gain access to places which are low.
Equipped with wheels for simple and quick moving.

Item No	1340057760	1340057762
Identification:	HFJ-400	HFJ-700
Capacity:	4 TON	7 TON
Maximum lifting height mm	430	420
Minimum lifting height mm	65	65
Width mm	203	250
Weight kg	35	53

Item No 1340057762



Item No 1340057760



RACK AND PINION JACK

Equipped with strong housing construction and stable footplate
 Manufactured in hardened materials.
 The jacks are designed so that both the lifting claw and the crown (the top) can be used for lifting.
 Collapsible crank makes transport and storage easy.

Item No	1340057740	1340057742
Capacity tonne	3	10
Lifting height claw mm	65-350	35-300
Lifting height top mm	725-1075	725-1100
Total height mm	725	800
Weight kg	20	40

Item No 1340057740



Item No 1340057742

HYDRAULIC JACK UNIVERSAL

Compact, flexible, extra low and reliable design. It lifts with the lift foot and the top of the lift body. The body can rotate 360 degrees, which makes it unique. Jack Universal is suitable for all types of repair, maintenance and installation work. Stepless lowering speed and overload protection.

Item No	1340057750
Capacity ton	10
Lifting height foot mm	30-260
Lifting height top mm	420 -650
Weight kg	35

Item No 1340057750



HYDRAULIC JACKS

Powerful tool for heavy lifting. Equipped with a practical handle. Available in two versions, with a capacity of 3 or 8 tonnes. The lifting claw is adjustable in three positions. Low minimum height for the lifting claw. The TG series is extremely suitable for all types of service and installation work of machinery.

Item No	1340057753	1340057754
Identification:	TG 30	TG 80
Capacity:	3 TON	8 TON
Lifting/stroke mm	140	140
Minimum lifting height mm	15	20
Maximum lifting height mm	155	160
Weight kg:	21.5	28



Item No 1340057754



Item No 1340057753

MACHINE JACK

Strong and robust jacks for the heaviest lifting of, e.g. machinery, etc. 2-position lifting, either from the claw or the top. Equipped with a handle and wheels for simple and quick moving. The TB series is extremely suitable for all types of service and installation work of machinery.

Item No	1340057756
Identification:	TB 200
Lifting capacity claw	12 TON
Lifting capacity top	15 TON
Lifting/stroke mm	140
Lifting height top mm	325-545
Lifting height claw mm	40-260
Weight kg	69



Item No 1340057756

Lifting plate claw

WHEELED HAND LEVER

Long and strong wheeled hand lever. Manual lifter on wheels which lifts the goods the first couple of millimetres from the floor level so as to enable the consequent use of a hydraulic jack or machine rollers.



Item No 1951057700

Item No	1951057700
Capacity TON	1.5
Length mm	200
Weight kg	13
Wheel diameter mm	100
Wheel width mm	55
Wheels	Steel

MACHINE ROLLERS

Strong and flexible machine rollers for handling of heavy goods weighing between 2 and 24 tonnes. All of them have a loading surface covered in rubber to protect the transported goods.

Supplied in sets where each set consists of two machine rollers and two steel rods.

CM60-N can be set at between 500 and 1400 mm.

CM60-N and CM240-N can be set at between 720 and 1500 mm.

Item No	1952057726	1952057728	1952057730
Identification:	CM60-N	CM120-N	CM240-N
Capacity:	2x3 TON	2x6 TON	2x12 TON
Number of wheels:	8	12	16
Wheels:	Polyurethane 90x85	Polyurethane 90x85	Steel 85x83
Dimensions: LxWxH	300x250x115	360x220x115	360x220x115
Weight kg:	30	38	65

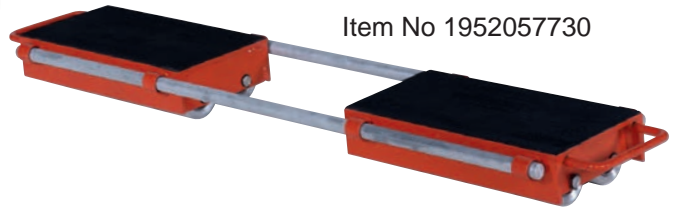

Item No 1952057730

Item No 1952057730

2x12 24 TON



Item No 1952057728

2x6 TON



Item No 1952057726

2x3 TON



MACHINE ROLLERS

Powerful machinery transporters for handling of heavy goods weighing between 2 and 24 tonnes.

All of them have a loading surface covered in rubber to protect the transported goods.

Models with towing rods have a swivel wheel and the carrying plate follows the direction of the tow road for flexible and safe movement.

Sold separately.

Item No 1951057712



Item No 1951057702



Item No	1951057702	1951057704	1951057706	1951057712	1951057724
Identification:	AS20-N	SS40-P	SS60P	AS120-N	SS240-P
Capacity:	2 TON	4 TON	6 TON	12 TON	24 TON
Number of wheels:	2	4	8	8	16
Wheels	Nylon 82x100 mm	Polyurethane 82x100 mm	Polyurethane 82x100 mm	Nylon 115x60 mm Polyurethane	115x60 mm Polyurethane
Dimensions: LxWxH	270 x 115 x 110 mm	310 x 250 x 110 mm	385 x 560 x 110 mm	345 x 400 x 145 mm	415 x 1120 x 145 mm
Weight kg:	7.5 kg	16 kg	50 kg	40 kg	130 kg

Item No 1951057706



Item No 1951057724



Item No 1951057704



DRUM LIFTER FL 300

The drum lifter is designed for handling of 200-litre steel drums. Automatically locks the drum during lifting. It can lift drums in and out of most transport vehicles. Simple lift with a foot pedal and lowering with a manually operated dead man's hand grip.

- Total height to maximum height for both lifters 1920 mm,
- Dimensions between support legs = 870 mm.
- Supplied unassembled.

Item No 1851054310

Item No	1851054300	1851054310
Identification	FL 300 A	FL 300 AH
Capacity kg	300	300
Lifting height mm	700	700
Fork wheel Ø mm	65 Nylon	125 Nylon
Steering wheel Ø mm	80 Nylon	125 Nylon
Weight kg	67	70



DRUM STACKER WITH TILT FUNCTION

The drum lifter is designed for lifting and tilting of 200-litre steel drums. Excellent tool for emptying and stacking drums. Safe and simple lifting with a foot pedal.

The drum tilt is operated with a manually operated crank.

Distance between support legs = 870 mm

Item No	1851054140
Identification	PL 1400
Capacity kg	350
Lifting height mm	1400
Fork wheel Ø mm	74x70 Nylon
Steering wheel Ø mm	180 Nylon
Weight kg	155
Total width mm	1070
Total height mm	2020
Total length mm	1240



Item No 1851054140

DRUM GRIP

Safe and flexible drum tongs for horizontal lifting of 210-litre drums with rims or rings. Suitable for placing drums on drum pallets, stands, etc. Semiautomatic locking device. The grapples are locked in an open position and lowered down to the drum. Once they are subsequently released, they lock automatically under the rim during lifting. Capacity of 500 kg, weight of 5.2 kg.



DN 500
Item No 1222054405

DL 350
Item No 1222054400



DRUM CLAMP

Safe and flexible drum tongs for horizontal lifting of 210-litre drums with rims or rings. Fast and simple handling from cranes or trucks. Capacity of 350 kg, weight of 9.5 kg.

DRUM & TYRE TROLLEY

For handling of drums, tyres or other loads with circular bottoms. Welded steel design. High stability.

Item No 1915054000 = 200 litre drums

<i>Item No</i>	1915054000
<i>Capacity kg</i>	300
<i>Internal diameter Ø mm</i>	598
<i>Total height mm</i>	157
<i>Wheel Ø mm</i>	75
<i>Weight kg</i>	9.5

Item No 1915054000



DRUM CLAMP UNIT

Automatic clamping unit for all types of drums. The unit is mounted directly on to the truck's forks and is locked in place with wing nuts. When the drum is lifted, it is automatically locked in place by the unit's arms.

Item No	1222054401
Identification	DG40
Capacity kg	300
Total length mm	1070
Total width mm	700
RAL Colour	3020
Weight	60
Internal dimensions of the fork channels	178x58 mm



Item No 1222054401

DRUM GRIP UNIT

Automatic clamping unit for lifting and transporting steel drums by truck. The unit is easily fitted to the truck's forks and locked in place with wing nuts. Automatically grips the drum and holds it securely in place during transport.

The height of the device is adjustable to fit all sizes of steel drums.

Available in versions for handling of 1 or 2 drums at the same time.

Item No	1222054410	1222054420
Identification	DG360A	DG720A
Capacity kg	360	720
Total length mm	830	1030
Total width mm	710	850
Total height mm	1000	1000
RAL Colour	3020	3020
Weight	60	96
Internal dimensions of the fork channels	178x58 mm	178x58 mm

Item No 1222054420



Item No 1222054410



SPILL TRAY

Spill tray for the safe storage of chemicals in drums, jerry cans, bottles, etc. It can also be used to hold spare and machine parts during service of machinery and vehicles. Manoeuvred with hand trucks, stackers or forklifts.

Item No 2314021110

Item No	2314021110
Volume L	260
Height mm	350
Width mm	800
Length mm	1250
Weight kg	40



PALLET TRAYS

Pallet trays for the safe storage of chemicals in drums, jerry cans, bottles, etc. They can also be used to hold spare and machine parts during service of machinery and vehicles. The pallet trays are intended to be used together with Euro pallets.

Item No	2314021215	2314021240
Volume L	150	400
Height mm	160	415
Width mm	810	810
Length mm	1250	1250
Weight kg	24	38

Item No 2314021240

Item No 2314021215



OPEN DRUM PALLETS FOR STANDING DRUMS

Item No 2311020020

Item No	2311020010	2311020020	2311020040
Volume L	210	260	380
Number of drums	1	2	4
Length mm	950	950	1250
Width mm	950	1250	1250
Height mm	325	325	1250

ACCESSORIES: Wheel set:
(2 fixed wheels & 2 castors)

Choose between nylon 150 mm
or rubber 160 mm.

Wheel set/nylon = Item No 8611019030

Wheel set/rubber = Item No 8612019031



TROLLEY UNIT FOR DRUM PALLETS FOR STANDING DRUMS

Item No 2311020020 + 8611022040

Trolley unit Item No 86110
8611022040 contains a
pushing handle and a wheel
set in nylon (8611019030).



DRUM PALLETS WITH SAFETY RAILING FOR STANDING DRUMS

Item No	2311020012	2311020022	2311020042
Volume L	220	260	440
Number of drums	1	2	4
Length mm	950	950	1250
Width mm	950	1200	1200
Height mm	910	910	910

Item No 2311020022



ACCESSORIES: Wheel set:
(2 fixed wheels & 2 castors)

Choose between nylon 150 mm
or rubber 160 mm.

Wheel set/nylon = Item No 8611019030

Wheel set/rubber = Item No 8612019031

ENCLOSED DRUM PALLETS FOR STANDING DRUMS

Item No	2311020013	2311020023	2311020043
Volume L	220	260	380
Number of drums	1	2	4
Length mm	950	950	1250
Width mm	950	1280	1280
Height mm	1330	1330	1330

Item No 2311020023



ACCESSORIES: Wheel set:
(2 fixed wheels & 2 castors)

Choose between nylon 150 mm
or rubber 160 mm.

Wheel set/nylon = Item No 8611019030

Wheel set/rubber = Item No 8612019031

DRUM PALLETS FOR LAYING DRUMS

Item No	2311021010	2311021020	2311021022
Volume L	260	440	440
Number of drums	1	2	4
Length mm	950	1550	1550
Width mm	1250	1250	1250
Height mm	580	580	1280

Item No 2311021010

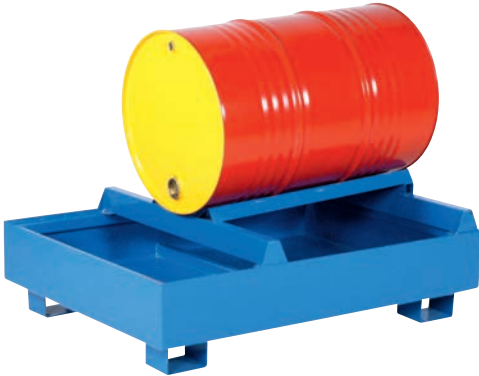

Item No 2311021022

ACCESSORIES: Wheel set:
(2 fixed wheels & 2 castors)

Choose between nylon 150 mm
or rubber 160 mm.

Wheel set/nylon = Item No 8611019030

Wheel set/rubber = Item No 8612019031

DRUM PALLETS FOR 1 OR 2 CIPAX CONTAINERS

Item No	2311021101	2311021102
Volume L	1100	1200
Number of drums	1	2
Length mm	1310	2530
Width mm	1310	1310
Height mm	750	450

Item No 2311021102



Item No
2311021101



ACCESSORIES: Wheel set:
(2 fixed wheels & 2 castors)

Choose between nylon 150 mm
or rubber 160 mm.

Wheel set/nylon = Item No 8611019030

Wheel set/rubber = Item No 8612019031

TOOL TROLLEY

Robust tool trolley for secure storage of tools on building sites, etc. Strong lock with 3 locking points. Equipped with four solid rubber wheels, two of which are equipped with brakes, 160 mm in diameter. Also suitable for use as a worktable. Powder coated.

Item No
2018017040



Item No	2018017040
Size LxWxH	1100x660x870
Max load kg	600
Wheel Ø mm solid rubber	1310
Weight kg	63

BOTTOM DISCHARGING CONTAINERS

Always easy to empty as the whole bottom opens. Automatic opening and locking after emptying. It should be emptied by a forklift truck or a stacking truck. It can be moved with most forklift trucks and fork lifting devices available on the market.

Powder coated.
Stackable.

Also available with a factoryfitted cover.

Item No 2017018100



Item No	2017018070	2017018100	2017018180
Identification	BTC 07	BTC 10	BTC 18
Capacity kg	800	800	800
Volume L	700	1000	1800
Length mm	1200	1200	1600
Width mm	800	900	1000
Height mm	900	1100	1300
Weight kg	115	149	224

ACCESSORY FLAT LID (FACTORYFITTED)

Item No	2511018079	2511018109	2511018189
Fitted to	18070 (BTC 07)	18100 (BTC 10)	18180 (BTC 18)



120 L



240 L



360 L

Select lid in the colours as recommended by the public waste collection service.



REFUSE BINS

Volume L	120	240	360
Width mm	490	580	580
Height mm	930	1060	1100
Depth mm	550	730	880
Steering wheel mm	200x50	200x50	200x50
Capacity kg	60	120	160
Colour	Dark grey	Dark grey	Dark grey

	BLUE	= Paper
	RED	= Environmentally hazardous
	WHITE	= Plastic
	YELLOW	= Textile
	BROWN	= Compostable
	GREEN	= Glass
	DARK GREY	= Metal

REFUSE BINS 120 L

Item No	211231101	211231102	211231103	2112 31104	2112 31105	2112 31106	211231107
Colour	Brown	Green	Red	Yellow	White	Blue	Dark grey

REFUSE BINS 240 L

Item No	212431201	2124 31202	212431203	212431204	2124 31205	212431206	212431207
Colour	Brown	Green	Red	Yellow	White	Blue	Dark grey

REFUSE BINS 360 L

Item No	213631301	2136 31302	213631303	213631304	213631305	213631306	213631307
Colour	Brown	Green	Red	Yellow	White	Blue	Dark grey

BIN DISCHARGERS FOR FORKLIFT TRUCKS

For simple and flexible emptying of refuse bins. Suitable for plastic bins from 40 to 400 litres. Distance between fork tunnels of 760 mm, Fork tunnel width of 180 mm. Total width of 1120 mm. Total length of 1430 mm (incl. hooks). Powder coated. Blue RAL 5019.

Item No	1224031000
Fork tunnel distance mm	760
Fork tunnel width mm	180
Total width mm	1120
Total length mm (incl. hooks)	1430
Suitable for bins of between	40 and 400 Litres
Weight kg	39

Item No 1224031000



CLEANING TROLLEY

Easy-to-use cleaning trolley for indoor and outdoor use. Manufactured of a strong, powder coated tubular steel frame. The cleaning trolley has fittings for bin bags, two tube holders for cleaning equipment and a basket for storing bin bags, etc.

Item No 1910057007

Item No	1910057007
Capacity kg	200
Total height mm	1120
Width mm	730
Length mm	1118
Wheel type	Pneumatic rubber
Wheel diameter mm	400x100
Bin bag holder diameter mm	440
Weight	30



WORK CAGES

For safe personal lifts. Provided with anti-slip floors, double safety chains to the locking pin and spring lock on the gate.

The cages meet the requirements of the Swedish standards according to SS 3628. CE-approved.

A first time inspection of cage and truck must be carried out by an accredited company according to AFS 1993:1.
Powder coated.



Item No	1250065001	1250065002	1250065003
Size mm	800x800	1200x800	1200x1200
Total height mm	1990	1990	1990
Number of persons	1	1	2
Permitted total weight kg	250	250	500
Weight kg	77	96	116

Fork channel internal dimensions:
A=210 mm, B=225 mm, C=660 mm, D=80 mm.

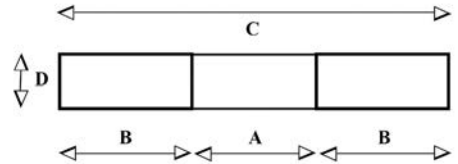

COLLAPSIBLE WORK CAGE

Practical, collapsible lift cage. Assembled by one person in less than 30 seconds. The cage has an anti-slip floor. Equipped with a fork lock to ensure the highest level of safety. Equipped with two wheels for simple and quick moving without a truck. Transported easily and flexibly in, e.g. smaller delivery vans, etc. The cages meet the requirements of the Swedish standards according to SS 3628. CE-approved.

A first-time inspection of cage and truck must be carried out by an accredited company according to AFS 1993:1.
Powder coated.

Item No	1250065010
Total lifting capacity kg	250
Length x Width mm	1000x1000
Height collapsed mm	350
Height during use mm	1960
Weight kg	100

TILTING SKIPS

- Tilting skips are the industry's best tool for waste assorting, waste and material handling.
- Designed, reinforced and powder coated to provide maximum safety and service life.
- Spring pressure plate on the base frame for automatic tilting.
- Also with manual tipping.
- Other sizes are manufactured on request.

TIPPO have reinforcements in the right places in order to deal with rough handling.

- Corner reinforcements improves the stiffness of the containers.
- Reinforced fork channels.
- The stop lug is well dimensioned in order to deal with the forces it can be exposed to.
- The automatic tipping function does not only provide greater efficiency, it also raises safety during emptying at greater heights as TIPPO cannot slide from the forks.

Tilting skips are exceptionally suited to waste assorting. They can be supplied in colours as recommended by the public waste collection service.



CHOOASABLE COLORS FOR ALL TILTING SKIPS

	BLUE	= Paper	Color no: (RAL 5019)
	RED	= Environmentally hazardous	Color no: (RAL 3020)
	WHITE	= Plastic	Color no: (RAL 9010)
	ORANGE	= Flammable	Color no: (RAL 2008)
	YELLOW	= Textile	Color no: (RAL 1021)
	BROWN	= Compostable	Color no: (RAL 8017)
	GREEN	= Glass	Color no: (RAL 6032)
	GREY	= Metal	Color no: (RAL 7042)
	Black		Color no: (RAL 9005)

Item No 2011010030 + 8611019030





Item No 2011010-	015	030	060	090	110	160	200	250	300
Identification	Tippo 150	Tippo 300	Tippo 600	Tippo 900	Tippo 1100	Tippo 1600	Tippo 2000	Tippo 2500	Tippo 3000
Volume cubic	0.15	0.3	0.6	0.9	1.1	1.6	2.0	2.5	3.0
Volume Litre	130	320	520	765	1030	1340	1700	2050	2500
Length mm	815	1235	1525	1525	1700	2073	2073	2073	2073
Width mm	760	840	865	1215	1215	1066	1316	1566	1866
Height mm	580	750	870	870	1045	1248	1248	1248	1248
Weight kg	55	80	101	122	157	205	253	288	321
Capacity kg	1200	1500	2000	2000	2000	2000	2000	2000	2000

Sizes from 150 litres up to and including 1600 litres have the following base frame dimensions:

A=160 mm, B=230 mm, C=630 mm, D=100 mm.

Sizes from 2000 litres up to and including 3000 litres have the following base frame dimensions:

A=560 mm, B=230 mm, C=1035 mm, D=100 mm.

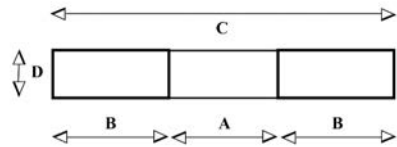

ACCESSORIES FOR TILTING SKIPS

Item No	2011010925	2512019040	2512019041	2512019042	2512019046
Identification	Safety chain	Fork lock	Spacer heels for handling with stacking trucks	Spacer heels for wheels when handling with stacking trucks	Net - crane – tight welding for liquid separation
Item No	8611019030	8611019051	8612019031	8612017160	
Identification	Wheel set nylon 150 mm	Wheel set nylon 150 mm with break	Wheel set solid rubber 160 mm	Wheel set solid rubber 160 mm with break	

Safety chain



Wheel set with spacers

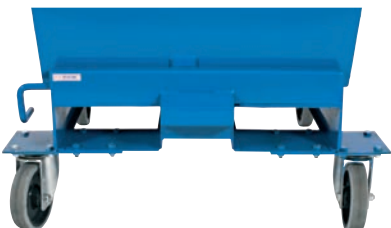

Fork lock



Distance heels

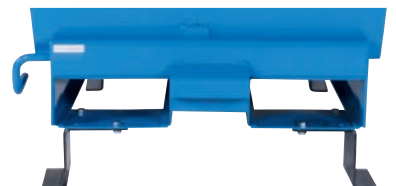

**ACCESSORIES: FLAT COVER TO OPEN TILTING SKIPS.
CAN EASILY BE RETROFITTED.**

Item No	2511012021	2511012041	2511012076	2511012111	2511012131	2511012171	2511012221	2511012271	2511012301
Flat cover for	Tippo 150	Tippo 300	Tippo 600	Tippo 900	Tippo 1100	Tippo 1600	Tippo 2000	Tippo 2500	Tippo 3000



Item No 2511012111

**TILTING SKIPS WITH
HIGH COVER**

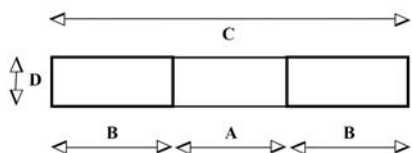

Sizes from 200 litres up to and including 1700 litres have the following base frame dimensions: A=160 mm, B=230 mm, C=630 mm, D=100 mm.

Sizes from 2200 litres up to and including 2700 litres have the following base frame dimensions: A=560 mm, B=230 mm, C=1035 mm, D=100 mm.



Item No 201211110

Item No	201211020	201211040	201211075	201211110	201211130	201211170	201211220	201211270
Identification	TL 200	TL 400	TL 750	TL 1100	TL 1300	TL 1700	TL 220	TL 2700
Volume cubic	0.2	0.4	0.75	1.1	1.3	1.7	2.2	2.7
Volume Litre	130	320	520	770	1030	1350	1700	2050
Length mm	815	1235	1525	1525	1700	2073	2073	2073
Width mm	780	860	880	1230	1230	1080	1330	1580
Height mm	900	1110	1295	1295	1545	1845	1845	1845
Weight kg	90	140	175	240	260	330	350	430
Capacity Kg	1200	1500	2000	2000	2000	2000	2000	2000
Number of doors	1	1	1	2	2	1	2	2

LOW TILTING SKIPS

Low containers are suitable for use in workstations where the height plays a role. They facilitate the handling of waste, sawdust, wood, splinters, etc. Built-in fork locking for safe handling. The low container has a low construction height and is thereby emptied over its axle using a strong hinge. Equipped with a spring pressure plate on the base frame for automatic emptying. Powder coated.

Item No	2013013055	2013013075	2013013090
Identification	Tippo LB 55	Tippo LB 75	Tippo LB 90
Capacity Kg	1500	1500	1500
Volume L	550	750	900
Length mm	1645	1645	1645
Width mm	1065	1315	1565
Height mm	525	525	525
Weight kg	116	129	142

Item No 2013013055



Fork channel dimensions
 A=150 mm, B=265 mm,
 C=705 mm, D=95 mm.

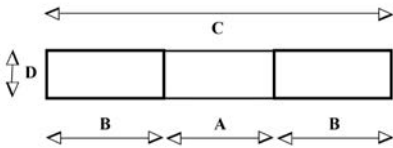

HEAVY DUTY TILTING SKIPS

Tippo HD, a heavy duty tilting skip for heavier materials and rougher handling. 3 mm steel plate and reinforcements at sensitive locations ensures strength. Lower front for easier control of the material when emptying. Longer and higher handle for manual emptying makes it easier for the user. Automatic emptying with the pressure plate on front edge of the chassis allows the driver to safely sit in the fork lift truck throughout the tilting procedure and thereby minimize the risk of accidents. Wire holding container to the undercarriage for involuntary discharge not to occur. The same cable also works as a fork lock and pulled around the truck stand before emptying to take place and prevents the container from being able to slip of the forks.

Item No 2015140900



Item No 2015141600

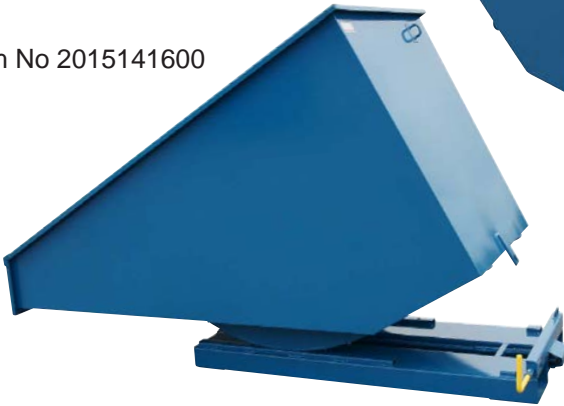

ACCESSORY FOR HEAVY DUTY TILTING SKIPS

New way to tilt the Heavy Duty Tilting Skips family. Use the forkspreading when you tilt the skip. You have 3 ways to tilt the skip. Forkspreading, automatic drain mechanism and manual. With this new model you can tip everywhere.

Item No 2512019044



Item No 2015141600

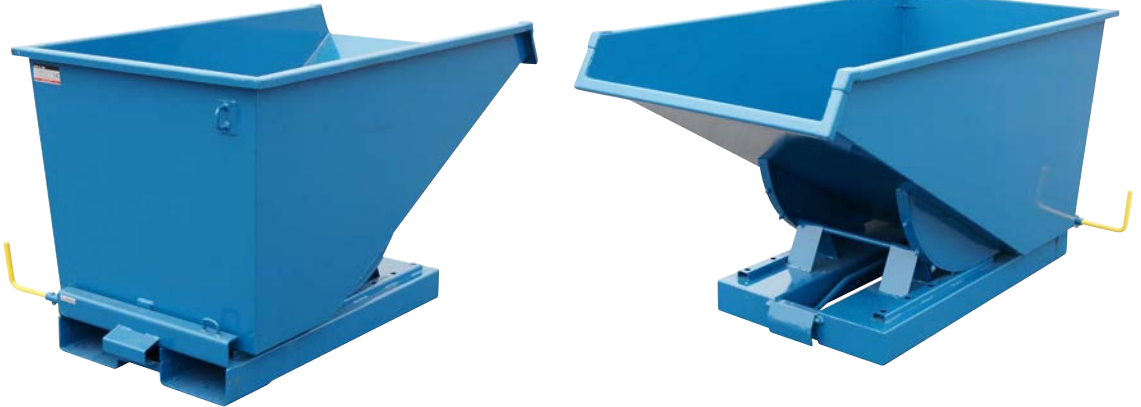

Item No	2015140300	2015140600	2015140900	2015141100	2015141600
Identification	Tippo HD 300	Tippo HD 600	Tippo HD 900	Tippo HD 1100	Tippo HD 1600
Volume cubic	0.3	0.6	0.9	1.1	1.6
Volume Litre	320	520	765	1030	1340
Length mm	1230	1540	1540	1860	2150
Width mm	840	870	1215	1215	1065
Height mm	760	875	875	1045	1245
Weight kg	110	135	159	188	235
Capacity kg	2500	2500	2500	2500	2500

Sizes from 300 litres up to and including 1600 litres have the following base frame dimensions: A=160 mm, B=220 mm, C=615 mm, D=110 mm.

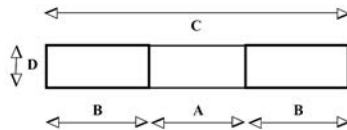

Safety chain



ACCESSORIES FOR TILTING SKIPS

Item No	2011010925	2512019040	2512019041	2512019042	2512019046
Identification	Safety chain	Fork lock	Spacer heels for handling with stacking trucks	Spacer heels for wheels when handling with stacking trucks	Net - crane – tight welding for liquid separation
Item No	8611019030	8611019051	8612019031	8612017160	
Identification	Wheel set nylon 150 mm	Wheel set nylon 150 mm with break	Wheel set solid rubber 160 mm	Wheel set solid rubber 160 mm with break	

Wheel set with spacers



Fork lock



Distance heels

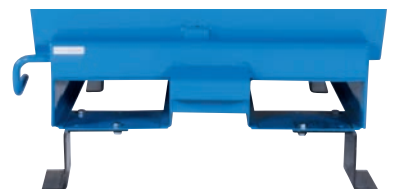

WINTER PRODUCTS

PLOUGHS FOR FORKLIFT TRUCKS

Strong ploughs in 8 mm sheet steel fitted with a spring mechanism and a fork lock for safe and effective ploughing. The spring mechanism causes the plough to retract in the event of a collision. Simple and easy adjustment to the truck's forks. Reinforced on the front edge for a long service life. The plough is adjustable in three positions: Right, left and straight. Powder coated.

Item No 7012016015

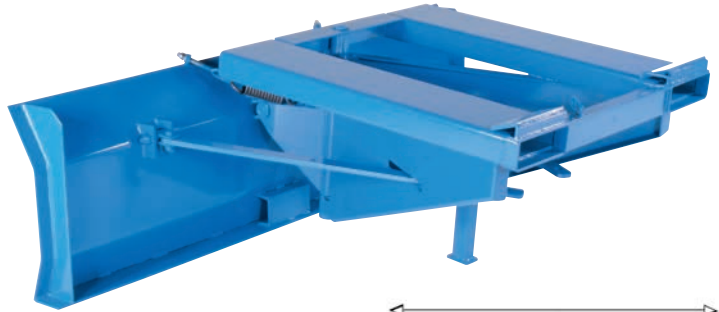

Fork channel internal dimensions:
A=525 mm, B=215 mm, C=975 mm, D=68 mm.

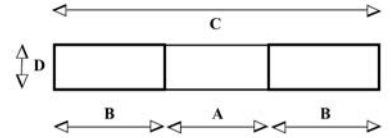

Item No	7012016015	7012016020	7012016025	7012016030
Identification	SP 15	SP 20	SP 25	SP 30
Width mm	1500	2000	2500	3000
Height blade mm	600	600	600	600
Weight	240	255	270	285

PLOUGH FOR FORKLIFT TRUCKS

Plough with rubber that is exchangeable. Simple and easy to change in three positions and the fork channels have fork lock. The exchangeable rubber makes the snow plough last longer.

Item No 7012016520



Rubber. Item No 7012016590

Item No	7012016520
Identification	SPR 20
Width mm	2000
Height blade mm	450
Weight	72



Fork channel internal dimensions:
A=250 mm, B=160 mm, C=570 mm, D=80 mm.

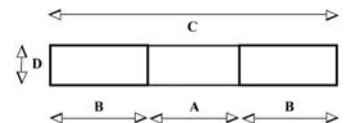

PLOUGH FOR FORKLIFT TRUCKS

Strong plough in 5 mm steel plate. Equipped with fork lock for safe and efficient plowing. Easy and fast bucking on your forks. Reinforced bottom for durability.

The plow is solid and built for plowing side and is reversible for side plowing on the left and the right. Powder coated.

Item No 7012016518

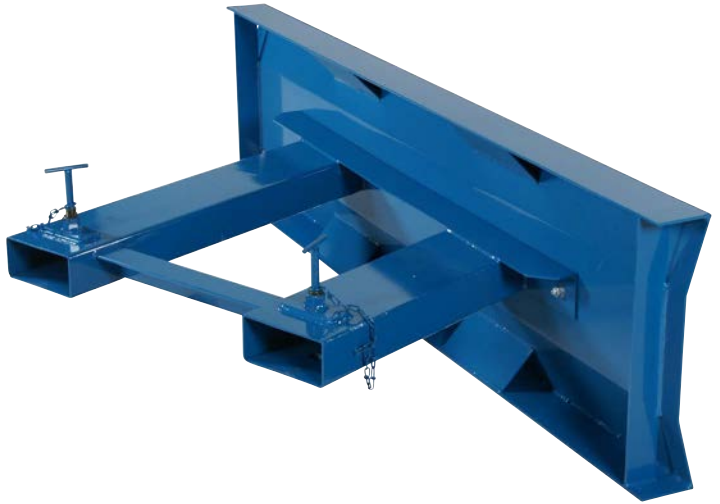

Item No	7012016518
Identification	SPF 18
Width mm	1800
Height blade mm	400
Weight	95

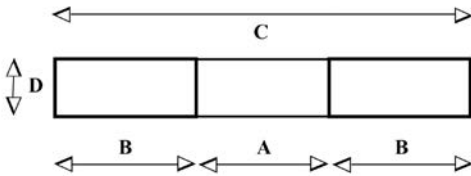

Fork channel internal dimensions:
A=430 mm, B=170 mm, C=790 mm, D=75 mm.

SNOW AND SAND SCOOP

Powerful truck scoop for handling and clearing of snow, gravel, sawdust, waste, etc. Manufactured in 3 mm sheet metal with strong hardwearing steel on the front edge. Built in fork locking for safe operation. Powder coated.

Item No 7011015015



Item No	7011015010	7011015015
Identification	SK 1	SK2
Volume L	1000	1500
Length mm	1795	1795
Width mm	1500	2000
Height mm	600	750
Capacity Kg	1500	1500
Weight kg	154	209

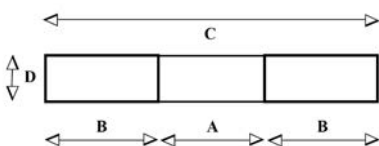

Fork channel dimensions
A=475 mm, B=265 mm, C=1025 mm, D=95 mm.

EFEKT - SNOW SHOVEL

With smart patented solutions, ergonomic and awarded for its design is EFEKT the best and smartest solution for snow handling .

Item No 7025020086

Item No	7025020086
Identification	Shovel EFEKT
Blade width mm	370
Blade height mm	570
Overall height mm	1610
Thickness shaft mm	36



SNOWTRAY

High graded plastic snowtray, bow with thermogrip, steel edge and very light for easy gliding.

Item No 7025477001

Item No	7025477001
Identification	Snowtray
Blade width mm	580
Overall height mm	770
Weight kg	5



SALT & SAND CARRIER

Spreader for salt, sand, seeds and fertilizer. Easy dosing on the grip. Capacity up to 25 L with cover and fender. Measurement 465x690 mm.

Item No 1970057148



SONNECK
SNOWMASTER®

BATTERY POWERED SNOW BLOWER

A battery powered snow blower which is very easy to use. Ideal for garage driveways and pavements. Ergonomic single-hand grip and optimal handling through adjustable grip. Ergonomic and silent for great comfort.

Item No	7040030330
Identification	ACCU 330
Battery: Lithium	18V 4.0 Ah 72Wh
Operation life	45 min
Charging time	60 min
Clearing width	330 mm
Throwing width	3-4 m
Throwing height	3-4 m
Weight	6 kg



Item No 7040030330

BATTERY POWERED SNOW BLOWER

Powerful brushless motor and a very easy control box to control the engine. Ergonomic and silent for great comfort. LED light on the handlebar and electric steering of the out blow canon.

Item No	7040030450
Identification	ACCU 450
Clearing Capacity	200 m ²
Battery: Lithium	36V 4.0 Ah 144 Wh
Operation life	45 min
Charging time	90 min
Clearing width	450 mm
Throwing width	4-5 m
Throwing height	3-5 m
Weight	15 kg

SONNECK
SNOWMASTER®



Item No 7040030450

PERSONAL TRANSPORT PRODUCTS

Gocycle G2R

Gocycle is an electric bike out of the ordinary. With perfect balance and feeling makes Gocycle the ultimate bike combined with its electric motor is the ideal vehicle to travel fast and comfortable with. The engine gives you extra support only when you want it.

Top Speed km/h	25
Range	up to 64 km
Frame Colour	White, Grey, Black
Battery	Lithium 10.75Ah / 22V
Motor	250 watt continuous
Gears	3 - Electronic Shifting
Breaks	Hydraulic disk, front and rear
Tyres	Gocycle Performance Tyre (406-50, 20 x 1.75 in/BMX)
Stowable Dimensions	600mm x 760mm x 300mm (with folding pedals)
Weight kg	15



Item No 9520400100

Item No 9520400120

Item No 9520400110



Paukool S2

Paukool is beautiful, stylish, compact and flexible. The driver and the vehicle makes a perfect symbiosis and traveling with total control to your desired destination. With its adjustable handlebar is perfect to bring along on the voyage or camper for the ultimate transport close at hand.

Item No	9612038120	9612038110
Top Speed km/h	15	15
Range	up to 30 km	up to 30 km
Colour	Red	Black
Battery	Lithium 48V 8Ah	Lithium 48V 8Ah
Height cm max/min	138 / 103	138 / 103
Weight kg	20	20

Item No 9612038120





Lift Safe Ltd
Unit 9
Westwood Business Centre
Featherstall Road South
Oldham
OL9 6HN

Tel : 0161 626 9628
Fax : 0161 626 9728

Web : www.liftsafe.net
Email : info@liftsafe.net