

Sigma CP (K and T Series)

Conventional Fire Control Panel

(K11020M2, K11040M2, K11080M2)

(T11020M2, T11040M2, T11080M2)

Operation and Maintenance Manual

Man-1078 Issue 12 June 2010

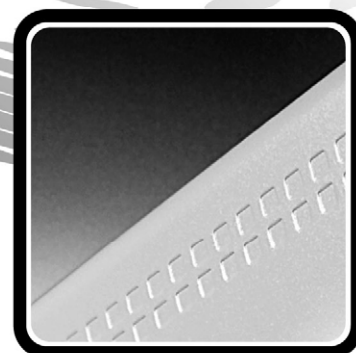

Index	Page
1. Introduction	3
2. Safety and mounting	3
3. Technical specification.....	4
4. Using intrinsically safe barriers.....	7
5. Control panel fascia.....	8
6. Connecting to the circuit board	9
7. Software revision number	9
8. Detection zone wiring.....	10
9. Sounder circuit wiring.....	11
10. Connection to remote control terminals	11
11. Aux 24V DC supply.....	12
12. Connection to relay contacts.....	12
13. Connection to Repeater panels.....	12
14. Connection to Ancillary boards	13
15. Connection to 8 way Sounder boards	13
16. Panel operation.....	14
17. Configuration options	15
18. Watchdog reset switch	17
19. Processor reset switch	18
20. Internal indications – troubleshooting.....	18
20.1 Mains fail	18
20.2 Batt fail.....	18
20.3 CPU fault	18
20.4 Aux 24V fault	18
20.5 Batt low.....	18
20.6 Earth fault.....	18
20.7 Sys fuse fault	18
20.8 S1 fault and S2 fault	18
20.9 Comms fault.....	18
21. Power supply	19
22. Maintenance	20
23. Zone designation label.....	20
24. Record of Configuration.....	21

1. Introduction

The SIGMA CP range consists of a series of conventional fire alarm control panels designed in accordance with European standards EN54-2 and EN54-4 Fire Detection and Fire Alarm systems - Control and Indicating Equipment.

The range consists of 2, 4 and 8 zone control panels. All control panels are available in two versions:

Sigma K11 range in which detectors and call points are wired on separate circuits to sounders (two sounder circuits are provided).

Sigma T11 range in which detectors, call points and sounders are wired to the same pair of cables. This is what is commonly referred to as a two-wire system.

Wiring sounders to the detection circuits eliminates the need to install sounder circuit cables and also offers the ability to provide zoned or two stage sounder operation.

All control panels have an integral, mains powered battery charger and power supply designed in accordance with the requirements of EN54-4.

In addition to the requirements of EN54-2 the control panel has the following facilities:

.....*Test condition* to allow the automatic resetting of zones in alarm for testing purposes. EN54-2 Section 10 option with requirements.

.....*Delay of the actioning* of fire alarm devices (sounders) so that an alarm may be verified before a premises is evacuated. EN54-2 Section 7.11 option with requirements.

.....*Fire alarm devices* to enable an audible warning to be sounded throughout a premises upon the detection of a fire condition or the operation of a manual call point. EN54-2 Section 7.8 option with requirements.

In addition to the requirements of EN54-2, all control panels have voltage free relay contacts for fire and local fire which operate upon fire condition. These are to be used for local control and signalling.

2. Safety and mounting

Suppliers of articles for use at work are required under section 6 of the Health and Safety at Work act 1974 to ensure as reasonably as is practical that the article will be safe and without risk to health when properly used.

An article is not regarded as properly used if it is used 'without regard to any relevant information or advice' relating to its use made available by the supplier.

This product should be installed, commissioned and maintained by trained service personnel in accordance with the following:

- (i) IEE regulations for electrical equipment in buildings
- (ii) Codes of practice
- (iii) Statutory requirements
- (iv) Any instructions specifically advised by the manufacturer

According to the provisions of the Act you are therefore requested to take such steps as are necessary to ensure that you make any appropriate information about this product available to anyone concerned with its use.

This equipment is designed to be operated from 230V 50Hz mains supplies and is of class 1 construction. As such it **must** be connected to a protective earthing conductor in the fixed wiring of the installation and a readily accessible double pole disconnect device meeting the requirements of EN60950/IEC950 which disconnects live and neutral simultaneously shall be incorporated in the fixed wiring.

Switch disconnect devices such as MK Sentry 63A or similar are suitable for this.

Failure to ensure that all conductive accessible parts of this equipment are adequately bonded to the protective earth will render the equipment unsafe.

This control panel is designed for indoor use only and at temperatures between -5°C (+/- 3) and +40°C (+/- 2) and with a maximum relative humidity of 95%.

The IP rating for the enclosure is IP30.

Operation outside of these limits may render the equipment unsafe.

Mounting

The control panel should be mounted on a dry, flat surface, at eye height to the display and in a level position such that the enclosure is not distorted.

Screws or bolts of a minimum of 5mm diameter must be used to mount the enclosure in all three mounting positions.

It should be positioned in an accessible position as agreed with the end user.

Suitable fixings should be used at all fixing points such that the control panel is securely mounted and is not liable to move once fixed.

The control panel should not be mounted in another enclosure or near sources of excessive heat.

Cables should be connected using suitable cable glands fitted to the knockouts provided. If additional cable entry points are required, all swarf and debris caused by drilling of additional cable entries must be cleared before power is applied to the panel.

3. Technical specification

Table 1 - Electrical specifications

Mains supply	230V AC +10% - 15% (100 Watts maximum)	
Mains supply fuse	1.6Amp (F1.6A L250V)	<i>Replace only with similar type</i>
Power supply rating	3 Amps total including battery charge 28V +/- 2V	
Maximum ripple current	1.5 Volts	
Output voltage	18.5 to 29V DC +/- 2%	
I _{max a}	400 milliamps	
I _{max b}	2.3 Amps	
I _{min}	0.065A	
Battery type (Yuasa NP)	Two 12 Volt sealed lead acid (7Ah maximum)	<i>See table 2 for capacities</i>
Battery charge voltage	27.6VDC nominal (temperature compensated)	<i>See table 3</i>
Battery charge current	0.7A maximum	
Battery lead fuse	20mm, 3.15A glass	<i>Replace only with the same type</i>
Battery high impedance warning (R _{imax})	1.35 ohms max	
Low battery voltage indication	21V +/- 2%	
Low battery shut off voltage	18.5V +/- 2%	
Maximum current draw from batteries	3 Amps	<i>With main power source disconnected</i>
ROV output	Fused at with electronic fuse	
Dedicated sounder outputs	24V Fused at 500mA with electronic fuse	<i>1.6 Amp total load over <u>all</u> circuits</i>
Zonal sounder outputs	24V Fused at 500mA with electronic fuse	<i>1.6 Amp total load over <u>all</u> circuits</i>
Fault relay contact rating	30VDC 1A Amp maximum for each	<i>Maximum ratings not to be exceeded</i>
Fire relay contact rating	30VDC 1A Amp maximum for each	<i>Maximum ratings not to be exceeded</i>
Local fire relay contact rating	30VDC 1A Amp maximum for each	<i>Maximum ratings not to be exceeded</i>
Zone quiescent current	1.6mA maximum	<i>See table 4 for detector types</i>
Terminal capacity	0.5mm ² to 2.5mm ² solid or stranded wire	
Number of detectors per zone	> 20	<i>Dependent on type</i>
Number of sounders per circuit	Dependent on type and current consumption	<i>See table 6 for sounder types</i>
Detection circuit end of line	6K8 5% ½ Watt resistor	<i>Supplied in terminals</i>
Sounder circuit end of line	10K 5% ¼ Watt resistor	<i>Supplied in terminals</i>
No. of detection circuits	(see table 2 for number of zones for each model)	<i>Dependent on model</i>
No. of sounder outputs	2 (plus one per zone on T models)	
SIL, AL, FLT, RST inputs	Switched -ve, max resistance 100 Ohms	
Zone normal threshold	8K ohm TO 1K ohm	
Detector alarm threshold	999 ohms to 400 ohms	
Call point alarm threshold	399 ohms to 100 ohms	
Short circuit threshold	99 ohms to 0 ohms	
Head removal condition	15.5 to 17.5 volts	<i>Zener clamp detector base to be used</i>
Cabling	FP200 or equivalent (maximum capacitance 1uF maximum inductance 1 millihenry)	<i>Metal cable glands must be used</i>

Table 2 - Standby battery capacity required for fully loaded system

Panel model	24 hours standby	48 hours standby	72 hours standby	Standby current	Max panel alarm current
K11020 (2 Zones)	3Ah	4.6Ah	6.2Ah	0.065	0.10A
K11040 (4 Zones)	3.3Ah	5.1Ah	6.9Ah	0.075	0.21A
K11080 (8 Zones)	3.75Ah	5.95Ah	8.2Ah	0.093A	0.55A
T11020 (2 Zones)	3Ah	4.6Ah	6.2Ah	0.065	0.15A
T11040 (4 Zones)	3.3Ah	5.1Ah	6.9Ah	0.075	0.30A
T11080 (8 Zones)	3.75Ah	5.95Ah	8.2Ah	0.093A	0.63A

Table 3 - Battery charge voltage versus temperature

Temperature °C	Battery charge voltage
0	29.2
10	28.56
20	27.99
30	27.55
40	27.13

Table 4 - Compatible detectors

Model	Type	Manufacturer	Maximum Number per zone
SLR-E	OPTICAL	Hochiki	32
SIJ-E	IONISATION	Hochiki	32
DCD-1E	HEAT	Hochiki	32
DCD-2E	HEAT	Hochiki	32
DCD-1RE	HEAT	Hochiki	32
DFG-60E	HEAT	Hochiki	32
DFJ-60E	HEAT	Hochiki	32
DFJ90-E	HEAT	Hochiki	32
SPB-ET	BEAM	Hochiki	8
SRA-ET	BEAM	Hochiki	5
55000-200/210 - SERIES 60	IONISATION	Apollo	32
55000-300 - SERIES 60	OPTICAL	Apollo	32
55000-100 - SERIES 60	HEAT	Apollo	32
55000-101 - SERIES 60	HEAT	Apollo	32
55000-102 - SERIES 60	HEAT	Apollo	32
55000-103 - SERIES 60	HEAT	Apollo	32
55000-104 - SERIES 60	HEAT	Apollo	32
55000-215 - SERIES 65	IONISATION	Apollo	32
55000-216 - SERIES 65	IONISATION	Apollo	32
55000-217 - SERIES 65	IONISATION	Apollo	32
55000-218 - SERIES 65	IONISATION	Apollo	32
55000-219 - SERIES 65	IONISATION	Apollo	32
55000-220 - SERIES 65	IONISATION	Apollo	32
55000-315 - SERIES 65	OPTICAL	Apollo	32
55000-316 - SERIES 65	OPTICAL	Apollo	32
55000-317 - SERIES 65	OPTICAL	Apollo	32
55000-120 - SERIES 65	HEAT	Apollo	32
55000-121 - SERIES 65	HEAT	Apollo	32
55000-122 - SERIES 65	HEAT	Apollo	32
53541-151 - SERIES 30	IONISATION	Apollo	32
53541-152 - SERIES 30	IONISATION	Apollo	32
53551-101 - SERIES 30	OPTICAL	Apollo	32
53531-221 - SERIES 30	HEAT	Apollo	28
53531-211 - SERIES 30	HEAT	Apollo	28
53531-212 - SERIES 30	HEAT	Apollo	28
53531-213 - SERIES 30	HEAT	Apollo	28
53531-214 - SERIES 30	HEAT	Apollo	28
AS100	OPT	Argus Vega	22
AS200	OPT/HEAT	Argus Vega	22
AS300	HIGH TEMP HEAT	Argus Vega	26
AS400	RATE OF RISE HEAT	Argus Vega	26
NID-58	IONISATION	Nittan	32
2KC/2KD	OPTICAL	Nittan	32
2SA-LS/2SA-70T-LS	HEAT	Nittan	32
TCA-70-LS	HEAT	Nittan	32
NFD-18-2/NFD-18-5	FLAME	Nittan	3
NID-48F	IONISATION	Nittan	32
NS-12-7	HEAT	Nittan	32
NC-9C-70T	HEAT	Nittan	32
ECO1002	HEAT/PHOTO	System Sensor	6
ECO1003	PHOTO	System Sensor	13
ECO1005	HEAT	System Sensor	13
ECO1005T	HEAT	System Sensor	13

Although the current consumption of many detection devices would allow more than 32 to be connected to a zone, this number should be limited to 32 to ensure that a short or open circuit on the wiring does not prevent the indication of a fire alarm from more than 32 fire detectors and/or call points as required by European standard EN54-2.

No more than 32 detectors and call points should be fitted to any one zone.

Table 5 - Compatible detector bases and call points

Model	Type	Manufacturer	Comments
YBN-R/4	STANDARD	Hochiki	
YBO-R/5	STANDARD WITH REMOTE LED	Hochiki	
YBN-R/4SK	DIODE BASE	Hochiki	<i>Must be used with LCMU*</i>
YBO-R/5SK	DIODE BASE WITH REMOTE LED	Hochiki	<i>Must be used with LCMU*</i>
YBO-R/5PA	SAVWIRE	Hochiki	<i>Only with T series panels</i>
ECO1000R	STANDARD	System Sensor	
ECO1000BRSD	DIODE BASE	System Sensor	<i>Must be used with LCMU*</i>
45681-200	STANDARD BASE	Apollo	
45681-201	DIODE BASE	Apollo	<i>Must be used with LCMU*</i>
45681-206	SAVWIRE BASE	Apollo	<i>Only with T Series Panels</i>
AUBDR100-470	470R RESISTOR + DIODE	Argus Vega	<i>Must be used with LCMU*</i>
AUBSR100-470	470R RESISTOR	Argus Vega	
MCP1BR	470R RESISTOR + DIODE	KAC	<i>For 2-wire systems</i>
WR2012	470 + 680 OHM CALL POINT	KAC	<i>Use with both resistors intact for call point discrimination</i>
MCP1AR	470R	KC	<i>For standard, 4-wire systems</i>
CX	470 OHM CALL POINT	Fulleon	
NCP-T	CALL POINT	Nittan	
	ELECTRONICS FREE BASES	ALL	

Note: LCMU (Line Continuity Monitoring Device) part number K1406 allows call points mounted downline of detectors that have been removed from diode bases to continue to operate.

***LCMU units are not compatible with 2 wire "T" series Sigma CP Panels.**

Table 6 - Compatible sounders

Model	Type	Manufacturer	Comments
BANSHEE	ELECTRONIC	VIMPEX	
WAFER	ELECTRONIC	VIMPEX	
FIRECRYSER RANGE	ELECTRONIC VOICE	VIMPEX	
KOBELL	MOTORISED	VIMPEX	
ASKARI	ELECTRONIC	FULLEON	<i>Standard polarised type only</i>
ROSHNI	ELECTRONIC	FULLEON	<i>Standard polarised type only</i>
SQUASHNI	ELECTRONIC	FULLEON	<i>Standard polarised type only</i>
SYMPHONI	ELECTRONIC	FULLEON	<i>Standard polarised type only</i>
ELECTRONIC BELL	ELECTRONIC	FULLEON	<i>Standard polarised type only</i>
CFB BELLS	MOTORISED	FULLEON	<i>Standard polarised type only</i>
B6 AND B8 BELLS	SOLENOID	FULLEON	<i>Standard polarised type only</i>

Table 7 - Compatible I.S. barriers

Model	Type	Manufacturer
MTL5061	DETECTION ZONE GALVANIC ISOLATOR	MTL
MTL778ac	SOUNDER CIRCUITS SI AND S2 ONLY	MTL

Note: Use galvanic isolator with Hochiki or Apollo detectors only.

4. Using intrinsically safe barriers

SIGMA CP control panels support the use of I.S. barriers for connecting to equipment in hazardous areas. **Only certified detectors, call points and sounders may be used in hazardous areas and these must be connected to the control panel via a compatible I.S. barrier as listed in table 7.**

Connection of the I.S. barrier changes the characteristics of the detection circuit so zones that have I.S. barriers connected must be adjusted to work with them. Programmable options C61 to C68 allow each zone to operate with I.S. barriers.

The amount of detectors and call points that can be connected to a zone is limited by the I.S. approval system diagram which should be supplied by the detector manufacturer. The power rating of the end of line resistor will be dependent upon the Zone classification rating (Gas class) this will be specified on the system diagram.

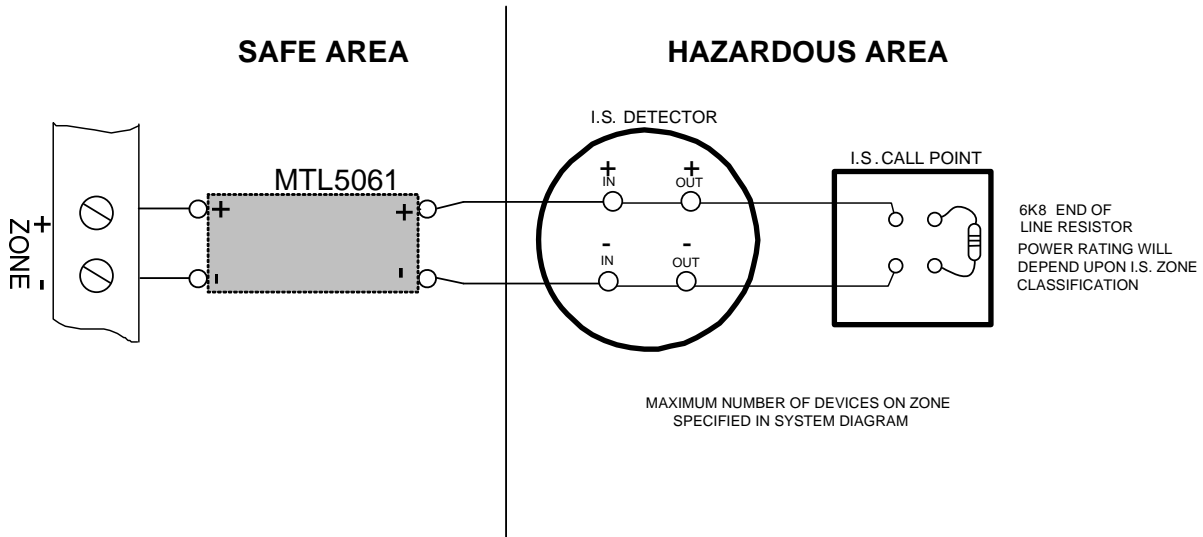

Figure 1. Detection zone wiring through an MTL5061 I.S. barrier

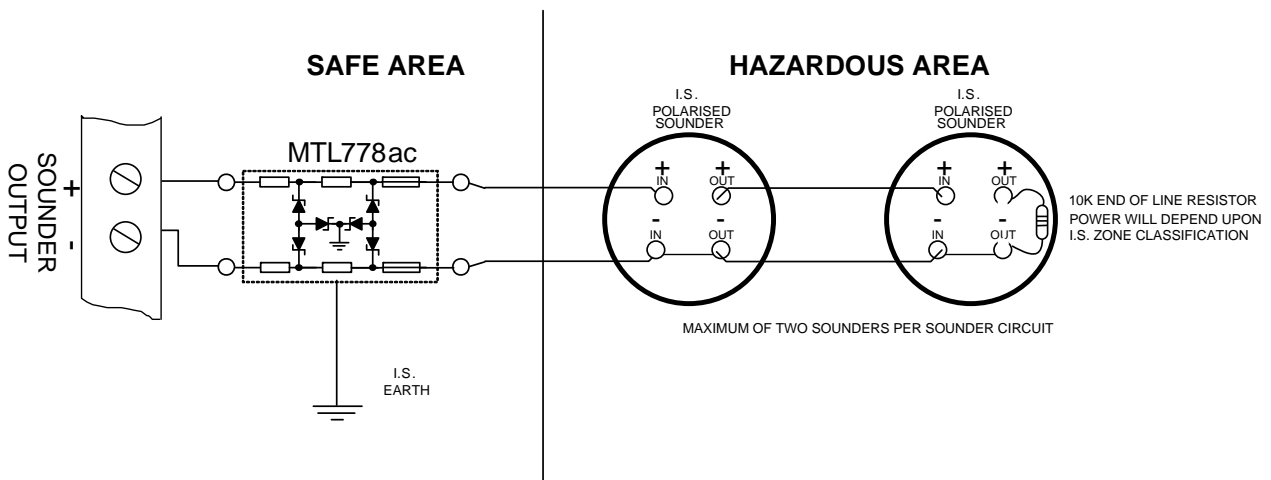
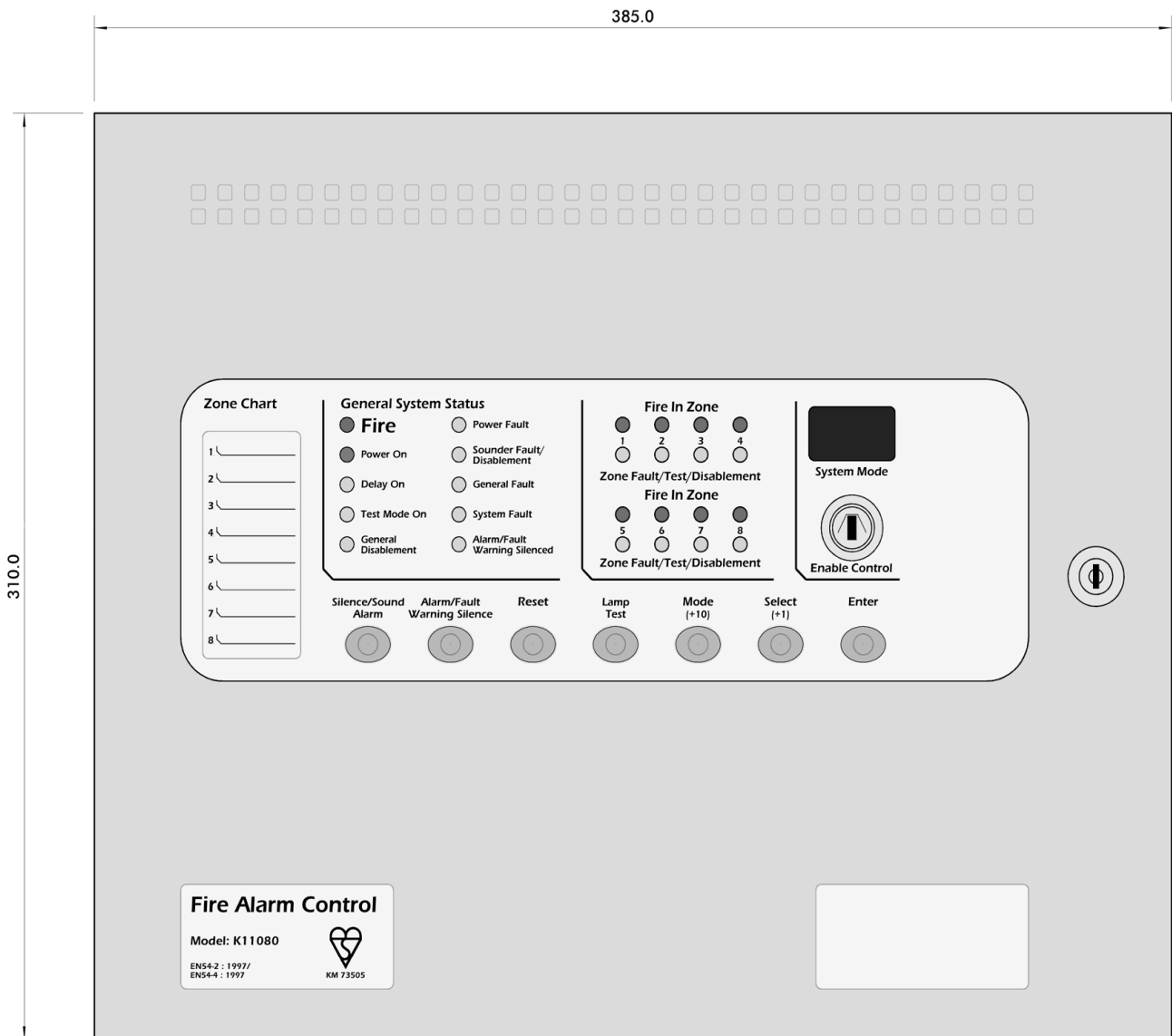

Figure 2. Sounder circuit wiring through an MTL778ac I.S. barrier

5. Control panel fascia



In addition to the mandatory controls and indications required by the EN54-2 standard, two, seven segment, LED displays and MODE, SELECT and ENTER buttons are provided to allow easy entry and storage of codes to configure the control panel to suit the requirements of the installation.

Removing the fascia

Before the fascia can be removed it will be necessary to unplug the three way terminal block on the left hand side of the PCB.

The fascia of the control panel is held in place by countersunk screws. Undo the two screws and lift the fascia gently away from the box towards you.

With the fascia removed there is much more room inside the panel for making off and dressing cables.

When cabling work is complete the fascia can be re-fitted with the two countersunk screws and the red, green/yellow and black wires re-connected to the three way terminal block.

It is most important that the polarity of the red and black wires is observed as wrong connection of these will damage the control panel.

6. Connecting to the circuit board

All connections for field wiring are to a single row of terminals along the top of the circuit board. The connections for the power cables are to a pluggable terminal block which may be pulled off of the board to remove the plate/PCB assembly. Remove this pluggable terminal only with mains power off. Shielded fire alarm cable such as FP200 and metal cable glands must be used for all connections to the panel.

The resistance of any core of any cable must not exceed 25 ohms. The shield of the cable must be bonded securely to the enclosure via a metal gland.

Wiring should enter the enclosure at the top of the panel using the knockouts provided and be formed tidily to the appropriate terminals leaving only enough wire to ensure that there is no strain on the PCB.

Terminals are capable of accepting wires of up to 2.5mm².

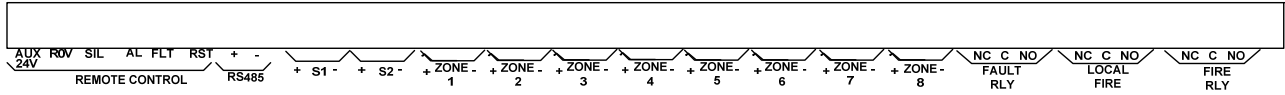

Terminal designations

Wiring must not go across the front of the circuit board plate or between the plate and the circuit board. If cable entries need to be in positions other than at the knockouts provided, wiring must be fed behind and well away from the surface of the circuit board.

The space at the bottom of the enclosure is largely occupied by the standby batteries so this must be borne in mind when considering cable entries.

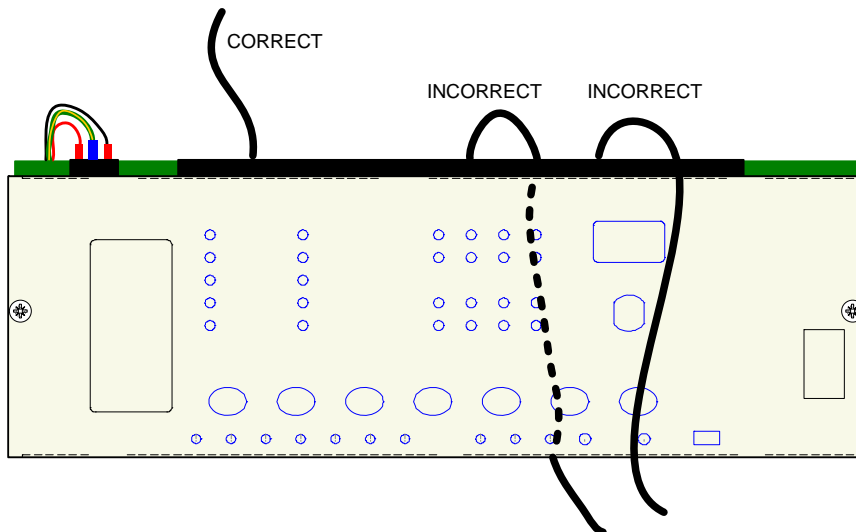

7. Software revision number

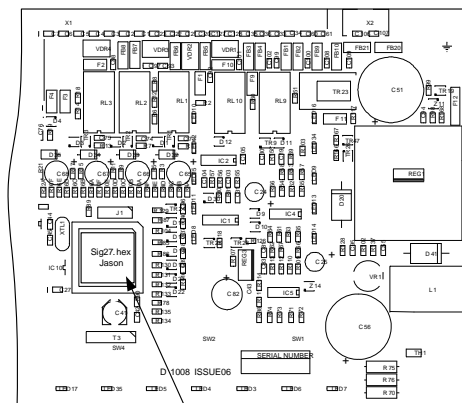

New features may be added to Sigma CP fire control panels from time to time and when this is done the operating software of the unit is updated. The software revision can be located on the main processor by removing the plate holding the PCB from the enclosure and turning it over. The software version will have a number such as "Sig27.hex" and it is this number which will determine which features the panel has installed and its compatibility with Sigma CP ancillary board, sounders boards, repeaters etc.

8. Detection zone wiring

The detection zones provide a nominal 24V DC to power conventional detectors and call points as listed in the compatibility tables on pages 6 and 7.

The wiring is monitored for open and short circuit fault conditions by removing the 6K8 end of line monitoring resistors that are supplied fitted to the control panels' terminals and placing them across the last device that is wired to the zone circuit.

Detection zone circuits must be wired as a single, radial circuit with no spurs or T junctions to enable the monitoring circuit to work correctly.

On T series panels, polarised sounders must also be wired across the detection zone but in reverse polarity to that shown by the zone terminals (see figure 5 below). At least one sounder should be fitted to each detection zone. Each zone can be configured individually as a 2-wire type zone or a non 2-wire type zone using configuration options C1 to C8.

For non 2-wire systems that are required to comply with BS5839 Part 1: 2002 detector removal requirements, detector bases fitted with a Schottky diode should be used and the end of line resistor replaced with an LCMU active end of line monitoring device.

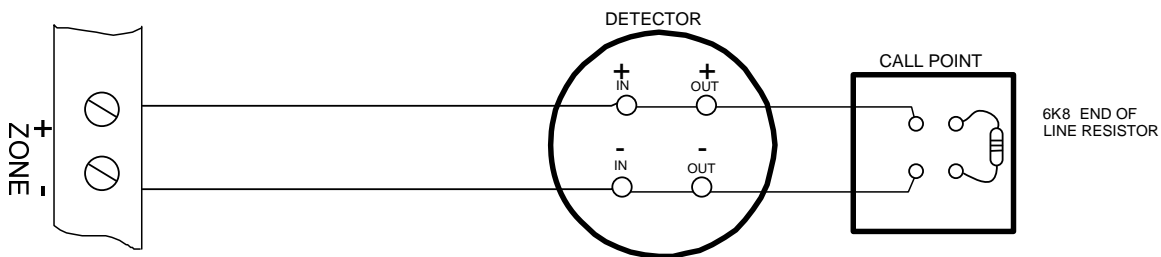

Figure 4.- K Series detection zone wiring

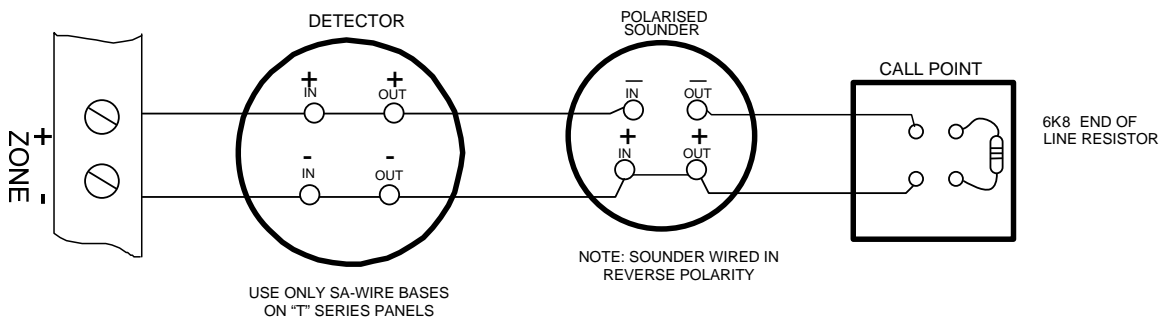

Figure 5.- T series detection zone wiring

9. Sounder circuit wiring

Whether using standard or T series control panels, all sounders must be of the polarised type. If non-polarised sounders are used the control panel will permanently show a fault condition. See table 6 on page 7 for a list of compatible sounder types.

Sounder circuits are monitored for open and short circuit faults by placing a 10K end of line monitoring resistor across the last device on the circuit.

Sounder circuits must be wired as a single, radial circuit with no spurs or T junctions to enable the monitoring circuit to work correctly.

A maximum of 1.6 Amps is available for powering sounders with a maximum load of 0.41 Amps on any one circuit.

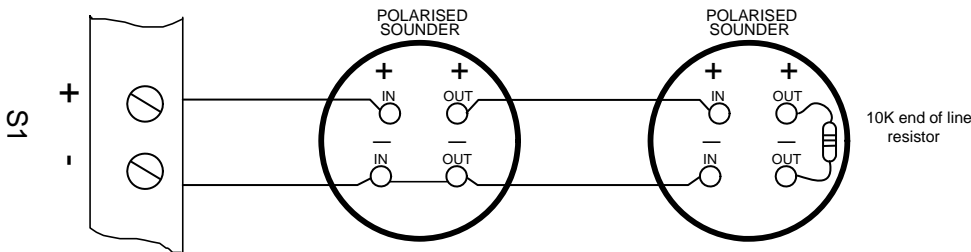

Figure 6.- Sounder circuit wiring

10. Connection to remote control terminals

Some functions of the control panel can be controlled externally from the panel if required. Operation of these inputs **must be restricted by an access level 2 control** as defined in EN54-2 These are abbreviated at the terminals block as follows:

- a) Remote 0 V supply - ROV
- b) Silence Alarm – SIL
- c) Sound Alarm – AL
- d) Fault – FLT
- e) Reset – RST

To activate these inputs, the remote 0 Volt (ROV) supply must be connected to the input via a normally open switch or contact and via a resistance of no greater than 100 ohms.

All of the remote control inputs are non-latching.

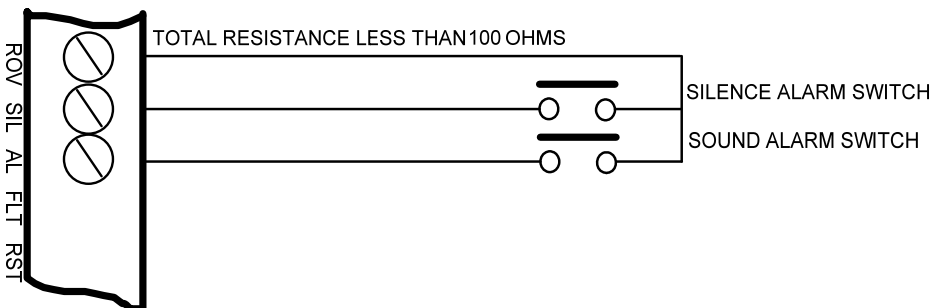

Figure 7- Example connections to remote control inputs

11. Aux 24V DC supply

An auxiliary 24V DC supply is provided to enable local signalling or control of ancillary systems such as door release controllers.

The terminals for the Aux 24V supply are labelled Aux 24V and ROV. The ROV terminal is the negative terminal and is the same terminal that should be used to switch the remote control terminals.

It is possible to make the ROV terminal pulsing so that by connecting it to the AL terminal via a remote, volt free contact, it can be used to pulse the dedicated sounder circuits in response to a signal from another system for example to give an alert. See programming code 24.

The supply is fitted with an electronic self resetting fuse to protect the control panel's 24V supply in the event of a wiring fault.

Any standing load on the Aux 24V supply must be taken into account when calculating battery standby times as standby time will be significantly affected by even modest standing loads. It is recommended that the Aux24V output is **not** used to power standing loads and not used to supply loads of greater than 300 milliamps

Where the Aux 24V supply is used to power electromechanical devices such as relays or door retainers it is imperative that a suppression diode is fitted across the coil of the electromechanical device to prevent the generation of high voltage transients back to the control panels power supply.

The Aux 24V DC Supply is not suitable for powering Sigma CP sounder boards, a separate power supply should be used for these.

12. Connection to relay contacts

Volt free changeover relay contacts are provided for local control and signalling if required. These contacts are rated for switching signalling circuits only and the maximum ratings listed in table 1 on page 5 should not be exceeded under any circumstances.

Fault relay

The fault relay is normally energised and will de-energise upon any fault condition including total loss of power.

Local fire relay

The local fire relay will energise upon activation of a fire condition on any of the zones or pressing of the sound alarm button on the front panel. The relay will remain activated until the alarm is silenced or the panel is reset. This relay will not operate upon activation of the remote AL input or when a fire condition is triggered on a zone that is in test mode.

Fire relay

The fire relay will energise upon activation of a fire condition on any of the zones. The relay will remain activated until the control panel is reset. This relay will *NOT* operate upon activation of the remote AL input. Individual zones can be configured not to operate the Fire relay by setting configuration options E1 to E8.

13. Connection to Repeater panels

Repeater panels connect via a 2 core cable to the terminals marked RS485 + and – on the Sigma CP main control panel PCB. Up to 7 repeaters may be connected and each repeater has terminals for the incoming cables and outgoing cables. All except the last ancillary board, sounder board or repeater panel connected to the cable must have the jumper links J2 removed.

Set the repeater address using the DIP switch (SW7); ensure no two repeaters share the same address.

Apply power to main panel first and then all repeater panels. Turn on the Enable Control keyswitch and set the Write Enable switch to on then briefly press the PROCESSOR RESET button on the main panel. Wait for a few seconds and the main panel will show the addresses of the repeaters that were found on the display for instance r1 indicates that a repeater at address 1 has been found.

Turn the write enable switch of, then on again and then press the ENTER button to accept each repeater that has been found. When all repeaters have been added, set the main panel Write Enable switch to off. Press the Watchdog reset switch on the main panel.

All repeaters are now configured and the main control panel will report a fault if any repeaters that have been accepted become faulty or go off line.

For full details of commissioning procedures for repeaters see the Sigma CP Repeater Operation and maintenance manual.

Please note that repeaters can only be fitted to panels containing boards labeled S4XXA or above. They will not work with panels containing boards without an alpha suffix.

For panels with software version Sigma242.hex or below, the Enable controls keyswitch and Write Enable switch must both be set to off.

14. Connection to Ancillary boards

Ancillary boards connect via a 2 core cable to the terminals marked RS485 + and – on the Sigma CP main control panel PCB. Up to 7 Ancillary boards may be connected and each board has terminals for the incoming cables and outgoing cables. All except the last ancillary board, sounder board or repeater panel connected to the cable must have the jumper links J2 removed.

Set the ancillary board address using the DIP switch (SW7); ensure no two ancillary boards share the same address.

Apply power to main panel and all ancillary boards then briefly press the PROCESSOR RESET button on the main panel, wait for a few seconds and the main panel will show the addresses of the ancillary boards that were found on the display for instance o1 indicates that an ancillary board at address 1 has been found. Press the ENTER button to accept each ancillary board that has been found.

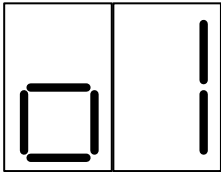

The control panel will report a fault if any ancillary boards that have been accepted become faulty or go off line.

For full details of commissioning procedures for ancillary boards see the Sigma CP Ancillary board Operation and maintenance manual.

Please note that Ancillary boards can only be fitted to panels containing boards labelled S4XXA or above. They will not work with panels containing boards without an alpha suffix.

15. Connection to 8 way Sounder boards

Sounder boards connect via a 2 core cable to the terminals marked RS485 + and – on the Sigma CP main control panel PCB. Up to 7 Sounder boards may be connected and each board has terminals for the incoming cables and outgoing cables. All except the last Ancillary board, Sounder board or Repeater connected to the cable must have the jumper links J2 removed. Sounder boards must be powered from a separate power supply which is suitably rated to supply the full sounder load that is connected. This can be up to 4 Amps if all circuits are fully loaded.

Set the Sounder board address using the DIP switch (SW7); ensure no two Sounder boards share the same address.

Apply power to main panel and all Sounder boards then briefly press the PROCESSOR RESET button on the main panel, wait for a few seconds and the main panel will show the addresses of the sounder boards that were found on the display for instance b1 indicates that a sounder board at address 1 has been found.

Press the ENTER button to accept each Sounder board that has been found.

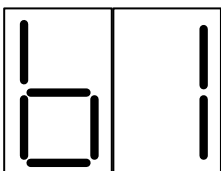

The control panel will report a sounder fault if any Sounder boards that have been accepted become faulty, have cable faults on their outputs or go off line.

For sounder boards to work option 25 must be set. This is set by default in the factory on 'T' type panels only, this setting should be checked if sounder boards are not working.

For full details of commissioning procedures for Sounder boards see the Sigma CP Sounder board Operation and maintenance manual.

Please note that Sounder boards can only be fitted to panels containing software SIGMA242.HEX or later.

16. Panel operation

16.1 Normal condition

Under normal conditions, control panels will have only the green, *Power On* LED lit.

16.2 Fire condition

Upon receipt of a fire condition by activation of a detector or call point, the *Common Fire* indicator will light and the zonal *Fire* indicators will flash at around 2Hz.

The fire and local fire relays will also operate and signal any systems to which they are connected.

Any sounders connected to the sounder circuits will operate in common, zonal or 2-stage mode as selected by configuration options 10 to 12 (see table 8).

16.3 Silence/sound alarms

The *Silence/Sound alarm* button can only be operated at access level two which means that the *Enable Control* key must be inserted.

To silence the sounders, insert the Enable Control key and press the Silence/Sound alarm button.

When the sounders have been silenced, the Zone Fire LEDs will change from flashing to a steady state.

Pressing the *Silence/Sound alarm* whilst the control panel is in this silenced condition, will cause the sounders to operate again.

The sounders can be toggled on and off with the *Silence/Sound alarm* button as required.

16.4 Reset

To reset the panel, insert the Enable key then press the Reset button.

16.5 Zone fault

Removal of a detector from its base or a fault on any of the zone wiring will cause the *Fault* LED and *Zone Fault* LEDs to light indicating the zone in which the fault has occurred.

16.6 Sounder fault

A fault on the wiring to sounder circuits will cause the *Fault* and *Sounder Fault* LEDs to light indicating a fault on the wiring to the sounder circuits.

16.7 Power fault

Failure of the mains power, disconnection of the standby battery or high impedance in the charging circuit will cause the *Fault* and *Power Fault* LEDs to light indicating an abnormality in the power supply to the control panel.

16.8 System fault

The *System Fault* LED will light if the configuration memory has not been set or has become corrupt.

16.9 Lamp test

All LED indicators can be tested at any time by pressing the *Lamp Test* button. The *Enable Control* key does not need to be inserted to test the indicators.

The buzzer can be silenced at any time by pressing the *Buzzer Silence* button. The enable key does not need to be inserted to silence the buzzer.

16.10 Disablements

It is possible to disable parts of the system. This may be required if there are works going on in a building which may cause the fire alarm system to operate in error.

16.10.1 Disable zones

To disable zones, the *Enable Control* key should be inserted and the mode button pressed until "d" appears in the first of the two seven segment LED displays. The *Select* button should then be pressed to select the number of the zone which is to be disabled in the second of the two seven segment displays. Once the desired zone is displayed, the enter button should be pressed to confirm the disablement.

The *Disable* LED will light and the *Zone Fault* LED will light for each disabled zone.

16.10.2 Disable sounders

To disable sounder outputs, press the mode button to select "db" on the seven segment display. Pressing enter will disable all sounders and cause the *Disable* and *Sounder Fault* LEDs to light.

16.10.3 Activate delays

To activate delays on zones as set in configuration options 31 to 48, press the mode button until Ad appears on the seven segment LED display. When the enter button is pressed any zones that are set as delayed will have their alarm outputs delayed by the time set in configuration options 00 to 09.

16.10.4 Disable fault contact

The fault relay can be disabled by selecting configuration option 22.

16.11 Test mode

Fire alarm systems must be tested regularly to ensure that they are functioning correctly. The Sigma CP range of panels enable the system to be tested single handed by using a test mode. When in test mode, activation of a fire alarm will be automatically reset after a few seconds to eliminate the need to return to the control panel to reset after every activation.

Test mode is entered in a similar way to disablements. With the *Enable Control* key inserted, press the *Mode* button until "t" appears in the first of the seven segment displays. Then press the *Select* button until the required zone number appears. Pressing the *Enter* button will cause the *Test* and *Zone Fault* LEDs to illuminate indicating the zones which are in test mode.

Disablements and zone tests are cleared by repeating the sequence that is used to select them, i.e. the "db" function (for example) toggles between sounders disabled and sounders enabled.

17. Configuration options

The Sigma CP range of control panels has many configuration options which can be set at the time of commissioning to suit the requirements of the installation. These options are normally set once and will rarely need to change. The configuration options are only available at access level 3. To access level 3, CAREFULLY slide the Write Enable switch (located behind the aperture in the panel plate) to the right position using a small screwdriver or similar. When the panel is at access level 3, the buzzer will "pip" three times every few seconds as an indication that it is at this access level.

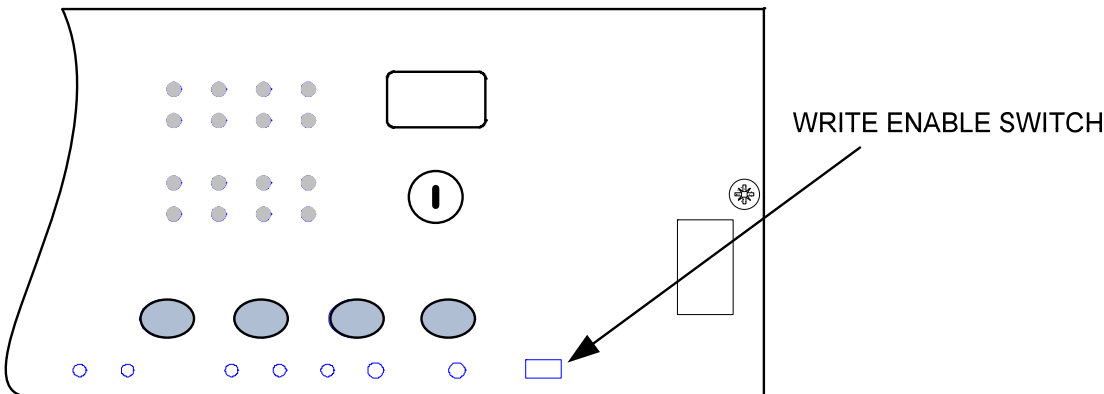

Figure 8 – Access level 3 (Write enable) enable switch location

Configuration options are simple to enter using the codes in table 8 below. When the control panel is at access level 3, the sub-text of the *Mode* and *Select* buttons is used to enter a number using tens (+10) and units (+1).

When the required code number is displayed, pressing the enter button will cause the dot on the units, seven segment display to flash. This indicates that a configuration option has been set.

To review which configuration options have been set previously, simply scroll through numbers 1 to 99, A1 to A8, C1 to C8 and E1 to E8 and those with a flashing dot indicate which options have been set.

ZONE 1 I.S. BARRIER
OPTION SET

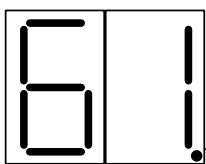

DOT
FLASHING

ZONE 1 I.S. BARRIER
OPTION NOT SET

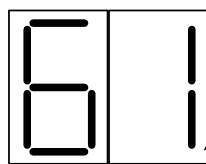

NO DOT

Figure 9 – Example display showing option set and not set.

Table 8 – Configuration codes

CODE	FUNCTION	COMMENTS
00	SOUNDER DELAY TIME = 30 SECONDS	Sets the time delay before sounders operate in combination with configuration codes 31 to 48 and access level 2 function AD.
01	SOUNDER DELAY TIME = 1 MINUTE	
02	SOUNDER DELAY TIME = 2 MINUTES	
03	SOUNDER DELAY TIME = 3 MINUTES	
04	SOUNDER DELAY TIME = 4 MINUTES	
05	SOUNDER DELAY TIME = 5 MINUTES	
06	SOUNDER DELAY TIME = 6 MINUTES	
07	SOUNDER DELAY TIME = 7 MINUTES	
08	SOUNDER DELAY TIME = 8 MINUTES	
09	SOUNDER DELAY TIME = 9 MINUTES	
10	COMMON ALARM MODE (default)	All sounders operate upon any fire condition
11	TWO-STAGE ALARM MODE	Continuous sounders in activated zone, pulsing elsewhere
12	ZONED ALARM MODE	Only sounders connected to zone in alarm operate
21*	DISABLE FIRE BUZZER	Buzzer will not operate on fire condition
22*	DISABLE FAULT OUTPUT	Fault relay will not operate except upon total power failure
23	DISABLE EARTH FAULT MONITORING	Connection of fire alarm wiring will not announce a fault
24	PULSED REMOTE CONTROL OUTPUT	Aux 24V supply pulses 1 sec on/1 sec off
25	ENABLE SOUNDERS ON DETECTION CIRCUITS	Set as default if panel is two wire "T" series (detectors and call points on same cables)
26	DISABLE FIRE OUTPUT	Fire relay will not operate upon any alarm
27	REMOVE AUX 24 UPON PANEL RESET	24V supply switches off for about 5 seconds when panel is reset
28	INDICATE CALL POINT ACTIVATION	Activation of a call point with a 270R resistance fitted is indicated by a flashing zone indicator and "Pu" on the 7 segment display. Activation of a detector will be indicated by a steady zone indicator and nothing on the 7 segment display.
29	DO NOT RE-SOUND ALARMS FROM ANOTHER ZONE	Silenced sounders will not re-sound upon further zone activations
31	ZONE 1 ALARM FROM DETECTOR DELAYED	Sounder outputs will be delayed by time set at options 0-9 when selected zone(s) triggered by detector only. Note: Access level 2 function Ad must be set for this to take effect.
32	ZONE 2 ALARM FROM DETECTOR DELAYED	
33	ZONE 3 ALARM FROM DETECTOR DELAYED	
34	ZONE 4 ALARM FROM DETECTOR DELAYED	
35	ZONE 5 ALARM FROM DETECTOR DELAYED	
36	ZONE 6 ALARM FROM DETECTOR DELAYED	
37	ZONE 7 ALARM FROM DETECTOR DELAYED	
38	ZONE 8 ALARM FROM DETECTOR DELAYED	
41	ZONE 1 ALARM FROM CALL POINT DELAYED	Sounder outputs will be delayed by time set at options 0-9 when selected zone(s) triggered by call point only. Note access level 2 function Ad must be set for this to take effect.
42	ZONE 2 ALARM FROM CALL POINT DELAYED	
43	ZONE 3 ALARM FROM CALL POINT DELAYED	
44	ZONE 4 ALARM FROM CALL POINT DELAYED	
45	ZONE 5 ALARM FROM CALL POINT DELAYED	
46	ZONE 6 ALARM FROM CALL POINT DELAYED	
47	ZONE 7 ALARM FROM CALL POINT DELAYED	
48	ZONE 8 ALARM FROM CALL POINT DELAYED	
51	COINCIDENCE ZONE 1	Zone contributes to ancillary board coincidence O/P. Any number of zones can be selected to contribute.
52	COINCIDENCE ZONE 2	
53	COINCIDENCE ZONE 3	
54	COINCIDENCE ZONE 4	
55	COINCIDENCE ZONE 5	
56	COINCIDENCE ZONE 6	
57	COINCIDENCE ZONE 7	
58	COINCIDENCE ZONE 8	
61	CONFIGURE Z1 FOR I.S BARRIER	Detection threshold changed for use with IS barrier
62	CONFIGURE Z2 FOR I.S BARRIER	
63	CONFIGURE Z3 FOR I.S BARRIER	
64	CONFIGURE Z4 FOR I.S BARRIER	
65	CONFIGURE Z5 FOR I.S BARRIER	
66	CONFIGURE Z6 FOR I.S BARRIER	
67	CONFIGURE Z7 FOR I.S BARRIER	
68	CONFIGURE Z8 FOR I.S BARRIER	

CODE	FUNCTION	COMMENTS
71*	ZONE 1 SHORT CIRCUIT INDICATES ALARM	Changes the trigger threshold of the zone so that the control panel can be used on older systems that had no short circuit monitoring.
72*	ZONE 2 SHORT CIRCUIT INDICATES ALARM	
73*	ZONE 3 SHORT CIRCUIT INDICATES ALARM	
74*	ZONE 4 SHORT CIRCUIT INDICATES ALARM	
75*	ZONE 5 SHORT CIRCUIT INDICATES ALARM	
76*	ZONE 6 SHORT CIRCUIT INDICATES ALARM	
77*	ZONE 7 SHORT CIRCUIT INDICATES ALARM	
78*	ZONE 8 SHORT CIRCUIT INDICATES ALARM	
81*	ZONE 1 NON-LATCHING	Renders the zone self-resetting so that it can be used to receive signals from other systems and will reset when the input is removed. Note: It can take up to 20 seconds for zone to reset itself when sounders are operating
82*	ZONE 2 NON-LATCHING	
83*	ZONE 3 NON-LATCHING	
84*	ZONE 4 NON-LATCHING	
85*	ZONE 5 NON-LATCHING	
86*	ZONE 6 NON-LATCHING	
87*	ZONE 7 NON-LATCHING	
88*	ZONE 8 NON-LATCHING	
91	ZONE 1 DOES NOT SOUND ALARMS	Prevents the zone from operating the two common sounder outputs.
92	ZONE 2 DOES NOT SOUND ALARMS	
93	ZONE 3 DOES NOT SOUND ALARMS	
94	ZONE 4 DOES NOT SOUND ALARMS	
95	ZONE 5 DOES NOT SOUND ALARMS	
96	ZONE 6 DOES NOT SOUND ALARMS	
97	ZONE 7 DOES NOT SOUND ALARMS	
98	ZONE 8 DOES NOT SOUND ALARMS	
A1*	ZONE 1 ANY ALARM DELAYED	Zone needs to be triggered for 30 seconds continuously before an alarm is generated.
A2*	ZONE 2 ANY ALARM DELAYED	
A3*	ZONE 3 ANY ALARM DELAYED	
A4*	ZONE 4 ANY ALARM DELAYED	
A5*	ZONE 5 ANY ALARM DELAYED	
A6*	ZONE 6 ANY ALARM DELAYED	
A7*	ZONE 7 ANY ALARM DELAYED	
A8*	ZONE 8 ANY ALARM DELAYED	
C1	ZONE 1 SOUNDERS INHIBITED	Enables individual zones to be configured not to operate zonal sounders. On 2 wire "T" series panels this enables individual zones to be configured for use with conventional (non 2-wire) detector bases. SOFTWARE VERSIONS SIGMA242.HEX and above only
C2	ZONE 2 SOUNDERS INHIBITED	
C3	ZONE 3 SOUNDERS INHIBITED	
C4	ZONE 4 SOUNDERS INHIBITED	
C5	ZONE 5 SOUNDERS INHIBITED	
C6	ZONE 6 SOUNDERS INHIBITED	
C7	ZONE 7 SOUNDERS INHIBITED	
C8	ZONE 8 SOUNDERS INHIBITED	
E1*	ZONE 1 WILL NOT OPERATE FIRE RELAY	Enables individual zones to be selected to not operate the fire relay. This is sometimes combined with the non-latching function to prevent ring around on interconnected panels. SOFTWARE VERSIONS SIGMA242.HEX and above only
E2*	ZONE 2 WILL NOT OPERATE FIRE RELAY	
E3*	ZONE 3 WILL NOT OPERATE FIRE RELAY	
E4*	ZONE 4 WILL NOT OPERATE FIRE RELAY	
E5*	ZONE 5 WILL NOT OPERATE FIRE RELAY	
E6*	ZONE 6 WILL NOT OPERATE FIRE RELAY	
E7*	ZONE 7 WILL NOT OPERATE FIRE RELAY	
E8*	ZONE 8 WILL NOT OPERATE FIRE RELAY	

NOTE: Setting the options marked with asterisks does not comply with EN54-2

Once the required configuration options have been set, the Write enable switch **must** be returned to its normal position to the right. The General fault indicator will remain lit if the Write enable switch is not turned off.

18. Watchdog reset switch

If for any reason the microprocessor in the control panel fails to carry out its operation correctly it will attempt to restart itself. This process is called a "watchdog" and the control panel must record and indicate these events.

If a watchdog event occurs, the control panel will show the FAULT and SYSTEM FAULT LEDs on the front panel, the CPU fault LED inside the panel.

This fault can only be cleared by pressing the WATCHDOG RESET button on the PCB inside the control panel. The control panel buzzer can not be silenced and will continue to sound until the watchdog activation is reset.

19. Processor reset switch

Once started, the microprocessor controlling the panel should continue to run continuously without interruption. If the microprocessor fails to run correctly it can be reset by pressing the PROCESSOR RESET button on the PCB inside the control panel.

This should not normally be necessary but should be done as a matter of course if the system is behaving abnormally. The system should resume normal operation within a couple of seconds of pressing the processor reset button.

20. Internal indications – troubleshooting

To assist in identifying fault conditions which are not detailed on the front of the control panel, a number of internal indicators are visible with the front cover removed as follows:

20.1 Mains fail

Indicates that the 230V AC supply is not present and the system is running on standby batteries. If there is not a power cut, check the panels mains fuse.

20.2 Batt fail

Indicates that the standby battery has become disconnected or that the charging circuit of the control panel has a high resistance or has failed. Check that both batteries are connected and linked together. Test battery. Disconnect battery and ensure that 28 Volts can be measured on battery charger leads.

20.3 CPU fault

Indicates that the central processor unit has failed to correctly execute code and has been re-started by the system watchdog. The watchdog reset switch must be pressed to clear the CPU fault condition. Press watchdog reset. If system does not return to normal then the panel is probably damaged and needs the circuit board replacing. (See maintenance section).

20.4 Aux 24V fault

The Aux 24V and ROV terminals provide a 500 milliamp, 24V DC power supply for power fire alarm ancillary equipment. This LED indicates that fuse protecting the ROV output has operated and the rating of this output has been exceeded. The fuse is a self resetting type and the supply will resume when the fault condition is removed.

20.5 Batt low

Illuminates when the system is running on batteries and the battery voltage is lower than 21V +/-2% (the minimum battery voltage).

20.6 Earth fault

Indicates that part of the system wiring is connected to earth. Remove all system wiring and re-connect cables one at a time until the earth fault returns. This will indicate which cable the earth fault is present on.

20.7 Sys fuse fault

Indicates that the total power rating of the power supply has been exceeded and that the system fuse has come into operation. Remove and review all loads and re-connect one at a time until over rated circuit trips fuse to identify troublesome circuit.

20.8 S1 fault and S2 fault

Indicates a short or open circuit on sounder outputs. Remove wiring and refit end of line resistors. Check sounder circuit wiring.

20.9 Comms fault

Indicates that communication has been lost with a repeater panel or Ancillary board. Check for comms fault at all repeaters and ancillary boards to identify the source of the problem.

21. Power supply

The control panel requires a 230V (+10%/-15%), 50/60Hz, AC mains power supply which connects to the fused terminal block labelled "230V".

The fused terminal block contains a 20mm, F1.6A L250V fuse which should only be replaced with a similar type.

The output voltage of the power supply is 28V DC +/- 2V and the total current rating including a maximum 0.7A for battery charging is 3 Amps. Fuse F12 mounted on the circuit board is a self-resetting electronic fuse rated at 4 Amps.

The incoming mains cable should be routed well away from other lower voltage wiring by a distance of at least 50mm.

Mains wiring should include an earth conductor which is securely bonded to the building earth and should enter the enclosure as close as possible to the mains terminal block. Mains wires should be kept very short inside the enclosure and secured together close to the mains terminal block with a cable tie.

The control panel can accept sealed lead acid rechargeable batteries of up to 7Ah maximum capacity (see table 2 for battery size required for each model).

The maximum current drawn from the batteries when the main power source is disconnected is 3 Amps.

Battery leads are supplied wired to the PCB along with a link to connect the two batteries in series. The PCB is fitted with a 20mm, 3.15A T1 glass fuse (F13) in the battery charging circuit which must only be replaced with one of the same type.

It is most important that the polarity of the batteries is carefully observed when connecting.

When the batteries are discharged to a level at which a low battery indication is given, the BATT FAIL indicator will also be lit.

Wrongly connected batteries could cause damage to the control panel.

Figure 9 – Mains and battery connections

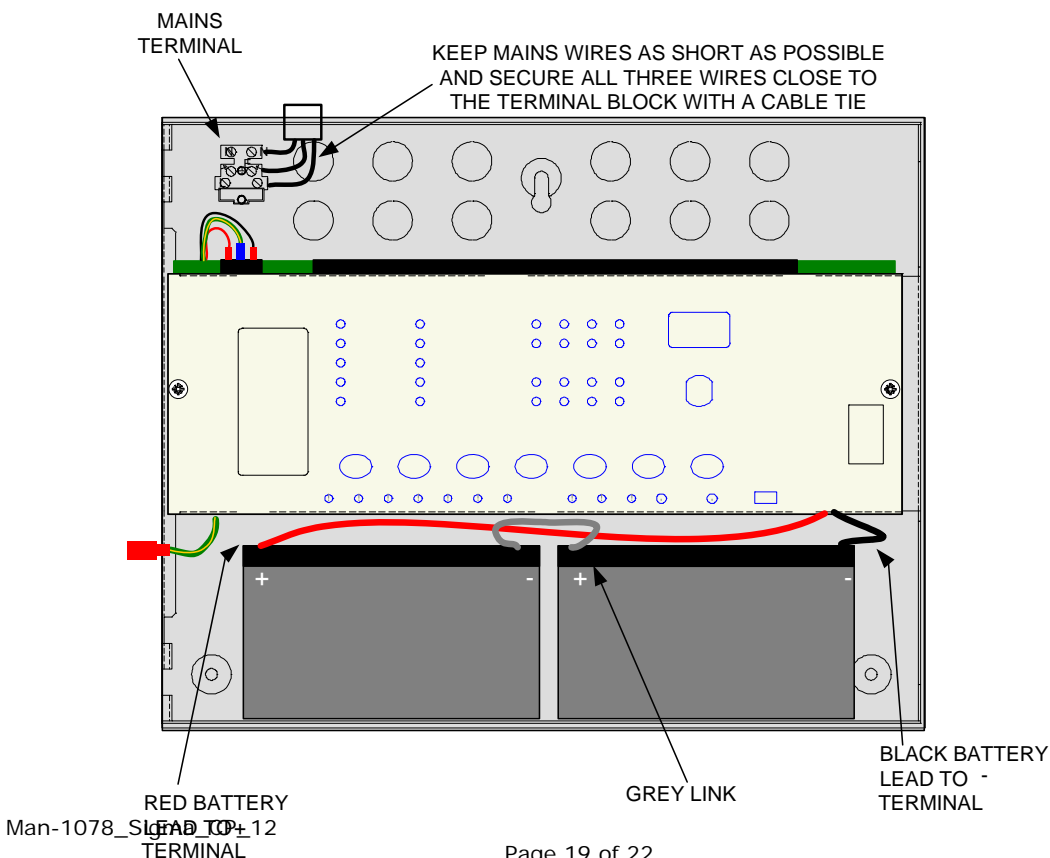

22. Maintenance

Sigma CP control panels do not require any specific maintenance but should the control panel become dirty it can be wiped over with a damp cloth and should then be dried with a dry, lint free cloth. Detergents or solvents should not be used to clean the panel and care must be taken that water does not enter the enclosure.

The control panel contains sealed lead acid batteries to provide standby power in the event of a mains failure.

These batteries have a life expectancy of around 4 years. It is recommended that these batteries be tested in accordance with the battery manufacturer's recommendations annually to determine their suitability for continued standby applications.

Routine testing of the fire alarm system in accordance with BS5839: Part 1: 2002 will identify any malfunction of the control panel and any malfunction should be reported to the fire alarm maintenance company immediately.

Should the control panel become faulty the complete electronic assembly can be replaced.

To do this, any configured options should be noted then both mains and battery power should be removed before the work is started.

The field wiring should be carefully labelled and removed from the terminals.

The PCB can now be taken out of the panel by removing the 2 holding the plate in position.

Fitting the new PCB is the reverse of the procedure for removing the board.

23. Zone designation label

All Sigma CP control panels are supplied with a zone designation label onto which zone designations can be written.

This enables each zone to be given a text description allowing easier identification of any zones showing an abnormal condition.

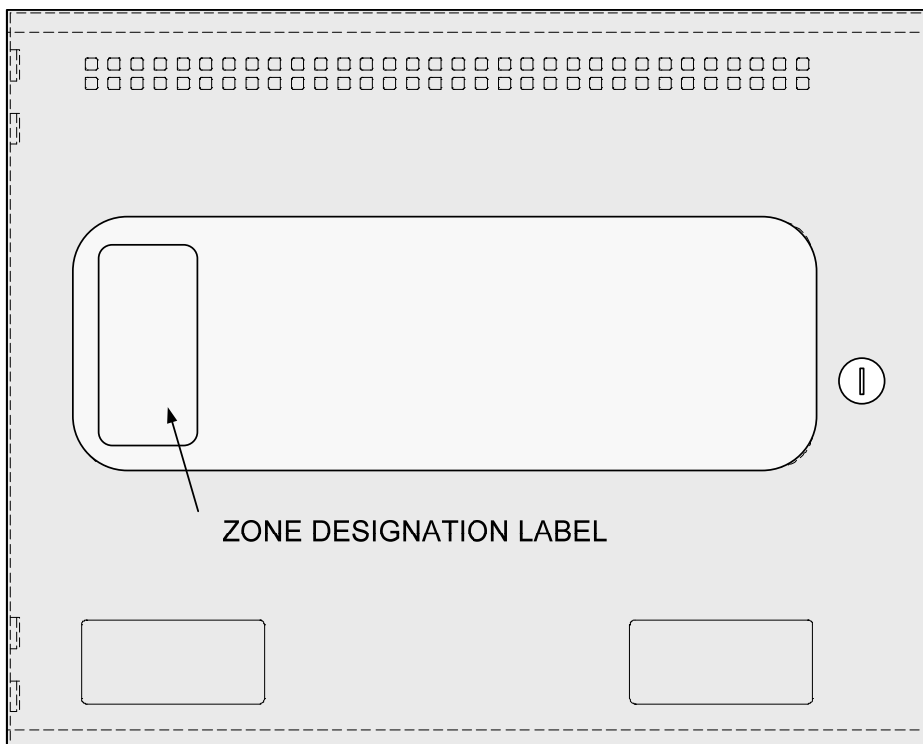

24. Record of Configuration

Use the table below to record the configuration codes that have been set on the control panel for future reference. Place a tick in the grey band for any configuration options that are set.

It is recommended that a copy of this table is left with the control panel under the supervision of the person responsible for the fire detection system.

CODE	FUNCTION	COMMENTS	SET
00	SOUNDER DELAY TIME = 30 SECONDS	Sets the time delay before sounders operate in combination with configuration codes 31 to 48 and access level 2 function AD.	
01	SOUNDER DELAY TIME = 1 MINUTE		
02	SOUNDER DELAY TIME = 2 MINUTES		
03	SOUNDER DELAY TIME = 3 MINUTES		
04	SOUNDER DELAY TIME = 4 MINUTES		
05	SOUNDER DELAY TIME = 5 MINUTES		
06	SOUNDER DELAY TIME = 6 MINUTES		
07	SOUNDER DELAY TIME = 7 MINUTES		
08	SOUNDER DELAY TIME = 8 MINUTES		
09	SOUNDER DELAY TIME = 9 MINUTES		
10	COMMON ALARM MODE	All sounders operate upon any fire condition	
11	TWO-STAGE ALARM MODE	Continuous sounders in activated zone, pulsing elsewhere	
12	ZONED ALARM MODE	Only sounders connected to zone in alarm operate	
21*	DISABLE FIRE BUZZER	Buzzer will not operate on fire condition	
22*	DISABLE FAULT OUTPUT	Fault relay will not operate except upon total power failure	
23	DISABLE EARTH FAULT MONITORING	Connection of fire alarm wiring will not announce a fault	
24	PULSED REMOTE CONTROL OUTPUT	Aux 24V supply pulses 1 sec on/1 sec off	
25	ENABLE SOUNDERS ON DETECTION CIRCUITS	Set as default if panel is two wire "T" series (detectors and call points on same cables)	
26	DISABLE FIRE OUTPUT	Fire relay will not operate upon any alarm	
27	REMOVE AUX 24 UPON PANEL RESET	24V supply switches off for about 5 seconds when panel is reset	
28	INDICATE CALL POINT ACTIVATION	Activation of a call point with a 270R resistance fitted is indicated by a flashing zone indicator and "Pu" on the 7 segment display. Activation of a detector will be indicated by a steady zone indicator and nothing on the 7 segment display	
29	DO NOT RE-SOUND ALARMS FROM ANOTHER ZONE	Silenced sounders will not re-sound upon further zone activations	
31	ZONE 1 ALARM FROM DETECTOR DELAYED	Sounder outputs will be delayed by time set at options 0-9 when selected zone(s) triggered by detector only. Note access level 2 function Ad must be set for this to take effect.	
32	ZONE 2 ALARM FROM DETECTOR DELAYED		
33	ZONE 3 ALARM FROM DETECTOR DELAYED		
34	ZONE 4 ALARM FROM DETECTOR DELAYED		
35	ZONE 5 ALARM FROM DETECTOR DELAYED		
36	ZONE 6 ALARM FROM DETECTOR DELAYED		
37	ZONE 7 ALARM FROM DETECTOR DELAYED		
38	ZONE 8 ALARM FROM DETECTOR DELAYED		
41	ZONE 1 ALARM FROM CALL POINT DELAYED	Sounder outputs will be delayed by time set at options 0-9 when selected zone(s) triggered by call point only. Note access level 2 function Ad must be set for this to take effect.	
42	ZONE 2 ALARM FROM CALL POINT DELAYED		
43	ZONE 3 ALARM FROM CALL POINT DELAYED		
44	ZONE 4 ALARM FROM CALL POINT DELAYED		
45	ZONE 5 ALARM FROM CALL POINT DELAYED		
46	ZONE 6 ALARM FROM CALL POINT DELAYED		
47	ZONE 7 ALARM FROM CALL POINT DELAYED		
48	ZONE 8 ALARM FROM CALL POINT DELAYED		
51	COINCIDENCE ZONE 1	Zone contributes to ancillary board coincidence O/P. Any number of zones can be selected to contribute.	
52	COINCIDENCE ZONE 2		
53	COINCIDENCE ZONE 3		
54	COINCIDENCE ZONE 4		
55	COINCIDENCE ZONE 5		
56	COINCIDENCE ZONE 6		
57	COINCIDENCE ZONE 7		
58	COINCIDENCE ZONE 8		
61	CONFIGURE Z1 FOR I.S BARRIER	Detection threshold changed for use with IS barrier	
62	CONFIGURE Z2 FOR I.S BARRIER		
63	CONFIGURE Z3 FOR I.S BARRIER		
64	CONFIGURE Z4 FOR I.S BARRIER		
65	CONFIGURE Z5 FOR I.S BARRIER		
66	CONFIGURE Z6 FOR I.S BARRIER		
67	CONFIGURE Z7 FOR I.S BARRIER		
68	CONFIGURE Z8 FOR I.S BARRIER		

CODE	FUNCTION	COMMENTS	SET
71*	ZONE 1 SHORT CIRCUIT INDICATES ALARM	Changes the trigger threshold of the zone so that the control panel can be used on older systems that had no short circuit monitoring.	
72*	ZONE 2 SHORT CIRCUIT INDICATES ALARM		
73*	ZONE 3 SHORT CIRCUIT INDICATES ALARM		
74*	ZONE 4 SHORT CIRCUIT INDICATES ALARM		
75*	ZONE 5 SHORT CIRCUIT INDICATES ALARM		
76*	ZONE 6 SHORT CIRCUIT INDICATES ALARM		
77*	ZONE 7 SHORT CIRCUIT INDICATES ALARM		
78*	ZONE 8 SHORT CIRCUIT INDICATES ALARM		
81*	ZONE 1 NON-LATCHING	Renders the zone self-resetting so that it can be used to receive signals from other systems and will reset when the input is removed. Note: It can take up to 20 seconds for zone to reset itself when sounders are operating	
82*	ZONE 2 NON-LATCHING		
83*	ZONE 3 NON-LATCHING		
84*	ZONE 4 NON-LATCHING		
85*	ZONE 5 NON-LATCHING		
86*	ZONE 6 NON-LATCHING		
87*	ZONE 7 NON-LATCHING		
88*	ZONE 8 NON-LATCHING		
91	ZONE 1 DOES NOT SOUND ALARMS	Prevents the zone from operating the two common sounder outputs	
92	ZONE 2 DOES NOT SOUND ALARMS		
93	ZONE 3 DOES NOT SOUND ALARMS		
94	ZONE 4 DOES NOT SOUND ALARMS		
95	ZONE 5 DOES NOT SOUND ALARMS		
96	ZONE 6 DOES NOT SOUND ALARMS		
97	ZONE 7 DOES NOT SOUND ALARMS		
98	ZONE 8 DOES NOT SOUND ALARMS		
99			
A1*	ZONE 1 ANY ALARM DELAYED	Zone needs to be triggered for 30 seconds continuously before an alarm is generated.	
A2*	ZONE 2 ANY ALARM DELAYED		
A3*	ZONE 3 ANY ALARM DELAYED		
A4*	ZONE 4 ANY ALARM DELAYED		
A5*	ZONE 5 ANY ALARM DELAYED		
A6*	ZONE 6 ANY ALARM DELAYED		
A7*	ZONE 7 ANY ALARM DELAYED		
A8*	ZONE 8 ANY ALARM DELAYED		
C1	ZONE 1 SOUNDERS INHIBITED	Enables individual zones to be configured not to operate zonal sounders. On 2 wire "T" series panels this enables individual zones to be configured for use with conventional (non-savwire) detector bases. SOFTWARE VERSIONS SIGMA242.HEX hex and above only	
C2	ZONE 2 SOUNDERS INHIBITED		
C3	ZONE 3 SOUNDERS INHIBITED		
C4	ZONE 4 SOUNDERS INHIBITED		
C5	ZONE 5 SOUNDERS INHIBITED		
C6	ZONE 6 SOUNDERS INHIBITED		
C7	ZONE 7 SOUNDERS INHIBITED		
C8	ZONE 8 SOUNDERS INHIBITED		
E1*	ZONE 1 WILL NOT OPERATE FIRE RELAY	Enables individual zones to be selected to not operate the fire relay. This is sometimes combined with the non-latching function to prevent ring around on interconnected panels. SOFTWARE VERSIONS SIGMA242.HEX hex and above only	
E2*	ZONE 2 WILL NOT OPERATE FIRE RELAY		
E3*	ZONE 3 WILL NOT OPERATE FIRE RELAY		
E4*	ZONE 4 WILL NOT OPERATE FIRE RELAY		
E5*	ZONE 5 WILL NOT OPERATE FIRE RELAY		
E6*	ZONE 6 WILL NOT OPERATE FIRE RELAY		
E7*	ZONE 7 WILL NOT OPERATE FIRE RELAY		
E8*	ZONE 8 WILL NOT OPERATE FIRE RELAY		

NOTE: Setting the options marked with asterisks does not comply with EN54-2