



Series 2000 Garage Door Price List

01.04.2019

HÖRMANN



HÖRMANN IS ALWAYS COMMITTED TO EXCELLENCE: “In Engineering, in User Safety and in Design.”

All our products are third party tested to the highest standards and are certified to the high safety requirements and performance characteristics of the European Standard 13241-1.

This gives you the reassurance that your purchase of a Hörmann product is a safe investment. We are also committed to our national network of Garage Door Specialist Distributors.

These are independent businesses, who believe in customer service and have skills to advise you on the best product for your property, also providing quality fitting and finishing.

“A great product performs at its best when fitted by experts.”

Door Operating Systems

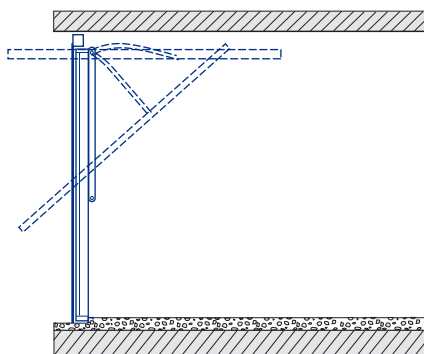

Canopy Operating Gear

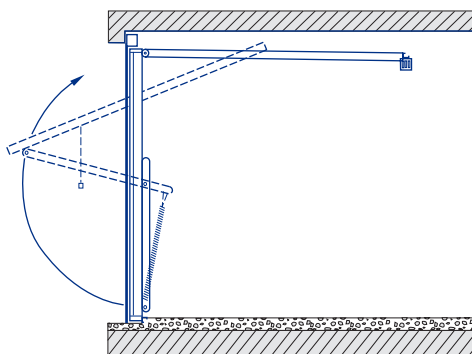

Retractable Operating Gear

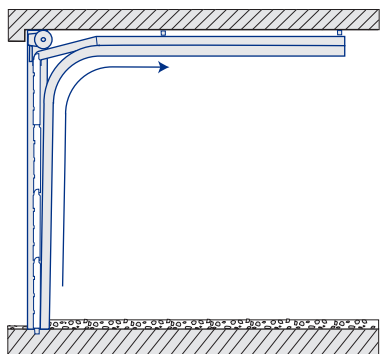



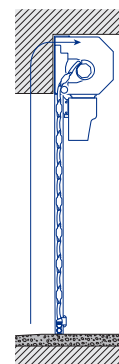



Sectional Operating Gear



RollMatic Operating Gear

Contents

	Up-and-over garage door	Canopy and retractable with steel infill	2
		Canopy and retractable with timber infill	6
		Canopy and retractable with GRP infill (Glass reinforced polyester)	10
<hr/>			
	Sectional garage doors	Sectional garage doors LTE 42 Single-skinned steel sectional doors	12
		Sectional garage doors LPU 42 Double-skinned steel sectional doors	13
		Optional extras and window designs	16
<hr/>			
	Hinged double-leaf garage doors		
		Sectional double-leaf side doors with block frames made of aluminium profiles	18
<hr/>			
	RollMatic Roller Garage Doors	RollMatic roller garage doors	20
		RollMatic side doors	24
		RollMatic TDL	25
		RollMatic OD	26
<hr/>			
	Garage door operators	Garage door operators	30
		Operator accessories	30

Hörmann Up-and-Over Doors

Canopy & retractable with steel infill



SINGLE DOORS		Door sizes BR		2001 Vertical		2002 Horizontal		2601 Elegance		2602 Finesse		2101 Ilkley		2103 Caxton	
				CAN.	RET.	CAN.	RET.	CAN.	RET.	CAN.	RET.	CAN.	RET.	CAN.	RET.
Imperial	Metric	CAN.	RET.	CAN.	RET.	CAN.	RET.	CAN.	RET.	CAN.	RET.	CAN.	RET.	CAN.	RET.
6'6" x 6'6"	6'6"	1981 x 1981	665	706	584	625									
	7'0"	1981 x 2134	665	706	584	625									
6'10" x 6'4"	6'6"	2083 x 1930	663	704	598	639									
	7'0"	2083 x 2134	680	721	634	675									
7'0" x 6'4"	6'6"	2134 x 1981	647 ¹	688 ¹	584 ¹	625 ¹	820	861	820	861	1107	1148			
	7'0"	2134 x 2134	671 ¹	712 ¹	613 ¹	654 ¹	866	907	866	907	1119	1160	1068	1109	
	7'6"	2134 x 2286		821		766									
	7'6"	2134 x 2286		821		766									
7'3" x 6'4"	6'6"	2210 x 1930	699 ¹	740 ¹	658	699									
	6'6"	2210 x 1981	702	743	661	702									
	7'0"	2210 x 2134	712	753	668	709									
7'5" x 6'6"	6'6"	2261 x 1981	708	749	658	699					1149	1190			
	7'0"	2261 x 2134	794	835	749	790					1162	1203			
7'6" x 6'4"	6'6"	2286 x 1981	723 ¹	764 ¹	658 ¹	699 ¹	909	950	909	950	1149	1190	1130	1171	
	7'0"	2286 x 2134	794 ¹	835 ¹	751 ¹	792 ¹	1047	1088	1047	1088	1162	1203	1142	1183	
	7'6"	2286 x 2286		893		918									
	7'6"	2286 x 2286		893		918									
7'8" x 6'4"	6'6"	2337 x 1930	819	860	756	797									
	6'6"	2438 x 1930	856	897	757	798					1219	1260			
	6'6"	2438 x 1981	856 ¹	897 ¹	757	798	1075	1116	1075	1116	1219	1260			
	7'0"	2438 x 2134	886 ¹	927 ¹	772	813	1119	1160	1119	1160	1230	1271	1228	1269	
	7'6"	2438 x 2286		1005		894									
8'0" x 6'4"	6'6"	2438 x 1981	856 ¹	897 ¹	757	798	1075	1116	1075	1116	1219	1260			
	7'0"	2438 x 2134	886 ¹	927 ¹	772	813	1119	1160	1119	1160	1230	1271	1228	1269	
8'6" x 6'6"	6'6"	2590 x 1981		968		860									
	7'0"	2590 x 2134		1049		891									
9'0" x 6'6"	6'6"	2743 x 1981		1117		1071									
	7'0"	2743 x 2134		1220		1124									
10'0" x 6'6"	6'6"	3048 x 1981		1354		1342									
	7'0"	3048 x 2134		1354		1342									

Prices Marked ¹ – optional Terra brown RAL 8028 available. Surcharge on door, see page 5.

DOUBLE DOORS Internal frame sizes BR		2001 Vertical	2002 Horizontal	2601 Elegance	2602 Finesse	2101 Ilkley	Style Not Available
Imperial	Metric	Retractable	Retractable	Retractable	Retractable	Retractable	
11'0" x 6'6"	6'6"	3353 x 1981	1472 *	1472 *			
	7'0"	3353 x 2134	1483 *	1483 *			
12'0" x 6'6"	6'6"	3658 x 1981	1545 *	1545 *			
	7'0"	3658 x 2134	1557 *	1557 *			
13'0" x 6'6"	6'6"	3962 x 1981	1682 *	1682 *			
	7'0"	3962 x 2134	1694 *	1694 *			
14'0" x 6'6"	6'6"	4267 x 1981	1620	1620		2244 *	
	7'0"	4267 x 2134	1620	1620		2244	

Prices Marked * – Not available ex-stock, delivery 4 – 5 weeks

MATCHING SIDE DOORS Ordering sizes	2001 Vertical	2002 Horizontal	2601 Elegance	2602 Finesse	Style Not Available	Style Not Available
875 x 1875	443	926 ²	865 ²	865 ²		
875 x 2000	443	926 ²	865 ²	865 ²		
875 x 2125	443 ²	926 ²	865 ²	865 ²		
1000 x 2000	470 ²	957 ²	989 ²	989 ²		
1000 x 2125	470	957 ²	989 ²	989 ²		

Prices Marked ² – Not available ex-stock, delivery 4 – 8 weeks





2003 Chevron		2004 Georgian		2304 Georgian with windows		2104 Marquess		2504 Countess		75mm steel framed doors Recommended structural opening sizes allowing tolerance of 10mm on width & 5mm on height For steel frame options see page 5	
CAN.	RET.	CAN.	RET.	CAN.	RET.	CAN.	RET.	CAN.	RET.	Imperial	Metric
		809	850							7'0" x 6'8½"	2135 x 2044
		822	863							7'0" x 7'2¾"	2135 x 2199
		819	860							7'4" x 6'6½"	2235 x 1994
		820	861							7'4" x 6'8½"	2235 x 2044
		879	920							7'4" x 7'2¾"	2235 x 2199
		820	861							7'6" x 6'6½"	2284 x 1994
691	732	820 ¹	861 ¹	1123	1164	820	861	820	861	7'6" x 6'8½"	2284 x 2044
736	777	866 ¹	907 ¹	1170	1211	866	907	866	907	7'6" x 7'2¾"	2284 x 2199
										7'6" x 7'8½"	2284 x 2350
		909	950							7'9¼" x 6'6½"	2365 x 1994
										7'9¼" x 6'8½"	2365 x 2044
										7'9¼" x 7'2¾"	2365 x 2199
		909	950							7'11" x 6'8½"	2411 x 2044
		1047	1088							7'11" x 7'2¾"	2411 x 2199
		909	950							8'0" x 6'6½"	2436 x 1994
		909 ¹	950 ¹	1213	1254	909	950			8'0" x 6'8½"	2436 x 2044
		1047 ¹	1088 ¹	1351	1392	1047	1088			8'0" x 7'2¾"	2436 x 2199
										8'0" x 7'8½"	2436 x 2350
		1089	1130							8'2" x 6'6½"	2489 x 1994
		1075	1116							8'6" x 6'6½"	2589 x 1994
964	1005	1075	1116			1075	1116			8'6" x 6'8½"	2589 x 2044
1004	1045	1119	1160			1119	1160			8'6" x 7'2¾"	2589 x 2199
										8'6" x 7'8½"	2589 x 2350
										8'6" x 8'2¾"	2589 x 2503
										9'0" x 6'8½"	2741 x 2044
										9'0" x 7'2¾"	2741 x 2199
			1409							9'6" x 6'8½"	2894 x 2044
			1434							9'6" x 7'2¾"	2894 x 2199
										10'6" x 6'8½"	3199 x 2044
										10'6" x 7'2¾"	3199 x 2199
2003 Chevron	2004 Georgian	2304 Georgian with windows	2104 Marquess	Style Not Available		Imperial	Metric				
Retractable	Retractable	Retractable	Retractable								
						11'6" x 6'8½"	3504 x 2044				
						11'6" x 7'2¾"	3504 x 2199				
						12'6" x 6'8½"	3809 x 2044				
						12'6" x 7'2¾"	3809 x 2199				
						13'6" x 6'8½"	4114 x 2044				
						13'6" x 7'2¾"	4114 x 2199				
2127 *	1744	2355 *	1744 *			14'6" x 6'8½"	4419 x 2044				
2127 *	1744	2355 *	1744 *			14'6" x 7'2¾"	4419 x 2199				
2003 Chevron	2004 Georgian	2304 Georgian with windows	2104 Marquess	Style Not Available							
1162 ²	865 ²	1106 ²	865 ²								
1162 ²	865 ²	1106 ²	865 ²								
1162 ²	865 ²	1106 ²	865 ²								
1180 ²	989 ²	1130 ²	989 ²								
1180 ²	989 ²	1130 ²	989 ²								

Hörmann Up-and-Over Doors

Canopy & retractable with steel infill

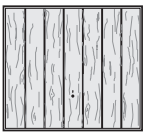
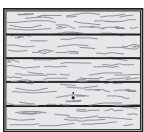

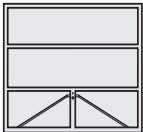
SINGLE DOORS											
Door sizes BR		Vertical Decograin Golden Oak or Rosewood		Horizontal Decograin Golden Oak or Rosewood		Georgian Decograin Golden Oak or Rosewood		Marquess Decograin Golden Oak or Rosewood		2011 Open for infill	
Imperial	Metric	CAN.	RET.	CAN.	RET.	CAN.	RET.	CAN.	RET.	CAN.	RET.
6'6" x 6'6"	1981 x 1981									563	604
6'6" x 7'0"	1981 x 2134									563	604
6'10" x 6'4"	2083 x 1930									563	604
6'6" x 6'6"	2083 x 1981										
6'6" x 7'0"	2083 x 2134										
7'0" x 6'4"	2134 x 1930									563	604
6'6" x 7'0"	2134 x 1981	832	873	741	782	980	1021	980	1021	563	604
7'0" x 7'0"	2134 x 2134	856	897	801	842	1027	1068	1027	1068	598	639
7'6" x 7'6"	2134 x 2286										
7'3" x 6'4"	2210 x 1930									625	666
6'6" x 7'0"	2210 x 1981										
7'0" x 7'0"	2210 x 2134										
7'5" x 6'6"	2261 x 1981	887	928	820	861					625	666
7'0" x 7'0"	2261 x 2134	955	996	912	953					644	685
7'6" x 6'4"	2286 x 1930									625	666
6'6" x 7'0"	2286 x 1981	887	928	820	861	1089	1130	1089	1130	625	666
7'0" x 7'0"	2286 x 2134	955	996	912	953	1257	1298	1257	1298	643	684
7'6" x 7'6"	2286 x 2286										
7'8" x 6'4"	2337 x 1930									654	695
8'0" x 6'4"	2438 x 1930									654	695
6'6" x 8'0"	2438 x 1981	1020	1061	904	945	1278	1319	1278	1319	654	695
7'0" x 8'0"	2438 x 2134	1050	1091	937	978	1323 ³	1364 ³	1323	1364	654	695
7'6" x 8'0"	2438 x 2286										
8'0" x 8'0"	2438 x 2438										
8'6" x 6'6"	2590 x 1981										765
7'0" x 8'6"	2590 x 2134										778
9'0" x 6'6"	2743 x 1981										945
7'0" x 9'0"	2743 x 2134										945
10'0" x 6'6"	3048 x 1981										945
7'0" x 10'0"	3048 x 2134										945
Prices Marked ³ - Only available in Rosewood											
DOUBLE DOORS Internal frame sizes BR		Style Not Available		Style Not Available		Style Not Available		Style Not Available		2011 Open for infill	
Imperial	Metric									Retractable	
11'0" x 6'6"	3353 x 1981										1864
7'0" x 11'0"	3353 x 2134										1948
12'0" x 6'6"	3658 x 1981										1975
7'0" x 12'0"	3658 x 2134										2048
13'0" x 6'6"	3962 x 1981										2072
7'0" x 13'0"	3962 x 2134										2139
14'0" x 6'6"	4267 x 1981										1936
7'0" x 14'0"	4267 x 2134										1936
Prices Marked * - Not available ex-stock, delivery 4-5 weeks											
MATCHING SIDE DOORS Ordering sizes		2001 Golden Oak or Rosewood		2002 Golden Oak or Rosewood		2004 Golden Oak or Rosewood		2104 Golden Oak or Rosewood		2011 Open for infill	
Prices Marked ² - Not available ex-stock, delivery 4-8 weeks											
875 x 1875		961 ²		961 ²		961 ²		961 ²		443	
875 x 2000		967 ²		967 ²		967 ²		967 ²		443	
875 x 2125		974 ²		974 ²		974 ²		974 ²		443	
1000 x 2000		1105 ²		1105 ²		1105 ²		1105 ²		470	
1000 x 2125		1113 ²		1113 ²		1113 ²		1113 ²		470	



The door leaf and optional box section steel frame are made of galvanised material that is polyester powder coated on both sides.

This finish is extremely durable and the standard colour is Traffic white RAL 9016.

Other colours are available listed in optional extras below.

To help maintain the aesthetic appearance of your door and prevent the build up of dirt, salt and other corrosive substances the door should be washed with a mild soap-based solution on a regular basis.

If the door is located near the coast it is important that the door panel and frame should be washed at least every 2 months.

We also suggest that all other components are brushed down on a regular basis to prevent the build up of dirt and dust etc.

The window frames on the Georgian and Ilkley doors are UPVC and white as standard.

These frames are a 2-part construction with the window material sandwiched between and frames screwed together from the back for security.

The finish of the Decograin doors is a synthetic foil-coated timber design outside (inside primer white).

The leaf frame and fixing frame is a matching powder coating.





For further choice of exciting door designs in steel, traditional or contemporary, with a vast range of sizes and increased range of colours, ask your garage door specialist about the N 80 Up-and-Over garage doors available to special order.

Optional extras for Steel Doors	Price
75mm Steel fixing frame for either canopy or retractable geared single doors. Factory fitted	121
75mm Steel fixing frame for either canopy or retractable geared single doors. Factory fitted with frame to compliment Decograin	121
75mm Steel fixing frame for DOUBLE retractable geared doors, when ordered with the door	191
60mm Steel fixing frame for canopy geared doors only. Factory fitted	125
60mm Steel fixing frame for canopy geared doors only. Factory fitted with frame to compliment Decograin	125
Please note: Factory fitted 8' high frame not available	
Prices marked ¹ – optional Terra Brown RAL 8028 available. Surcharge on door	34
Retractable plus gear for retractable doors up to 7'6" wide giving extra drive through width	
Surcharge on retractable price	63
4 point locking kit for extra security, factory fit with door order or retrofit – single door sizes only	57
3 point locking kit for extra security, factory fit with door (this cannot be retrofitted). Available for 2001 side doors only	98
Window options for 2304 Georgian style door – Plain, crossed or diamond style with crystal glazing	Incl.
Colours are available to special order in the following styles:	
2001 Vertical, 2002 Horizontal, 2101 Ilkley available in all the listed sizes	
2004 Georgian, 2304 Georgian with windows and 2104 Marquess are available in	
7066, 7070, 7566, 7570, 7666, 7670 and 8066, 8070 sizes only	
Please note: Caxton, Chevron, Elegance, Finesse and Countess steel up-and-over doors are only available in white	
Colours:	
Terra Brown RAL 8028, Signal Blue RAL 5005, Steel Blue RAL 5011, Moss Green RAL 6005, Ruby Red RAL 3003, Jet Black RAL 9005	
Includes matching frame if ordered with door. White frame RAL 9016 also available, please specify when ordering	
Please allow 5-6 weeks lead time for coloured doors	
	115
Single doors	
	184
Double doors	
Please consult your Hörmann dealer for steel garage door styles that are available from stock in colours: Anthracite grey RAL 7016, Jet black RAL 9005, Moss green RAL 6005 and Steel blue RAL 5011	
Coloured window frames for Georgian and Ilkley doors:	
Coloured window frames to match door colour	
Georgian doors (price per window, see note below for the number of windows)	35
Ilkley doors (price per single door)	161
Ilkley doors (price per double door)	321
Please state coloured windows required on order	
Orders received without reference will be supplied with white as standard	
Georgian doors up to 10' wide = 4 windows, 11' to 13' = 6 windows, 14' = 8 windows	
Optional handle sets	
Cast Aluminium silver colour and brass colour	144
Cast Aluminium white and brown	170
Brushed or polished stainless steel	205
Matching lever handles are also available for side doors	P.O.A.

Hörmann Up-and-Over Doors

Canopy & retractable with timber infill

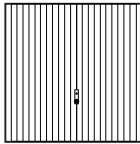

SINGLE DOORS											
Door sizes BR		2005 Measham		2007 Jacobean		2008 Tudor		2014 Rutland		2009 Vertical or Horizontal	
Imperial	Metric	CAN.	RET.	CAN.	RET.	CAN.	RET.	CAN.	RET.	CAN.	RET.
6'6" x 6'6"	1981 x 1981	1195	1236	1440	1481	1440	1481	1440	1481	1643	1684
7'0"	1981 x 2134	1195	1236	1440	1481	1440	1481	1440	1481	1643	1684
6'10" x 6'4"	2083 x 1930	1195	1236	1440	1481	1440	1481	1440	1481	1643	1684
6'6"	2083 x 1981										
7'0"	2083 x 2134										
7'0" x 6'4"	2134 x 1930	1195	1236	1440	1481	1440	1481	1440	1481	1643	1684
6'6"	2134 x 1981	1195	1236	1440	1481	1440	1481	1440	1481	1643	1684
7'0"	2134 x 2134	1195	1236	1440	1481	1440	1481	1440	1481	1643	1684
7'6"	2134 x 2286										
7'3" x 6'4"	2210 x 1930	1242	1283	1508	1549	1508	1549	1508	1549	1703	1744
6'6"	2210 x 1981										
7'0"	2210 x 2134										
7'5" x 6'6"	2261 x 1981	1242	1283	1508	1549	1508	1549	1508	1549	1703	1744
7'0"	2261 x 2134	1335	1376	1555	1596	1555	1596	1555	1596	1742	1783
7'6" x 6'4"	2286 x 1930	1242	1283	1508	1549	1508	1549	1508	1549	1703	1744
6'6"	2286 x 1981	1242	1283	1508	1549	1508	1549	1508	1549	1703	1744
7'0"	2286 x 2134	1271	1312	1555	1596	1555	1596	1555	1596	1742	1783
7'6"	2286 x 2286										
8'0"	2286 x 2438										
7'8" x 6'4"	2337 x 1930	1289	1330	1574	1615	1574	1615	1574	1615	1703	1744
8'0" x 6'4"	2438 x 1930	1311	1352	1592	1633	1592	1633	1592	1633	1801	1842
6'6"	2438 x 1981	1311	1352	1592	1633	1592	1633	1592	1633	1801	1842
7'0"	2438 x 2134	1338	1379	1631	1672	1631	1672	1631	1672	1853	1894
8'0"	2438 x 2438										
8'6" x 6'6"	2590 x 1981										
7'0"	2590 x 2134										
9'0" x 6'6"	2743 x 1981		1584		1836		1836		1836		1960
7'0"	2743 x 2134		1584		1836		1836		1836		1960
10'0" x 6'6"	3048 x 1981		1589		1961		1961		1961		2049
7'0"	3048 x 2134		1589		1961		1961		1961		2049
DOUBLE DOORS Internal frame sizes BR		2005 Measham		2007 Jacobean		2008 Tudor		2014 Rutland		2009 Vertical or Horizontal	
Imperial	Metric	CAN.	RET.	CAN.	RET.	CAN.	RET.	CAN.	RET.	CAN.	RET.
11'0" x 6'6"	3353 x 1981		2803		3092		3092		3092		3302
7'0"	3353 x 2134		2803		3092		3092		3092		3302
12'0" x 6'6"	3658 x 1981		2909		3107		3107		3107		3651
7'0"	3658 x 2134		2909		3107		3107		3107		3651
13'0" x 6'6"	3962 x 1981		2920		3351		3351		3351		4081
7'0"	3962 x 2134		2920		3351		3351		3351		4081
14'0" x 6'6"	4267 x 1981		2925		3298		3298		3298		3419
7'0"	4267 x 2134		2925		3298		3298		3298		3419
Please note: Lead times on all timber garage doors will be 5 to 6 weeks											
MATCHING SIDE DOORS Ordering sizes		2005 Measham		2007 Jacobean		2008 Tudor		2014 Rutland		2009 Vertical or Horizontal	
Please note: Lead times on all timber side garage doors will be 5 to 6 weeks											
875 x 1875		804		930		930		930		941	
875 x 2000		804		930		930		930		941	
875 x 2125		804		930		930		930		941	
1000 x 2000		845		969		969		969		983	
1000 x 2125		845		969		969		969		983	





2109 Mallory Horizontal or Vertical		2013 Caxton		2020 Gatcombe		2114 Shepshed		2019 Garage Light		75mm steel framed doors Recommended structural opening sizes allowing tolerance of 10mm on width & 5mm on height For steel frame options see page 9	
CAN.	RET.	CAN.	RET.	CAN.	RET.	CAN.	RET.	CAN.	RET.	Imperial	Metric
1640	1681	1902	1943	1902	1943	1902	1943	1965	2006	7'0" x 6'8½"	2135 x 2044
1640	1681	1902	1943	1902	1943	1902	1943	1965	2006	7'0" x 7'2¾"	2135 x 2199
1640	1681	1902	1943	1902	1943	1902	1943	1965	2006	7'4" x 6'6½"	2235 x 1994
										7'4" x 6'8½"	2235 x 2044
										7'4" x 7'2¾"	2235 x 2199
1640	1681	1902	1943	1902	1943	1902	1943	1965	2006	7'6" x 6'6½"	2284 x 1994
1640	1681	1902	1943	1902	1943	1902	1943	1965	2006	7'6" x 6'8½"	2284 x 2044
1640	1681	1902	1943	1902	1943	1902	1943	1965	2006	7'6" x 7'2¾"	2284 x 2199
										7'6" x 7'8½"	2284 x 2350
1703	1744	1963	2004	1963	2004	1963	2004	2051	2092	7'9¼" x 6'6½"	2365 x 1994
										7'9¼" x 6'8½"	2365 x 2044
										7'9¼" x 7'2¾"	2365 x 2199
1703	1744	1963	2004	1963	2004	1963	2004	2051	2092	7'11" x 6'8½"	2411 x 2044
1766	1807	1994	2035	1994	2035	1994	2035	2103	2144	7'11" x 7'2¾"	2411 x 2199
1703	1744	1963	2004	1963	2004	1963	2004	2051	2092	8'0" x 6'6½"	2436 x 1994
1703	1744	1963	2004	1963	2004	1963	2004	2051	2092	8'0" x 6'8½"	2436 x 2044
1766	1807	1994	2035	1994	2035	1994	2035	2147	2188	8'0" x 7'2¾"	2436 x 2199
										8'0" x 7'8½"	2436 x 2350
										8'0" x 8'2¾"	2436 x 2503
1872	1913	2151	2192	2151	2192	2151	2192	2300	2341	8'2" x 6'6½"	2489 x 1994
1872	1913	2151	2192	2151	2192	2151	2192	2300	2341	8'6" x 6'6½"	2589 x 1994
1872	1913	2151	2192	2151	2192	2151	2192	2300	2341	8'6" x 6'8½"	2589 x 2044
1872	1913	2151	2192	2151	2192	2151	2192	2300	2341	8'6" x 7'2¾"	2589 x 2199
										8'6" x 8'2¾"	2589 x 2503
										9'0" x 6'8½"	2741 x 2044
										9'0" x 7'2¾"	2741 x 2199
	2153		2457		2457		2457		2524	9'6" x 6'8½"	2894 x 2044
	2153		2457		2457		2457		2524	9'6" x 7'2¾"	2894 x 2199
	2348		2615		2615		2615		2806	10'6" x 6'8½"	3199 x 2044
	2348		2615		2615		2615		2806	10'6" x 7'2¾"	3199 x 2199
2109 Mallory		2013 Caxton		2020 Gatcombe		2114 Shepshed		2019 Garage Light		Imperial	Metric
CAN.	RET.	CAN.	RET.	CAN.	RET.	CAN.	RET.	CAN.	RET.		
	3474		3668		3668		3668		4083	11'6" x 6'8½"	3504 x 2044
	3474		3668		3668		3668		4083	11'6" x 7'2¾"	3504 x 2199
	3768		3988		3988		3988		4491	12'6" x 6'8½"	3809 x 2044
	3768		3988		3988		3988		4491	12'6" x 7'2¾"	3809 x 2199
	4088		4358		4358		4358		5057	13'6" x 6'8½"	4114 x 2044
	4088		4358		4358		4358		5057	13'6" x 7'2¾"	4114 x 2199
	3971		4239		4239		4239		4792	14'6" x 6'8½"	4419 x 2044
	3971		4239		4239		4239		4792	14'6" x 7'2¾"	4419 x 2199
2109 Mallory		2013 Caxton		2020 Gatcombe		2114 Shepshed		2019 Garage Light			
CAN.	RET.	CAN.	RET.	CAN.	RET.	CAN.	RET.	CAN.	RET.		
1060		1098		1121		1091		1250			
1060		1098		1121		1091		1250			
1060		1098		1121		1091		1250			
1104		1140		1164		1133		1289			
1104		1140		1164		1133		1289			

Hörmann Up-and-Over Doors

Canopy & retractable with timber infill

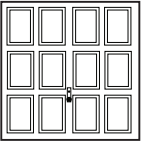
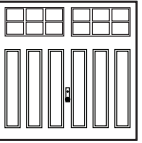

SINGLE DOORS										75mm steel framed doors Recommended structural opening sizes allowing tolerance of 10mm on width & 5mm on height For steel frame options see page 9	
Door sizes BR		2119 Leicester		2010 Chevron		2121 Chesterfield		2122 Middleton		Imperial	Metric
Imperial	Metric	CAN.	RET.	CAN.	RET.	CAN.	RET.	CAN.	RET.	Imperial	Metric
6'6" x 6'6"	6'6"		2266	2030	2071		2589		2567	7'0" x 6'8½"	2135 x 2044
	7'0"	1981 x 2134	2266	2030	2071		2589		2567	7'0" x 7'2¾"	2135 x 2199
6'10" x 6'4"	6'4"	2083 x 1930	2266	2030	2071		2589		2567	7'4" x 6'6½"	2235 x 1994
	6'6"	2083 x 1981								7'4" x 6'8½"	2235 x 2044
7'0" x 6'4"	6'4"	2134 x 1930		2282	2030	2071	2589		2567	7'6" x 6'6½"	2284 x 1994
	6'6"	2134 x 1981		2282	2030	2071	2589		2567	7'6" x 6'8½"	2284 x 2044
7'0" x 7'0"	7'0"	2134 x 2134		2282	2030	2071	2606		2597	7'6" x 7'2¾"	2284 x 2199
	7'6"	2134 x 2286								7'6" x 7'8½"	2284 x 2350
7'3" x 6'4"	6'4"	2210 x 1930		2489	2121	2162	2779		2770	7'9¼" x 6'6½"	2365 x 1994
	6'6"	2210 x 1981								7'9¼" x 6'8½"	2365 x 2044
7'3" x 7'0"	7'0"	2210 x 2134								7'9¼" x 7'2¾"	2365 x 2199
	6'6"	2261 x 1981		2500	2121	2162	2784		2770	7'11" x 6'8½"	2411 x 2044
7'5" x 7'0"	7'0"	2261 x 2134		2597	2179	2220	2796		2784	7'11" x 7'2¾"	2411 x 2199
	6'4"	2286 x 1930		2498	2121	2162	2784		2770	8'0" x 6'6½"	2436 x 1994
7'6" x 6'6"	6'6"	2286 x 1981		2498	2121	2162	2784		2770	8'0" x 6'8½"	2436 x 2044
	7'0"	2286 x 2134		2597	2179	2220	2811		2796	8'0" x 7'2¾"	2436 x 2199
7'6" x 7'6"	7'6"	2286 x 2286								8'0" x 7'8½"	2436 x 2350
	8'0"	2286 x 2438								8'2" x 6'6½"	2436 x 2503
7'8" x 6'4"	6'4"	2337 x 1930		2664	2316	2357				8'6" x 6'6½"	2489 x 1994
	6'6"	2438 x 1930		2674	2316	2357				8'6" x 6'8½"	2589 x 1994
8'0" x 6'4"	6'4"	2438 x 1930		2674	2316	2357				8'6" x 7'2¾"	2589 x 2044
	6'6"	2438 x 1981		2674	2316	2357				8'6" x 7'8½"	2589 x 2199
8'0" x 7'0"	7'0"	2438 x 2134		2733	2353	2394				8'6" x 8'2¾"	2589 x 2503
	8'0"	2438 x 2438								9'0" x 6'8½"	2741 x 2044
8'6" x 6'6"	6'6"	2590 x 1981								9'0" x 7'2¾"	2741 x 2199
	7'0"	2590 x 2134								9'6" x 6'8½"	2894 x 2044
9'0" x 6'6"	6'6"	2743 x 1981		2802		2548				9'6" x 7'2¾"	2894 x 2199
	7'0"	2743 x 2134		2802		2548				10'6" x 6'8½"	3199 x 2044
10'0" x 6'6"	6'6"	3048 x 1981		3156		2967				10'6" x 7'2¾"	3199 x 2199
	7'0"	3048 x 2134		3156		2967					

DOUBLE DOORS Internal Frame Sizes BR		2119 Leicester		2010 Chevron		Style Not Available		Style Not Available		Imperial	Metric
BR	RET.	CAN.	RET.	CAN.	RET.	CAN.	RET.	CAN.	RET.	Imperial	Metric
11'0" x 6'6"	6'6"	3353 x 1981		4399		4209				11'6" x 6'8½"	3504 x 2044
	7'0"	3353 x 2134		4399		4209				11'6" x 7'2¾"	3504 x 2199
12'0" x 6'6"	6'6"	3658 x 1981		4703		4287				12'6" x 6'8½"	3809 x 2044
	7'0"	3658 x 2134		4703		4287				12'6" x 7'2¾"	3809 x 2199
13'0" x 6'6"	6'6"	3962 x 1981		5147		4358				13'6" x 6'8½"	4114 x 2044
	7'0"	3962 x 2134		5147		4358				13'6" x 7'2¾"	4114 x 2199
14'0" x 6'6"	6'6"	4267 x 1981		5021		4239				14'6" x 6'8½"	4419 x 2044
	7'0"	4267 x 2134		5021		4239				14'6" x 7'2¾"	4419 x 2199

Please note: Lead times on all timber garage doors will be 5 to 6 weeks

MATCHING SIDE DOORS Ordering Sizes	2119 Leicester	2010 Chevron	2121 Chesterfield	2122 Middleton
875 x 1875	957	930	930	957
875 x 2000	957	930	930	957
875 x 2125	957	930	930	957
1000 x 2000	983	969	969	983
1000 x 2125	983	969	969	983

Please note: Lead times on all timber side garage doors will be 5 to 6 weeks



Our timber garage doors are constructed as an infill to fit into the Open-for-Infill Up-and-Over door frame, this gives the doors their rigid and durable construction.

The styles Measham, Jacobean, Tudor and Rutland are cedar facings glued and fixed to exterior quality plywood.

The solid cedar doors are 12mm tongue and groove boards constructed as an infill.

Cedar is organically grown with natural colour and grain variations; this is a feature of cedar.

We make every effort to harmonise the effect where possible, by hand matching the component parts used in construction.

Please note a uniform overall grain pattern cannot be guaranteed.

Protection (Basecoat)

All our timber doors are supplied with a dip immersion coat of Remmers Induline GW306 base stain primer 006 Light Oak; this coating is for temporary protection only.

If purchased in this temporary finish, please ensure that a full specification of finishing coats are applied immediately before or after installation to all exposed surfaces - inside as well as outside - with a Remmers or similar finishing coat system.

A fully finished option is available, please see options below.

For further choice of exciting door designs, traditional or contemporary in Nordic Pine and Hemlock, with a vast range of sizes, ask your garage door specialist about the N80 Up-and-Over garage doors available to special order.

Optional extras for timber doors	Price
75mm Steel fixing frame for either canopy or retractable geared single doors, factory fitted Terra brown RAL 8028 as standard	121
75mm Steel fixing frame for DOUBLE retractable geared doors Terra brown RAL 8028 as standard when ordered with the door	191
60mm Steel fixing frame for canopy geared doors only, factory fitted Terra brown RAL 8028 as standard	125
Please note: Factory fitted 8' high frame not available	
Retractable plus gear for retractable doors up to 7'6" wide giving extra drive through width Surcharge on retractable price	63
4 point locking kit for extra security, factory fit with door order or retrofit	57
Window options for 2019 Garage Light door - Crystal or clear glazing and can be plain or with square or diamond simulated leading	Incl.

Fully finished option

This is available as a factory process giving a 5 year erosion protection

The product used is Remmers and is available in the following stain colours:

Mahogany, Walnut, Dark Oak, Medium Oak, Light Oak, Teak, Rosewood and Golden Oak

For south facing situations exposed to strong sunlight, the dark colours are NOT recommended as they can store excessive heat and dry out

	Stain finish	Traffic white RAL 9016/Ebony	RAL to choose
Door sizes up to 8'0" x 7'0"	123	211	281
Door sizes up to 14'0" x 7'0"	281	380	697
Side Doors	91	191	238





Optional handle sets



Cast Aluminium silver colour and brass colour	144
Cast Aluminium white and brown	170
Brushed or polished stainless steel	205
Matching lever handles are also available for side doors	P.O.A.

Hörmann Up-and-Over Doors

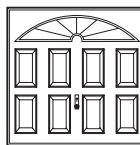
Canopy & retractable with GRP infill



SINGLE DOORS									
Door sizes BR		2042 Windermere		2041 Coniston		2044 Stamford		2034 Penshurst	
Imperial	Metric	CAN.	RET.	CAN.	RET.	CAN.	RET.	CAN.	RET.
7'0" x 6'6"	2134 x 1981	1964	2005	1922	1963	2017	2058	2081	2122
	2134 x 2134	1964	2005	1922	1963	2017	2058	2081	2122
7'6" x 6'6"	2286 x 1981	2081	2122	2029	2070	2123	2164	2262	2303
	2286 x 2134	2081	2122	2029	2070	2123	2164	2262	2303
8'0" x 6'6"	2438 x 1981	2238	2279	2214	2255	2297	2338	2408	2449
	2438 x 2134	2238	2279	2214	2255	2297	2338	2408	2449
9'0" x 6'6"	2743 x 1981		2510*		2453*		2534*		2582
	2743 x 2134		2510*		2453*		2534*		2582

SINGLE DOORS & DOUBLE DOORS									
Door sizes BR		2047 Bourton		2048 Burford		2049 Moreton			
Imperial	Metric			CAN.	RET.	CAN.	RET.		
7'0" x 6'6"	2134 x 1981	2081	2122	2081	2122	2300	2341		
	2134 x 2134	2081	2122	2081	2122	2300	2341		
7'6" x 6'6"	2286 x 1981	2262	2303	2262	2303	2483	2524		
	2286 x 2134	2262	2303	2262	2303	2483	2524		
8'0" x 6'6"	2438 x 1981	2408	2449	2408	2449	2627	2668		
	2438 x 2134	2408	2449	2408	2449	2627	2668		
14'0" x 6'6"	4267 x 1981		3800		3800		4141		
	4267 x 2134		3800		3800		4141		

Coniston and Stamford are supplied in white RAL 9016 OFI, all other styles are supplied in Terra brown RAL 8028 OFI.

75mm steel framed doors

Door sizes BR		Recommended structural opening sizes allowing tolerance of 10mm on width & 5mm on height	
Imperial	Metric	Imperial	Metric
7'0" x 6'6"	2134 x 1981	7'6" x 6'8½"	2284 x 2044
7'0" x 7'0"	2134 x 2134	7'6" x 7'2¾"	2284 x 2199
7'6" x 6'6"	2286 x 1981	8'0" x 6'8½"	2436 x 2044
7'6" x 7'0"	2286 x 2134	8'0" x 7'2¾"	2436 x 2199
8'0" x 6'6"	2438 x 1981	8'6" x 6'8½"	2589 x 2044
8'0" x 7'0"	2438 x 2134	8'6" x 7'2¾"	2589 x 2199
9'0" x 6'6"	2743 x 1981	9'6" x 6'8½"	2894 x 2044
9'0" x 7'0"	2743 x 2134	9'6" x 7'2¾"	2894 x 2199

For GRP colour options please consult main brochure

Window Options

Clear or translucent

Price

Per door 193

Clear or translucent with decorative leading

Per door 323

Windows are available in the Windermere and Coniston (clear or translucent) Stamford comes with black windows as standard
* Doors only available without handle (automation required)



**New product
at exhibition**

Aluminium frame sectional door ART 42 / ART 42 Thermo **Exact division for more light and ventilation in the garage**

- Harmonious overall appearance thanks to uniform division of window sections
- 42-mm-thick aluminium frame as standard profile and thermal break profile for better thermal insulation
- 9 infill variations for more light in the garage or for ventilation of parking spaces in collective garages

HÖRMANN



For more information on this door please consult your local Hörmann dealer

Hörmann Sectional Doors

LTE 42 – single-skinned doors with steel sections

Single doors with Z track tension springs giving low headroom as standard

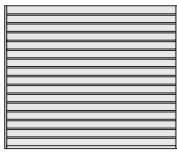

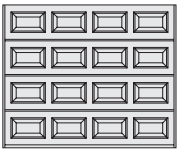
SINGLE DOORS								No. of panels
Door sizes BR		S-ribbed Woodgrain		M-ribbed Woodgrain		S-panelled Woodgrain		
Imperial	Metric	Outside White	Outside Colour	Outside White	Outside Colour	Outside White	Outside Colour	
6'10" x 6'2"	2080 x 1875	808	961	808	961	906	1059	4
	2080 x 2080	847	1016	847	1016	941	1110	4
7'0" x 6'6"	2134 x 2000	825	992	825	992	923	1090	4
	2134 x 2125	847	1024	847	1024	941	1118	4
7'6" x 6'6"	2286 x 2000	825	1004	825	1004	923	1102	4
	2286 x 2125	847	1037	847	1037	941	1131	4
	2286 x 2250	891	1092	891	1092	979	1180	4
	2286 x 2375	1032	1244	1032	1244	1130	1342	4
8'0" x 6'6"	2438 x 2000	860	1051	860	1051	958	1149	4
	2438 x 2125	889	1092	889	1092	974	1177	4
	2438 x 2250	934	1148	934	1148	1016	1230	4
	2438 x 2375	1073	1299	1073	1299	1163	1389	4
8'6" x 6'6"	2591 x 2000	860	1063	860	1063	958	1161	4
	2591 x 2125	889	1104	889	1104	974	1189	4
	2740 x 2000	968	1182	968	1182	1110	1324	4
	2740 x 2125	997	1225	997	1225	1131	1359	4
9'6" x 6'6"	2896 x 2000	1000	1226	1000	1226	1166	1392	5
	2896 x 2125	1037	1278	1037	1278	1183	1424	5
10'0" x 6'6"	3048 x 2000	1000	1238	1000	1238	1166	1404	5
	3048 x 2125	1037	1290	1037	1290	1183	1436	5

For information on outside colour, see page 15

Double doors with N track springs (see shaded area of grid). For low headroom see bottom of page 15

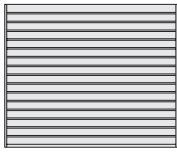
DOUBLE DOORS			
Door sizes BR		S-ribbed Woodgrain	
Imperial	Metric	Outside White	Outside Colour
11'0" x 6'6"	3353 x 2000	1395	1657
	3353 x 2125	1445	1723
12'0" x 6'6"	3658 x 2000	1545	1831
	3658 x 2125	1607	1911
13'0" x 6'6"	3962 x 2000	1577	1887
	3962 x 2125	1639	1968
14'0" x 6'6"	4267 x 2000	1710	2043
	4267 x 2125	1801	2155
14'6" x 6'6"	4420 x 2000	1746	2091
	4420 x 2125	1840	2207
15'0" x 6'6"	4572 x 2000	1758	2115
	4572 x 2125	1847	2226
15'6" x 6'6"	4725 x 2000	1809	2178
	4725 x 2125	1900	2292
16'0" x 6'6"	4877 x 2000	1808	2189
	4877 x 2125	1900	2305



For door width and glazing configuration - please refer to the 01-19 A

Hörmann Sectional Doors

LPU 42 – double-skinned doors with steel sections – 42mm

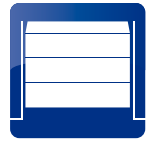

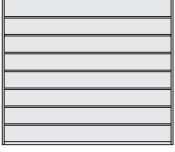

Single doors with Z track tension springs giving low headroom as standard



SINGLE DOORS									
Door sizes BR		S-ribbed Woodgrain/ M-ribbed Woodgrain		M-ribbed Sandgrain		M-ribbed Silkgrain		M-ribbed Decograin	
Imperial	Metric	Outside White	Outside Colour	Outside White	Anthracite grey Terra brown White aluminium	Outside White	Outside Colour	Rosewood, Golden Oak, Dark Oak, Winchester Oak, Night Oak	
6'10" x 6'2"	2080 x 1875	941	1094	1000	1153	1147	1300	1260	
6'6"	2080 x 2000	983	1146	1048	1211	1204	1367	1322	
6'10"	2080 x 2080	1018	1187	1088	1257	1249	1418	1373	
7'0" x 6'6"	2134 x 2000	1017	1184	1048	1215	1204	1371	1322	
7'0"	2134 x 2125	1052	1229	1088	1265	1249	1426	1373	
7'6" x 6'6"	2286 x 2000	1017	1196	1048	1227	1204	1383	1322	
7'0"	2286 x 2125	1052	1242	1088	1278	1249	1439	1373	
7'4"	2286 x 2250	1066	1267	1138	1339	1308	1509	1438	
7'9"	2286 x 2375	1150	1362	1188	1400	1366	1578	1502	
8'2"	2286 x 2500	1147	1370	1234	1457	1419	1642	1561	
8'0" x 6'6"	2438 x 2000	1068	1259	1106	1297	1273	1464	1400	
7'0"	2438 x 2125	1110	1313	1152	1355	1327	1530	1460	
7'4"	2438 x 2250	1117	1331	1189	1403	1366	1580	1503	
7'9"	2438 x 2375	1203	1429	1242	1468	1431	1657	1575	
8'2"	2438 x 2500	1200	1438	1296	1534	1495	1733	1647	
8'6" x 6'6"	2591 x 2000	1068	1271	1106	1309	1273	1476	1400	
7'0"	2591 x 2125	1110	1325	1152	1367	1327	1542	1460	
9'0" x 6'6"	2740 x 2000	1155	1369	1204	1418	1394	1608	1537	
7'0"	2740 x 2125	1195	1423	1251	1479	1448	1676	1597	
9'6" x 6'6"	2896 x 2000	1207	1433	1264	1490	1467	1693	1620	
7'0"	2896 x 2125	1255	1496	1315	1556	1524	1765	1683	
10'0" x 6'6"	3048 x 2000	1166	1404	1264	1502	1467	1705	1620	
7'0"	3048 x 2125	1207	1460	1315	1568	1524	1777	1683	

For information on outside colour, see page 15

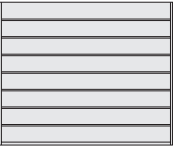
Double doors with N track springs (see shaded area of grid). For low headroom see bottom of page 15

SINGLE DOORS									
Door sizes BR		S-ribbed Woodgrain/ M-ribbed Woodgrain		M-ribbed Sandgrain		M-ribbed Silkgrain		M-ribbed Decograin	
Imperial	Metric	Outside White	Outside Colour	Outside White	Anthracite grey Terra brown White aluminium	Outside White	Outside Colour	Rosewood, Golden Oak, Dark Oak, Winchester Oak, Night Oak	
11'0" x 6'6"	3353 x 2000	1372	1634	1498	1760	1749	2011	1940	
7'0"	3353 x 2125	1426	1704	1557	1835	1818	2096	2016	
12'0" x 6'6"	3658 x 2000	1610	1896	1683	1969	1971	2257	2192	
7'0"	3658 x 2125	1670	1974	1749	2053	2048	2352	2277	
13'0" x 6'6"	3962 x 2000	1668	1978	1732	2042	2031	2341	2259	
7'0"	3962 x 2125	1731	2060	1795	2124	2107	2436	2344	
14'0" x 6'6"	4267 x 2000	1729	2062	1781	2114	2091	2424	2327	
7'0"	4267 x 2125	1798	2152	1851	2205	2174	2528	2420	
14'6" x 6'6"	4420 x 2000	1787	2132	1824	2169	2143	2488	2387	
7'0"	4420 x 2125	1857	2224	1899	2266	2230	2597	2483	
15'0" x 6'6"	4572 x 2000	1818	2175	1838	2195	2160	2517	2405	
7'0"	4572 x 2125	1889	2268	1915	2294	2250	2629	2507	
15'6" x 6'6"	4725 x 2000	1897	2266	1871	2240	2202	2571	2453	
7'0"	4725 x 2125	1970	2362	1945	2337	2287	2679	2548	
16'0" x 6'6"	4877 x 2000	1897	2278	1905	2286	2239	2620	2495	
7'0"	4877 x 2125	1970	2375	1979	2384	2329	2734	2595	



Intermediate sizes are available, please see your dealer for more details

Hörmann Sectional Doors

LPU 42 – double-skinned doors with steel sections – 42mm

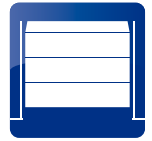

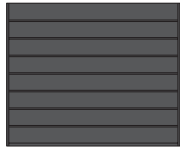
Single doors with Z track tension springs giving low headroom as standard

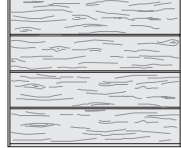

SINGLE DOORS						Door sizes BR		Titan Metallic CH 703		L-ribbed Sandgrain		L-ribbed Silkgrain		L-ribbed Decograin			
Imperial						Metric		Outside White		Anthracite grey Terra brown White aluminium		Outside White		Outside Colour		Rosewood, Golden Oak, Dark Oak, Winchester Oak, Night Oak	
Imperial	Metric					Imperial	Metric	Imperial	Metric	Imperial	Metric	Imperial	Metric	Imperial	Metric	Imperial	Metric
6'10" x 6'2"	2080 x 1875	1260	1184	1337	1311	1464	1437										
6'6"	2080 x 2000	1322	1216	1379	1346	1509	1475										
6'10"	2080 x 2080	1373	1233	1402	1362	1531	1492										
7'0" x 6'6"	2134 x 2000	1322	1216	1383	1346	1513	1475										
7'0"	2134 x 2125	1373	1233	1410	1362	1539	1492										
7'6" x 6'6"	2286 x 2000	1322	1216	1395	1346	1525	1475										
7'0"	2286 x 2125	1373	1233	1423	1362	1552	1492										
7'4"	2286 x 2250	1438	1284	1485	1422	1623	1558										
7'9"	2286 x 2375	1502	1292	1504	1430	1642	1565										
8'2"	2286 x 2500	1561	1327	1550	1465	1688	1604										
8'0" x 6'6"	2438 x 2000	1400	1283	1474	1420	1611	1558										
7'0"	2438 x 2125	1460	1306	1509	1448	1651	1588										
7'4"	2438 x 2250	1503	1370	1584	1519	1733	1667										
7'9"	2438 x 2375	1575	1407	1633	1559	1785	1711										
8'2"	2438 x 2500	1647	1447	1685	1602	1840	1758										
8'6" x 6'6"	2591 x 2000	1400	1283	1486	1420	1623	1558										
7'0"	2591 x 2125	1460	1306	1521	1448	1663	1588										
9'0" x 6'6"	2740 x 2000	1537	1406	1620	1561	1775	1717										
7'0"	2740 x 2125	1597	1425	1653	1583	1811	1740										
9'6" x 6'6"	2896 x 2000	1620	1479	1705	1647	1873	1813										
7'0"	2896 x 2125	1683	1502	1743	1671	1912	1840										
10'0" x 6'6"	3048 x 2000	1620	1479	1717	1647	1885	1813										
7'0"	3048 x 2125	1683	1502	1755	1671	1924	1840										

For information on outside colour, see page 15

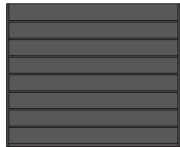
Double doors with N track springs (see shaded area of grid). For low headroom see bottom of page 15

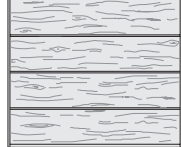
DOUBLE DOORS						Door sizes BR		Titan Metallic CH 703		L-ribbed Sandgrain		L-ribbed Silkgrain		L-ribbed Decograin			
Imperial						Metric		Outside White		Anthracite grey Terra brown White aluminium		Outside White		Outside Colour		Rosewood, Golden Oak, Dark Oak, Winchester Oak, Night Oak	
Imperial	Metric					Imperial	Metric	Imperial	Metric	Imperial	Metric	Imperial	Metric	Imperial	Metric	Imperial	Metric
11'0" x 6'6"	3353 x 2000	1940	1749	2011	1954	2216	2158										
7'0"	3353 x 2125	2016	1776	2054	1983	2261	2191										
12'0" x 6'6"	3658 x 2000	2192	1970	2256	2208	2494	2444										
7'0"	3658 x 2125	2277	2005	2309	2247	2551	2488										
13'0" x 6'6"	3962 x 2000	2259	2030	2340	2278	2588	2523										
7'0"	3962 x 2125	2344	2060	2389	2309	2638	2557										
14'0" x 6'6"	4267 x 2000	2327	2090	2423	2347	2680	2600										
7'0"	4267 x 2125	2420	2125	2479	2384	2738	2641										
14'6" x 6'6"	4420 x 2000	2387	2148	2493	2412	2757	2673										
7'0"	4420 x 2125	2483	2182	2549	2448	2815	2713										
15'0" x 6'6"	4572 x 2000	2405	2170	2527	2436	2793	2701										
7'0"	4572 x 2125	2507	2205	2584	2476	2855	2744										
15'6" x 6'6"	4725 x 2000	2453	2208	2577	2482	2851	2752										
7'0"	4725 x 2125	2548	2247	2639	2524	2916	2799										
16'0" x 6'6"	4877 x 2000	2495	2249	2630	2525	2906	2801										
7'0"	4877 x 2125	2595	2287	2692	2570	2975	2851										

Intermediate sizes are available, please see your dealer for more details

Hörmann Sectional Doors

LPU 42 – double-skinned doors with steel sections – 42mm

Single doors with Z track tension springs giving low headroom as standard

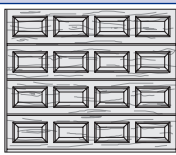
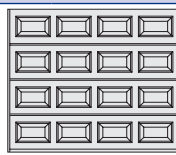

SINGLE DOORS		 L-ribbed Titan Metallic CH 703	 S-panelled Decograin	 S-panelled Woodgrain					
Door sizes BR					Rosewood, Golden Oak, Dark Oak, Winchester Oak, Night Oak	No. of panels	Outside White	Outside Colour	No. of panels
Imperial	Metric								
6'10" x 6'2"	2080 x 1875	1437	1541	4	1180	1333	4		
6'6"	2080 x 2000	1475	1574	4	1237	1400	4		
6'10"	2080 x 2080	1492			1251	1420	4		
7'0" x 6'6"	2134 x 2000	1475	1574	4	1279	1446	4		
7'0"	2134 x 2125	1492	1593	4	1296	1473	4		
7'6" x 6'6"	2286 x 2000	1475	1574	4	1279	1458	4		
7'0"	2286 x 2125	1492	1593	4	1296	1486	4		
7'4"	2286 x 2250	1558	1737	4	1292	1493	4		
7'9"	2286 x 2375	1565	1778	4	1381	1593	4		
8'2"	2286 x 2500	1604	1840	4	1379	1602	4		
8'0" x 6'6"	2438 x 2000	1558	1670	4	1349	1540	4		
7'0"	2438 x 2125	1588	1692	4	1369	1572	4		
7'4"	2438 x 2250	1667	1908	4	1362	1576	4		
7'9"	2438 x 2375	1711	1938	4	1451	1677	4		
8'2"	2438 x 2500	1758	1973	4	1449	1687	4		
8'6" x 6'6"	2591 x 2000	1558	1670	4	1349	1552	4		
7'0"	2591 x 2125	1588	1692	4	1369	1584	4		
9'0" x 6'6"	2740 x 2000	1717	1832	4	1466	1680	4		
7'0"	2740 x 2125	1740	1861	4	1487	1715	4		
9'6" x 6'6"	2896 x 2000	1813	1932	5	1538	1764	5		
7'0"	2896 x 2125	1840	1965	5	1567	1808	5		
10'0" x 6'6"	3048 x 2000	1813	1932	5	1477	1715	5		
7'0"	3048 x 2125	1840	1965	5	1507	1760	5		

For information on outside colour, see below

All coloured doors are special order only – 4 to 8 weeks delivery. Please note: the prices listed as Outside Colour are for the following RAL colours only: RAL 1015, 3003, 5011, 5014, 6005, 6009, 7016, 7030, 7035, 7040, 8001, 8003, 8028, 9005, 9006 and 9007. Special RAL colours are available, please ask your garage door specialist.

Double doors with N track springs (see shaded area of grid). For low headroom see bottom of page

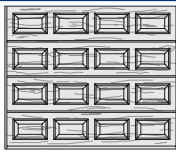
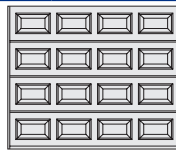
DOUBLE DOORS		 L-ribbed Titan Metallic CH 703	 S-panelled Decograin	 S-panelled Woodgrain					
Door sizes BR					Rosewood, Golden Oak, Dark Oak, Winchester Oak, Night Oak	No. of panels	Outside White	Outside Colour	No. of panels
Imperial	Metric								
11'0" x 6'6"	3353 x 2000	2158	2296	5	1760	2022	5		
7'0"	3353 x 2125	2191	2334	5	1792	2070	5		
12'0" x 6'6"	3658 x 2000	2444	2595	6	2073	2359	6		
7'0"	3658 x 2125	2488	2639	6	2107	2411	6		
13'0" x 6'6"	3962 x 2000	2523	2678	6	2156	2466	6		
7'0"	3962 x 2125	2557	2717	6	2185	2514	6		
14'0" x 6'6"	4267 x 2000	2600	2760	7	2241	2574	7		
7'0"	4267 x 2125	2641	2803	7	2276	2630	7		
14'6" x 6'6"	4420 x 2000	2673	2834	7	2322	2667	7		
7'0"	4420 x 2125	2713	2880	7	2360	2727	7		
15'0" x 6'6"	4572 x 2000	2701	2868	7	2364	2721	7		
7'0"	4572 x 2125	2744	2912	7	2403	2782	7		
15'6" x 6'6"	4725 x 2000	2752	2924	7	2479	2848	7		
7'0"	4725 x 2125	2799	2967	7	2517	2909	7		
16'0" x 6'6"	4877 x 2000	2801	2978	7	2479	2860	7		
7'0"	4877 x 2125	2851	3026	7	2517	2922	7		

Low headroom

Door with track application L, torsion spring at the back

132

Intermediate sizes are available, please see your dealer for more details

Hörmann Sectional Doors

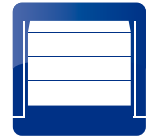

Optional extras for sectional doors

Colour surcharge	Price
RAL to choose colours (please ask to see colour chart)	per m ² 65
Door leaf in special colours (please ask to see colour chart)	per m ² 129

Fittings	Article no.	£
----------	-------------	---

The below listed handle sets are supplied with:

- Lock with profile half cylinder with side locking
- Template for lock knock-out on site

A factory lock knock-out will result in a longer delivery time and must be ordered explicitly (State position on order!)

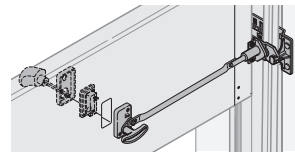

Door handle set, black plastic, prepared for profile cylinder	4015100	Each	60
Door handle set, silver finish cast aluminium (F2), prepared for profile cylinder	3060829	Each	146
Door handle set, cast aluminium RAL 9016, prepared for profile cylinder	3060831	Each	167
Door handle set, brown cast aluminium, prepared for profile cylinder	3076054	Each	167
Door handle set, brushed stainless steel, prepared for profile cylinder	3060835	Each	167

Emergency release	Price
-------------------	-------

Emergency release for sectional doors with handle set (Please state at point of order)	Each	44
Emergency release for sectional doors without handle set (Please state at point of order)	Each	43

Special anchor set	Price
--------------------	-------

Set of 8 special anchors for between wall fitting	per set	53
---	---------	-----------

ThermoFrame – Frame support with thermal break	Price
--	-------

Set 1 to 3 consists of:

- Lintel seal (1 unit) with 2 lip seals
- Plastic angle profiles (2 units) black 84 × 22.5 mm with lip seal

Set 4 and 5 consists of:

- Plastic angle profiles (3 units) black 84 × 22.5 mm with lip seal

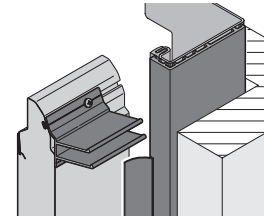

Note on set 1 to 3:

- The single-skinned fascia panel is eliminated and cannot be fitted. Headroom required for track application N = 255 mm, headroom required for track application Z and L = 145 mm.
- Please also note the supplements and limitations in the technical manual!
- Not possible for LTH 42!

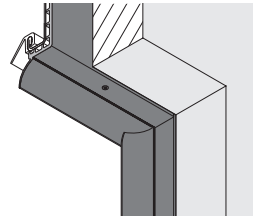

Note on set 4 and 5 (frame covering not possible):

- A single-skinned fascia panel is fitted. Required headroom corresponds with track application Z, N and L.
- Please also note the supplements and limitations in the technical manual!

ThermoFrame set 1 Article no. 4004702	RM height ≤ 3000 mm LZ width ≤ 3250 mm	2 plastic angle profiles Length 3210 mm 1 lintel seal Length 3250 mm	Each	260
ThermoFrame set 2 Article no. 4006087	RM height ≤ 3000 mm LZ width > 3250 mm and ≤ 6000 mm	2 plastic angle profiles Length 3210 mm 1 lintel seal Length 6000 mm	Each	307
ThermoFrame set 3 Article no. 4004982	For doors with track application H	2 plastic angle profiles Length 4500 mm 1 lintel seal Length 5500 mm	Each	307
ThermoFrame set 4 Article no. 4015121	RM height ≤ 3000 mm LZ width ≤ 3210 mm	3 plastic angle profiles Length 3210 mm	Each	307
ThermoFrame set 5 Article no. 4015122	RM height ≤ 3000 mm LZ width ≥ 3210 mm and ≤ 6000 mm	2 plastic angle profiles Length 3210 mm 1 plastic angle profile Length 6000 mm	Each	307

Frame cover profiles matching the colour of the door – 55mm × 19.5mm and 90mm × 19.5mm: prices are per pair

Door heights	White RAL 9016						Colour						RAL to choose/CH 703				Decograin/Titan Metallic CH 703	
	Woodgrain		Sandgrain		Silkgrain		Woodgrain		Sandgrain		Silkgrain		Woodgrain		Silkgrain		55mm	90mm
	55mm	90mm	55mm	90mm	55mm	90mm	55mm	90mm	55mm	90mm	55mm	90mm	55mm	90mm				
1875mm	57	79	62	87	62	87	70	104	81	107	81	107	98	141	104	154	89	115
2000mm	60	84	66	92	66	92	74	110	86	114	86	114	104	150	110	164	94	122
2080mm	63	88	69	96	69	96	77	115	90	119	90	119	109	156	115	171	98	127
2125mm	64	90	71	98	71	98	79	117	92	122	92	122	111	160	117	175	100	130
2250mm	68	95	75	104	75	104	84	124	97	129	97	129	117	169	124	185	106	138
2375mm	72	100	79	110	79	110	88	131	103	136	103	136	124	179	131	195	112	145
2500mm	75	105	83	115	83	115	93	138	108	143	108	143	130	188	138	205	118	153

Silkgrain white / Titan Metallic CH 703 and Decograin colours are available ex-stock. **Please note colours and RAL to choose/CH 703 must be ordered with the door.**

Sandgrain is available in RAL 9016, 7016, 8028 and 9006

Retrofit fascias	White RAL 9016	Colour	RAL to choose/CH 703	Decograin/Titan Metallic CH 703
------------------	----------------	--------	----------------------	---------------------------------

Door heights	Woodgrain	Sandgrain	Silkgrain	Woodgrain	Sandgrain	Silkgrain	Woodgrain	Silkgrain	
--------------	-----------	-----------	-----------	-----------	-----------	-----------	-----------	-----------	--

Set: Renovation fascias to cover damaged brickwork edges consisting of: 3 angle sections, 69/40mm, each 3000mm long

Price	163	176	176	202	215	215	228	241	185
--------------	------------	------------	------------	------------	------------	------------	------------	------------	------------

Set: Fascia frame -95- consisting of: 2 fascias, 95mm, 2800mm long, 1 fascia 95mm, 3200mm long, fixing material

Price	184	200	200	223	239	239	249	265	207
--------------	------------	------------	------------	------------	------------	------------	------------	------------	------------

Hörmann Sectional Doors



Glazing options for sectional doors





LTE 42 with 3mm single pane in clear (FK) or crystal structure (KR), 3mm

LTE 42 ribbed doors are only available with type D glazing

LPU 42 with 16mm (for panelled) or 22mm (for ribbed) double pane in clear (DS) or crystal structure (DK)

LTE 42 panelled doors are available in S glazing only

LTE 42 doors are not available with M0 & L0 glazing

Glazings		£/each
S0	 With synthetic single pane, 3 mm, clear or crystal structure	LTE 42 95
	With synthetic double pane, 16 mm or 22mm, clear / clear or crystal structure / crystal structure	LPU 42 102
S1	 With synthetic single pane, 3 mm, clear or crystal structure	LTE 42 114
	With synthetic double pane, 16 mm or 22mm, clear / clear or crystal structure / crystal structure	LPU 42 125
S2	 With synthetic single pane, 3 mm, clear or crystal structure	LTE 42 114
	With synthetic double pane, 16 mm or 22mm, clear / clear or crystal structure / crystal structure	LPU 42 125
S 10 – S 60	 With synthetic single pane, 3 mm, clear or crystal structure	LTE 42 122
	With synthetic double pane, 16 mm or 22mm, clear / clear or crystal structure / crystal structure	LPU 42 129
M0	 <ul style="list-style-type: none"> With synthetic double pane, 22 mm, Clear / clear or crystal structure / crystal structure 	LPU 42 123







For door width and glazing configuration, please refer to the 01-19 A price list

L0	 <ul style="list-style-type: none"> With synthetic double pane, 22 mm, Clear / clear or crystal structure / crystal structure 	LPU 42 160
-----------	--	-------------------

For door width and glazing configuration, please refer to the 01-19 A price list

Type D	 <ul style="list-style-type: none"> With clear synthetic pane or crystal structure, 3 mm 	LTE 42 87
	<ul style="list-style-type: none"> With synthetic double pane, clear / clear or crystal structure / crystal structure, 16 mm 	LPU 42 102

For door width and glazing configuration, please refer to the 01-19 A price list

Sunrise Glazing		£/section
S 10		<ul style="list-style-type: none"> With synthetic single pane, 3 mm Clear or crystal structure
LTE 42	Door width 2075 mm up to 2740 mm	For LTE 42 (4 × £122) 488
LPU 42	Door width 2130 mm up to 2750 mm	For LPU 42 (4 × £129) 516
S 20		<ul style="list-style-type: none"> With synthetic single pane, 3 mm Clear or crystal structure
LTE 42	Door width 2745 mm up to 3000 mm	For LTE 42 (5 × £122) 610
LPU 42	Door width 2755 mm up to 3500 mm	For LPU 42 (5 × £129) 645
S 30		<ul style="list-style-type: none"> With synthetic double pane, 16 mm or 22mm Clear / clear or crystal structure / crystal structure
LPU 42	Door width 3505 mm up to 4000 mm	For LPU 42 (6 × £129) 774
S 40		<ul style="list-style-type: none"> With synthetic double pane, 16 mm or 22mm Clear / clear or crystal structure / crystal structure
LPU 42	Door width 4005 mm up to 4750 mm	For LPU 42 (7 × £129) 903
S 50		<ul style="list-style-type: none"> With synthetic double pane, 16 mm or 22mm Clear / clear or crystal structure / crystal structure
LPU 42	Door width 4755 mm up to 5500 mm	For LPU 42 (8 × £129) 1032
S 60		<ul style="list-style-type: none"> With synthetic double pane, 16 mm or 22mm Clear / clear or crystal structure / crystal structure
LPU 42	Door width 4755 mm up to 5500 mm	For LPU 42 (8 × £129) 1032

Standard Colour Surcharges for the above windows. Please note: front window frame only is painted		Price
Standard colour or colour for Decograin	For glazing S0, S1, S2, M0, L0 & type D	Each 27
	For Sunrise glazing × No. of frames for width of door	Each 33
RAL to choose	For glazing S0, S1, S2, M0, L0 & type D	Each 48
	For Sunrise glazing × No. of frames for width of door	Each 60

Hinged Garage Doors DFT 42

// NEW





Double-leaf hinged garage doors and door leaf frames made of aluminium profiles; door infill made of steel sectional door sections 42 mm

Size range, ribbed

For an overview of dimensions and optional extras, see price list 01-19 A

Size range Ordering sizes Overall frame dimensions (RAM) Width × Height	 S-ribbed Woodgrain						
	Exterior White	Exterior Color					
Fitting in the opening – opening outwards							
From 1330 × 1960							
to 1800 × 2250	2971	3303					
to 2200 × 2100	3026	3358					
to 3000 × 2500	3405	3737					

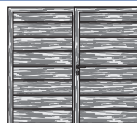
Size range Ordering sizes Overall frame dimensions (RAM) Width × Height	 M-ribbed Woodgrain		 M-ribbed Sandgrain¹⁾		 M-ribbed Silkgrain		 M-ribbed Decograin²⁾ Exterior Timber design /Titan Metallic CH 703	
	Exterior White	Exterior Color	Exterior White	Exterior Color	Exterior White	Exterior Color		
Fitting in the opening – opening outwards								
From 1330 × 1960								
to 1800 × 2250	2971	3303	3082	3414	3178	3510	3471	
to 2200 × 2100	3026	3358	3140	3472	3239	3571	3540	
to 3000 × 2500	3405	3737	3533	3865	3646	3978	3982	

1) Surface in *Sandgrain* only available in the colours RAL 7016 Anthracite grey, RAL 8028 Terra brown and RAL 9006 White aluminium. Other colours or RAL to choose are not possible!

2) *Decograin* surface with timber design film coating or decor film coating in Titan Metallic CH 703. Please state desired decor on order!

Polyester-primer coating	£
Frame inside and outside, door leaf infill outside	
Color	Per m ² 39
RAL to choose or colour CH 703 Anthracite metallic	Per m ² 65
Special colours	Per m ² 129
Fastening holes	£
Fastening holes for fitting in the opening	Per door 18
Fittings and further optional extras	See from page 419 in price list 01-19 A

Optional Extras

For roller garage door RollMatic including operator



Fitting compensation set		Article no.	£
(to accommodate for unevenness on the building structure when fitting behind/in front of the opening)			
Fitting compensation set LH ≤ 2300		8991235 Per set	42
Fitting compensation set LH > 2300		8991236 Per set	48
Chamfered bottom profile			£
Roller garage door RollMatic with chamfered bottom profile (not available in the surfaces Golden Oak and Rosewood)		In black	Per m 320
		In door colour	Per m 320
Symmetrical barrel casing			£
Symmetrical barrel casing for a visually balanced look		Per door	No surcharge
Additional fascia panel			£
Reinforcement of the fascia panel			
Note: Required for fitting in the opening!		In door colour	Per m 65
► State additional fascia panel height (SBH) and width!			

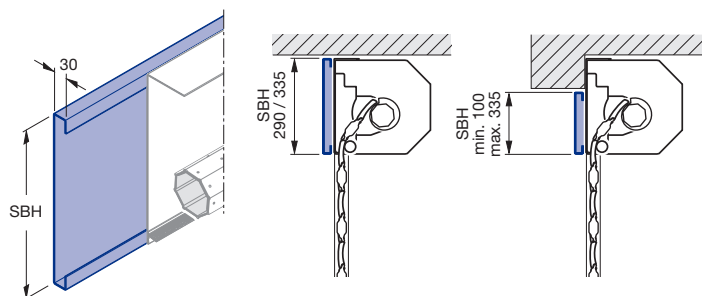

Note:
State on door order, subsequent fitting is not possible.

SBH Fascia panel height
min. At least
max. Maximum

Optional extras		£
	Glazing element with clear synthetic pane, window cut-out 112 × 33 mm, black glazing frame on exterior, transparent on interior (maximum of 10 sections per door, number of glazing elements depending on the door width)	Per m 28
	Ventilation grilles Black plastic Ventilation cross section approx. 13 cm ² /grille (maximum of 10 sections per door, number of ventilation grilles depending on the door width)	Per m 28
	Brush seal for fascia panel	LB up to 3000 mm Per door 15 LB from 3000 mm to 5000 mm Per door 21

Aluminium cover for side guides (as standard with external roller garage door) Per m **45**

2-coloured roller garage door RollMatic		£
After technical clarification!		
2-coloured roller garage door – frame and door curtain		Per door 111
2-coloured door curtain		Per door 310

Accessories for operator RollMatic		Article no.	£
Motor connection line, 10 m		436523	35
Acoustic anti-lift kit		436524 Each	56
Emergency battery HINA 18		437726 Each	206
Emergency release			£
Exterior emergency release for internal roller garage door		436526 Each	90
Exterior emergency release for external roller garage door		436526 Each	90
Accessory bag for double secured release SE		437728 Each	9
Bowden cable, length 1 m, for double secured release SE		437986 Each	16
Note: All 3 articles are required for the external roller garage door!			





Fixed element		£
Element infill with roller garage door sections in RollMatic look. Position of sections does not match the roller garage door RollMatic.		Based on RAL 9016
Frame made of aluminium extrusion profile. Coated in color of the element infill.		Color on request
Decopaint and Decograin colours matched to the surface Decopaint/Decograin.		Decopaint
RAMB max. 6000 mm. Reinforcement profile from RAMB > 5000 mm.		Decograin
For technical drawings on the fixed element please consult price list 01- 19 A		

RollMatic Side Doors

NT60 profile type 4

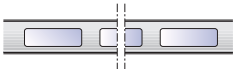

Accessories for RollMatic side doors

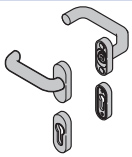
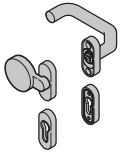
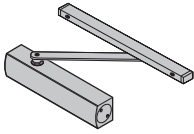
Matching side door and accessories			
Size Range Ordering sizes Overall frame dimensions (RAM) Width × Height	 White or Colour	 Decopaint Golden Oak or Rosewood	 Decograin Golden Oak or Rosewood
Opening inwards or outwards			
From 875 × 1800			
Up to 1200 × 2255	847	930	1074
From 1201 × 2256			
Up to 1284 × 2500	886	963	1121
Note: View of internal roller garage door / external roller garage door, state opening sense and handing!			
Glazing element			£
	Glazing element with clear synthetic pane, window cut-out 112 × 33 mm, black glazing frame on exterior, transparent on interior The number of glazing elements depends on the door width (not possible in the bottom section and in the lock area)	Per m	28
Ventilation grilles			£
	Ventilation grille, black plastic Ventilation cross section: approx. 13 cm ² /grille The number of ventilation grilles depends on the door width (not possible in the bottom section and in the lock area)	Per m	28
Smaller overall frame dimensions			£
Side door in smaller dimensions than special sizes			Per door 386
Frame fixing (optional)			£
Support bracket for block frame			Per set 23
Screw-in anchor for corner frame			Per set 25
Fittings			£
Lever handle sets			
	Cast aluminium with natural finish (F1), prepared for profile cylinder	Each	111
	Cast aluminium with silver finish (F2), prepared for profile cylinder	Each	111
	Cast aluminium in RAL 9016, prepared for profile cylinder	Each	133
	Cast aluminium in brown, prepared for profile cylinder	Each	133
	Brushed stainless steel, prepared for profile cylinder	Each	145
Lever / knob handle sets			
	Black plastic, prepared for profile cylinder	Each	61
	Cast aluminium with natural finish (F1), prepared for profile cylinder	Each	127
	Cast aluminium with silver finish (F2), prepared for profile cylinder	Each	127
	Cast aluminium in RAL 9016, prepared for profile cylinder	Each	159
	Cast aluminium in brown, prepared for profile cylinder	Each	159
Brushed stainless steel, prepared for profile cylinder	Each	169	
Overhead door closers			
	Overhead door closer with slide rail and hold-open device	Each	253
3-point locking			
3-point locking with latch, bolt, and 2 locking hooks; keys to differ Cannot be retrofitted!			Per door 388
Electric door strike with day and night setting (without wiring). For doors with block frame made of aluminium profiles.			
10–24 V, LH hinged / RH hinged (only opens with an impulse, i.e. as long as the button is pressed)			Each 96
10–24 V, LH / RH hinged (remains open after impulse until the door is actuated, subsequent locking by door strike)			Each 128
Block reed contact			£
Block reed contact (article no. 4004810)			Each 93
Anti-panic locks			£
Panic lock function E For profile cylinders, for fixed knob on exterior, the door can only be opened from the outside using a key			Each 192
Profile double cylinder			£
Profile double cylinder 40 + 40 mm Keys to pass, for side doors NT 60			on request

For additional optional extras please refer to the 01-19 A price list

Roller Garage Door – RollMatic TDL

Including tubular drive

Size range and prices



Prices for internal roller garage doors

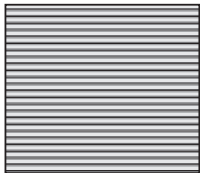

Exterior
RAL 9016 Traffic white or
RAL 7016 Anthracite grey

2300	1303	1303	1333	1333	1438	1572	1618	1659	1732
2125	1303	1303	1333	1333	1393	1504	1569	1603	1662
2000	1303	1303	1333	1333	1349	1439	1500	1560	1587
1750	1303	1303	1333	1333	1349	1439	1500	1560	1587
1500	1303	1303	1333	1333	1349	1439	1500	1560	1587
	1250	1500	1750	1900	2000	2250	2500	2750	3050
Clear width (LB) = ordering size									

Only available in the priced size range listed! (Minimum production dimension BR 1250 x 1500 mm)

Prices for internal roller garage doors

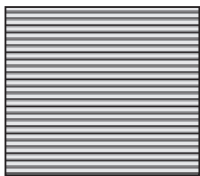

Exterior
Decopaint Golden Oak* or
Noir 2100 Sablé (Anthracite metallic)

2300	1368	1379	1423	1432	1542	1688	1748	1801	1890
2125	1361	1375	1418	1424	1489	1614	1688	1742	1810
2000	1359	1371	1413	1419	1439	1542	1613	1685	1724
1750	1352	1362	1402	1408	1428	1528	1598	1669	1706
1500	1345	1353	1393	1398	1417	1515	1584	1654	1689
	1250	1500	1750	1900	2000	2250	2500	2750	3050
Clear width (LB) = ordering size									

* Painted in timber design look on inside and outside

Only available in the priced size range listed! (Minimum production dimension BR 1250 x 1500 mm)

Accessory	Description	Part no.		£
	RollMatic TDL hand transmitter Impulse, Incl. battery 433.92 MHz Battery: 3 V / type: 2025 Dimensions (W x H x D): 28 x 58 x 25mm	RSC2	Each	48

Important product information

Please note that the RollMatic TDL cannot be fitted to a garage without alternate access.

Overhead Garage Door RollMatic OD

Including side operator ProMatic

Size range and prices



For a product description, see price list 01-19 A

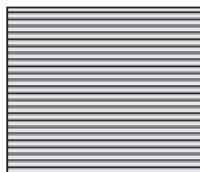

Exterior
White or Color

(same price)

Prices for overhead garage doors RollMatic OD

Clear height (LH) = ordering size height (BMH)	3000			1867	1912	1964	2007	2057	2099	2151
	2875			1832	1874	1914	1964	2011	2056	2097
	2750			1799	1834	1875	1923	1968	2009	2048
	2625			1759	1799	1833	1879	1925	1963	1999
	2500	1555	1552	1745	1780	1821	1865	1911	1948	1988
	2375	1516	1536	1645	1679	1721	1758	1797	1829	1867
	2250	1480	1516	1554	1587	1623	1661	1695	1729	1765
	2125	1452	1482	1516	1549	1583	1619	1652	1680	1719
	2000	1423	1450	1479	1510	1541	1575	1608	1638	1671
	1875	1391	1433	1446	1481	1516	1544	1578	1612	1645
	1700									
	1250	1500	1750	2000	2250	2500	2750	3000	3250	3500

Only available in the priced size range listed! (min. production dimension BR 1250 x 1700 mm)

SupraMatic E



Optional with garage door operator SupraMatic E
With 5-button hand transmitter HS 5 BS (black textured surface)

Surcharge

138

2-coloured overhead garage door RollMatic OD

see page 29

Optional extras for overhead garage door RollMatic OD

see page 29

Overhead Garage Door RollMatic OD

Including side operator ProMatic

Size range and prices

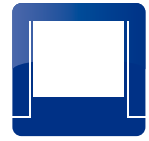

For a product description, see price list 01-19 A

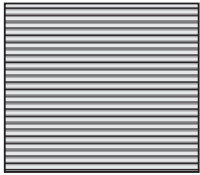

Exterior
Decopaint*

Golden Oak/Rosewood or
Noir 2100 Sablé

* Painted in timber design look on inside and outside

Prices for overhead garage doors RollMatic OD

Clear height (LH) = ordering size height (BMH)	3000			2010	2073	2143	2203	2270	2331	2400
	2875			1969	2029	2085	2152	2217	2278	2336
	2750			1929	1983	2037	2103	2166	2220	2278
	2625			1883	1941	1990	2052	2113	2166	2217
	2500	1645	1656	1864	1914	1969	2029	2088	2144	2197
	2375	1601	1636	1759	1807	1862	1914	1967	2013	2066
	2250	1560	1610	1662	1708	1757	1809	1856	1904	1953
	2125	1528	1571	1618	1663	1711	1758	1804	1846	1897
	2000	1494	1534	1574	1618	1660	1705	1751	1792	1837
	1875	1457	1508	1532	1577	1623	1663	1707	1753	1795
1700										
	1250	1500	1750	2000	2250	2500	2750	3000	3250	3500

Only available in the priced size range listed! (min. production dimension BR 1250 x 1700 mm)

SupraMatic E

£



Optional with garage door operator SupraMatic E
With 5-button hand transmitter HS 5 BS (black textured surface)

Surcharge

138

Optional extras for overhead garage door RollMatic OD

see page 29

Overhead Garage Door RollMatic OD

Including side operator ProMatic

Size range and prices



For a product description, see price list 01-19 A

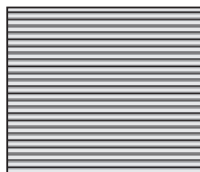

Exterior
Decograin*

Golden Oak or Rosewood

* Plastic film coating in timber design look on outside

Prices for overhead garage doors RollMatic OD

Clear height (LH) = ordering size height (BMH)	3000			2426	2536	2641	2735	2835	2960	3065
	2875			2377	2481	2573	2672	2767	2891	2983
	2750			2325	2416	2504	2603	2698	2811	2902
	2625			2271	2362	2442	2538	2631	2740	2829
	2500	1961	2002	2235	2320	2405	2494	2587	2676	2780
	2375	1899	1958	2116	2199	2283	2359	2441	2525	2622
	2250	1851	1925	2009	2089	2166	2242	2318	2399	2493
	2125	1812	1876	1952	2028	2098	2171	2243	2315	2393
	2000	1771	1830	1892	1965	2031	2103	2169	2238	2309
	1875	1721	1792	1834	1907	1976	2039	2103	2175	2240
	1700									
	1250	1500	1750	2000	2250	2500	2750	3000	3250	3500

Only available in the priced size range listed! (min. production dimension BR 1250 x 1700 mm)

SupraMatic E



Optional with garage door operator SupraMatic E
With 5-button hand transmitter HS 5 BS (black textured surface)

Surcharge

138



Optional extras for overhead garage door RollMatic OD

see page 29

Optional Extras

For overhead garage door RollMatic OD including side operator ProMatic

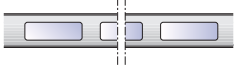

Optional extras	Article no.	£
 <p>Glazing element With clear synthetic pane, window cut-out 112 x 33 mm, black glazing frame on exterior, transparent on interior (maximum 10 sections per door, number of glazing elements depending on the door width)</p>	Per m	28
 <p>Ventilation grilles Black plastic Ventilation cross section: approx. 13 cm²/grille (maximum of 10 sections per door, number of ventilation grilles depending on the door width)</p>	Per m	28

2-coloured overhead garage door RollMatic OD	£
After technical clarification!	
2-coloured roller garage door – frame and door curtain	Per door 111
2-coloured door curtain	Per door 310

Retrofit fascia panels for flush fitting	£
Set: fascia frame OD	
<ul style="list-style-type: none"> As cover for lintel and frame with flush-fitting installation and for renovations For use with doors up to LB max. 3150 mm and LH max. 2700 mm 	
Consisting of:	
<ul style="list-style-type: none"> 2 fascias, width 95 mm, length 2800 mm each, 1 fascia, width 95 mm, length 3200 mm, including additional fixing material for panel and door 2 plastic panel shoes (black) 	

Note:
The vertical tracks and the fascia panel are pre-drilled at the factory if this fitting is selected.

Surface finish	£
White, based on RAL 9016 or Color	Per set 247

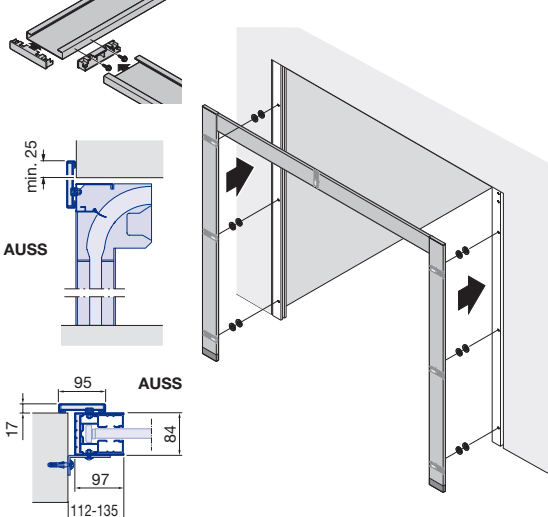

AUSS Exterior
min. At least

Emergency release NET 4 (required if there is no second entrance)	See the "Door operators" section in the 01-19 A
Accessories for operator ProMatic / SupraMatic E	See the "Door operators" section in the 01-19 A

Garage Door Operators

Operator Accessories







Garage door operators

Boom Length	SupraMatic E	SupraMatic P	ProMatic	ProMatic Canopy	ProMatic Akku
K	530	602	422	535	740
M	560	632	452	565	770
L	653	725	545	658	863

Hand transmitters with BiSecur technology are backwards compatible, i.e. they can also be used with series 1 and 2 operators (868 MHz). Hand transmitter 868 MHz BiSecur, incl. battery (Range of radio signal depends on local conditions)

- Possible
- Only in combination with a BiSecur radio receiver
- Only in conjunction with the BiSecur radio receiver ESE, status query possible
- Not possible

Accessory	Description	Garage door operators				
		SupraMatic E/P	SupraMatic HT	ProMatic	ProMatic Akku	RollMatic
HS 1-button hand transmitter  Black HS 1 BS Art. no. 4511720 £ 63	Textured plastic surface with chrome-plated zinc die-cast caps <ul style="list-style-type: none"> • Impulse • Protection category: for dry rooms only • Temperature range: -20 °C to +60 °C • Battery: 1.5 V LR03/AAA • Dimensions: 38 × 95 × 16 mm 	●	●	●	●	●
HS 4-button hand transmitter  Black HS 4 BS Art. no. 4511724 £ 63	Textured plastic surface with chrome-plated zinc die-cast caps <ul style="list-style-type: none"> • Impulse • Protection category: for dry rooms only • Temperature range: -20 °C to +60 °C • Battery: 1.5 V LR03/AAA • Dimensions: 38 × 95 × 16 mm 	●	●	●	●	●
HS 5-button hand transmitter  Black HS 5 BS Art. no. 436946 £ 74	Textured plastic surface with chrome-plated zinc die-cast caps <ul style="list-style-type: none"> • Impulse • Status query • Protection category: for dry rooms only • Temperature range: -20 °C to +60 °C • Battery: 1.5 V LR03/AAA • Dimensions: 38 × 95 × 16 mm 	●	●	●	-	-
HS 5-button hand transmitter   Black HS 5 BS Art. no. 436752 £ 74	High gloss plastic surface with chrome-plated zinc die-cast caps <ul style="list-style-type: none"> • Impulse • Status query • Protection category: for dry rooms only • Temperature range: -20 °C to +60 °C • Battery: 1.5 V LR03/AAA • Dimensions: 38 × 95 × 16 mm 	●	●	●	-	-





Garage Door Operators

Operator Accessories



Hand transmitters with BiSecur technology are backwards compatible, i.e. they can also be used with series 1 and 2 operators (868 MHz). Hand transmitter 868 MHz BiSecur, incl. battery (Range of radio signal depends on local conditions)

- Possible
- Only in combination with a BiSecur radio receiver
- Only in conjunction with the BiSecur radio receiver ESE, status query possible
- Not possible

Accessory			Description	Garage door operators				
				SupraMatic E/P	SupraMatic HT	ProMatic	ProMatic Akku	RollMatic
Accessories For hand transmitters (HS and HSS) <div style="display: flex; justify-content: space-around; align-items: center;">    </div> <div style="display: flex; justify-content: space-around; margin-top: 5px;"> Black Black (textured surface) White </div>			<ul style="list-style-type: none"> For HS 1 BS, HS 4 BS, HS 5 BS, HSS 4 BS 					
Hand transmitter station Art. no. 436691 437077 436692 £ 11 11 11								
For hand transmitters (HS and HSS) <div style="text-align: center; margin-top: 10px;">  </div>			<ul style="list-style-type: none"> For HSE 1 BS, HSE 2 BS and HSE 4 BS Transparent, incl. visor clip For wall fitting or for fitting to the visor clip Without fitting material 					
Hand transmitter holder Transparent, incl. visor clip Art. no. 436698 £ 10								
HSE 1-button hand transmitter <div style="text-align: center; margin-top: 10px;">  </div>			Textured plastic surface with chrome-plated zinc die-cast caps <ul style="list-style-type: none"> Impulse Incl. key ring for fastening to the key chain Protection category: for dry rooms only Temperature range: 0 °C to +60 °C Battery: Lithium round cell 3 V / type CR 2032 Dimensions: 28 x 70 x 14 mm 	●	●	●	●	●
HSE 1 BS Art. no. 4511728 £ 63								
HSE 2-button hand transmitter <div style="display: flex; justify-content: space-around; align-items: center; margin-top: 10px;">   </div>			High gloss plastic surface with chrome-plated zinc diecast caps <ul style="list-style-type: none"> Impulse Incl. key ring for fastening to the key chain Protection category: for dry rooms only Temperature range: 0 °C to +60 °C Battery: Lithium round cell 3 V / type CR 2032 Dimensions: 28 x 70 x 14 mm 					
<div style="display: flex; justify-content: space-around; margin-top: 5px;"> Black White </div> HSE 2 BS HSE 2 BS Art. no. 436754 436755 £ 63 63								
HSE 2-button hand transmitter HSE 2 BS								
Housing colour	Art. no.	£						
Purple	436869	74						
Orange	436870	74						
Yellow	436871	74						
Red	436872	74						
Green	436873	74						
Carbon	436863	74						
Silver	436864	74						
Dark rootwood look	436866	74						





Garage Door Operators

Operator Accessories



Hand transmitters with BiSecur technology are backwards compatible, i.e. they can also be used with series 1 and 2 operators (868 MHz). Hand transmitter 868 MHz BiSecur, incl. battery (Range of radio signal depends on local conditions)

- Possible
- Only in combination with a BiSecur radio receiver
- Only in conjunction with the BiSecur radio receiver ESE, status query possible
- Not possible

Accessory	Description	Garage door operators				
		SupraMatic E/P	SupraMatic HT	ProMatic	ProMatic Akku	RollMatic
<p>HSE 4-button hand transmitter</p>  <p>Black</p> <p>HSE 4 BS</p> <p>Art. no. 4511732</p> <p>£ 63</p>	<p>Textured plastic surface with chrome-plated zinc die-cast caps</p> <ul style="list-style-type: none"> • Impulse • Incl. key ring for fastening to the key chain • Protection category: for dry rooms only • Temperature range: 0 °C to +60 °C • Battery: Lithium round cell 3 V / type CR 2032 • Dimensions: 28 × 70 × 14 mm 	●	●	●	●	●
<p>HSE 4-button hand transmitter</p>  <p>Black</p> <p>HSE 4 BS</p> <p>Art. no. 4511736</p> <p>£ 57</p>	<p>Textured plastic surface with plastic caps</p> <ul style="list-style-type: none"> • Impulse • Incl. key ring for fastening to the key chain • Protection category: for dry rooms only • Temperature range: 0 °C to +60 °C • Battery: Lithium round cell 3 V / type CR 2032 • Dimensions: 28 × 70 × 14 mm 	●	●	●	●	●
<p>HSP 4-button hand transmitter</p>  <p>Black</p> <p>HSP 4 BS</p> <p>Art. no. 436776</p> <p>£ 66</p>	<ul style="list-style-type: none"> • Impulse • With sliding switch as a button lock-out • Incl. key ring • Protection category: for dry rooms only • Temperature range: -20 °C to +60 °C • Battery: Lithium round cell 3 V / type CR 2025 • Dimensions (D × H): Ø48 × 13 mm 	●	●	●	●	●
<p>HSD 2-button hand transmitter</p>  <p>Aluminium</p>  <p>Chrome</p> <p>HSD 2-A BS HSD 2-C BS</p> <p>Art. no. 436774 436775</p> <p>£ 89 89</p>	<ul style="list-style-type: none"> • Impulse • High-quality metal housing • As a key ring • Protection category: for dry rooms only • Temperature range: 0 °C to +60 °C • Battery: Lithium round cell 3 V / type CR 2025 • Dimensions (W × H × D): 32 × 66 × 13 mm 	●	●	●	●	●
<p>HSZ 1-button hand transmitter 2-button hand transmitter</p>  <p>Black</p>  <p>Black</p> <p>HSZ 1 BS HSZ 2 BS</p> <p>Art. no. 436779 436782</p> <p>£ 57 57</p>	<ul style="list-style-type: none"> • Impulse • For insertion in a vehicle cigarette lighter • Protection category: for dry rooms only • Temperature range: -20 °C to +60 °C • Battery: Lithium 3 V / type CR 2 • Dimensions (D × H): Ø29 × 39 mm 	●	●	●	●	●





Garage Door Operators

Operator Accessories



Hand transmitters with BiSecur technology are backwards compatible, i.e. they can also be used with series 1 and 2 operators (868 MHz). Hand transmitter 868 MHz BiSecur, incl. battery (Range of radio signal depends on local conditions)

- Possible
- Only in combination with a BiSecur radio receiver
- Only in conjunction with the BiSecur radio receiver ESE, status query possible
- Not possible

		Garage door operators				
		SupraMatic E/P	SupraMatic HT	ProMatic	ProMatic Akku	RollMatic
FIT 1-button radio internal push button  Art. no. FIT 1 BS 439740 £ 93		●	●	●	●	●
FIT 4-button radio internal push button  Art. no. FIT 4 BS 439741 £ 93		●	●	●	●	●
FIT 5-button radio internal push button  Art. no. FIT 5 BS 439742 £ 108		●	●	●	-	-
FES Radio receiver electric socket  Art. no. FES 1 BS 439762 £ 100						
FES Radio receiver electric socket  Art. no. FES 1-1 BS 439763 £ 113						

Garage Door Operators

Operator Accessories







Hand transmitters with BiSecur technology are backwards compatible, i.e. they can also be used with series 1 and 2 operators (868 MHz). Hand transmitter 868 MHz BiSecur, incl. battery (Range of radio signal depends on local conditions)

- Possible
- Only in combination with a BiSecur radio receiver
- Only in conjunction with the BiSecur radio receiver ESE, status query possible
- Not possible

Garage door operators

SupraMatic E / P	SupraMatic HT	ProMatic	ProMatic Akku	RollMatic
------------------	---------------	----------	---------------	-----------

Radio internal push button 868 MHz BiSecur, incl. battery (Range of radio signal depends on local conditions)

<p>FCT 3 BS Radio code switch</p>  <p>FCT 3 BS Art. no. 436758 £ 104</p>	<ul style="list-style-type: none"> • Impulse, for control of up to 3 door operators • Transmission of up to 3 radio codes, 868 MHz • Power supply: Battery 4 × 1.5 V LR03 / AAA • Illuminated keypad, clip frame • Protection category: IP 54 • Temperature range: -20 °C to +60 °C • Housing: Plastic • Dimensions (W × H × D): 80 × 135 × 40 mm 	<table border="1"> <tr> <td>●</td> <td>●</td> <td>●</td> <td>●</td> <td>●</td> </tr> </table>	●	●	●	●	●
●	●	●	●	●			
<p>FCT 10 BS Radio code switch</p>  <p>FCT 10 BS Art. no. 436759 £ 159</p>	<ul style="list-style-type: none"> • Impulse, for control of up to 10 door operators • Transmission of up to 10 radio codes, 868 MHz • Power supply: Battery 4 × 1.5 V LR03 / AAA • Illuminated keypad, sliding cover with metal embellishment • Protection category: IP 54 • Temperature range: -20 °C to +60 °C • Housing: Plastic • Dimensions (W × H × D): 80 × 135 × 40 mm 	<table border="1"> <tr> <td>●</td> <td>●</td> <td>●</td> <td>●</td> <td>●</td> </tr> </table>	●	●	●	●	●
●	●	●	●	●			
<p>CTR Code switch</p>  <p>1 relay output 3 separate relay outputs</p> <p>CTR 1b-1 CTR 3b-1 Art. no. 4511631 4511632 £ 203 234</p>	<ul style="list-style-type: none"> • Impulse • Illuminated keyboard • With 5 m connecting cable between the input unit and the decoder • Operating voltage: optionally 100–240 V AC or 10–24 V AC/DC • Max. switching capacity: <ul style="list-style-type: none"> – 30 V DC / 2.5 A (resistive load) – 230 V AC/500 W (resistive load) • Protection category: <ul style="list-style-type: none"> – Input unit IP 65 – Decoder unit IP20 • Temperature range: -20 °C to +60 °C • Input unit dimensions (W × H × D): 80 × 80 × 15 mm Decoder unit dimensions (W × H × D): 140 × 130 × 50 mm • Without connecting lead, connection cables for power supply <ul style="list-style-type: none"> – 230 V AC: Use connection cable ZL 1 – 24 V AC/DC and for providing impulse to operator: Use ASL connection cables. Use ASL connection cables (see page 521 in 01 -19 A Price List) <p>CTR 1b-1: 1 relay output for control of one door operator CTR 3b-1: 3 separate relay outputs for control of 2 operators, second opening height, outdoor lighting</p>	<table border="1"> <tr> <td>●</td> <td>●</td> <td>●</td> <td>-</td> <td>●</td> </tr> </table>	●	●	●	-	●
●	●	●	-	●			
<p>CTP Code switch</p>  <p>3 separate relay outputs</p> <p>CTP 3-1 Art. no. 4511634 £ 278</p>	<ul style="list-style-type: none"> • Illuminated capacitive keyboard • Impulse • With 5 m connecting cable between the input unit and the decoder • Operating voltage: optionally 100–240 V AC or 10–24 V AC/DC • Max. switching capacity: <ul style="list-style-type: none"> – 30 V DC / 2.5 A (resistive load) – 230 V AC/500 W (resistive load) • 3 separate relay outputs for control of 2 operators, second opening height, outdoor lighting • Protection category: <ul style="list-style-type: none"> – Input unit IP 65 – Decoder unit IP20 • Temperature range: -20 °C to +60 °C • Input unit dimensions (W × H × D): 80 × 80 × 15 mm Decoder unit dimensions (W × H × D): 140 × 130 × 50 mm • Without mains lead, connection cables for power supply <ul style="list-style-type: none"> – 230 V AC: Use connection cable ZL 1 (see page 520) – 24 V AC / DC and for providing impulse to operator: Use ASL connecting leads 	<table border="1"> <tr> <td>●</td> <td>●</td> <td>●</td> <td>-</td> <td>●</td> </tr> </table>	●	●	●	-	●
●	●	●	-	●			





Garage Door Operators

Operator Accessories



Hand transmitters with BiSecur technology are backwards compatible, i.e. they can also be used with series 1 and 2 operators (868 MHz). Hand transmitter 868 MHz BiSecur, incl. battery (Range of radio signal depends on local conditions)

- Possible
- Only in combination with a BiSecur radio receiver
- Only in conjunction with the BiSecur radio receiver ESE, status query possible
- Not possible

		Garage door operators				
		SupraMatic E/P	SupraMatic HT	ProMatic	ProMatic Akku	RollMatic
Radio internal push button 868 MHz BiSecur, incl. battery (Range of radio signal depends on local conditions)						
FIT	Radio internal push button					
	 <ul style="list-style-type: none"> • Impulse • With 2 impulse push buttons for control of 2 operators via radio signal • One additional button for On/Off function of connected external control elements • Connection option for max. 2 control elements (volt-free contact) e.g. key switch • Protection category: for dry rooms only • Temperature range: -20°C to +60°C • Battery: 2 x 1,5 V LR03/AAA • Colour: Pure white RAL 9010 • Dimensions (W x H x D): 80 x 80 x 45 mm 	●	●	●	●	●
	FIT 2-1 BS Art. no. 4511695 £ 74					
IT 3b-1	Internal push button					
	 <ul style="list-style-type: none"> • Impulse • Additional buttons for light on/off and operator on/off (vacation mode) • Illuminated keyboard • With 7 m connection cable, 2-wire • Protection category: for dry rooms only • Temperature range: -20°C to +60°C • Colour: Pure white RAL 9010 • Dimensions (W x H x D): 80 x 80 x 45 mm 	●	●	-	-	-
	IT 3b-1 Art. no. 4511647 £ 42					
Radio finger-scan 868 MHz BiSecur (range of radio signal depends on local conditions!)						
FFL	Radio finger-scan					
	 <ul style="list-style-type: none"> • Impulse, to control 2 operators using a fingerprint • Up to 12 fingerprints can be taught in, cannot be individually deleted • Setting / programming via 3 buttons • Housing: Plastic, sliding cover with metal embellishment • Display via 3 LEDs • Battery: 4 x 1,5 V LR03 / AAA • Protection category: IP 54 • Temperature range: -20°C to +60°C • Dimensions (W x H x D): 80 x 130 x 45 mm <p>Only for use with Hörmann BiSecur 868 MHz receivers.</p>	●	●	●	●	●
	FFL 12 BS Art. no. 436788 £ 225					
Batteries		Description				
HNA	Emergency battery					
	 <ul style="list-style-type: none"> • Emergency power supply to bypass power failures up to 18 hours and max. 5 door cycles (depending on temperatures, situation of charge etc.) • To be fixed on operator or garage ceiling • Protection category: for dry rooms only • Weight: approx: 2.3 kg • Operating voltage: 24 V DC / 2.3 Ah • Dimensions (W x H x D): 150 x 70 x 90 mm <p>Also suitable for series 2 SupraMatic and ProMatic operators.</p>	●	●	●	-	●
	HNA 18-3 Art. no. 437726 £ 214					
HNA	Emergency battery					
	 <ul style="list-style-type: none"> • Emergency power supply to bridge power outages • Universal fixing for wall and floor fitting • Double LED function display • Protection category: IP 65 • Weight: approx: 3 kg • Dimensions: 213 x 143 x 96 mm • Battery voltage: 24 V DC / 2.3 Ah <p>For RotaMatic / P / PL from autumn 2010 and for LineaMatic/P/H from year of manufacture 10/2009.</p>	-	-	-	-	-
	HNA Outdoor Art. no. 436522 £ 227					

Warranty

Hörmann products are manufactured to the highest quality standards and leave our factory only after rigorous quality testing. However, if you should have grounds for complaint, this section tells you what our door warranty offers, and how to go about making your claim.

In the unlikely event of a warranty claim becoming necessary, please contact the dealer or distributor who originally supplied your garage door. Your dealer should then supply details of the claim, together with a copy of the warranty card provided with the door and proof of purchase to the Product Services Department at Hörmann (UK) Ltd. To enable your claim under warranty to be processed as quickly as possible, you should provide the following details:

1. Your name, address and telephone number
2. Original invoice with date of purchase
3. Product description/door type and product number
4. Description of defect

An assessment of the claim will then be made. This may require Hörmann to inspect the product in-situ. In the event that there is no legitimate warranty claim under the terms specified herein, you may be liable for the costs of the inspection visit. We strongly recommend that you take note of the care and usage instructions displayed on the stickers on the back of your garage door, and on the page opposite, and that you follow these instructions throughout.

Hörmann installers

Hörmann (UK) Ltd has a nationwide network of recommended installers who will be able to offer you a regular maintenance service on your garage door. Please call us on 01530 513050 for details of your nearest dealer.

Hörmann (UK) Ltd Garage Door Warranty

Warranty Period The purchaser is granted a warranty covering the safe and reliable function of the Hörmann garage door for a period of 10 years from the date of purchase. A 5 year warranty applies to springs, wire cables, track rollers, hinges and guide rollers. The warranty period for replacement parts is 6 months or to the end of the current warranty period, whichever is longer. In the case of foil-coated timber-effect, a warranty of 5 years is granted, for timber and GRP doors a warranty of 2 years is granted on the door panels alone under the terms and conditions specified herein. The door mechanism and steel frame (if applicable) is covered by the 10 year warranty period.

Requirements Warranty claims are only applicable in the country where the garage door was purchased. The product must have been purchased through our authorised distribution channels. The warranty only covers damage to the contract object. The fully completed warranty card together with the receipt of purchase correspondingly dated substantiates your right to claim under the warranty.

Performance During the warranty period we undertake to rectify any and all defects to the Hörmann product which can be proved to be attributed to a material or manufacturing fault. We pledge at our discretion either to exchange the defective merchandise for faultless merchandise, repair it or allow a reduction in price. We do not accept costs for dismantling and installation nor for carriage. Replaced parts become our property.

The warranty does not cover damage caused through:

- normal wear and tear
- improper installation
- negligent care and maintenance
- improper initial and subsequent operation
- negligent or wanton destruction
- external influences such as fire, water, salts, alkaline solutions, acids, abnormal environmental influences
- mechanical damage through improper transport and fitting
- priming and other surface protection treatments
- incorrect or too late applied surface protection treatments
- repair by non-qualified persons
- using non-Hörmann parts without the approval of the manufacturer
- removal of the product number or making it unidentifiable

Electric Operator Warranty

A separate 5 year warranty is granted on our electric operators. This includes operator mechanics, motor and motor control systems. A 2 year warranty is granted on radio equipment, accessories and system controls. There is no warranty on consumables (e.g. fuses, batteries, bulbs etc.). For further details please contact us on 01530 513030 or through our website on www.hormann.co.uk

User Information/Care

Finish – Steel Doors

The coating process applied to the door and chassis is environmentally friendly. Minor scratches or marks are not covered under the conditions of our warranty and should be repaired immediately to prevent corrosion and deterioration of the panel. Corrosive substances such as acids, alkalines, and salts, etc. should be cleaned from the door immediately; failure to do so will result in deterioration of the finish, which will not be covered under our warranty. Should deterioration of the finish start to occur you will need to repaint your door immediately. Prepare the surface lightly with wet and dry. Then treat with solvent based 2 pack epoxy wash primer and a normal commercial paint (cellulose paint must not be used). Hörmann steel doors are a finished product. They do not require re-painting on site. They are however not immune to damage, which can occur at any stage of the handling of the product from factory to site.

Finish – Timber Doors

Timber panels are coated with a neutralising base-stain. Doors must be stored upright, under cover, with wrapping intact, until wrapping is removed. As soon as the door is unwrapped, one coat of a good quality basecoat primer must be applied to both sides of the door. Immediately after installation, your timber doors require a further two coats of a good quality exterior wood finish on both sides. Initial application and periodic treatment should be carried out strictly in accordance with the woodstain manufacturer's instructions. Failure to follow these instructions will result in early deterioration of the timber panel.

Finish – GRP Doors

GRP door panels should periodically washed down using water. This should be done more frequently if fitted near the sea. Bird droppings will bleach the finish on GRP and should be removed using water as soon as possible. GRP doors should not be painted over.

Paint Finish – Steel Doors

Minor surface damage can easily be repaired using touch up sprays or sticks without invalidating warranties.

The following document was designed by the Association of Garage Door Specialists, updated by the DHF and endorsed by all major UK garage door manufacturers, as a guide for purchasers of domestic garage doors.

Visual appearance of Garage Doors

A new garage door can be a significant investment that will transform the appearance of your home. This information is a guide to the quality you can expect.

The Quality Check

The quality check should be carried out in natural daylight, not direct sunlight. Stand at a distance of 3 metres from the door to view the overall appearance. The door is acceptable if, taking into account the facts below, none of the following are readily visible on the face of the door:

- Marks or distortion associated with the manufacturing process
- Minor indentations, marks or scuffs on the surface
- Paint or stain blemishes

The Facts

Steel Doors

Panel Distortion The rolling or pressing of steel panels during manufacture will cause distortion in the steel and while every effort is made to keep this to a minimum, inevitably some visible distortion will remain. The application of high gloss paints will make this slight distortion more apparent, especially under certain lighting conditions, such as car headlamps, or bright sunshine.

Paint Finish Primed doors – the primer coating is applied as a base coat only and as such requires additional finishing with a good quality exterior paint. Any marks or scratches on the primer coat should be rubbed down and repainted as part of this finishing process.

Timber Doors Finished doors – the factory application of the paint finish is an automated process and this may result in minor blemishes or slight inconsistencies in the paint, particularly in the area of panel joints.

Timber

Timber is a natural product and there will be variations in pattern, colour, shading and grains. No two doors will be the same, because wood naturally expands and contracts according to environmental conditions, joints will open and close and some minor curvature may occur.

It is vital that timber doors are fully finished as per the manufacturers instructions before exposure to the elements.

GRP and Composite Plastic Doors

Mould Marks GRP doors are individually handcrafted in a mould and are then hand finished. Some minor marks and blemishes will inevitably remain after this process.

Translucency When viewed from the inside, it is often possible to see variations in the translucency of the door, particularly around and between areas of relief. Such variations do not detract from the overall strength or build quality of the door.

All Doors

Colour Match Pairs of doors should be ordered together to obtain the best colour match, bearing in mind the limitations of the materials used in the construction. Timber garage doors cannot be ordered as matching sets.

Size Variation As the size of a door changes in height and/or width, the panel frequency and profile can change, therefore doors of the same style but of different sizes can be significantly different in appearance.

Clearances All doors require operating clearances, i.e. the gap between the door panel and the frame opening, these are inbuilt during manufacture and should not be reduced by means of infills, or draughtproofing.

Deflection When in the open position, all doors will display a level of vertical deflection or “sag” across the width of the panel. Individual manufacturers' specifications should be consulted for exact tolerances.

Power Operated Garage Doors

It is against the law to install a power operated garage door in the UK without complying with the Machinery Directive.

To comply with the Machinery Directive both the door and the operator used in the installation must have a Declaration of Incorporation from the manufacturer.

On completion of the installation the installer must provide a Declaration of Conformity and apply a CE mark giving details of the installation to the door / operator combination, which is now classed as a machine.

The installer must issue to the customer a Declaration of Conformity on completion of the installation.

The installer must hold copies of both the Declaration of Incorporation and the Declaration of Conformity on a technical file for inspection by the relevant authorities.

If any of the above requirements are not fulfilled the installation is illegal.

Please ensure for your own safety and peace of mind that whoever installs your electric operator is both willing and able to fulfil these requirements; if they are not – do not use them!

Members of the DHF Garage Door Installer Group can and will install your Hörmann operator safely and legally.

Since the company's policy is one of continuous improvement of its products, we reserve the right to make any alterations in design, manufacture or price. All business is governed by the company's Standard Conditions and this document does not form any part of any contract with the company and statements contained in it should not be construed as representations or warranties.

Hörmann: Quality without Compromise



Hörmann KG Amshausen, Germany



Hörmann KG Antriebstechnik, Germany



Hörmann KG Brandis, Germany



Hörmann KG Brockhagen, Germany



Hörmann KG Dissen, Germany



Hörmann KG Eckelhausen, Germany



Hörmann KG Freisen, Germany



Hörmann KG Ichttershausen, Germany



Hörmann KG Werne, Germany



Hörmann Alkmaar B.V., Netherlands



Hörmann Legnica Sp. z o.o., Poland



Hörmann Beijing, China



Hörmann Tianjin, China

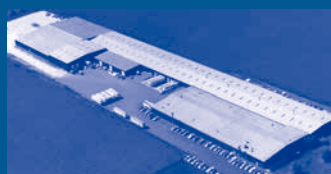

Hörmann LLC, Montgomery IL, USA



Hörmann Flexon LLC, Burgettstown PA, USA



Shakti Hörmann Ltd., India

Hörmann is the only manufacturer worldwide that offers you a complete range of all major building products from one source. We manufacture in highly-specialised factories using the latest production technologies. The close-meshed network of sales and service companies throughout Europe, and activities in the USA and Asia, make Hörmann your strong partner for first-class building products, offering “Quality without Compromise”.

GARAGE DOORS
OPERATORS
INDUSTRIAL DOORS
LOADING EQUIPMENT
HINGED DOORS
DOOR FRAMES

Hörmann (UK) Ltd
Gee Road
Coalville
Leicestershire
LE67 4JW

Tel: 01530 513000
Fax: 01530 513001

www.hormann.co.uk

HÖRMANN