



EDSTROM

**Automated Watering Systems
for Small Animals and Birds**



WATER

The Key Nutrient

As a serious breeder and producer of specialty animals or birds, you understand the importance of supplying clean water at all times. Water is the most critical nutrient in your livestock's diet, making up as much as 85% of the living body and serving many purposes.

An animal can lose nearly all of its body fat and half its protein and stay alive. However, the loss of more than 10% of its water will cause death. Deprivation of water for even a few hours can stress an animal, leading to health problems and reduced performance in breeding stock. In the wild, birds and animals obtain a major portion of their water from the natural foods they consume. Since the prepared feeds used in most facilities are low in moisture content, your animals must drink more water to sustain their daily dietary water requirement.

Providing adequate quantities of clean, fresh water, accessible to the animals 24 hours a day, is crucial to the overall health of your livestock and to the resulting profitability of your production enterprise. Installing an EDSTROM Automated Watering System will accomplish this!



Average Daily Water Requirements	
Animal	Fluid Ounces/Day
Rabbit	5.0
Guinea Pig (Cavy)	3.0
Chinchilla	1.3
Parakeet	0.3
Hamster	0.4
Gerbil	0.1
Rat	1.3
Mouse	0.2
Chicken	10.0
Squirrel Monkey	3.3
Rhesus Monkey	30.0

AUTOMATED WATERING SYSTEMS FOR SMALL ANIMALS AND BIRDS

Table of Contents

How to Succeed with EDSTROM Automated Watering Equipment	2
The EDSTROM Drinking Valve	3
Vari-Flo Drinking Valves	
Original Drinking Valves	
Look Inside the Valve	4
Distribution Piping	5
Flex-Tube System	
Rigid Piping System	
Water Supply Components	7
Pressure Regulator Methods	
Gravity Feed Methods	
Designing an Automated Watering System	11
Installation Methods - Flex-Tube Systems	
Installation Methods - Rigid PVC Pipe Systems	
Installation Methods - Combination Systems	
Systems Guidelines for Startup	16
Operation and Maintenance	17
Specialty Waterers	18
Exotic Bird Watering	19
Cup Waterers for Poultry	19
Trouble Shooting Guide	20
Parts List	21
Drinking Valves	
Specialty Waterers	
Water Supply Components	
Flex-Tube System Components	
Rigid PVC Pipe Components	
Drinking Valve Repair Parts	
EDSTROM Kits	24



mpt	male pipe thread
fpt	female pipe thread
soc	socket
mght	male garden hose thread
fght	female garden hose thread
psi	pounds per square inch (unit of measure of water pressure)
micron	metric unit of measure of length (equals 0.001 millimeters)
ID	inside diameter
OD	outside diameter

ABBREVIATIONS

HOW TO SUCCEED WITH EDSTROM AUTOMATED WATERING SYSTEMS



The EDSTROM Automated Watering System

The EDSTROM Automated Watering System was first introduced in 1967, when Bill Edstrom Sr. designed the unique pivoting stem drinking valve. Its unique, simple design and its rugged, quality manufacture make the EDSTROM Drinking Valve very reliable, providing years of trouble free performance. EDSTROM Drinking Valves are used in thousands of animal and bird facilities around the world.

Success of an Automated Watering System depends on two basic features:

1. *The system must be easy to install.*
2. *The drinking valve must reliably provide water to the animals on demand without leaking.*

There are several manufacturers of watering systems that claim to offer these benefits, but only an EDSTROM Watering System meets this challenge!

An EDSTROM Watering System consists of three basic groups of hardware. Within each group you have several

options available from which to choose. You should review the features of each group. Select components that will easily adapt to your facility and animal husbandry methods.

The three groups are:

Drinking Valves – The drinking valve is the heart of the Automated Watering System. EDSTROM offers several models of patented drinking valves. Each has features that are advantageous to specific types of animals and their housing.

Distribution Piping – The distribution piping is the plumbing component used to carry the water from the water supply to the drinking valves. Two basic methods are offered: a Flex-Tube System and Rigid PVC Piping.

Water Supply Components – The water supply to your Automated Watering System must be clean and at a reduced pressure. A selection of water filtration and pressure reduction plumbing components are available.

THE EDSTROM DRINKING VALVE – VARI-FLO AND ORIGINAL

There are 2 models of EDSTROM Drinking Valves available – the EDSTROM Vari-Flo Valve and the EDSTROM Original Valve. Both models are designed to operate using the patented pivoting stem valve mechanism. You should select the valve that best suits your application.

1. Vari-Flo Drinking Valve

The Vari-Flo Valve is precision machined from solid brass and is available with either 1/8" mpt for PVC pipe system or 3/16" barb for Flex-Tube system connections. The small diameter of the stainless steel stem that the animal must move to release water and the low force required to move it makes this valve ideal for use with even the smallest of creatures, such as weanling mice and finches.

The rate that water is discharged from the Vari-Flo Valve can be adjusted over a wide range to best suit your animals and reduce the spillage of water into the cage as the animal drinks. The rate can be adjusted from a slow trickle, 20 cc per minute, to a strong stream, 100 cc per minute. See



3/16" barb connection
1000-8000

1/8" mpt connection
1000-8010

2. Original Drinking Valve

The Original Drinking Valve is slightly larger than the Vari-Flo Valve. It is constructed with thicker materials, making it the preferred valve for use with larger gnawing animals (i.e. rabbits, chinchillas). This brass valve has a stainless steel stem and is available with either 1/8" mpt or 3/16" barb connection. See Figure 3.

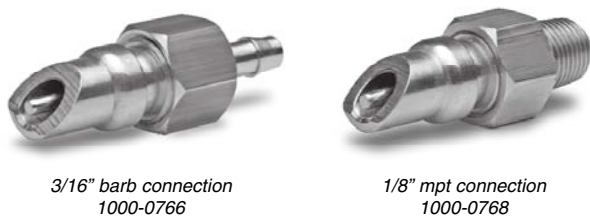

3/16" barb connection
1000-0766

1/8" mpt connection
1000-0768



Figure 1
Vari-Flo Drinking Valve Series

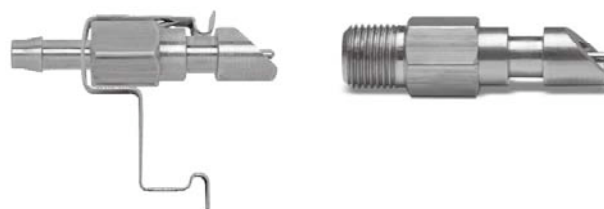

Vari-Flo Valve 1000-8000
3/16" barb connection
with Valve Clip 1100-7440

Vari-Flo Valve 1000-8010
1/8" mpt connection

Figure 2
Adjusting the Vari-Flo Valve

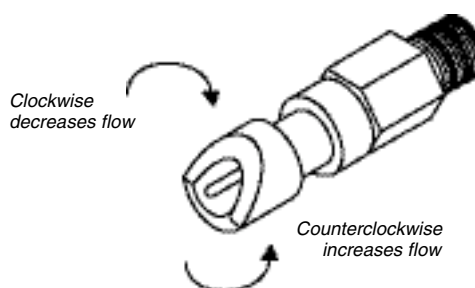

Clockwise
decreases flow

Counterclockwise
increases flow

Figure 3
Original Drinking Valve

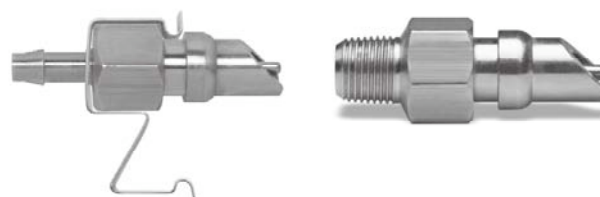

Original Valve 1000-0766
3/16" barb connection
with Valve Clip 1100-0867-100

Original Valve 1000-0768
1/8" mpt connection

LOOK INSIDE THE VALVE – RUGGED, SIMPLE DESIGN

See How EDSTROM Drinking Valves Work

The pivoting stem design used in all EDSTROM valves is easy to understand when you look at the exploded view and cross sectional drawings of the valve. See Figures 4 and 5.

The sealing force in EDSTROM drinking valves comes from a silicone rubber diaphragm which provides the pressure necessary to hold the valve closed. This prevents water from flowing under the stem head and out of the valve. Water is released only when the end of the stem is moved in any direction by biting, licking or pecking. This causes one side of the stem head to lift off the O-ring, allowing water to flow under it and out to the animal's mouth or beak.

When the animal releases the end of the stem, the elasticity of the silicone rubber diaphragm located behind the stem head pushes the head back to the closed position, stopping the flow of water.

The Many Advantages and Benefits of this Simple Valve Design

- The valves are extremely resistant to leaks since a soft O-ring provides the water shut-off seal. Dissolved minerals in the water (hard water and iron) do not cause the valve to leak as with other types of waterers. However, we do recommend that particles in the water be removed by filtration. See *Water Supply section*.
- The EDSTROM Valve can be easily disassembled for clean-ing or replacement of parts.
- The EDSTROM Valve is not sensitive to water supply pressure. It will operate with pressures as low as 1/8 psi and as high as 10 psi. At higher pressures the force required to actuate the valve increases. An operating pressure of 3 to 5 psi is recommended for easy operation by most species.
- The pivoting head of the valve is held tightly closed by the elasticity of the silicone diaphragm, preventing possible backflow of water and contamination into the water supply line to the rest of your facility.
- A small droplet of water normally remains at the end of the valve after its operation. Animals and birds quickly locate this water, and in their efforts to drink it, move the stem, releasing more water to drink. They train themselves to drink from the EDSTROM Valve in no time at all.

Figure 4
Exploded view of the EDSTROM Vari-Flo Drinking Valve

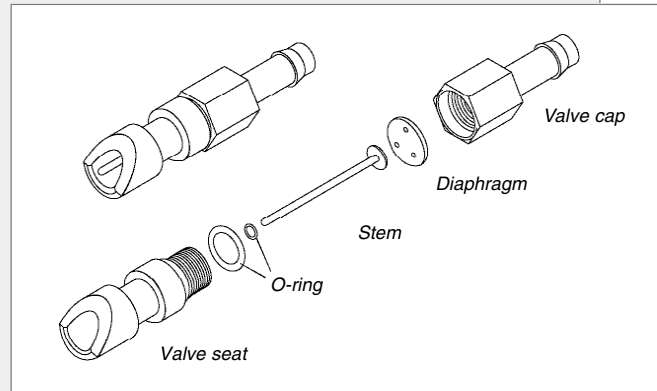
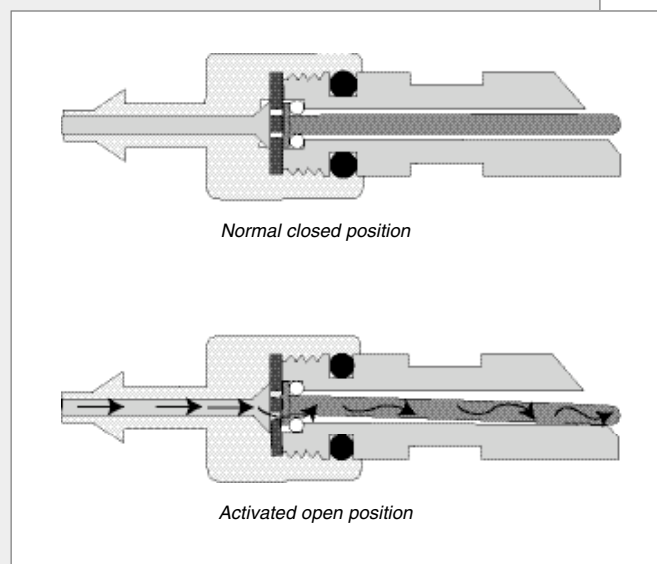

Figure 5
Cross section view in closed and open position



DISTRIBUTION PIPING – FLEX-TUBE SYSTEM

As described in the previous section, the EDSTROM Drinking Valves are offered with two connection styles. The models with 3/16" barb connection are for use with the Flex-Tube distribution system. The valves with 1/8" mpt connection are used in Rigid PVC pipe distribution systems. Your selection of either the Flex-Tube

System or the Rigid PVC pipe system will be determined by:

1. *The type of caging layout that you have and...*
2. *The amount of effort and degree of skill you have for installing equipment.*

Flex-Tube System

The Flex-Tube Piping System is a very easy way to install an automated watering system that mounts directly to the outside of wire mesh cages. See Figure 6.

Easy To Install – no drilling or glue required

The only tool required for installation is a scissors to cut the soft plastic tubing to length. The system is assembled by simply pushing the tubing onto the barb ends of the connector fittings and is snapped onto the cages using the special stainless steel mounting clips.

Black Tubing – prevents algae growth in water lines

The tubing used in the Flex-Tube System is a soft, non-toxic plastic material. Because the tubing is black, it blocks light, preventing algae growth.

Flexible Layout – easily rearranged or expanded

A complete selection of barb connector fittings is available, permitting you to assemble your Flex-Tube System in any required configuration. The system can be easily rearranged, expanded, or taken down.

Figure 6
Flex-Tube mounting on a cage front

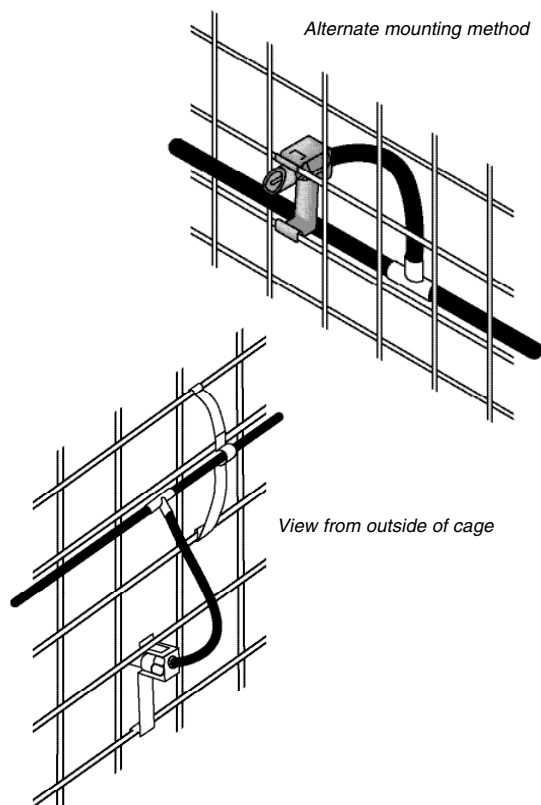
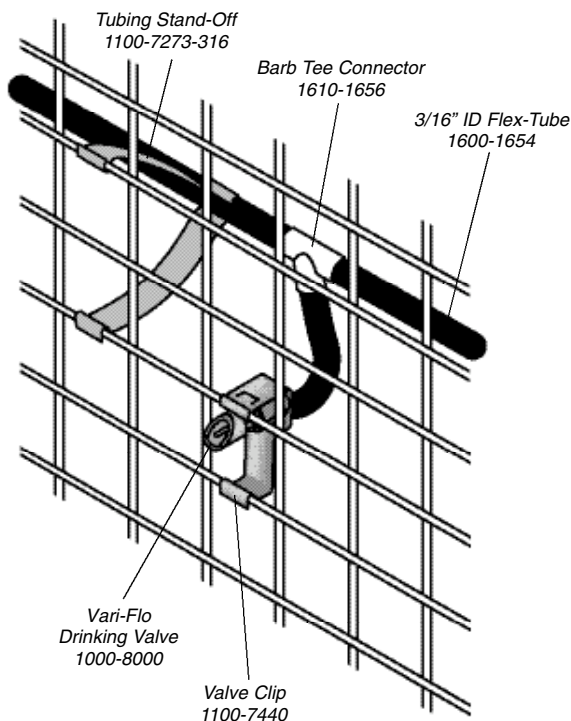

DISTRIBUTION PIPING – RIGID PVC PIPING SYSTEM

Rigid Piping System

A distribution piping system can be made using standard 1/2" PVC Pipe and fittings used for household plumbing systems. It is assembled by gluing the joints together. See Figure 7.

A distribution system constructed of PVC pipe is a very rugged system, which can withstand much animal/bird abuse.

The pipelines can be permanently mounted to the walls or directly to the sides of the cages. The system is assembled with basic do-it-yourself plastic plumbing methods: PVC pipe and fittings are glued together with special solvent cement. The PVC pipe is cut to length with a pipe or tubing cutter (do not use a saw, as this produces particles of plastic which can fall inside the pipe and eventually be carried

Figure 7
Easy to Install Rigid PVC Piping System

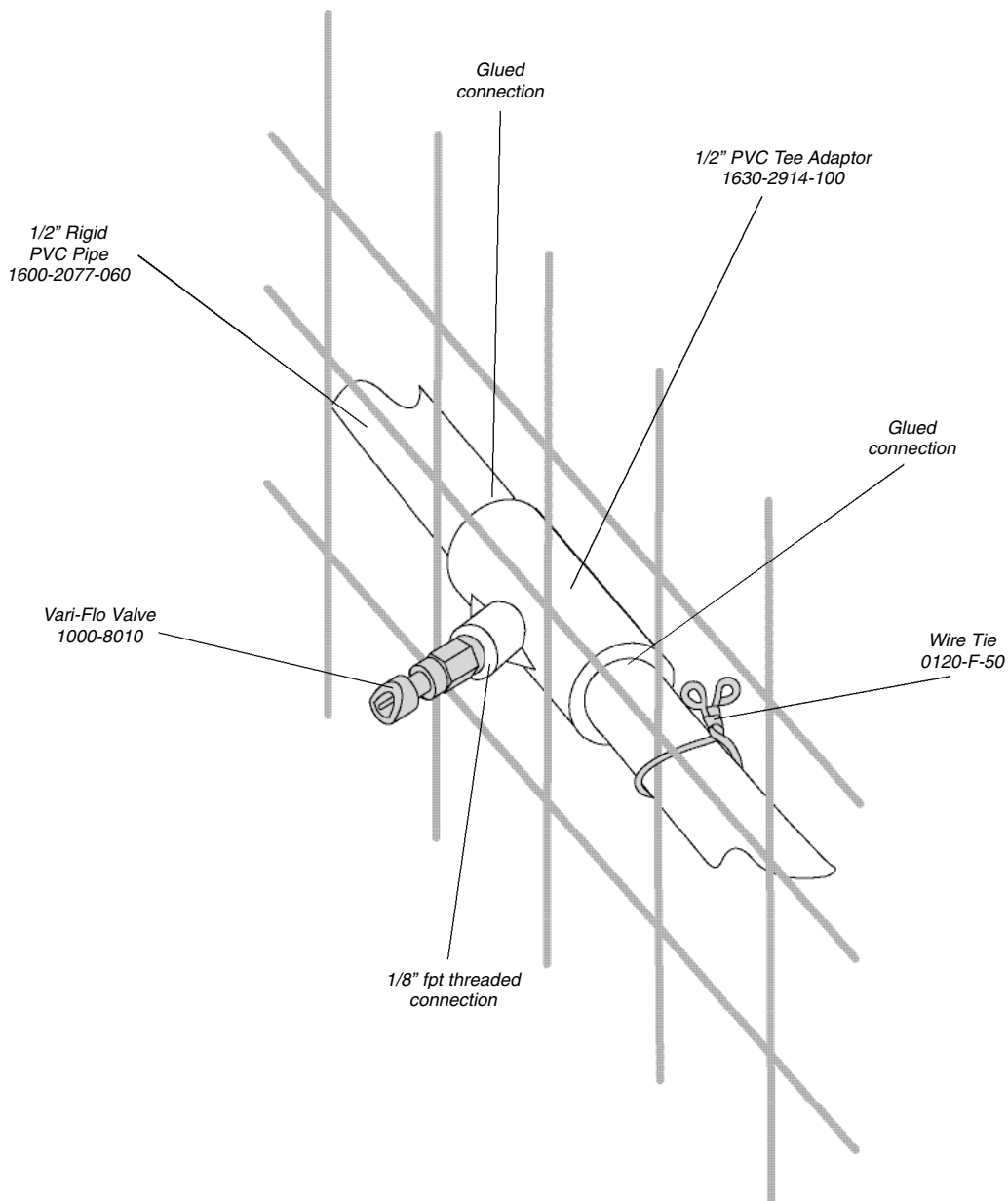

WATER SUPPLY – PRESSURE REGULATORS

The water being supplied to your EDSTROM Automated Watering System must be clean and at a controlled, reduced pressure of 1/2 psi to 5 psi. The normal household or farmstead water system usually operates at a pressure of 20 psi to 60 psi, so your automated watering system cannot be connected directly to the nearest garden hose spigot.

EDSTROM offers a selection of components which allow you to supply water continuously at the required reduced pressure. Select the method that best adapts to your facility.

Pressure Regulator Method

A convenient and reliable method of providing water at reduced pressure to your watering system is with a pressure regulator. This device connects directly to your house water supply and as water flows through, it reduces high water pressure to the low pressure required for your watering system. The advantage of this method is that it makes your watering system fully automated – no gravity supply tanks to monitor and fill. In addition, because the flow of water is always confined in the pipeline, there is no chance of contamination and there are no open tanks to keep clean.

The pressure regulator offered by EDSTROM Industries accurately maintains the outlet pressure over a wide flow handling range. The unit is tested and preset at the factory for an outlet pressure of 3 psi; however, the outlet pressure is adjustable from 3/4 psi to 10 psi.

EDSTROM offers three Pressure Regulator Kits:

Pressure Regulator, 7450-6114

This pressure regulator is designed to connect directly to your garden hose spigot. A 142 micron strainer is built into the inlet garden hose thread fitting. Outlet connections are provided for connecting to either 3/16" or 5/16" Flex-Tube lines. See Figure 8.

The pressure regulator can be used to supply up to 600 drinking valves. The pressure regulator should be mounted at approximately the same level as the drinking valve line to avoid pressure differential due to elevation difference.

Local plumbing codes may require that you install an Auto-Air Break Valve at the point you connect your automated watering system to your domestic water supply. Use an approved device for this purpose.

Installation Tip

Figure 8
Installation of Pressure Regulator

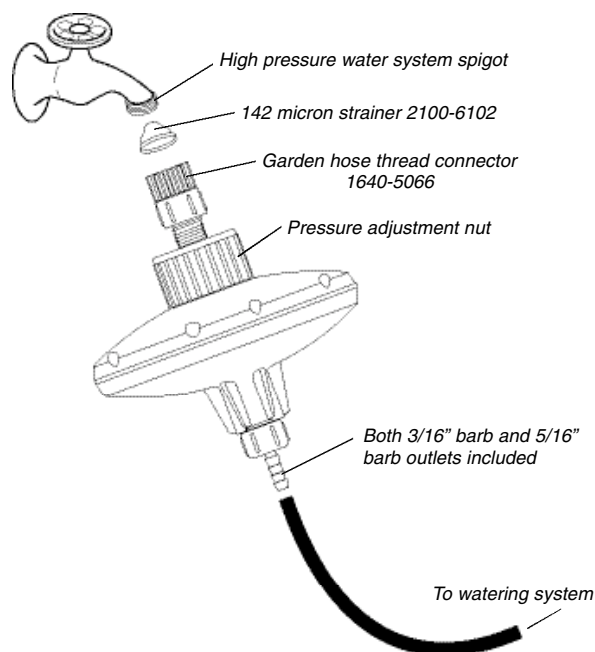

WATER SUPPLY – PRESSURE REGULATORS

Basic Pressure Regulator/Filter Station, 7450-5452-001

This station is a wall mountable unit that includes a high capacity flushable filter ahead of the pressure regulator. The filter has a large, cleanable 80 micron screen. (For more details refer to the description of a flushable filter on page 10.) A pressure gauge provides a visual readout of the operating water pressure. Also included with the regulator/filter station is a 10-ft long inlet hose assembly to connect the station to the spigot. Outlet connections are included for 3/16" or 5/16" Flex-Tube, or 3/4" mpt. See Figure 9.

Figure 9

Installation of Pressure Regulator/Filter Station

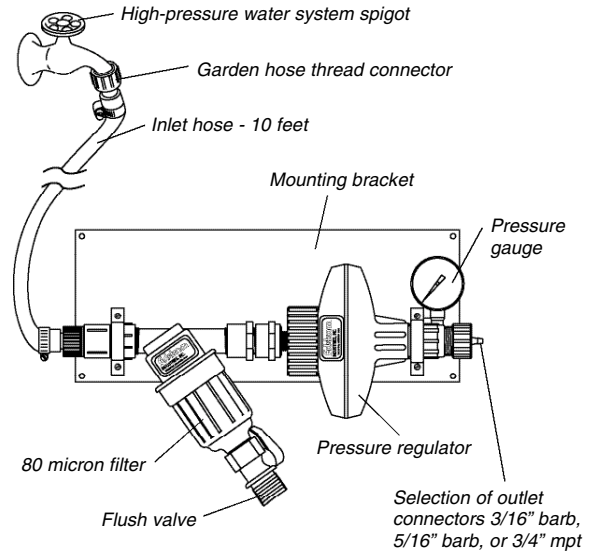

Deluxe Pressure Regulator/Filter/Injection Port Station, 7450-5452-002

This Deluxe Station is identical to the Basic Station described above except the Deluxe Station includes injection port valves. These valves permit you to turn off the fresh water supply and connect a temporary supply of medicated or chlorinated water. The injection hose and tank connector are included with the station. See Figures 10(a) and 10(b).

Figure 10(a)

Installation of Deluxe Pressure Station

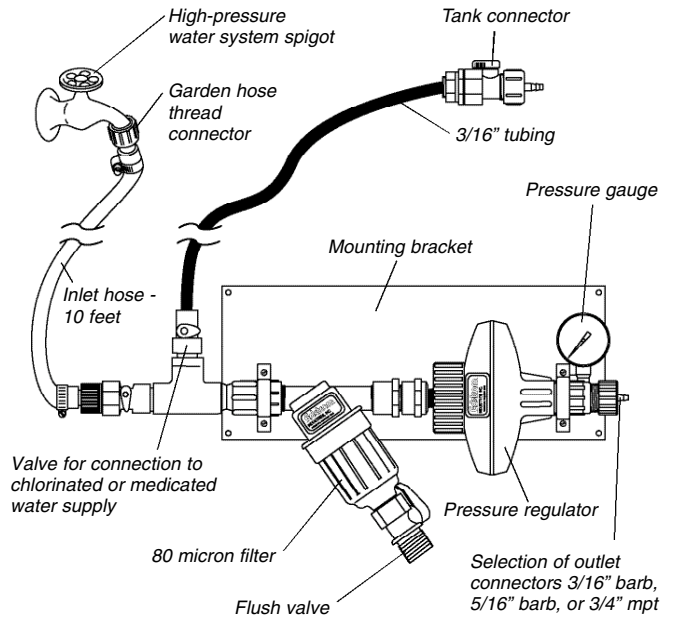
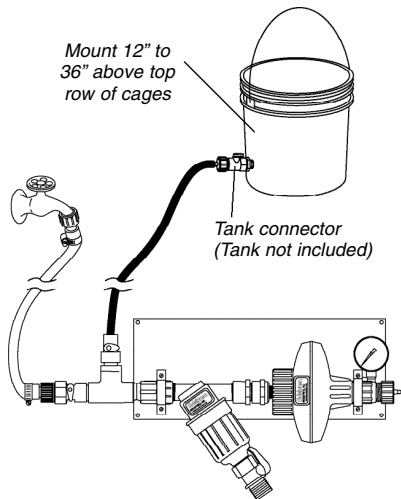

Figure 10(b)
Medication Injection Hose Assembly Included with Deluxe Station



WATER SUPPLY – GRAVITY FEED METHODS

Gravity Feed Method

The simplest method of providing water at reduced pressure to your automated watering system is to connect to a supply tank of water suspended higher than the drinking valves. By the force of gravity the water will flow from the tank, through the distribution line to the drinking valves. The higher the tank is above the drinking valves, the higher the water pressure. (Each 14" of elevation of the water supply above the drinking valve produces 1/2 psi of water pressure at the drinking valve.) The capacity of the tank and the number of gallons has no effect on the pressure produced in the watering system. See Figure 11.

Installation Tip

Normally a gravity supply tank is mounted 12" to 36" above the top row of cages.

A maximum of 75 drinking valves should be supplied by a gravity supply tank.

Figure 11
Gravity Feed Method

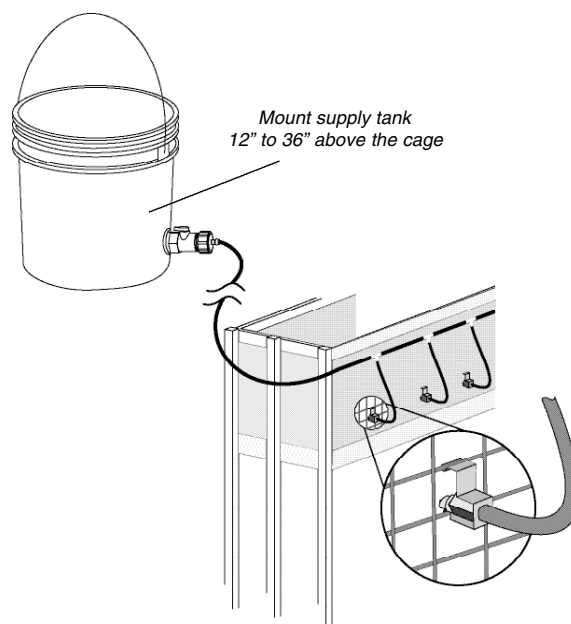

EDSTROM offers three Gravity Supply Options:

Tank Connector, 7450-6115-200 or 7450-6115-516

The tank connector is designed to connect to the side wall of your water supply tank or pail. It provides an outlet for connecting the 3/16" or 5/16" Flex-Tubing and has a shut-off valve and a built-in 142 micron strainer. See Figure 12.

You should select a tank with the capacity to hold a 24 hour supply of water for your facility. The tank should not be of excessive capacity because you don't want the water supply to become stagnant. It is best to fill the tank with fresh water each day.

Your tank should have a lid to prevent dirt from falling into the clean water. Be sure the lid does not fit too tightly on the tank as to be air-tight; the tank must be able to draw in air as the water drains out. If the lid is tight, you will need to drill a small vent hole in the side of the tank near the top. To install the tank connector on your tank drill an 11/16" diameter hole in the side of the tank.

Figure 12
Installation of Tank Connector

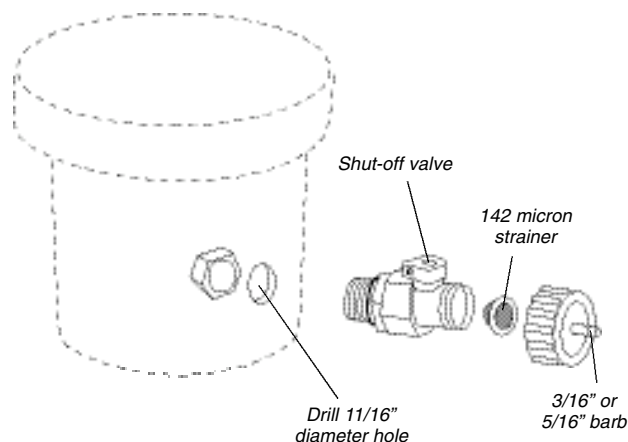

WATER SUPPLY – GRAVITY FEED METHODS

Storage Tank, 7450-6126

The storage tank is a complete gravity supply tank assembly. The tank is a one gallon pail with its own lid. It includes the tank connector, 7450-6115-200, described on page 9. See *Figure 13*.

Figure 13

Storage Tank

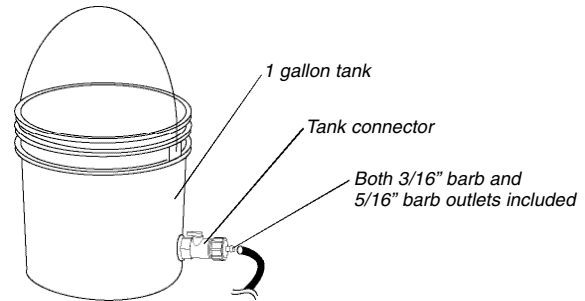

Float Tank, 7450-5069-002

The float tank is best described as a self-filling gravity supply tank. The float tank is equipped with a float valve which keeps the water in the tank at a constant level. This float valve is connected directly to your house water supply.

The float tank consists of a one gallon pail and lid, an outlet fitting assembly, a float valve and 10-foot long inlet hose for connecting to your garden hose spigot. A 142 micron strainer is provided in the inlet connection. See *Figure 14*.

Figure 14

Installation of Float Tank

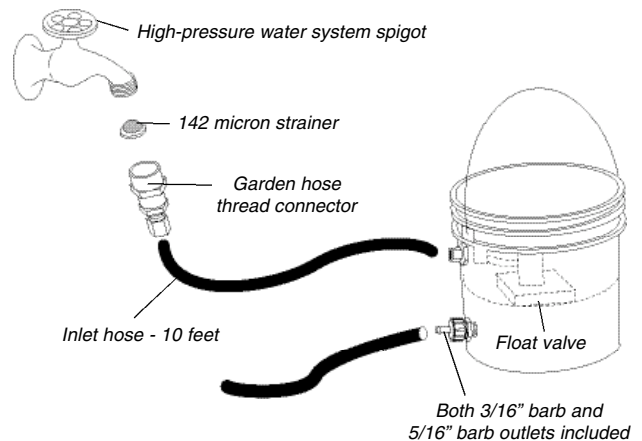

Installation Tip

If your water supply contains a lot of sediment and this strainer plugs up regularly, you should install the Flushable Filter, 2100-6120-200, (See below) on your supply spigot.

Water Filtration

Flushable Filter, 2100-6120-200

If your water supply contains a heavy load of particulates, the 142 micron washer strainer provided in EDSTROM's water supply equipment will plug quickly and require frequent cleaning. In such cases, it is recommended that the flushable filter unit, 2100-6120-200, be installed on your water supply. The flushable filter has an 80 micron cleanable filter cartridge that provides maximum protection to your automated watering system. The filter cartridge can be easily cleaned by opening the valve at the base of the filter bowl and allowing the water to flush the cartridge.

Note: This flushable filter is a component of the pressure regulator/filter stations on page 8.

Figure 15

Flushable Filter

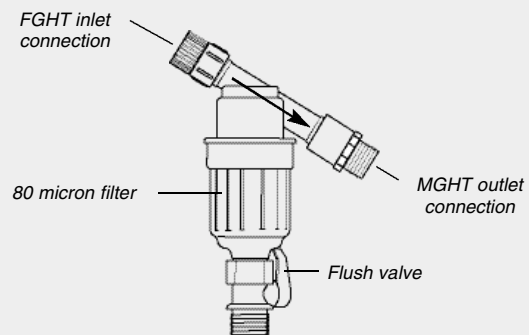

DESIGNING YOUR AUTOMATED WATERING SYSTEM

To determine the components that you will need to install an Automated Watering System in your animal facility, you should first review the installation methods below and the options detailed on pages 12 to 15. After deciding which basic installation method will work in your facility, you must select and determine the quantity of all components required.

You may find it helpful to draw a layout of your facility and cage arrangement to scale on graph paper. This will make it easier to calculate the length of the distribution piping lines, as well as the quantity of fittings and drinking valves.

As you prepare your list, be sure you select the proper components from each of the basic groups in a watering system:

Drinking Valve

Distribution Piping

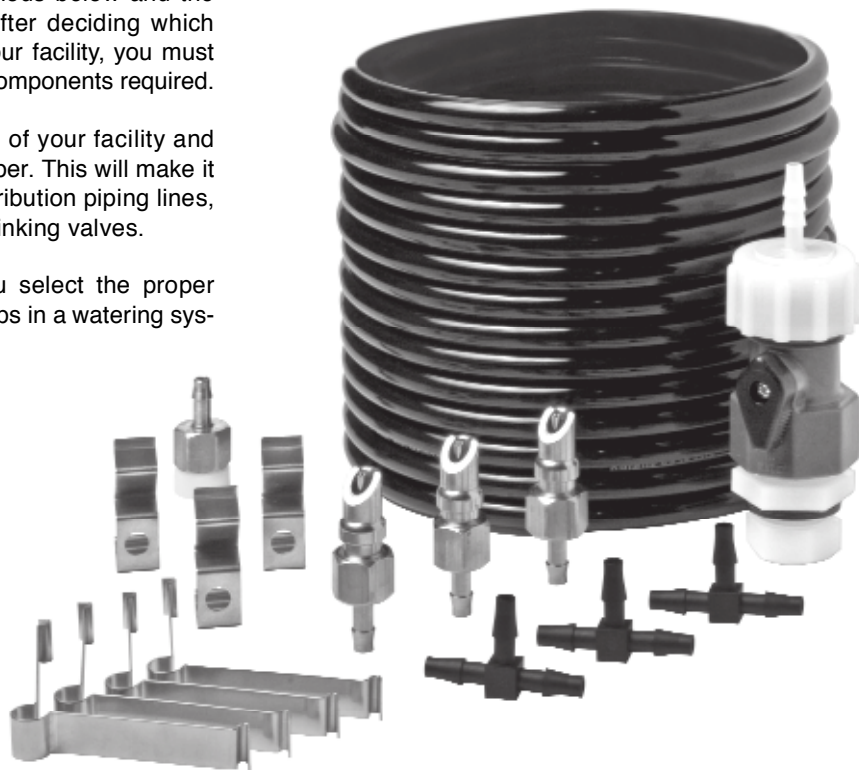

Installation Methods

Whether you select to set up your automated watering system using the Flex-Tube Piping System, Rigid PVC Piping System or a combination of both, there are several basic system design principles you need to consider as you do your layout and prepare your parts list:

1. Place the drinking valves on the side of the cage at a location and height that the animal can easily reach. The drinking valve should not be located in the nesting area, nor should it be located immediately above the feeding station.
2. Run lateral lines as near horizontal as possible; avoid going up and over an obstacle and back to horizontal. The reason for this is to avoid high points in the line where air pockets can form, which cannot be easily flushed out.

Lateral lines are the piping lines that run the length of the cages and to which the drinking valves are connected. Header lines are used to interconnect multiple lateral lines

to the water supply.

3. All lines should be laid out and installed with a drain valve at the end. On initial start-up, these drain valves must be opened to allow the water to fill the lines and push out all the air inside the lines. In addition, good management practice requires that you flush the water lines once a week to ensure the freshness of the water to your animals. (*Refer to Operation and Maintenance, Page 17*).
4. In larger facilities requiring long runs of piping lines, the water supply (gravity tank or pressure regulator) should be located centrally. This assures balanced water pressures throughout the system.
5. The lengths of the lateral lines and the number of drinking valves connected to the lateral lines should not exceed the recommendations for the option of distribution piping and water supply selected. Exceeding these limits can result in reduced water discharge rates from the drinking

INSTALLATION METHODS – FLEX-TUBE SYSTEMS

EDSTROM 3/16" Flex-Tube System – for cage rows up to 50 feet long

Figure 16 shows an example of a design layout sketch for an Automated Watering System for cages arranged on shelves or a rack structure with one or more tiers. Most commonly, the Flex-Tube system is mounted along the front of the cages. The lateral line is located either on the top or along the bottom of the cage row to avoid interference with doors or feeders.

Table 1 – 3/16" Flex-Tube System Components

Average Quantity of Components Needed Per Cage					
Cage Width	18"	24"	30"	36"	48"
Drinking Valve, 1000-8000	1	1	1	1	1
Valve Clip, 1100-7440	1	1	1	1	1
- or -					
Drinking Valve, 1000-0766	1	1	1	1	1
Valve Clip, 1100-0867-100	1	1	1	1	1
Tee Connector, 1610-1656	1	1	1	1	1
Tubing Stand-Off, 1100-7273-316	1	2	2	2	3
3/16" Flex-Tube, 1600-1654 (includes 12" length piece to each valve)	2.5 ft	3 ft	3.5 ft	4 ft	5 ft

For each lateral line include:

- One Drain Valve, 2020-1125
- One Additional Tubing Stand-Off, 1100-7273-316
- One Shut-Off Valve, 2000-4510-316, per lateral line, optional
**Don't forget to add 3/16" flex-tube from your water supply to your system*

IMPORTANT

Figure 16

3/16" Flex-Tube System on cage, front view of stacked cages

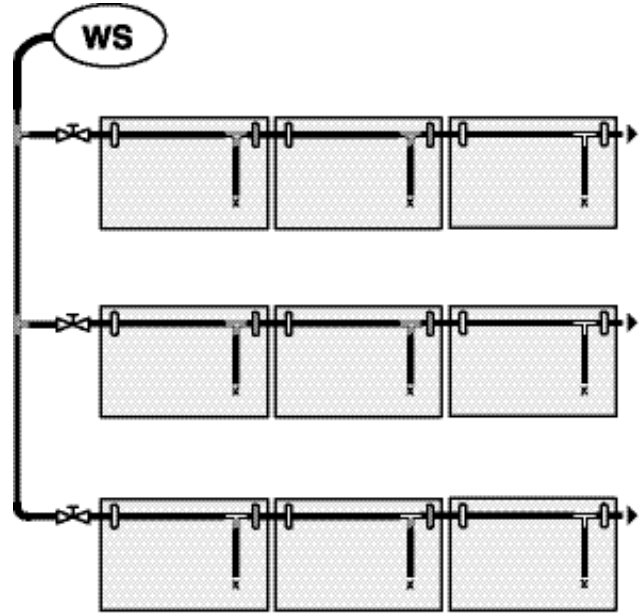

Legend and Layout Guidelines

- WS** Water Supply – Either a Pressure Regulator or a Gravity Supply can be used. If a Gravity supply is used, mount the tank 12" to 36" above the top row of cages.
- X** Drinking Valve with 3/16" barb connection 1000-8000 or 1000-0766 (one per cage). Valve Clip, 1100-7440 or 1100-0867-100 (one per valve).
- T** Tee Connector, 1610-1656 (one per valve).
- Tubing Stand-Off, 1100-7273-316 – Install one clip at each tee and one every 18" for additional support. Do not space support clips further than 18" apart.
- 3/16" Flex-Tube, 1600-1654 – When calculating the footage required, DON'T FORGET to include the short lengths required to make the connection from the tee fitting to the drinking valves. Maximum number of drinking valves supplied by a single line is 75. Maximum length of a lateral line is 50 ft.
- ⊘** Shut-off Valve, 2000-4510-316 (optional). One per lateral line.

INSTALLATION METHODS – FLEX-TUBE SYSTEMS

EDSTROM 5/16” Flex-Tube System –

For larger facilities having cage rows over 50 ft long and/or requiring over 75 drinking valves, the 5/16” Flex-Tube System provides the answer. The larger diameter 5/16” flex-tube, with its higher water capacity, is used for the lateral lines with 3/16” Flex-Tube used at each tee to connect to the drinking valve. *Figure 17* shows a typical layout.

Table 2 – 5/16” Flex-Tube System Components

Average Quantity of Components Needed Per Cage					
Cage Width	18”	24”	30”	36”	48”
Drinking Valve, 1000-8000	1	1	1	1	1
Valve Clip, 1100-7440	1	1	1	1	1
Drinking Valve, 1000-0766	1	1	1	1	1
Valve Clip, 1100-0867-100	1	1	1	1	1
Tee Connector, 1610-5174-355	1	1	1	1	1
Tubing Stand-Off, 1100-7273-380	1	2	2	2	3
5/16” Flex-Tube, 1600-K-30	1.5 ft	2 ft	2.5 ft	3 ft	4 ft
3/16” Flex-Tube, 1600-1654	1 ft	1 ft	1 ft	1 ft	1 ft

For each lateral line include:

- One Drain Valve, 2020-3095-516
 - One Additional Tubing Stand-Off, 1100-7273-380
 - One Shut-Off Valve, 2000-4510-516, per lateral line, optional
- *Don't forget to add 5/16” flex-tube from your water supply to your system*

IMPORTANT

Figure 17
5/16” Flex-Tube System on cage

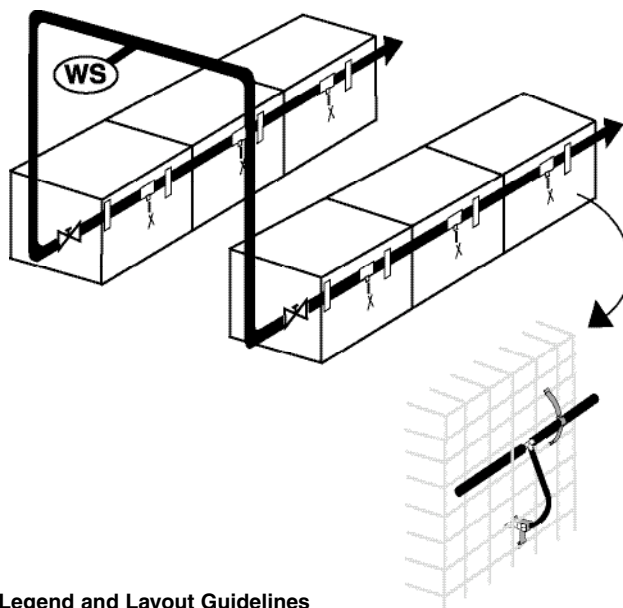

Legend and Layout Guidelines

- WS** Water Supply – A pressure regulator can supply up to 600 drinking valves when connected to multiple lines. If a gravity supply is used a maximum of 75 drinking valves can be supplied.
- X** Drinking Valve, 1000-8000 or 1000-0766, with 3/16” barb connection (one per cage). Valve Clip, 1100-7440 or 1100-0867-100 (one per valve).
- T** Tee Connector, 1610-5174-355, 5/16” barb x 5/16” barb x 3/16” barb (one per valve).
- Tubing Stand-Off, 1100-7273-380 – Install one clip at each tee and one every 18” for additional support. Do not space clips further than 18” apart.
- 5/16” Flex-Tube, 1600-K-30 – Used for lateral line. Maximum number of drinking valves supplied by a single line is 200 total. Maximum length of a lateral line is 100 ft. **DON'T FORGET** to include tube from water supply line to your system.
- 3/16” Flex-Tube, 1600-1654 – Used for the short connection between the tee connector and the drinking valve.
- ⊗** Shut-Off Valve, 2000-4510-516 – Optional one per lateral line.
- ▶** Drain Valve, 2020-3095-516 – One at end of each lateral line.

INSTALLATION METHODS – RIGID PVC PIPE SYSTEM

Typical Rigid PVC Pipe Layout –

for cage rows up to 200 feet long

Rigid PVC pipe can be used for large facilities requiring lines over 100 ft or having over 200 drinking valves. Rigid PVC pipe is the preferred piping system for animals and birds that have the agility and strength to pull the Flex-Tube System off the cage. *Figure 18* shows a typical layout with rigid PVC pipe.

Table 3 – Rigid PVC Pipe Layout Components

Average Quantity of Components Needed Per Cage					
Cage Width	18"	24"	30"	36"	48"
Drinking Valve, 1000-8010	1	1	1	1	1
- or -					
Drinking Valve, 1000-0768	1	1	1	1	1
Tee Adaptor Fitting, 1630-2914-100	1	1	1	1	1
Wire Pipe Tie, 0120-F-50	1	1	1	1	2
1/2" PVC Pipe, 1600-2077-060 (5 ft. section)	1.5 ft	2 ft	2.5 ft	3 ft	4 ft

For each lateral line include:

One Drain Valve, 2000-4043 and 1630-9028-001, one at the end of each lateral line

One Shut-Off Valve, 2000-H-900, per lateral line, optional
**Don't forget to add 1/2" PVC pipe from your water supply to your system*

IMPORTANT

IMPORTANT Assembly Tip

Do not use a saw to cut the PVC pipe to length. This produces many fine particles of plastic which fall inside the pipe, are very difficult to flush out and later can become lodged in the Drinking Valve, causing leaks.

Use EDSTROM's Pipe Cutter Tool, 0129-HV-100.

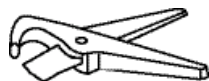
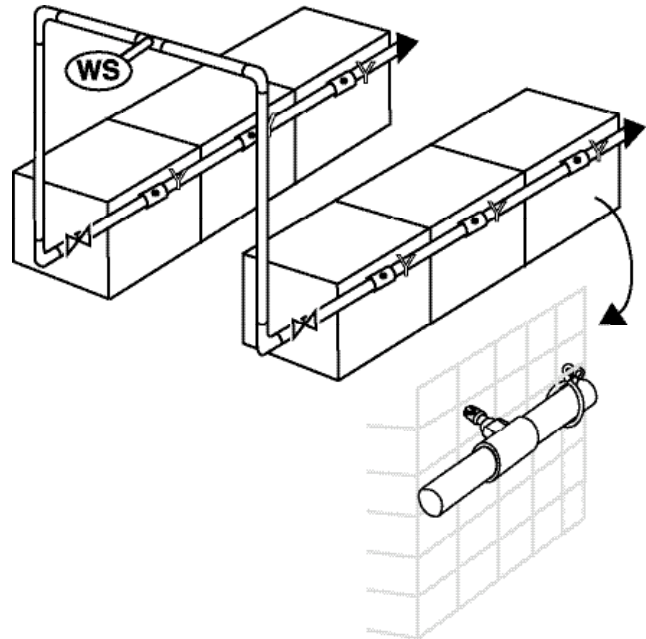







Figure 18

Rigid PVC Pipe System on Cages



Legend and Layout Guidelines

-  Water Supply – A Pressure Regulator can supply up to 600 Drinking Valves. If a Gravity Supply is used a maximum of 75 Valves can be supplied. (A Flex-Hose Hookup Kit, 7450-5400, is available to make the connection between the water supply and the rigid PVC piping.)
-  Drinking Valve, 1000-8010 or 1000-0768, with 1/8" mpt connection (one per cage). Tee Adaptor Fitting, 1630-2914-100, 1/2" soc x 1/2" soc x 1/8" fpt (one per valve).
-  1/2" PVC Pipe, 1600-2077-060 (5-ft section). Maximum number of drinking valves supplied by a single line is 600. The maximum length of a lateral line is 200 ft.
-  Wire Pipe Tie, 0120-F-50 (one per valve). The pipe should be supported every 36" or less; install additional supports as required.
-  Drain Valve, 2000-4043 and 1630-9028-001 – One at the end of each lateral line.
-  Shut-Off Valve, 2000-H-900 1/2" soc x 1/2" soc – Optional one per lateral line.

Refer to the Parts List on page 23 to select the components for your rigid PVC piping.

INSTALLATION METHODS – COMBINATION SYSTEMS

Combination Rigid PVC/Flex-Tube Plumbing Systems

In some facilities it may prove advantageous to install the plumbing for the Automated Watering System using a combination of Rigid PVC pipelines and/or Flex-Tube lines.

In larger facilities having multiple racks of small cages, it is suggested that larger diameter piping, either the 5/16" Flex-Tube or 1/2" Rigid PVC, be used for the distribution piping

around the room walls with outlets for connecting each rack of cages. The rack of cages can then be set up with the standard 3/16" Flex-Tube System connected to the outlet in the distribution piping. In the two drawings below, the two methods are shown and the special components required are identified. See Figures 19 and 20.

Figure 19

5/16" Flex-Tube Distribution Line with 3/16" Flex-Tube Cage Lines

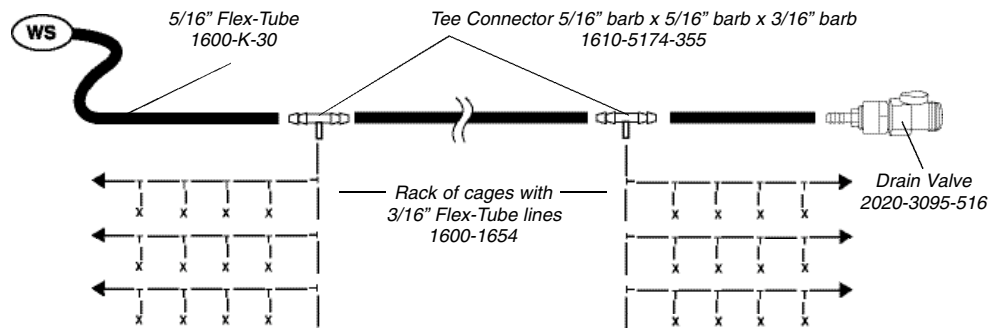
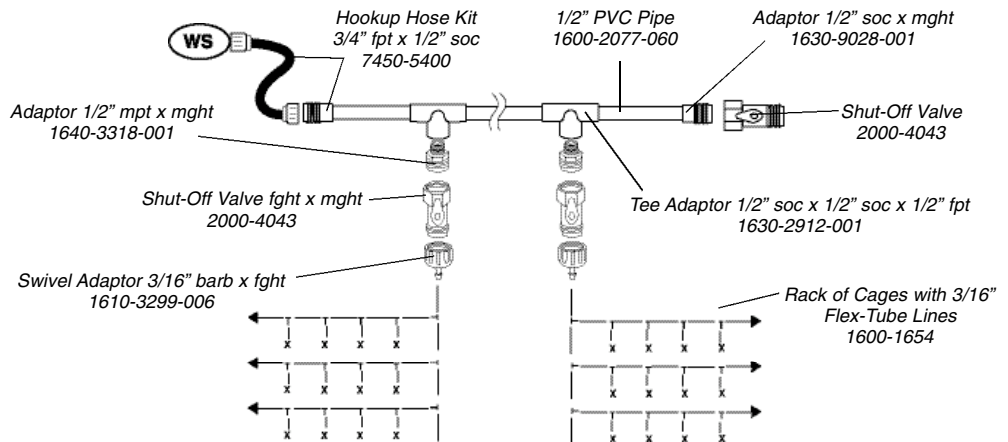

Figure 20

1/2" Rigid PVC Distribution Lines with 3/16" Flex-Tube Cage Lines



Another variation of the combination plumbing system is the use of Rigid PVC pipe for the cage lines, and 5/16" Flex-Tube for the interconnecting and distribution lines. Figure 21 shows an example of such an arrangement and the special fittings that are available.

Figure 21

5/16" Flex-Tube Distribution Lines with 1/2" Rigid PVC Cage Lines

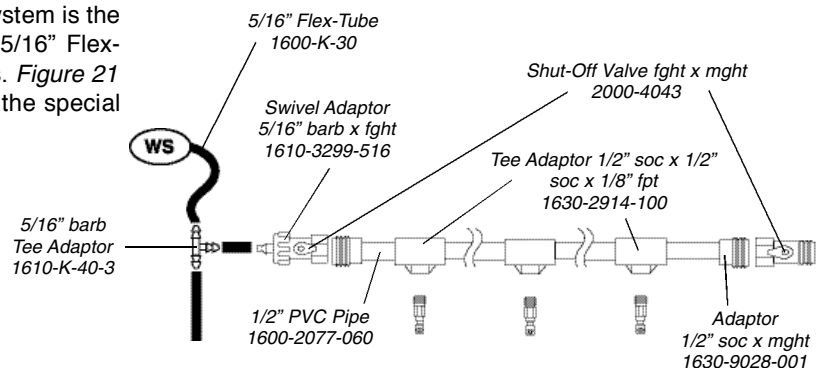

SYSTEMS GUIDELINES FOR STARTUP

■ **Flushing the Lines** – On initial hookup of the water supply to a newly installed piping system, all the lines should be thoroughly flushed to remove any particles of dirt or debris that may have fallen inside the pipe lines during assembly. If the lines are not flushed, then these particles will be carried into the drinking valve, where they may become lodged on the seal and cause a leak.

To flush the line, open the drain valve at the end of the line, and allow water to flow out for several minutes. Repeat this procedure for each drain valve in your system. Start on the lines that are closest to the water supply and work your way to those farthest away.

■ **Actuate each Drinking Valve** – To confirm the proper actuation of the drinking valves, each one should be manually actuated and the flow of water observed. In Flex-Tube installations, air trapped in the short length of the Flex-Tube connection between the Valve and the lateral line must be pushed out before water begins to flow evenly.

■ **Sanitizing the Plumbing System** – For household potable water systems it is good plumbing practice to sanitize the lines on start-up to eliminate bacteria in the pipe lines. This is also a good practice to follow for your automated watering system. Sanitization of the lines can be easily done by filling them with a chlorine solution and allowing to stand for at least 30 minutes. It is recommended that the chlorine solution have a concentration of 5 to 10 parts per million (ppm). This will not harm the animals/birds if they should drink it. (Normal municipal water supplies have chlorine levels of 0.5 to 2 ppm.)

You can easily prepare a chlorine solution by mixing household chlorine bleach and water. A solution of 1/2 teaspoon per 7 gallons water will produce a solution of approximately 5 ppm. Use EDSTROM's Chlorine Test Kit, 2400-6683, which has a range of 0 to 20 ppm, or 2400-6684 (0 to 3.5 ppm) to test your mix.

The method of filling your pipelines with the sanitizing solution will depend on the water supply method you are using. If a storage tank is used, you can fill it directly with the sanitizing solution. If a float tank is used, the fresh water supply must be shut off, and then the tank must be filled with the solution. If the basic pressure station is used, it can be temporarily disconnected and a storage tank, filled with the solution, connected in its place. With the deluxe pressure regulator station, a temporary storage tank can be connected directly to the injection port and the fresh water supply turned off. See *Figures 22 and 23 on page 17*.

Once you have the sanitizing solution as your water supply, you should flush each line just long enough to fill it with the solution. Then allow the system to sit for at least 30 minutes before flushing the lines with fresh water.

■ **Confirm that your Animals/Birds are Drinking** – After installing your automated watering system, you must make sure that your livestock learn to use the drinking valve. To get them trained you must first remove other water sources from the cage. During the next 24 hours observe them carefully to determine if they are using the drinking valves. If you feel they are not finding and learning to use the drinking valve, manually activate the valve in front of them allowing a drop of water to “hang” from the valve. Continue to carefully observe them to confirm they have learned to drink.

Raisers of all types of animals and birds normally report very little problem getting their animals/birds to learn to drink. However, it is your responsibility to confirm that your livestock are drinking from your automated watering system.



OPERATION AND MAINTENANCE

■ **Routine Operation Check** – It is recommended that you routinely check the operation of all drinking valves in your operation as part of your normal animal husbandry procedures.

■ **Regular Flushing and Sanitization of the System** – Because smaller animals and birds drink such a small amount of water, the total flow of water through the system is very low. To ensure the freshness of the water in your lines, all lines should be flushed at least once a week. Refer to the procedure for flushing the lines in the Startup Section on page 16.

In addition, to eliminate the chance for bacterial or algae growth in the system it should be sanitized at least twice a month. This is especially important if your fresh water supply is not chlorinated.

■ **Use of Medications and Vitamins in the Water Supply** – Most water soluble medications and vitamins recommended for use in the animal drinking water can be dispensed through the automated watering system. Whenever an additive is put in the water supply, care must be taken to confirm that it completely dissolves and stays in suspension in the water to avoid potential problems with residues fouling the operation of the drinking valves.

There are several methods for feeding medicated water into your automated watering system. If a storage tank is being used the tank can simply be filled with the medicated water solution. If a float tank is being used, the fresh water supply line can be shut off and the tank filled manually with the medicated solution. If a basic pressure regulator station is used, it can be temporarily disconnected, and a storage tank filled with the solution connected in its place. See Figure 22. The Deluxe Pressure Station has injection port valves which permit turning off the fresh water supply and connecting a temporary storage tank of medicated solution to supply the system. See Figure 23.

After completing the dosing of the medication or vitamins, the system should be flushed and sanitized to remove any residues from inside the lines. If not removed these residues can promote bacterial growth in the water lines.

Figure 22
Storage tank used as a temporary supply of medicated solution

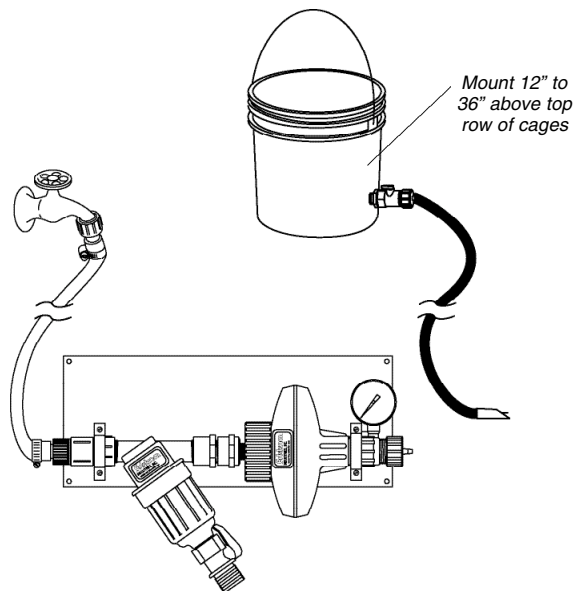
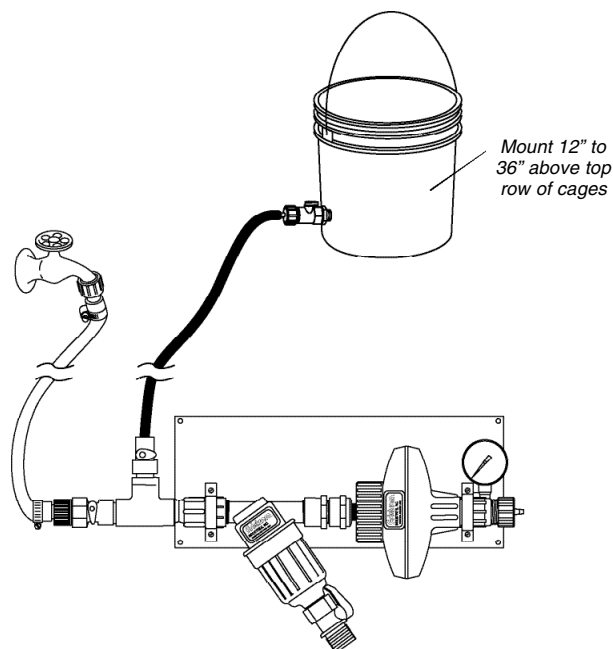

Figure 23
Storage tank of medicated solution connected to injection port of the Deluxe Pressure Station



SPECIALTY WATERERS

Water Buddy™ Animal Water Bottle

When animals are in transit or at shows, the EDSTROM Water Buddy™ Animal Water Bottle provides your animals with clean water through the same drip-free drinking valve they are accustomed to using. The EDSTROM Drinking Valve is ideal for transit cages, since it will not leak water due to movement and/or bouncing of the cage.

In addition, the Water Buddy can be used to provide medicated water to an individual cage of animals in your facility. Simply remove the regular drinking valve from the cage and attach the Water Buddy filled with the medicated water solution.

The Water Buddy is available in three sizes: 8 oz size, 1000-8808-001; 16 oz size, 1000-8816-001; and 32 oz size, 1000-8832-001. See Figure 24.

Water Buddy is top-filling and made from rugged, clear, blue PVC plastic. The bottle mounts neatly to the side of a cage with a spring clip (included), and is dishwasher safe on the top shelf.



Figure 24
8 oz, 16 oz and 32 oz
Water Buddy™

Watering Guinea Pigs and Mice

Special considerations need to be given to setting up Automated Watering Systems for commercial guinea pig and mouse facilities. Both animal species are prone to playing with the drinking valve and causing spillage into the cage. Not only is this spillage messy, but it can cause health problems for the animals. If animals are left in cages with wet bedding they can quickly suffer from hyperthermia and die.

EDSTROM offers a special drinking valve with a play-guard which is recommended for use with guinea pigs and mice. This GP/Mouse Drinking Valve, 1000-1451-GP 3/16" barb and 1000-1452-GP 1/8" mpt, incorporates the same reliable operating mechanism as the Vari-Flo Drinking Valve. See Figure 25. It has the same low actuation force, making it usable by weanling mice. The play-guard is made of stainless steel to withstand the gnawing of the animals.

The special GP/Mouse Drinking Valve with play-guard helps reduce the amount of spillage by playful guinea pigs and mice in two ways:

- The valve actuation stem is guarded on all sides by the play-guard making it more difficult for the animal to actuate the stem, except when drinking.
- The flow rate from the valve can be reduced by adjusting the tightness of the seat in the valve (see *flow adjustment instructions on Page 3*).

In guinea pig cages it is recommended that the drinking valve be mounted in an area of the cage having wire flooring, to eliminate the possibility of damp cage floors.

Mice are often housed in solid plastic cages with bedding, which makes the installation of the GP/Mouse Drinking Valve very critical. The mice will often stick the bedding material into the drinking valve, which can lodge it in the open position,

allowing water to flow into the cage. Such a continuous leak will quickly wet all the bedding in the cage and lead to the death of the animals.

It has been found that certain bedding materials can be more prone to causing leaking problems; use of fine wood chip bedding material should be avoided. It is the operator's responsibility to carefully monitor the animals' activities to confirm that they are not developing the habit of sticking bedding into the drinking valve, producing a leak.

Many breeders using solid plastic cages have good luck mounting the GP/Mouse Drinking Valve on the top of the cage, clipped to a wire mesh cover. Of course, the cage design must permit a method for the mice to crawl up to the top and reach the drinking valve.



The GP/Mouse Drinking Valve can also be mounted through the side-wall of the cage by punching a 5/8" hole in the end of the cage and pressing on the protective brass grommet (available from EDSTROM). The drinking valve is inserted through the grommet to protrude into the cage.

Figure 25
GP/Mouse Drinking Valve, 1000-1451-GP 3/16" barb and Clip

No matter what installation method you use, it is critical that you closely monitor the operation of the drinking valves to avoid any problems with the mice sticking bedding in the valves and causing leaks.

IMPORTANT

EXOTIC BIRD WATERING

EDSTROM Drinking Valves have been used extensively by commercial aviaries and exotic bird breeding facilities around the world for years with great success. Using the drinking valve assures a continuous supply of clean, fresh water to the birds. Providing a clean water supply in sanitary dispensers is critical to maintaining the good health of the birds, and the EDSTROM Drinking Valve does this for you.

In addition to eliminating the labor and time required to clean and change water bottles, producers also report that because they don't have to enter the breeding rooms as often, the birds' natural activities are less often interrupted.

Both the Vari-Flo Valve and the Original Drinking Valve can be operated by most straight-billed and hooked-billed breeds of birds. The Vari-Flo Valve, with its low actuation force, is the preferred drinking valve for finches and other small birds.

The drinking valve should be located on the cage side at a height easily accessible by the bird, either standing on a perch or on the cage floor. By mounting the drinking valve horizontally, the last drop of water remains in the barrel of the valve. This small amount of water attracts the birds to the valve, encouraging them to play with the valve, so they quickly learn how to operate it.

When installed in large flights, it is recommended that one drinking valve be provided for every six to eight birds. The valves should be spaced far enough apart to prevent the dominant bird from controlling access to all the drinking



Vari-Flo Valve
1000-8000



Original Valve
1000-0766

The Parrot Valve

For large birds like parrots, macaws, and cockatoos, EDSTROM has a large, rugged stainless steel Parrot Valve, 1000-4005. The Parrot Valve has a 1/2" mpt connection which can be easily installed in a Rigid PVC pipe system using the Tee Adaptor Fitting, 1630-2912-001.

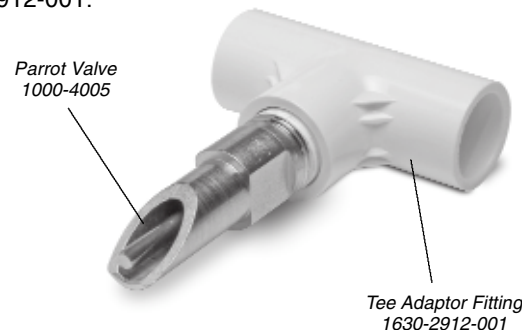

Cup Waterers for Poultry

EDSTROM also offers a line of Cup Waterers for use with all types of poultry including pigeons, quails, pheasants, doves, and chickens. Models are available which easily adapt to installation in the hobbyist's facility as well as commercial production facilities.

The Pivoting Stem Cup Waterer, *see Figure 27*, is available with either 1/8" mpt connection, 1000-5552, or with 3/16" barb connection, 1000-1900, for use in a Flex-Tube System. The valve mechanism used in the Pivoting Stem Cup Waterer is identical to the design of the Original Drinking Valve. The bowl of the cup is made of plastic and can be easily removed for cleaning.

A Trigger Cup Waterer used in commercial chicken houses around the world is also offered by EDSTROM. The Hart Trigger Cup, 0100-H-8L, has a 1/8" mpt connection, and is made of rugged plastic. *See Figure 28*.

Figure 27

Pivoting Stem Cup, 1000-1900 and Clip, 1100-0867-100



Figure 28

Trigger Cup, 0100-H-8L



Drinking Valve Leaking

- **The primary cause of a leak from the valve is the collection of particles on the O-ring seal inside the valve.** As explained on page 4, the water shut-off seal occurs between the head of the stem and the O-ring seal. When particles become lodged on the O-ring, it will prevent the stem head from sealing completely and a leak will occur.

If you experience this problem with your valves, you should disassemble the valve and inspect the O-ring to see what contamination can be found. It is helpful to have a good light source and a magnifying glass when inspecting the surface of the O-ring. If residue is found on the O-ring it is best to replace it with a new one. It is almost impossible to “clean” an O-ring that has particles embedded in it.

- **A common source of leak producing particles is fine sand in the water supply.** If your water supply has sand in it, an 80 micron or finer water filter (*see page 10, flushable filter, 2100-6120-200*) must be used on the water supply to the system.

- **Should leaks occur immediately in a newly installed Rigid PVC pipe system, the likely cause is shavings from the cutting of the PVC pipe which were not flushed out of the distribution lines during installation.** When the system is started up, the particles flow into the drinking valve and become lodged on the O-ring, causing a leak. To stop the leak each valve will need to be opened and the particles removed or the O-ring replaced.

- **Another possible cause of a leak would be corrosion of the brass seat under the O-ring.** Brass is an extremely rugged, sanitary and corrosion resistant material and is ideal for drinking water that is in the normal and safe range of 6.5 to 8.5 pH. However, when exposed to high acid levels the surfaces of both brass and stainless steel can be damaged by corrosion. For the well being of both your animals and your drinking valves use caution when using water additives and treatments to avoid exceeding this pH range.

- **A valve can also leak if animals stick bedding or feed inside the drinking valve, and thereby force the stem to the actuated position.** This can be avoided by locating the valve further away from the feed source in the cage or higher in the cage making it more difficult for the animals to play with the valve.

No Flow from the Drinking Valve

If you are unable to get water to flow from the valve when the Stem is actuated, check the following:

- **First confirm that you have water available in the distribution line to the valve.** Check that the pressure is properly regulated, 0.5 to 5 psi. If the valve is connected to high water pressures the stem head will become embedded into the O-ring and not allow water to be released.
- **Check that the valve seat has not been turned too tightly into the valve cap.** As described on Page 3, the rate that water is released from the Vari-Flo Valve can be adjusted by loosening or tightening the seat into the cap. Over-tightening of the seat in both the Vari-Flo and Original Valves can completely shut off the flow of water through the valve.
- **Check that the valve has not become plugged internally with algae or slime buildup.** Disassemble the valve and clean all internal parts. Be sure that the holes through the diaphragm are open. The valve components can be cleaned in vinegar or a bathroom cleanser to remove lime deposits.

Winterization of a Watering System

The EDSTROM Automated Watering System has been designed for use in facilities not exposed to freezing temperatures. Although the Flex-Tube System is very seldom damaged by effects of freezing temperatures, there is no easy method to protect it from freezing. The use of electrical heat tapes with the Flex-Tube System is NOT recommended. Some of the methods used by producers to deal with overnight mild freezing temperatures include:

1. *Turning off the water supply in the evening and allowing the animals to drink the system dry overnight.*
2. *Opening the drain-valve at the end of each lateral line allowing a slow trickle of water to run continuously.*

The Rigid PVC Pipe System is more susceptible to damage by water freezing inside the lines. Therefore PVC distribution lines should be drained to avoid the possibility of the pipe or fittings being split by freezing water.

It is possible to install heat tape on a Rigid Pipe System, using care to install according to manufacturer's instructions. The heat tape should be located on the pipe in a position that cannot be accessed by the animals. To protect yourself and your animals from possible electrical

PARTS LIST

DRINKING VALVES



Vari-Flo Drinking Valve
1000-8010, 1/8" mpt, all brass



Vari-Flo Drinking Valve
1000-8000, 3/16" barb, all brass



Valve Clip for Vari-Flo Valve
1100-7440, stainless steel



Original Drinking Valve
1000-0768, 1/8" mpt, all brass



Original Drinking Valve
1000-0766, 3/16" barb, all brass



Valve Clip for Original Drinking Valve
1100-0867-100, stainless steel

SPECIALTY WATERERS



Pivoting Stem Cup Waterer
1000-1900, 3/16" barb connection, brass cap
1000-5552, 1/8" mpt, brass cap



Valve Clip for Pivoting Stem Waterer with 3/16" barb
1100-0867-100, stainless steel



GP/Mouse Drinking Valve with play-guard
1000-1451-GP, 3/16" barb, brass and stainless steel
1000-1452-GP, 1/8" mpt, brass and stainless steel



Valve Clip for GP/Mouse Drinking Valve
1100-7440, stainless steel



Parrot Valve, threaded connection
1000-4005, 1/2" mpt, stainless steel



Water Buddy
1000-8808-001, 8 oz bottle, brass valve



Water Buddy
1000-8816-001, 16 oz bottle, brass valve



Water Buddy
1000-8832-001, 32 oz bottle, brass valve

WATER SUPPLY COMPONENTS



Tank Connector
7450-6115-200, can be attached to any plastic tank by drilling an 11/16" hole. Has a 142 micron strainer, shut-off valve and a 3/16" barb outlet. (To use with 5/16" flex-tube order p/n 7450-6115-516)



Storage Tank
7450-6126, one gallon tank with 142 micron strainer and shut-off valve; 3/16" or 5/16" barb outlet.



Float Tank
7450-5069-002, one gallon tank with auto-fill float valve, 10-ft inlet hose with female garden hose connection, 142 micron strainer, 3/16" or 5/16" barb outlet. (Order 7450-5069-202 and receive everything but the bucket.)



Pressure Regulator
7450-6114, 3/4 to 10 psi, high capacity, rugged plastic construction with female garden hose inlet connection, 142 micron strainer; 3/16" barb, 5/16" barb or 3/4" mpt outlet.



Basic Filter/Pressure Regulator Station
7450-5452-001, 3/4 to 10 psi, 80 micron flushable filter, pressure gauge, 10-ft inlet hose; 3/16" barb, 5/16" barb or 3/4" mpt outlet.

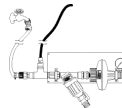

Deluxe Filter/Pressure Regulator/Injection Port Station
7450-5452-002, 3/4 to 10 psi, 80 micron flushable filter, pressure gauge, 10-ft inlet hose, injection port valve, 3/16" barb, 5/16" barb or 3/4" mpt outlet. Includes Injection Hose Assembly.



Flushable Filter (80 micron)
2100-6120-200, cartridge filter can be easily cleaned by opening flush valve. Inlet connection: mght or 3/4" mpt. Outlet connection: mght or 3/4" mpt.



Strainer Gasket (142 micron)
2100-6102, fits ght

PARTS LIST

3/16" FLEX-TUBE SYSTEM COMPONENTS



Flex-Tube
 1600-1654, 3/16" I.D. - per foot
 1600-1654-500, 3/16" I.D. - 500 foot roll
 Non-toxic black vinyl tubing used for EDSTROM Flex-Tube watering system components. Sold by the foot or roll.



Tubing Stand-Off
 1100-7273-316, stainless steel, secures
 3/16" Flex-Tube to wire cages



Loop Clamp and Screw
 1200-1714, secures tubing into solid wood or metal surface

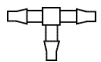

Barb Tee
 1610-1656, 3/16" barb x 3/16" barb x 3/16" barb



Barb Connector
 1610-1655, 3/16" barb x 3/16" barb



Shut-Off Valve
 2000-4510-316, 3/16" barb x 3/16" barb, plastic

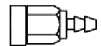

Drain Valve
 2020-1125, 3/16" barb, use at the ends of all Flex-Tube laterals
 to permit easy flushing of lines

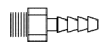

Barb Adaptor
 1610-1106, 3/16" barb x 1/8" mpt
 1610-1723, 3/16" barb x 1/4" mpt
 1610-4468-006 3/16" barb x mght

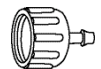

Swivel Adaptor
 1610-3299-006, 3/16" barb x fght, swivel w/gasket
 1610-5978-006, 3/16" barb x 3/4" fpt, swivel w/gasket

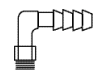

Barb Elbow Adaptor
 1610-1107, 3/16" barb x 1/8" mpt
 1610-2561, 3/16" barb x 1/4" mpt

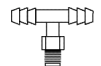

Barb Tee Adaptor
 1610-1108, 3/16" barb x 3/16" barb x 1/8" mpt
 1610-2562, 3/16" barb x 3/16" barb x 1/4" mpt

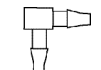

Barb Elbow
 1610-5490, 3/16" barbs x 90 degrees

5/16" FLEX-TUBE SYSTEM COMPONENTS



Flex-Tube
 1600-K-30, 5/16" I.D. - per foot
 1600-K-40, 5/16" I.D. - 50 foot roll
 1600-K-30X, 5/16" I.D. - 500 foot roll
 Non-toxic black vinyl tubing used for EDSTROM Flex-Tube watering system components. Sold by the foot or roll.



Tubing Stand-Off
 1100-7273-380, stainless steel, secures
 5/16" Flex-Tube to wire cages



Loop Clamp and Screw
 1200-1714-380, secures tubing into solid wood or
 metal surface

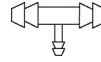

Barb Tee Reducer
 1610-5174-355, 5/16" inch barb x 5/16" barb x 3/16" barb

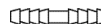

Barb Connector
 1610-5175-104, 5/16" barb x 5/16" barb



Shut-Off Valve
 2000-4510-516, 5/16" barb x 5/16" barb, plastic



Drain Valve
 2020-3095-516, 5/16" barb, use at the ends of all Flex-Tube
 laterals to permit easy flushing of lines



Barb Adaptor
 1610-4608-007, 5/16" barb x 1/4" mpt
 1610-K-44, 5/16" barb x 1/8" mpt

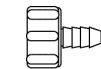

Swivel Adaptor
 1610-3299-516, 5/16" barb x fght, swivel w/gasket
 1610-5978-005, 5/16" barb x 3/4" fpt, swivel w/gasket

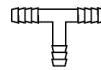

Barb Tee
 1610-K-40-3, 5/16" barb x 5/16" barb x 5/16" barb

PARTS LIST

1/2" RIGID PVC PIPE COMPONENTS



PVC Tee Adaptor
1630-2914-100, 1/2" soc x 1/2" soc x 1/8" fpt PVC



Rigid PVC Pipe
1600-2077-060, 1/2" pipe Sch40 60" long



Solvent Cement
4300-H-341, for cementing pipe together, 1/2 pint



Pipe Cutter Tool
0129-HV-100, for cutting rigid PVC pipe



Wire Tie
0120-F-50, Twist-On for PVC pipe



Wire Tie Tool
0129-F-50T, for twisting wire to cage



Plastic Clamp
1200-2312-008, for securing 1/2" PVC pipe



PVC Coupling
1630-HV-124-1, 1/2" soc x 1/2" soc



PVC Elbow
1630-HV-122, 1/2" soc x 1/2" soc



PVC Tee
1630-HV-123, 1/2" soc x 1/2" soc x 1/2" soc



PVC Tee Adaptor
1630-2912-001, 1/2" soc x 1/2" soc x 1/2" fpt



PVC Adaptor
1630-HV-121F, 1/2" soc x 1/2" fpt



PVC Adaptor
1630-9028-001, 1/2" soc x mght



PVC Adaptor
1630-HV-125X, 1/2" soc x 1/8" fpt



Threaded Adaptor
1640-3318-001, 1/2" mpt x mght



Plastic Shut-Off Valve
2000-4043, fght x mght



PVC Shut-Off Valve
2000-H-900, 1/2" soc x 1/2" soc

DRINKING VALVE REPAIR PARTS



Cap for Original Valve - Threaded Brass
1010-0046, 1/8" mpt



Cap for Original Valve - Barb Brass
1010-0042-001, 3/16" barb



Cap for Vari-Flo - Threaded Brass
1010-7272, 1/8" mpt



Cap for Vari-Flo - Barb Brass
1010-7270, 3/16" barb



Diaphragm for Original Valve with Brass Cap
Threaded and barb
1010-0048-065, 3-hole, red



Diaphragm for Original Valve with Old Style Plastic Cap
Threaded and barb
1010-0061-065, 4-hole, red



Diaphragm for Vari-Flo Valve
Threaded and barb
1010-0241-040, 3-hole, blue



O-ring Seal for Original Valve - all models
3100-0757-006, black



O-ring Seal for Vari-Flo Valves - all models
3100-2217, pink



Seat and O-ring for Original Valve - Brass
1010-0765-010



Seat and O-ring for Vari-Flo Valve - Brass
1010-8000-010



Stem for Original Valve - all models
1010-0448-001, stainless steel



Stem for Vari-Flo Valve - all models
1010-0240, stainless steel

EDSTROM KITS

EDSTROM Starter Kit, 7450-1000-100

EDSTROM's Starter Kit is perfect for someone just getting into raising small animals or birds. This Kit includes all components needed to supply three cages:



1 – Storage Tank and Lid
7450-6126



10 Feet – Flex-Tube
1600-1654, 3/16" ID

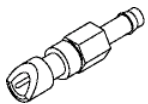

3 – Vari-Flo Valves
1000-8000, 3/16" barb, all brass

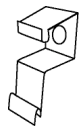

3 – Valve Clips
1100-7440, for the Vari-Flo Valve

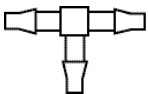

3 – Barb Tees
1610-1656, 3/16" barb

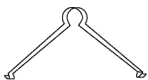

4 – Tubing Stand Offs
1100-7273-316, for 3/16" Flex-Tube

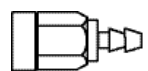

1 – Drain Valve
2020-1125, 3/16" barb

EDSTROM Add-On Kit, 7450-1000-101

The EDSTROM Add-On Kit gives you the flexibility to add on six more cages to the Starter Kit. This Kit includes:



20 Feet – Flex-Tube
1600-1654, 3/16" ID

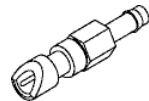

6 – Vari-Flo Valves
1000-8000, 3/16" barb, all brass

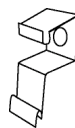

6 – Valve Clips
1100-7440, for the Vari-Flo Valve

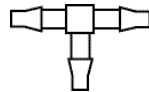

6 – Barb Tees
1610-1656, 3/16" barb

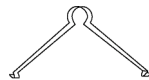

6 – Tubing Stand-Offs
1100-7273-316, for 3/16" Flex-Tube

Kits with Guinea Pig Drinking Valves, Original Drinking Valves and Poultry Cups are also available:

7450-1100-100 Starter Kit w/3 GP Valves

7450-1100-101 Add-On Kit w/6 GP Valves

7450-2000-100 Starter Kit w/3 Original Valves

7450-2000-101 Add-On Kit w/6 Original Valves

7450-3000-100 Starter Kit w/3 H-8L Poultry Cups

7450-3000-101 Add-On Kit w/6 H-8L Poultry Cups

Other Starter Kits





CONTACT US TO FIND A DEALER NEAR YOU:

service@agselect.com

www.agselect.com

Edstrom INDUSTRIES, INC.

819 Bakke Ave • Waterford WI 53185 • Tel: 262 534 5181 • 800 558 5913 • Fax: 262 534 5184