



ELECTRONICS INTERNATIONAL INC.

- Price List -





ELECTRONICS
INTERNATIONAL INC.

(541) 318-6060



www.Buy-Ei.com

Glass Panel Displays

MVP-50P Glass Panel Piston Engine Monitor & In-Flight Information System	4 - 6
MVP-50T Glass Panel Turboprop Monitor & In-Flight Information System	7 - 9
CGR-30P 3 1/8" Glass Panel Piston Engine Monitor	10 - 12
CGR-30C 3 1/8" Cluster Gauge Replacement Engine Monitor	13

Turboprop Instruments

N1, N2, Torque, ITT, EGT, TOT, Probe Harness, AC Volts and Frequency	14 - 15
--	---------

Engine Analyzers

UBG-16 Ultimate Bar Graph Engine Analyzer	16
US-8A Ultimate Engine Analyzer (for Singles and Twins)	17
SR-8A Smart Engine Analyzer	18

Fuel Flow/Pressure Instruments

FP-5L Fuel Flow/Horsepower/Fuel Pressure with GPS Interface	19
Primary FP-5L Fuel Flow and/or Fuel Pressure with GPS Interface	19

Fuel Level Instruments

FL-2CA, FL-2RA-12 and FL-2RA-24 Dual Fuel Level	20
FL-1CA, FL-1RA-12 and FL-1RA-24 Single Fuel Level	20

RPM/Oil Press/Temp, Manifold Pressure and Volt/Amp

PRIMARY R-1 RPM	21
PRIMARY OPT-1 Oil Press/Temp	21
PRIMARY M-1 Manifold Pressure	21
PRIMARY VA-1A Volt/Amp (Internal and External Shunt)	22

Altitude Alert/Super Clock Instruments

SC-5 Super Clock	23
ASC-5A Altitude Alert/Super Clock	23

EGT's/CHT's/TIT's/OAT/Carb. Temp.

EGT's / CHT's / TIT's	24
Combination Units (EGT's, CHT's, OAT, Carb. Temp.)	25
Remote Switches	25 - 26
Primary Remote Switches	26
EGT's / CHT's / TIT's for Twins	27

Miscellaneous

Annunciator Panels and Lights	28
Voice Annunciator	29
Probes	30
Accessories	31 - 33

Prices subject to change without notice



MVP-50P Glass Panel Engine Monitor

(STC'd and TSO'd as Primary Replacement)

Without question, the MVP-50P is the industry's finest engine analyzer and systems monitor, hands down. EI has redefined what an engine analyzer should be with the full color, glass-paneled, completely customizable MVP-50P. The MVP-50P allows pilots to accurately monitor dozens of engine and system parameters, program redline limits, setup custom inputs, create interactive checklists, store general flight information, build flight plans, record and review pertinent data from every flight, and so much more. The MVP-50P has been designed with the same thoughtful engineering that goes into every EI product, so even though the MVP-50P is by far the most powerful system in the industry, it is sure to be one of the easiest systems to use in your cockpit.

Specifications: 5.55" x 5.15" x 2.4" depth. Viewable in direct and indirect sunlight.

Hardware: All of the probes and transducers are connected to the EDC (Engine Data Converter). This small box (4.5" x 3.5" x 2.2") converts all engine data to serial data, which is then provided to the MVP-50P via two wires. This reduces installation time and the wire bundle to the instrument panel by over 100 wires. The EDC can interface with any probe or transducer. The EDC comes pre-wired (i.e., the harnesses are provided with each MVP-50P package).



The MVP-50P has over 14 different screens

ALL PACKAGES INCLUDE:

HARDWARE INCLUDED:

- MVP-50P Color Display Unit
- EDC Engine Data Converter
- Pre-wired Harness
- All EGT & CHT Probes and Cables
- Oil Pressure Transducer and Cable
- Oil Temperature Probe and Cable
- Fuel Pressure Transducer and Cable
- Fuel Flow Transducer and Cable
- OAT Probe and Cable
- Two RPM Pickups and Cables
- Manifold Pressure Transducer and Cable
- Shunt (for AMPS) and Cable
- Volts Pickup
- USB Memory Stick
- AL-1R and AL-1Y (External Cautionary and Warning Lights)
- AV-17 Voice Warning (Experimental Only)
- Annunciator Interface
- Resistive Fuel Interface

OTHER FUNCTIONS INCLUDED:

- Help Screen
- EGT Differential
- CHT Differential
- Shock Cooling
- Horsepower
- Weight and Balance Data
- Weight and Balance Graph
- GPS Interface and Data
- Fuel Efficiency
- Fuel Used for the Trip
- Fuel Used Since Fill Up
- Time to Empty
- Distance to Empty
- Fuel to Way Point
- Data Recording

- Time to Way Point
- Distance to Way Point
- Fuel Reserve
- Time Reserve
- Distance Reserve
- Up Timer
- Down Timer
- Flight Timer
- Tach Timer
- Engine Hours
- Date
- Local Time
- Zulu Time
- Voice Warnings (Experimental Only)
- Chelton & GRT Output

Experimental Packages (No OEM Discounts)

MVP-50P-4: 4-Cylinder Package	\$ 5,180.00
MVP-50P-6: 6-Cylinder Package (For Engines over 350 hp specify the FT-90 Fuel Flow Transducer)	\$ 5,680.00
MVP-50P-7: 7-Cylinder Radial Package (For Engines over 350 hp specify the FT-90 Fuel Flow Transducer)	\$ 5,880.00
MVP-50P-8: 8-Cylinder air cooled Package (Comes with two EDC-33P's)	\$ 6,680.00
MVP-50P-8W: 8-Cylinder water cooled Package	\$ 5,680.00
MVP-50P-9: 9-Cylinder Radial Package (Comes with two EDC-33P's)	\$ 6,680.00
MVP-50P-12W: 12-Cylinder water cooled Package (Thunder Mustang)	\$ 5,780.00
MVP-50P-4/6-FADEC: 4 or 6 Cylinder FADEC Aerosance Package	\$ 5,180.00

Certified Packages**(TSO'd, STC'd. See AML for applicable aircraft)**

MVP-50P-4-C: 4-Cylinder Package	\$ 6,180.00
MVP-50P-6-C: 6-Cylinder Package	\$ 6,680.00
MVP-50P-8-C: 8-Cylinder air cooled Package	\$ 7,680.00
MVP-50P-4T-C: Twin 4-Cylinder Package (two MVP-50P Packages, three EDC's)	\$13,180.00
MVP-50P-6T-C: Twin 6-Cylinder Package (two MVP-50P Packages, three EDC's)	\$14,180.00

Options**(for all packages listed above)**

Type-K Cable:XDO-6'-MVP, Type K, 6-foot extension cable with connectors and D-Sub pins. For connecting a temp probe to the MVP (\$1.60 for each additional foot)	\$ 39.00
Four Wire Cable: Cbl-4D-6'-MVP, 6-foot four wire cable with connectors and D-Sub pins. For connecting a pressure probe, flow transducer or G-Meter to the MVP (\$1.60 for each additional foot)	\$ 59.00
G-Meter: GS-3, 0.1g resolutions, +/- 8 g's max, for recording g's during the entire flight	\$ 495.00
TIT: TIT Probe, specify P-111 (1/8" NPT), P-112 (7/16"-20) or P-114 (1/4" NPT)	\$ 98.00
CarbTemp: P-128, 1/4"-28	\$ 98.00
Aux Volts and Amps: Volts/Amps Module (FM-VA-3). Allows any two temperature channels on the EDC to measure Voltage and Current for a separate bus. Specify an S-50 (100amp) or S-300 (300amp) shunt.	\$ 195.00
Vacuum Pressure: PT-05Diff, 0 to 6 In Hg.	\$ 150.00
Airspeed: PT-05Diff, 0 to 350 Kts indicated	\$ 150.00
Pressure Altitude: PT-30Alt, up to 40,000 ft	\$ 395.00
Cabin Altitude: PT-30ABS, up to 20,000 ft.	\$ 150.00
Cabin Differential Pressure: PT-05Diff, 0 to 6 In Hg.	\$ 150.00
High Manifold Pressure: PT-60ABS, 0 to 70 In Hg.	\$ 150.00
Hydraulic Pressure: PT-3000S, 0 to 3000 psi	\$ 250.00
H2O Pressure: PT-04H2O, measures pressure from 0 to 5" of water	\$ 250.00
Upper Deck Pressure: PT-30GA, 0 to 40 psi, for aircraft that require fuel pressure to be measured in reference to the upper deck.	\$ 195.00
3/4" Capacitive Fuel Level Probe: P-300C with Accessories (see Accessories at the back of this document)	\$ 249.00
Mini Capacitive Fuel Level Probe: P-300C Mini (see Accessories at the back of this document)	\$ 198.00
Magnetic Float Sensor: P-300M, accurate replacement for a resistive sensor (see Accessories at the back of this document)	\$ 349.00
Fuel Flow Differential Module: FFDM-1-xx, for aircraft with a pressure carburetor. Includes FT-60 or FT-90 flow transducer to measure the returned fuel. Specify FT-60 or FT-90 flow transducer	\$ 395.00
Fuel Flow from a Pulsed Injector: FM-Flow-P, measures Fuel Flow from a pulsed injector signal	\$ 395.00
Carbon Monoxide Detector: by CO Guardian, Requires a RS232 Input Port 3 on the MVP, unit also provides Cabin Pressure (altitude) and Cabin Temperature. (No Discounts).	\$ 475.00
Real-Time Data Out: RTDO, provides telemetry data for UAV's, racers and other applications	\$ 667.00
FLAM-1: Adds up to 4 Capacitive Fuel Level Probes and Provides 1 Output	\$ 475.00

Accessories

MVP Sub-panel: Makes installation of the MVP in an existing aircraft panel much easier. A 10.1" x 10.5" x .062" aluminum panel with a cutout for the MVP. This panel can be cut to size allowing front mounting of the MVP.	\$ 38.50
MVP-50P (Display Only): 1 EDC can drive multiple MVP-50P Displays, Non TSO'd unit.	\$ 3,550.00
MVP-50P (Display Only): 1 EDC can drive multiple MVP-50P Displays, TSO'd unit.	\$4,550.00
EDC-33P: Engine Data Converter. Adding a second EDC to the MVP provides 30 additional channels for temperatures, pressures, annunciators and other functions. (Requires the Input Port 3 on the MVP)	\$ 995.00
EGView: EGView Charting Software. Use for analyzing and downloading data to the MVP-50P. — (No Discounts)	\$ 125.00
USB-128: USB Memory Stick, 128 MB or larger. Used to upload and download data to the MVP-50P.	\$ 35.00
CP-1-MVP: LED Intensity Control Pot. External pot used to control the display intensity of the MVP-50P.	\$ 39.00

Adding Options to the MVP-50P

There are a limited number of channels on the MVP system to accommodate Options. Options are connected to the MVP system through the EDC (an external box). The EDC provides 6-pressure channels, 17-temperature channels, 4-fuel level channels, 2-RPM channels, 1-Fuel Flow channel, 1-Amp channel and 1-Volt channel. If you run out of channels on the MVP system, a second EDC may be purchased and connected to the MVP system.

The following is a list of open channels available for the packages listed in this price sheet and a list of the channels required to connect an Option to the MVP system.

Package	Included in the Package	Open Channels Available	Option	Channels Required
4 Cyl	RPM, Amps, Volts, Fuel Flow, M.P, F.P, Oil P, 4-EGT's, 4-CHT's, Oil T and OAT.	3- Pressure 7- Temperature 4- Fuel Level	All Temperature Options (TIT, Carb T, Induction T, etc.)	1- Temperature per Option
6 Cyl	RPM, Amps, Volts, Fuel Flow, M.P, F.P, Oil P, 6-EGT's, 6-CHT's, Oil T and OAT.	3- Pressure 3- Temperature 4- Fuel Level	All Pressure Options (Hyd P, Vac, Alt, Airspeed, Cabin P, etc.)	1- Pressure per Option
7 Cyl Radial	RPM, Amps, Volts, Fuel Flow, M.P, F.P, Oil P, 7-EGT's, 7-CHT's, Oil T and OAT.	3- Pressure 1- Temperature 4- Fuel Level	All Fuel Level Options (Up to 4 Fuel Tanks)	1- Fuel Level per Tank
8-Cyl Air Cooled (comes with two EDC's)	RPM, Amps, Volts, Fuel Flow, M.P, F.P, Oil P, 8-EGT's, 8-CHT's, Oil T and OAT.	9- Pressure 16- Temperature 8- Fuel Level	Any Annunciator Option (Canopy, Lights, etc.)	1- Temp or Fuel Level per Option
8-Cyl Water Cooled	RPM, Amps, Volts, Fuel Flow, M.P, F.P, Oil P, 8-EGT's, Oil T and OAT.	3- Pressure 7- Temperature 4- Fuel Level	Gear Annunciators	1 to 4 - Temp or Fuel Level
9-Cyl Radial (comes with two EDC's)	RPM, Amps, Volts, Fuel Flow, M.P, F.P, Oil P, 9-EGT's, 9-CHT's, Oil T and OAT.	9- Pressure 14- Temperature 8- Fuel Level	Gear Warning (Requires Airspeed Option)	1 - Pressure (Airspeed)
12-Cyl (water cooled)	RPM, Amps, Volts, Fuel Flow, M.P, F.P, Oil P, 12-EGT's, Oil T and OAT.	3- Pressure 2- Temperature 4- Fuel Level		

MVP-50T Engine Monitor for Turboprop and Jet Aircraft

(STC'd and TSO'd as Primary Replacement)

Engine and System Monitoring: The MVP-50T replaces over 15 engine instruments and 50 functions in a single full color glass panel display. The MVP-50T features programmable colors, ranges, limits and a voice alarm (experimental only) for each instrument displayed. A system page that displays trims, flaps, gear status lights and many system parameters is provided. Also, the MVP-50T incorporates a Crew Warning System (CAS) with 27 annunciators located at the top of the Main Engine Display Screen. These annunciators may be customized and programmed to display any color for the appropriate input signal and can have a voice warning (experimental only) associated with them.

In-Flight Data: The MVP-50T provides many "Flight Data Screens" to reduce cockpit clutter and pilot workload. Some of these screens are: Fuel Management, Timers, Clocks and Date, Weight and Balance, Data Recording, Custom Checklists, Custom Flight Plans, General Information, Flight Log, Start Log, Max Data Log, Min Data Log and other screens. The pilot can easily generate custom checklists and flight plans and download them to the MVP-50T through the USB port.

Hardware: All of the probes and transducers are connected to the EDC (Engine Data Converter). This small box (4.5" x 3.5" x 2.2") converts all engine data to serial data, which is then provided to the MVP-50T via two wires. This reduces installation time and the wire bundle to the instrument panel by over 100 wires. The EDC can interface with any probe or transducer. The EDC comes pre-wired (i.e., the harnesses are provided with each MVP-50T package).



Specifications: 5.55" x 5.15" x 2.4" depth. Accuracy: 1/2%. Viewable in direct and indirect sunlight. Backlit for night operation.



Scan the QR code or visit Buy-Ei.com/MVP-50T to see live videos of the product in action.

ALL PACKAGES INCLUDE

HARDWARE INCLUDED:

- MVP-50T Color Display Unit
- EDC Engine Data Converter
- Pre-wired Harness
- N1 and N2 Hookups
- Torque Pressure Transducer and Cable
- Oil Pressure Transducer and Cable
- Oil Temperature Probe and Cable
- Fuel Pressure Transducer and Cable
- Fuel Flow Transducer and Cable
- OAT Probe and Cable
- Shunt (for AMPS) and Cable
- Volts Pickup
- USB Download/Upload Memory Stick
- AL-1R External Red Warning Light
- AL-1Y External Yellow Caution Light
- AV-17CP Voice Warning (Experimental Only)
- Annunciator Interface
- Resistive Fuel Interface

OTHER FUNCTIONS INCLUDED:

- Help Screen
- Weight and Balance Data
- Weight and Balance Graph
- GPS Interface and Data
- Fuel Efficiency
- Fuel Used for the Trip
- Fuel Used Since Fill up
- Time to Empty
- Distance to Empty
- Fuel to Way Point
- Time to Way Point
- Distance to Way Point
- Fuel Reserve
- Time Reserve
- Distance Reserve
- Up Timer
- Down Timer
- Flight Timer
- Engine Hours
- Cycles
- Date
- Local Time
- Zulu Time
- Voice Warnings (Experimental Only)

MVP-50T Turboprop/Jet Engine Packages

Experimental Packages

MVP-50T-PT6: Pratt & Whitney PT-6 Turboprop Package.	\$ 6,995.00
MVP-50T-W: Walters Turboprop Package.	\$ 6,995.00
MVP-50T-G: Garrett Turboprop Package.	\$ 6,995.00
MVP-50T-L: Lycoming Turboprop Package.	\$ 6,995.00
MVP-50T-A: Allison Turboprop Package.	\$ 6,995.00
MVP-50T-J85: General Electric J85 Jet Engine Package.	\$ 6,995.00
MVP-50T-L39: L39 Aircraft Package.	\$ 8,762.00
MVP-50T-WJ33: Williams J33 Jet Engine Package.	\$ 6,995.00

Certified Packages

(TSO'd, STC'd. See AML for applicable aircraft)

MVP-50T-PT6-C: Pratt & Whitney PT-6 Turboprop Package.	\$ 9,950.00
MVP-50T-W-C: Walters Turboprop Package.	\$ 9,950.00
MVP-50T-G-C: Garrett Turboprop Package.	\$ 9,950.00
MVP-50T-L-C: Lycoming Turboprop Package.	\$ 9,950.00
MVP-50T-A-C: Allison Turboprop Package.	\$ 9,950.00
MVP-50T-J85-C: General Electric J85 Jet Engine Package.	\$ 9,950.00
MVP-50T-WJ33-C: Williams J33 Jet Engine Package.	\$ 9,950.00
MVP-50T-Twin-C: Twin Engine Package	\$21,233.00

Options

(for packages listed above)

Type-K Cable: XDO-6'-MVP, Type K, 6-foot extension cable with connectors and D-Sub pins. For connecting a temp probe to the MVP (\$1.60 for each additional foot)	\$ 39.00
Four Wire Cable: Cbl-4D-6'-MVP, 6-foot four wire cable with connectors and D-Sub pins. For connecting a pressure probe, flow transducer or G-Meter to the MVP (\$1.60 for each additional foot)	\$ 59.00
G-Meter: GS-3, 0.1g resolutions, +/- 8 g's max, for recording g's during the entire flight	\$ 495.00
Aux Volts and Amps: Volts/Amps Module (FM-VA-3). Allows any two temperature channels on the EDC to measure Voltage and Current for a separate bus. Specify an S-50 (100amp) or S-300 (300amp) shunt.	\$ 195.00
Vacuum Pressure: PT-05Diff, 0 to 6 In Hg.	\$ 150.00
Airspeed: PT-05Diff, 0 to 350 Kts indicated	\$ 150.00
Pressure Altitude: PT-30Alt, up to 40,000 ft	\$ 395.00
Cabin Altitude: PT-30ABS, up to 20,000 ft.	\$ 150.00
Cabin Differential Pressure: PT-05Diff, 0 to 6 In Hg.	\$ 150.00
Hydraulic Pressure: PT-3000S, 0 to 3000 psi	\$ 250.00
H2O Pressure: PT-04H2O, measures pressure from 0 to 5" of water	\$ 250.00
3/4" Capacitive Fuel Level Probe: P-300C with Accessories (see Accessories in the back of this document)	\$ 249.00
Mini Capacitive Fuel Level Probe: P-300C Mini (see Accessories at the back of this document)	\$ 148.00
Magnetic Float Sensor: P-300M, accurate replacement for a resistive sensor (see Accessories in back)	\$ 349.00
Carbon Monoxide Detector: by CO Guardian, Requires an RS232 Input Port 3 on the MVP. Unit also provides Cabin Pressure (altitude) and Cabin Temperature. (No Discounts).	\$ 459.00
Real-Time Data Out: RTDO, provides telemetry data for UAV's, racers and other applications	\$ 667.00
FLAM-1: Adds up to 4 Capacitive Fuel Level Probes and Provides 1 Output	\$ 475.00

Accessories

MVP Sub-panel: Makes installation of the MVP in an existing aircraft panel much easier. A 10.1" x 10.5" x .062" aluminum panel with a cutout for the MVP. This panel can be cut to size allowing front-mounting of the MVP.	\$ 38.50
MVP-50T (Display Only): 1 EDC can drive multiple MVP-50T Displays, Non TSO'd unit.	\$ 5,200.00
MVP-50T (Display Only): 1 EDC can drive multiple MVP-50T Displays, TSO'd unit.	\$ 6,500.00
EDC-33T: Engine Data Converter. Adding a second EDC to the MVP provides 30 additional channels for temperatures, pressures, annunciators and other functions. (Requires the Input Port 3 on the MVP)	\$ 2,450.00
USB-128: USB Memory Stick, 128 MB or larger. Used to upload and download data to the MVP-50P.	\$ 35.00
CP-1-MVP: LED Intensity Control Pot. External pot used to control the display intensity of the MVP-50P.	\$ 29.00

Adding Options to the MVP-50T

There are a limited number of channels on the MVP system to accommodate Options. Options are connected to the MVP system through the EDC (an external box). The EDC provides 9-pressure channels, 13-temperature channels, 4-fuel level channels, 2-RPM channels, 1-Fuel Flow channel, 1-Amp channel and 1-Volt channel. If you run out of channels on the MVP system, a second EDC may be purchased and connected to the MVP system. The following is a list of open channels available for the packages listed in this price sheet and a list of the channels required to connect an Option to the MVP system.

Package	Included in the Package	Open Channels Available
ALL	N1, N2, RPM, Amps, Fuel Flow, Torque Fuel P, Oil P, ITT, Oil T and OAT	6- Pressure 10 - Temperature 4- Fuel Level

Option

Channels Required

Any Temperature Option
(TIT, Carb T, Induction T, etc.)

1- Temperature

Any Pressure Option
(Hyd P, Vac, Alt, Airspeed,
Cabin P, etc.)

1- Pressure

All Fuel Level

1- Fuel Level

Any Annunciator
(Canopy, Gear, Lights, etc.)

1- Temp or Fuel Level



CGR-30P Color Engine Monitor (STC'd and TSO'd as Primary Replacement)

EI is proud to introduce its CGR-30P, the best engine monitor available in the industry. The CGR-30P was designed to replace your aircraft's tachometer. In addition to replacing your tachometer, our STC'd CGR-30P will replace MANY of your existing primary instruments. Because the CGR-30P is installed in a standard 3-1/8" hole, it doesn't protrude from your panel or cover adjacent instruments. This gives the CGR-30P a distinct advantage over the competition because it seamlessly integrates into your panel, is easy to install and is the perfect size to fit into any aircraft panel.

Specifications: 3.25" x 3.25" x 4.45" depth. Accuracy: 1/2%. Viewable in direct and indirect sunlight. Backlit for night operation.

AVAILABLE FUNCTIONS:

The CGR-30P comes standard with a state-of-the-art, full-color bar graph which assists with ROP/LOP leaning. Additionally, the bar graph has both "normalized" and digital readout screens. No other bar graph in the industry comes close to providing the number of options the CGR-30P offers. In addition to its bar graph, the CGR-30P can be configured to display a combination of the functions listed at the right.

- | | | |
|-------------------|------------------------|-------------------------|
| RPM | Fuel Pressure | Flight Timer |
| M.P. | Fuel Level | Tach Timer |
| EGT/CHT Bar Graph | Fuel Flow | Local Time |
| Oil Pressure | Fuel Remaining | Zulu Time |
| Oil Temperature | Fuel Used | Annunciators |
| TIT | Fuel -GPS Related Data | Data Recording |
| Hyd Pressure | Low Fuel Alarm | USB Port |
| C.O. | Recurring Fuel Alarm | External Caution Lights |
| OAT | Volts | And More |
| Vac. | Amps | |



Secondary Screen

This screen provides six additional functions to be displayed on the CGR-30P, as well as annunciators to display Main Screen alerts.



GPS Data Screen

This screen allows you to select between six sets of Fuel Flow, Fuel Remaining and GPS-related data.



Fuel Quantity Screen

This screen displays the estimated Fuel Remaining for each tank, based on current Fuel Flow.

AVAILABLE SCREENS:

In addition to the "Main Screen", the CGR-30P offers a "Secondary Screen", a "Fuel Quantity Screen" and a "GPS Data Screen." These additional screens give the CGR-30P flexibility not found in any other engine instrument.

CGR-30P Basic

Included: RPM, Fuel Flow, EGT/ CHT Bar Graph, Fuel Remaining, Volts, OAT, Tach Time, Local Time, Zulu Time, Flight Timer, Fuel Used for the Flight, Fuel Used Since Fill-up and all GPS/Fuel Flow Data.

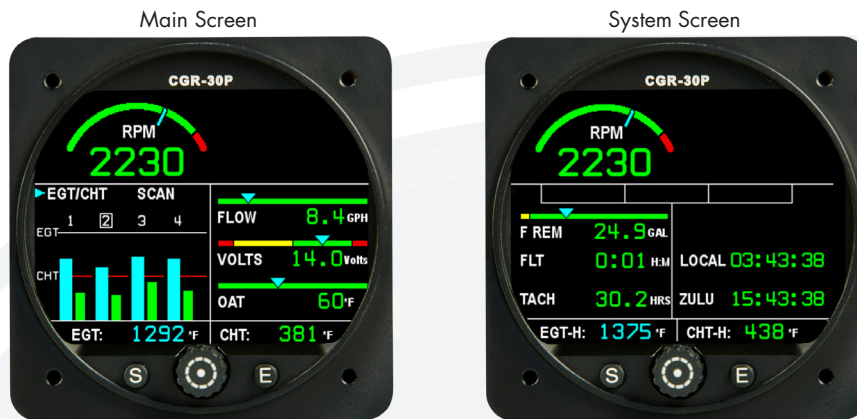

4-Cyl. Basic Setup Shown Above

CGR-30P-4-Basic (4-Cylinder)
\$3,596

CGR-30P-6-Basic (6-Cylinder)
\$4,342

CGR-30P Premium

Included: RPM (Arc Gauge), EGT/CHT Bar Graph, Fuel Remaining, Fuel Used, GPS/Fuel Flow Data, Eng Time and Tach Time.

Pick Second Arc:

M.P.

Pick Four Primary Functions:

Oil P, Oil T, Fuel Flow¹, Fuel Pressure², Right Fuel Level³, Left Fuel Level³, Aux Fuel Level³, TIT, Vac, Volts and Carbon Monoxide Detector⁴.

Pick Up To Five Additional Functions:

OAT	N/C
HP (requires RPM and MP)	N/C
Flight Timer	N/C
Local Time	N/C
Zulu Time	N/C
Hydraulic Press	\$250.00
Fuel Flow (If not selected as a primary)	\$295.00
G-Meter	\$495.00
Fuel Level(s) for a tank that does not feed the engine	\$98.00
Carb Temp or IAT	\$95.00
Amps	\$39.00
Second Amp Measurement	\$195.00



6-Cyl. Premium Setup Shown



CGR-30P-4- Premium (4-Cylinder)
\$4,217

CGR-30P-6- Premium (6-Cylinder)
\$4,714

¹Measuring Fuel Flow on a pressure carburetor requires an FFD-1 – \$395.00

²Turbocharged engine requires an upper deck pressure transducer – \$195.00

³Fuel Level Sensors not included

⁴Carbon Monoxide Detector (Additional \$459)

CGR-30P Twin

Two CGR-30P heads included. Options below are per head.

Included On Both Heads: RPM (Arc Gauge), EGT/CHT Bar Graph, Fuel Remaining, Fuel Used, GPS/Fuel Flow Data, Eng Time and Tach Time.

Pick Second Arc For Each Head:

M.P. or Fuel Flow¹

Pick Four Primary Functions For Each Head:

Oil P, Oil T, Fuel Flow¹, Fuel Pressure², Main Fuel Levels³, Aux Fuel Level³, TIT, Vac, Volts and Carbon Monoxide Detector⁴.

Pick Up To Five Additional Functions For Each Head:

OAT	N/C
HP (requires RPM and MP)(For both heads)	N/C
Flight Timer	N/C
Local Time	N/C
Zulu Time	N/C
Hydraulic Press	\$250.00
Fuel Flow (If not selected as a primary)(For both heads)	\$295.00
G-Meter	\$495.00
Fuel Level(s) for a tank that does not feed the engine	\$98.00
Carb Temp or IAT (For both heads)	\$196.00
Amps(Left & Right)	\$78.00
Second Amp Measurement	\$195.00

CGR-30P-4T (4 Cyl. Twin)
\$8,436

CGR-30P-6T (6 Cyl. Twin)
\$9,428

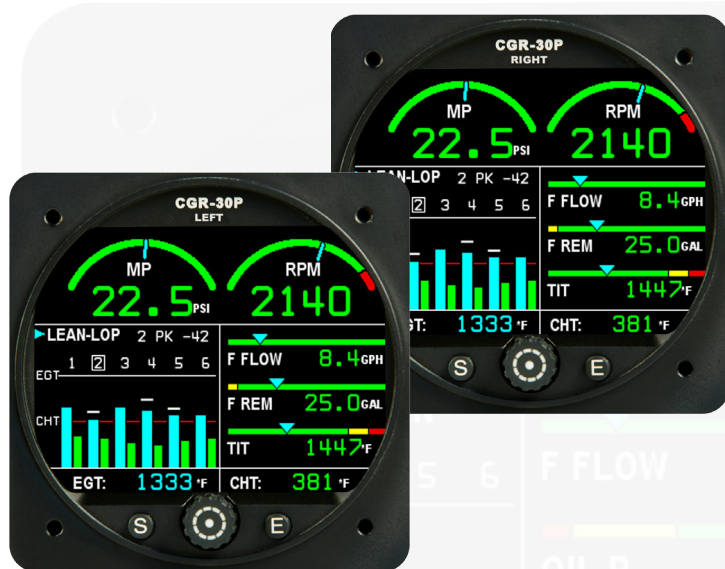

Above: 2 CGR-30P-6T Main Screens

¹Measuring Fuel Flow on a pressure carburetors requires an FFDM-1's (2 included) – \$790.00

²Turbocharged engines requires an upper deck pressure transducers (2 included) – \$390.00

³Fuel Level Sensors not included

⁴Carbon Monoxide Detector (Additional \$459)

CGR-30P Twin Combo

Two CGR-30P's and One CGR-30C. (See following page for CGR-30C details)



Twin CGR-30P Plus CGR-30C Package

CGR-30P-4TC (4 Cyl. Twin) **\$10,388**
 CGR-30P-6TC (6 Cyl. Twin) **\$11,380**

The CGR-30C can be installed as a stand-alone cluster gauge replacement instrument, or can be installed as a companion instrument with a Twin CGR-30P installation for the ultimate in engine and systems management.

In addition to replacing your instrument cluster, the CGR will digitally store all of your checklists for easy retrieval during flight. Create your own checklists on your computer, and then upload them from a USB stick via the provided USB interface.

**CGR-30C**

(STC'd and TSO'd as Primary Replacement)

The CGR-30C can replace up to 16 Primary Instruments, which means you can remove an ENTIRE INSTRUMENT CLUSTER with a single 3-1/8" instrument. This means Oil Temperature/Pressure, Fuel Pressure, even Fuel Level instruments can now be removed to give you the peace of mind that only comes from flying behind the world's most technologically advanced engine and system monitoring equipment.

The CGR-30C provides you with several full-color strip gauges and/or arc gauges, which give pilots a quick reference view of critical parameters, along with digital readouts for the pinpoint accuracy you've come to expect from Electronics International products.

Specifications: 3.25" x 3.25" x 4.45" depth.

Pick Up To 8 Functions:

- Fuel Flow¹
- RPM (Arc Gauge)
- Manifold (Arc Gauge)
- EGT
- CHT
- TIT
- OAT
- Oil Pressure
- Oil Temperature
- Fuel Pressure²
- Hydraulic Pressure
- Vacuum
- G-Meter
- Fuel Level (Up to 4 tanks)³
- Carb Temp or IAT

Pick Up To 8 Additional Functions:

- HP (Requires RPM, Manifold and EGT)
- Engine Time (Requires RPM)
- Tach Time (Requires RPM)
- Flight Timer (Requires RPM)
- Local Time
- Zulu Time
- Volts
- Amps
- Carbon Monoxide Detector⁴

Experimental Screen Layout



Checklists Screen



Also included are up to 6 annunciators tied to external switches.

CGR-30C - without EDC

\$1,952

CGR-30C - with EDC

\$2,952¹Measuring Fuel Flow on a pressure carburetors requires an FFDM-1 – \$395.00²Turbocharged engine requires an upper deck pressure transducer – \$195.00³Fuel Level Sensors not included⁴Carbon Monoxide Detector (Additional \$459)



R-1-N1 RPM (TSO'd and PMA'd)

RPM Instrument displayed in 0.1%. 210 degree graphic analog display with green, yellow and red LED's. Accurate digital display, .1% Resolution. Readings below 3.0% display as 0%. Hysteresis between LED's is 1 count. Tac Timer (records engine time above 96%). Flight Timer (starts above 96% and stops below 96%). Unit connects to one lead of the tac generator. Triggers at .4 volts. 2 1/4" Mount, 3.65" Depth, 10 Oz. Instrument. TSO'd, PMA'd, based instrument. **No STC's**. Viewable in direct and indirect sunlight, Backlit, Operates from 7.5 to 30 volts at .3 amps.



Kit Includes: Instrument and wire harness.

Price: \$895.00 Order must specify max %, any yellow ranges, Tac Time (set to 0 unless otherwise specified) and Tac Gen. RPM for a 100.0% reading on the R-1 (4200 RPM is standard).

Option: 5-Volt RS-232 Output for data recording: \$95.00

R-1-N2 RPM (TSO'd and PMA'd)

RPM Instrument displayed in RPM. 210 degree graphic analog display with green, yellow and red LED's. Accurate digital display, 10 RPM Resolution. Readings below 100 RPM display as 0. Hysteresis between LED's is 3 counts. Tac Timer (records engine time above 1300 RPM). Flight Timer (starts at 1500 RPM and stops at 1200 RPM). 2 1/4" Mount, 3.65" Depth, 10 Oz. Instrument. TSO'd, PMA'd, based instrument **No STC's**. Viewable in direct and indirect sunlight, Backlit, Operates from 7.5 to 30 volts at .3 amps. Triggers off the tac generator at 3.7 volts.

Kit Includes: Instrument and wire harness.

Price: \$895.00 Order must specify max RPM, any yellow ranges, Tac Time (set to 0 unless otherwise specified) and Tac Gen. RPM for a given reading on the R-1 (Tac Gen RPM of 4200 = 1670 RPM reading on the unit is standard).

Option: 5-Volt RS-232 Output for data recording: \$95.00



M-1T Pressure or Torque (TSO'd and PMA'd)

Pressure or Torque Instrument displayed in PSI or % Torque. 210 degree graphic analog display with green, yellow and red LED's. Accurate digital display, 1 PSI or 1% Resolution. Readings below 10 will be displayed as 0 and no LED's will be lit. Hysteresis between LED's is 2 counts. M-1T connects to E.I.'s PT-100GA pressure transducer. 2 1/4" Mount, 3.65" Depth, 10 Oz. Instrument. TSO'd, PMA'd, based instrument. **No STC's**. Viewable in direct and indirect sunlight, Backlit, Operates from 7.5 to 30 volts at .3 amps.

Kit Includes: Instrument and wire harness **(No Pressure Transducer)**

Price: \$895.00 Order must specify max Red line, any yellow ranges and the input pressure for a given reading on the M-1T.

Option: 5-Volt RS-232 Output for data recording: \$95.00



Add \$195.00 for PT-100GA or PT-300GA pressure transducer (no OEM discount)

Add \$395.00 for DPIM-1 Differential Pressure Interface Module (No Discounts)

For reading High and Low Torque Ports. Includes one pressure transducer.

M-1-ITT Inter-Turbine Temperature

(TSO'd and PMA'd)

Inter-Turbine Temperature Instrument displayed in Celsius. 210 degree graphic analog display with green, yellow and red LED's. Accurate digital display, 1°C Resolution. Operates with grounded or ungrounded type K harness. 2 1/4" Mount, 3.65" Depth, 10 Oz. Instrument. TSO'd, PMA'd, based instrument. **No STC's.** Viewable in direct and indirect sunlight, Backlit, Operates from 7.5 to 30 volts at .3 amps.

Kit Includes: Instrument and wire harness (does not include type K T.C. wires).

Price: \$895.00 Order must specify max red line and any yellow ranges.

Option: 5-Volt RS-232 Output for data recording: \$95.00

**M-1-TOT Turbine Outlet Temperature**

(TSO'd and PMA'd)

Turbine Outlet Temperature Instrument displayed in Celsius. 210 degree graphic analog display with green, yellow and red LED's. Accurate digital display, 1°C Resolution. Operates with grounded or ungrounded type K harness. 2 1/4" Mount, 3.65" Depth, 10 Oz. Instrument. TSO'd, PMA'd, based instrument. **No STC's.** Viewable in direct and indirect sunlight, Backlit, Operates from 7.5 to 30 volts at .3 amps.

Kit Includes: Instrument and wire harness (does not include type K T.C. wires).

Price: \$895.00 Order must specify max red line and any yellow ranges.

Option: 5-Volt RS-232 Output for data recording: \$95.00

**OPT-1-FV AC Bus Voltage and Frequency**

(TSO'd and PMA'd)

AC Bus Voltage and Frequency Instrument. The "-60" instrument is for a 60 Hz. bus and the "-400" instrument is for a 400 Hz. bus. Displays in Volts and Hz. Two 90 degree graphic analog displays with green, yellow and red LED's for a fast visual reference. Accurate digital display selects between Voltage and Frequency, 1 Volt and 1 Hz. Resolution. +/- 2% Accuracy 10 to 280 volts range. External warning line pulls to ground for an over voltage, over frequency, or under frequency condition. 2 1/4" Mount, 3.65" Depth, 10 Oz. Instrument. TSO'd, PMA'd, based instrument. **No STC's.** Viewable in direct sunlight, Backlit, Operates from 7.5 to 30 volts DC at .3 amps.

Kit Includes: Instrument and wire harness.

Price: \$895.00

Option: 5-Volt RS-232 Output for data recording: \$95.00



P-908: EGT 8 Probe Harness for a Garrett TPE-331-1 and -2 Turbine Engine. No STC's.

Kit Includes: 8 Probe Harness

Price: \$995.00

FP-5 Fuel Flow Instrument - See the Fuel Flow section of this price sheet.

OPT-1 Oil Pressure and Temperature Instrument - See the Oil Press/Temp section of this price sheet.

FL-2 and FL-1 Fuel Level Instrument - See the Fuel Level section of this price sheet.



UBG-16 Ultimate Bar Graph

(STC'd and PMA'd)



Sixteen Input Channels. Any channel may be set to display EGT's, CHT's, TIT and/or Oil Temp (digital and bar graph display). Other temperatures & functions will be displayed digitally only. See below for list of other temperatures or functions. Engine analysis performed automatically with sixteen Pilot Programmable Over-Temp Limits, sixteen Under-Temp Limits, a Differential Limit and a Shock-Cooling Limit. Range for Bars and Scan Rate are also Pilot Programmable. True Peak Detect that eliminates false peak readings. Indicates as each cylinder reaches Peak EGT. Displays Temperature Below Peak EGT for accurate Leaning. Fuel/Air Mixture Profiling. Normalized Mode with Long Term Memory for Easy Problem Detection and Trend Analysis.

Specification: 2.65" x 2.65" x 6" Depth. 2 1/4" Mount. 22 Oz. Unit. 3.5 Oz for each probe and 6' cable. 1°F Resolution. Accuracy: 1/2%. Plasma display viewable in direct and indirect sunlight. Operates from 7.5 to 35 volts at 1/2 amp.

RETAIL PACKAGE PRICES

UBG-16-4-Mem: 4 Cyl. UBG-16 Package w/4 P-110 EGT, 4 P-100 CHT, 6' Cables (uses 8 inputs) and Includes Memory (MUX-8A Data Recorder) with free download software.

\$1,648

UBG-16-4G-Mem: 4 Cyl. UBG-16 Package w/4 P-110 EGT, 3 P-100 CHT, 1 P-102 Gasket CHT Probe, 6' Cables (uses 8 inputs) and includes Memory (MUX-8A Data Recorder) w/free download software. Order this package if you have a 4 cylinder engine with a primary CHT instrument already installed.

\$1,648

UBG-16-6-Mem: 6 Cyl. UBG-16 Package w/6 P-110 EGT, 6 P-100 CHT, 6' Cables (uses 12 inputs) and Includes Memory (MUX-8A Data Recorder) with free download software.

\$2,098

UBG-16-6G-Mem: 6 Cyl. UBG-16 Package w/6 P-110 EGT, 5 P-100 CHT, 1 P-102 Gasket CHT Probe, 6' Cables (uses 12 inputs) and Includes Memory (MUX-8A Data Recorder) w/free download software. Order this package if you have a 6 cylinder engine with a primary CHT instrument already installed

\$2,098

UBG-16 OPTIONS

The UBG-16 features 16 input channels. Any of the following options can be added at any time. Each option uses 1 input channel unless noted otherwise.

EGView: EGView Charting Software. Use for analyzing downloaded data. (Does not use an input)

\$125

UBG-16-Remote: UBG-16 Remote Head option 1.5" deep (case connected to head by 7' of wire) \$100 additional charge to any of the above UBG-16 packages (does not use an input channel)

\$100

P-128-XCO-6 OAT or Carb Temp with P-128 Probe (1/4" -28 thread) & 6' Precision Cable

P-120-XCO-6 Secondary Oil Temp with P-120 Probe (5/8" - 18 thread) & 6' Cable

P-111-XCO-6 Secondary TIT or Oil Temp with P-111 Probe (1/8" NPT adjustable depth) & 6' Cable

P-112-XCO-6 Secondary TIT or Oil Temp with P-112 Probe (7/16 - 20 thread adjustable depth) & 6' Cable

P-114-XCO-6 Secondary TIT or Oil Temp with P-114 Probe (1/4" NPT adjustable depth) & 6' Cable

FM-Flow-60 Fuel Flow only. For aircraft with engine-driven fuel pumps with up to 350 horsepower

FM-Flow-90 Fuel Flow only. For aircraft with 350 to 550 HP **OR** without an engine-driven fuel pump

\$395

FM-OP- Secondary Oil Pressure. Includes PT-100GA Pressure Transducer

FM-FP- Secondary Fuel Pressure. Includes PT-30GA Pressure Transducer

FM-MP- Secondary Manifold Pressure. Includes Pressure Transducer

FM-Gyro Gyro Vacuum. Includes Pressure Transducer

FM-RPM- Secondary RPM. Connects directly to the Mag Switch

FM-VA- Secondary Volts/Amps w/S-50 Shunt. 1 input channel for volts and/or 1 for Amps

\$249 ea.

US-8A Ultimate Engine Analyzer

(STC'd and PMA'd)

Two Displays, 16 Channels (use up to 8 probes for each display). Can measure EGT's, CHT's, TIT, Oil Temp, OAT, Carb. Temp and More. Manual and Automatic (Scan) Modes.

Singe Engine Aircraft: Use left display for EGT and right display for CHT.

Twin Engine Aircraft: Use left display for left engine and right display for right engine.



Pilot Programmable from the front panel: Sixteen Over-Temp Limits, Sixteen Under-Temp Limits, Two Differential Limits, Two Shock-Cooling Limits, Scan Rate, and Number of Channels to be Scanned.

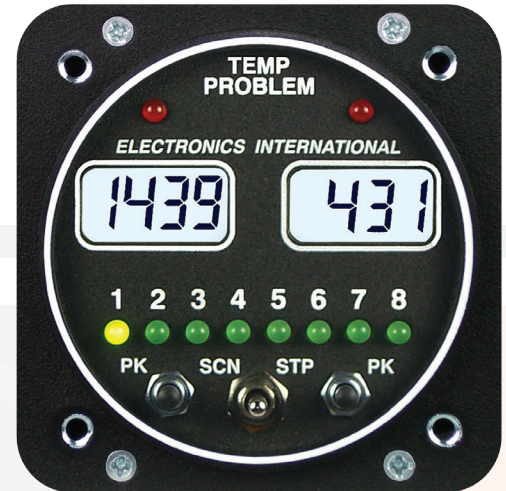

Specifications: 2 1/4" Mount. 5.35" Depth. 19 Oz. Unit. 3.5 Oz for each probe and 6' cable, 7 Oz for each probe and 20' cable. 1°F Resolution. Accuracy: 1/2%. Viewable in direct and indirect sunlight. Backlit for night operation. Operates from 7.5 to 35 volts at .3 amps.

SINGLE ENGINE RETAIL PACKAGE PRICES

US-8A-4: 4 Cyl. US-8A Package w/4 P-110 EGT, 4 P-100 CHT, 6' Cables (uses 8 inputs)

\$1,298

US-8A-4G: 4 Cyl. US-8A Package w/4 P-110 EGT, 3 P-100 CHT, 1 P-102 Piggy Back CHT Probe, 6' Cables (uses 8 inputs) **Order this package if you have a 4 cylinder engine with a primary CHT instrument already installed.**

\$1,298

US-8A-6: 6 Cyl. US-8A Package w/6 P-110 EGT, 6 P-100 CHT, 6' Cables (uses 12 inputs)

\$1,598

US-8A-6G: : 6 Cyl. US-8A Package w/6 P-110 EGT, 5 P-100 CHT, 1 P-102 Piggy Back CHT Probe, 6' Cables (uses 12 inputs) **Order this package if you have a 6 cylinder engine with a primary CHT instrument already installed.**

\$1,598

TWIN ENGINE RETAIL PACKAGE PRICES

US-8A-4-T: 4 Cyl. US-8A Package w/8 P-110 EGT, 8 P-100 CHT, 20' Cables (uses all 16 inputs)

\$2,298

US-8A-4G-T: 4 Cyl. US-8A Package w/8 P-110 EGT, 6 P-100 CHT, 2 P-102 Piggy Back CHT Probe, 6' Cables (uses all 16 inputs) **Order this package if you have a twin 4 cylinder engine with a primary CHT instrument already installed.**

\$2,298

US-8A-6-T: 6 Cyl. US-8A Package w/12 P-110 EGT, 4 P-100 CHT, 20' Cables (uses all 16 inputs)

\$2,298

US-8A OPTIONS

The US-8A features 16 input channels. Any of the following options can be added at any time to any unused channel. Each option uses 1 input channel.

P-128-XCO-6 OAT or Carb Temp with P-128 Probe (1/4" -28 thread) & 6' Precision Cable

P-120-XCO-6 Secondary Oil Temp with P-120 Probe (5/8" - 18 thread) & 6' Cable

P-111-XCO-6 Secondary TIT or Oil Temp with P-111 Probe (1/8" NPT adjustable depth) & 6' Cable

P-112-XCO-6 Secondary TIT or Oil Temp with P-112 Probe (7/16" - 20 thread adjustable depth) & 6' Cable

P-114-XCO-6 Secondary TIT or Oil Temp with P-114 Probe (1/4" NPT adjustable depth) & 6' Cable

\$98 ea.
W/ US-8A
Purchase



SR-8A Smart Engine Analyzer

(STC'd and PMA'd)

Large Display. Total of 8 Channels (inputs). Use only the channels you need and save on probe and cable costs. Measures EGT's, CHT's, TIT, Oil Temp, OAT, Carb. Temp and Other, up to 8 channels. Manual and Automatic (Scan) Modes. Automatically finds the hottest EGT or CHT. Factory set EGT Over-Temp Limit (1650°F). Factory set EGT Under-Temp Limit (1100°F). Factory set CHT Over-Temp Limit (500°F). Differential Limit set from back panel to 95°F or 195°F. Selectable Scan Rate and Number of Channels to be Scanned.

Specification: 2 1/4" Mount. 5.35" Depth. 16 Oz. Unit. 3.5 Oz for each probe and 6' cable, 7 Oz. for each probe and 20' cable. 1°F Resolution. Accuracy: 1/2%. Viewable in direct and indirect sunlight. Backlit for night operation. Operates from 7.5 to 35 volts at .3 amps.



RETAIL PACKAGE PRICES

SR-8A: SR-8A Instrument Only (no probes or cables)

\$498

SR-8A-4: 4 Cyl. SR-8A Package w/4 P-110 EGT, 4 P-100 CHT, 6' Cables (uses all 8 inputs)

\$1,098

SR-8A-4G: 4 Cyl. SR-8A Package w/4 P-110 EGT, 3 P-100 CHT, 1 P-102 Piggy Back CHT Probe, 6' Cables (uses all 8 inputs) Order this package if you have a 4 cylinder engine with a primary CHT instrument already installed.

\$1,098

SR-8A-6: 6 Cyl. SR-8A Package w/6 P-110 EGT, 2 P-100 CHT, 6' Cables (uses all 8 inputs)

\$1,098



SR-8A OPTIONS

The SR-8A features 8 input channels. Any of the following options can be added at any time to any unused channel. Each option uses 1 input channel.

P-128-XCO-6 OAT or Carb Temp with P-128 Probe (1/4" -28 thread) & 6' Precision Cable

P-120-XCO-6 Secondary Oil Temp with P-120 Probe (5/8" - 18 thread) & 6' Cable

P-111-XCO-6 Secondary TIT or Oil Temp with P-111 Probe (1/8" NPT adjustable depth) & 6' Cable

P-112-XCO-6 Secondary TIT or Oil Temp with P-112 Probe (7/16" - 20 thread adjustable depth) & 6' Cable

P-114-XCO-6 Secondary TIT or Oil Temp with P-114 Probe (1/4" NPT adjustable depth) & 6' Cable

\$98 ea.
W/ SR-8A
Purchase

FP-5L Fuel Flow / Horsepower

(STC'd and PMA'd as Primary Replacement)

The FP-5L is the most versatile fuel computer in the General Aviation industry. Displays Gallons per Hour, Gallons Used, Gallons Remaining, Time to Empty, Gallons Needed to Destination, % Horsepower and Two Programmable Low Fuel Alarms. The standard FP-5L also has one auxiliary channel that can be used to monitor Oil Pressure, Oil Temperature, Fuel Pressure, Manifold Pressure, Vacuum, Volts, Amps, Carb temperature, EGT, CHT, TIT or OAT.



Specifications: 2 1/4" Mount. 3.65" Depth. 28 Oz. Kit. Backlit for night operation. Viewable in direct sunlight. Operates from 7.5 to 30 volts at .3 amps.

STANDARD FP-5L PACKAGES

FP-5L-Inst: Fuel Flow w/HP & GPS input/output. Instrument Only (no transducers)

\$688

FP-5L-60: Fuel Flow w/HP & GPS input/output. Includes FT-60 Flow transducer (for aircraft with up to 350 HP and an engine-driven fuel pump).

\$778

FP-5L-90: Fuel Flow w/HP & GPS input/output. Includes FT-90 Flow Transducer (for aircraft with 350 to 550 HP **OR** without an engine-driven fuel pump).

\$778

FP-5L-180: Fuel Flow w/HP & GPS input/output. Includes HIGH FLOW FT-180 Flow Transducer (for aircraft with more than 550 horsepower).

\$1,183

STANDARD FP-5L AUXILIARY CHANNEL OPTIONS

Any one of the following choices can be added to the FP-5L Aux Channel at any time.

FM-OP Secondary Oil Pressure. Includes PT-100GA Pressure Transducer

FM-FP Secondary Fuel Pressure. Includes PT-30GA Pressure Transducer

FM-MP Secondary Manifold Pressure. Includes Pressure Transducer

FM-Gyro FM-Gyro Gyro Vacuum. Includes Pressure Transducer

FM-RPM Secondary RPM. Connects directly to the Mag Switch

FM-VA Secondary Volts OR Amps (one or the other) w/S-50 Shunt

\$249 ea.

PRIMARY FP-5L PACKAGES - Must specify High/Low Pressure Limits when ordering

FP-5L Instrument Only: Instrument Only (no transducers)

\$788

FP-5L w/FT-60 & Pressure: Includes FT-60 Flow Transducer (for engines up to 350 HP) & PSI Transducer

\$1,073

FP-5L w/FT-60 NO Pressure: Includes FT-60 Flow Transducer (for engines up to 350 HP)

\$878

FP-5L w/FT-90 & Pressure: Includes FT-90 Flow Transducer (for engines with 350 to 550 HP) & PSI Transducer

\$1,073

FP-5L w/FT-90 NO Pressure: Includes FT-90 Flow Transducer (for engines with 350 to 550 HP)

\$878

STANDARD FP-5L ACCESSORIES - May be required for your aircraft

FFDM-1 Fuel Flow Differential Module (for aircraft with a pressure carburetor). Includes FT-60 or FT-90 flow transducer to measure the returned fuel. Please specify FT-60 or FT-90.

\$395

DPIM-1-30 Fuel Pressure Differential Module (for aircraft that measure fuel pressure in reference to the upper deck). Includes 1 PT-30GA pressure transducer to measure the upper deck.

\$395



FL-1 - Single Fuel Level

FL-1 and FL-2 Fuel Level Instruments

(Not STC'd. For TC and STC Holders or Experimental Aircraft)

The FL-1 and FL-2 are fuel level instruments featuring an LED analog display and a digital display. The FL-1 is for single fuel level while the FL-2 is for dual fuel level. They can display in gallons (one or one-half gallon increments), pounds or liters. Since the FL-1 and FL-2 do not incorporate any moving parts (needles, bearings, springs, etc.) there is little to go wrong or wear out. Instrument improvements allow for a new easier and quicker fuel calibration procedure. The procedure also removes any non-linearity in the tanks and sensors. You may use as few as two calibration points or as many as nine. A New Programmable Fuel Slosh Stabilization Feature has been added to increase user customization.

Specification: 2 1/4" Mount, 3.65" Depth, 10 Oz. Unit, Viewable in direct sunlight, Backlit, Operates from 7.5 to 35 volts at .3 amps.

ALL PACKAGES (WITHOUT PROBES) - \$469

FL-1CA or FL-2CA: This model was designed to be used with E.I.'s Capacitive Fuel Level Probe (P-300C) from 6" to 20' long. A P-300C/4 Module must be used for probes 6" to 4' long.

FL-1RA-12 or FL-2RA-12: This model was designed to be used on a 12-volt system with a resistive fuel level sensor. The fuel level sensor's resistance may increase or decrease as fuel is added to the tank and the maximum resistance must be between 90 and 270 ohms.

FL-1RA-24 or FL-2RA-24: This model was designed to be on a 24-volt system with a resistive fuel level sensor. The fuel level sensor's resistance may increase or decrease as fuel is added to the tank and the maximum resistance must be between 90 and 270 ohms.

FL-2M: This model was designed to be used with E.I.'s Magnetic Float Sensor (P-300M). The P-300M is an accurate replacement for a resistive fuel level sensor.



FL-2 Dual Fuel Level

VOICE ANNUNCIATOR

Easily add Voice Warnings by purchasing the AV-17.
[VISIT OUR ANNUNCIATORS PAGE TO LEARN MORE »](#)



Replace your unreliable resistive fuel probe with our P-300M Magnetic Probe.
 See our PROBES page for more details.



R-1 RPM Tachometer

(TSO'd and STC'd as Primary Replacement)

Displays an accurate RPM measurement in digital and analog format. Proprietary algorithms ensure stable yet lighting-quick responses.

Kit Includes: Instrument and wire harness.

Price: \$529.00 Order must specify range markings.

Options: RC-1 RPM Cap: \$4.95. AV-17 Voice Annunciator: \$285.00.



OPT-1 Oil Press and Temp

(TSO'd and STC'd as Primary Replacement)

Displays accurate Oil Pressure and temperature readings. Easily see readings on a large LCD display along with an LED arc for quick glance analysis.

Kit Includes: Instrument Temp Probe, Press. Transducer and wire harness.

Price: \$598.00 Order must specify range markings.

Options: AV-17 Voice Annunciator: \$285.00.



M-1 Manifold Pressure

(TSO'd and STC'd as Primary Replacement)

Displays precise Manifold Pressure in both Digital and Analog format. The LED Arc provides the pilot with a quick reference of the Manifold Pressure operation.

Kit Includes: Instrument and wire harness.

Price: \$569.00 Order must specify range markings.

Options: AV-17 Voice Annunciator: \$285.00.



R-1, OPT-1 AND M-1 SPECIFICATIONS

2 1/4" Mount. 3.65" Depth. Viewable in direct and indirect sunlight. Backlit for night operation. Operates from 7.5 to 30 volts at .3 amps. Instruments may come with labels on the faceplate rather than silkscreen to signify limit markings for your aircraft. An A-102 Adapter is available to fill a 3 1/8" hole for \$19.00.

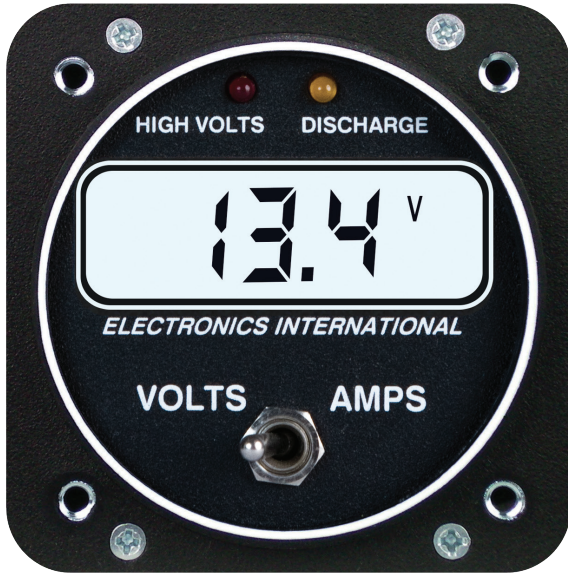

VA-1A Volts and Amps

(STC'd, and PMA'd)

Provides Pilots with precision Volts and Amps readings. Offers both a "High Volts" and a "Discharge" alarm. Runs on 12 or 24 volt systems. This model comes with an internal shunt.



Price: \$399.00

VA-1A-xx: The VA-1A-xx can be matched to the aircraft's external shunt (i.e. 50 amp, 50mV external shunt must use a VA-1A-50). E.I. will calibrate the unit to match any shunt.

Price: \$399.00 Order must specify shunt value. (shunt sold separately).

Specifications: Accuracy: 1%. 2 1/4" Mount. 2.5" Depth. 9 Oz. Unit. Viewable in direct and indirect sunlight. Backlit for night operation. Operates from 7.0 to 40 volts at .1 amp.



RSVA-3: Remote Switch used to monitor the Left and Right Alternator and Battery Current for Twins. To be used with any external shunt unit. Body 1" x 1" x 1.5" depth. Front Panel 2" x 1.15." 3 Oz. Unit. STC'd, PMA'd.

Price: \$98.00

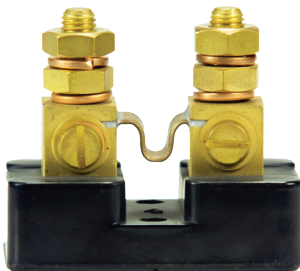

S-50: 50 amp, 50mV (100 amp short burst capability) External Shunt. To be used with a VA-1A-50. Size 2" x 1.2" x 1.7" height. 3.5 Oz. Unit.

Price: \$39.00



S-300: 300 amp External Shunt, To be used with a VA-1A-300, Size 3.25" x 1.75" x 1.75" height. 11.5 Oz. Unit.

Price: \$49.00

SC-5 Super Clock

(Minor Alteration Installation. **No STC required.**)

The SC-5 is a fully functional, panel mounted aircraft clock. Displays Local Time, Zulu Time, 12 & 24 hour formats and an engine timer. Has Up timers and Down timers with programable alarms. The instrument runs off a 10-year lithium battery that keeps the clock running even if the aircraft battery is removed.

Kit Includes: SC-5 and wire harness.

Price: \$331.00

Options: Voice Annunciator. (See AV-17): \$285



ASC-5A Altitude Alert Super Clock

(Minor Alteration Installation. **No STC required.**)



Has the same great features as the SC-5 but adds additional features for altitude. The ASC-5A can read your Altitude Encoder and displays your current altitude as seen by ATC. Display indicates when your current altitude is above or below your Programmed Assigned Altitude. The unit also has a Level off Alarm, Deviation Alarm, Programmed Approach Altitude, Wheels Down Altitude or any altitude for which you wish to set an alert. Additionally, the ASC-5A can monitor and display OAT temperatures. This allows it to also display Density Altitude based on your current OAT readings.

Kit Includes: ASC-5A, OAT probe, 6 foot OAT extension cable and wire harness. (Connectors for your Altitude Encoder are not included.)

Price: \$550.00

Options: Voice Annunciator. (See AV-17): \$285.00



SC-5 AND ASC-5A SPECIFICATIONS

2 1/4" Mount. 3.65" Depth. 10 Oz. Unit. Viewable in direct and indirect sunlight. Backlit for night operation. Operates from 7.5 to 35 volts at .3 amps.



E-1 or C-1 Single Channel EGT or CHT

(STC'd, TSO'd and PMA'd)

The E-1 is a single channel EGT and the C-1 is a single channel CHT gauge. Both instruments are 2 1/4" Mount, 2.5" Depth and 12 Ounces. Sunlight viewable and backlit for night operation.

Kit Includes: Unit, 1 6' Cable, 1 Probe, All Wires and Connectors.

Price: \$329.00



E-1P, T-1P or C-1P Primary Replacement Single Channel

(STC'd, TSO'd and PMA'd)

Primary replacement single channel EGT, TIT or CHT kits with an Over-Temp Light. All are 2 1/4" Mount, 2.5" Depth and 12 Ounces. Sunlight viewable and backlit for night operation.

Kit Includes: Unit, 1 6' Cable, 1 Probe, All Wires and Connectors.

Price: \$369.00 (Order must specify Over-Temp Limit and TIT Probe Type)



EC-1 Single Channel EGT/CHT

(STC'd, TSO'd and PMA'd)

This unit can monitor a single channel EGT and CHT. Easily switch between your readings with a front mounted switch. 2 1/4" Mount, 2.5" Depth and 16 Ounces. Sunlight viewable and backlit for night operation.

Kit Includes: Unit, 2 6' Cables, 1 EGT Probe and 1 CHT Probe

Price: \$429.00



EC-1P or TC-1P Dual Screen Primary Replacement

(STC'd, TSO'd and PMA'd)

Primary Replacement CHT and EGT (or Primary TIT) with Over-Temp Lights. 3 1/8" Mount, 2.5" Depth and 20 Ounces.

Kit Includes: Unit, 2 6' Cables, 1 EGT or TIT Probe and 1 CHT Probe

Price: \$599.00 (Order must specify Over-Temp Limits)



E-4 or C-4 Four Channel EGT or CHT

(STC'd, TSO'd and PMA'd)

Similar to the E-1 or C-1 this unit allows you to monitor 4 channels of EGT or CHT's with a front mounted switch.

Kit Includes: Unit, 4 6' Cables, 4 Probes and All Wires and Connectors.

Price: \$659.00



E-6 or C-6 Six Channel EGT or CHT

(STC'd, TSO'd and PMA'd)

Similar to the E-1 or C-1 this unit allows you to monitor 6 channels of EGT or CHT's with a front mounted switch.

Kit Includes: Unit, 6 6' Cables, 6 Probes and All Wires and Connectors.

Price: \$769.00

**A-1 OAT or Carb. Temp**

(STC'd, TSO'd and PMA'd)

OAT instrument with Ice Zone Warning Light. Or order the instrument to display Carb. Temp.

Kit Includes: Unit, 1 6' Cable and 1 OAT Probe.

Price: \$299.00

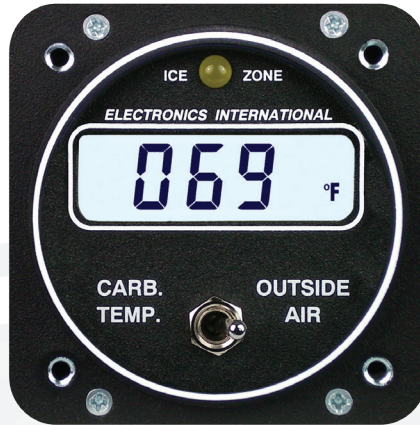
**CA-1 Carb. Temp and OAT**

(STC'd, TSO'd and PMA'd)

Carb. Temp and OAT Instrument with Ice Zone Warning Light.

Kit Includes: Unit, 2 6' Cables, 1 Carb. Temp Probe and 1 OAT Probe.

Price: \$399.00

**EAC-1 EGT, CHT and OAT**

(STC'd, TSO'd and PMA'd)

Single Channel EGT/OAT/CHT Kit with Ice Zone Warning Light.

Kit Includes: Unit, 3 6' Cables, 1 EGT Probe, 1 OAT Probe and 1 CHT Probe.

Price: \$499.00

REMOTE SWITCHES

RS-4-1S (STC'd and PMA'd)

Upgrades our single temperature instrument to read Four Channels of EGT or CHT.

Price: \$349.00 (Specify probe type with order.)

RS-4-2S (STC'd and PMA'd)

Upgrades our dual temperature instrument to read Four channels of EGT and CHT.

Price: \$499.00

RS-6-1S (STC'd and PMA'd)

Upgrades our single temperature instrument to read Six channels of EGT or CHT.

Price: \$469.00

RS-6-2S (STC'd and PMA'd)

Upgrades our single temperature instrument to read Six channels of EGT and CHT.

Price: \$699.00



RS-8-1S (STC'd and PMA'd)

Upgrades our single temperature instrument to read Eight channels of EGT or CHT.
Price: \$589.00



RS-12-1S (STC'd and PMA'd)

Upgrades our single temperature instrument to read Twelve channels of EGT or CHT.
Price: \$799.00



RS-5-1PS (STC'd and PMA'd)

Upgrades any primary TIT/CHT unit to read Four channels of EGT or CHT

Specification: Body 1" x 1" x 1.5" depth, Front Panel 2" x 1.15", 15 Oz. Kit.
Kit Includes: Unit, 4 6' Cables, 4 Probes.
Price: \$589.00
Option: Add \$40 for 4 new FAST Response EGT Probes.



RS-5-2PS (STC'd and PMA'd)

Upgrades any primary TIT/CHT unit to read Four channels of EGT **and** CHT.

Specification: Body 1" x 1" x 1.5" depth, Front Panel 2" x 1.15", 2.2 Lb. Kit.
Kit Includes: Unit, 8 6' Cables, 4 EGT Probes and 4 CHT Probes.
Price: \$589.00
Option: Add \$40 for 4 new FAST Response EGT Probes.

RS-7-1PS (STC'd and PMA'd)

Upgrades any primary TIT/CHT unit to read Six channels of EGT or CHT.

Specification: Body 1" x 1" x 1.5" depth, Front Panel 2" x 1.15", 27 Oz. Kit.
Kit Includes: Unit, 6 6' Cables, 6 Probes.
Price: \$799.00 Order must specify either EGT or CHT Probes
Option: Add \$60 for 6 new FAST Response EGT Probes

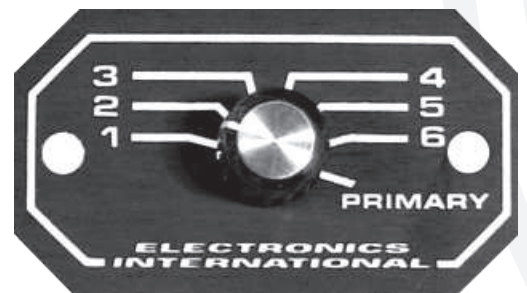

RS-7-2PS (STC'd and PMA'd)

Upgrades any primary TIT/CHT unit to read Six channels of EGT **and** CHT.

Specification: Body 1" x 1" x 1.5" depth, Front Panel 2" x 1.15", 3.2 Lb. Kit.
Kit Includes: Unit, 12 6' Cables, 6 EGT Probes and 6 CHT Probes.
Price: \$799.00
Option: Add \$60 for 6 new FAST Response EGT Probes.

Remote Switches without Probes or Cables:

RS-4-1, RS6-1: \$75 (No Dealer Discounts)

RS-4-2, RS-6-2, RS-7-1, RS-7-2, RS-8-1, RS-12-1: \$98 (No Dealer Discounts)

E-2 or C-2 Dual Channel EGT or CHT

(STC'd, TSO'd, PMA'd)

Specifications: 2 1/4" Mount, 2.5" Depth and 24 Oz. Kit. Accurate to 1/2% with a 1 degree resolution.**Kit Includes:** Unit, 2 20' Cables, 2 EGT Probes and All Wires and Connectors.**Price:** \$589.00**Option:** Add \$20 for Fast Response EGT Probe.**EE-1P or TT-1P or CC-1P Dual Channel EGT or CHT or TIT**

(STC'd, TSO'd, PMA'd)

Specifications: 3 1/8" Mount, 2.5" Depth and 28 Oz. Kit. Accurate to 1/2% with a 1 degree resolution. Operates from 7.5 to 35 volts at .1 amp.**Kit Includes:** Unit, 2 20' Cables, 2 Probes and All Wires and Connectors.**Price:** \$719.00 (Order must specify Over-Temp Limits.)**Option:** Add \$20 for 2 Fast Response EGT Probes.**EC-2 EGT and CHT for Left and Right Engine**

(STC'd, TSO'd, PMA'd)

Specifications: 2 1/4" Mount, 2.5" Depth and 2.5lb kit. Accurate to 1/2% with a 1 degree resolution. Operates from 7.5 to 35 volts at .1 amp.**Kit Includes:** Unit, 4 20' Cables, 2 EGT Probes and 2 CHT Probes.**Price:** \$769.00**Option:** Add \$20 for Fast Response EGT Probes.**EC-1PT EGT and Primary Replacement CHT**

(STC'd, TSO'd, PMA'd)

Specifications: Over temp lights. 3 1/8" Mount, 2.5" Depth and 28 Oz. Kit. Accurate to 1/2% with a 1 degree resolution. Operates from 7.5 to 35 volts at .1 amp.**Kit Includes:** Unit, 2 20' Cables, 1 EGT Probe and 1 CHT Probe.**Price:** \$698.00**TC-1PT Primary Replacement TIT and CHT**

(STC'd, TSO'd, PMA'd)

Specifications: 3 1/8" Mount, 2.5" Depth and 2.2lb Kit. Accurate to 1/2% with a 1 degree resolution. Operates from 7.5 to 35 volts at .1 amp.**Kit Includes:** Unit, 2 20' Cables, 1 TIT Probe and 1 CHT Probe.**Price:** \$698.00 (Order must specify Over-Temp Limits and TIT Probe Type (Hose Clamp, 1/8" NPT, 1/4" NPT or 7/16 x 20).)

AP-7V

Annunciator Panel Kit

Not STC'd (Normally installed as a minor alteration.)

When mounted in front of the pilot, the bright LED's give a quick warning of any out-of-limit condition without having to scan the instrument panel.

Specification: The unit must be connected to the following E.I. instruments: US-8A or SR-8A or UBG-16, FP-5L and/or FL-2, R-1, M-1, and OPT-1. A control switch will dim or turn off the warning LED's. Simple to install (requires only 8 ea. 1/2" holes to mount). Connect to a small 3" x 2" x 1" Control Box tie wrapped to a wire bundle under the instrument panel. Operates at .3 amps.

Size: 5.3" x .9", 10 Oz. Kit, Operates on a 12 or 24-volt system.

Kit Includes: Annunciator Panel, Control Box and all wires and connectors.

Price: \$195.00

AP-7H

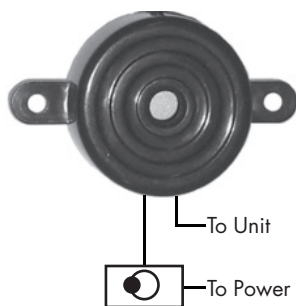
**ATG-1 - Annunciator Tone Generator**

Not STC'd (Normally installed as a minor alteration.)

This unit generates a 4.7KHz tone when an out-of-limit condition occurs. The Annunciator Tone Generator may be connected to one or more E.I. instruments.

Specification: To be used with Instruments featuring a warning light (US-8A, SR-8A, C-1P, T-1P, EC-1P, R-1, M-1, OPT-1, FP-5, etc.). The ATG-1 comes with an on-off toggle switch. It mounts under the instrument panel using wire ties.

Size: 1.3" diameter. Operates on a 12 or 24-volt system.

Price: \$19.50

AL-1(x) - Chrome Annunciator Light

Not STC'd (Normally installed as a minor alteration.)

(x) = "R" for Red, "Y" for Yellow, "B" for Blue, "G" for Green or "O" for Orange. The AL-1 makes an excellent indicator light for displaying boost pump on, gear status, power on, flags, etc. Also, it can be used as a remote warning light for any E.I. instrument featuring an external warning line. The AL-1 is more attractive, operates on less power and is smaller than the old fashioned indicator lights. The AL-1 has a service life of over 1000 times that of incandescent bulbs.

Specification: Mounts in a 5/16" hole.

Size: .4" diameter x 1" depth. Operates on a 12 or 24-volt system. Comes with 32" leads.

Price: \$19.50



VOICE ANNUNCIATOR

17 Voice Warnings

Oil Pressure and Temperature
 Fuel Level and Pressure
 RPM
 Manifold Pressure
 Altitude and Timer
 Cylinder Head Temperature
 Exhaust Gas Temperature
 Turbine Inlet Temperature

Engine Analyzer
 Bus Voltage
 Gyro Vacuum
 Landing Gear
 Air Speed
 Oil Pressure
 Fuel Level
 Timer
 Chime Only (no voice)



AV-17



Control Panel

The Voice Annunciator (AV-17) can provide from one to seventeen verbal warnings through your headset. The AV-17 ends the need to constantly scan instruments. It also eliminates concern about missing an alarm at a critical moment. The instant a monitored alarm occurs, the Voice Annunciator will chime in the headset and a pleasant female voice will announce a phrase, such as: "Check Oil Pressure," or "Check Altitude," etc.

The AV-17's voice alarm in the headset provides an instant and clear understanding of what's going on in the cockpit without the hassle of having to scan instruments, decipher functions, interpret readings or translate numerous bongs, buzzes or beeps.

The AV-17 connects to the headset through the Audio Panel or Intercom or it may be connected directly to the headset. The AV-17 receives most of its warning signals from any one or more of Electronics International's instruments which feature a warning light. However, other alarm inputs can be received from any warning device that drives a horn or light.

It is not necessary to activate all seventeen of the AV-17's warnings. A "Check Bus Voltage" warning is built into each AV-17. Further voice alarms can be activated as Electronics International instruments are added to the panel.

The AV-17 is compact. A 4.1" x 2.6" x 1.7" Control Box tie wraps under the instrument panel. Also, there is a small 1" x 1" Control Panel that mounts on the aircraft instrument panel. The Control Panel allows you to turn the Voice Annunciator on or off. Also, it allows you to acknowledge and thereby deactivate any active alarm for either 1 minute or 10 minutes. The AV-17 voice alarms are activated by pulling the appropriate control line to ground (0 volts).

AV-17 Price: \$285.00

AVI-1 Price: \$19.50 This module allows a positive voltage to activate one AV-17 control line.

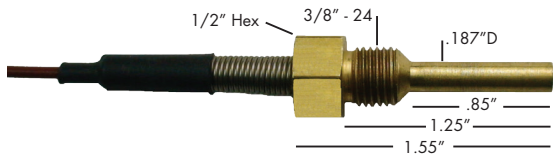

P-100 - CHT Probe

Screw-in Type, Standard with most Kits. Can be used in a pressure environment, 700°F Max.

Price: \$94.00



P-101 - CHT Probe

Military Bayonet Type, 1/4 turn locking for quick removal. To be used with the A-101 Adaptor. 700°F Max.

Price: \$99.00

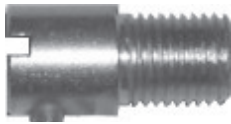

A-101 - CHT Adaptor

3/8" - 24, To be used with the P-101 CHT Probe.

Price: \$12.00

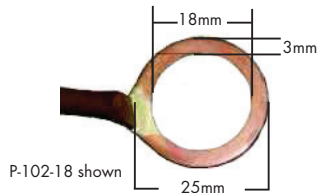

P-102-18: CHT Probe, 18 mm. Gasket Type 700°F Max.

P-102-14: CHT Probe, 14 mm Gasket Type 700°F Max.

P-102-12: CHT Probe, 12 mm Gasket Type 700°F Max.

P-102-3/8: CHT Probe, 3/8" Piggy-Back Gasket Type 700°F Max.

Price: \$94.00

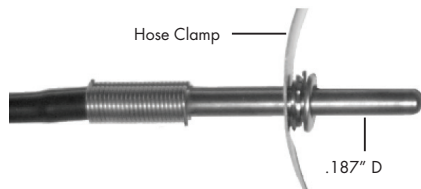

P-110 - EGT/TIT Probe

Hose Clamp Type, Used with 13/64" Hole. Standard with most kits. Weight: 1.6 oz.

Price: \$94.00

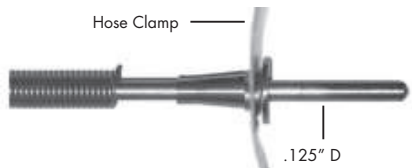

FAST RESPONSE P-110 - EGT/TIT Probe

Hose Clamp Type, used with .130" hole. Optional with most kits. Weight: 1.3 oz.

Price: \$104.00



P-111: TIT Probe, 1/8" NPT, with Adjustable Depth.

Price: \$99

P-112: TIT Probe, 7/16" - 20, with Adjustable Depth.

Price: \$99

P-114: TIT Probe, 1/4" NPT, with Adjustable Depth.

Price: \$99

P-111 & P-114 Available in FAST Response Style with a .125" D tip. Price: \$109/ea

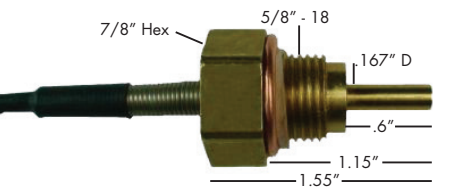

P-120 - Oil Temp Probe

Can be used in a pressure environment, 700°F Max. Weight: 2.5 oz.

Price: \$94.00



P-128 - OAT/Carb Temp. Probe

FAST Response Exposed Tip, Uses a precision connector, 700°F Max.

P-128-S - Sealed Tip Temp. Probe

For use in pressure environments, uses a precision connector, 700°F Max.

Price: \$94.00



P-104: Universal Probe

Used to measure surface temperatures, 700°F Max.

Price: \$94.00

FFDM-1 - Fuel Flow Differential Module - Price: \$395.00

Used with the FP-5 or FP-5L to accommodate a pressure carburetor with a fuel return line back to the fuel tank. Please specify FT-60, FT-90 or FT-180 Flow Transducer. This should be the same type of transducer that was installed with the FP-5 or FP-5L.

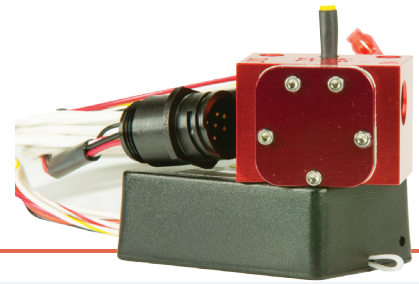
**FT-60 - Fuel Flow Transducer (Red Cube) - Price:** \$295.00

To be used with engine-driven fuel pumps only up to 350 HP engines. Red anodized aluminum body, 1/4" female NPT, .6 to 70+ GPH, .6 PSI drop at 30 GPH, 2.3 PSI drop at 60 GPH, K-Factor approximately 68,000, 5.3 Oz.

FT-90 - Fuel Flow Transducer (Gold Cube) - Price: \$295.00

For 350 to 550 HP engines, or gravity feed engines. Gold anodized aluminum, 1/4" female NPT, 3 to 125+ GPH, .05 PSI drop at 20 GPH, .2 PSI drop at 40 GPH, K-Factor approximately 33,800, 5.3 Oz.

FT-180 - Fuel Flow Transducer (Black Cube) - Price: \$495.00

Black anodized aluminum body, #8 male flare fittings, 5 to 250+ GPH, .23 PSI drop at 60 GPH, .92 PSI drop at 120 GPH, K-Factor approximately 22,400, 5.3 Oz. The EI FT-180 (Black Cube) Flow Transducer does not require the IU-1 Foxboro Interface Unit.

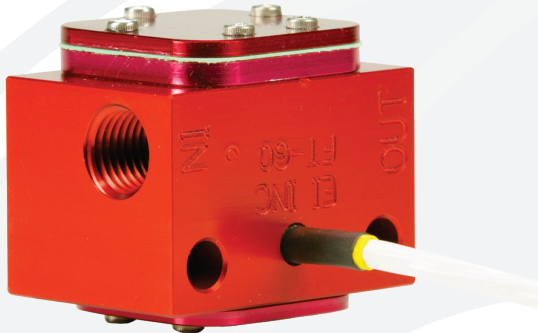
**PT-30GA - Pressure Transducer - Price:** \$195.00

1/8" NPT Male, 0 to 40 PSI, Max. Over Pressure 90 PSI, Burst Pressure 120 PSI, Shock 100g, Material 316L SS, 8 Oz.

PT-100GA - Pressure Transducer - Price: \$195.00

1/8" NPT Male, 0 to 120 PSI, Max. Over Pressure 300 PSI, Burst Pressure 400 PSI, Shock 100g, Material 316L SS, 8 Oz.

PT-300GA - Pressure Transducer - Price: \$195.00

1/8" NPT Male, 0 to 300 PSI, Max. Over Pressure 900 PSI, Burst Pressure 1200 PSI, Shock 100g, Material 316L SS, 8 Oz.

PT-3000S - Pressure Transducer - Price: \$250.00

1/8" NPT Male, 0 to 3000 PSI, Max. Over Pressure 9,000 PSI, Burst Pressure 10,000 PSI, Shock 100g, Material 316L SS, 8 Oz.

**IU-1 - Foxboro Interface Unit - Price:** \$173.00

Electronics in a lumpy cable used to interface a Foxboro or Flow Technologies Transducer to the FP- 5(L). K-Factor for a Foxboro Transducer is approx. 33,800. The IU-1 is not needed for EI's FT-180 (Black Cube) Flow Transducer.

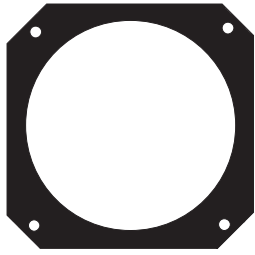

A-102 - Adaptor Plate - Price: \$12.00

Makes a 2 1/4" E.I. Instrument look excellent in a 3 1/8" mount, Black Powder Coated Aluminum (matches the instruments).

A-103 - UBG-16 Adaptor Plate - Price: \$19.50

Use this Adaptor Plate to mount the UBG-16 in a 3 1/8" hole.

XO-6 - Price: \$39.00

6' Extension Cable with Overlap (OLC-1) connectors on each end.

XCO-6 - Price: \$39.00

6' Extension Cable with circular to Overlap (OLC-1) connectors. Used on UBG-16, US-8A and SR-8A.

XDO-6 - Price: \$39.00

6' Extension Cable with D-sub pin to Overlap (OLC-1) connectors. Used on MVP-50 and CGR-30.

XO-20 - Price: \$69.00

20' Extension Cable with Overlap (OLC-1) connectors.

XCO-20 - Price: \$69.00

20' Extension Cable with circular to Overlap (OLC-1) connectors. Used on UBG-16, US-8A and SR-8A.

XDO-20 - Price: \$69.00

20' Extension Cable with D-sub pin to Overlap (OLC-1) connectors. Used on MVP-50 and CGR-30.

Note: Extension Cables can be ordered to custom lengths for \$1.60 (retail) per foot for each foot over the standard lengths of 6' and 20' shown above. Please allow a minimum of 2 weeks for custom cable lengths to be shipped.

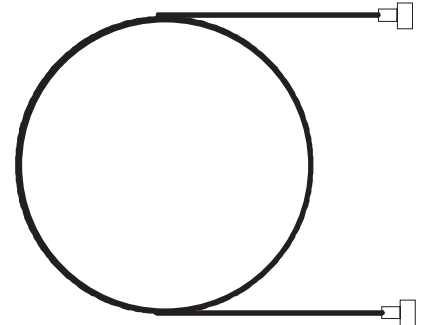

CP-1 - LED Intensity Control Pot and Electronics - Price: \$29.00

Controls the intensity of the UBG-16 (Plasma Display), green LED's on R-1, M-1, OPT-1, FL-2, FP-5(L) and other EI instruments. This unit can be connected to any one or all of these instruments at the same time. It provides linear control of the intensity of the green LED's for low ambient light or night operation. Mounts in a 1/4" hole. Operates on a 12 or 24-volt system.

Note: The CP-1 is a low current, high impedance control pot with offsets and gains designed to control the intensity of EI's LED's & Plasma displays ONLY. Not appropriate for other applications.

S-50 - Price: \$39.00

50 amp, 50mV (100 amp capability) External Shunt. To be used with a VA-1A-50. Size 2" x 1.2" x 1.7" height. 3.5 Oz. Unit.



S-300 - Price: \$49.00

300 amp External Shunt. To be used with a VA-1A-300, Size 3.25" x 1.75" x 1.75" height. 11.5 Oz. Unit.



P-300C: Capacitive Fuel Level Probe with Accessories

The P-300C is assembled from a 3/4" aluminum pipe with an aluminum center electrode and a 3/4" NPT boss attached to one end. The electronics (P-300C Interface Module) are located externally from the probe. The probe was designed to fit in a 3/4" NPT. Coupler and Guides (included with the probe), are intended to be molded into a fiberglass fuel tank. You may wish to use other mounting methods appropriate for your fuel tanks. The probes may be ordered from 4" to 20' in length. A P-300C/4 Divide by 4 Interface module will be included at no charge for probe lengths that require one. Ordering the correct length is **recommended**, however you may cut the probes to a shorter length than ordered. Call EI for cutting instructions. Probes over 8' may incur additional shipping expenses.

Price: \$395.00 ea., plus shipping. (Specify Length 6" to 20') (No OEM Discounts). **Please allow a minimum of 3 weeks for your order to be shipped.**

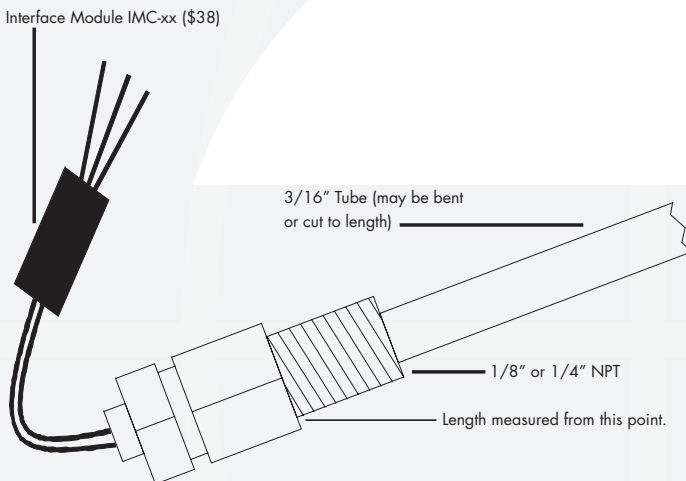
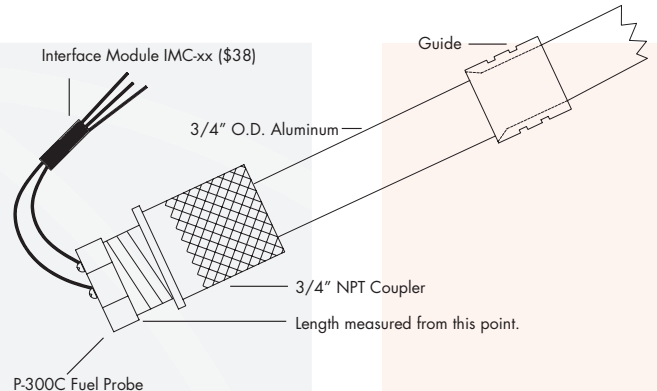

P-300C-Mini-1/8: 1/8" NPT Capacitive Fuel Level Probe P-300C-Mini-1/4: 1/4" NPT Capacitive Fuel Level Probe

The P-300C-Mini is assembled from a 3/16" stainless steel tube with an insulated wire as the center electrode and a 1/8" NPT or 1/4" NPT boss attached to one end. The electronics (P-300C-Mini Interface Module) are located externally from the probe. The probe may be bent or cut to length in the field. The probe can be ordered from 2" to 72" in length. A P-300C/4 Divide by 4 Interface module will be included at no charge for probe lengths that require one. Ordering the correct length is **recommended**.

Price: \$249.00 ea., plus shipping. (Specify Length 2" to 72") (No OEM Discounts). **Please allow a minimum of 3 weeks for your order to be shipped.**

P-300M Magnetic Float Sensor

The P-300M is a PMA'd fuel level sensor designed by E.I. to replace a resistive sensor. The P-300M works off magnetics and is an amazingly accurate and reliable sensor. It is not affected by vibration, corrosion, wear, varnish build up, poor wiper tension or any of the many other problems affecting resistive sensors. The P-300M will only work with E.I. instruments. The float travel must be specified. If an existing sensor is to be replaced, ship your old sensor to E.I.

Price: \$395.00 ea. Plus shipping, (Specify float travel, No OEM Discounts). **Call E.I. for availability.** Add \$375 if custom plate is needed (one-time charge).

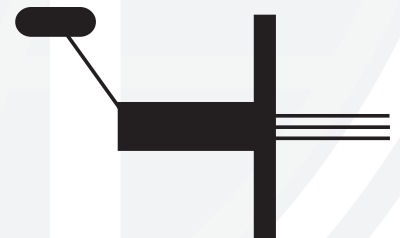

Providing **Superior** Products
and Unparalleled Customer Service Since 1979



 Learn more about Electronics International and its products at www.Buy-Ei.com