

## Benefits & Features

### OPERATION

The vertical operation of the Compact Garage Door means you can park as close to the door as possible, creating precious space on your driveway.



### CONSTRUCTION

Our Compact Garage Door rolls up into a very compact box which is ideal for restricted headroom openings.

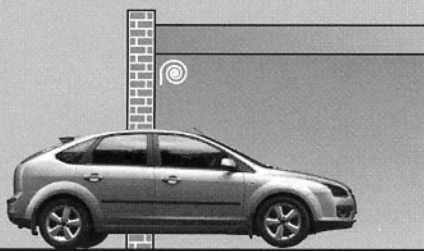

### DESIGN

With a standard up-and-over garage door the side walls and overhead storage spaces are wasted. Our Compact Garage Door creates that extra valuable space.



### DETAILED DIAGRAM

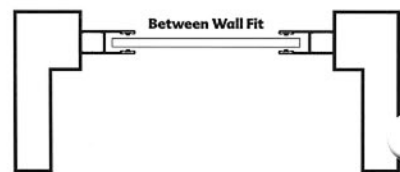
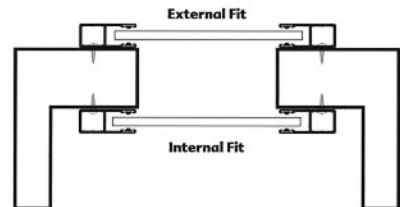
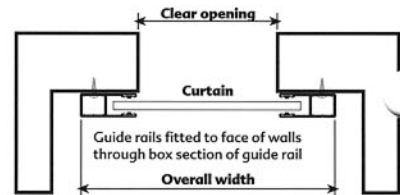
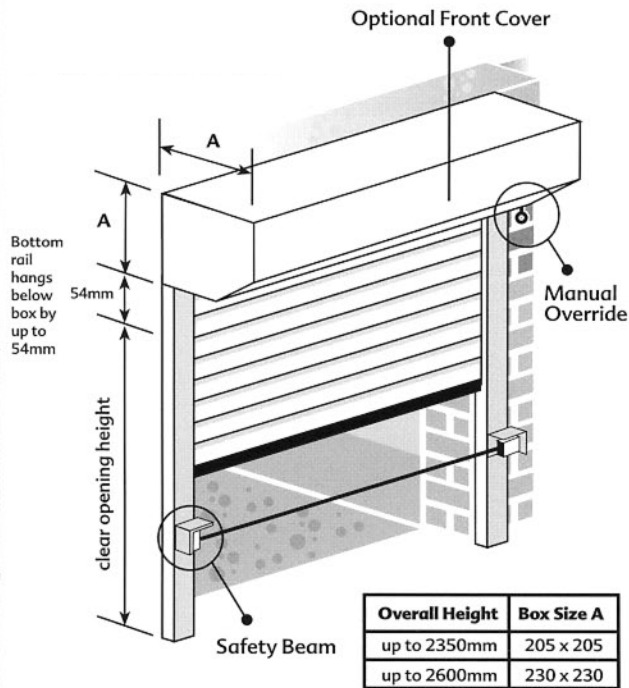

Compact Box detail

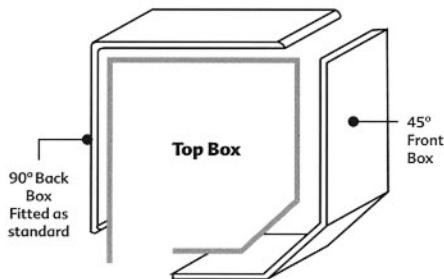

Compact Guide Rail

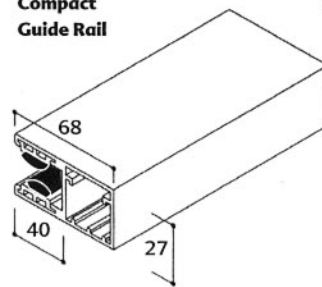

Compact Profile

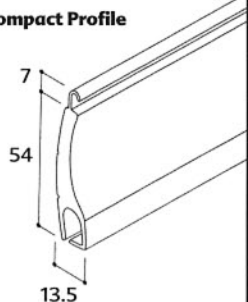

Ideal for garages with limited internal or external headroom, the Compact Ultimate Garage Door neatly rolls up into housings that start from 205mm (8").

Operated via a Somfy tubular motor complete with a manual override facility. Controlled by a remote controlled unit comprising of a courtesy light, internal push buttons, rolling code technology and 2 handsets.

Manufactured from high quality foam filled 54mm aluminium slats with a heavy duty bottom rail, the Compact Ultimate Garage Door simply slides up and down within its aluminium powder coated brush lined side guides. Standard features for the Compact

Ultimate Garage Door include a 90° Back Box on internal fit doors with an optional extra for a 45° Front Box. On externally fitted doors a full 90° Back Box and 45° Front Box is fitted as standard.

Safe and secure in operation the Compact Ultimate Garage Door is fitted as standard with a safety beam which spans the width of the door opening, if obstructed or broken the Compact Ultimate Garage Door simply returns to a safe zone to avoid any accidents.

The Compact Ultimate Garage Door is also fitted with an automatic locking system making your door secure when fully lowered.