

# Changing Places: the practical guide





# **Changing Places: [the practical guide](#)**

**Changing Places Consortium**

# Contents

## Foreword

P4

Foreword by Baroness Tanni Grey-Thompson DBE  
Acknowledgements by the Changing Places Consortium  
Note on terminology

## 1 Introduction

P6

About this guide  
What are Changing Places toilets and why do we need them?  
How is a Changing Places toilet different from an accessible WC?  
Who uses Changing Places toilets?  
Where should Changing Places toilets be provided?

## 2 Legislative background

P20

Equality legislation and treaties  
Building Regulations, design guidance and codes of practice  
Health and safety legislation  
Recommendations for risk management

## 3 Planning and design

P30

Consultation  
Professional advice  
Statutory consents  
Room layout  
Planning Changing Places toilets in different venues  
Portable Changing Places toilets  
Accessible routes  
Signage and wayfinding  
Planning and design checklist

## 4 Equipment and environment P49

Doors	Shower
Door locks	Shower seat
WC	Waste bins
Grabrails and drop-down support rails	Mirror
Height-adjustable washbasin	Assistance alarm
Taps	Coat hooks
Soap dispenser	Sanitary-towel dispensers
Hand drying	Heating
Ceiling track hoist	Water supply
Hoist slings	Ventilation
Privacy screen	Lighting and décor
Height-adjustable changing bench	Equipment and environment checklist
Wide paper roll dispenser	

## 5 Finance P71

- Construction costs
- Funding
- VAT relief
- Charities

## 6 Management and maintenance P75

Staff training	Equipment tests and maintenance
Security	Day-to-day management
Information Management	Management checklist

## 7 Sources of further information P87

Organisations	Other publications
Standards	HMRC Notices
Legislation	

## Index P90

# Foreword

## Foreword



**Baroness Tanni Grey-Thompson opening the CP facilities at Middlesbrough Bus Station**

**Imagine having to change your son, daughter or partner on the floor of a public toilet.**

Imagine how you would feel if you were that person on that floor. Sadly, there are thousands of disabled people and families who do not have to use their imagination. For them, this is a daily reality.

Standard accessible toilets meet the needs of some disabled people – but not all. Over 230,000 people in the UK need personal assistance to use the toilet or change continence pads, including people with profound and multiple learning disabilities, spinal injuries and people living with stroke.

Without appropriate facilities, carers are forced to change continence pads on public toilet floors or wait until they go home. This is unhygienic, undignified and unacceptable.

Changing Places toilets offer a solution. They are larger facilities that have the right equipment, including a changing bench and

a hoist, designed to support disabled people who need assistance.

In the last decade we have seen hundreds of Changing Places toilets installed across the UK, including in major shopping centres, airports, train stations and town centres.

We have seen first-hand how Changing Places toilets open up a world of possibility. The summer of 2012 saw many people with complex and multiple disabilities and their families able to be a part of the London Olympic and Paralympic Games due to the availability of Changing Places toilets at the various sites and venues. We have also heard about the benefits from those who install the toilets and the advantages to local communities.

However, while progress has been made, more is needed if we are to meet the demand for Changing Places toilets and to see them in all public areas.

This guide is designed to offer information and guidance to all those considering installing a Changing Places toilet and for those who are already going through the process of installing one.

Everyone has a right to access their community. On behalf of all those who need Changing Places toilets, their families and the Changing Places Consortium, thank you for being a part of this.

**Baroness Tanni Grey-Thompson DBE**

# Acknowledgements

**Behind every Changing Places toilet is a group of passionate people who made it happen. Without the support of individuals, families, professionals and organisations, we would not be where we are today.**

Over the last ten years we have seen a growing number of planning and building professionals who are involved in the installation of Changing Places toilets across the UK. This guide has been developed to provide support and guidance to all those involved.

On behalf of the Changing Places Consortium, we would like to take this opportunity to thank all those who have made this guide possible.

Thank you to everyone who has contributed to the guide, in particular the professionals who provided advice and guidance along the way, the venues that are featured and the individuals who allowed us to share their personal experiences. Furthermore, a special thank you to the Centre of Accessible Environments for their pivotal role in the creation of this guide.

We also want to share our gratitude with all the members of the Changing Places Charter group, the Department for Communities and Local Government, the Scottish Government, the Northern Ireland Assembly and the Welsh Assembly for their ongoing support, guidance and commitment to the cause. We would also like to thank [Aveso](#) for sponsoring the Changing Places Campaign, which enables us to work towards our goal.

Finally, we would like to pay special tribute to the Rix-Thompson-Rothenberg Foundation and the Baily Thomas Charitable Fund for funding the production of this guide.



**RTR Foundation**



**Beverley Dawkins OBE and Loretto Lambe**  
Co-Chairs, Changing Places Consortium

## Note on terminology

When accessing Changing Places toilets, disabled people may be accompanied by one or more other person(s) who may be professional carers, support workers, personal assistants, partners, parents or other family members, friends or other companions. The Changing Places Consortium acknowledges that these are all distinct roles but has adopted the term 'assistant' throughout this guide to refer to any person facilitating access to and use of equipment for the disabled person.

## © Changing Places Consortium

Author and illustrations: Alison Grant

Project Editors: Wai Chan and Madeleine Gray

Designed and typeset by: James Foulger



# 1 Introduction

## About this guide

***Changing Places toilets: the practical guide* aims to provide readers with practical guidance on the design and management of a Changing Places (CP) toilet, as well as an understanding of why they are needed and who is likely to benefit from them.**

The need for specialist toilet and changing facilities, which enable people with profound and multiple learning disabilities, their carers, assistants and families to enjoy days out was first brought to public attention by the learning disability organisation PAMIS. In 2006, the *Changing Places, changing lives* campaign was launched by the Changing Places Consortium. The campaign's continuing aim is to improve the lives of people who require CP facilities. More CP toilets are needed to allow freedom of movement and dignity for everyone.

This guide is intended for use by people responsible for the design and management of buildings, including:

- building owners
- property developers
- facilities managers
- architects and designers
- access consultants
- occupational therapists
- planning and building control officers
- representatives of public authorities.

It includes detailed design guidance based on the recommendations in the British Standards Institution's best-practice guide BS 8300, which is supplemented with good practice advice from members and supporters of the Changing Places Consortium. Case study examples illustrate different points and provide demonstrations of CP facilities in practice. There are checklists at the end of the Planning, Equipment and Management chapters for a quick and easy reminder of the key points.

## Changing Places Consortium

The Changing Places Consortium supports the installation of CP toilets in key public buildings. The Consortium provides information on the location of existing CP toilets, including a searchable map, address and contact details of the venue, opening times, details of the equipment and public access. The Consortium also publicises the location and expected opening date of forthcoming CP toilets.

Members of the Consortium are:

**PAMIS, Royal Mencap Society, Centre for Accessible Environments, Dumfries and Galloway Council , Nottingham City Council, Scottish Government**



## What are Changing Places toilets and why do we need them?



© Tony Mould – My Brighton and Hove website

A CP toilet provides sanitary accommodation for people with multiple and complex disabilities who have one or two assistants with them.

Without a suitable changing bench, many disabled people have to be laid on the floor to be changed. This is undignified, unhygienic and puts assistants at risk of injury. In the absence of a hoist, assistants are again put at risk when forced to manually transfer a disabled person who is unable to self-transfer between a wheelchair and WC.

The absence of toilet and changing facilities means that some disabled people are often limited in terms of activities available to them, or even prevented from going out altogether. They may also find themselves compromising their health and dignity – or that of the people assisting them – by using unsuitable facilities. CP toilets can vastly improve people's quality of life, allowing disabled people and their assistants to stay out for longer and participate in more activities.

## How is a Changing Places toilet different from an accessible WC?

A standard accessible WC is designed for independent use by an individual. Grabrails (fixed-position handrails) are located to the side and rear of the pan, aiding self-transfer between a wheelchair and the WC. In some cases, a wheelchair user may be assisted, but there is usually insufficient room for two assistants. Standard accessible WCs are designed to facilitate access by a standard wheelchair, but are unlikely to accommodate a powered wheelchair, or those fitted with additional head or leg supports.

CP toilets are designed for people who cannot use standard accessible toilets. A CP facility must include:

- height-adjustable, adult-sized changing bench
- ceiling track hoist system
- adequate space for the disabled person and up to two assistants
- centrally located toilet with space both sides for assistants
- privacy screen
- wide paper roll
- large waste disposal bin
- washbasin, preferably height adjustable

In addition, **shower facilities** are recommended for managed buildings, such as leisure centres, transport hubs or specific projects. A shower is not required for all Changing Places toilets.

See Chapter 4, **Equipment and environment**, for further details on equipment in CP toilets.

CP facilities should be provided **in addition** to the full range of single-sex and standard accessible WCs and baby changing facilities.



CP toilets are designed for people who need additional space, equipment, time and assistance. They may not be suitable for people who can use standard accessible toilets independently.



Standard accessible corner WC for independent use: minimum 1.5m by 2.2m in size, no equipment or space to change an adult or for assistants



Changing Places facility for assisted use: minimum 3m by 4m in size, including a centrally located WC with space for assistants either side, adult-sized height-adjustable changing bench, a ceiling track hoist and privacy screen

© City Hospital, Nottingham University Hospitals NHS Trust

## Who uses Changing Places toilets?

Research undertaken at the University of Dundee concluded that up to a quarter of a million disabled people throughout the UK are potential users of CP toilets. See Chapter 7, **Sources of further information**. This figure excludes potential users who are able to use standard accessible toilets. With ongoing advances in medical science and better healthcare, the number of people who will need a CP toilet is constantly increasing.

The range of people who might use CP toilets include:

- people with profound and multiple learning disabilities
- people with conditions that may affect their movement, including cerebral palsy, multiple sclerosis, motor neurone disease
- people with head injuries or severe spinal injuries
- people living with stroke
- older people who require assistance
- ex-service personnel.

People who are unable to transfer independently or have no sitting balance need additional facilities such as a ceiling track hoist to transfer between their wheelchair, the WC and an adult-sized changing bench. Many people with profound and multiple learning disabilities are doubly incontinent and have total dependency on assistants. They need access to facilities where they can be changed with dignity and where assistants are able to use a hoist and other equipment to provide appropriate and safe care.

CP facilities also allow assistants to use the toilet, without leaving a disabled person unattended. This is not possible in standard toilet facilities which do not provide a privacy screen or enough space. A privacy screen must be included in all CP toilets.



Thanks to the CP facility, Seth can exercise at his local gym, which helps him control his condition © Karen Warner

Seth is a young man with autism and mitochondrial myopathy, whose mother, Sol, cares for him. Previously Seth was unable to get out of bed and had great difficulty eating and drinking, but a specially designed exercise programme has helped him make great progress. Seth is able to attend sessions at his local gym thanks to a CP facility, and can access the jacuzzi via a hoist.

Sol says:

**“Gentle exercise lets us control Seth’s condition without medicines and medical equipment. He is now able to walk again with a frame, and has the potential for independent walking once more, which is absolutely fantastic.”**



CP facilities help Gabriel participate in more activities for longer

Gabriel has multiple sclerosis. He is unable to stand and uses a wheelchair to move around. He requires assistance, particularly when away from home. Gabriel needs a hoist, changing bench, peninsular-style toilet and a room big enough for an assistant and his wheelchair.

Because there are few CP toilets in his area, Gabriel is extremely restricted as to where he can go. On numerous occasions he has had to cut trips short and return home. He explains:

**“The provision of CP toilets would enable me to take part in a greater number of activities, for longer periods, safe in the knowledge that CP facilities are available if I need them.”**

Lowri is 12 years old and has Rett Syndrome. She is a wheelchair user with no independent mobility and needs complete 24-hour support with all aspects of her care. Lowri wears continence pads, which need to be changed in a CP toilet.



Without CP toilets, Lowri either has to be changed in unsanitary conditions or stay at home

Thanks to the installation of CP toilets in the local area, Lowri's mum, Bethan, has been able to take the whole family out and stay out for longer in Nottingham. She says:

**“I was able to take Elin and Lowri shopping for school clothes in the morning, have lunch and then go straight on to the theatre, just like anyone else would have done.”**

Changing Lowri in the absence of a CP toilet can be very difficult, says Bethan:

**“We try to plan our days around being home for meal times because Lowri needs to go to the toilet, meaning we can only spend a few hours away from home. We put a large mat on the floor and just muddle through – we have countless experiences at eye level of disgusting toilet floors.”**

## Where should Changing Places facilities be provided?

CP facilities should be provided in buildings and locations where large numbers of people may visit, such as major entertainment venues, as well as places people may visit for several hours at a time, such as schools or colleges.

A CP facility should be provided in:

- major transport terminals or interchanges such as airports, large railway and bus stations
- motorway service stations
- sport and leisure facilities, including entertainment arenas, stadiums, large hotels, large theatres and multiplex cinemas
- cultural centres such as museums, concert halls and art galleries
- shopping centres, large retail developments and Shopmobility centres
- key public buildings within town centres such as town halls, civic centres and principal public libraries
- educational establishments, including universities
- health facilities such as hospitals, health centres and doctors' surgeries.

Portable CP toilets should also be provided at large outdoor and temporary events such as music festivals, concerts and agricultural shows.

The following case studies are just some examples of Changing Places facilities found in different types of buildings.



## Sutton Railway Station



Sutton Railway Station was the first station to install a CP facility. As a result, Southern the operator, won the Loo of the Year Awards 2011(England category). Sutton Railway Station was also Highly Commended in the Passenger Experience category of the Railway Industry Innovation Awards 2010 for its CP toilet.

**“We have published a commitment to provide a more accessible rail network, so it made sense for us to become the first train operator in the country to provide Changing Places facilities at one of our key stations.**

**This toilet makes a substantial contribution towards opening up train travel to more members of our local communities, enabling more passengers with disabilities to travel knowing there’s a toilet at Sutton which meets their needs.”**

**Kirsty Monk**, *Southern’s Accessibility Manager*

The Eurotunnel Passenger Terminal in Folkestone, Paddington and Kings Cross train stations are all major rail stations that have also installed CP facilities, with the Eurotunnel CP toilet winning the Changing Places category in the Loo of the Year Awards 2012.



George Best Belfast City Airport was the first airport in the UK to install a CP facility in 2010, followed by East Midlands, Birmingham and Newcastle Airports. In 2012, Gatwick Airport opened two CP facilities, one in each terminal.

**“We are constantly listening to our customers and delivering facilities that make using the airport easier for all our passengers and visitors. This decision has been vindicated through the very positive feedback we’ve received.”**

**Brian Ambrose**, *Chief Executive of George Best Belfast City Airport*



George Best Belfast City Airport

CP campaigners Julie Clough and her mother Margaret attended the official openings of the CP toilets at East Midlands and Gatwick Airports.

**“From the moment the Changing Places team first approached us, we were proud to be able to support their campaign. As an airport that caters for millions of passengers, it is essential to provide a first class facility.”**

**Brad Miller**, *East Midlands Airport Managing Director*



CP Campaigners Julie Clough and her mother Margaret with airport representatives at the opening of the CP facility at East Midlands Airport

**“One in six of Europe’s population is disabled, so it is vital we provide appropriate facilities, in all ways. Margaret made us aware of the worth of a Changing Places toilet, beyond our conventional accessible toilets, and we judged it a valuable addition to make people’s experience of London Gatwick as enjoyable as possible.”**

**Lindsay Baldwin**, *Head of Airport Communications at Gatwick Airport*

**“This demonstrates commitment towards creating a safe and easy way for carers and those with disabilities to travel freely through the airport. The new changing facilities will make a huge difference to families who need additional support.”**

**Margaret Clough**, *Changing Places Campaigner*



# Bus or Car

## Middlesbrough Bus Station



The CP toilet at Middlesbrough Bus Station provides a centrally located facility for people in the town centre, as well as those using bus services.

**“We welcome the addition of any facilities to the town centre which enable more people to visit Middlesbrough town centre. It is well used and enables disabled shoppers, visitors and their families to come to our town safe in the knowledge that there is a facility they can use which meets their needs.”**

**Richard Horniman**, *Economic Development Manager, Middlesbrough Council*

Other bus stations with Changing Places toilets include Stoke, Bromsgrove and Swansea City bus stations.

## Moto Cherwell Valley



CP facilities at motorway service stations allow those who need them to travel further in safety and comfort.

There are currently very few motorway services providing Changing Places facilities. Moto Cherwell Valley service station in Oxfordshire (Junction 10 on the M40) was the first to provide a CP toilet.

**“There are almost a quarter of a million people in this country who can’t use a standard accessible toilet. We are extremely proud to introduce this extended and much needed facility to the motorway network.”**

**Tim Moss**, *Chief Executive of motorway services operator Moto*

There are also CP facilities available at the Moto Toddington Northbound service station, between Junctions 11 and 12 of the M1.







## Retail

IKEA Edinburgh includes a CP facility



The CP facility at the IKEA outlet in Edinburgh benefits both staff and customers.

**“At the IKEA Group, we believe that taking responsibility for people is a prerequisite for doing good business. The decision to install a Changing Places toilet was entirely our own, in our desire to create something to benefit our co-workers as well as our customers.”**

**Elizabeth Stanton**, *IKEA Community Educational Support Specialist*

Shopping centres and large retail stores are places that CP users and their families will want to spend time visiting.

Current CP providers include the Trafford Centre in Manchester, WestQuay and Westfield shopping centres in Derby and Stratford (East London), with two available in the Stratford centre.

Debenhams Blackpool, Co-operative store Ilkeston, and Asda Superstore Chaucer Road, Sheffield, also provide CP toilets in-store.



## Leisure

Capital FM Arena is a major entertainment venue





Capital FM Arena Nottingham, based within the National Ice Centre, is a large entertainment venue whose chief executive, Geoff Huckstep, has seen how CP facilities benefit visitors:

**“We want our venue to be accessible to everyone, which is why we were so keen to get this facility installed at the Arena. We are proud to be the first arena in the country to do this and we would encourage others to follow.”**

Opening the facility with Nottingham City Councillor Eunice Campbell was Sara Brett from Nottingham. Sara has cerebral palsy and needs 24-hour care. Her sister, Linda, explained the difference the CP toilet would make:

**“Every time we go to the Arena we usually have to leave before the end because Sara needs the toilet, but that won’t happen now.”**



The opening (above) of the CP facility (top right) at Capital FM Arena Nottingham



### Long Barn visitor centre

Long Barn visitor centre was the first UK National Trust property to install CP facilities. Located on the side of Divis and the Black Mountain, Northern Ireland, the centre offers scenic views of Belfast and beyond.



Long Barn visitor centre, Divis and the Black Mountain



The view from the CP facilities at Long Barn

“Disabled visitors and their families will now be able to enjoy this spectacular place – from which they would otherwise have been excluded.

The opening of the Long Barn and Changing Places, on these wonderful hills, will add to the visitor experience for so many people in Belfast, Northern Ireland and further afield.”

**Hilary McGrady**, *National Trust Regional Director for Northern Ireland*

Giant’s Causeway, Antrim in Northern Ireland, Garwnant Visitor Centre in Merthyr Tydfil, Wales and the Camel Trail Gateway public conveniences in Wadebridge, Cornwall are just a few other CP locations which also enable more disabled visitors to explore outdoor trails and natural environments.

### **The Eden Project**

The Eden Project’s ecological gardens attract over a million visitors every year and aim to provide a great experience for all ages, abilities and backgrounds. Installing CP facilities has helped them to achieve that aim.

“It has always been our ambition to make Eden as accessible as we can to anyone who wants to come. Thanks to the work of our very dedicated staff and partnerships with Cornwall Council through the Aiming High programme, the Sensory Trust and the Changing Places campaign, we’re really pleased that we’ve been able to make this important step forward.”

**Tony Kendle**, *Director, The Eden Project*



The Eden Project (above) provides a CP facility (below), so more disabled visitors and their families can enjoy a full day at the attraction © Eden Project



Rachel George, who attended the official opening with her four year old son Adam, said:

“A facility like this makes the difference between visiting somewhere for a couple of hours and being able to stay for a day. It’s fabulous.”

Cadbury World in Birmingham, Royal Botanic Gardens, Kew, Pili Palas Nature World in Anglesey and Marwell Zoo, Hampshire are just a few other popular visitor attractions with CP toilets.



# Key public buildings

## Warminster Civic Centre

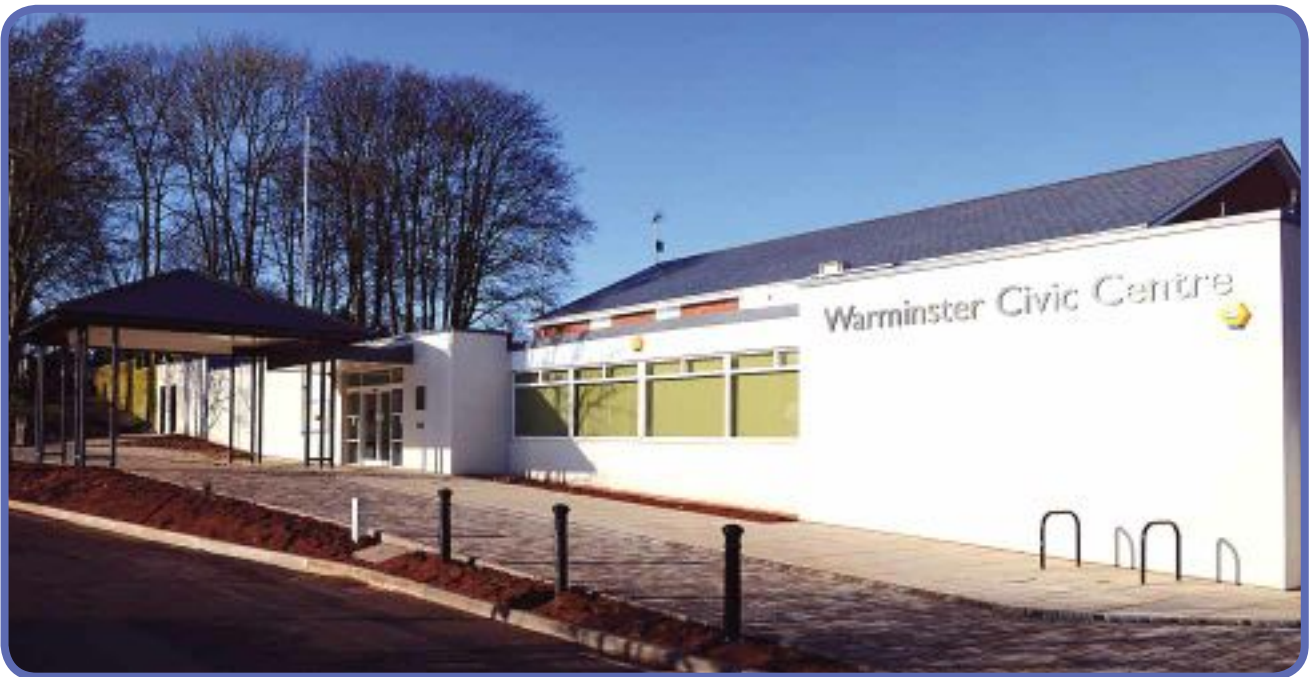

Public buildings in town centres are excellent sites for CP facilities, which help support the local community and visitors. Local authorities should consider providing CP toilets at all of their civic hubs. Kent County Council, for example, has CP facilities available at all Gateway sites.

Key public buildings such as libraries, resource centres, community halls and meeting venues should also consider CP provision to be accessible to all visitors. Public buildings with CP facilities include County Hall Trowbridge, Basingstoke Discovery Centre and Warminster Civic Centre.

**“We wanted to make the building as inclusive and accessible as possible for all the residents of Warminster and visitors to the town. We are delighted that with the support of Wiltshire Council we have been able to include a Changing Places toilet in our new facilities, giving us state-of-the-art provision for all those who visit the Civic Centre.”**

**Heather Abernethie**, *Warminster Town Clerk*





# + Health and education



University Hospital Wales celebrate opening their CP facility

Healthcare facilities and education buildings are more likely to have regular visitors who require frequent access to CP toilets.

University Hospital Wales responded to requests from visiting families and became the first hospital to install a CP toilet in Wales.

**“The Changing Places toilet we have installed is the first in any hospital in Wales. We hope people who cannot use standard accessible toilets find that this vastly improves their experience within the University Hospital of Wales. I’m delighted that, together with Mencap Cymru, we have improved things for families.”**

**Mike Spencer**, *Assistant Director of Patient Experience at Cardiff and Vale University Health Board*

**“We congratulate the health board on this installation, and encourage other hospitals in Wales to follow their good example. Without Changing Places toilets, families jeopardise their own health and safety to change their son or daughter on a toilet floor – something which is dangerous, unhygienic and undignified. People with a learning disability will often have additional health needs, so it’s vital to have fully accessible spaces like these in our hospitals.”**

**Wayne Crocker**, *Director at Mencap Cymru*

Other healthcare facilities which provide CP toilets include Ninewells Hospital in Dundee, Harold Wood Polyclinic in Havering, City Hospital and Queen’s Medical Centre, which are both in Nottingham.

The University of Manchester and the University of Dundee have improved access for higher education students and staff by installing CP toilets. Aviemore Primary School and Community Centre also provide CP facilities for local users.

# Special events

## Olympic and Paralympic Games 2012



© Paul Edgar

The London 2012 Games were the first to offer CP facilities at Olympic and Paralympic venues. Paul Murray (pictured) enjoyed his experience at the Games

Providing CP toilets at special events means that more disabled visitors can attend and stay for the full duration. For the Olympic and Paralympic Games 2012 in London, the Olympic Delivery Authority (ODA) included CP toilets in each of the Olympic Park's venues as part of its Inclusive Design Strategy.

**“The Olympic Park was designed and constructed to be inclusive for people of all cultures, faiths and ages, and accessible to disabled people. As part of this commitment, we aimed to provide accessible Changing Places toilets at every venue.”**

**Margaret Hickish**, *Principal Access Officer for the ODA*

**“There was much to see...I had a very good day at the Olympics, tiring but well worth it...and finally, after a brilliant day out, I headed home.”**

**Paul Murray**, *London 2012 spectator*

## V Festival



Portable CP toilets can be used at outdoor events such as festivals

The outdoor music event, V Festival, offers portable CP facilities.

**“British summertime means one thing to me - going to a festival - and most of us are lucky enough to be able to do so without too much worry. But for people with profound and multiple learning disabilities this often isn't the case as many festivals don't have suitable toilets for them to use. That's why it's great to see V Festival's continued support for the Changing Places campaign.”**

**Jo Whiley**, *BBC Radio 2 DJ*

Robert (pictured above with friends) loves music and goes to gigs in his local area almost every week. However, as his assistant Rui Shang explained, he had never been able to go to a festival before due to the limitation of facilities. Rui said:

**“It's brilliant that V festival has Changing Places toilets at the site – now Robert can get to see the bands he has plastered on his walls!”**

## 2 Legislative background

**This section sets out the legislative background relevant to the provision and use of Changing Places (CP) toilets and seeks to clarify the duties and responsibilities of providers and users. It outlines existing policy guidance for organisations considering or planning a CP toilet.**

It is important to carry out a full risk assessment and implement robust management procedures for maintaining sanitary facilities. The Health and Safety Executive provides further information about conducting risk assessments on its website. The Changing Places Consortium is happy to assist anyone with concerns about providing CP facilities, although they are unable to provide legal advice. A factsheet about legal issues is available for download from the CP website. For more details, see Chapter 7, **Sources of further information.**

### Equality legislation and treaties

#### Equality Act 2010 (England, Scotland and Wales)

The Equality Act 2010 came into force in October 2010 and provides a single legal framework through which inequality and discrimination can be challenged. It brought together nine separate anti-discrimination laws which previously covered distinct areas of inequality. These are defined in the Equality

Act 2010 as the 'protected characteristics' of race, disability, gender, gender identity, religion and belief, pregnancy and maternity, sexual orientation and age. The Act replaced previous equality legislation including the Disability Discrimination Acts 1995 and 2005 (DDA) in England, Scotland and Wales. The DDA is still in force in Northern Ireland.

The single equality framework simplifies this area of the law and also strengthens the duties, rights and expectations of service users, service providers and employers across the public, commercial and voluntary sectors. Compared with previous legislation, the Equality Act 2010 makes it easier for disabled people to demonstrate that they are covered by the definition of 'disability' under the Act. It protects disabled people against direct discrimination, indirect discrimination, discrimination arising from their disability, harassment and victimisation.

Different parties, including service providers, employers and education providers are required to make 'reasonable adjustments' wherever a disabled person would encounter a substantial disadvantage, in an effort to overcome this disadvantage. Adjustments may be made to policies or to physical features, or through the provision of auxiliary aids.

The Act provides protection at work for people who care for a disabled or older person. It also provides measures to protect people against discrimination and harassment when accessing services accompanied by a disabled person.

## Duties as a service provider

The Equality Act 2010 sets out duties requiring service providers to make reasonable adjustments by:

- **altering policies and practices**
- **overcoming barriers caused by physical features of buildings**
- **providing auxiliary aids.**

Doing this should make it easier for disabled people to access facilities and services.

The Act also requires organisations to plan ahead and make changes in advance in order to meet the needs of existing and potential new customers.

Whether an adjustment is considered 'reasonable' will depend on a number of factors, including the practicality and effectiveness of implementing the change, the cost, the size of the organisation and availability of resources. The aim of undertaking adjustments should be to remove any disadvantage experienced by disabled people.

## Positive action

The Equality Act 2010 allows service providers to take positive action in order to meet the needs of people who are under-represented, disadvantaged or have specific needs, where this will help to overcome potential barriers or disadvantages. The purpose of positive action is to increase opportunities for people to benefit from services and to enjoy full involvement in the community by providing services that respond to specific requirements.

There is no restriction under the Act on treating disabled people more favourably than people who are not disabled. It is also acceptable to target positive action towards people with a particular disability, rather than to disabled people generally.

Justification for taking positive action should be based on three conditions:

- **service providers should have reasonable grounds for thinking that a particular group of people protected by the Act are disadvantaged in terms of accessing their services**
- **service providers should have reasonable grounds for thinking that the particular group of people is under-represented as service users**
- **the needs of the particular group should be different from those of other groups of people.**

Where a service provider takes positive action, the action should meet the needs of the particular target group, help to reduce or eliminate disadvantages and facilitate full involvement or access to the service.

## Public sector Equality Duty

The Act includes a public sector Equality Duty, which came into force from April 2011. This requires public bodies to place equality at the heart of everything they do and extends the benefits across all protected characteristics. It consists of a general duty and specific duties.

While the specific duties vary in England, Scotland and Wales, under the general duty



all public authorities in the UK are required to actively promote disability equality and positive attitudes towards disabled people, as well as to eliminate harassment and discrimination of disabled people.

## Disability Discrimination Act 1995 (Northern Ireland)

Under the DDA, employers and service providers have the positive duty to make reasonable adjustments to premises and policies in order to provide disabled people access to goods, facilities, services or premises.

A service provider may need to change a practice, policy or procedure which makes it impossible or unreasonably difficult for disabled people to access their services. They may also have to make adjustments where a physical feature makes it impossible or unreasonably difficult for a disabled person to use a service.

The Equality Commission for Northern Ireland provides the following guidance on duties in relation to the provision of goods, facilities and services.

## Goods, facilities and services

The DDA makes it unlawful for those providing goods, facilities or services to the public to discriminate against a disabled person for a reason related to their disability, in certain circumstances. It is unlawful for a provider of services to discriminate against a disabled person in:

- **refusing to provide, or deliberately not providing, to a disabled person, any service which is provided to members of the public**
- **failing to make a reasonable adjustment which makes it impossible or unreasonably difficult for a disabled person to make use of any such service, and the failure cannot be justified**
- **the standard of service provided to a disabled person or the manner in which the service is provided**
- **the terms on which the service is provided.**

## Public sector duties (Northern Ireland)

Public bodies in Northern Ireland have additional duties to promote equality of opportunity and good relations under Section 75 of the Northern Ireland Act 1998. They must also meet duties under the Disability Discrimination Act to promote positive attitudes towards disabled people and to encourage the participation of disabled people in public life.



Sara and her sister Linda

“I’m determined Sara should have the chance to take part in our local community, and we go out somewhere every day. Now that Nottingham City Centre has Changing Places toilets we have far more freedom and choice – it’s made such a difference to our lives”

## United Nations Convention on the Rights of Persons with Disabilities

The UK Government ratified the United Nations (UN) Convention on the Rights of Persons with Disabilities in 2009. The Convention places obligations on the UK Government to protect and promote the rights of disabled people and to take steps to ensure that this is also undertaken by other public bodies, such as local authorities and health boards. The Convention can play an interpretative role in cases under domestic human rights or equality legislation.

Among other areas, the Convention includes articles relating to:

- equality and non-discrimination, including the ability to create specific measures to promote equality for disabled people (Article 5)
- accessibility including within the built environment, transport, public services and facilities (Article 9)
- freedom from degrading treatment, that is, treatment that is grossly humiliating and undignified (Article 15)
- living independently and being included in the community (Article 19)
- personal mobility (Article 20)
- participation in cultural life, recreation, leisure and sport (Article 30).

The UN Enable website provides additional information on the UN Convention on the Rights of Persons with Disabilities. Further information and guidance on domestic equality and human rights legislation, as well as on the application of the UN Convention on the Rights of Persons with Disabilities in the UK, can be found via the UK’s commissions for equality and human rights. See Chapter 7, **Sources of further information**.

## Building Regulations, design guidance and codes of practice

### British Standard (BS) 8300

Detailed guidance relating to the provision and design of CP toilets was included for the first time in a British Standard when it was incorporated into the 2009 edition



of BS 8300 *Design of buildings and their approaches to meet the needs of disabled people – code of practice*. The code of practice provides guidance for those involved in the design of new buildings and the adaptation or improvement of existing facilities. It recommends that CP facilities should be provided in larger buildings and complexes with public access or where visitors might be expected to spend long periods of time.

## Building Regulations

The design of all new buildings and the majority of alterations to existing premises are controlled by the Building Regulations system in England, Wales, Scotland and Northern Ireland. The Building Regulations include a series of requirements to ensure that buildings are safe, healthy, sustainable and convenient for everyone to access and use. The associated technical documents cover specific areas of the Regulations, with the most relevant to this guide being the following:

### England

*Approved Document M – Access to and use of buildings (AD M) 2013 edition*

Section 5 refers to the provision of sanitary accommodation and CP facilities in larger buildings.

#### “5.6

**In large building developments, separate facilities for baby changing and an enlarged unisex toilet incorporating an adult changing table are desirable. Facilities incorporating adult changing tables are more commonly known as**

**Changing Places toilets and further guidance is available from the Changing Places Campaign website ([www.changing-places.org](http://www.changing-places.org)) or by reference to guidance in section 12.7 and Annex G of BS 8300.**

#### “5.17

**In large building complexes, such as retail parks and large sports centres, there should be one wheelchair-accessible unisex toilet capable of including an adult changing table.”**

### Wales

*Approved Document M – Access to and use of buildings (ADM)*

Documents and guidance that are current and in force up to 31 December 2011 and had previously applied to England and Wales, will continue to apply in Wales following transfer of powers to Welsh Ministers. This includes Building Regulations and Approved Documents.

From 1 January 2012, any revisions to Building Regulations and Approved Documents issued by the Department for Communities and Local Government apply to England only. For the latest version refer to the Welsh Government website: [www.wales.gov.uk](http://www.wales.gov.uk)

## Northern Ireland

*Technical Booklet R 2012 – Access to and use of buildings*

Section 6, *Sanitary accommodation*, covers the provision of sanitary and changing facilities in dwellings and non-domestic buildings. *Appendix A: Informative – facilities for people with profound and multiple learning disabilities*, includes recommendations for changing places facilities:

**“People with profound and multiple learning disabilities, who require the help of up to two assistants, need a facility that is a combined toilet, shower and changing room.**

Such facilities require extra space to accommodate people, often using large wheelchairs having elevated leg rests, a reclining facility or integral oxygen cylinders, and space to fit slings for use with a hoist. It also needs to be possible for a wheelchair to remain within the facility when not in use without compromising the safe access and use of the equipment.

**A Changing Places toilet includes such extra space and facilities.”**

## Scotland

*Technical Handbook 2013 – Non-Domestic*

The guidance in section 3.12 – Sanitary facilities acknowledges CP toilets as best practice and includes recommendations for a network of these facilities:

**“Changing Places Toilet (CPT) – is a toilet with a changing facility that is suitable for use by people that have profound and multiple learning disabilities or other disabilities and for whom standard accessible toilets may not be fit for purpose. A CPT is provided where the building owner chooses to do so and their installation represents best practice.**

**There are many building types best suited for CPT installations including publicly accessible facilities such as shopping malls, entertainment or assembly buildings and transport related facilities. Provision of CPTs within suitable buildings is important to establish a network of facilities at appropriate locations across the country.”**

## Jersey

*Approved Technical Guidance Document  
Part 8 – Access to and use of buildings,  
2007 edition incorporating 2012  
amendments*



Section 5 includes detailed design considerations and provisions for Changing Places sanitary accommodation in terms of meeting requirements of Part 8 of Schedule 2 to the Building Byelaws (Jersey) 2007.



Example layout from the *Jersey Technical Guidance Document: Part 8*

“The reason for including provision for Changing Places facilities was to address concerns that standard wheelchair-accessible toilets do not meet the needs of all disabled people. Providing CP facilities as part of larger developments was seen as a reasonable solution to those concerns.”

**Morris Roscouet**, Director of Building Control, States of Jersey

## Accessible train station design for disabled people: A code of practice



The code is published by the Department for Transport, and relates to Section 71B of the Railways Act 1993. It fulfils the Secretary of State’s responsibility to produce a code of practice “*protecting the interests of users of railway passenger services or station services who are disabled*”.

Section P2 *Toilets – provision and location of wheelchair-accessible toilets* states:

“A Changing Places toilet facility should be provided in all large railway stations (category A). (Further advice on the design and installation of Changing Places facilities can be obtained by contacting the Changing Places Consortium). The Changing Places facility should be in addition to, not instead of, the provision of unisex accessible WCs.”



# Health and safety legislation

## Health and Safety at Work Act 1974

Under the Health and Safety at Work Act 1974, employers have a duty to ensure, as far as is reasonably practicable, the health, safety and welfare at work of all their employees. This duty may be relevant, for example, regarding attendants employed in public CP toilets. The provider would have to be clear about the role and function of such attendants, as well as about the competence level, supervision, policies and procedures.

The Changing Places Consortium recommends that organisations do not place responsibility on staff to assist people to use CP toilet facilities.

The Act also places a duty on employers to conduct their undertaking in a way as to ensure, so far as is reasonably practicable, that people who are not in their employment who might be affected are not exposed to risk towards their health and safety. This might apply to users of CP toilets and their assistants. The risk might be managed, for example, by providing clear information about the equipment and instructions for use, by ensuring the equipment is properly maintained and by providing an emergency alarm.

## Management of Health and Safety at Work Regulations 1999

Among other duties, these regulations stipulate an explicit obligation to carry out a risk assessment in relation to both employees and non-employees.

## Common law of negligence

This is the law which would potentially apply should a user suffer an injury using a facility such as a CP facility. The basic test of negligence is whether there is a duty of care, whether it has been breached by carelessness, and whether harm has been caused by the breach. The test of carelessness would include consideration of whether the risks of providing specialist equipment in public toilets had been properly evaluated and then balanced against the benefits, which would be determined by a thorough assessment of the risks and how these could be managed.

## Lifting Operations and Lifting Equipment Regulations 1998, and Provision and Use of Work Equipment Regulations 1998

These regulations relate to the examination and maintenance of lifting equipment, but only for equipment used at work. However, where the Health and Safety at Work Act applies to non-employees, the Health and Safety Executive has stated that it would expect the standards associated with these regulations to be adhered to.

The Changing Places Consortium recommends that all specialist equipment should be fitted, regularly inspected and maintained according to the manufacturer's instructions.

## Manual Handling Operations Regulations 1992 (as amended in 2002)

These Regulations are designed to protect and safeguard people in the workplace in situations that involve manual handling. They acknowledge that many injuries can be caused by handling heavy loads, by adopting poor posture and by exacerbating a previous or existing injury. The Regulations require employers to carry out a risk assessment for all manual handling tasks, taking into account the task, individual capabilities, the load and the working environment.

A risk assessment might conclude that the risks posed to an attendant who was called upon to physically assist a user of the toilet were high and unmanageable. The Changing Places Consortium recommends that the facility attendants should not be required to help users of CP toilets.

The provision of height-adjustable facilities such as a hoist, changing bench and washbasin will enable disabled people and their assistants to use the facilities safely and with considerably reduced risk of injury.

Further information and guidance on health and safety legislation is available from the Health and Safety Executive – see Chapter 7, **Sources of further information.**



Sara and Linda using a hoist: transfer is managed by the disabled person and their chosen assistant(s)

**“Organisations that provide a CP toilet should not place responsibility on staff to assist people to use the facilities.”**

**Changing Places Consortium, *Legal framework factsheet***



# Recommendations for risk management

To ensure that organisations considering the installation of a CP facility have a balance between the risks posed and the benefits offered, the Changing Places Consortium makes the following recommendations:

- Organisations that provide a CP toilet should carry out a full risk assessment.
- Organisations that provide a CP toilet should not place responsibility on staff to assist people to use the facilities.
- An emergency alarm should be fitted in the CP toilet with a clear management and response policy.
- All specialist equipment, including hoists and changing benches, should be fitted, regularly inspected and maintained according to the manufacturers' instructions.
- Instructions that show how to use equipment, and any relevant warnings, should be clearly displayed in the facility.
- Organisations should not provide slings. Signage and literature should clearly advise people that they should provide their own slings for health and safety reasons.
- Clear information should be provided on the type of hoist provided in the facility and which slings are compatible. If there is any uncertainty as to whether the hoist is compatible with the person's own sling, the person should be advised not to use the facility.
- The organisation should ensure that the facility is kept as clean and hygienic as possible.
- Equipment to assist people using the facility to maintain hygiene should be provided, including wide tear-off paper roll to cover the changing bench and a large waste bin for disposable pads.

For detailed guidance on managing CP facilities, see Chapter 6, **Management and maintenance**.

A legal factsheet is available from the Changing Places website:  
[www.changing-places.org](http://www.changing-places.org)

# 3 Planning and design

## Consultation

When planning the provision of a new Changing Places (CP) toilet, consultation with relevant organisations and individuals is essential if the needs of existing local user groups are to be met. The list below suggests various groups that could be consulted, the choice depending on the location of the proposed facility. Once key user groups have been identified, their needs should be considered throughout the design process and in the selection of equipment.

### Consultation groups

- local access groups
- local information and advice services for disabled people
- local disabled people's groups
- day centres
- community learning disability teams
- occupational therapists
- Disability Information and Advice Line (DIAL)
- carers' groups
- local authority disabled children's teams
- school staff
- social services adult-care teams
- Shopmobility centres
- patient forums associated with local health centres or hospitals
- local authority access officers or equalities teams.

In situations where a CP toilet is being provided for known individuals, such as specific students in schools or colleges, their needs should be taken into account. If a new CP toilet is proposed within an existing building, such as an adult day-care centre, the input of people already attending the building is essential.

## Professional advice

Organisations or authorities looking to provide a CP toilet will need an architect or building surveyor to prepare plans and obtain relevant statutory consents. This will be the case whether the work is part of a new development or is an addition to an existing building. The architect or building surveyor will advise if the services of other professionals such as a structural engineer or building services engineer are also required.

Given the specialist nature of CP toilets and taking into account access considerations, it is recommended to seek advice from a professional access consultant as well as engaging with consultation groups. The National Register of Access Consultants (NRAC) is a useful resource for this purpose, see Chapter 7, **Sources of further information**.

## Statutory consents

The provision of a CP toilet is likely to require statutory consents including planning permission, Building Regulations approval and, in the case of listed buildings, listed-building consent. Besides the architect or building surveyor, the local authority planning officer, building inspector, access officer and conservation officer may be able to provide advice on obtaining these consents.

## Room layout

The correct arrangement of equipment in a CP toilet ensures that people are able to access and use the facilities easily. However, in the case of retro-fit facilities, there may be limitations on the arrangement as a result of the door position, structural elements, existing services and other factors.

The diagrams that follow illustrate several different room arrangements, all of which allow useable facilities for the majority of users. Key considerations for a facility – which are highlighted on each diagram – include:

- adequate manoeuvring space
- position of equipment in relation to the ceiling track hoist
- position of items such as waste bins, hand dryers and dispensers.

## Room layout: critical factors

- direct access from the door into the clear manoeuvring space
- sufficient clear space to enable a wheelchair user and two assistants to manoeuvre around the room
- fixed and free-standing equipment positioned to maximise the manoeuvring space
- easy direct transfer using hoist between clear manoeuvring space, WC and changing bench
- peninsular WC positioned to provide room for an assistant on either side of the WC
- if installed, shower unit and detachable shower head located close to head of changing bench
- if installed with shower unit, floor drain positioned to prevent water flowing across room
- privacy curtain or screen positioned to shield the WC and to provide adequate space either side, but where it will not cause an obstruction when retracted.

# Example design: BS 8300 Changing Places facility

- corner door position
- layout as BS 8300:2009
- layout also suitable for freestanding changing bench
- full room cover ceiling track hoist

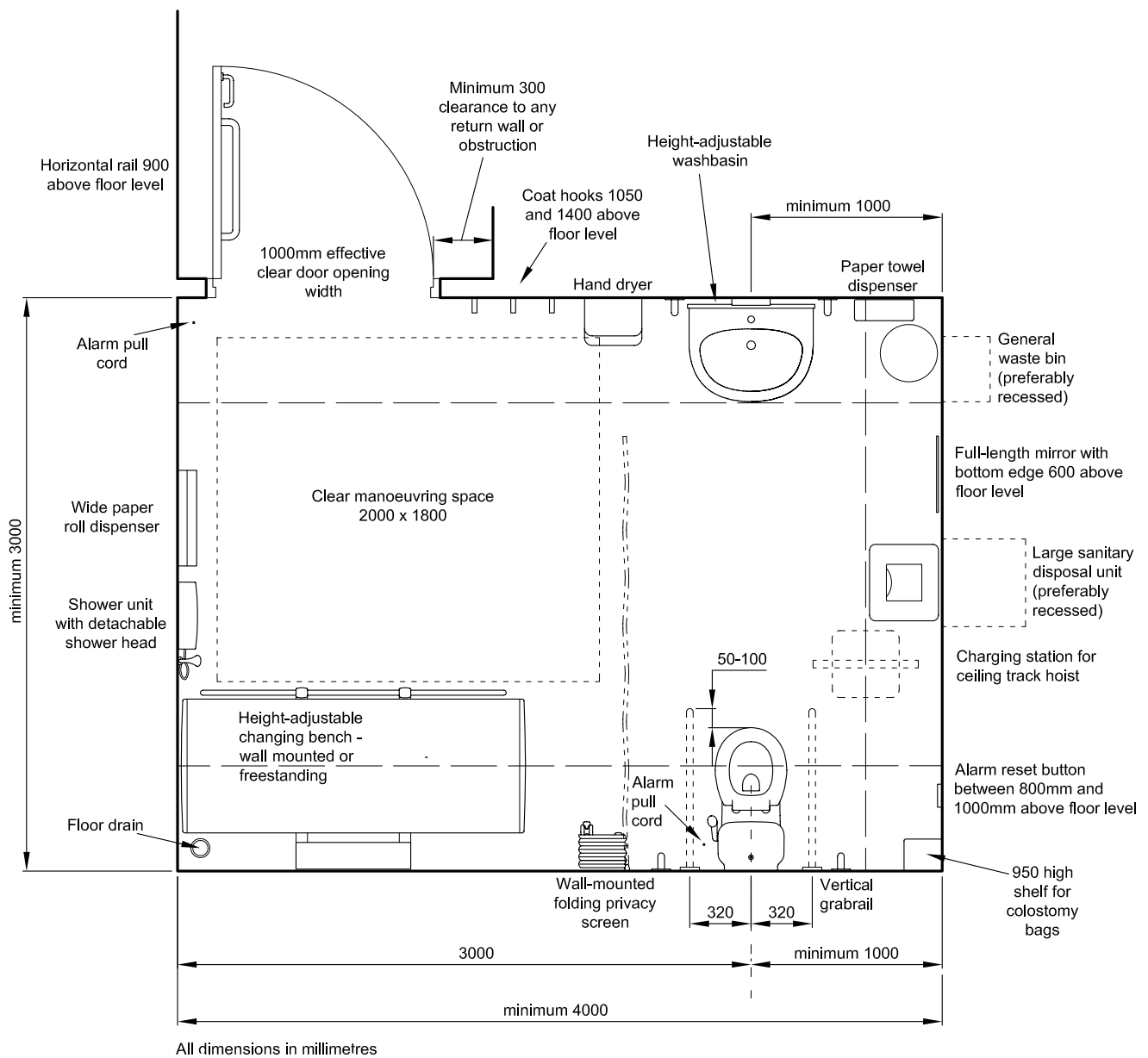



## Example design: Central door layout

- direct access between door and clear manoeuvring space
- shower and floor drain positioned away from door
- layout also suitable for freestanding changing bench
- full room cover ceiling track hoist

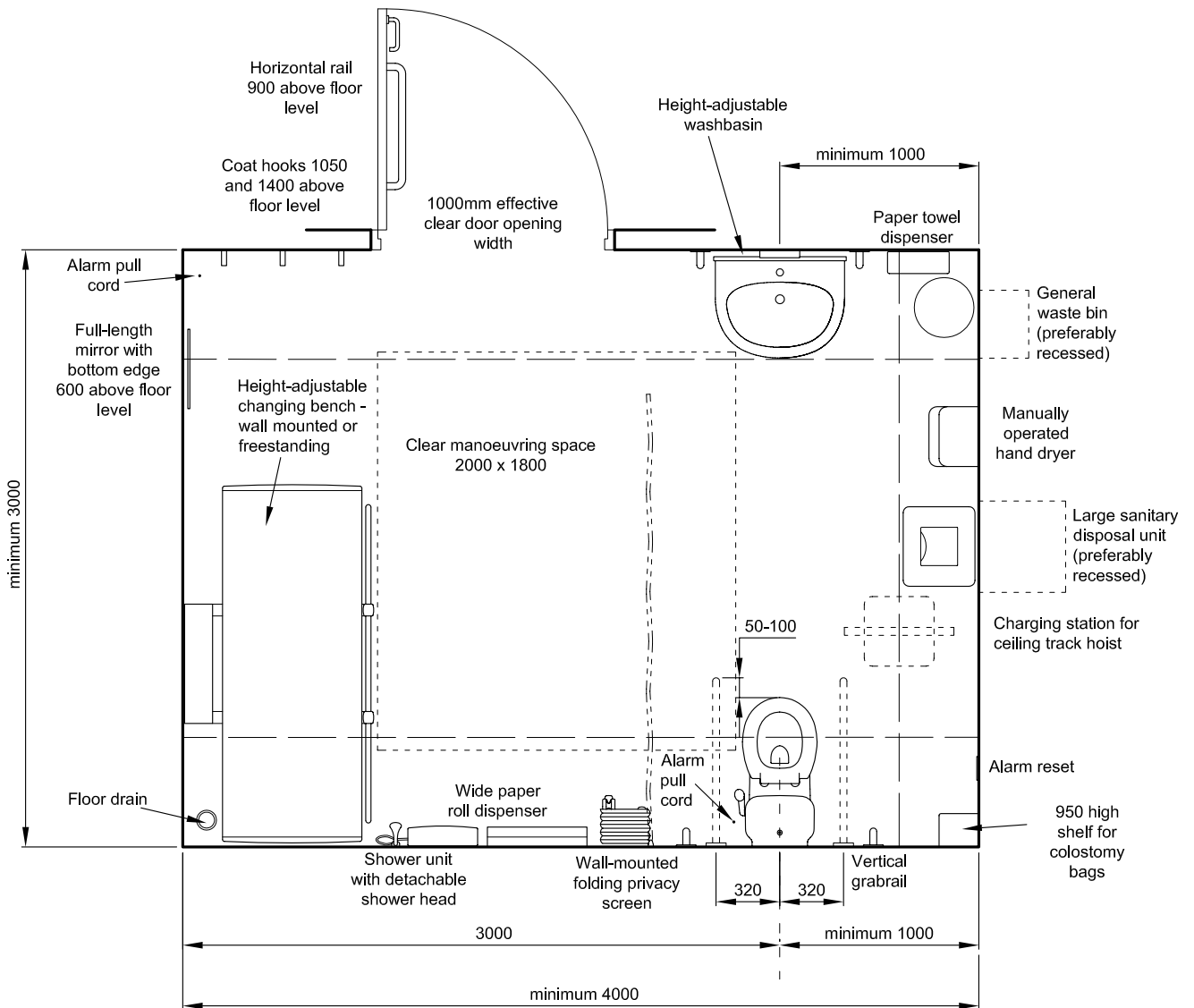

# Design: Recommended heights for fittings

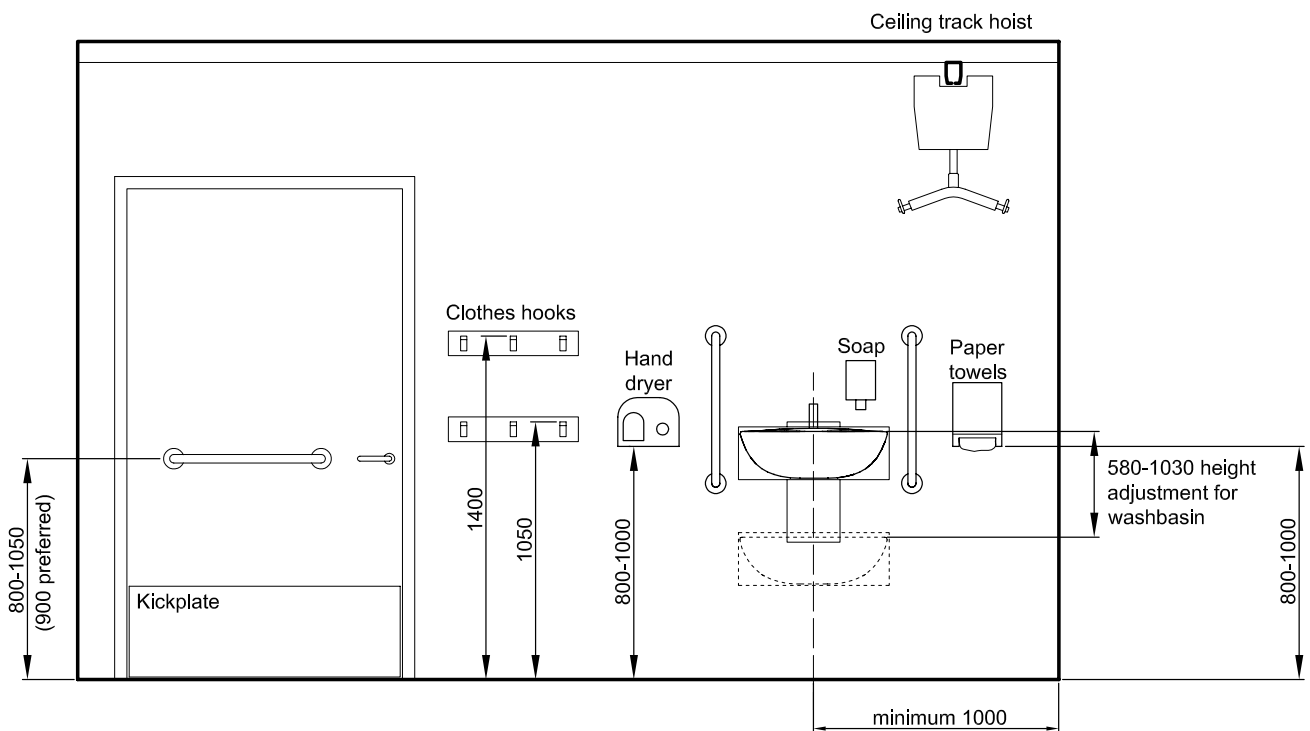
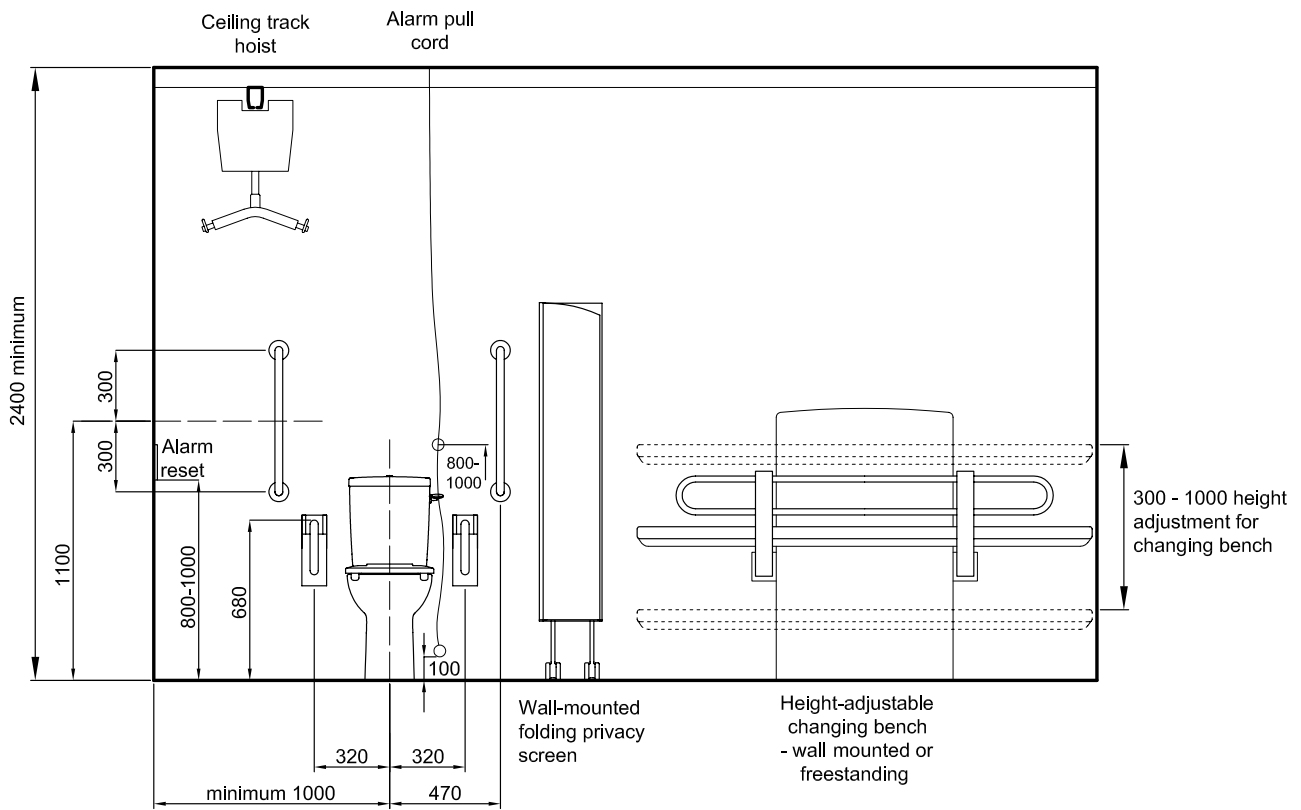

All dimensions in millimetres





# Design: Recommended heights for shower area

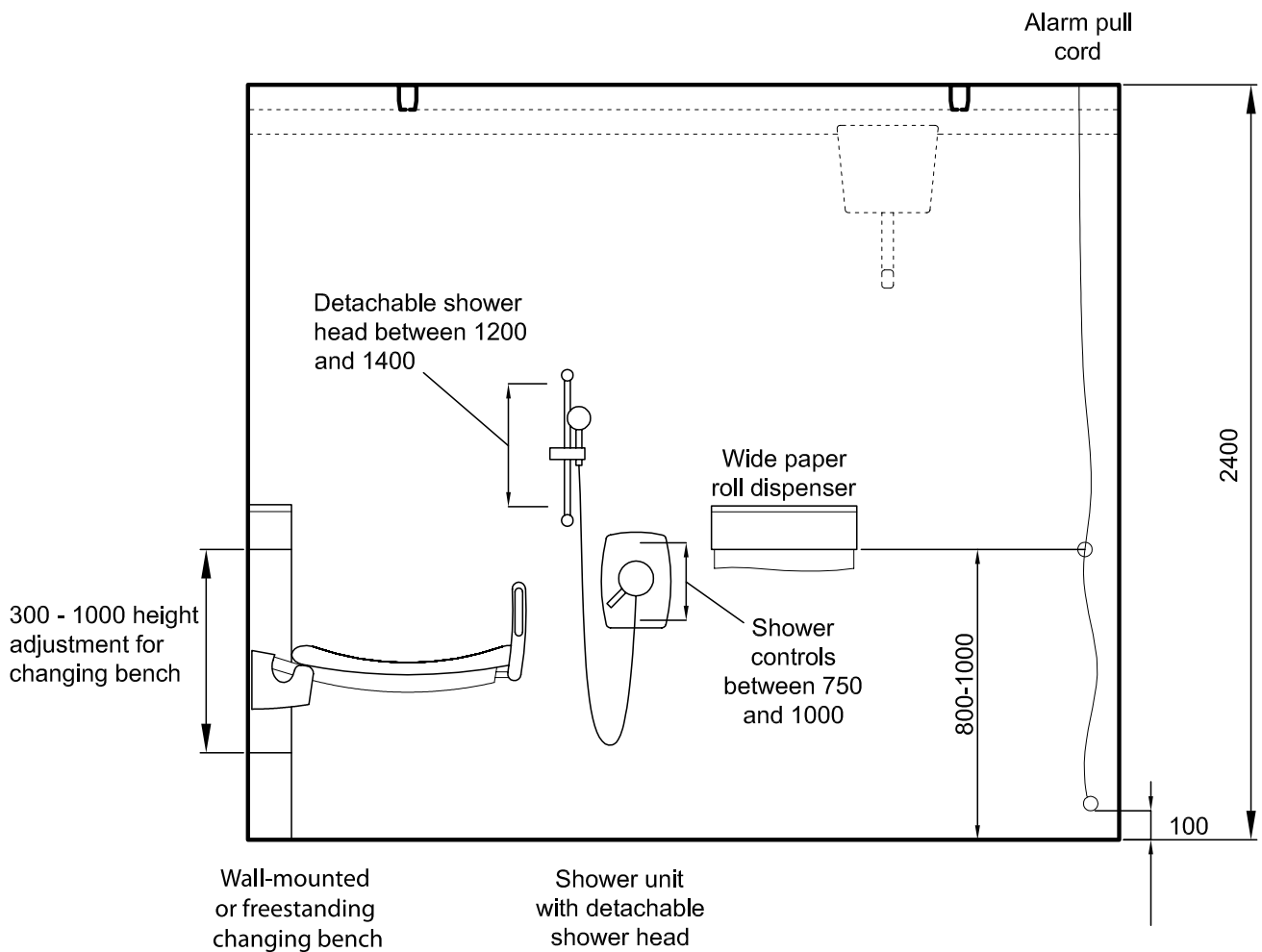

All dimensions in millimetres

Recommendations on the design and installation of a shower area with shower seat can be found in Chapter 4, **Equipment and environment**.

## Case study:

# The Eden Project's CP facility design

The CP toilet at the Eden Project measures approx 4.5m by 3m providing a space of just over 13.5 sq m (square metres).

The interior decoration provides visual contrast, which helps to identify the equipment, as well as creating a welcoming environment.

**“The main learning point for me is that, while it is crucial to ensure there is enough space to create an accessible environment, going the extra mile and getting the best equipment also makes a real difference to people’s lives.”**

**Andy Bruton**, *The Eden Project*

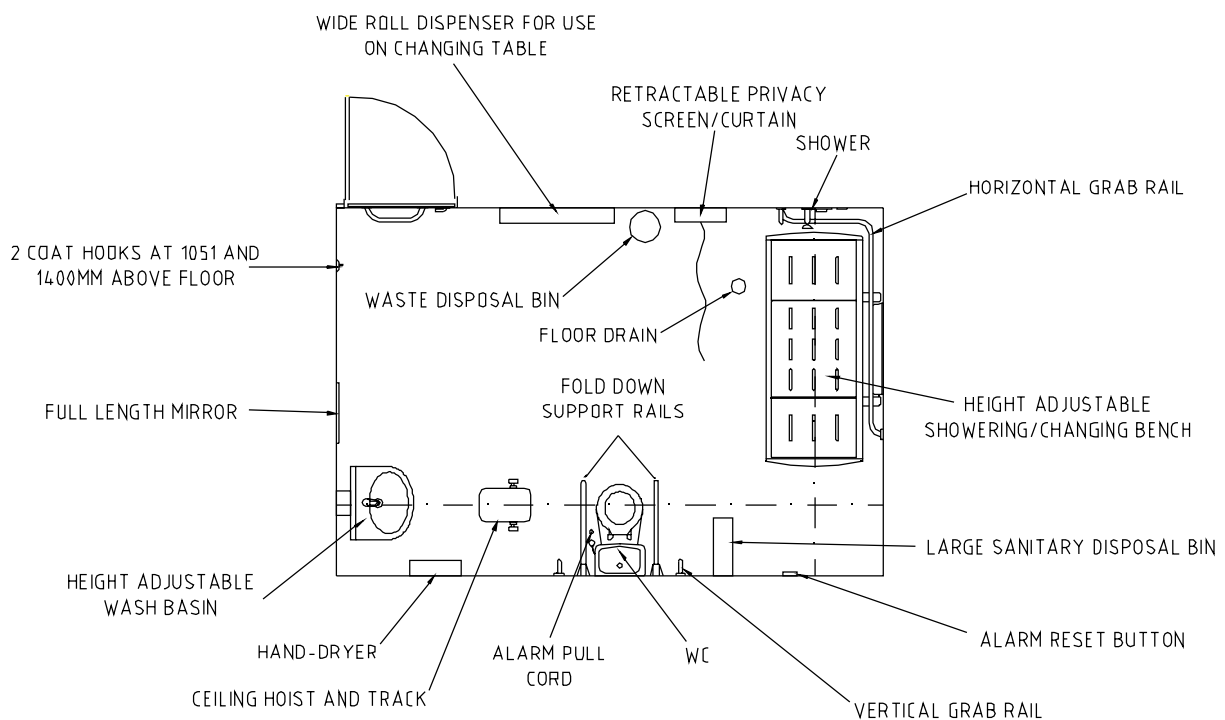

[Above] The Eden Project's CP layout is a bespoke 4.5 by 3m design by Ted Page

[Right] The Eden Project's CP facility is bright and welcoming

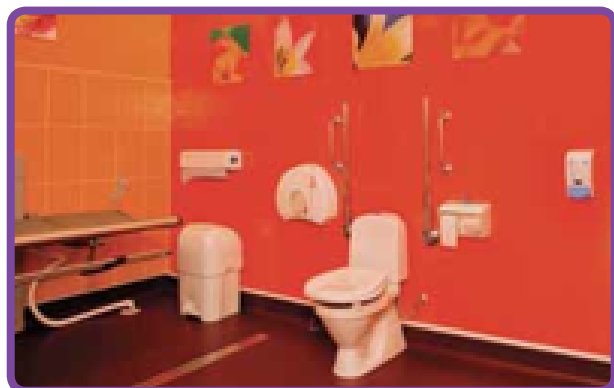

## Planning CP toilets in different venues

### Large venues

In larger venues such as shopping centres, cultural sites and stadiums, CP toilets should be located in the same area as other WC facilities, clearly signed and near staffed information points. Information on CP facilities should be made available at reception areas, maps, directories and any local Shopmobility centres.

### Public conveniences

In public conveniences with direct access from the street, security issues may be a concern – see also *Security* in Chapter 6, **Management and maintenance**. In some circumstances, a wall-mounted, fold-down, height-adjustable changing bench may be preferable to a mobile unit.

Clear street and building signage will help visitors to find the facilities. Hours of opening, management contact details and alternative CP toilet information should be provided.

## Sports and leisure centres

CP toilets should be located close to changing areas, with direct access to the sports facilities. Accessible and dignified methods of transferring into swimming pools should be provided. Associated facilities such as lockers should be provided nearby and should be easily accessible.

The guidance in the Sport England publication *Accessible Sports Facilities* requires a CP toilet to be provided in sports centres with a nine-court sports hall (or larger) and in swimming pools and leisure centres with a 25m (or longer) pool. It is also recommended for four-court and six-court sports halls and 20m swimming pools.



The public toilets in Nottingham City Centre offer one main entrance to the separate toilets, promoting social inclusion, access and increasing public visibility and convenience

Bradford Metropolitan District Council has been instrumental in providing a number of CP toilets in buildings throughout the district, one of which is at Keighley Leisure Centre. The leisure centre provides facilities including a swimming pool with wet-side chair and hoist, sauna, fitness suite, bar, café and spectator gallery. The CP toilet can be used whenever the leisure centre is open and is kept unlocked. Access to the toilet is via the leisure centre reception, which is staffed at all times.

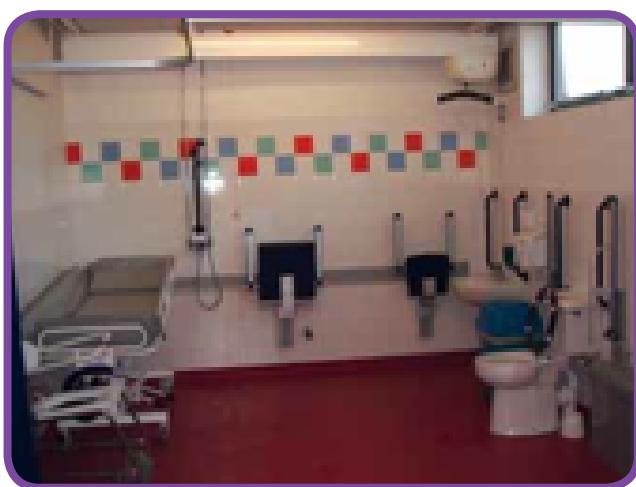

The CP toilet at Keighley Leisure Centre provides a good range of facilities

The large facility incorporates two peninsular-arrangement WCs which can be divided by a privacy screen, a freestanding height-adjustable changing bench and ceiling track hoist. Two fold-down height-adjustable shower seats are also provided and are mounted on a horizontal track to enable them to be moved to suit the user.

Providing two WCs means that if groups visit the leisure centre, they have the option of two people using the facility at the same time, reducing queuing time. The provision of height-adjustable drop-down rails to either side of the WC offers greater flexibility and improved safety compared to fixed-height drop-down rails.



Keighley Leisure Centre's 23 sq m facilities are large enough to include two peninsular layout WCs with a privacy screen, enabling more efficient use by a visiting group

## Residential, day-centre and healthcare environments

In situations where a significant proportion of people who use the facilities are either residents or regular visitors, it may be appropriate to provide shelves or cupboards to store personal items, such as pads and cleansing products, as well as items for assistants, such as gloves and hand cream. Shelves and cupboards should not cause an obstruction or reduce the overall space available.

In hospitals, facilities similar to CP toilets are likely to be provided already for use by inpatients as a component of ward-based facilities. A CP toilet for public use should also be provided to enable disabled people to attend GP practices, health centres and hospitals as visitors, and for outpatient appointments.



Ninewells Hospital and Medical School provides CP facilities near to the central lift providing easier access from all floors



The CP facility at Aberdeen Royal Infirmary is located on the ground floor near to the lifts. The toilet is open but a Radar key is required to access the hoist and supplies for nurses and assistants. A Radar key can be borrowed from the reception desk or porters' service office

## Schools

Appropriate storage should be provided, as is the case for residential and day-centre environments. A lockable cabinet for medicines and dressings may also be necessary and a floor-mounted sluice is usually required. In schools, CP toilets are commonly named 'hygiene rooms'.

Special schools are likely to require more than one CP toilet, with the number of rooms being determined by the students' needs. *Building Bulletin 102: Designing for disabled children and children with special educational needs* includes sample schedules and layouts for special schools for different age ranges.

## Universities

Access to a Changing Places toilet on campus in central location(s) will benefit disabled students and staff. As university campuses can be large and complex, it is essential to consider the best location in terms of accessible routes and provide clear signage guiding users to the facilities.

The University of Manchester installed a CP toilet in the Stopford Building, which is in the centre of the campus. They have provided detailed access guides for all of their buildings including photos of the equipment available in the CP facility.

## Airports and transport interchanges

Careful thought should be given to the number of CP facilities provided and their location, taking into account a passenger's complete journey. The overall size of the CP toilet should reflect the likelihood that people will have luggage with them. There should be sufficient space within the CP toilet to enable people to keep their luggage with them, without it obstructing the manoeuvring space and use of equipment.

As most travellers from outside the UK may not be in possession of a Radar key, alternative arrangements for access should be provided if the facility needs to be kept locked. For further information on restricted-access facilities, see *Security* in Chapter 6, **Management and maintenance**.



At George Best Belfast City Airport, CP facilities are located on the ground floor next to the check-in area. The pre-security location allows visitors as well as passengers to access the toilet. A Radar key is available from the information desk.

The CP toilet at East Midlands Airport has an 'airside' location beyond security, in the departure lounge.

Careful consideration should be given to the management and location of CP facilities to ensure they can be used by as many people as possible both before and after security checkpoints.



A pre-security location allows visitors and some passengers access to a CP toilet at George Best Airport



Access to CP toilets provided post-security at East Midlands Airport

The CP toilet at Sutton Railway Station is accessed by a lift from the over bridge near the station's main entrance. Access to the facility is provided on request from a staffed office on the same platform as the toilet. The station also provides free accessible parking to Blue Badge holders. The facility's location and management takes into account the passenger's complete journey experience.



Sutton Railway Station's CP facility is located on the same platform as the staffed office

**“Developing a strategy to provide Changing Places toilets in Middlesbrough was a great challenge. I found that my OT skills really helped during this process in understanding the needs of disabled people - but I wasn't alone - a strong steering group of professionals and user representatives was established and, following a great deal of campaigning and hard work, we now have seven Changing Places in a variety of locations”**

**Justine Sharman**, Access Officer at Middlesbrough Council

## Portable Changing Places toilets

At large events such as music festivals and outdoor fairs or shows, some or all toilet facilities are likely to be portable. The overall provision should include unisex accessible toilets and a CP toilet.

Portable CP toilets should have step-free access and be fitted with the same equipment as permanent CP toilets. Wherever possible, the unit should be connected to the mains water supply and waste drainage system. It is particularly important to ensure that high standards of cleanliness are maintained in portable CP toilets, as their outdoor location means users may be more likely to bring in dirt from outside. Maintenance checks should also be performed to ensure that running water is available. The location of the facility should be clearly signed.



In Wales, Mencap Cymru and the National Eisteddfod have two portable CP toilets available for local loan



Birmingham city centre provided a Changing Places toilet for visitors to their Christmas market and busy shopping district, supplied by Andy Loos. A straight-on, ramped approach provides easy access

## Accessible routes

CP toilets should be located within easy access of the building entrance. Wherever practicable, a CP toilet should be located close to managed facilities, such as in a staffed suite of public conveniences or close to a reception desk.

The routes between the building entrance, CP toilet and other key facilities should all be accessible, direct and free from obstructions. In situations in which a CP toilet is being provided in an existing building, alterations may be required to improve access between the building entrance and the CP toilet. These may include widening doors, eliminating steps, providing powered door-opening devices and improving surface finishes and lighting. All such improvements, many of which will likely require statutory consent, should be undertaken with reference to the guidance in BS 8300 and relevant technical documents under the building regulations, see Chapter 2, **Legislative background**.

## Signage and wayfinding

CP toilets should be clearly identified using the CP symbol, as shown below. Toilets displaying the symbol are required to meet the minimum standards set out by the CP Consortium. These standards can be achieved by following the guidance in this document.

The symbol should be used on directional signage as well as on the door to the toilet. It is important to create a clear route with signage at regular intervals from the entrance(s) of the venue to the CP facility. Larger venues with greater numbers of visitors should locate signage so that it is visible when crowds fill the area.

The symbol can also be used on leaflets, maps and guides, websites and other promotional material relating to the venue or area. Use of the symbol and 'Changing Places' wording will help people to identify the availability and whereabouts of facilities that meet their needs.



## Changing Places signage: the journey approach



Brighton's CP street signage is clearly visible above the crowds



Visually contrasting symbols and non-reflective signage at Newark town centre's public toilet facilities. Opening hours are extended to cater for events





Double-sided overhead signs are visible from different directions. In this example from Middlesbrough Bus Station, the logo is used with the words 'Changing Places Toilet' in clear print and in title case, which is easier to read



Clear directional signage for the CP facility and other toilet types should be provided in prominent locations



Overhead signage indicating step-free routes and lift access will help users find CP facilities at large venues

If a CP facility is used by people who do not require the specialist equipment, they may be preventing others from using it when they need it. Signage should be provided adjacent to a CP toilet to direct people to the nearest unisex accessible toilet and baby changing facilities.

Many people (including potential users) may not know what a CP toilet is. It is a good idea to promote the availability of the facility once it has been installed. A brief explanation of what a CP toilet is, provided on signage outside the facility, will help to advertise its availability to people in the vicinity.

Here is some suggested wording for the signage for an open access facility:



**This is a Changing Places toilet. It is provided for people with multiple disabilities who are accompanied by one or more assistants. For more information about Changing Places facilities, visit:**

**[www.changing-places.org](http://www.changing-places.org)**

If the CP facility is not open access, information about how to gain access must be provided.



The signage on the CP door at IKEA Edinburgh includes access information and directions to separate baby changing facilities

If a CP toilet is being installed, the Changing Places Consortium should be informed. Service users will then be able to access information relating to the facility via the Changing Places website. See also *Information management* in Chapter 6, **Management and maintenance**.



To raise awareness, Keighley Leisure Centre created a dedicated information board showing the equipment and facilities available

## Case study:

### Nottingham City Council's CP strategy

While working as Day Services Modernisation Project Manager at Nottingham City Council, Martin Jackaman became aware that day services staff could only take people with profound and multiple learning disabilities into the community for a couple of hours due to the unsuitability of standard accessible toilets for people requiring the support of an assistant. He set up a project team of representatives from different council departments, including an occupational therapist and a healthcare physiotherapist, to create a Changing Place toilet which would meet these needs. Using a video from PAMIS showing how family carers had to manage with inadequate facilities, he gained the support of the Councillor with Portfolio for Equality, the Carers' Forum and Partnership Board.

The project team's design was intended to meet a variety of needs, such as people who needed continence pads to be changed or who required support to get on to the toilet. The layout was piloted with users, carers and staff. In response to user feedback, the plan was adapted to include three horizontal grabrails next to the toilet.

The layout was then presented to the executive board and senior council officers, with the support of carers. The team's aim was to include the facility in the plan for new toilet provision in Nottingham city centre. They had to overcome some initial negative perceptions, such as why the project was needed and should be resourced, as well as concerns over possible health and safety risks.





Three horizontal grabrails were incorporated into the design after consultation

The team helped to gain support for the project by explaining that it helped the council meet equality obligations and would impact positively on subsequent performance management and inspections. They also presented evidence from individuals and PAMIS demonstrating the importance of such facilities.

The project team took a strategic approach, identifying venues that would enable families to do the things many people take for granted, such as visiting major leisure venues, shopping centres, hospitals and transport hubs.

They approached various council department officers and councillors responsible for future developments.

Their work resulted in Nottingham becoming a leader in the provision of CP facilities. The council supported the installation of CP facilities at venues including city centre public toilets as well as Ken Martin, Djanogly, and Victoria Leisure Centres, the heritage site Wollaton Park, Mary Potter and Bulwell Riverside Joint Service Centres, Nottingham Contemporary art gallery and major entertainment venue Capital FM Arena Nottingham at the National Ice Centre.

Although the project team disbanded in 2009, members have recently worked with Nottingham's two hospitals, the City and Queens Medical Centre and East Midlands Airport. At the time of publication, future plans included a refurbishment of Nottingham train station and Victoria Shopping Centre.

Besides the benefits to local residents and visitors to the city, in 2006 the team won a Community Care Award worth £5,000, which they put towards a further CP installation, and Mr Jackaman was named The Guardian's Public Servant of the Year 2007.

Mr Jackaman explained some of the factors behind the group's success:

**“It is important to seize opportunities when they arise: for example, when Nottingham City Council was rolling out a programme to modernise leisure centres, the group demonstrated how installing these toilets would benefit the service. It is also important to make clear repeatedly that these facilities cater to a different sort of need which requires a specific layout and equipment. With advances in medical science allowing people to live longer, the need to support carers is growing rapidly.”**

## Case study:

# Collaborative planning and design at NHS Grampian

The NHS Grampian Disability Discrimination Act Review Group, the majority of whose members are disabled people, carers and representatives from disabled people's organisations, is responsible for taking forward the disability agenda within NHS Grampian.

The group's membership includes Jenny Whinnett, PAMIS Family Support Service Co-ordinator for Grampian, who brought the group's attention to the problems faced by carers of adults with profound and multiple disabilities when visiting hospitals. The group resolved to overcome the issue.

**“Jenny alerted us to the fact that adults with multiple disabilities were being changed on the floors of our public toilets. We all felt this was totally unacceptable in terms of the dignity of the disabled person and the risk of injury this posed to carers from doing manual handling in a confined space, hence our determination to overcome this problem.”**

**Nigel Firth**, Equality and Diversity Manager at NHS Grampian

A subgroup was created to work on the project which included carers and disabled people as well as technical representatives. The subgroup developed a basic design for adult-changing facilities, which was then amended by identifying the best features of other such facilities.

Input from users led to further modifications: for example, for the facility at Aberdeen Royal Infirmary, assistants said that two drop-down grabrails would be the most appropriate configuration. The group later collected feedback from users which commented positively on this design. Similarly at the Woodend toilet, only one drop-down grabrail was originally installed. However, following feedback from users, it was decided to install a second drop-down grabrail.

Once they were satisfied that they had found the best configuration, the group agreed that this would become the blueprint for other CP facilities within NHS Grampian.

## Planning and design checklist

Strategic planning to identify appropriate venue(s) and location	<input type="checkbox"/>
Space at least 3m by 4m (12 sq m) available for the CP facility	<input type="checkbox"/>
Consult relevant stakeholders (including local disability and access groups)	<input type="checkbox"/>
Consult architect and access consultant	<input type="checkbox"/>
Obtain relevant statutory consents	<input type="checkbox"/>
Design appropriate to the context developed in consultation with stakeholders	<input type="checkbox"/>
<b>Room layout:</b>	
Direct access from the door into the manoeuvring space	<input type="checkbox"/>
Equipment positioned to maximise manoeuvring space	<input type="checkbox"/>
Easy and direct transfer using hoist between different areas	<input type="checkbox"/>
Sufficient room for an assistant on either side of the WC	<input type="checkbox"/>
Shower unit close to head of changing bench	<input type="checkbox"/>
Floor drain positioned to prevent water flowing across room	<input type="checkbox"/>
Privacy curtain or screen	<input type="checkbox"/>
Reference made to Changing Places layout and guidance	<input type="checkbox"/>
Accessible routes to the facility	<input type="checkbox"/>
Clear signage indicating the CP toilet's location	<input type="checkbox"/>
Clear information about access arrangements and guidance for use including sling compatibility	<input type="checkbox"/>
Additional information explaining the CP facility's purpose	<input type="checkbox"/>
CP Consortium informed about the new facility	<input type="checkbox"/>

# 4 Equipment and environment

This section looks in detail at each element of a Changing Places (CP) toilet, including door features, surface finishes, environmental services, equipment and fixtures. It covers the need for each element, how features are used, their layout and position.

In addition to using the guidance here, consultation with local groups and individuals is essential to help focus provision and meet the needs of the existing local population (see *Consultation* in Chapter 3, **Planning and design**).

## Doors

The door to a CP toilet should provide easy access into and out of the room, be clearly visible and easy to operate.

- The door should open outwards wherever possible (so it does not obstruct manoeuvring space within the room), and comprise a single door leaf.
- The door should provide an effective clear width of 1000mm.
- The door threshold should be level. Any change in floor finish along the line of the door should be bridged with a securely fixed low-profile threshold plate.
- An easy-action lever handle at 900mm height and / or a vertical pull handle with bottom end 700-1000mm and top end no lower than 1300mm above floor level should be provided.

- Outward-opening doors should have a horizontal rail on the inside face at a height of 900mm. This makes it easier for people to close the door behind them as they enter the room.
- Outward-opening doors should not obstruct any emergency escape route. Sliding doors, including pocket doors, should only be installed following consultation with the local building inspector and fire officer.
- Colours and surface finishes should be selected to optimise visual contrast between the door and adjacent wall surfaces, and between the door face and any handles, locks and horizontal rails. This helps people with visual impairments to differentiate between surfaces and fixtures.
- The door should have an unobstructed space next to the leading edge of the opening face of the door of at least 300mm. This space is not necessary where an automatic door is installed.
- Automatic doors should be considered where possible, because opening a door while guiding a wheelchair and carrying equipment can be difficult. Controls for automatic doors should be easy to use and should contrast visually with their background.

Guidance documents including AD M, Technical Handbooks and BS 8300 provide further information and detail on doors.

For relevant standards, see *Building regulations* in Chapter 2, **Legislative background**.





[Left] At Keighley Leisure Centre, the CP symbol appears on a blue door which stands out against the white wall. [Right] Marwell Zoo's CP toilet has a dark wooden door and frame, which contrast against the brick wall

## Alternative door designs

Wherever possible, the toilet door should be outward opening. However, where there is insufficient space for an outward-opening door, such as where a CP toilet is being installed in an existing building, the following alternatives could be considered:

**Reduced-swing door** – This operates with a sliding folding mechanism and requires a special track and suspension system. The area taken up by the door swing is much less than a conventional swing door.

**Sliding door** – This requires an overhead track which is fixed to the surface of the wall and can be concealed in a pelmet. A clear length of wall is required to one side for the door leaf to slide across. A disadvantage of sliding doors is that they provide minimal sound insulation, compromising privacy.

They should only be used where the installation of single-swing or reduced-swing doors is impractical.

**'Pocket' sliding door** – This incorporates a door leaf which slides into a specialist steel frame set inside a partition wall. Pocket doors provide improved sound resistance, and therefore better privacy. Pocket doors are not recommended where the door is immediately adjacent to a shower area due to potential corrosion of the steel frame.

**Double swing double door** – This is useful in situations in which the ceiling track for a hoist extends from the CP toilet to a poolside or other area. The centre of the door should be aligned with the ceiling track and the doors should swing in both directions.

It is important with all door types that a minimum effective clear width of 1000mm is maintained.





The automatic door to the CP toilet at City Hall, London. The push pad should be 750-1000mm above floor level and set back 1400mm from the leading edge of the door when open

## Door locks

All CP toilet doors require a privacy lock on the inside. Some CP toilets also require a security lock to prevent unauthorised access and to safeguard the facility when not in use. Whether a door is kept locked when not in use will depend on the location of the CP toilet, the proximity of building management staff, and the management policy for that facility (see *Security* in Chapter 6, **Management and maintenance**). The points below refer to privacy locks only.

- An easy-to-operate privacy lock which incorporates a red / white (occupied / vacant) visual indicator should be provided.
- Privacy locks should incorporate a mechanism that allows the door to be opened from the outside in an emergency.



A light action lever lock on the inside of this toilet is easy to use and changes the occupied / vacant indicator on the outside

## WC

The WC in a CP toilet should be provided in a peninsular arrangement (away from the walls) to allow sufficient space for an assistant on each side.

The WC should also be positioned to allow convenient transfer directly from a wheelchair or using the ceiling track hoist.

- The WC pan should be at least 1000mm from the nearest wall.
- The WC should have a seat height of 480mm to facilitate transfer from a wheelchair.
- The WC seat and its fixings should be sufficiently robust to support someone during transfer and their weight when

seated. Stainless steel seat fixings are preferred and they should be positioned directly into the top of the WC rim.

- Seats with a gap at the front should not be used. This style of seat can make it difficult for people to transfer, and the gap is a potential leg trap.
- Seat covers can obstruct transfer when raised unless they are well designed and fixed to serve as a comfortable backrest.
- The use of close-coupled WCs is generally preferred. This style of WC provides an integral backrest and, as long as the cistern has a flat top, also provides a shelf for colostomy bags.
- If low- or high-level cisterns are used, a padded backrest and a wall-mounted colostomy shelf should be provided.
- Backrests should be designed to be as comfortable as possible, with no raised edges, and should be sufficiently strong to provide back support.
- A shelf for colostomy bags 100mm to 150mm deep and at least 400mm wide should be fitted 950mm above floor level. The shelf should be positioned where it will not obstruct use of the wall-mounted handrails or other equipment, but where it is within reach of a person using the WC.
- Toilet tissue should be positioned where it can be reached easily by an assistant and also by a person seated on the WC. A wall-mounted dispenser could be provided as well for the convenience of an assistant. Consultation with user groups will help decide whether a sheet dispenser or a toilet roll is more appropriate.
- Automatic 'wash and dry' toilets are not a Changing Places requirement. They should be considered in regularly managed sites in consultation with user-groups.

Automatic toilets require specific maintenance, and instructions for use should be provided.



Peninsular layout WC with transfer space and drop-down grabrails on both sides. Alarm cords should not be tied up and the transfer space kept clear

© Queen's Medical Centre, Nottingham University Hospitals NHS Trust

## Grabrails and drop-down support rails

Wall-mounted vertical grabrails (fixed-position handrails) and drop-down support rails should be provided to both sides of the WC to offer support to people while transferring and while seated. The wall-mounted vertical grabrails assist people adopting a frontal transfer and people who are able to stand while using the WC.

Drop-down rails can be lowered to assist during transfer or to provide support to a person while seated on the WC. They should be raised when not in use so they do not obstruct transfer using a hoist.

It is essential that grabrails, support-rail fixings and the structure on which they are fitted are strong enough to support the weight of a person.

- All fixed grabrails should be tubular in cross-section, 32mm to 35mm in diameter, minimum 600mm long and with a clearance of 50mm to 60mm between the wall surface and the grabrails.
- Vertical grabrails should be positioned with the centre line 1100mm above floor level.
- All grabrails and drop-down support rails should contrast visually with the surface they are mounted on so that they are easy to identify.
- Grabrails and drop-down support rails should be made of a material that is easy to grip and that does not become slippery when wet.
- Wherever possible, drop-down support rails should be height adjustable as these offer greater flexibility and improve safety. Where fixed-height drop-down rails are provided, the upper rail should be 680mm above floor level when in the horizontal position.
- All drop-down support rails should be firmly held when folded up against the walls, but must be easy to release when required.
- Drop-down support rails should be positioned 320mm either side of the centre line of the WC and project 50mm to 100mm beyond the front of the WC when horizontal.



Drop-down rails on both sides of the WC can be folded up when not needed or dropped-down into horizontal position for support. The black grabrails contrast visually against the pale background

## Height-adjustable washbasin

Ideally a washbasin that is height adjustable should be provided to allow people to use it from either a seated or standing position. The washbasin should be positioned at a height at which a wheelchair user can easily reach the taps and use the bowl. To prevent back strain or injury, it should be possible to raise it to a suitable height so that the assistant can use it when standing.

- The washbasin should have a large bowl, but not so large that it will be difficult to reach the taps or a wall-mounted soap dispenser.
- Level areas at either side of the washbasin, provided with most height-adjustable units, can provide forearm support.

- The washbasin should provide a clear knee space below the bowl and should not have a pedestal. All supply and waste pipes should be neatly positioned to avoid obstructing the knee space.
- The washbasin should be adjustable in height if possible. The majority of commercially available washbasins allow height adjustment within the range of 580mm to 1030mm above floor level.
- The height-adjustment mechanism should be power assisted (either electrical or hydraulic). Instructions and controls for adjusting the height should be clearly visible and easy to follow.
- The height-adjustment mechanism should have a pressure-sensitive safety override to prevent the washbasin from lowering if there is any obstruction underneath.
- Height-adjustable washbasins require flexible tap and waste pipe connectors to enable the washbasin to be raised and lowered to its maximum extent. These connectors are enclosed or concealed behind a rear panel in most models.
- If it is not possible to provide the height-adjustable facility, the washbasin should be installed at a height accessible to a wheelchair user (720-740mm from floor).



Height-adjustable washbasin with flat sides to rest arms and a lever mixer tap at Warminster Civic Centre

## Taps

Washbasin taps should be easy to operate and adjust, and water temperature should be controlled to avoid the risk of injury. Mixer taps should be provided wherever possible. Infrared touch-free taps are beneficial to some users, as long as they are suitably responsive, but they can be confusing to some people and may not always offer the best solution. Again, it is important to consult potential users to determine the most appropriate fittings (see *Consultation* in Chapter 3, **Planning and design**).

- Where manually-operated taps are provided, they should be lever mixer taps. Mixer taps should be positioned centrally, with a single lever to adjust water flow.
- Where infrared touch-free taps are provided, the sensor eye should be positioned in line with the water outlet.
- Where it is not possible to provide a mixer tap, individual hot and cold water taps should be operated by a lever which requires no more than a quarter turn.
- Where individual taps are used, the convention for hot to be positioned on the left and cold on the right should be used. This is particularly beneficial for visually impaired people. Clear colour-coding and lettering will also aid identification.
- The hot water supplied to washbasin taps should not exceed 43°C (degrees Celsius) at the outlet. Temperatures higher than this present a risk of injury.
- Hot water circulating inside pipework should be at least 60°C to avoid risk of legionella.

## Soap dispenser

- A soap dispenser should be wall mounted directly above the washbasin. It should be within reach of a person seated in a wheelchair, with the underside between 800-1000mm above floor level.
- The dispenser should be positioned to allow room for it to be operated when the washbasin is at its highest position.
- The dispenser should be easy to operate with one hand.

## Hand drying

A means of drying hands should be provided close to the washbasin. Wherever possible, paper towels should be provided in addition to a hot-air hand dryer. Hand dryers requiring users to put their hands into a limited space at the top of a hand dryer should not be installed. Some 'ultrapid' hand dryers can be too loud, causing discomfort for some users, including people with sensory impairments and people with dementia.

- A paper-towel dispenser should be wall mounted close to the washbasin, with the lower edge positioned 800mm to 1000mm above floor level. The dispenser should be a type that can be used easily with one hand.
- A hot-air hand dryer should be provided on the door side of the washbasin, positioned with the underside 800mm to 1000mm above floor level.
- Hand-drying facilities and any controls should contrast clearly against their backgrounds. Polished metal finishes should be avoided as reflective surfaces are more difficult to see.

## Ceiling track hoist

A ceiling track hoist which covers the whole room should be provided wherever possible to enable a person to be transferred conveniently between their wheelchair, the changing bench, WC and washbasin. Such hoists are sometimes referred to as an X-Y system or H-system hoist.

Full room coverage provides access to all the equipment and clear manoeuvring space within the facility. A single-track hoist only covers a linear route and may limit movement within a room.

Mobile hoists are not recommended. They reduce manoeuvring space, and may require an alternative space outside the toilet for charging. They are also liable to being removed, and may cause manual handling issues for assistants unfamiliar with specific models.

- Hoists should conform to BS EN ISO 10535 (Chapter 7, **Sources of further information**). The safe working load of any hoist should be at least 200kg (440lbs) and the structure of the walls and ceiling should be sufficient to support this. The safe working load and clear, easy-to-read instructions should be clearly displayed.
- The ceiling height should be at least 2.4m. There should be sufficient space for the hoist track, motor and supporting arms above the working area.
- All other ceiling-mounted fixtures such as lights and alarms should be shallow or recessed and positioned away from the ceiling track to avoid causing an obstruction to the hoist.
- The hoist sling connectors should offer the broadest possible compatibility with



different types of sling, including those by other manufacturers.

- Hoists should incorporate the following features:
  - easy-to-use handset controls
  - auxiliary controls on the motor unit
  - soft-start and soft-stop motor control
  - convenient location for hoist motor to be parked for battery charging
  - return-to-charge feature to ensure that the hoist motor is regularly charged
  - emergency-lowering and emergency-stopping device
  - optimum compatibility with a range of sling types and manufacturers.

Hoists must be regularly inspected, serviced and maintained in order to ensure safe, effective use. Hoists are subject to the Lifting Operations and Lifting Equipment Regulations 1998 (see *Health and safety legislation* in Chapter 2, **Legislative background** and *Equipment tests and maintenance* in Chapter 6, **Management and maintenance**).



The East Midlands Airport have installed a hoist with maximum safe lifting weight of 295kg (46 stone) and included clear signage indicating capacities of the equipment

Specialist advice should be sought when selecting a hoist for installation in a CP toilet. Possible sources of advice include occupational therapists, the Changing Places Consortium and Assist UK.

## Hoist slings

A sling is used in conjunction with the ceiling hoist to enable its user to be transferred between the facilities in a CP toilet. **Slings are not expected to be provided within a CP toilet.** Slings are assessed to meet individual needs and are intended for personal use only. It is common practice for individuals to have their own slings and to carry them for use outside their home.

There are currently two main types of sling attachments to hoists available: loop and click.

Loop attachments potentially provide the greatest compatibility compared to click attachments, which can only be used with a limited range of specific sling types. It is essential to consult potential local and regular users to ascertain the most suitable hoist system. The compatibility of the hoist should be clearly advertised so that users can bring the correct slings for use.

Information relating to the type of hoist should be readily available in advance so that visitors can bring compatible slings. For example, it should be listed on the venue's website, the Changing Places Consortium website, on any visitor information and on printed / online fact sheets available from the venue. It is also important to confirm that slings will not be provided. See *Information management* in Chapter 6, **Management and maintenance** for further details.

## Privacy screen

A curtain or screen should be provided between the toilet and the rest of the room. This provides privacy for people who, having been assisted into position on the toilet, are then able to use it unaided. It also allows an assistant to use the toilet in privacy if it is not appropriate for the person they are accompanying to be left alone outside the room.

- Wall-mounted retractable screens or free-standing folding screens are preferred as they take up minimal space when fully retracted but provide the necessary privacy when extended.
- When retracted, wall-mounted screens should not obstruct the space to the side of the WC.
- Ceiling-mounted curtain tracks or fixed rails are unlikely to be suitable as they may obstruct the ceiling-track hoist.



A folding screen provides privacy for CP users and assistants and should be provided in all CP facilities

## Height-adjustable changing bench

An adult-sized changing bench should be provided to enable people who are unable to sit on the toilet or shower seat to lie down while being changed or showered. Height adjustment enables the bench level to be lowered to a suitable height for self-transfer from a wheelchair or assisted transfer using a hoist, and then raised to a working height for one or more assistants.

- The changing bench should be either freestanding or wall-mounted. It should be at least 1800mm long and 800mm wide (as a minimum) and adjustable in height, usually within the range 300mm to 1000mm above floor level.
- A changing bench with a minimum safe working load of 200kg (440lbs) is recommended - a higher capacity is preferred for use by a greater range of users. The safe working load of the equipment should be clearly displayed.
- The height-adjustment mechanism for wall-mounted benches should be mains powered. If freestanding benches are battery powered, they will need regular charging and management. The controls should be easy to operate using a handheld unit, which should either have a wander lead or be a remote-control device. Instructions for adjusting the height and activating safety mechanisms should be clearly visible and easy to follow.
- The changing bench should have a comfortable surface that is suitable for changing and showering, such as perforated netting, and must be easy to clean.

- If a showering facility is provided within the CP toilet, the bench should have an integral water collection tray, also known as a water catchment tray, with a waste outlet and hose.
- Some models of changing bench offer an adjustable backrest at one or both ends which can improve comfort.
- Safety rails should be provided on the changing bench so that assistants can choose to use them when appropriate and under supervision.

There are advantages and disadvantages to both freestanding and wall-mounted benches, as set out in the table below. Selection of the most appropriate type of changing bench should be carefully considered, taking into account the needs of people consulted during the planning stage of the project (see *Consultation* in Chapter 3, **Planning and design**).

## Advantages and disadvantages of freestanding and wall-mounted changing benches

Advantages	Disadvantages
<b>Freestanding</b>	
<ul style="list-style-type: none"> <li>● A freestanding bench can be moved, offering greater flexibility and a range of transfer positions.</li> <li>● The shower can be used in conjunction with a shower seat if the bench can be moved away from the shower area.</li> <li>● Assistants are able to access both sides to assist with manual handling.</li> <li>● Battery-operated benches offer easy height adjustment. Hydraulic benches can be manually adjusted.</li> </ul>	<ul style="list-style-type: none"> <li>● The bench may be taken out of the room, with the result that it is unavailable when required.</li> <li>● Freestanding benches typically take up more space than wall-mounted benches that fold flat against a wall.</li> <li>● If the bench is battery powered it will require regular recharging and maintenance checks.</li> </ul>
<b>Wall-mounted</b>	
<ul style="list-style-type: none"> <li>● It may be possible to fold the bench up against the wall when not in use, increasing clear floor space.</li> <li>● The bench cannot be removed or taken out of the room and stored elsewhere.</li> </ul>	<ul style="list-style-type: none"> <li>● Assistants can only stand on one side, restricting manual handling.</li> <li>● The bench position is fixed, limiting flexibility of use and transfer options.</li> <li>● There is a slight reduction in space in the shower area when the bench is folded up against the wall.</li> </ul>



A wall-mounted changing bench at Cherwell Valley Moto Services. It is height adjustable, with maximum-load capacity and instructions clearly on display



The freestanding changing bench at the Brighton Colonnade public toilets allows flexible use of space

## Wide paper roll dispenser

A dispenser with a wide paper roll (sometimes referred to as a couch roll) should be provided adjacent to the changing bench. This allows assistants to place paper over the changing bench surface to promote good hygiene and to aid the changing and cleansing process.

- The dispenser should be wall mounted. It should be adjacent to the head of the changing bench and within easy reach of the assistant, although not too close to the shower.
- The dispenser should be positioned with the underside between 800mm and 1000mm above floor level.

## Shower

Showers enable people to wash after using the WC or while being changed. A shower should be included in the design of a CP toilet in relevant types of managed buildings such as leisure centres, travel hubs or for specific projects. A shower is not required for all CP toilets.

The preferred area for the shower is in a corner of the room where it can be used in conjunction with the changing bench or shower seat. It is best if the shower area can be positioned away from the door so that the floor surface in this area does not become unnecessarily wet.

- The floor in a CP toilet should be designed as a wetroom floor. A continuous waterproof non-slip floor surface should cover the whole room and have an integral waterproof skirting (also called a coved skirting).
- The shower area should provide step-free access to facilitate easy transfer from a wheelchair, and unimpeded movement for a freestanding changing bench or shower seat.
- The floor in the shower area should be very slightly sloped, with a gradient no greater than 1:50, to enable water to drain towards a floor outlet.



- The outlet should be recessed into the floor structure and have a cover flush with the floor surface. Ideally a floor drain would be placed adjacent to a wall or in a corner away from main activity / turning space.
- The shower unit should be wall-mounted adjacent to the changing bench where it can be easily reached and operated by an assistant or by a person seated on a shower seat.
- The shower controls should be easy to read and operate, and should be positioned between 750mm and 1000mm above floor level.
- The shower head should be detachable and mounted on a flexible hose. The hose should be of sufficient length for users to be showered on the changing bench or in a shower seat. A hose length of 2000mm is suggested, depending on layout.
- A vertical mounting bar and adjustable bracket should be provided to enable the shower head to be positioned within the range 1200mm to 1400mm above floor level. The vertical bar can extend from 1050-1800mm to allow more flexible use but shower head must always be within reach at the lower level.
- The water temperature for the shower should be adjustable, but should not exceed 43°C at the outlet.
- The water temperature in the pipework should be at least 60°C to avoid the risk of legionella.
- Where appropriate, such as in hotels and selected leisure environments, a supply of clean towels should be provided.
- In certain environments, such as in hospitals and day-care facilities, a low-height sluice outlet should be provided in the shower area.

## Shower seat

It is good practice to offer a range of facilities. A shower seat, provided in addition to a changing bench, allows users to shower in a seated upright position.

- The shower seat should be slip resistant and wall-mounted, and a backrest and support handrails should be provided.
- Fold-down or tip-down seats provide more space when not in use, but these should not be spring loaded.
- The seat should preferably be height adjustable, or 480mm from floor level. The edge of the seat should be at least 650mm from the mounted wall. Larger seats allow use by a wider range of people.
- The seat should be able to support a weight of at least 200kg (440lbs).



The CP facility at Ken Martin Leisure Centre in Nottingham includes a shower seat with a backrest and drop-down arm supports



# Recommended heights for shower area with shower seat

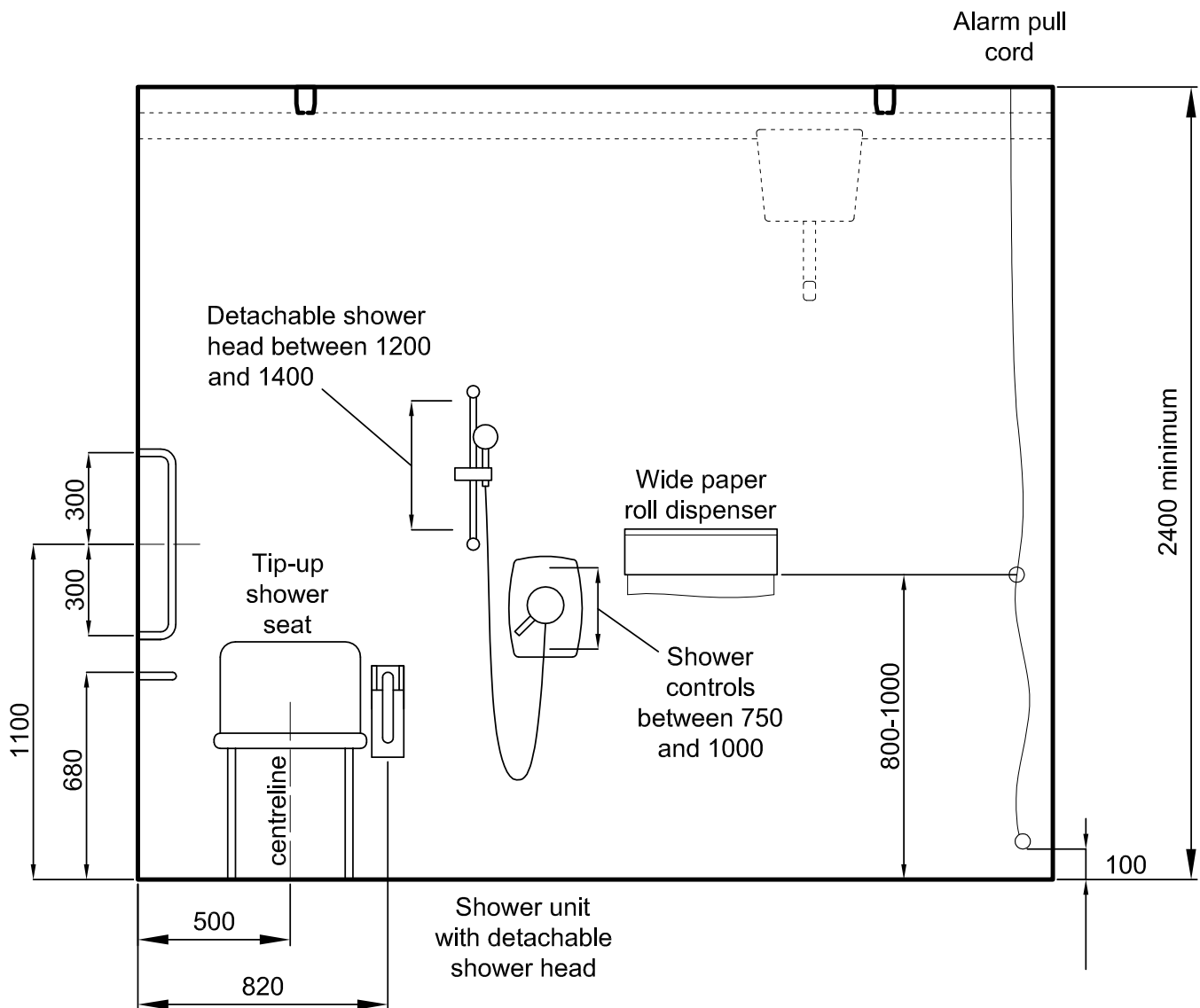

All dimensions in millimetres

## Waste bins

Adequate receptacles for waste, including separate bins for general waste and personal hygiene products, should be provided, and must be emptied regularly. See *Day-to-day management* in Chapter 6, **Management and maintenance** for more information.

- The sanitary-disposal bin should be large enough to accommodate adult-sized incontinence pads. It should be positioned within easy reach of the WC, but not where it will obstruct access.
- A disposal bin for general waste should be positioned where it can be reached easily from the clear manoeuvring space. In facilities that provide paper towels, the bin should not be far from the paper towel dispenser.
- The disposal unit and general waste bin should be recessed into the wall. This maximises space and reduces the risk of the bin obstructing movement or equipment. A waste bin could shatter and cause damage if it is stored underneath the height-adjustable bench.



A large bin should be provided for the disposal of adult-sized pads

## Mirror

A full-length mirror with unobstructed access should be provided within a CP toilet to enable people to view themselves and to adjust their clothing.

- A wall-mounted mirror should be provided, 600mm wide and at least 1000mm tall, positioned with the lower edge no higher than 600mm above the floor.
- Mirrors should not extend to floor level as this can create a false impression of being a door or wall opening.

## Assistance alarm

An assistance alarm should be provided to enable a disabled person or their assistant to summon assistance. This should incorporate visual and audio indicators which differ from those of the fire alarm system to avoid confusion.

Emergency alarm alerts should be positioned in areas which are permanently staffed, and staff must be trained in providing appropriate assistance. See *Staff training* in Chapter 6, **Management and maintenance**.

- The alarm system should comprise two alarm pull cords and a reset button within the room.
- One alarm pull cord should be positioned adjacent to the toilet where it can be reached from the toilet.
- A further alarm pull cord should be positioned near to the door, but not where it will be confused with the light pull cord.
- Alarm pull cords should be coloured red and extend down to within 100mm of the



Alarm cord with bangles at two heights, which can be reached easily if a CP user or assistant has fallen onto the floor. The reset button should be easy to find and operate if the alarm is accidentally triggered



It is good practice to install an alarm in the shower area. The red cord and bangles should contrast against the background and should be easy to identify

floor. This is so that they can be reached easily in the event of a user falling to the floor.

- The pull cords should incorporate two red bangles, 50mm in diameter. One bangle should be positioned at the end of the cord (100mm above floor level) and the other at a height between 800mm and 1000mm above floor level.
- An alarm reset button should be positioned within the room, preferably close to the toilet, at a height between 800mm and 1000mm above floor level.
- The reset control, a button or switch, should be easy to identify and operate.

- The system should incorporate an indication that the alarm has been raised as this will reassure users that assistance is on its way.
- Above the door on the outside of the room, an alarm indicator should be provided, incorporating both a light and sounder.

## Coat hooks

Sufficient coat hooks should be provided to enable a CP user and two assistants to hang their coats and bags. Coat hooks should be positioned at two different heights – 1050mm and 1400mm above floor level – to meet the needs of people of different heights and with a different reach range.

## Sanitary-towel dispensers

Installing a vending machine dispensing sanitary and hygiene products is recommended, and it should be easy to reach and operate. Wherever possible, a recessed or slimline unit should be selected so that it does not reduce and encroach into the useable floor space or present an obstruction. Controls, coin slots and the dispensing drawer should be positioned at a height between 750mm and 1200mm.

## Heating

CP toilets should be heated to maintain a comfortable temperature when they are available for use. The room temperature should take account of the fact that many people using the facilities may be undressed for an extended period, such as while being changed or showered.

- Underfloor heating is recommended wherever it is practical to install, such as in new-build CP toilets or where the room is being substantially renovated. Underfloor heating is ideal for CP toilets as:
  - it provides a consistent room temperature
  - it provides a warm floor surface, which improves comfort and ensures that the floor surface dries faster
  - it ensures greater floor space as it avoids the need for wall-mounted radiators which may reduce the useable floor space.
- If radiators are provided, they should be carefully positioned so as not to obstruct access to and use of any equipment. They should have a maximum surface temperature of 43°C. Radiator pipes should also be fully concealed or guarded.
- Convection and fan-type heaters should be avoided as they can create draughts and cause discomfort. Fan heaters also generate background noise which can impair communications and create an unpleasant environment.

## Water supply

Hot water in pipes supplying washbasins and showers is required to be at least 60°C in order to avoid the risk of legionella. However, thermostatic valves should be used to ensure that the water temperature at the point of supply is much lower.

- At the point of supply, water temperature should not exceed 43°C.
- Water supply pipes should be concealed or boxed in to avoid the risk of injury.

## Ventilation

CP toilets should be adequately ventilated to provide fresh air and to remove moisture after showering, where applicable. The ventilation system should be designed to meet the requirements of the relevant building regulations.

- The operation of the mechanical ventilation system could be linked to use of the lights. This could incorporate, for example, a 15-minute overrun once the lights have been switched off.
- Mechanical ventilation and extract systems should be as quiet as possible as the noise generated by certain systems can be distressing to some people. Regular cleaning and maintenance can greatly reduce noise levels.
- Supplementary natural ventilation via windows may be desirable in some circumstances. Where windows that can be opened are provided, they should be carefully positioned to maintain comfort and privacy.
- Handles and opening mechanisms for windows should be easy and safe to use, and should contrast visually with their background.
- Where high-level windows that can be opened are provided, either a lower-level winding handle or remote-control device for electrical operation should be provided between 800mm and 1000mm above floor level.

## Lighting and décor

It is important to ensure that the décor creates strong visual contrast between the fittings and their background. A warm, welcoming environment should be created. The facility should be as pleasant as possible as users may spend considerable periods of time there.

Artificial lighting should be provided to achieve an even level of illumination throughout the room. Given the size of the room, it is likely that more than one light fitting will be required. Light fittings controlled by a timer should be avoided because an assistant may have to move away from the CP user in order to reactivate the light, and this could compromise safety.

The use of ultraviolet light, which is used in some public conveniences to deter drug use, should not be used in CP toilets. Ultraviolet light reduces visual contrast between surfaces and fittings and is also known to induce seizures.

- Matt surfaces should be used to avoid glare.
- Pale tones for walls and ceilings help to reflect light more evenly.
- The floor finish and the door should contrast with the walls so that they can be easily identified.
- Fittings such as grabrails, dispensers, pull cords and switches should also contrast with their surroundings.
- Artificial lighting should provide an even level of illumination of 300 lux at the height of the changing bench.
- The position of lights should not create strong contrasts between light and shade or cause glare or reflections.

- Light fittings should be shallow or recessed and positioned away from the ceiling track to avoid causing an obstruction to the hoist.
- Uplighters may be appropriate next to a changing bench to avoid users having to look directly at an overhead light source while lying down. Lights should be of a type suitable for use in wet rooms.
- Light switches should be a pull cord type positioned 150mm from the leading edge of the door. The pull cord should extend to between 900mm and 1000mm above floor level.
- Although the light pull cord fitting should contrast in colour with the adjacent wall surface, it should not be red in colour as it may be mistaken for an emergency assistance pull cord.



The fittings at the CP facility at City Hall, London, contrast visually with their background

The design of the CP toilet at City Hall was based on consultation with staff and regular visitors, which resulted in an attractive facility with good visual contrast. The Access Consultant for this facility, Ann Sawyer, said:

**“The appearance was considered carefully, in order to ensure the fittings and finishes specified would look good as well as work well. As they say, however, ‘the devil is in the detail’; a great deal of time was spent trying to find the most suitable tap, soap dispenser and so on.”**



# Equipment and environment checklist

## Pre-visit information:

Location and how to access the facility

Working capacity of the hoist and changing bench

Hoist compatibility with sling types

Confirm that slings are not provided

Availability of shower facilities

Above information available on venue website, publicity, leaflets and from staff

## Door:

Visually contrasting frame, handle and lock with clear CP signage

If locked, access instructions provided outside

Minimum of 1000mm effective clear width, outward opening if possible

Horizontal pull bar at 900mm height on inside of the door

Easy-to-use privacy lock

Coat hooks on the inside at two heights, 1050mm and 1400mm

## WC:

Peninsular (space both sides) at least 1000mm from the wall

Seat height 480mm from floor

Comfortable back rest

Toilet paper within reach

Retractable wall-mounted / freestanding folding screen

Colostomy shelf fixed within reach of the WC 950mm from floor

### Grabrails / Drop-down support rails:

Contrast visually with background

Drop-down support rails 320mm either side, upper rail 680mm above the floor when in horizontal position

Vertical grabrails with centre at 1100mm height

Easy to grip, minimum 600mm long, 32-35mm diameter

### Washbasin:

Height adjustable (usual range 580-1030mm) with safety stop or positioned at 720-740mm from floor (if fixed)

Clear knee space underneath (700mm from floor)

Large bowl but taps still within reach

Level surface either side for arm rests

Lever mixer tap

Soap dispenser above, easy to use and well within reach

### Hand drying:

Automatic hand dryer near basin

Paper towels supplied in addition

Hand-drying facilities contrast against surroundings without having reflective surfaces, 800mm -1000mm from floor

**Ceiling-track hoist:**

**Full room coverage**

**Minimum 200kg – greater capacity recommended**

**Minimum ceiling height 2.4m**

**Ceiling lights and alarms recessed**

**Sling compatibility information provided**

**Instructions and working load clearly visible and easy to understand**

**Emergency lower / stop**

**Return-to-charge feature and charging location instructions**

---

**Changing bench:**

**Freestanding or wall-mounted**

**Minimum 1800mm long and 800mm wide**

**Adjustable in height 300mm-1000mm from floor level**

**Minimum working load 200kg (higher recommended)**

**Instructions for use and working load clearly displayed**

**Comfortable surface for changing or showering**

**Wide paper roll dispenser provided by bench, 800-1000mm from floor**

---

**Privacy Screen:**

**Freestanding or wall-mounted screen provided**

**Folds away without obstructing other equipment**

<p><b>Shower:</b></p> <p><b>Non-slip, wetroom floor design</b></p> <p><b>Step-free access, maximum slope 1:50 for water drainage</b></p> <p><b>Shower unit with detachable head, located next to changing bench</b></p>	<input type="checkbox"/> <input type="checkbox"/> <input type="checkbox"/>
<p><b>Shower seat (if provided)</b></p> <p><b>Shower seat with backrest and supporting grabrail</b></p> <p><b>Adjustable height or 480mm from floor, seat edge 650mm from wall (min)</b></p> <p><b>Minimum safe working load 200kg, higher capacity recommended</b></p>	<input type="checkbox"/> <input type="checkbox"/> <input type="checkbox"/>
<p><b>Bins:</b></p> <p><b>Large sanitary disposal bin (not narrow type)</b></p> <p><b>Recessed where possible, not under changing bench or in transfer space</b></p> <p><b>Separate bins for general waste and paper towels</b></p>	<input type="checkbox"/> <input type="checkbox"/> <input type="checkbox"/>
<p><b>Alarm system:</b></p> <p><b>Audible and with indicator light, linked to staffed area</b></p> <p><b>Alarm pull cords should be red and have bangles at two heights: 100mm and 800-1000mm from the floor</b></p> <p><b>Alarm should have at least two pull cords, one that can be reached from the WC, the other by the door (based on BS8300 layout)</b></p> <p><b>Pull cords should not obstruct hoist movement or other equipment</b></p> <p><b>Contrasting reset button located near alarm and easy to find</b></p>	<input type="checkbox"/> <input type="checkbox"/> <input type="checkbox"/> <input type="checkbox"/> <input type="checkbox"/>





## Construction costs

**Providing a Changing Places (CP) facility as part of a new development is usually more cost effective than retrofitting the same facility into an existing structure. The provision of CP toilets should be considered from the outset in all major new developments and large-scale refurbishment and extension projects.**

Where a CP toilet is being provided in an existing building, the project cost will depend, to a large extent, on the alterations required to create the space needed. There may be additional costs if alterations are required in other parts of the building to facilitate access, such as widening doors and providing ramps.

The case studies included in this chapter provide an indication of costs, which may offer a rough guide for comparable schemes.

## Funding

Charities, not-for-profit organisations and social enterprises typically have greater access to grant funding and alternative finance streams than their commercial counterparts. For example, financial assistance may be available from charitable trusts, local and regional councils and lottery funders. Sufficient funds to cover the design and installation of a CP toilet may be derived from a single funder or from a number of sources. Funds may be available purely to finance the installation of a CP

toilet, or to finance a larger project of which a CP toilet is a component part. Whilst initial funding for installation may be available to organisations, any additional ongoing funding for maintenance will need to be considered.

Large commercial organisations such as the operators of a shopping centre or a large hotel are expected to fund the installation and running costs associated with a CP toilet themselves. In these instances, the cost of installing a CP toilet would be viewed as part of the overall development and operational costs for the organisation, as would expenditure relating to other facilities provided for public use.

## VAT relief

In the majority of cases, and certainly for all works undertaken by commercial organisations, construction work and the supply of equipment are VAT standard-rated. There are certain situations in which a lower or zero rate of VAT can be applied (See *HMRC Notices* in Chapter 7, **Sources of further information**).

In all cases, it is the supplier (the building contractor in the case of installing a CP toilet) who is responsible for ensuring that the correct rate of VAT is applied. Where goods and services qualify for zero rating, the client organisation and the supplier are required to sign a declaration confirming eligibility.

## Charities

Registered charities and not-for-profit organisations that are treated by HMRC as charitable are currently able to zero rate the construction and adaptation of certain elements in a building and the supply of particular equipment if certain criteria are met. These include toilets and washrooms, sanitary devices and hoists provided for disabled people.

For current information on VAT, refer to HM Revenue and Customs' website:

<http://www.hmrc.gov.uk/>

In all cases, it is advisable for the client organisation to seek clarification from an accountant or construction professional who is familiar with current VAT arrangements.

### Case study:

## Cross-sector partnerships



A private company financed the installation of the CP facility at the seafront public toilets in Brighton, while the local authority pays for maintenance



Debenhams Blackpool provided the space for the CP facility, while the council financed the installation and maintenance © John Burke

Wetton Cleaning Services, the cleaning company contracted to service the Brighton and Hove City Council public conveniences, financed the installation of the CP toilet at The Colonnade, Madeira Drive, Brighton. The toilet was installed as part of a major refurbishment of the existing seafront public toilets. The total cost of the building works and equipment for the CP toilet was just over £20,000. Brighton and Hove City Council states that it costs £200 annually to maintain the equipment in the toilet.

In Blackpool, Debenhams department store and the local council ensured the provision of a CP facility through an innovative agreement, in which Debenhams provided the space and the council financed the installation and maintenance costs.

**“We were very happy to work with the council and Changing Places on introducing a great facility for our shoppers and visitors. The facility is well used both by residents and visitors to Blackpool, and their families.”**

**Graham Dickinson**, *Store Manager, Blackpool Debenhams*



Erewash Borough Council funded the installation of the CP facility at Ilkeston Co-op Department Store, now managed by Midlands Co-operative Society © Garth Newton. Reproduced under the terms of a Creative Commons Licence <http://creativecommons.org/licenses/by-nc-sa/2.0/uk/>

Responding to local representations, Erewash Borough Council provided £36,000 funding for the installation of the Changing Places toilet at the Ilkeston Co-op Department Store. Midlands Co-operative Society is responsible for managing the facilities.

Speaking prior to the installation of the CP facility, Councillor Geoffrey Smith, Erewash Borough Council's Lead Member for Regeneration and Planning, said:

**“The Changing Places toilet will make such a difference to the many people, both young and old, who have serious or multiple disabilities and we are very proud to be working with the Co-operative Society to provide this facility in Ilkeston town centre. It is a great example of partnership working for the benefit of the community.”**

## Case study:

# Central government funding

The CP toilet at Sutton Railway Station was part funded by the Department for Transport under its Access for All programme. Access for All funding is targeted towards infrastructure improvements at Network Rail stations in England and Wales, which will enable more disabled people to access the rail network.

The funding available is from £250,000 to £1 million per scheme, and is only granted to projects that have reached a credible stage of development, having completed all appropriate feasibility studies and having identified other funding sources.





The CP facility at Sutton Railway Station was part funded by the Government's Access for All programme

Case study:

## Trust funding



The countryside around Divis and Black Mountain Long Barn visitor centre

The Divis and Black Mountain Long Barn visitor centre opened to the public in 2009, supported by funding from the Northern Ireland Environment Agency, the Heritage Lottery Fund and Ulster Gardens Villages. The centre's CP facilities cost £15,000 and were funded by the National Trust Access for All scheme, Adapt Northern Ireland and the Bruce Wake Charitable Trust.

**“Divis and Black Mountain are wonderful heritage assets and this project is a great example of how Lottery players’ money can benefit the widest possible audience. Thousands of people have already enjoyed visiting this unique landscape, and the provision of these additional facilities will enable many more people to access and enjoy the mountains for the first time. We’re delighted to have been able to help make that possible.”**

**Ronnie Spence**, *Chairman of the Lottery Fund Committee for Northern Ireland*



## 6 Management and maintenance

**Efficient management and maintenance of Changing Places (CP) toilets is essential to their day-to-day operation and ongoing viability. Good management involves the provision of relevant staff training, and effective and appropriate communications. Regular cleaning and servicing are also essential.**

Ensuring good practice in management and maintenance can also safeguard the providers of CP toilets by demonstrating that risks are well managed. Keeping accurate records of daily activities, such as cleaning and equipment inspections, and of annual servicing of hoists and benches will provide evidence of good management practice. See Chapter 2, **Legislative background**, for further information on risk management.

Providing staff who manage a CP toilet with disability awareness training and an understanding of how people use the equipment is very important. However, staff do not require manual-handling training themselves as they are not expected to provide personal assistance to people using the facility.

In a CP toilet used predominantly by visitors, assistants are less likely to be familiar with the particular items of equipment or individual controls. Providing clearly visible instructions that are easy to follow, and frequent checks by management staff between users, such as checking that the hoist is returned to the charging station, will help ensure that equipment is ready for the next user.



The CP toilet at the Tate Modern has large, eye-catching lettering on the wall to remind users and staff that the hoist should be returned to the charger. This has the additional advantage of indicating the location of the charger

**“It is important that staff receive training on Changing Places to understand why they are needed, the equipment and how it all works. It is a chance to clarify what is and isn’t their responsibility. They will play a vital role which includes providing information about the CP toilet, as well as promoting its availability to potential users.”**

**Ann Sawyer**, Access Consultant for the City Hall CP



## Watchpoints

### The organisation providing a CP toilet is responsible for: ✓

- undertaking a full risk assessment of the facility and managing risk
- displaying clear instructions and relevant information regarding the equipment provided
- providing accurate information on the availability and location of facilities
- checking all equipment daily to ensure it is clean, charged and ready for use
- ensuring that all equipment is regularly maintained and inspected in accordance with manufacturers' recommendations and relevant legislation.

### The organisation and its staff are not responsible for: ✗

- undertaking a risk assessment for **individual** disabled people and their assistants
- providing physical assistance to a disabled person using the CP facilities
- providing slings for use with the hoist.

## Staff training

The provision of a new CP toilet in a building should be accompanied by training. This will ensure that relevant staff members are aware of the new facility and prepared for any responsibilities relating to its management.

- Disability awareness training should be supplemented with training on why people need CP toilets and how they are used.
- It can be beneficial to provide all staff with basic equipment training, such as safely returning the hoist motor to the charging station, and recognising the controls for the release and power cord, to help them answer basic queries.
- Customer-service staff should be aware of what type of equipment is provided. They should understand the importance of providing visitors with access information in advance and promoting the facility to potential users.
- Cleaning and caretaking staff should understand the importance of meticulous hygiene and why the position of items within the room is critical. For example, if an alarm pull cord is tied up, it will not be possible for a user to reach it from the floor in an emergency.
- Suitable cleaning products should be used to clean the equipment following the manufacturer's instructions.
- Building-maintenance staff should be familiar with the operation and maintenance of all items of equipment.

- Caretakers, building managers and maintenance staff should be trained in operating and maintaining equipment and troubleshooting common problems. This should include an understanding of the hoist system's basic functions, limitations and maintenance requirements.
- A contingency plan in the event of a power cut should be drafted.

## Security

The level of security required for a CP toilet will vary depending on where it is situated and how it is managed. In all cases, instructions explaining how to gain access should be displayed on signage outside the toilet and in any information about the facility, such as on the venue's website. Where open access is not provided, it is essential that arrangements are put in place to manage the situation should somebody urgently require access to the CP toilet. Clear signage explaining how to gain emergency access should be displayed outside the toilet. Ideally, CP toilets should be kept unlocked so that users have quick, easy and independent access to the facility. However, if there is a risk of a facility being mistreated by other people in the building, managers may have to consider options that provide better security. The benefits and drawbacks to different security arrangements are outlined below.

### Open access

Where a CP toilet is located in a staffed facility, it is preferable to keep it unlocked when not in use. Operating a well-managed open site means that the CP toilet is available when required and allows visitors to access it immediately without having to request access or register. It also prevents staff time being taken up by giving out keys,

unlocking the facility or registering users.

### Key schemes

Where a CP toilet is remotely managed, or is at risk of being misused and damaged, it should be kept locked when not in use. This may be the case in situations where access is directly from a public space.

### Uncontrolled access by key

Using a national key scheme, such as the widely recognised Royal Association for Disability Rights (Radar) National Key Scheme, provides people who have the national key access to the CP facility at any time. Where a CP toilet is provided in conjunction with or alongside a unisex accessible toilet, the key system should be the same for both toilets.

The disadvantage to this is that it relies on the disabled person or their assistant having a key. If they do not have one, they will not be able to access the facility.

If a CP toilet is only accessible using a key, this must be made clear in all online and printed information about the facility.

Further information about the National Key Scheme can be found on the [Radar website](#).

Please note that Radar is now part of Disability Rights UK, for contact details see Chapter 7, **Sources of further information**.

### Controlled access by venue-specific key

Restricting access by locking the facility with a key or code specific to a particular venue allows the venue greater control over who uses it. Visitors can request the key or code from a member of staff, usually someone at reception or a toilet attendant. Although this



provides greater security for the facility, it will increase the time it takes for users to access the toilet, and relies on a staff member being available at all times.

### **Membership schemes**

Organisations may wish to operate a membership scheme for regular users. Registering the assistant, rather than the disabled user of the toilet, allows a safeguard to be added by asking them to confirm that they know how to use the equipment. This type of scheme is not suitable for venues that are not regularly visited by the same people.

### **Membership card systems**

Assistants complete a registration form before using the facility for the first time. They are then provided with a membership card, which is shown to a member of staff who will either unlock the toilet or provide a key. It is preferable for visitors to have the option of registration on arrival, for example at an information point or with the toilet attendant. The CP website has an example Guidance for Use form which can be used as a template.

### **Member keys / fobs for individual use**

To allow regular users flexibility, membership schemes can provide assistants with their own keys or electronic access fobs. This means that members can access the CP toilet independently at any time. Electronic systems may allow the venue to record access. They will need to be linked to a control centre, such as a local Shopmobility centre.

**“We didn’t want to create any barriers to access. We took the lock off so the facility is open to visitors and is being used all the time.”**

**Tina Levett**, *Gateway Manager, Kent*



Tonbridge Gateway provides open access to their managed CP facilities

## Case study:

# Open access

## Kent Gateway services

The majority of CP toilets in Kent are installed within a Gateway, a centre offering public and voluntary services in an accessible town centre or high street location. Kent County Council has at least one CP toilet available in every Gateway location.

A CP Working Group, supported by the Gateway Programme Board, meets every six months to review implementation of proposals and to improve access to the facilities even further.

The group's activities include:

- promoting the facilities through leaflets, newsletters, access guides and local networks
- 'mystery shopping' visits to the toilets to check ongoing access, management and maintenance
- picking up on specific management and maintenance issues as they arise
- sharing knowledge of CP users and families.

The Tonbridge and Malling, Maidstone and Tunbridge Wells CP facilities were originally locked toilets. However, it was later decided to remove the locks, making the facility more accessible to all members of the community.

The open sites are well managed and frequently used by a range of people, including people with learning disabilities, older people, people living with stroke and families.

**“We manage use carefully and priority is always given to disabled people. We have had no queues and no problems with vandalism. The cleaners service the CP toilet regularly as part of the usual contract, and we didn't need to change our insurance cover.”**

**Tina Levett**, Gateway Manager



Information signs in the Tonbridge CP facility provide clear diagrams and instructions for using the equipment

## Case study:

# Membership card scheme

## Nottingham City Council

Nottingham City Council uses a one-off registration / membership process for its CP toilet, which is part of the main city centre public toilet facilities. The toilet complex is staffed by attendants who ask assistants if they have a membership card. If not, assistants are asked to complete a very simple *Guidance for Use form*, which highlights key information and 'dos and don'ts'. Once completed, assistants are provided with a membership card which they show on future visits.

The toilet is opened by the attendant at the request of membership-card holders, ensuring that the facility remains clean, safe and used by those who really need it.

Martin Jackaman is a CP Consortium member who, while working for Nottingham City Council, was involved in gaining approval for the CP toilet. He said:

**“People with profound disabilities and their carers can now visit the city, knowing that they have a haven with the right equipment which is safe, clean and easy to access.”**

Bethan Foden, a local parent, said:

**“Our daughter Lowri was very comfortable when we used the changing bench and the whole place was spotless.”**

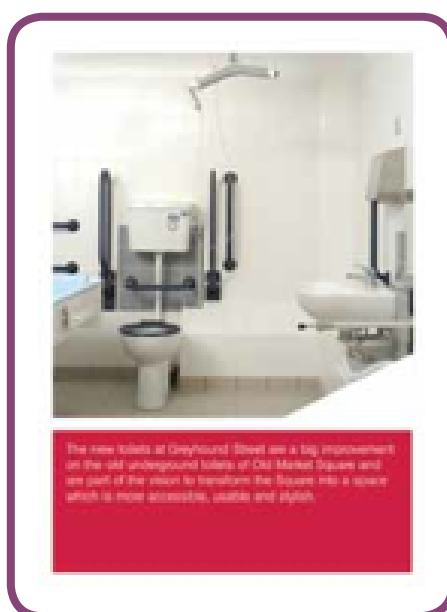
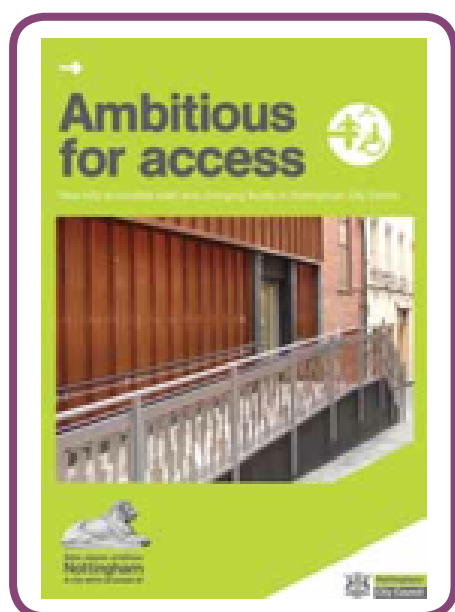

Nottingham City Council produced a leaflet to promote their public CP facility. They operate a simple membership scheme for access



## Case study:

# Membership scheme with personal fobs

## Middlesbrough Bus Station

The first CP facility to be built in Middlesbrough is located at the bus station. An unused room located here was an ideal choice for a new CP toilet, because it was sufficiently spacious, council owned, and situated in the town centre. The most challenging issue when planning the facility was management, particularly as there was no bus station manager at the time.

The cleaning, management and ongoing costs associated with the provision of the facility were eventually resolved by the council. However, the bus station continues to experience significant problems relating to antisocial behaviour. Therefore the CP steering group opted to run a membership scheme for the toilet, to ensure that it would be accessed only by the people who really need it.

Middlesbrough Shopmobility offered to operate the membership scheme, while the CP steering group devised a welcome pack for new members. This contains membership information, an application form, frequently asked questions, a disclaimer and information about the operation and safe working load of the equipment. On completion of the application form, all members are provided with a fob which allows them to access the facility. Details of the membership scheme are clearly displayed outside the facility.

The vandal-resistant fob system was installed following consultation with the council's Security Officer. All fobs are numbered and, once issued to members, members' contact details are kept securely at Middlesbrough Shopmobility. The fob system provides data which can be reviewed to show frequency of use. Fobs can also be instantly deactivated if they are lost, or if anybody is found to be abusing the facility.

The fobs are brightly coloured, with contrasting stickers displaying their numbers. To ensure easy access for all users, they are held in front of the reader rather than needing to be swiped.



The fob reader [left] and fob [right] at Middlesbrough Bus Station's CP facility are designed to manage access while remaining user friendly

# Information management

Any information about the venue, such as its website, should make specific reference to the CP facility. It is also very important to advertise CP facilities to potential users at the venue itself, and staff should be trained so that they can direct visitors to the facility.

If people are not aware that the facility exists, it will be underused and therefore will not benefit the people who need it.

Clear, accurate, up-to-date and easily accessible information about the facility should be provided through a variety of media so that journeys and visits can be planned. Knowing what facilities are available, their location, opening times, whether a key is required and the type of equipment provided will reassure people that their proposed journey is viable.

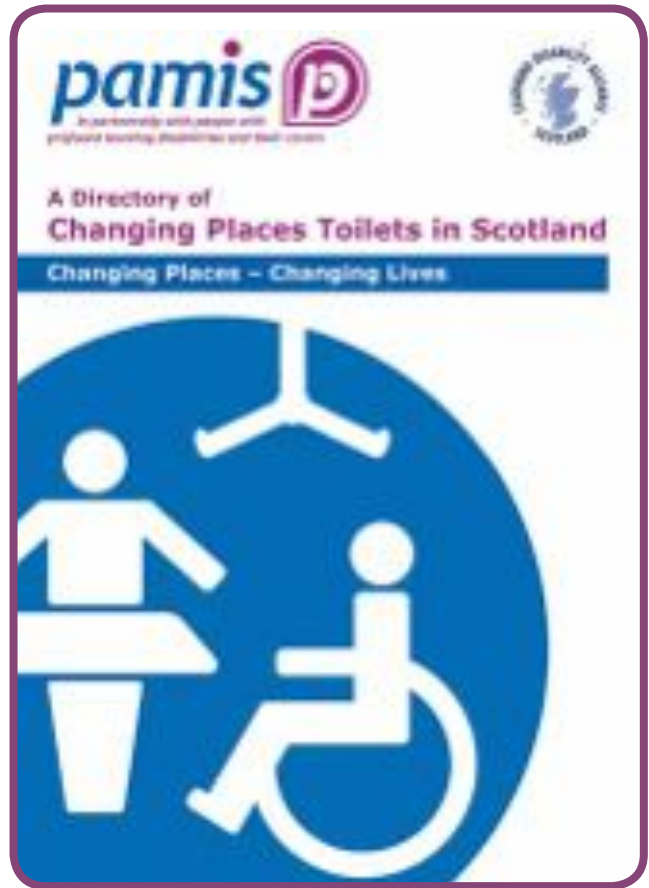

PAMIS with Learning Disability Alliance Scotland have produced *A Directory of Changing Places Toilets in Scotland*

# Spreading the message



The Changing Places website provides details on all registered CP toilets and includes photographs, equipment and access information shared by service providers



Middlesbrough Council provide photographs and details on all of their CP toilets on their website



Sheffield have produced a leaflet with details on local CP facilities and a helpful reminder to visitors to bring their own slings

The following information should be readily accessible and up-to-date:

- location
- opening hours
- access and security arrangements
- equipment and hoist sling compatibility (see *Hoist slings* in Chapter 4, **Equipment**).

This information should be provided through a variety of media including:

- visitor information leaflets
- websites
- signage
- telephone and textphone enquiries
- staff reception desks
- alternative formats.

Operating instructions for the hoist, height-adjustable changing bench and height-adjustable washbasin should be displayed inside the CP toilet.



Kent County Council have created a map of Changing Places facilities available across the county

It is a good idea to provide a brief explanation of what a CP toilet is outside the facility itself. This should reduce misuse of the facility, and will also promote its availability to potential users who are unaware of the CP scheme.



For suggested wording for such a sign, see *Signage and wayfinding* in Chapter 3, **Planning and design**.

Signage should be also provided to direct people to alternative toilet facilities such as:

- unisex accessible toilets
- single-sex sanitary facilities
- baby changing facilities.

This will help to ensure that CP toilets are not used by people who are able to access other facilities. See *Signage and wayfinding* in Chapter 3, **Planning and design**.

The use of the CP facility should be monitored. Customer feedback should be encouraged and a dialogue with users should be established. This will help organisations meet the needs of users. It should also highlight potential problems at an early stage, enabling a prompt response and appropriate rectification work if necessary.



Clear signage will help direct visitors to the CP facility

## Equipment testing and maintenance

Certain regulations govern the frequency and type of regular maintenance. Hoists need to be serviced and maintained in accordance with the Lifting Operations and Lifting Equipment Regulations 1998. For more information, see *Health and safety legislation* in Chapter 2, **Legislative background**). It is the responsibility of the building management to ensure this takes place.

- A programme of regular inspections, maintenance and servicing of all moveable and motorised equipment should be implemented.
- Accurate records of all equipment tests, inspections and servicing should be kept.

## Day-to-day management

Many tasks need to be undertaken daily. In situations where a CP toilet is used repeatedly throughout the day, such as in a healthcare facility, more frequent checks and cleaning will be required. Management and maintenance staff should ensure the CP toilet is cleaned and restocked, and that batteries are fully charged, on a daily basis, or more often if required.

- **Routes** – Staff should ensure that all routes, including entrances, lobbies, corridors, steps and ramps, are clean, free of obstructions and well lit. External routes should be kept clear of fallen leaves, snow and ice.



- **Signage** – Directional signage should be clearly visible at all times and not obscured by temporary notices, posters, furniture or other items. Signage should be kept clean.
- **Door and ironmongery** – The toilet door should be maintained so that it does not become stiff or heavy to operate. Door handles and locks should be checked to ensure they are fully operable.
- **Equipment** – All items of equipment should be inspected regularly to ensure they remain in good condition, are positioned correctly and are ready for use. In CP toilets with mobile changing benches, the bench should be returned to its designated position. Freestanding waste bins should be returned to their designated locations so they do not obstruct access and are ready for the next user. The overhead hoist motor should be returned to its charging unit.
- **Batteries** – Equipment powered by batteries should be fully recharged overnight. Equipment should also be returned to its charging position between users during the day.
- **Supplies** – Items such as toilet paper, soap, hand towels and paper roll should be checked and restocked daily. If the facility is in continuous use during the day, more frequent checks should be made to ensure there are sufficient supplies for every user.
- **Cleanliness** – Thorough daily cleaning of all surfaces and equipment is essential. Spot-checks throughout the day are also advised, particularly if the facility is in continuous use. Regular flushing of water outlets is recommended to reduce the risk of legionella.
- **Assistance alarm** – Pull cords and reset buttons should be tested regularly to ensure they are easy to operate and fully functional. Checks should also be made to ensure that audible and visual alarms, including those positioned immediately outside the room and those positioned remotely (such as at a reception or service desk), are fully functional and tested for response.
- **Fire alarm** – Whenever the building's fire alarm is tested, a check should be made to ensure that the visual alarm within the CP toilet is activated and that the sound level of the audible alarm is adequate.
- **Heating** – The room temperature should be checked regularly and monitored to ensure the required temperature is maintained. Zone and control settings should be carefully checked to ensure that heating in the CP toilet is maintained at times when heating is switched off elsewhere in the building.
- **Lighting** – Lights should be checked regularly within the CP toilet and along access routes. Any non-functioning light bulbs should be replaced immediately. In situations in which light switching is centrally controlled, lights along access routes and in the CP toilet should be activated at any time whenever the facility is available for use.

For more information visit:

[www.changing-places.org.uk](http://www.changing-places.org.uk)



# Management checklist

Staff trained and aware of facilities	<input type="checkbox"/>
Emergency egress, alarm and power cut response policies	<input type="checkbox"/>
Pre-visit information on website and leaflets	<input type="checkbox"/>
Access routes clean and free of obstructions	<input type="checkbox"/>
Signage on routes and facility clearly visible	<input type="checkbox"/>
Door handles and locks fully operable	<input type="checkbox"/>
Changing bench in correct position	<input type="checkbox"/>
Waste bin checked (not obstructing equipment or transfer space)	<input type="checkbox"/>
Hoist motor and changing bench returned to charging position / batteries charged	<input type="checkbox"/>
<b>Supplies fully stocked:</b>	
Toilet paper	<input type="checkbox"/>
Soap	<input type="checkbox"/>
Hand towels	<input type="checkbox"/>
Paper roll	<input type="checkbox"/>
Sanitary dispenser	<input type="checkbox"/>
All surfaces and equipment thoroughly cleaned using appropriate cleaning products and regularly checked	<input type="checkbox"/>
Water outlets including showers and sinks, are flushed regularly in line with risk assessment	<input type="checkbox"/>
Alarm at full length, not tied up or on top of other equipment	<input type="checkbox"/>
Alarms tested to ensure audiovisual signals work and receive a response	<input type="checkbox"/>
Regular equipment tests, inspections and servicing, records kept	<input type="checkbox"/>
All lights working, temperature correct	<input type="checkbox"/>

# 7 Sources of further information

## Organisations

### Changing Places Consortium

For enquiries in England, Wales and Northern Ireland:

Telephone: 020 7696 6019

Email: [ChangingPlaces@mencap.org.uk](mailto:ChangingPlaces@mencap.org.uk)

Website: [www.changingplaces.org](http://www.changingplaces.org)

For enquiries in Scotland:

### PAMIS

Telephone: 01382 385 154

Email:

[PamisChangingPlaces@dundee.ac.uk](mailto:PamisChangingPlaces@dundee.ac.uk)

Website: [www.pamis.org.uk](http://www.pamis.org.uk)

### Mencap (England)

Website: [www.mencap.org.uk](http://www.mencap.org.uk)

Telephone: 020 7454 0454

Email: [help@mencap.org.uk](mailto:help@mencap.org.uk)

### Mencap (Northern Ireland)

Telephone: 02890 691351

Email: [helpline.ni@mencap.org.uk](mailto:helpline.ni@mencap.org.uk)

### Mencap (Cymru)

Telephone: 02920 747588

Email: [helpline.wales@mencap.org.uk](mailto:helpline.wales@mencap.org.uk)

### Centre for Accessible Environments

Website: [www.cae.org.uk](http://www.cae.org.uk)

Telephone: 020 7822 8232

### Action on Hearing Loss

Website: [www.actiononhearingloss.org.uk](http://www.actiononhearingloss.org.uk)

Telephone: 0808 808 0123

### Disability Rights UK

Website: [www.disabilityrightsuk.org](http://www.disabilityrightsuk.org)

Telephone: 020 7250 3222

### Disabled Living Foundation

Website: [www.dlf.org.uk](http://www.dlf.org.uk)

Telephone: 0300 999 0004

### Equality and Human Rights Commission

Website: [www.equalityhumanrights.com](http://www.equalityhumanrights.com)

### Equality Commission for Northern Ireland

Telephone: 028 90 500 600

Textphone: 028 90 500 589

Email: [information@equalityni.org](mailto:information@equalityni.org)

Website: [www.equalityni.org](http://www.equalityni.org)

### Equality Advisory Support Service

Website: [www.equalityadvisoryservice.com](http://www.equalityadvisoryservice.com)

Telephone: 0800 444 205

Textphone: 0800 444 206

### Business Disability Forum (formerly Employers' Forum on Disability)

Telephone: 020 7403 3020

Textphone: 020 7403 0040

Email:

[enquiries@businessdisabilityforum.org.uk](mailto:enquiries@businessdisabilityforum.org.uk)

Website: [www.businessdisabilityforum.org.uk](http://www.businessdisabilityforum.org.uk)

### Government Equalities Office

Website: [www.equalities.gov.uk](http://www.equalities.gov.uk)

### Health and Safety Executive

Website: [www.hse.gov.uk](http://www.hse.gov.uk)

Telephone: 0300 003 1747



## **HM Revenue & Customs**

Telephone: 0845 010 9000

Textphone: 0845 000 0200

Website: [www.hmrc.gov.uk](http://www.hmrc.gov.uk)

## **National Council for Voluntary Organisations**

Website: [www.ncvo-vol.org.uk](http://www.ncvo-vol.org.uk)

Telephone: 020 7713 6161

## **National Register of Access Consultants**

Website: [www.nrac.org.uk](http://www.nrac.org.uk)

Telephone: 020 7822 8282

## **RADAR (now Disability Rights UK) National Key Scheme**

Website: [www.radar.org.uk](http://www.radar.org.uk) or

[www.disabilityrightsuk.org](http://www.disabilityrightsuk.org)

Telephone: 020 7250 3222

## **RNIB**

Website: [www.rnib.org.uk](http://www.rnib.org.uk)

Telephone: 0303 123 9999

# Standards

## **Building standards**

### **England**

Building Regulations 2010

**Approved Document M: Access to and use of buildings** (2004 edition incorporating 2010 and 2013 amendments)

Department for Communities and Local Government

### **Wales**

Building Regulations 2010

**Approved Document M: Access to and use of buildings** (AD M) 2004 edition incorporating 2010 amendments) until updated by Welsh Government

### **Scotland**

Building (Scotland) Regulations 2013

**Technical Handbook 2013: Non-Domestic**  
Scottish Building Standards

### **Northern Ireland**

The Building Regulations (Northern Ireland) 2012

**Technical booklet R: Access to and use of buildings 2012**

Department of Finance and Personnel (Northern Ireland).

### **Jersey**

The Building Bye-laws (Jersey) 2007

**Approved Technical Guidance**

**Document Part 8: Access to and use of buildings**, 2007 edition incorporating 2012 amendments  
States of Jersey

### **British Standards**

**BS 8300:2009+A1:2010** Design of buildings and their approaches to meet the needs of disabled people – Code of practice.  
The British Standards Institution

**BS 5827:1979** Specification for mobile, manually operated patient-lifting devices.  
The British Standards Institution

**BS EN ISO 10535:2006** Hoists for the transfer of disabled persons. Requirements and test methods.  
The British Standards Institution

# Legislation

Available from [www.legislation.gov.uk](http://www.legislation.gov.uk)

Equality Act 2010 (England, Scotland and Wales)

The Disability Discrimination Act 1995, also the Disability Discrimination Act 1995 (Amendment) Regulations (Northern Ireland) 2004

Lifting Operations and Lifting Equipment Regulations 1998

The Manual Handling Operations Regulations 1992

United Nations Convention on the Rights of Persons with Disabilities (UK ratified 2009)  
Available from the United Nations Enable website: [www.un.org/disabilities/index.asp](http://www.un.org/disabilities/index.asp)

## Other publications

**Access Audit Handbook**, CAE / RIBA Publishing, 2013

**Accessible Sports Facilities**, Sport England 2010

**Accessible train station design for disabled people: A code of practice**, Department for Transport and Transport Scotland, 2011

**Building Bulletin 102: Designing for disabled children and children with special educational needs: Guidance for mainstream and special schools**, Department for Children, Schools and Families. The Stationery Office, 2008

**Changing Places Toilets: Estimates of potential users**, report by Professor James Hogg, White Top Research Unit, University of Dundee, 2009

**Designing for Accessibility**, CAE / RIBA Publishing, 2012

**Health Building Note 00-02: Sanitary spaces**, Department for Health, 2013

**Sign Design Guide**, JMU Access Partnership and the Sign Design Society, 2000

**Legal framework concerning provision of Changing Places public toilets**, Changing Places Consortium factsheet available online from [www.changingplaces.org](http://www.changingplaces.org)

## HMRC Notices:

HMRC Notice 701/1 Charities

HMRC Notice 701/6 Charity funded equipment for medical, veterinary etc uses

HMRC Notice 701/7 VAT reliefs for disabled people

HMRC Notice 708 Buildings and Construction



# Index

- Alarm systems, 55, 62, 69, 85
- Assistance, 28
- Automatic WCs / Wash-and-dry toilets, 52
  
- Bins, 62, 69
- Building Regulations, 23, 88
  
- Ceiling track hoist, 55, 68
- Checklists:
  - Risk recommendations, 29
  - Planning and design, 48
  - Equipment and environment, 66
  - Management and maintenance, 86
- Consultation, 30
- Changing bench, 57, 68
- Coat hooks, 63
- Colostomy shelf, 52
- Colour contrast, see visual contrast
- Costs, 71
- Cleaning, see maintenance
- Curtain, see privacy screen
  
- Design, see layouts
- Doors, 49
  - Automatic door, 49, 51
  - Alternative doors, 50
  - Handles, 35, 49
  - Locks, 51, 77, 81
  - Grabrails, 35, 49
  - Contrast, 50
- Drop-down support rails, 35, 52
  
- Equality legislation, 20
- Equipment and environment checklist, 66
- Environment, 63, 66
- Fire alarms and egress, 62, 85, 86
- Funding, 71-74
- Flooring, Floor drains, 59, 64
  
- Grabrails, 35, 45, 52, 67
  
- Handrails, see grabrails
- Hand drying, 55, 67
- Health and safety, 27
- Heating, 63
- Heights of fittings, 35, 61
- Height-adjustable washbasin, 35, 53
- Hoist, 55, 68
- Hoist slings, 56
  
- Information provision, 43, 82
  
- Layouts, 31
  - BS 8300 layout, 32
  - Alternative corner door positions, 33
  - Central door layout, 34
  - Heights for fittings, 35
  - Heights for shower area, 36
  - Heights for shower area with seat, 61
  
- Legislation, 20
- Lighting, 65
- Locks, 51, 77, 81
  
- Manual handling, 28,
- Management and maintenance checklist, 86
- Membership schemes, 78
- Mirror, 62
- Mobile Changing Places toilets, 42
  
- National Key Scheme, 77
  
- Paper-towel dispenser, 55
- Paper (wide) roll dispenser, 59
- Peninsular toilet, 51
- Planning and design checklist, 48
- Portable / Mobile Changing Places toilets, 42
- Paper towels, 55
- Privacy curtain or screen, 57
- Professional advice, 30



Radar Key (National Key System) 77

Risk assessment, 29, 76

Routes, 42, 84

Sanitary towel dispensers, 63

Security, 77

Shower, 36, 59, 61, 69

Shower seat, 61, 69

Signage, 43

Sink, see washbasin

Slings, see hoist slings

Soap dispenser, 55

Staff training, 75, 76

Standards, 23, 88

Statutory consents, 31

Taps, 54

Toilet, 51

Training, see staff training

VAT relief, 71

Ventilation, 64

Visual contrast, 65

Washbasin, 35, 53

Waste bins, 62, 69

Water supply, 64

Wayfinding, 43

WC, 51, 66

Website, 82

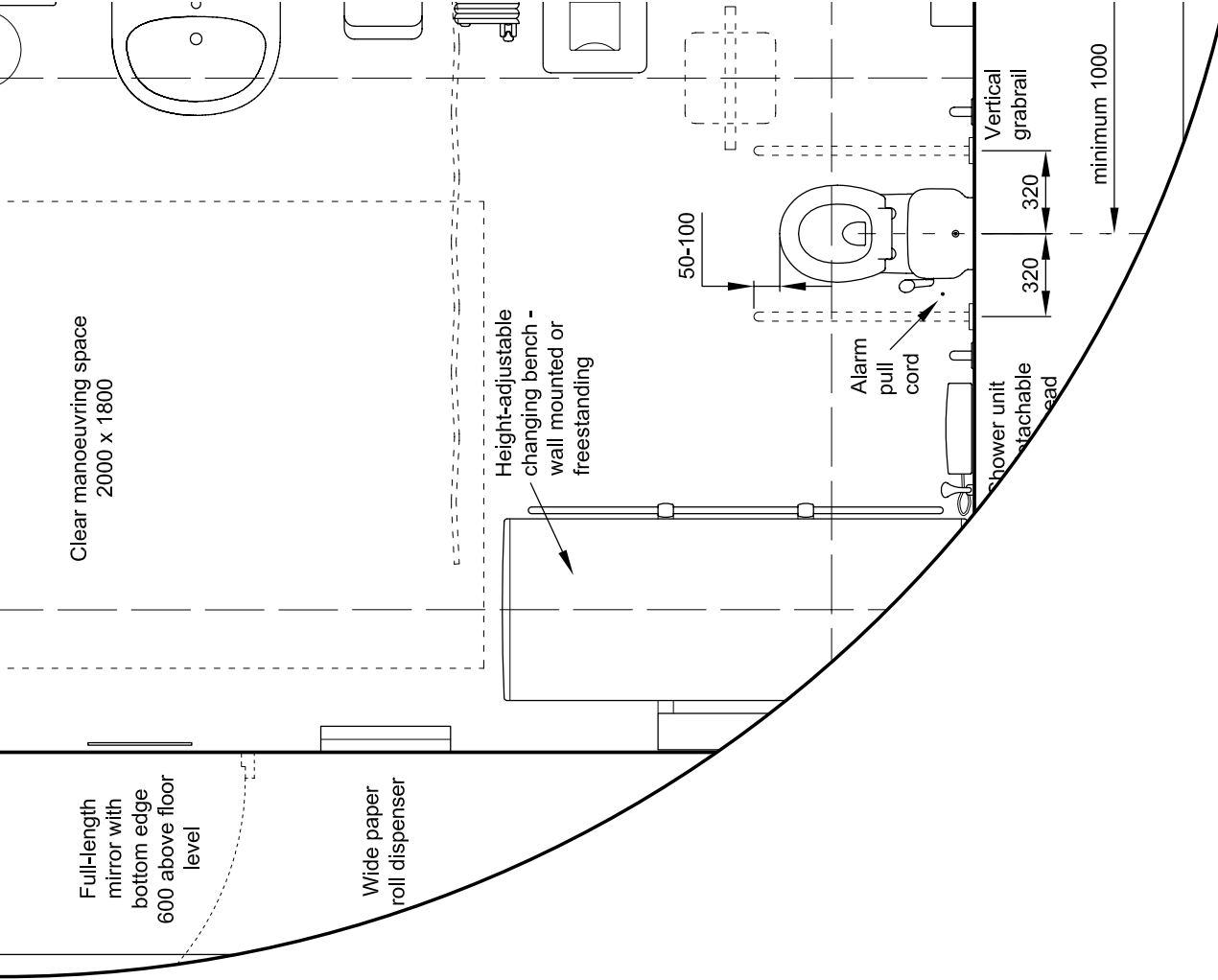

## Changing Places: the practical guide

Many disabled people cannot use standard toilet facilities – often requiring personal assistance, extra space and particular equipment, including a changing bench and hoist.

Changing Places offer a solution. These larger facilities are designed to support disabled people who need assistance. This guide offers information and guidance to anyone wishing to install a Changing Places facility.

