



# Collective chimney Practicshunt triple wall airtight line



## Adjustable wall support

	Ø150	Ø175	Ø200	Ø250	Ø300
C	300	350	400	450	500
D	255	284	313	342	380
E	388	442	496	550	604
F	396	446	496	546	596
L	387	416	445	474	512

All measurements are expressed in mm.



## Wind strap

	Ø150	Ø175	Ø200	Ø250	Ø300
C	300	350	400	450	500

All measurements are expressed in mm.



## Support bracket

	Ø150	Ø175	Ø200	Ø250	Ø300
C	300	350	400	450	500
D	260	260	260	260	260
E	40	40	40	40	40

All measurements are expressed in mm.



## Upper ventilation section

	Ø150	Ø175	Ø200	Ø250	Ø300
A					
B	200	225	250	300	350
C	300	350	400	450	500
L			980		

All measurements are expressed in mm.



## Tee plug with draft protection

	Ø150	Ø175	Ø200	Ø250	Ø300
C	300	350	400	450	500
L			125		

All measurements are expressed in mm.



## Double lip joint

	Ø150	Ø175	Ø200	Ø250	Ø300
A					

All measurements are expressed in mm.





# Collective chimney Practicshunt double wall airtight line

## Uses

- Extraction of combustion products for closed circuit gas systems.



## Regulations

CE0099 / CPD / A71/ 0065	EN 1856 -1	T160	P2	W	Vm	L20040	O(100)
CE0099 / CPD / A71/ 0065	EN 1856 -1	T160	P2	W	Vm	L50040	O(100)

- Regulation number.
- Temperature level.
- Pressure level (N or P or H).
- Resistance to condensation (W wet; D dry).
- Resistance to corrosion.
- Liner material.
- Resistance to soot fires (G Yes; O No)
- Distance from combustible materials (mm).

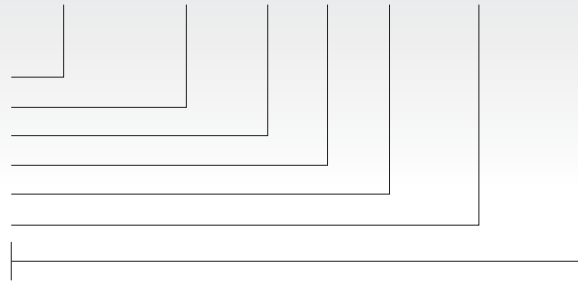

## General characteristics

- Easy assembly with 3 sections per floor.
- Quick assembly through male-female interlock system.
- Airtightness of tubing.
- High mechanical resistance to vertical and horizontal stress.
- A1 classified materials.
- Available in diameters of 100-350 mm.

## Materials

Location	Description
• Liner	Stainless steel AISI 304. UNE 1.4301. Stainless steel AISI 316L. UNE 1.4404.
• Outer wall	Acero inox. AISI 304. UNE 1.4301. For outdoor installation. Aluminized steel. For indoor installation.
• Cladding	Shiny Stainless Matt Aluminium. Ask about available colours.

## Inner and outer diameters and thickness

	Ø100	Ø125	Ø150	Ø175	Ø200	Ø250	Ø300	Ø350
• Ø inner (mm)	100	121	146	171	196	245	295	345
• Ø outer (mm)	150	200	260	300	350	400	475	550
• Thickness of steel (mm)	0.4	0.4	0.4	0.4	0.4	0.4	0.4	0.5

## Fuels

- Natural gas
- Propane
- Butane
- Gasoil

Recommended AISI 316L for:

- Oil
- Wood
- Coal
- Pellets

## Maximum temperature for use

- 160°C continuous

## Maximum surge pressure

- 200 Pa

# Collective chimney

## Practicshunt double wall airtight line

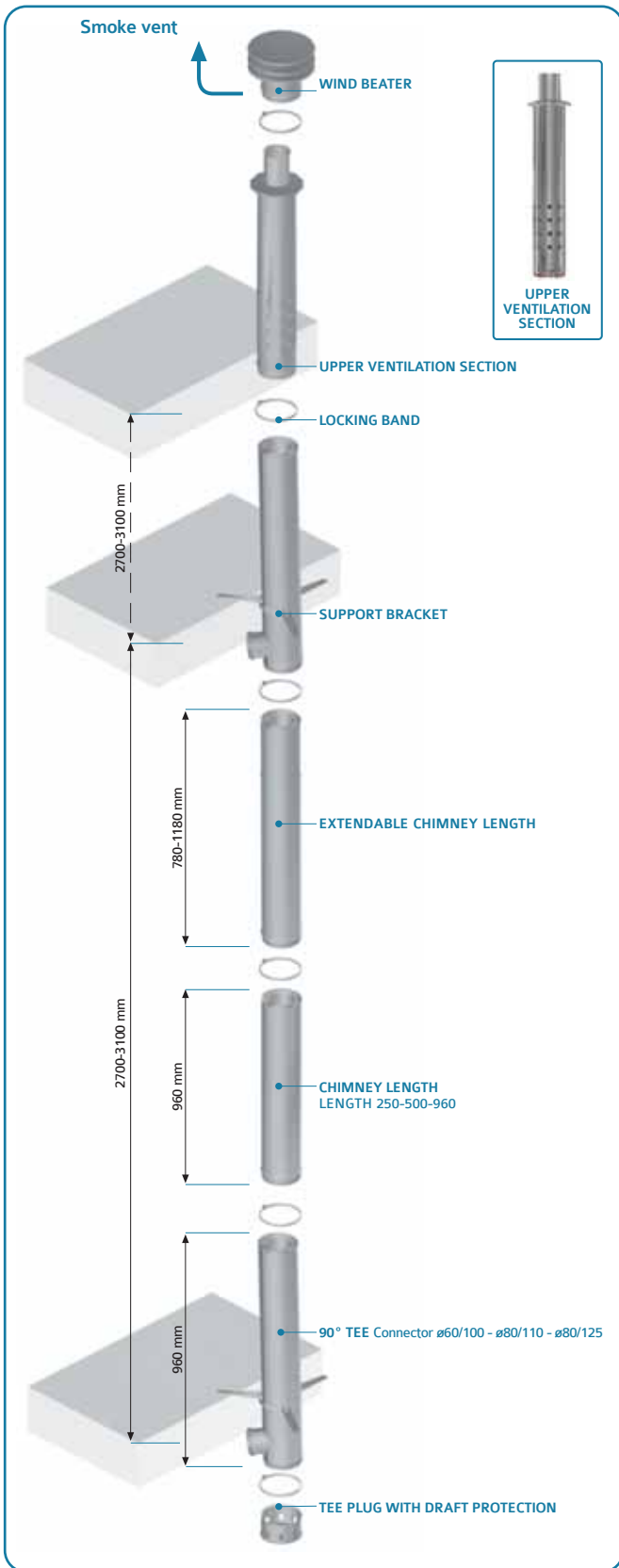

### Instructions for assembly

- A maximum of 10 connections may be installed.
- A tee plug with drain and draft protection must be installed at the lower end of the assembly.
- The chimney must be capped with a wind beater.
- A wind strap must be installed when the chimney extends 1.5 Metres beyond the anchor plate if wall anchor is not possible.
- The chimney cap must be free and clear of obstacles.
- All installations must bear the proper identification label, where the installer must detail product specifications, in accordance with regulation en 12391.
- We recommend using silicone caulking to seal the joints between sections with a diameter greater than 200 mm.

#### Indoor installations:

- A support bracket must be used for each section in indoor installation.

#### Outdoor installations:

- The installation must be anchored to the wall at 3 metre intervals using a wall strap.
- A wall support must be installed every 10 metres to provide extra support.

### Details

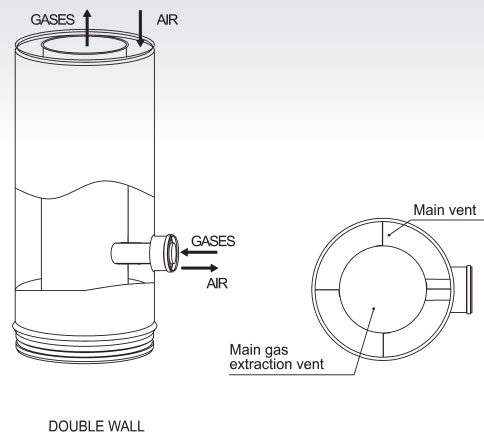

### Chimney dimensions

		Calculation of wall diameters (mm)			
		24 Kw		30 Kw	
N° of floor	Caldera	No Condensation	Condensation	No Condensation	Condensation
	2	150/260	125/200	150/260	150/260
3	175/300	150/260	175/300	175/300	175/300
4	175/300	175/300	200/350	175/300	175/300
5	200/350	175/300	250/400	200/350	200/350
6	250/400	200/350	250/400	250/400	250/400
7	250/400	250/400	250/400	250/400	250/400
8	250/400	250/400	300/475	250/400	250/400
9	300/475	250/400	300/475	300/475	300/475
10	300/475	250/400	350/550	300/475	300/475

- Conditions for calculating:  
400 m > h > 200 m  
3m. distance between floors

Natural gas boiler  
Distance to top - 3m.

## Assembly Regulations. Minimum distances for proper chimney function.

### With regard to the roof

#### Case A: Flat roof ( $< 20^\circ$ )

- 1 metre above the ridgepiece.

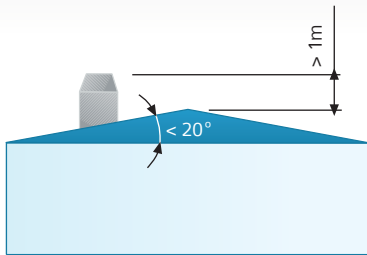

#### Case B: Inclined roof ( $\geq 20^\circ$ ) At least one of the following two conditions must be fulfilled:

- 1 metre above the ridgepiece.
- Minimum horizontal clearance of 2.5 metres between the edge of the chimney and the roof.

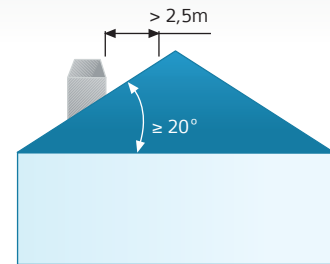
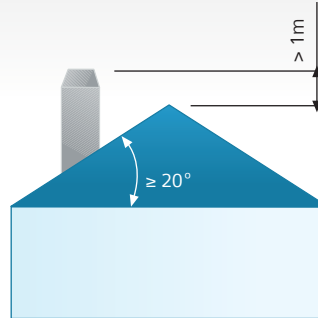

### With regard to obstacles on the roof

At least one of the following two conditions must be fulfilled:

- 1 metre above the obstacle.
- A horizontal clearance greater than two times the height of the obstacle.

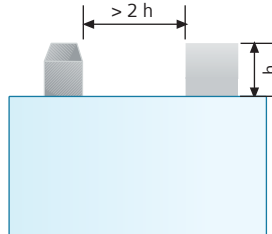
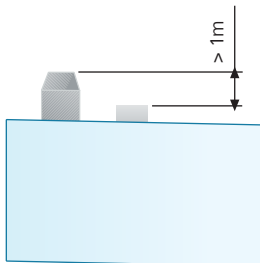

### With regard to external obstacles

- If the horizontal distance between the chimney and the adjacent building is less than 10 metres, the chimney must extend more than 1 metre beyond the highest point of the building.
- If the horizontal distance is greater than or equal to 10 metres, the chimney must extend beyond the height of the building.

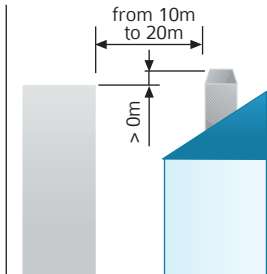
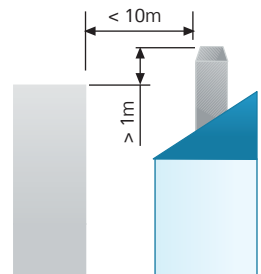

## Minimum distances according to environmental criteria

### With regard to openings in the roof

The following conditions must be fulfilled:

- 1 metre beyond the highest point of any window or opening.
- 2 metres above the surface of the roof and any opening situated behind the chimney.
- 1 metre above the surface of the roof and any window or opening situated in front of or to either side of the chimney.

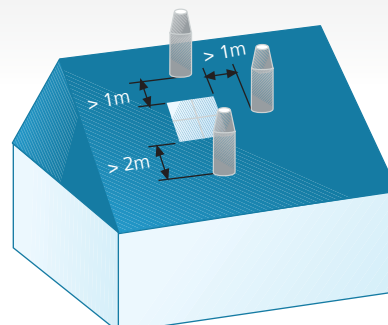
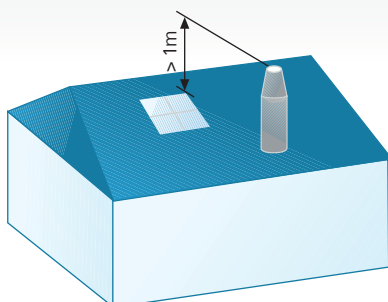

# Collective chimney

## Practicshunt double wall airtight line



### Chimney length

A	Ø100	Ø125	Ø150	Ø175	Ø200	Ø250	Ø300	Ø350
B	150	200	260	300	350	400	475	550
L	250 / 500 / 960							

All measurements are expressed in mm.



### Extendable chimney length

A	Ø100	Ø125	Ø150	Ø175	Ø200	Ø250	Ø300	Ø350
B	150	200	260	300	350	400	475	550
L min-max	780 - 1180							

All measurements are expressed in mm.

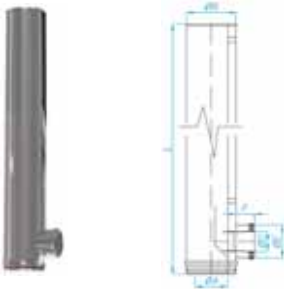

### Tee Connector 60 - 100 (ØD - ØE)

A	Ø100	Ø125	Ø150	Ø175	Ø200	Ø250	Ø300	Ø350
B	150	200	260	300	350	400	475	550
F	56							
L	960							

All measurements are expressed in mm.

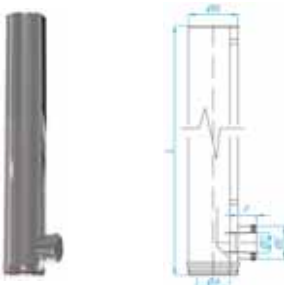

### Tee Connector 80 - 110 (ØD - ØE)

A	Ø100	Ø125	Ø150	Ø175	Ø200	Ø250	Ø300	Ø350
B	150	200	260	300	350	400	475	550
F	56							
L	960							

All measurements are expressed in mm.

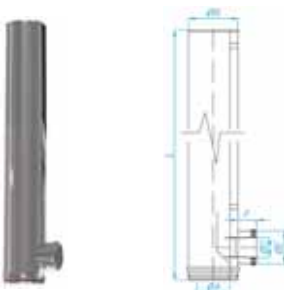

### Tee Connector 80 - 125 (ØD - ØE)

A	Ø100	Ø125	Ø150	Ø175	Ø200	Ø250	Ø300	Ø350
B	150	200	260	300	350	400	475	550
F	56							
L	960							

All measurements are expressed in mm.



### 45° Elbow

A	Ø100	Ø125	Ø150	Ø175	Ø200	Ø250	Ø300	Ø350
B	150	200	260	300	350	400	475	550
D	198	246	318	353	396	434	506	591
L	220	268	322	337	370	366	435	493

All measurements are expressed in mm.



# Collective chimney Practicshunt double wall airtight line



## Wind beater

A	Ø100	Ø125	Ø150	Ø175	Ø200	Ø250	Ø300	Ø350
B	210	210	250	360	360	500	500	570
L	205	210	215	265	265	310	310	325

All measurements are expressed in mm.



## Upper ventilation section

A	Ø100	Ø125	Ø150	Ø175	Ø200	Ø250	Ø300	Ø350
B	150	200	260	300	350	400	475	550
L	960							

All measurements are expressed in mm.



## Tee plug with draft protection

A	Ø100	Ø125	Ø150	Ø175	Ø200	Ø250	Ø300	Ø350
B	150	200	260	300	350	400	475	550
L	80							

All measurements are expressed in mm.

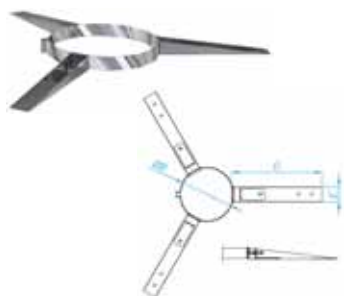

## Support bracket

	Ø100	Ø125	Ø150	Ø175	Ø200	Ø250	Ø300	Ø350
B	150	200	260	300	350	400	475	550
D	260							
E	40							

All measurements are expressed in mm.

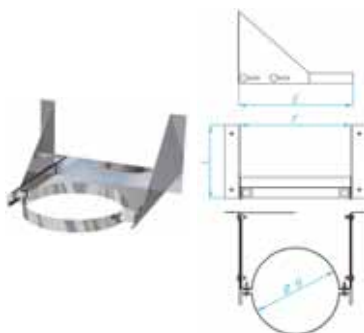

## Adjustable wall support

	Ø100	Ø125	Ø150	Ø175	Ø200	Ø250	Ø300	Ø350
B	150	200	60	300	350	400	475	550
E	280		388		442	496	604	
F	278		396		446	496	596	
L	210		387		416	445	512	

All measurements are expressed in mm.



## Wind strap

	Ø100	Ø125	Ø150	Ø175	Ø200	Ø250	Ø300	Ø350
B	150	200	260	300	350	400	475	550
E	15							

All measurements are expressed in mm.







## Secondary flue systems Airtight line

### Uses

- Extraction of gases from watertight boilers.
- Air intake from watertight boilers.



### Regulations

CE 0099 / CPD / A71 / 0062

EN 1856-2 T200 P1 W Vm L13100 O(50,50)

- Regulation number.
- Temperature level.
- Pressure level (N or P or H).
- Resistance to condensation (W wet; D dry).
- Resistance to corrosion.
- Liner material.
- Resistance to soot fires (G Yes; O No)
- Distance from combustible materials - wall (mm).
- Distance from combustible materials - ceiling (mm).

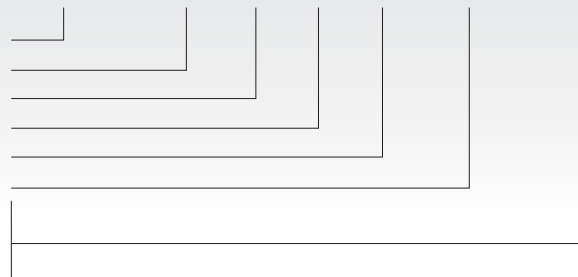

### General characteristics

- Sistema de unión entre elemento mediante junta bilabial de silicona.
- Posibilidad de corte del tubo con sierra.
- Recubrimiento resistente a golpes; sin desconchamiento.
- Disponibilidad de diámetros de  $\varnothing 60$  mm.,  $\varnothing 80$  mm.

### Materials

Location	Description
• Wall	Aluminium.
• Finish	White epoxy cladding.

### Diameters and thickness

	$\varnothing 60$	$\varnothing 80$
• Thickness of aluminium (mm)	1	1

### Fuels

- Natural gas
- Propane
- Butane
- Gasoil

### Maximum temperature for use

- 200°C en continuous

### Maximum surge pressure

- 200 Pa

# Secondary flue systems

## Airtight line

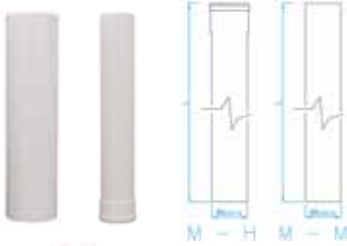

### Connection length

	MOUTH	Ø60	Ø80
L	M - M	-	195 / 485 / 965 / 1500 / 2000
L	M - H	500 / 973	195 / 485 / 965

All measurements are expressed in mm.



### Intake terminal

	MOUTH	Ø60	Ø80
L	M	-	893

All measurements are expressed in mm.



### Extraction terminal

	MOUTH	Ø60	Ø80
L	M	-	893

All measurements are expressed in mm.



### 45° Connection elbow

	MOUTH	Ø60	Ø80
D-L	M - H	45-140	35-150
D-L	H - H	-	35-150

All measurements are expressed in mm.



### 90° Connection elbow

	MOUTH	Ø60	Ø80
D-L	M - H	35-145	55-140
D-L	H - H	-	55-140

All measurements are expressed in mm.



### Joint sleeve

		Ø60	Ø80
L	H - H	62	135

All measurements are expressed in mm.



### Wall strap

		Ø60	Ø80
C		45	55

All measurements are expressed in mm.



# Secondary flue systems

## Airtight line

### Adaptors

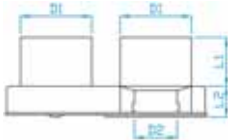

	BOILER	MOUTH	Ø60	Ø80
D1-D2-L1-L2	R	M - M	-	80-61-50-40

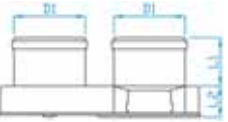

D1-L1-L2	R	H - H	-	81-50-40
----------	---	-------	---	----------

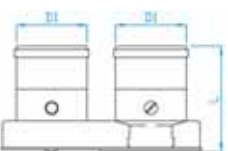

D1-L	R	H - H	-	81-122
------	---	-------	---	--------

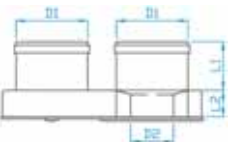

D1-D2-L1-L2	V	H - H	-	81-60-50-40
-------------	---	-------	---	-------------



D1-D2-L	SV	H - H	-	81-128-122
---------	----	-------	---	------------

All measurements are expressed in mm.

# Secondary flue systems

## Airtight line



### Adaptors



	BOILER	MOUTH	Ø60	Ø80
D1-D2	SD	H - H	-	81-138



D1-D2-L1-L2	MTS	H - H	-	81-60-61-28
-------------	-----	-------	---	-------------



D1-L1-L2	BX	H - H	-	81-50-140
----------	----	-------	---	-----------



D1	IG	H - H	-	81
----	----	-------	---	----



D1-L1	J	H - H	-	81-110
-------	---	-------	---	--------

All measurements are expressed in mm.



# Secondary flue systems

## Airtight line

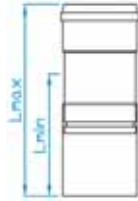

### Extendable adaptors

	BOILER	MOUTH	Ø60	Ø80
L		H	-	150-215
min-max				

All measurements are expressed in mm.

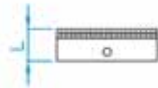

### Intake grate

	Ø60	Ø80
L	-	10

All measurements are expressed in mm.

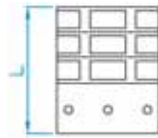

### Extraction cap

	Ø60	Ø80
L	70	70

All measurements are expressed in mm.

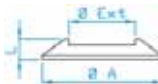

### Finishing collar

	Ø60	Ø80
A	105	135
L	10	15

All measurements are expressed in mm.

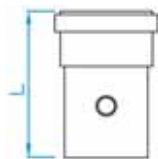

### Vertical test / Inspection section

	Ø60	Ø80
L	-	135

All measurements are expressed in mm.





## Secondary flue systems Coaxial airtight line

### Uses

- Extraction of gases from watertight boilers.
- Air intake from watertight boilers.



### Regulations

CE 0099 / CPD / A71 / 0062

EN 1856-2 T200 P1 W Vm L13100 O(50,50)

- Regulation number.
- Temperature level.
- Pressure level (N or P or H).
- Resistance to condensation (W wet; D dry).
- Resistance to corrosion.
- Liner material.
- Resistance to soot fires (G Yes; O No)
- Distance from combustible materials - wall (mm).
- Distance from combustible materials - ceiling (mm).

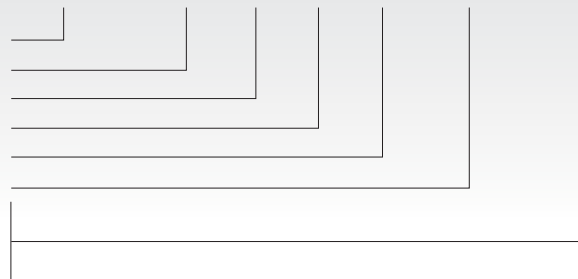

### General characteristics

- Double lip silicone joint connections
- Tubes may be cut using a saw.
- Blow-resistant cladding; chip-resistant.
- Available in diameters of  $\varnothing 60/100$  mm.,  $\varnothing 80/110$  mm.,  $\varnothing 80/125$  mm.

### Materials

Location	Description
• Inner wall	Aluminium.
• Outer wall	Aluminized sheet steel.
• Finish	White epoxy cladding

### Diameters and thickness

	$\varnothing 60/100$	$\varnothing 80/110$	$\varnothing 80/125$
• $\varnothing$ inner (mm)	60	80	80
• $\varnothing$ outer (mm)	100	110	125
• Thickness of steel (mm)	0.5	0.5	0.5
• Thickness of aluminium (mm)	1	1	1

### Fuels

- Natural gas
- Propane
- Butane
- Gasoil

### Maximum temperature for use

- 200°C continuous

### Maximum surge pressure

- 200 Pa

# Secondary flue systems

## Coaxial airtight line

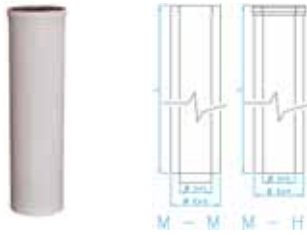

### Connection length

MOUTH		Ø60 / Ø100	Ø80 / Ø110	Ø80 / Ø125
L	M - M	195 / 485 / 965	195 / 485 / 965	195 / 485 / 965
L	M - H	195 / 485 / 965	195 / 485 / 965	195 / 485 / 965

All measurements are expressed in mm.

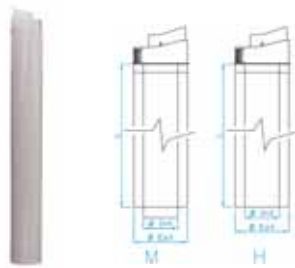

### Terminal

MOUTH		Ø60 / Ø100	Ø80 / Ø110	Ø80 / Ø125
L	H	888	-	-
L	M	888	888	888

All measurements are expressed in mm.



### 45° Connection elbow

MOUTH		Ø60 / Ø100	Ø80 / Ø110	Ø80 / Ø125
D - L	M - M	20 - 135	-	-
D - L	M - H	35 - 155	35 - 155	35 - 170

All measurements are expressed in mm.



### 90° Connection elbow

MOUTH		Ø60 / Ø100	Ø80 / Ø110	Ø80 / Ø125
D - L	M - M	65 - 170	-	-
D - L	M - H	65 - 170	60 - 170	45 - 180
D - L	H - H	65 - 170	-	-

All measurements are expressed in mm.



### Boiler connection elbow

MOUTH		BOILER	Ø60 / Ø100	Ø80 / Ø110	Ø80 / Ø125
D - L	M	SD	65-170	-	-
D - L	H	SD	65-170	-	-
D - L	M	CM	65-170	-	-
D - L	H	CM	65-170	-	-
D - L	M	F	65-170	-	-
D - L	H	F	65-170	-	-

All measurements are expressed in mm.





## Secondary flue systems Coaxial airtight line



### Boiler connection inspection elbow

	MOUTH	BOILER	Ø60 / Ø100	Ø80 / Ø110	Ø80 / Ø125
D - L	M	SD	65-170	-	-
D - L	H	SD	65-170	-	-
D - L	M	CM	65-170	-	-
D - L	H	CM	65-170	-	-
D - L	M	F	65-170	-	-
D - L	H	F	65-170	-	-

All measurements are expressed in mm.



### Vertical outlet

	MOUTH	BOILER	Ø60 / Ø100	Ø80 / Ø110	Ø80 / Ø125
L	M	SD	210	-	-
L	H	SD	210	-	-
L	M	CM	210	-	-
L	H	CM	210	-	-
L	M	F	210	-	-
L	H	F	210	-	-
L	M	FE	210	-	-
L	H	FE	210	-	-

All measurements are expressed in mm.



### Vertical inspection outlet

	MOUTH	BOILER	Ø60 / Ø100	Ø80 / Ø110	Ø80 / Ø125
L	M	SD	210	-	-
L	H	SD	210	-	-
L	M	CM	210	-	-
L	H	CM	210	-	-
L	M	F	210	-	-
L	H	F	210	-	-

All measurements are expressed in mm.



### Roof turret

	Ø60 / Ø100	Ø80 / Ø110	Ø80 / Ø125
L	1100	1110	1110

All measurements are expressed in mm.

# Secondary flue systems

## Coaxial airtight line

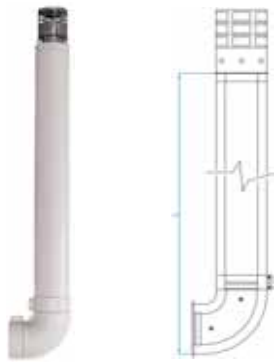

### Kit - terminal + Boiler connection elbow + wall strap

	BOILER	Ø60 / Ø100	Ø80 / Ø110
L	SD	1060	-
L	V	1060	-
L	J	1060	-
L	F	1060	-
L	C & M	1060	-

All measurements are expressed in mm.



### Kit - terminal + Boiler connection inspection elbow + wall strap

	BOILER	Ø60 / Ø100	Ø80 / Ø110
L	SD	1060	-
L	J	1060	-
L	F	1060	-
L	Fa	1060	-
L	Coi	1060	-

All measurements are expressed in mm.



### Joint sleeve

	MOUTH	Ø60 / Ø100	Ø80 / Ø110	Ø80 / Ø125
L	H - H	62	62	62

All measurements are expressed in mm.



### Wall strap kit

	CONNECTION	Ø60 / Ø100	Ø80 / Ø110	Ø80 / Ø125
L	T - T	36,5	-	-
L	T - C	36,5	-	-

All measurements are expressed in mm.

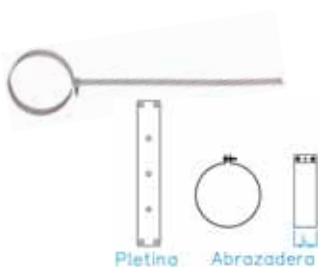

### Wall strap with platen

	Ø60 / Ø100	Ø80 / Ø110	Ø80 / Ø125
L	36,5	-	-

All measurements are expressed in mm.



## Secondary flue systems Coaxial airtight line

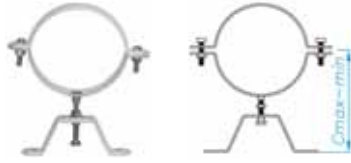

### Adjustable wall strap

	Ø60 / Ø100	Ø80 / Ø110	Ø80 / Ø125
C min-max	100-135	106-141	113-148

All measurements are expressed in mm.



### Finishing collar

	Ø60 / Ø100	Ø80 / Ø110	Ø80 / Ø125
Ø A	170	190	220
L	20	20	30

All measurements are expressed in mm.





## Secondary flue systems Polypropylene line

### Uses

- Extraction of combustion gases from condensation units.
- Piping for extraction of domestic waste water and for use with sanitary equipment.
- Ventilation as provided for in Regulation UNE EN 14471.
- Piping for rainwater.



### Regulations

CE0036 / CPD / 9165/ 001

EN 14471 T120 P1 O W2 O20 I E L

- Regulation number.
- Temperature level.
- Pressure level (N or P or H).
- Resistance to soot fires (G Yes; O No)
- Resistance to condensation (W wet; D dry).
- Resistance to corrosion.
- Distance from combustible materials (mm).
- Location (I Indoors; E Outdoors).
- Criteria for reaction in case of fire.
- Installation (L no shell; L1 suitable for combustible shell)

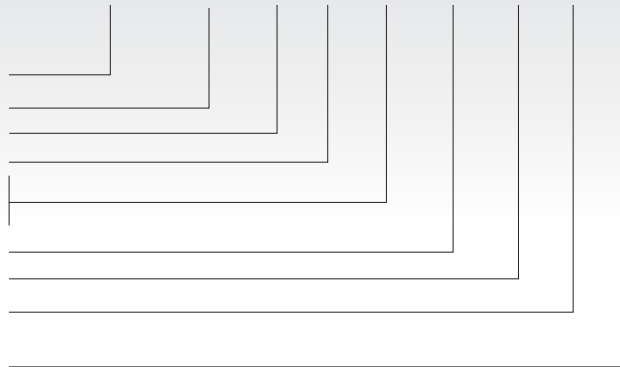

### General characteristics

- Stabilized polypropylene, hot water resistant and low flammability.
- Highly resistant to acidic condensates and chemicals.
- Maximum watertightness.
- Quick and easy installation.
- Highly resistant to buckling fatigue.
- Low electrical conductivity.
- Resistant to low temperatures.
- Highly resistant surface.

### Materials

Location	Description
• Wall	Polypropylene.
• Finish	White - Tubes and Piecing. UV-resistant Black - Terminals. Grey - Flexible tubing.

### Diameters and thickness

	ø80
• ø (mm.)	80
• Thickness of wall (mm.)	2

### Fuels

- Natural gas
- Butanr
- Propane
- Gasoil

### Maximum temperature for use

- 120°C

### Maximum surge pressure

- 200 Pa

# Secondary flue systems

## Polypropylene line

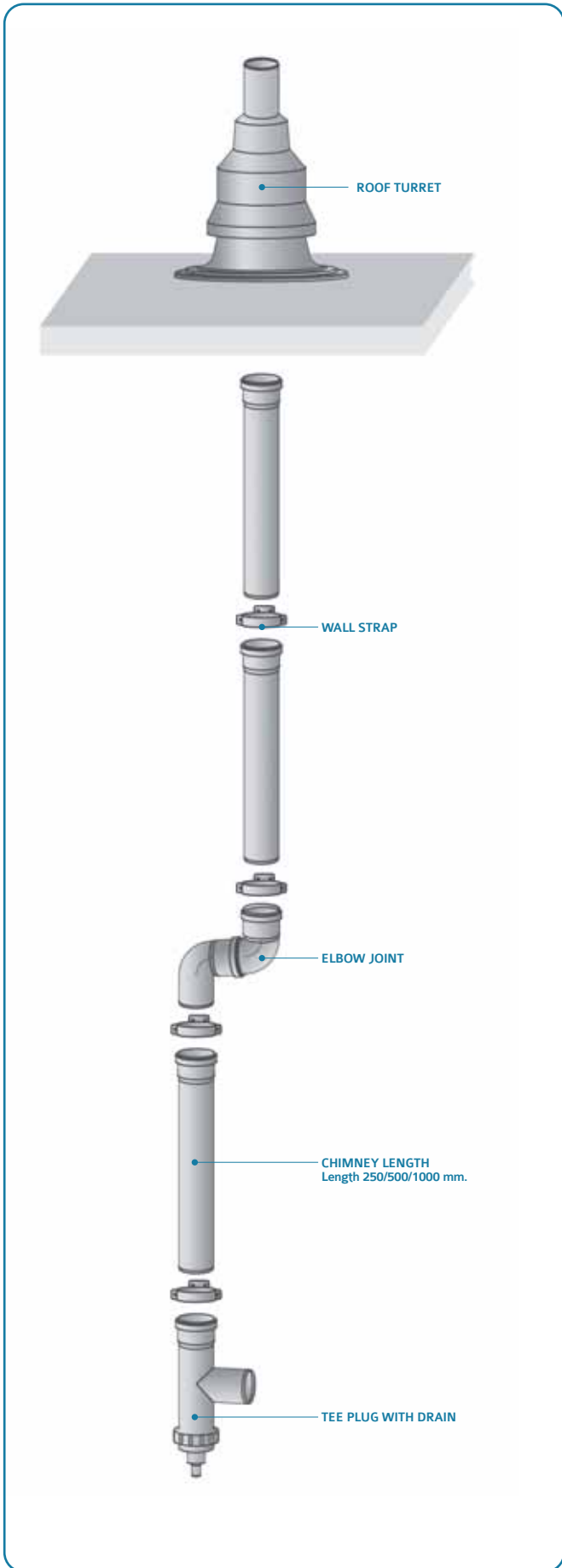

### Instructions for assembly

#### Connection between tubes and accessories:

- Clean the joint, both ends of the tube, elbow and adaptors before use.
- Check to see that the joint is properly in place.
- Apply a thin coat of lubricant on the inside of the joint for easier assembly.
- Insert the male section into the tube, elbow and adaptor.

#### Cut

- A fine-toothed saw or a cutter should be used to obtain the correct measurement.
- The cut end of the tube should then be smoothed down. Using a bevel or a bastard file, file the end of the tube at an approximate 15° angle.
- Important note: Accessories should not be cut.

### Details

#### Cleaning

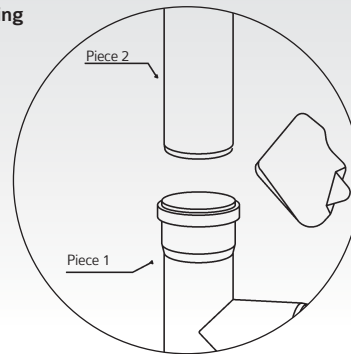

#### Apply vaseline

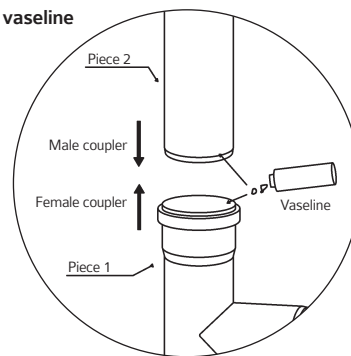

#### Assemble M-F

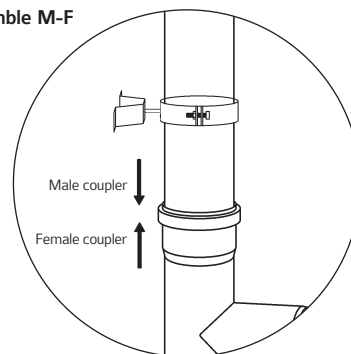



# Secondary flue systems

## Polypropylene line



### Chimney length

ØA	Ø80
L	250 / 500 / 1000 / 2000

All measurements are expressed in mm.



### 30M Flexible length

ØA	Ø80
L	30,000

All measurements are expressed in mm.

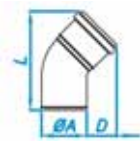

### 45° elbow

ØA	Ø80
L	175
D	53

All measurements are expressed in mm.

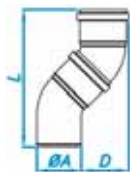

### Connection for 2 45° elbows

ØA	Ø80
L	251
D	86

All measurements are expressed in mm.

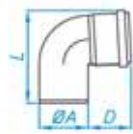

### 87° elbow

ØA	Ø80
L	154
D	71

All measurements are expressed in mm.

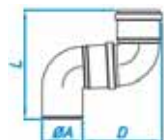

### Connection for 2 87° elbows

ØA	Ø80
L	220
D	158

All measurements are expressed in mm.

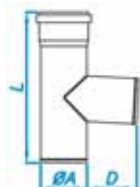

### M-F-M Tee

ØA	Ø80
L	265
D	87

All measurements are expressed in mm.

# Secondary flue systems

## Polypropylene line



### Condensation collector tee

ØA	Ø80
L	365
D	82
I	20

All measurements are expressed in mm.



### Inspection tee

ØA	Ø80
L	270
D	45

All measurements are expressed in mm.



### Stiff-flexible pipe adaptor, male

	Ø80
L	123

All measurements are expressed in mm.



### Flexible-flexible pipe adaptor

	Ø80
L	112

All measurements are expressed in mm.



### Stiff-flexible pipe adaptor, female

	Ø80
L	127

All measurements are expressed in mm.



### UV-resistant terminal

ØA	Ø80
L	500

All measurements are expressed in mm.

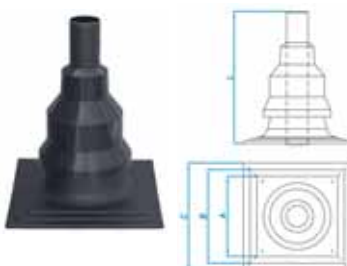

### Rigid roof turret

	Ø80
L	495
A	300
B	350
C	401

All measurements are expressed in mm.





## Secondary flue systems Polypropylene line

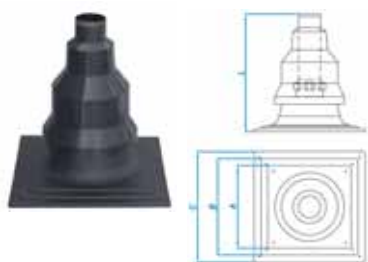

### Flexible roof turret

	Ø80
L	427
A	300
B	350
C	401

All measurements are expressed in mm.

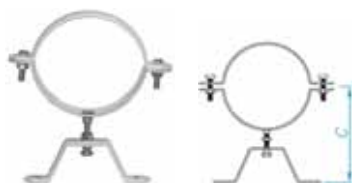

### Adjustable wall strap

	Ø80
C min-max	90-120

All measurements are expressed in mm.



### Finishing collar

ØA	Ø80
B	135
L	25

All measurements are expressed in mm.





## Secondary flue systems Coaxial polypropylene line

### Uses

- Extraction of combustion gases from condensation units.



### Regulations

CE0036 / CPD / 9165 / 001

EN 14471 T120 P1 O W2 O00 I E L1

- Regulation number.
- Temperature level.
- Pressure level (N or P or H).
- Resistance to soot fires (G Yes; O No)
- Resistance to condensation (W wet; D dry).
- Resistance to corrosion.
- Distance from combustible materials (mm).
- Location (I Indoors; E Outdoors).
- Criteria for reaction in case of fire.
- Installation (L no shell; L1 suitable for combustible shell).

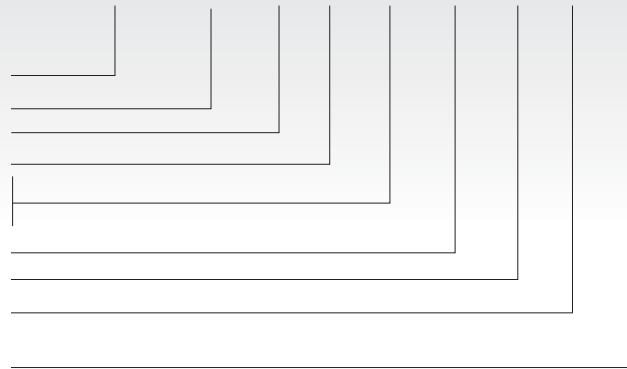

### General characteristics

- Stabilized polypropylene, hot water resistant and low flammability.
- Highly resistant to acidic condensates and chemicals.
- Maximum watertightness.
- Quick and easy installation.
- Highly resistant to buckling fatigue.
- Low electrical conductivity.
- Resistant to low temperatures.
- Highly resistant surface.

### Materials

Location	Description
• Inner wall	Polypropylene.
• Outer wall	Aluminized steel.
• Finish	White epoxy.

### Diameters and thickness

	ø60/100	ø80/125
• ø inner (mm.)	60	80
• ø outer (mm.)	100	125
• Thickness of inner wall (mm.)	2	2
• Thickness of outer wall (mm.)	0.5	0.5

### Fuels

- Natural gas
- Butane
- Propane
- Gasoil

### Maximum temperature for use

- 120°C

### Maximum surge pressure

- 200 Pa

# Secondary flue systems

## Coaxial polypropylene line

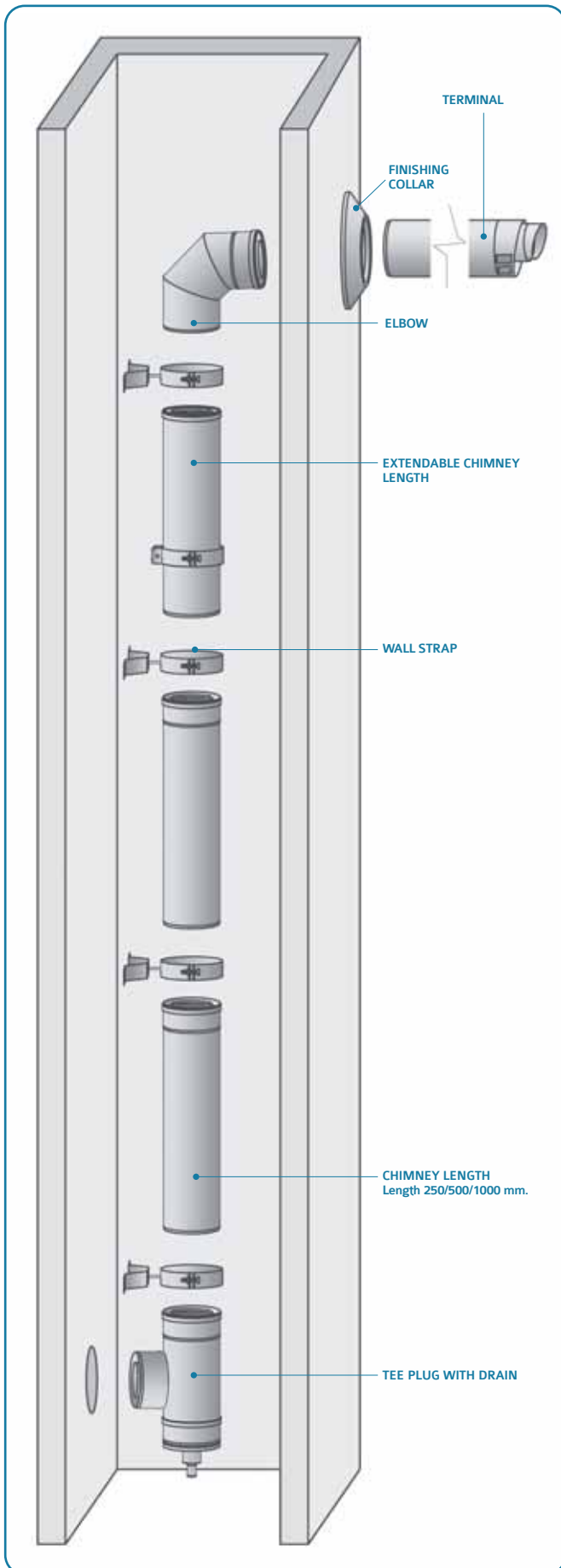

### Instructions for assembly

#### Connection between tubes and accessories:

- Clean the joint, both ends of the tube, elbow and adaptors before use.
- Check to see that the joint is properly in place.
- Apply a thin coat of lubricant on the inside of the joint for easier assembly.
- Insert the male section into the tube, elbow and adaptor.

#### Cut

- A fine-toothed saw or a cutter should be used to obtain the correct measurement.
- The cut end of the tube should then be smoothed down. Using a bevel or a bastard file, file the end of the tube at an approximate 15° angle.
- Important note: accessories should not be cut.

### Details for assembly of extendable parts

1. Measure the distance to be covered by the tube.

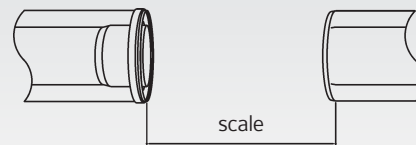

2. Separate extendable piece into two parts by removing the central locking band.

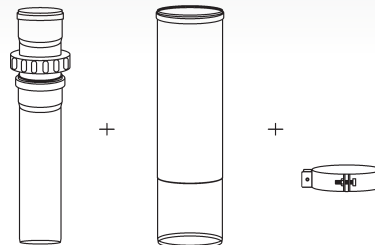

3. Cut the inner tube to the correct length and file the cut end until smooth. Slide the outer tube over the inner tube.

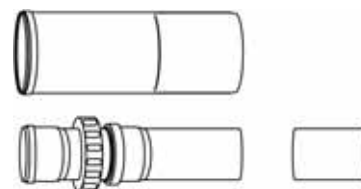

4. Reassemble the two sections and secure the locking band.





# Secondary flue systems

## Coaxial polypropylene line

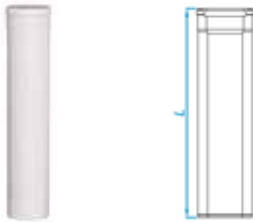

### Chimney length

	Ø60/Ø100	Ø80/Ø125
L	250 / 500 / 1000	250 / 500 / 1000

All measurements are expressed in mm.

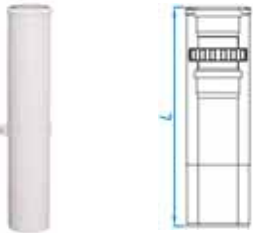

### Extendable chimney length 280/500

	Ø60/Ø100	Ø80/Ø125
L	280 / 500	280 / 500

All measurements are expressed in mm.



### 45° elbow

	Ø60/Ø100	Ø80/Ø125
L	179	190
D	141	170

All measurements are expressed in mm.



### 45° elbow joint

	Ø60/Ø100	Ø80/Ø125
L	247	255
D	183	211

All measurements are expressed in mm.

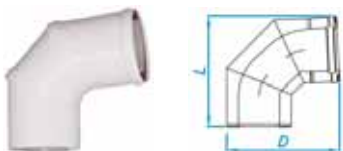

### 87° elbow

	Ø60/Ø100	Ø80/Ø125
L	208	215
D	192	218

All measurements are expressed in mm.



### 87° elbow joint

	Ø60/Ø100	Ø80/Ø125
L	302	308
D	325	372

All measurements are expressed in mm.

# Secondary flue systems

## Coaxial polypropylene line

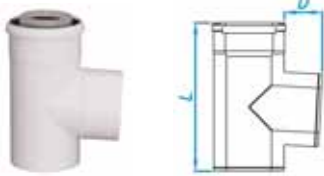

### M-F-M tee

	Ø60/Ø100	Ø80/Ø125
L	222	265
D	56	67

All measurements are expressed in mm.



### Condensation collector tee

	Ø60/Ø100	Ø80/Ø125
L	240	296
D	60	60
I	20	20

All measurements are expressed in mm.

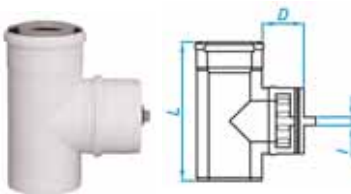

### Inspection tee

	Ø60/Ø100	Ø80/Ø125
L	223	260
D	78	78
I	16	16

All measurements are expressed in mm.



### Horizontal terminal

	Ø60/Ø100	Ø80/Ø125
L	448	469

All measurements are expressed in mm.

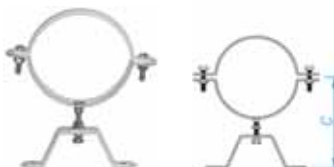

### Adjustable wall strap

	Ø60/Ø100	Ø80/Ø125
C <sub>min-max</sub>	100-135	113-148

All measurements are expressed in mm.



### Finishing collar

	Ø60/Ø100	Ø80/Ø125
ØB	170	220
L	20	30

All measurements are expressed in mm.



## Secondary flue systems Coaxial polypropylene line

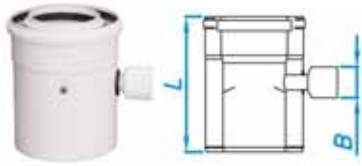

### Condensation collector

	Ø60/Ø100	Ø80/Ø125
L	175	175
ØB	40	40

All measurements are expressed in mm.







## Secondary flue systems Alupractic line

### Uses

- Extraction of combustion gases from atmospheric boilers and furnaces.
- Air and smoke piping, ventilation and extraction.



### Regulations

CE 0099 / CPD / A71 / 0061

EN 1856-2 T200 P1 D Vm L11080 O(50,50)

- Regulation number.
- Temperature level.
- Pressure level (N or P or H).
- Resistance to condensation (W wet; D dry).
- Resistance to corrosion.
- Liner material.
- Resistance to soot fires (G Yes; O No)
- Distance from combustible materials - wall (mm).
- Distance from combustible materials - ceiling (mm).

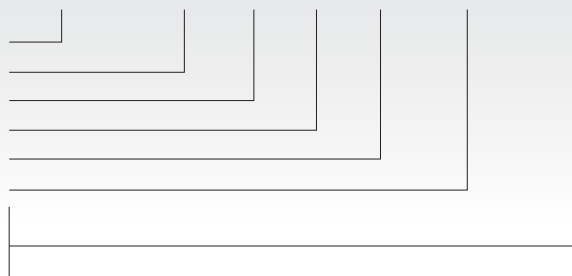

### General characteristics

- Double lip silicone joint connections
- Tubes may be cut using a saw.
- Blow-resistant cladding; chip-resistant.
- Available in diameters of  $\varnothing 100$ - $\varnothing 139$  mm

### Materials

Location	Description
• Wall	Aluminium.
• Finish	White epoxy cladding.

### Diameters and thickness

	$\varnothing 100$	$\varnothing 111$	$\varnothing 125$	$\varnothing 130$	$\varnothing 139$
• $\varnothing$ (mm)	100	111	125	130	139
• Thickness of sheet steel (mm) for $L \leq 1000$ mm.	0.8	0.8	0.8	0.8	0.8
• Thickness of aluminium (mm) for $L > 1000$ mm.	1.2	1.2	1.2	1.2	1.2

### Fuels

- Natural
- Propane
- Butane
- Gasoil

### Maximum temperature for use

- 200°C continuous

### Maximum surge pressure

- 200 Pa

# Secondary flue systems

## Alupractic line

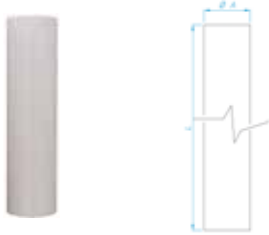

### Chimney length

A	Ø100	Ø111	Ø125	Ø130	Ø139
L	200 / 500 / 1000 / 1500 / 2000				

All measurements are expressed in mm.

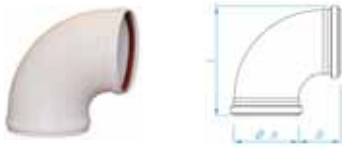

### 90° elbow

A	Ø100	Ø111	Ø125	Ø130	Ø139
B	63	62,5	62,5	63	62,5
L	168	179	193	198	207

All measurements are expressed in mm.



### 72° elbow

A	Ø100	Ø111	Ø125	Ø130	Ø139
B	55	55,5	55,5	56	55,5
L	169	180	193	198	206

All measurements are expressed in mm.



### 45° elbow

A	Ø100	Ø111	Ø125	Ø130	Ø139
B	34	33,5	33,5	35	33,5
L	142	150	160	163	170

All measurements are expressed in mm.



### 90° elbow - test section

A	Ø100	Ø111	Ø125	Ø130	Ø139
B	63	62,5	62,5	63	62,5
L	168	179	193	198	207

All measurements are expressed in mm.



### TT Joint sleeve

A	Ø100	Ø111	Ø125	Ø130	Ø139
L	62				

All measurements are expressed in mm.



### Storm collar

A	Ø100	Ø111	Ø125	Ø130	Ø139
B	205				
L	25				

All measurements are expressed in mm.



## Secondary flue systems Alupractic line



### Adjustable wall strap

A	Ø100	Ø111	Ø125	Ø130	Ø139
C min-max	100-135	106-141	113-148	115-150	120-155

All measurements are expressed in mm.

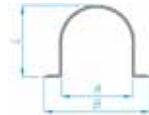

### Wall strap

A	Ø100	Ø111	Ø125	Ø130	Ø139
B	150,5	161,5	175,5	180,5	189,5
L	98	109	123	128	137

All measurements are expressed in mm.



### Wind beater

A	Ø100	Ø111	Ø125	Ø130	Ø139
B	175	175	175	205	245
L	164	164	164	169	176

All measurements are expressed in mm.



### Baffle

A	Ø100	Ø111	Ø125	Ø130	Ø139
B	200	200	200	224	224
L	136	136	136	156	156

All measurements are expressed in mm.

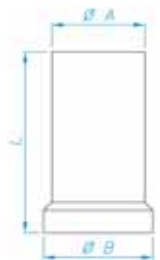

### Boiler adaptor

A	Ø100	Ø111	Ø125	Ø130	Ø139
B	103	115	128	125	142
A	Ø100	Ø111	Ø125	Ø130	Ø139
B	105	117	130	133	145
A	Ø100	Ø111	Ø125	Ø130	Ø139
B	110	120	133	135	148
L	200				

All measurements are expressed in mm.





## Secondary flue systems Vitrified black line

### Uses

- Smoke extraction for wood, coal and pellet-burning stoves, low fires and open fireplaces.



### Diameters and thickness

	ø100	ø120	ø150	ø175	ø200
• ø (mm)	100	120	150	175	200
• Thickness of sheet steel (including enamel)	0.8	0.8	0.9	0.9	0.9

### General characteristics

- Single male-female joint between sections.
- Available in diameters of 100-200 mm.

### Materials

Location	Description
• Wall	Cold rolled sheet steel.
• Finish	Black enamel vitrified at 830°C.

### Fuels

- Wood and coal
- Solid fuels
- Pellets

### Maximum temperature for use

- 600°C

### Maximum surge pressure

- 40 Pa

# Secondary flue systems

## Vitrified black line



### Chimney length

A	Ø100	Ø120	Ø150	Ø175	Ø200
L	250 / 500 / 750 / 1000				

All measurements are expressed in mm.



### 88° elbow

A	Ø100	Ø120	Ø150	Ø175	Ø200
B	115	120	140	155	194
L	220	240	290	340	395

All measurements are expressed in mm.



### 72° elbow

A	Ø100	Ø120	Ø150	Ø175	Ø200
B	105	110	128	125	120
L	215	235	300	350	390

All measurements are expressed in mm.



### 45° elbow

A	Ø100	Ø120	Ø150	Ø175	Ø200
B	70	65	63	65	80
L	205	230	270	300	340

All measurements are expressed in mm.

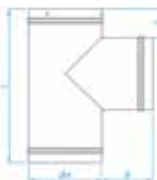

### 90° Tee

A	Ø100	Ø120	Ø150	Ø175	Ø200
B	50	105	105	105	105
C	50	55	55	55	60
L	200	290	320	340	370

All measurements are expressed in mm.



### Sleeve

A	Ø100	Ø120	Ø150	Ø175	Ø200
B	-	125	160	155	203
B	-	-	-	-	180

All measurements are expressed in mm.

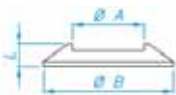

### Finishing collar

A	Ø100	Ø120	Ø150	Ø175	Ø200
B	170	190	220	250	270
L	24				

All measurements are expressed in mm.



## Secondary flue systems Vitrified black line



### Inspection section

A	Ø100	Ø120	Ø150	Ø175	Ø200
L	250				

All measurements are expressed in mm.

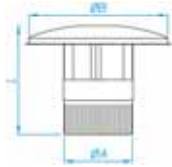

### chimney cap

A	Ø100	Ø120	Ø150	Ø175	Ø200
B	210	210	305	360	360
L	165	180	200	220	230

All measurements are expressed in mm.

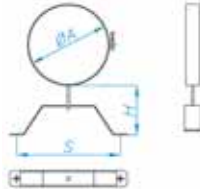

### Adjustable wall strap

A	Ø100	Ø120	Ø150	Ø175	Ø200
H min-max	50-80				
S	92				

All measurements are expressed in mm.

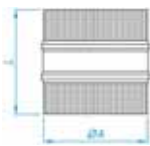

### M pipe

A	Ø100	Ø120	Ø150	Ø175	Ø200
L	150	150	150	150	150

All measurements are expressed in mm.



### F pipe

A	Ø100	Ø120	Ø150	Ø175	Ø200
L	100	100	100	100	100

All measurements are expressed in mm.



### Tee cap

A	Ø100	Ø120	Ø150	Ø175	Ø200
L	22	22	22	22	22

All measurements are expressed in mm.



### Wind strap

A	Ø100	Ø120	Ø150	Ø175	Ø200
---	------	------	------	------	------

All measurements are expressed in mm.







## Secondary flue systems Pellet line

### Uses

- Smoke extraction for wood, coal and pellet-burning stoves, low fires and open fireplaces.
- Smoke extraction for pellet heat generators.



### General characteristics

- Greater resistance to chlorine (typical of solid fuels) than steel AISI 316.
- Resistance to corrosion from acids, alkalines, organic solvents and atmospheric agents.
- Highly resistant to high temperatures, thermal shock and soot fires.
- Highly resistant to peeling and abrasion.
- Stable colour, resistant to UV rays and atmospheric agents.
- Recyclable. Environmentally friendly.

### Materials

Location	Description
• Wall	Cold rolled sheet steel.
• Finish	Texturized black enamel vitrified at 830°C.

### Diameters and thickness

	ø80	ø100
• ø (mm)	80	100
• Thickness of sheet steel (including enamel)	0.9	0.9

### Fuels

- Wood and coal
- Solid fuels
- Pellets

### Maximum temperature for use

- 600°C

### Maximum surge pressure

- 40 Pa

# Secondary flue systems

## Pellet line



### Chimney length

ØA	Ø80	Ø100
L	250 / 500 / 1000	

All measurements expressed in mm.

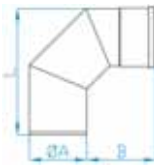

### 90° elbow

ØA	Ø80	Ø100
B	110	120
L	190	220

All measurements expressed in mm.

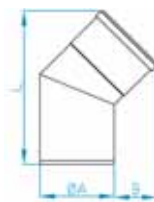

### 45° elbow

ØA	Ø80	Ø100
B	50	57,2
L	177	208

All measurements expressed in mm.

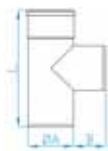

### M F M / M F F tee + tee plug

ØA	Ø80	Ø100
B	70	70
L	220	260
C	58	58

All measurements expressed in mm.

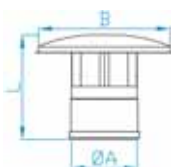

### Chimney cap

ØA	Ø80	Ø100
B	140	200
L	175	200

All measurements expressed in mm.

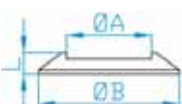

### Storm collar

ØA	Ø80	Ø100
B	150	170
L	25	25

All measurements expressed in mm.



## Secondary flue systems Pellet line

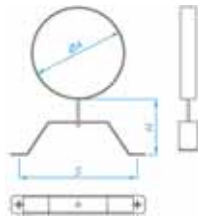

### Adjustable wall strap

ØA	Ø80	Ø100
S	92	
H min-max	50-80	

All measurements expressed in mm.

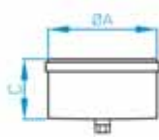

### Tee plug with drain

ØA	Ø80	Ø100
C	58	58

All measurements expressed in mm.

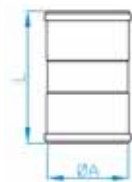

### F-F sleeve

ØA	Ø80	Ø100
L	165	165

All measurements expressed in mm.

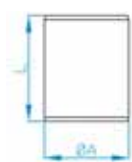

### M-M Sleeve

ØA	Ø80	Ø100
L	125	125

All measurements expressed in mm.



**Plastica Technologies Limited**

Colman House, Station Road,  
Knowle, Solihull, B93 0HL  
United Kingdom

**T** +44 (0) 1564 432112

**E** [info@plastica.tech](mailto:info@plastica.tech)

**W** [www.plastica.tech](http://www.plastica.tech)