

STATES[®]

TERMINAL BLOCKS & TEST SWITCHES

A DIVISION OF MEGGER

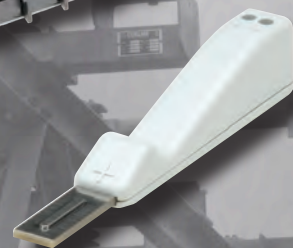
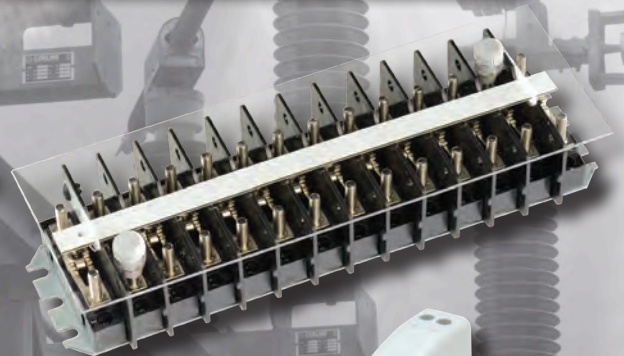
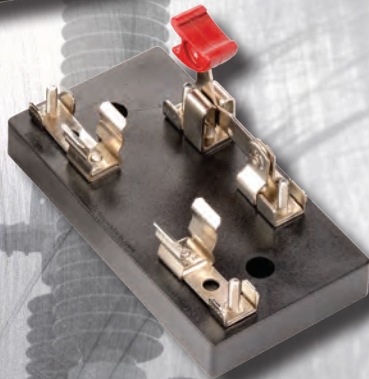
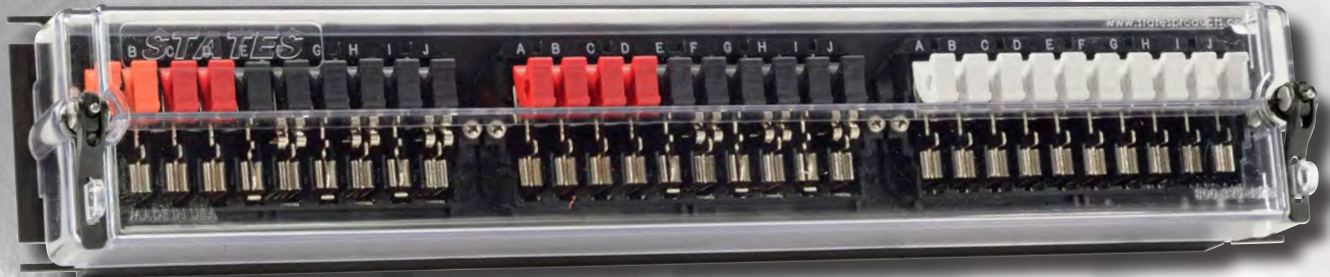

A name you know, quality you can count on.

Overview

STATES Terminal Blocks and Test Switches are designed and manufactured by Megger to facilitate the calibration, disconnecting, troubleshooting, checkout and testing of meters, relays, instruments, transducers and controls systems.

Test technicians and engineers have long depended on these high-quality STATES products to provide easy access to wiring on panelboards and switchboards. For increased safety, durability, ruggedness and reliability, they incorporate many features in material composition and design construction.

STATES Terminal Blocks and Test Switches eliminate wiring reconnection errors and save operator time. Because they easily make, break or rearrange the connections of an electric circuit without disturbing permanent wiring, work can be performed on energized panels.

Terminal Blocks

STATES Types NT and ZWM Terminal Blocks are widely acclaimed for their unique sliding-link disconnect feature which permits the insertion of an indicating instrument or artificial load into a circuit without disturbing permanent wiring. STATES Terminal Blocks are recognized by Underwriters Laboratories Inc.

Test Switches

The complete line of STATES Test Switches includes front-connected, back-connected, semiflush-mounted and flush-mounted versions.

The switches provide all the features you need for applications that involve potential elements, current elements and make-before-break short-circuiting elements for CT circuits.

Customer Service

Megger offers worldwide sales and customer service through offices in more than 100 countries. Our staff is dedicated to supporting all your needs for terminal blocks and test switches by providing high-quality products at competitive prices.

To assist you in ordering STATES products, this catalog shows a wide variety of typical arrangements for test switches and terminal blocks and their corresponding catalog numbers. Individual elements for customized blocks or switches also are shown. We'll be happy to help you select the equipment that meets your specifications.

Certified to ISO 9001

All our facilities are certified to the full operational requirements of the ISO 9001 quality standard.

Proprietary Information Disclaimer

The devices depicted and described hereon embodies a proprietary design owned by Megger. All design, manufacturing, reproduction, sales, and patent rights regarding these devices or drawings are reserved, except where explicit right is granted in writing by Megger.

CUSTOMER SERVICE AND SALES OFFICES

UNITED STATES

Megger
STATES
4271 Bronze Way
Dallas, TX 75237-1019
Phone: 800-325-4574
Fax: (214) 331-7368
Email: states@megger.com
Web: www.statesproducts.com

CANADA

Megger
110 Milner Avenue, Unit 1
Scarborough, ON M1S3R2
Phone: 800-297-9688
Fax: (416) 298-0848

AFRICA

EUROPE

INDIA

MIDDLE EAST

Megger
Archcliffe Road Dover
CT17 9EN
United Kingdom
Phone: +44 (0) 1304 502100
Fax: +44 (0) 1304 207342

CARIBBEAN

CENTRAL AMERICA

MEXICO

SOUTH AMERICA

PACIFIC

FAR EAST

Megger
4271 Bronze Way
Dallas, TX 75237-1019
Phone: (214) 330-3281
Fax: (214) 331-7368

SHIPPING

Prices F.O.B. origin
(U.S. and Canada)

TERMS OF SALE

Terms: Net 30 days
with credit approval: VISA,
MasterCard, American Express
and Discover cards accepted.
Minimum Order: \$100.00 U.S.

WARRANTY

STATES products are
guaranteed against material
and workmanship defects for a
period of one year from date
of shipment. Details of this
warranty are available upon
request.

PRODUCT CHANGES

Product information, photos
and illustrations in this catalog
were current when it was
approved for printing.
In a continuing effort to offer
innovative products, Megger
reserves the right to change
specifications, designs and
models without notice.

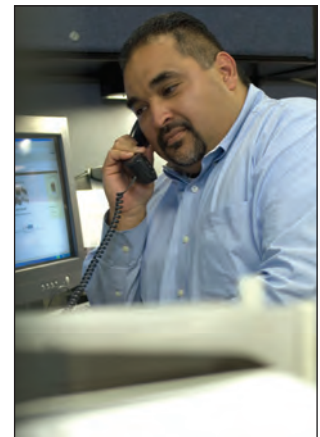

For applications assistance, prices and ordering information for STATES Terminal Blocks and Test Switches, please contact your area Megger office.

CONTENTS

Terminal Blocks	Page
Type NT Terminal Blocks	2
Type ZWM Terminal Blocks	2
Terminal Block Accessories	13
Test Switches	
Type FMS Semiflush-mounted Test Switches	14
Type FMS 19 inch Rack Mount Systems	43
Type R19 Rack Systems	59
FMS Accessories	64
Type MTS Miniature Test Switches	66
Type JTS Test Switches	74
MTS & JTS Accessories	80
Type SJK Test Switches	86
SJK Accessories	96
Type 2RK1 Test Switches	100
Type SMH Test Switches	104
SMH Accessories	116
Type DTE Test Switches	124
Testing Accessories	
Test Paddles	129
FMS Test Lead Kits	130
Binding Post	133
Knobs	133
Jumper Strip	133
Test Paddle Attachment	133
Insulated Socket Wrench	134
Plugs	134
Test Leads	134

STATES® is a division of Megger®. Megger designs, manufactures, markets and supports a wide variety of electrical test and measuring instruments for power applications.

STATES® is a registered trademark of Megger.

Please refer to the STATES website
for more part numbers and up to date information.

Terminal
Blocks

FMS
Test Switches

MTS & JTS
Test Switches

SJK
Test Switches

2RK1
Test Switches

SMH
Test Switches

DTE
Test Switches

Testing
Accessories

Terminal Blocks

Types NT and ZWM

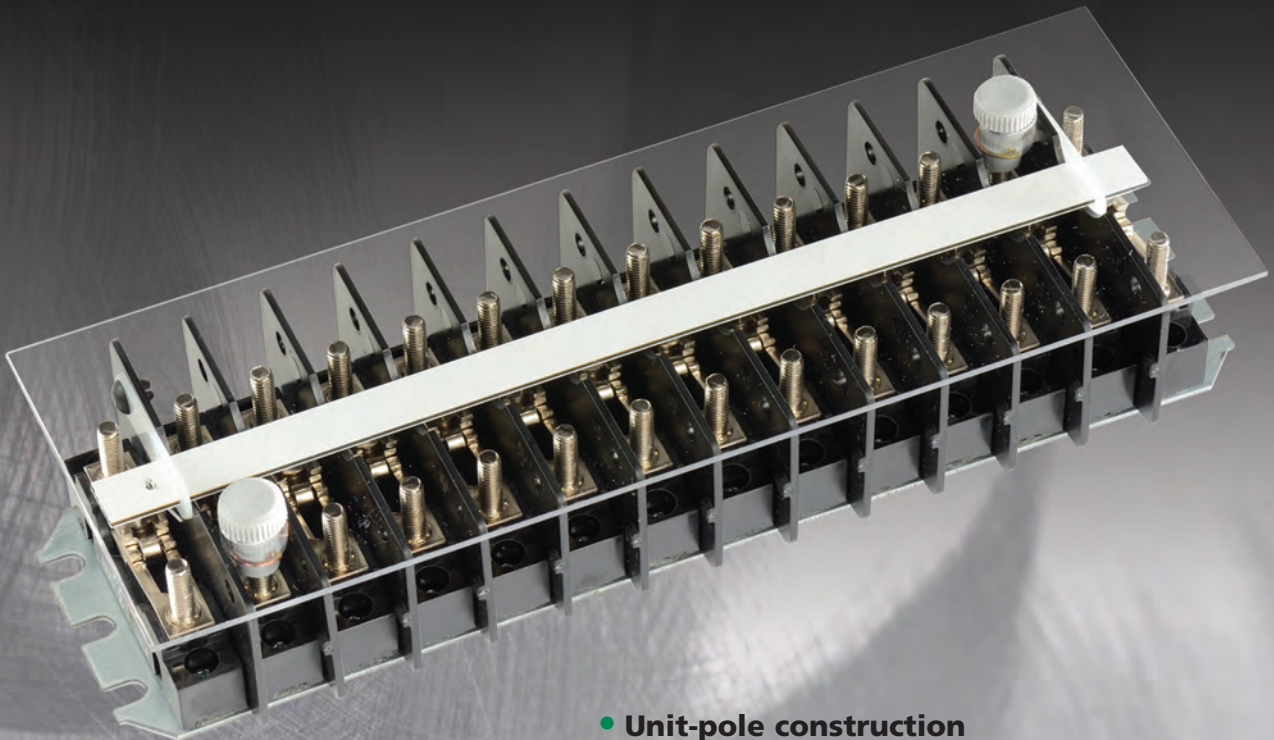

- Unit-pole construction
- Sliding link to permit testing without disturbing wiring
- High barriers that prevent shorting between poles
- Class 1E qualified per IEEE (Type ZWM only)
- Recognized by UL and cUL

STATES[®]

Recognized by UL and cUL

Underwriters Laboratories Inc. recognizes STATES Type NT and Type ZWM Terminal Blocks under its component program, File No. E147470, with a rating of 600 volts, 30 amperes.

Class 1E Qualified Per IEEE Standard 323-1974

Type ZWM Terminal Blocks have successfully completed a generic test program that meets the requirements of most nuclear power plants for Class 1E applications outside of containment. Extensive, accelerated-life testing was conducted by an outside, independent firm and utilized thermal aging, mechanical aging, environmental extremes, radiation exposure and seismic simulation. The service conditions and parameters of the test program included:

41-year life at 131° F (55° C), 600 operations, 95% humidity, 2.2×10^8 rads of radiation and 10g maximum acceleration seismic level.



Side view of closed sliding link block



Pictured is Part No. M-25012 – NT 12 pole sliding link with a white marker strip, shown in the up position.

DESCRIPTION

Featuring a unique “sliding link” disconnect, STATES Type NT and Type ZWM Terminal Blocks function as inexpensive switches to simplify system checkout. Easily and quickly operated, the sliding link provides a means of opening the circuit without removing any wiring. Utilizing unit-pole construction, these terminal blocks are available with up to 73 poles on a single base.

APPLICATIONS

The popular STATES Types NT and Type ZWM Terminal Blocks are widely acclaimed for their unique disconnect feature. Designed to provide a junction between switchboard wiring and cable wires, it replaces the standard stud and straight-strap type of connection with a sliding-link connection.

The sliding link provides the means for inserting an indicating instrument or artificial load into the circuit without removing any wiring. These terminal blocks greatly simplify system checkout by the test technician and eliminate the possibility of error in reconnection.

FEATURES AND BENEFITS

- **Sliding link:** Link quickly opens and closes the circuit to permit testing without disturbing any wiring.
- **Unit-pole construction:** Up to 73 poles available
- **Space-saving:** Only 0.625 of an inch (15 mm) center-to-center is used between poles.
- **Operator safety:** The high barrier between poles increases circuit isolation.
- **UL recognized:** Terminal blocks are rated for 600 volts, 30 amperes (50 amperes for 250 Series Sliding Link only).
- **Fuse holders:** 250- or 600-volt fuse holders are available if circuits must be fused.
- **Marker strips or tags:** Strips or tags are available to make coding of each circuit fast and easy.
- **Connections:** Blocks are available in front-connected styles.
- **Contacts:** Heavy, nickel-plated, brass contacts are used.
- **Covers:** Black or Clear covers are available.

Straight Strap

When the disconnect feature of the sliding link is not required, the blocks can be provided with a straight-strap connection. These blocks have the same construction and dimensions as the sliding link blocks. Poles with straight-strap connection can be combined on the same block with poles having sliding links or fuse holders.



Straight strap block with white marker strip

Shorting-type Terminal Block

Current shorting-type terminal blocks are available in one section, with up to 24 poles. Shorting pins are provided at each pole. There is one blank pole added to each block. The blank pole has provisions for two shorting pins to be stored if not in use. For panel layout, use the dimensions of the regular 10-pole shorting block with marker strip; the 11-pole dimensions would be used to lay out mounting holes.



Shorting-type block with white marker strip

Suffix

G: Current transformer shorting type block, use with 251 straight strap series only (25100-G).

Note

In special applications where flame-retardant properties are desired, STATES Terminal Blocks can be provided with self-extinguishing barriers and marker strips. Use ZWM prefix.

Terminal Blocks with Fuse Protection

Should fused protection be required, specify fuse holders by Part No. 6996 for 250-volt fuse holders or Part No. 6995 for 600-volt fuse holders (fuses not included). Also, counting left to right, specify at which position on the terminal block the fuse holders are to be installed.

Fuse Size

Part No. 6996 accepts standard cartridge fuses rated 250 VAC 30 AMP. Fuse dimensions must be $\frac{1}{4}$ " diameter and $1\frac{1}{4}$ " in length.

Part No. 6995 accepts standard cartridge fuses rated 600 VAC 30 AMP. Fuse dimensions must be $\frac{5}{8}$ " diameter and $1\frac{1}{2}$ " in length.



Part No. 6996 - 250 volt fuse holder



Part No. 6995 - 600 volt fuse holder

COVERS

Covers, clear or black, are available in either knobbed or hinged styles.

The black cover is made of laminate and the clear cover of lexan. Both cover types are made from flame retardant materials.

The knobbed covers are fastened to two pole studs by captive, insulated knobs.

The hinged covers are attached with swing arms.



NT sliding link block with knobbed black cover

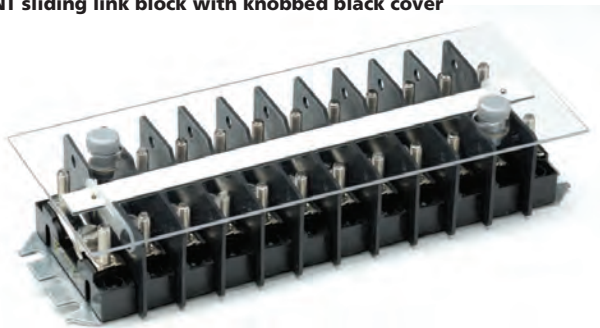

NT sliding link block with knobbed clear cover



CH-25012 - NT 12 pole sliding link with clear hinged cover

TERMINAL BLOCKS

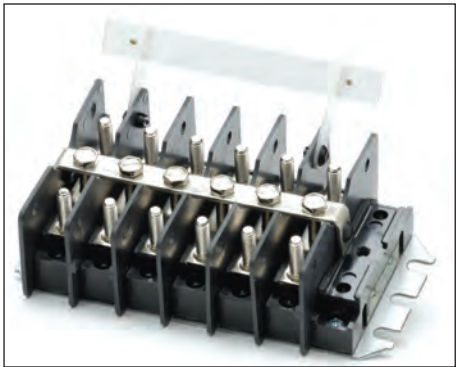

Shorting Type Block with white marker strip

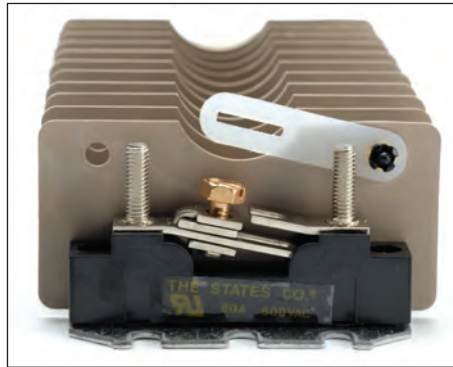

Side view of 'open' link

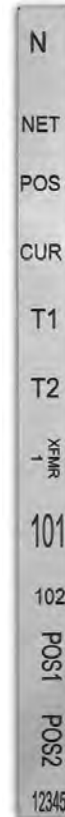

White marker strip showing examples of custom engraving styles

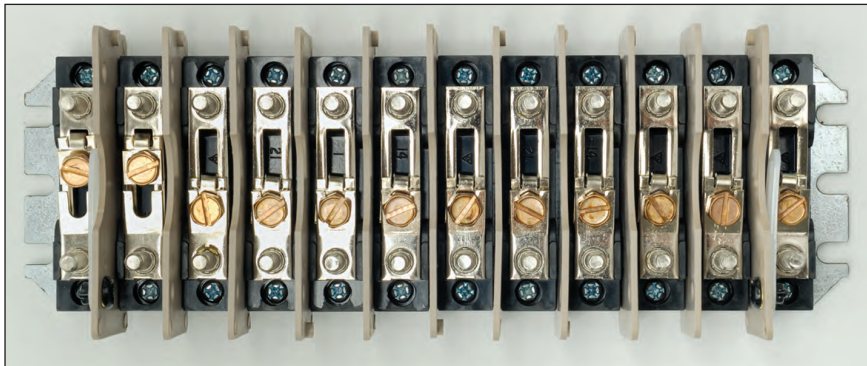

ZWM Sliding Link Terminal Block with first two links in 'open' position

SPECIFICATIONS

NT TERMINAL BLOCKS TECHNICAL SPECIFICATIONS			
Class	250	251	251xx-G
Brief Description	Sliding Link Terminal Block	Straight Strap Terminal Block	Shorting Type Terminal Block
Certifications	UL, cUL UL File E147470	UL, cUL UL File E147470	UL, cUL UL File E147470
Voltage Rating	600VAC	600VAC	600VAC
Current Rating	50A	30A	30A
Recommended Wire Size Range	Min 14awg / Max 10awg	Min 14awg / Max 10awg	Min 14awg / Max 10awg
Recommended Wire Lug Size	#10	#10	#10
Stud Thread	10-32	10-32	10-32
Recommended Torque for Stud Wiring Connections	Max 25in/lbs	Max 25in/lbs	Max 25in/lbs
6996 - Fuse Clip Dimensions - 250 VAC 30 AMP *Fuse not included	1/4" Diameter 1 1/4" Length	1/4" Diameter 1 1/4" Length	1/4" Diameter 1 1/4" Length
6995 - Fuse Clip Dimensions - 600 VAC 30 AMP *Fuse not included	13/32" Diameter 1 1/2" Length	13/32" Diameter 1 1/2" Length	13/32" Diameter 1 1/2" Length
Ambient Temperature	158° F (70° C)	158° F (70° C)	158° F (70° C)

ZWM TERMINAL BLOCKS TECHNICAL SPECIFICATIONS			
Class	ZWM-250	ZWM-251	ZWM-251xx-G
Brief Description	Nuclear Rated Sliding Link Terminal Block	Nuclear Rated Straight Strap Terminal Block	Nuclear Rated Shorting Type Terminal Block
Certifications	UL, cUL UL File E147470 IEEE 323-1974/83 - IEEE 323-1975/87	UL, cUL UL File E147470 IEEE 323-1974/83 - IEEE 323-1975/87	UL, cUL UL File E147470 IEEE 323-1974/83 - IEEE 323-1975/87
Voltage Rating	600VAC	600VAC	600VAC
Current Rating	50A	30A	30A
Recommended Wire Size Range	Min 14awg / Max 10awg	Min 14awg / Max 10awg	Min 14awg / Max 10awg
Recommended Wire Lug Size	#10	#10	#10
Stud Thread	10-32	10-32	10-32
Recommended Torque for Stud Wiring Connections	Max 25in/lbs	Max 25in/lbs	Max 25in/lbs
6996 - Fuse Clip Dimensions - 250 VAC 30 AMP *Fuse not included	1/4" Diameter 1 1/4" Length	1/4" Diameter 1 1/4" Length	1/4" Diameter 1 1/4" Length
6995 - Fuse Clip Dimensions - 600 VAC 30 AMP *Fuse not included	13/32" Diameter 1 1/2" Length	13/32" Diameter 1 1/2" Length	13/32" Diameter 1 1/2" Length
Ambient Temperature	284° F (140° C)	284° F (140° C)	284° F (140° C)

The Recommended Torque Value for the Linking Screw on BOTH the NT and ZWM Sliding Link Terminal Blocks is Max 18in/lbs

STATES TYPE NT/ZWM TERMINAL BLOCKS

Understanding NT Terminal Block Part Numbers					
	1	2	3	4 (optional)	5 (optional)
Block Type	Options (Options can be singular, combined or none selected)	Block Type	Number of Poles (Please use 2 digits)	Mixed Use	Number of Poles
NT	C = Clear Knob Cover B = Black Knob Cover CH = Clear Hinged Cover BH = Black Hinged Cover M = White Marker Strip K = Black Marker Strip SM = White Marker Tags FM = Red Marker Tags EM = Engraved White Marker Strip EK = Engraved Black Marker Strip	250 = Sliding Link 251 = Straight Strap *The NT 250 series uses an 8-32 stainless steel screw for the sliding link disconnect	01 - 73 *See notes on page 10 regarding extra mounting support on blocks over 25 poles	S = Combination of Sliding Link or Straight Strap w/ 250v Fuse Holder B = Combination of Sliding Link or Straight Strap w/ 600v Fuse Holder	1 - 73 G = Shorting Block The shorting option can only be used on the 251 series block *Typically 24 is the highest number of poles on a shorting block

Understanding ZWM Terminal Block Part Numbers					
	1	2	3	4 (optional)	5 (optional)
Block Type	Options (Options can be singular, combined or none selected)	Block Type	Number of Poles (Please use 2 digits)	Mixed Use	Number of Poles
ZWM	CZWM = Clear Knob Cover BZWM = Black Knob Cover CHZWM = Clear Hinged Cover BHZWM = Black Hinged Cover ZWM = White Marker Strip ZWK = Black Marker Strip ZWSM = White Marker Tags ZWFM = Red Marker Tags EZWM = Engraved White Marker Strip EZWK = Engraved Black Marker Strip	250 = Sliding Link 251 = Straight Strap *The ZWM 250 series uses an 8-32 everdur bronze screw for the sliding link disconnect	01 - 73 *See notes on page 10 regarding extra mounting support on blocks over 25 poles	S = Combination of Sliding Link or Straight Strap w/250v Fuse Holder B = Combination of Sliding Link or Straight Strap w/ 600v Fuse Holder	1 - 73 G = Shorting Block The shorting option can only be used on the 251 series block *Typically 24 is the highest number of poles on a shorting block

EXAMPLES

M	-	250 12
1		2 3

Part No. M-25012

NT 12 Pole Block - 12 sliding links with white marker strip.

CHEM	-	250 06	-	S 3
1		2 3		4 5

Part No. CHEM-25006-S3

NT 6 Pole Block - Combination Block - 3 sliding links & 3 250v fuse holders with clear hinged cover and engraved white marker strip (customer must provide fuse holder positions at order placement).

ZWSM	-	250 12
1		2 3

Part No. ZWSM-25012

ZWM 12 Pole Block - 12 sliding links with white marker tags.

BZWM	-	251 08	-	G
1		2 3		4

Part No. BZWM-25108-G

ZWM 8 Pole Block - 8 shorting with black knob cover and white marker strip.

Special custom orders may be subject to order minimums

DIMENSIONS IN INCHES [MM]

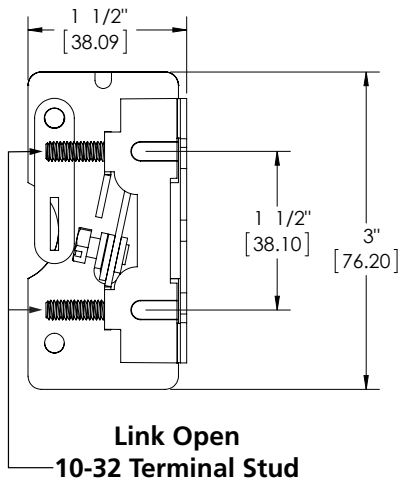
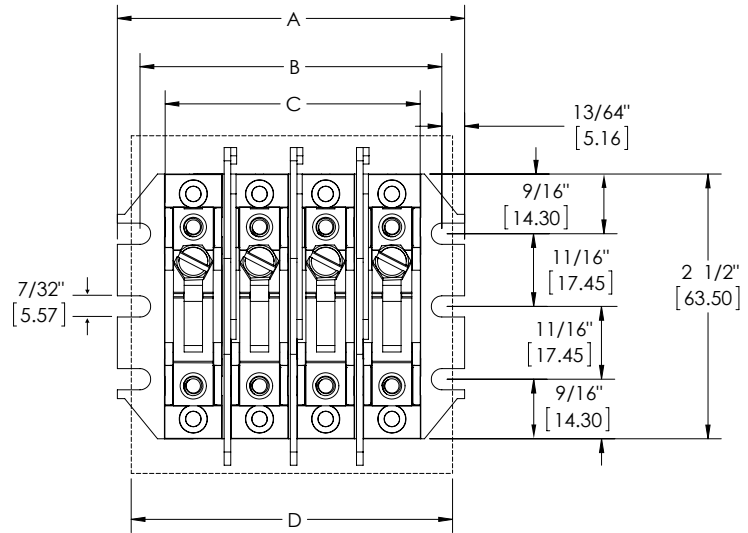
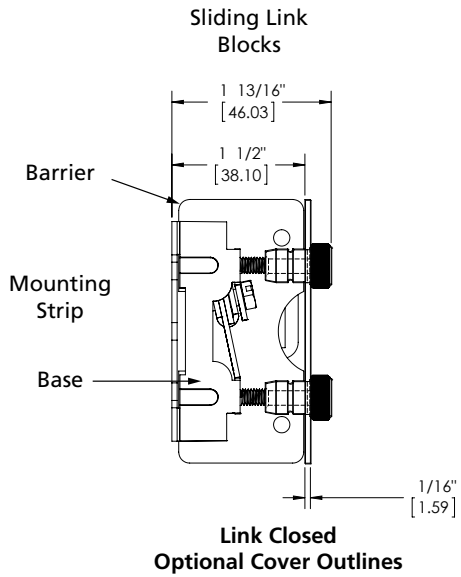

Straight-Strap Blocks

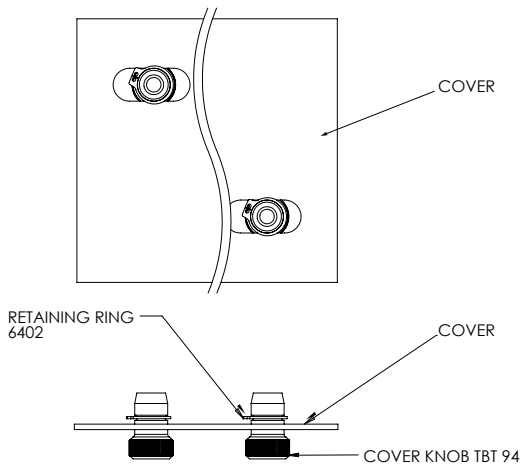
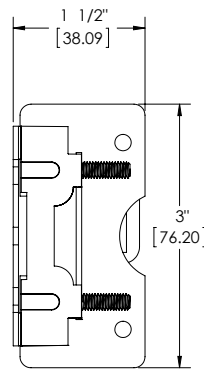

Notes:

- Both the sliding link and straight strap types have same dimensions.
- To provide extra mounting support, at 26 poles, one blank space is added; at 51 poles, two blank spaces are added.
(Example - use the 31 pole mounting dimensions for a 30 pole sliding link or straight strap block)
- Shorting Blocks, 1 extra pole provided for shorting pin storage.
(Example - use the 7 pole mounting dimensions for a 6 pole shorting block)

See **DIMENSIONS** on page 9

DIMENSIONS

NO. OF POLES	A			B			C			D (COVER LENGTH)		
	FRACTIONS	DECIMAL	MM	FRACTIONS	DECIMAL	MM	FRACTIONS	DECIMAL	MM	FRACTIONS	DECIMAL	MM
1	1 3/8	1.38	34.93	31/32	0.97	24.61	35/64	0.55	13.89	-	-	-
2	2	2.00	50.80	1 19/32	1.59	40.48	1 11/64	1.17	29.77	1 3/4	1.75	44.45
3	2 5/8	2.63	66.68	2 7/32	2.22	56.36	1 51/64	1.80	45.64	2 3/8	2.38	60.33
4	3 1/4	3.25	82.55	2 27/32	2.84	72.23	2 27/64	2.42	61.52	3	3.00	76.20
5	3 7/8	3.88	98.43	3 15/32	3.47	88.11	3 3/64	3.05	77.39	3 5/8	3.63	92.08
6	4 1/2	4.50	114.30	4 3/32	4.09	103.98	3 43/64	3.67	93.27	4 1/4	4.25	107.95
7	5 1/8	5.13	130.18	4 23/32	4.72	119.86	4 19/64	4.30	109.14	4 7/8	4.88	123.83
8	5 3/4	5.75	146.05	5 11/32	5.34	135.73	4 59/64	4.92	125.02	5 1/2	5.50	139.70
9	6 3/8	6.38	161.93	5 31/32	5.97	151.61	5 35/64	5.55	140.89	6 1/8	6.13	155.58
10	7	7.00	177.80	6 19/32	6.59	167.48	6 11/64	6.17	156.77	6 3/4	6.75	171.45
11	7 5/8	7.63	193.68	7 7/32	7.22	183.36	6 51/64	6.80	172.64	7 3/8	7.38	187.33
12	8 1/4	8.25	209.55	7 27/32	7.84	199.23	7 27/64	7.42	188.52	8	8.00	203.20
13	8 7/8	8.88	225.43	8 15/32	8.47	215.11	8 3/64	8.05	204.39	8 5/8	8.63	219.08
14	9 1/2	9.50	241.30	9 3/32	9.09	230.98	8 43/64	8.67	220.27	9 1/4	9.25	234.95
15	10 1/8	10.13	257.18	9 23/32	9.72	246.86	9 19/64	9.30	236.14	9 7/8	9.88	250.83
16	10 3/4	10.75	273.05	10 11/32	10.34	262.73	9 59/64	9.92	252.02	10 1/2	10.50	266.70
17	11 3/8	11.38	288.93	10 31/32	10.97	278.61	10 35/64	10.55	267.89	11 1/8	11.13	282.58
18	12	12.00	304.80	11 19/32	11.59	294.48	11 11/64	11.17	283.77	11 3/4	11.75	298.45
19	12 5/8	12.63	320.68	12 7/32	12.22	310.36	11 51/64	11.80	299.64	12 3/8	12.38	314.33
20	13 1/4	13.25	336.55	12 27/32	12.84	326.23	12 27/64	12.42	315.52	13	13.00	330.20
21	13 7/8	13.88	352.43	13 15/32	13.47	342.11	13 3/64	13.05	331.39	13 5/8	13.63	346.08
22	14 1/2	14.50	368.30	14 3/32	14.09	357.98	13 43/64	13.67	347.27	14 1/4	14.25	361.95
23	15 1/8	15.13	384.18	14 23/32	14.72	373.86	14 19/64	14.30	363.14	14 7/8	14.88	377.83
24	15 3/4	15.75	400.05	15 11/32	15.34	389.73	14 59/64	14.92	379.02	15 1/2	15.50	393.70
25	16 3/8	16.38	415.93	15 31/32	15.97	405.61	15 35/64	15.55	394.89	16 1/8	16.13	409.58
26	17	17.00	431.80	16 19/32	16.59	421.48	16 11/64	16.17	410.77			
27	17 5/8	17.63	447.68	17 7/32	17.22	437.36	16 51/64	16.80	426.64			
28	18 1/4	18.25	463.55	17 27/32	17.84	453.23	17 27/64	17.42	442.52			
29	18 7/8	18.88	479.43	18 15/32	18.47	469.11	18 3/64	18.05	458.39			
30	19 1/2	19.50	495.30	19 3/32	19.09	484.98	18 43/64	18.67	474.27			
31	20 1/8	20.13	511.18	19 23/32	19.72	500.86	19 19/64	19.30	490.14			
32	20 3/4	20.75	527.05	20 11/32	20.34	516.73	19 59/64	19.92	506.02			
33	21 3/8	21.38	542.93	20 31/32	20.97	532.61	20 35/64	20.55	521.89			
34	22	22.00	558.80	21 19/32	21.59	548.48	21 11/64	21.17	537.77			
35	22 5/8	22.63	574.68	22 7/32	22.22	564.36	21 51/64	21.80	553.64			
36	23 1/4	23.25	590.55	22 27/32	22.84	580.23	22 27/64	22.42	569.52			
37	23 7/8	23.88	606.43	23 15/32	23.47	596.11	23 3/64	23.05	585.39			
38	24 1/2	24.50	622.30	24 3/32	24.09	611.98	23 43/64	23.67	601.27			
39	25 1/8	25.13	638.18	24 23/32	24.72	627.86	24 19/64	24.30	617.14			
40	25 3/4	25.75	654.05	25 11/32	25.34	643.73	24 59/64	24.92	633.02			
41	26 3/8	26.38	669.93	25 31/32	25.97	659.61	25 35/64	25.55	648.89			

NT and ZWM Terminal Blocks

DIMENSIONS

NO. OF POLES	A			B			C		
	FRACTIONS	DECIMAL	MM	FRACTIONS	DECIMAL	MM	FRACTIONS	DECIMAL	MM
42	27	27.00	685.80	26 19/32	26.59	675.48	26 11/64	26.17	664.77
43	27 5/8	27.63	701.68	27 7/32	27.22	691.36	26 51/64	26.80	680.64
44	28 1/4	28.25	717.55	27 27/32	27.84	707.23	27 27/64	27.42	696.52
45	28 7/8	28.88	733.43	28 15/32	28.47	723.11	28 3/64	28.05	712.39
46	29 1/2	29.50	749.30	29 3/32	29.09	738.98	28 43/64	28.67	728.27
47	30 1/8	30.13	765.18	29 23/32	29.72	754.86	29 19/64	29.30	744.14
48	30 3/4	30.75	781.05	30 11/32	30.34	770.73	29 59/64	29.92	760.02
49	31 3/8	31.38	796.93	30 31/32	30.97	786.61	30 35/64	30.55	775.89
50	32	32.00	812.80	31 19/32	31.59	802.48	31 11/64	31.17	791.77
51	32 5/8	32.63	828.68	32 7/32	32.22	818.36	31 51/64	31.80	807.64
52	33 1/4	33.25	844.55	32 27/32	32.84	834.23	32 27/64	32.42	823.52
53	33 7/8	33.88	860.43	33 15/32	33.47	850.11	33 3/64	33.05	839.39
54	34 1/2	34.50	876.30	34 3/32	34.09	865.98	33 43/64	33.67	855.27
55	35 1/8	35.13	892.18	34 23/32	34.72	881.86	34 19/64	34.30	871.14
56	35 3/4	35.75	908.05	35 11/32	35.34	897.73	34 59/64	34.92	887.02
57	36 3/8	36.38	923.93	35 31/32	35.97	913.61	35 35/64	35.55	902.89
58	37	37.00	939.80	36 19/32	36.59	929.48	36 11/64	36.17	918.77
59	37 5/8	37.63	955.68	37 7/32	37.22	945.36	36 51/64	36.80	934.64
60	38 1/4	38.25	971.55	37 27/32	37.84	961.23	37 27/64	37.42	950.52
61	38 7/8	38.88	987.43	38 15/32	38.47	977.11	38 3/64	38.05	966.39
62	39 1/2	39.50	1003.30	39 3/32	39.09	992.98	38 43/64	38.67	982.27
63	40 1/8	40.13	1019.18	39 23/32	39.72	1008.86	39 19/64	39.30	998.14
64	40 3/4	40.75	1035.05	40 11/32	40.34	1024.73	39 59/64	39.92	1014.02
65	41 3/8	41.38	1050.93	40 31/32	40.97	1040.61	40 35/64	40.55	1029.89
66	42	42.00	1066.80	41 19/32	41.59	1056.48	41 11/64	41.17	1045.77
67	42 5/8	42.63	1082.68	42 7/32	42.22	1072.36	41 51/64	41.80	1061.64
68	43 1/4	43.25	1098.55	42 27/32	42.84	1088.23	42 27/64	42.42	1077.52
69	43 7/8	43.88	1114.43	43 15/32	43.47	1104.11	43 3/64	43.05	1093.39
70	44 1/2	44.50	1130.30	44 3/32	44.09	1119.98	43 43/64	43.67	1109.27
71	45 1/8	45.13	1146.18	44 23/32	44.72	1135.86	44 19/64	44.30	1125.14
72	45 3/4	45.75	1162.05	45 11/32	45.34	1151.73	44 59/64	44.92	1141.02
73	46 3/8	46.38	1177.93	45 31/32	45.97	1167.61	45 35/64	45.55	1156.89

"C" dim is outside edge of block

NOTE:

To provide extra mounting support, at 26 poles one blank space is added and at 51 poles two blank spaces are added. Shorting blocks are provided with 1 extra pole for pin storage.

EXAMPLE:

If you order part number M-25028, which is a 28 pole sliding link block, you will need to use the mounting dimension for the 29 pole strip.
 If you order part number M-25052, which is a 52 pole sliding link block, you will need to use the mounting dimension for the 54 pole strip.
 If you order part number SM-25104-G, which is a 4 pole shorting block, you will need to use the mounting dimension for the 5 pole strip.

COVER PART NUMBERS

No. of Poles	Black Cover (w/cover knobs)	Clear Cover (w/cover knobs)	No. of Poles	Black Cover (w/cover knobs)	Clear Cover (w/cover knobs)	No. of Poles	Black Cover (w/cover knobs)	Clear Cover (w/cover knobs)
02	3943-2	51459-2	12	3943-12	51459-12	22	3943-22	51459-22
03	3943-3	51459-3	13	3943-13	51459-13	23	3943-23	51459-23
04	3943-4	51459-4	14	3943-14	51459-14	24	3943-24	51459-24
05	3943-5	51459-5	15	3943-15	51459-15	25	3943-25	51459-25
06	3943-6	51459-6	16	3943-16	51459-16			
07	3943-7	51459-7	17	3943-17	51459-17			
08	3943-8	51459-8	18	3943-18	51459-18			
09	3943-9	51459-9	19	3943-19	51459-19			
10	3943-10	51459-10	20	3943-20	51459-20			
11	3943-11	51459-11	21	3943-21	51459-21			

NOTE:

Cover will not fit well with certain fuse holders.

Please also refer to page 13 for more cover information.

Extra Mounting Support Guide for NT and ZWM Sliding Link & Straight Strap Terminal Blocks

This guide can also be used for ordering replacement covers and marker strips.

Please mention the part number of the block you are adding the cover or marker strip to.

Example: Replacement marker strips or covers for a 50 pole block would require two 25 pole marker strips or covers.

No. of Poles	Pole Spacing	No. of Poles	Pole Spacing
26	13 - 13	51	17 - 17 - 17
27	14 - 13	52	17 - 18 - 17
28	14 - 14	53	18 - 17 - 18
29	15 - 14	54	18 - 18 - 18
30	15 - 15	55	18 - 19 - 18
31	16 - 15	56	19 - 18 - 19
32	16 - 16	57	19 - 19 - 19
33	17 - 16	58	19 - 20 - 19
34	17 - 17	59	20 - 19 - 20
35	18 - 17	60	20 - 20 - 20
36	18 - 18	61	20 - 21 - 20
37	19 - 18	62	21 - 20 - 21
38	19 - 19	63	21 - 21 - 21
39	20 - 19	64	21 - 22 - 21
40	20 - 20	65	22 - 21 - 22
41	21 - 20	66	22 - 22 - 22
42	21 - 21	67	22 - 23 - 22
43	22 - 21	68	23 - 22 - 23
44	22 - 22	69	23 - 23 - 23
45	23 - 22	70	23 - 24 - 23
46	23 - 23	71	24 - 23 - 24
47	24 - 23	72	24 - 24 - 24
48	24 - 24	73	24 - 25 - 24
49	25 - 24	74	25 - 24 - 25
50	25 - 25	75	25 - 25 - 25

"- " Represents location of the extra mounting support space (blank space)

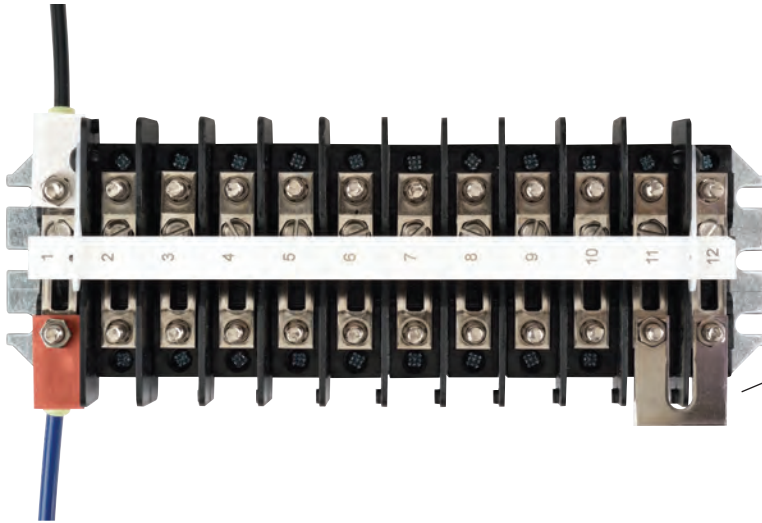

Detail

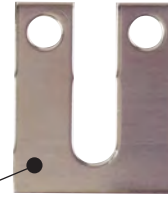

See Testing Accessories page 133 for more information regarding the Jumper Strip.

NT 12 Pole Sliding Link Block, picturing an optional engraved white marker strip and one each TBT69 (individual white marker tag) and TBT96 (individual red marker tag). Also pictured is a cut portion of the jumper strip, Part No. TBT168. This jumper strip comes in a 3ft length and can be cut down to required size by the user.

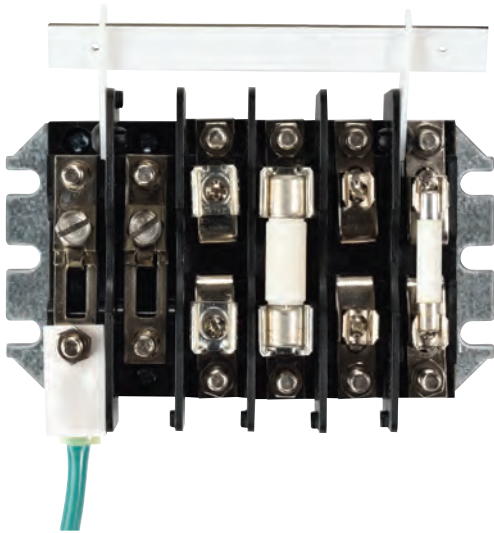

M-25006-B252 side view

M-25006-B252 NT 6 Pole Terminal Block with 2 sliding links, 2 6995 & 2 6996 fuse holders (fuses not included) and one white TBT69 marker tag shown for reference in the bottom left corner.



ZWM-25016 - ZWM 16 pole sliding link with a white marker strip (marker strip show in up position).

TERMINAL BLOCK ACCESSORIES

PART NUMBER	DESCRIPTION
14936INV	NT - Stainless Steel Sliding Link Assembly (250 series) - No Mounting Bar or Hardware
14876INV	ZWM - Everdur Bronze Sliding Link Assembly (250 series) - No Mounting Bar or Hardware
TBT21	NT Single Pole Sliding Link Assembly (14936INV) - Includes PR1422 & XNT126 - No Mounting Bar
TBT73	NT Single Pole Sliding Link Assembly (14936INV) - Includes PR1422 - No Mounting Bar
TBT133	ZWM Single Pole Sliding Link Assembly (14876INV) - Includes PR1422 & XNT126 - No Mounting Bar
TBT22	Straight Strap Assembly - Includes PR1422 & XNT126 - No Mounting Bar
TBT12	Raw Block/Base, No Assemblies or Hardware
TBT12-1	Raw Block/Base, No Assemblies - Includes PR1422
TBT34A	NT Barrier (Black)
TBT282	ZWM Barrier (Tan)
TBT168	Jumper Strip - 3ft Length - Copper, Nickel Plated (See page 133 for more jumper strip information)
6995	600V Fuse Holder Assembly - Fuse Block Only - No Mounting Bar or Hardware (FUSE NOT INCLUDED)
6996	250V Fuse Holder Assembly - Fuse Block Only - No Mounting Bar or Hardware (FUSE NOT INCLUDED)
3623	White Marker Strip, 24" Long, White Exterior w/Black Interior, Suitable for Engraving
3624	Black Marker Strip, 24" Long, Black Exterior w/White Interior, Suitable for Engraving
TBT411	Marker Arm Assembly - Includes 1 each, Nylon Marker Arm, Black Nylon Rivet and 3 Cotter Pins

REPLACE "xx" WITH THE NUMBER OF POLES REQUIRED

3623-xxKIT	White Marker Strip Cut to Requested Length w/3 Cotter Pins, 2 Nylon Marker Arms, 2 Black Nylon Rivets
3623-xx	White Marker Strip Cut to Requested Length w/3 Cotter Pins
3624-xx	Black Marker Strip Cut to Requested Length w/3 Cotter Pins
3943-xx	Black Knob Cover Assembly - Includes Cover Cut to Requested Length, 2 Cover Knobs w/Retaining Rings
51459-xx	Clear Knob Cover Assembly - Includes Cover Cut to Requested Length, 2 Cover Knobs w/Retaining Rings

Example: 3623-12 = white marker strip for a 12 pole terminal block

Note: Covers will not fit properly with certain fuse holders and shorting blocks and will have to be modified. Please mention the block part number the cover will be installed on when ordering.

THE FOLLOWING SPARE PARTS ARE SOLD IN QUANTITIES OF 100



PART NUMBER	DESCRIPTION	PART NUMBER	DESCRIPTION
TBT69-100	White Marker Tags	TBT280-100	Metal Marker Strip Arms
TBT96-100	Red Marker Tags	PR1422-100	Screw 6-32x.302 Phillips Pan Head, Steel, Zinc Plate
XNT126-100	Hex Nut 10-32 x 5/16 W x 7/64 Thick, Brass Nickel Plate	TBT94-100	Terminal Block Cover Knobs (Gray)
XNT163-100	Hex Nut 10-32 x .188TX .312W .078 Counterbore, Brass Nickel Plate	6402-100	Terminal Block Cover Knob Retaining Ring
PR1404-100	Hex Nut 10-32 x 5/16 W x 14/64 Thick, Brass Nickel Plate	XSC1139-100	Hex Screw Head(10-32 x 5/8) for Shorting Type Terminal Blocks
XP119-100	Cotter Pins for Marker Strips	10870-100	Stainless Steel Sliding Link Linking Screw (8-32) for NT Type Terminal Blocks
XR116-100	Black Nylon Rivet for Marker Strip Arms	TBT131-100	Everdur Bronze Sliding Link Linking Screw (8-32) for ZWM Type Terminal Blocks
PR411-100	Nylon Marker Strip Arms		

Please refer to our website for accessory photos.
Mounting bars are available from 1 to 73 poles, call the sales office, 1-800-325-4574, for part numbers.

FMS

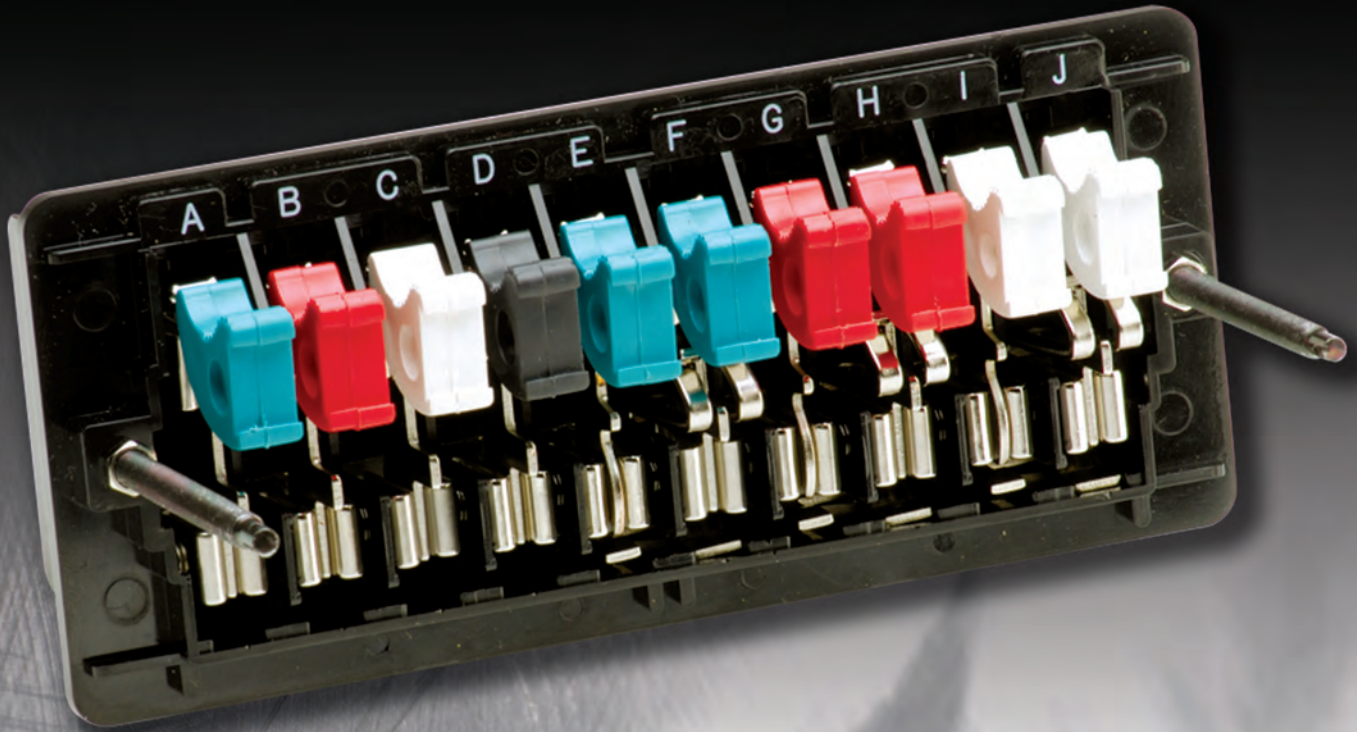
Semiflush-Mounted Test Switches



- Select from 1-10, 1-14, 1-30, or any combination of test switches
- Safe, durable, rugged and reliable
- Choice of black or clear covers with provision to apply seal
- UL recognized 
- CSA Certified 
- Nuclear rated switches
NFMS 10 & NFMS 14 pole versions

STATES®

The STATES FMS Semiflush-Mounted Test Switches provide a compact, versatile means to disconnect, test or measure devices and circuits in panelboards such as relays, metering, control circuits and other instrumentation applications. The FMS switch works without instrument transformers being disconnected from secondary wiring.

The FMS switch is the result of many decades of experience in the design and manufacture of test switches. Many features are incorporated for safety, ease of use, durability and security.

FMS TEST SWITCH BENEFITS

- **No downtime:** Measurements of voltage and current may be made without taking the device out of service.
- **Easy access:** All measurements and tests are performed at the front of the panelboard. This feature saves time and provides better safety and system security.

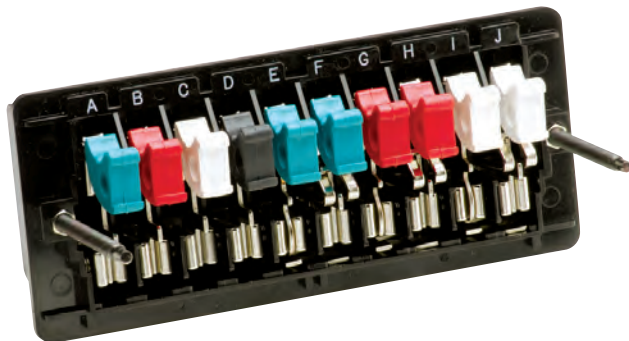

FMS 10-pole test switch

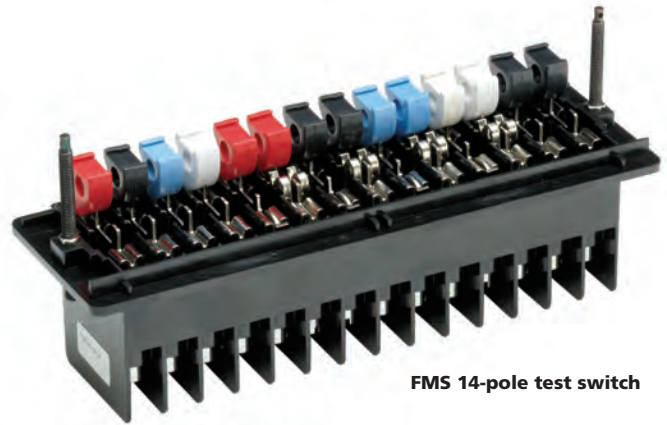

FMS 14-pole test switch

- **Secure:** The FMS 10, 14 & 30 pole deeper, wider, clear covers come with a “knockout” tab for a safety lock (not included), that can be used with our optional FMS Lockout Kit. Part No. FMSLOCK-1. The cover screws, which come standard, have a hole in the tip to insert the wire of a meter-type lead seal (not included). This will help deter unauthorized access to the switch.
- **Use standard plugs:** The test-clip feature allows connections using standard spring-clip test leads. Test connections also can be made using STATES Dual Circuit Plug (Part No. 15000), the STATES 10 Pole Test Paddle (Part No. V1TP10) or the STATES 14 Pole Test Paddle (Part No. FTP14).
STATES recommends the use of Part No. 15000 on all of its' test switches.
Use of any other manufacturer's plug could damage the switch and may void the warranty.
- **Safe to use:** Current switches automatically short-circuit current transformer secondaries when the switches are opened for test-plug insertion.
- **Choice of operation:** To provide testing flexibility, the FMS Switches can be operated independently, or two or more can be connected using the yoking bar to perform specific testing requirements.
- **Cost-saving advantage:** The FMS 10-pole test switch can be used as a direct replacement for many competitor test switches. In most cases you do not have to cut new holes or make any modifications.
- **Optional clear cover:** See at a glance if a switch blade is open or closed with the optional deeper, wider, clear cover. A deep ridge prevents the blade from opening or closing.

FMS Semiflush-Mounted Test Switches

The FMS switch base and cover is made of molded, flame-retardant ABS plastic, which provides a tough, flexible, insulated enclosure. Individual test switches are a knife-blade type and are separated by insulating barriers that are part of the molded base. Molded switch handles have a dovetail indentation to accept marker cards for circuit identification.

The individual FMS switch bases contain 10 or 14 positions and offer 1-10, 1-14 or 1-30 (consisting of 3, 10-pole bases) combinations.

The current switches have the necessary make-before-break short-circuit feature. A hole is provided in each handle to allow insertion of a yoke bar to gang switch operations together.

Two types of connections are offered on the back of the FMS test switch. Screw terminals are standard. Stud connections are optional. To specify stud connections, refer to **Ordering Information**. Either connection is separated by molded insulating barriers. The width between barriers is sufficiently wide enough for a standard spin-tight tool to be inserted for installation or removal of wire.

Covers

The FMS test switch comes standard with a black cover and the option of a clear cover. Both cover types completely seal the switches. Clear cover kits are also available to replace existing black covers, refer to **Ordering Information**.

Color-coded handles

Unless otherwise specified, **potential** elements have **red handles**, and **current** elements have **black handles**. Additionally, the following other handle colors are available at extra cost: blue, orange, white, yellow, green, brown and purple.

Identification card holder

Each handle is slotted for insertion of an identification card for marking or coding. Cards are available under Part No. 680001.

Recognized by UL & CSA

STATES FMS Test Switch is recognized by Underwriters Laboratories Inc., UL File E225664, with a rating of 600 volts, 30 amps, and is certified by CSA, Certificate 1281976. For additional information, go to www.ul.com.

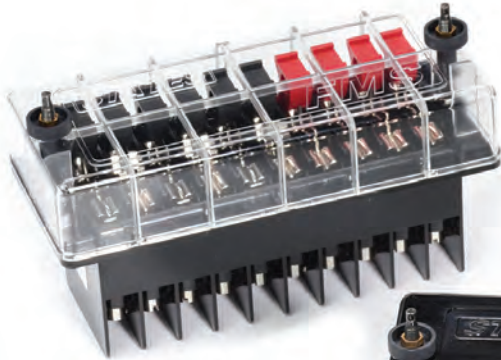

10 Pole Clear Narrow Cover

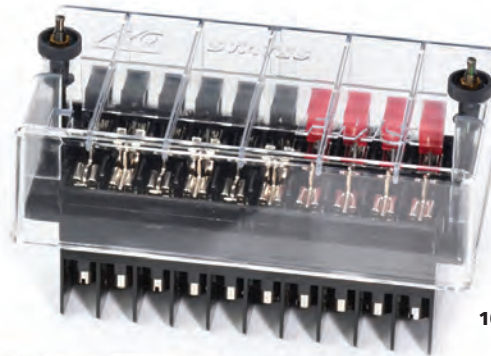

10 Pole Clear Wide Cover



10 Pole Black Cover

Deep ridge prevents a switch blade from opening or closing



Optional clear covers for STATES FMS Test Switch

Cover completely seals test switch



14 Pole Clear Wide Cover

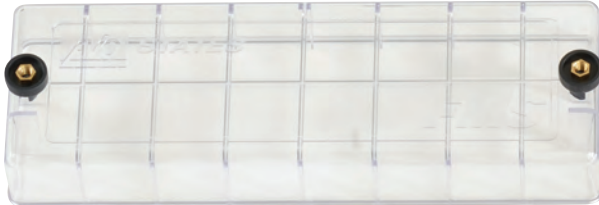

14 Pole Clear Narrow Cover



14 Pole Black Cover

STATES NUCLEAR RATED FMS TEST SWITCHES

The line of NFMS Test Switches, NFMS10 & NFMS14, were designed for Class 1E applications. Class 1E as described per IEEE323-1974/83 & IEEE 323-1975/87, is the safety classification of the electric equipment and systems that are essential to emergency reactor shutdown, containment isolation, reactor core cooling, and containment and reactor heat removal, or otherwise are essential in preventing significant discharge of radioactive material to the environment.

These test switches are manufactured of Polyetherimide material (switch base and cover) and a copper and bronze alloy with nickel plating on the metal conductive parts to

prevent corrosion. The switches were tested following IEEE 323-1974/83 & IEEE 323-1975/87 standards for Class 1E applications. They were exposed to radiation tests, 500 cycles of mechanical operations and rated current and voltage as well as being subjected to a 24 hour, 212°F superheated steam oven and seismic tests. The standard for Class 1E requires that all components have a 40 year life work cycle.



NFMS 10 Pole



NFMS 14 Pole

FMS Semiflush-Mounted Test Switches

SPECIFICATIONS



FMS Test Switches

Style - FMS	FMS10	FMS14	NFMS10	NFMS14	FMS19	R19
Brief Description	10 Pole Test Switch Semi-Flush Mounted	14 Pole Test Switch Semi-Flush Mounted	Nuclear Rated 10 Pole Test Switch Semi-Flush Mounted	Nuclear Rated 14 Pole Test Switch Semi-Flush Mounted	FMS 19inch Rack Mounting System Semi-Flush Mounted	R19 Rack Mounting System Semi-Flush Mounted
Typical Applications	Sub-Station Monitoring Relay Panels Metering	Sub-Station Monitoring Relay Panels Metering	Sub-Station Monitoring Relay Panels Metering	Sub-Station Monitoring Relay Panels Metering	Sub-Station Monitoring Relay Panels Metering	Sub-Station Monitoring Relay Panels Metering
Certifications	UL, CSA UL File E225664	UL, CSA UL File E225664	UL, CSA UL File E225664 IEEE 323-1974/83 - IEEE 323-1975/87	UL, CSA UL File E225664 IEEE 323-1974/83 - IEEE 323-1975/87	UL, CSA UL File E225664	UL, CSA UL File E225664
Voltage Rating	600VAC	600VAC	600VAC	600VAC	600VAC	600VAC
Current Rating	30A	30A	30A	30A	30A	30A
Recommended Wire Size Range	Min 14awg Max 10awg	Min 14awg Max 10awg	Min 14awg Max 10awg	Min 14awg Max 10awg	Min 14awg Max 10awg	Min 14awg Max 10awg
Recommended Wire Lug Size	#10	#10	#10	#10	#10	#10
Screw Thread	8-32	8-32	8-32	8-32	8-32	8-32
Recommended Torque for Screw Wiring Connections	Max 15in/lbs	Max 15in/lbs	Max 15in/lbs	Max 15in/lbs	Max 15in/lbs	Max 15in/lbs
Stud Thread	10-32	10-32	10-32	10-32	10-32	10-32
Recommended Torque for Stud Wiring Connections	Max 25in/lbs	Max 25in/lbs	Max 25in/lbs	Max 25in/lbs	Max 25in/lbs	Max 25in/lbs
Ambient Temperature	104° F (40° C)	104° F (40° C)	131° F (55° C)	131° F (55° C)	104° F (40° C)	104° F (40° C)

STATES TYPE FMS 10 & 14 POLE TEST SWITCHES

Understanding FMS 10 & 14 Pole Part Numbers				
Size of Switch Base	1	2	3	4
	Cover Type	Number of Poles	Arrangement Designator	Terminal Type
10 Pole	FMS - Black Cover 2FMS - Deeper, Wider Clear Cover 3FMS - Narrow Clear Cover CI-FMS - Bottom Slotted Black Cover NFMS - Nuclear Rated Cover (Gray)	01 - 10	This is the letter and/or number designation that has been assigned for a particular arrangement See catalog page 26, or visit our website at www.statesproducts.com for arrangement options	Switches are provided with screw terminals unless otherwise specified by adding -ST for Stud Terminals

Size of Switch Base	1	2	3	4
	Cover Type	Number of Poles	Arrangement Designator	Terminal Type
14 Pole	FMS14 - Black Cover 2FMS14 - Deeper, Wider Clear Cover 3FMS14 - Narrow Clear Cover CI-FMS14 - Bottom Slotted Black Cover NFMS14 - Nuclear Rated Cover (Gray)	01 - 14	This is the letter and/or number designation that has been assigned for a particular arrangement See catalog page 26, or visit our website at www.statesproducts.com for arrangement options	Switches are provided with screw terminals unless otherwise specified by adding -ST for Stud Terminals

EXAMPLES

<u>3FMS</u> 1	-	<u>06 A</u> 2 3	-	<u>ST</u> 4
------------------	---	--------------------	---	----------------

Part No. 3FMS-06A-ST

6 Switches in a 10 pole base, with a narrow clear cover and stud terminals.

<u>2FMS</u> 1	-	<u>10 A</u> 2 3
------------------	---	--------------------

Part No. 2FMS-10A

10 Switches in a 10 pole base, with a deeper, wider clear cover and screw terminals.

<u>FMS14</u> 1	-	<u>14 A1</u> 2 3
-------------------	---	---------------------

Part No. FMS14-14A1

14 Switches in a 14 pole base, with a black cover and screw terminals.

<u>NFMS</u> 1	-	<u>10 E1</u> 2 3
------------------	---	---------------------

Part No. NFMS-10E1









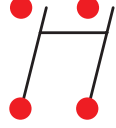
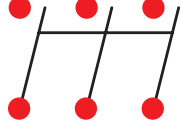

10 Switches in a nuclear rated 10 pole base with a nuclear rated cover and screw terminals.

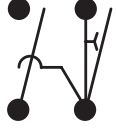
<u>NFMS14</u> 1	-	<u>14 A</u> 2 3	-	<u>ST</u> 4
--------------------	---	--------------------	---	----------------

Part No. NFMS14-14A-ST

14 Switches in a nuclear rated 14 pole base with a nuclear rated cover and stud terminals.

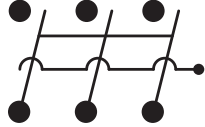
FMS SWITCH ELEMENTS

<p>1</p>  <p>Single-Pole Potential</p>	<p>2</p>  <p>Ganged Double-Pole Potential</p>	<p>16</p>  <p>Ganged Three-Pole Potential</p>
<p>8</p>  <p>Current Test Jack Without Blade</p>	<p>9</p>  <p>Current Test Jack</p>	<p>10</p>  <p>Right-Hand Current Assembly Consists of Test Jack and Short-Circuiting Current Assemblies</p>
<p>5</p>  <p>Short-Circuiting Assembly With Left-Hand Common Bar</p>	<p>6</p>  <p>Short-Circuiting Assembly With Right-Hand Common Bar</p>	<p>24</p>  <p>Through Bar</p>
<p>11</p>  <p>Left-Hand Current Assembly Consists of Test Jack and Short-Circuiting Current Assemblies</p>	<p>13</p>  <p>Ganged Two-Pole Short-Circuiting Current Assembly</p>	<p>20</p>  <p>Ganged Three-Pole Short-Circuiting Current Assembly, Right Extension</p>
<p>26</p>  <p>Blank Space</p>	<p>For the most up-to-date information, please visit our website – www.StatesProducts.com</p>	

NOTES:

1. Base molded barriers are provided between poles of opposite polarity.
2. **Potential** handles are **red** and **current** handles are **black** unless otherwise specified.
3. Specify adjacent handles to be ganged (yoked) if desired.
4. Black potential blade available. (Use "k" in arrangement, example: 1k-1k-1k)
5. For stud connections add "ST" as suffix. (Example, FMS-05A-ST)
6. Arrange elements, front view, left to right.
7. When using the #20 element, please use either the #8, #9, or #24 element on the right for the right extension to connect to. (Example, 20-9-1-1-1-1-1-1)

ORDERING INFORMATION

SPECIAL ORDERS

Special Arrangements: In addition to the typical arrangements shown on pages 25-40, special arrangements are available. These can be made of any combination of potential or current elements, with a maximum of 10 or 14 poles. For more information, refer to the following example and illustrations on Page 19.

Example:

To order a customized, 10 or 14-pole Switch, specify:

Switch Type: STATES Type FMS
No. of poles: 10 or 14-pole Test Switch
Arrangement*: 1-10-1-10-1-10-1

Terminal Type: Specify stud or screw terminal
Cover Type: Black, Clear (deeper, wider or narrow)

***Arrangements should be given as front view of switch, left to right, using the elements listed on page 20.**

Handle Colors: The standard colors for handles are **red** for **potential** and **black** for **current**. Handles are also available in other colors.

To specify non-standard colors, add to the element number the appropriate color code:

Color	Color Code
Black	k
Red	r
Blue	b
Orange	e
White	w
Green	g
Yellow	y
Brown	n
Purple	p

To order a switch with handles in non-standard colors You must specify the arrangement with colors indicated. For example, to order a 2-pole switch with special handle colors, specify: **Arrangement: 1y-1y. This replaces the standard red handles with yellow handles.**

Ganged handles

You may specify a yoking bar to gang adjacent handles. For example, to order a switch with the adjacent potentials ganged, you must specify: **Gang all potentials**

On the following FMS 10 & 14 pole catalog arrangement pages, the ganged handles are represented with the number (#) sign.

Example: #1-1-1-1-1-1-1-1-1-1# (all handles in between the “#” are ganged together)

Nuclear Rated FMS Test Switches

The Nuclear Rated FMS Test Switches are available in 1 – 10 and 1 – 14 pole arrangements with opaque covers.

To order, simply add the prefix N to the beginning of any of the switches listed.

Example: 10 Pole – NFMS-10A or NFMS-10A-ST
14 Pole – NFMS14-14A1 or NFMS14-14A1-ST

NOTE: Clear covers are not available for the nuclear rated switches.

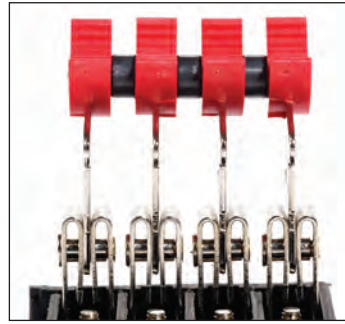

Detailed view of ganged handles. See page 64 for ganging kit information.

OPTIONAL ACCESSORIES



Dual Circuit Plug

By inserting the STATES Dual Circuit Plug (Part No. 15000) into the test jack, safe measurement can be made of current transformer secondary current.

STATES recommends the use of Part No. 15000 on all of its test switches.

Use of any other manufacturer's plug could damage the switch and may void the warranty.

Identification cards

Each switch handle is slotted for insertion of an identification card for marking or coding. Cards are available under Part No. 680001.



Test Paddle

The 10 and 14 pole potential test paddles are feature packed and have been designed to make a test technician's job easier.

Handle – use one hand to connect to test switch.

Labeled – locate connector to corresponding switch.

Use for STATES FMS Test Switch.

Part No. V1TP10 - 10 Pole Test Paddle

Part No. FTP14 - 14 Pole Test Paddle

See Testing Accessories on page 128.

Typical Wiring Diagram

FMS
Test Switches

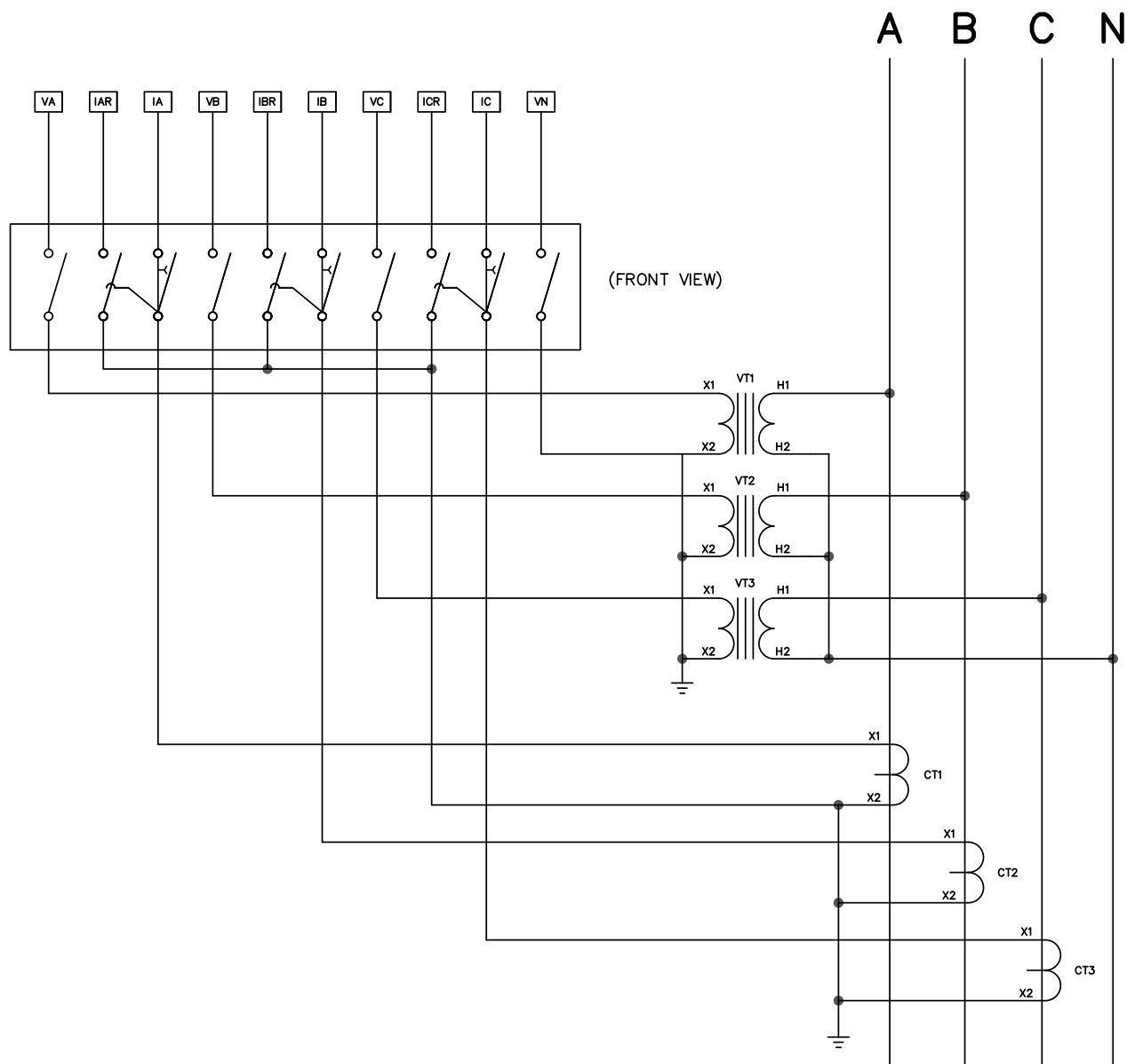

FMS-10C-ST (ARR: 1-10-1-10-1-10-1)



FMS-10C-ST back view. Also shown is the center insert used for the optional back cover attachment.

NARROW CLEAR AND BLACK COVERS

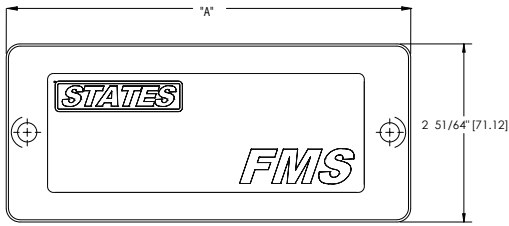

POLE	"A" DIMENSION	
10	6 23/64"	[161.5]
14	8 7/16"	[214.3]
30	17 45/64"	[449.6]

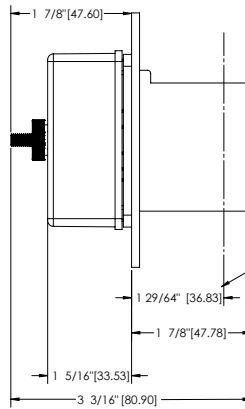

THIS DIMENSION TO TOP OF LUG MOUNTING NUT IN ASSEMBLY

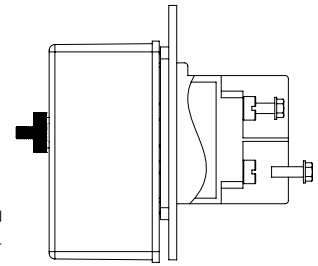

Cut-away side view of screw terminals

FMS
Test Switches

DEEPER, WIDER CLEAR COVER

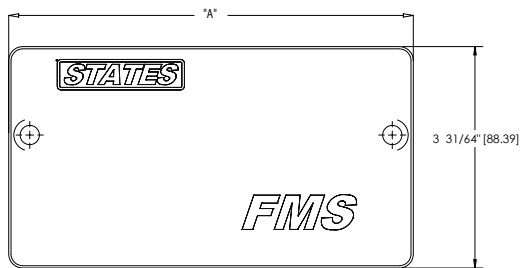

POLE	"A" DIMENSION	
10	6 23/64"	[161.5]
14	8 7/16"	[214.3]
30	17 45/64"	[449.6]

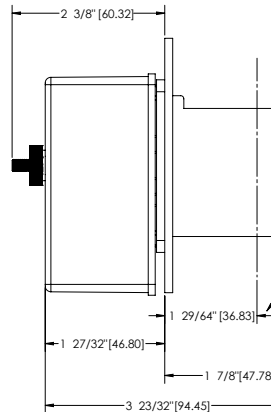

THIS DIMENSION TO TOP OF LUG MOUNTING NUT IN ASSEMBLY

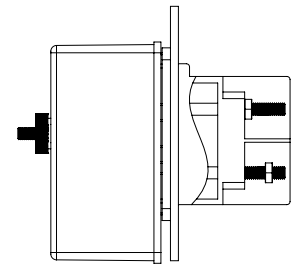

Cut-away side view of stud terminals

TYPE FMS 14-POLE TEST SWITCH DIMENSIONS IN INCHES [MM]

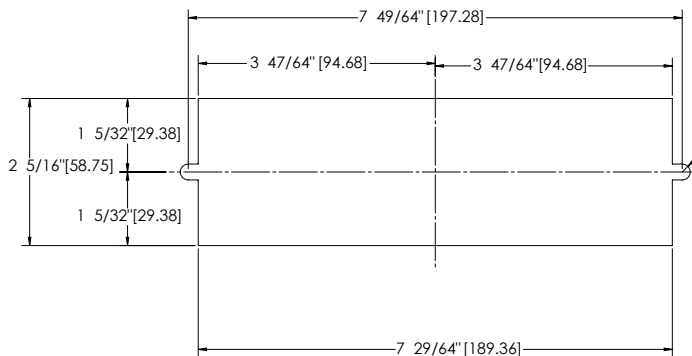

TYPE FMS 10-POLE TEST SWITCH DIMENSIONS IN INCHES [MM]

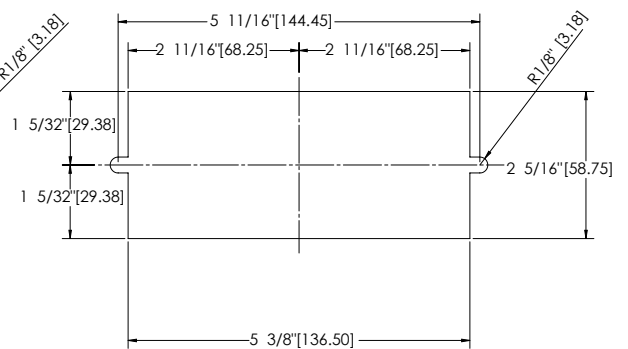

OPTIONAL ACCESSORIES

FMS
Test Switches



FMS Back Covers

See page 64 for **Back Cover Ordering Information.**

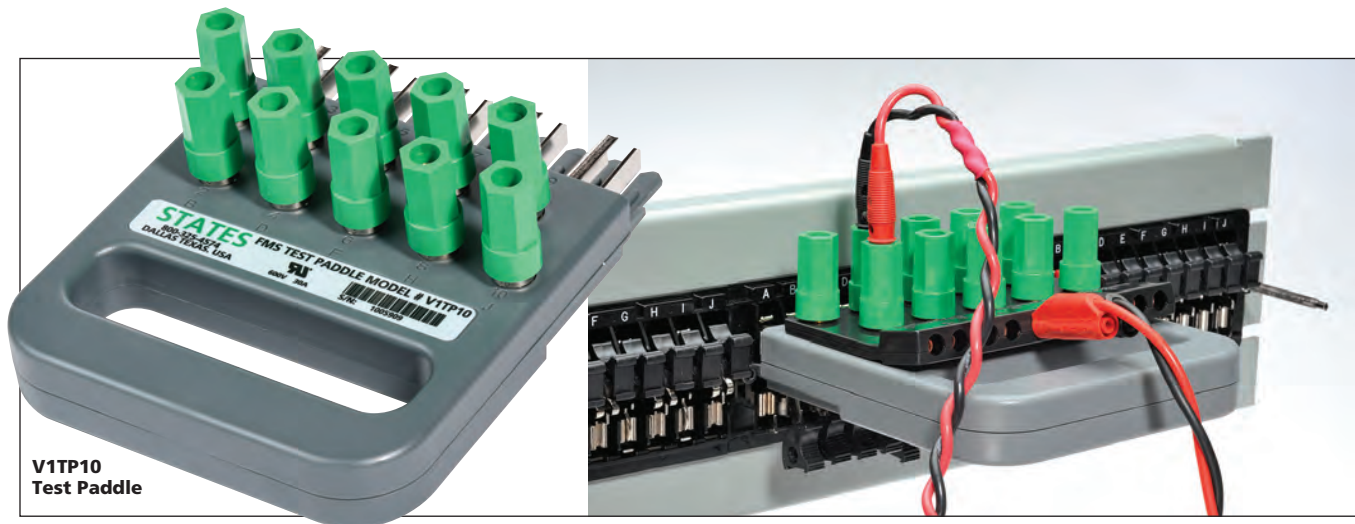

V1TP10
Test Paddle

15000 Dual Circuit Plug



See Testing Accessories on page 128

FRONT VIEW

6-POLE

26-26-26-26-1-1-1-1-1-1

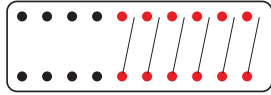

FMS-06A

26-26-26-26-2-2-2

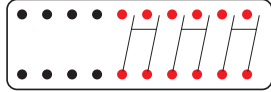

FMS-06B

26-26-26-26-1-1-1-10-1

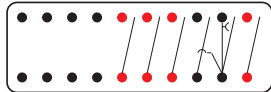

FMS-06C

26-26-26-26-9-9-9-9-9-9

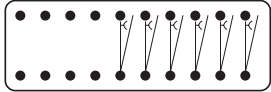

FMS-06D

26-26-26-26-1-1-10-10

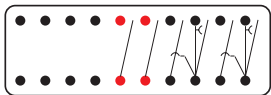

FMS-06E

26-26-26-26-10-10-10

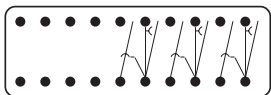

FMS-06F

7-POLE

26-26-26-1-1-1-1-1-1-1-1

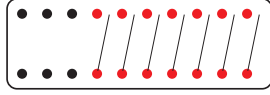

FMS-07A

26-26-26-9-9-9-9-9-9-9-9

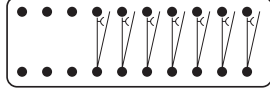

FMS-07B

26-26-26-1-10-1-10-1

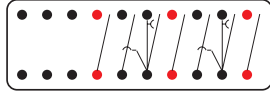

FMS-07C

26-26-26-1-1-1-10-10

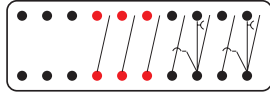

FMS-07D

26-26-26-1-10-10-10

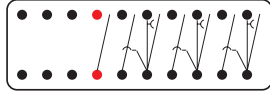

FMS-07E

8-POLE

26-26-1-1-1-1-1-1-1-1-1

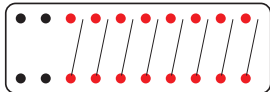

FMS-08A

26-26-2-2-2-2

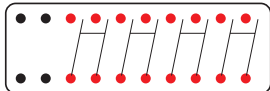

FMS-08B

26-26-9-9-9-9-9-9-9-9

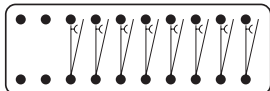

FMS-08C

26-26-1-10-1-1-10-1

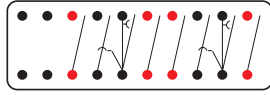

FMS-08D

26-26-1-1-1-10-1-10

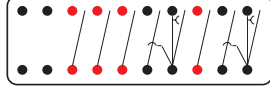

FMS-08E

26-26-10-10-10-10

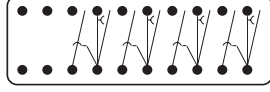

FMS-08F

9-POLE

26-1-1-1-1-1-1-1-1-1-1

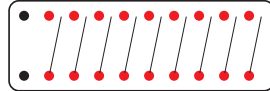

FMS-09A

26-16-16-16

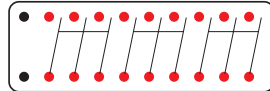

FMS-09B

26-9-9-9-9-9-9-9-9-9

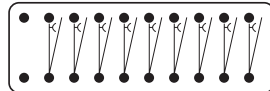

FMS-09C

26-1-10-1-10-1-10

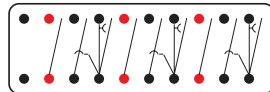

FMS-09D

26-1-1-1-10-10-10

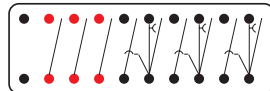

FMS-09E

10-POLE

1-1-1-1-1-1-1-1-1-1-1

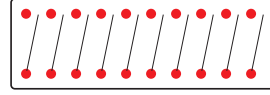

FMS-10A

9-9-9-9-9-9-9-9-9-9

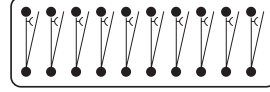

FMS-10B

1-10-1-10-1-10-1



FMS-10C

1-1-1-1-10-10-10



FMS-10D

1-1-1-10-10-10-1

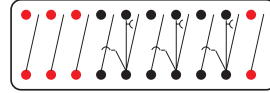

FMS-10E

10-10-10-10-10

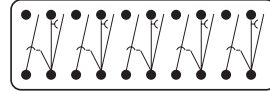

FMS-10F

FMS Semiflush-Mounted Test Switches

FMS Test Switches

FMS 10 Pole Test Switches

Part Number	Arrangement	R19 Rack Code
FMS-06A	26-26-26-26-1-1-1-1-1-1	06A
FMS-06A1	26-26-26-26-1K-1K-1K-1K-1K-1K	6A1
FMS-06B	26-26-26-26-2-2-2	06B
FMS-06C	26-26-26-26-1-1-1-10-1	06C
FMS-06D	26-26-26-26-9-9-9-9-9-9	06D
FMS-06E	26-26-26-26-1-1-10-10	06E
FMS-06F	26-26-26-26-10-10-10	06F
FMS-06G	1K-1K-1K-1K-26-26-26-26-1K-1K	06G
FMS-06H	1K-1K-1K-26-26-26-26-1K-1K-1K	06H
FMS-06I	26-26-26-1K-1K-1K-1K-1K-1K-26	06I
FMS-06J	1K-26-26-26-26-1K-1K-10-1K	06J
FMS-06K	1K-1K-26-26-26-26-9-10-1K	06K
FMS-06L	1K-26-26-26-26-10-10-1K	06L
FMS-06M	9-26-9-26-9-26-26-9-9-9	06M
FMS-06N	26-10-26-10-26-10-26	06N
FMS-06P	26-26-9-9-9-9-9-9-26-26	06P
FMS-06Q	26-26-26-10-10-10-26	06Q
FMS-06R	26-26-26-9-9-9-9-9-26	06R
FMS-06S	1K-26-26-26-26-1K-1K-10R-1K	06S
FMS-06T	26-26-26-10R-10R-10R-26	06T
FMS-06U	26-9-9-9-26-26-1-1-1-26	06U
FMS-06V	26-26-26-26-2K-2K-2K	06V
FMS-06W	26-26-10-2-2-26-26	06W
FMS-06X	26-26-26-10KE-10KG-10KR-26	06X
FMS-06Y	1K-1K-1K-1K-1K-1K-26-26-26-26	06Y
FMS-06Z	26-26-1-1-9-9-9-9-26-26	06Z
FMS-06AB	26-2-26-2-26-2-26	6AB
FMS-06AC	26-26-26-26-#1-1-1-1-#10#	6AC
FMS-06AD	26-1-1-26-1-1-26-10-26	6AD
FMS-06AE	26-1-1W-26-1-1W-26-1-1W-26	6AE
FMS-06AF	10-10-10-26-26-26-26	6AF
FMS-06AG	#1-1-1-1-#2-26-26-26-26	6AG
FMS-06AH	16-1-2-26-26-26-26	6AH
FMS-06AJ	2K-1-1Y-1B-1W-26-26-26-26	6AJ
FMS-06AK	2K-2K-2K-26-26-26-26	6AK
FMS-06AL	26-26-26-26-10-1B-1B-2	6AL
FMS-06AM	16Y-26-26-26-26-16B	6AM
FMS-06AN	1B-1B-1-1-1-1-26-26-26-26	6AN
FMS-06AO	1B-1B-1-1-1Y-1Y-26-26-26-26	6AO
FMS-06AP	1K-1K-1K-1-1-1K-26-26-26-26	6AP
FMS-06AQ	16-26-26-26-26-16	6AQ
FMS-06AR	1-1-1-1-2K-26-26-26-26	6AR
FMS-06AS	1-1-1-1-1-1-26-26-26-26	6AS
FMS-06AT	2-2-2-26-26-26-26	6AT
FMS-06AU	26-26-26-10EK-10EK-10EK-26	6AU
FMS-06AV	1B-1B-1B-1B-1B-1B-26-26-26-26	6AV
FMS-06AW	1-16-10-26-26-26-26	6AW
FMS-06AX	1Y-1Y-26-26-1G-1G-1Y-1Y-26-26	6AX
FMS-06AY	1W-1W-26-26-1K-1K-26-26-1W-1W	6AY
FMS-06AZ	#6-6-6-6-1K-1K-26-26-26-26	6AZ
FMS-06BA	#9-9-9-9-1-1-#26-26-26-26	6BA
FMS-06BC	1-1-1-1-26-26-26-26-1-1	6BC

FMS 10 Pole Test Switches

Part Number	Arrangement	R19 Rack Code
FMS-06BD	1-1-26-26-1-1-26-26-1-1	6BD
FMS-06BE	2-26-2-26-2-26-26	6BE
FMS-06BF	10R-10R-10R-26-26-26-26	6BF
FMS-06BL	10-9-26-10-9-26-26-26	6BL
FMS-06BM	1-1-1-1-26-1-1-26-26-26	6BM
FMS-06BN	1-1-26-1-1-1-1-26-26-26	6BN
FMS-06BO	24-1K-1K-1K-1-1-26-26-26-26	6BO
FMS-06BP	26-26-26-26-1W-1W-1W-1W-1W-1W	6BP
FMS-07A	26-26-26-1-1-1-1-1-1-1	07A
FMS-07B	26-26-26-9-9-9-9-9-9-9	07B
FMS-07C	26-26-26-1-10-1-10-1	07C
FMS-07D	26-26-26-1-1-1-10-10	07D
FMS-07E	26-26-26-1-10-10-10	07E
FMS-07F	1K-1K-1K-1K-26-26-1K-1K-1K-26	07F
FMS-07G	1K-1K-1K-1K-26-26-26-1K-1K-1K	07G
FMS-07H	26-1K-1K-1K-1K-1K-1K-26-26	07H
FMS-07I	1K-26-26-1K-1K-1K-1K-1K-26	07I
FMS-07J	1K-26-26-1K-1K-1K-26-1K-1K-1K	07J
FMS-07K	1K-1K-1K-1K-1K-26-26-10-26	07K
FMS-07L	1K-1K-26-26-26-10-1K-1K-1K	07L
FMS-07M	1K-10-1K-26-26-26-1K-1K-1K	07M
FMS-07N	1K-1K-9-26-9-26-9-26-1K-1K	07N
FMS-07P	1K-1K-1K-26-26-10-10-26	07P
FMS-07Q	1K-1K-26-26-26-10-10-1K	07Q
FMS-07R	1K-9-9-26-9-26-9-26-1K-1K	07R
FMS-07S	26-26-26-9-10-10-10	07S
FMS-07T	26-26-26-1-1-1-1-10-1	07T
FMS-07U	26-26-26-1-#10#-1-#10#-1	07U
FMS-07V	1K-1K-1-1-1-1-1-26-26-26	07V
FMS-07W	1K-1K-1K-1K-1K-1K-26-26-26	07W
FMS-07X	26-26-26-24-1-1-10-10	07X
FMS-07Y	1-1-1-26-10-26-26-10	07Y
FMS-07Z	1-10-10-10-26-26-26	07Z
FMS-07AB	1-1-1-1-1-1-1-26-26-26	7AB
FMS-07AC	10-10-10-9-26-26-26	7AC
FMS-07AD	26-26-9-10-10-10-26	7AD
FMS-07AE	1-1-26-26-1-1-26-10-9	7AE
FMS-07AF	26-26-26-1-24-1-10-10	7AF
FMS-07AG	10R-10R-10R-9R-26-26-26	7AG
FMS-07AH	26-26-26-1-13-13-13	7AH
FMS-07AJ	1K-1K-1K-1K-26-26-1K-1K-26-1K	7AJ
FMS-07AK	26-26-26-10-10-10-1	7AK
FMS-07AL	1W-1W-1W-1Y-1Y-1-1-26-26-26	7AL
FMS-07AP	2-2-16-26-26-26	7AP
FMS-07AQ	1-1-1-10-26-26-10-26	7AQ
FMS-07AS	11-11-11-9-26-26-26	7AS
FMS-08A	26-26-1-1-1-1-1-1-1-1	08A
FMS-08B	26-26-2-2-2-2	08B
FMS-08C	26-26-9-9-9-9-9-9-9	08C
FMS-08D	26-26-1-10-1-1-10-1	08D

Color Key: k: Black b: Blue g: Green e: Orange r: Red w: White n: Brown y: Yellow p: Purple

FMS 10 Pole Test Switches

Part Number	Arrangement	R19 Rack Code
FMS-08E	26-26-1-1-1-10-1-10	08E
FMS-08F	26-26-10-10-10-10	08F
FMS-08G	26-10-10-10-10-26	08G
FMS-08H	1K-1K-1K-1K-1K-26-26-1K-1K-1K	08H
FMS-08I	1K-1K-1K-1K-26-26-1K-1K-1K-1K	08I
FMS-08J	1K-26-26-1K-1K-1K-1K-1K-1K-1K	08J
FMS-08K	1K-1K-1K-1K-1K-26-26-10-1K	08K
FMS-08L	1K-1K-1K-26-26-10-1K-1K-1K	08L
FMS-08M	1K-1K-1K-1K-26-10-10-26	08M
FMS-08N	1K-1K-26-9-9-9-9-26-1K-1K	08N
FMS-08P	1K-1K-26-10-10-26-1K-1K	08P
FMS-08Q	1K-10-1K-26-26-1K-10-1K	08Q
FMS-08R	26-26-1K-1K-1K-10-10-1K	08R
FMS-08S	26-10-10-10-1K-1K-26	08S
FMS-08T	26-10-10-10-26-1K-1K	08T
FMS-08U	1K-26-9-10-10-10-26	08U
FMS-08V	9-9-9-9-26-26-9-9-9-9	08V
FMS-08W	26-9-9-9-9-9-9-9-26	08W
FMS-08X	1B-1B-1B-1B-26-26-1B-1B-1B-1B	08X
FMS-08Y	1K-1K-26-10R-10R-26-1K-1K	08Y
FMS-08Z	1K-10R-1K-26-26-1K-10R-1K	08Z
FMS-08AB	10-10-10-10-26-26	8AB
FMS-08AC	1-1-1-1-26-26-1-1-1-1	8AC
FMS-08AD	26-26-#1-9-10-10-10#	8AD
FMS-08AE	26-9-9-9-9-9-26-1K-1K	8AE
FMS-08AF	26-26-1-1K-1B-1B-1B-1B-1B-1B	8AF
FMS-08AG	26-26-1E-1E-1E-1E-1E-1E-1E-1E	8AG
FMS-08AH	26-26-10-10-10-1-1	8AH
FMS-08AI	1-1-1-24-26-26-1-1-1-24	8AI
FMS-08AJ	26-10R-10R-10R-10R-26	8AJ
FMS-08AK	26-26-1-1-1-1-1-1-1G-1G	8AK
FMS-08AL	10-10-10-2-26-26	8AL
FMS-08AM	26-26-1-1-10-10-10	8AM
FMS-08AN	26-26-9-9-9-#6-6-6-6#-24	8AN
FMS-08AP	1K-1K-2K-1-1Y-1B-1W-26-26	8AP
FMS-08AQ	2K-2K-2K-2K-26-26	8AQ
FMS-08AR	1B-1B-1B-1B-1B-1B-1B-26-26	8AR
FMS-08AS	10-10-1G-1-1-1-26-26	8AS
FMS-08AT	26-1-1-1Y-1Y-1Y-1Y-1Y-26	8AT
FMS-08AU	2K-2K-2K-1-1-26-26	8AU
FMS-08AV	10-10-10-1-1-26-26	8AV
FMS-08AW	26-26-1-1-1-1-10-10	8AW
FMS-08AX	1K-1K-1K-1K-26-26-1K-1K-1K-1	8AX
FMS-08AZ	1B-1B-1-1-#6-6-6#-9-26-26	8AZ
FMS-08XY	1K-1-1-10-10-26-26-1	8XY
FMS-08BA	1K-1K-1K-1-1-1-1-1K-26-26	8BA
FMS-08BB	26-26-2-16-16	8BB
FMS-08BC	26-10-10B-10R-10E-26	8BC
FMS-08BD	10-10-10-26-26-2	8BD
FMS-08BE	26-10EK-10EK-10EK-10EK-26	8BE
FMS-08BF	10-10-10-26-26-1K-1K	8BF
FMS-08BG	1K-1K-1K-1K-1K-1K-1K-26-26	8BG

FMS 10 Pole Test Switches

Part Number	Arrangement	R19 Rack Code
FMS-08BH	10-10-26-26-10-10	8BH
FMS-08BI	26-26-1K-1K-1K-1K-1-1-1K	8BI
FMS-08BJ	1-1-1-1-1-1-1-1Y-26-26	8BJ
FMS-08BK	#10-10-10-10#-26-26	8BK
FMS-08BL	1-1-1-1-1-1-1-26-26	8BL
FMS-08BM	1-1-10-1-1-10-26-26	8BM
FMS-08BN	1-1Y-1B-1K-26-26-1-1Y-1B-1K	8BN
FMS-08BO	2K-2K-2K-10-26-26	8BO
FMS-08BP	6-6-6-9-1K-1K-1K-1K-26-26	8BP
FMS-08BQ	26-26-10R-10R-10R-10R	8BQ
FMS-08BR	26-10W-10W-10W-10W-26	8BR
FMS-08BS	1-1-1-1-6-24-6-24-26-26	8BS
FMS-08BT	10-10-10-26-26-1-1	8BT
FMS-08BU	#10-10-10#-24-24-26-26	8BU
FMS-08BV	#13R-13R-13R-1K-1K#-26-26	8BV
FMS-08BW	10-26-26-10-10-10	8BW
FMS-08BX	6-6-6-9-6-6-6-9-26-26	8BX
FMS-08BY	26-10-10-10-26-10	8BY
FMS-08BZ	10-26-26-2-2-2	8BZ
FMS-08CA	1-1-1-1W-26-26-1B-1B-1B-1W	8CA
FMS-08CB	1-1-1-1-#6-6-6-5#-26-26	8CB
FMS-08CC	13-13-13-13-26-26	8CC
FMS-08CE	10-10-10-26-26-10	8CE
FMS-08CF	10-10G-10R-26-26-1Y-1Y	8CF
FMS-08CH	1B-1B-1B-1B-1B-1B-26-26-1B-1B	8CH
FMS-08CI	1B-1B-1B-1B-1B-1B-26-26-1-1	8CI
FMS-08CJ	10-10-10-24-24-26-26	8CJ
FMS-08CK	1-1-1-1-26-1-1-1-1-26	8CK
FMS-08CL	26-1-1-1-1-1-1-1-26	8CL
FMS-08CM	1K-1K-1K-1K-26-1K-1K-26-1K-1K	8CM
FMS-08CN	9-9-9-9-1K-26-26-16	8CN
FMS-08CO	1Y-1G-1-1B-1Y-1G-1-1B-26-26	8CO
FMS-08CP	1-1-1-26-1-1-1-26-10	8CP
FMS-08CQ	16-10-10G-10R-10W-26	8CQ
FMS-08CR	#6-6W-6R-5G#-13-13-26-26	8CR
FMS-08CS	#13-13W-13R-13G#-26-26	8CS
FMS-08CT	#1K-1W-1-1G#2K-2K-26-26	8CT
FMS-08CU	13-#1K-1W-1-1G#-2K-26-26	8CU
FMS-08CV	#6-6W-6R-5G#-#6-6W-6R-5G#-26-26	8CV
FMS-08CX	1-1-1-1-26-26-1K-1K-1K-1K	8CX
FMS-09A	26-1-1-1-1-1-1-1-1-1	09A
FMS-09AB	10-10-10-9-26-1K-1K	9AB
FMS-09AC	26-10-10-10-10-1	9AC
FMS-09AD	1-1-26-10-10-10-24	9AD
FMS-09AE	1K-1K-1K-26-10-10-10	9AE
FMS-09AF	10R-10R-10R-9R-26-10R	9AF
FMS-09AG	1-1-1-10-1-1-10-26	9AG
FMS-09AH	1K-24-1K-10-10-10-26	9AH
FMS-09AI	1-1-1-1-24-1-1-1-24-26	9AI
FMS-09AJ	10-10-10-10-24-26	9AJ
FMS-09AK	1K-1K-1K-1K-1K-1K-1K-26-1K	9AK

Color Key: k: Black b: Blue g: Green e: Orange r: Red w: White n: Brown y: Yellow p: Purple

FMS Test Switches

FMS Semiflush-Mounted Test Switches

FMS Test Switches

FMS 10 Pole Test Switches

Part Number	Arrangement	R19 Rack Code
FMS-09AL	1-2-2-2-2-26	9AL
FMS-09AM	1-1-10-10-26-1-1-1	9AM
FMS-09AN	1-1W-26-1-1-1-#6-6-6-1K#	9AN
FMS-09AO	1-1-1-1W-1-26-1B-1B-1B-1B	9AO
FMS-09AP	10-10-10-1K-1K-1K-26	9AP
FMS-09AR	#10-10-10#-26-16K	9AR
FMS-09AS	1K-16K-26-1K-1K-1K-1K-1K	9AS
FMS-09AT	1K-#1K-1K-13#-26-1K-1K-1K-1K	9AT
FMS-09AU	13-13-13-9-9-9-26	9AU
FMS-09AV	10-10-10-1-1-1-26	9AV
FMS-09AW	9-9-9-9-1-1-1-1-1-26	9AW
FMS-09AY	#10-1K#-#10-1K#-#10-1K#-26	9AY
FMS-09AZ	9-9-9-9-1K-1K-26-16K	9AZ
FMS-09B	26-16-16-16	09B
FMS-09BA	10-10-10-1Y-1Y-1Y-26	9BA
FMS-09BB	10-10-10-9-26-10	9BB
FMS-09BC	10-10-9-26-10-10	9BC
FMS-09BD	10-10-9-26-1-1-1-1	9BD
FMS-09BE	1Y-1E-1E-10-10-10-26	9BE
FMS-09BF	1K-#1K-1K-13#-26-#1K-1K-1K#-1K	9BF
FMS-09BH	10-10-10-10-26-1	9BH
FMS-09BI	1K-1G-1-1W-26-1W-1W-1W-1B-1B	9BI
FMS-09BJ	26-10-9-10-10-10	9BJ
FMS-09C	26-9-9-9-9-9-9-9-9	09C
FMS-09D	26-1-10-1-10-1-10	09D
FMS-09E	26-1-1-1-10-10-10	09E
FMS-09F	1K-1K-1K-1K-26-1K-1K-1K-1K-1K	09F
FMS-09G	1K-1K-26-1K-1K-1K-1K-1K-1K-1K	09G
FMS-09H	1K-1K-1K-1K-1K-26-10-9-1K	09H
FMS-09I	1K-1K-1K-1K-1K-10-10-26	09I
FMS-09J	1K-1K-1K-1K-26-10-10-1K	09J
FMS-09K	1K-1K-26-10-10-10-1K	09K
FMS-09L	9-10-10-10-10-26	09L
FMS-09M	1-10-10-10-10-26	09M
FMS-09N	26-#1-1-1-#10-10-10#	09N
FMS-09P	16-10-10-10-26	09P
FMS-09Q	1B-1B-1B-1B-1B-1B-1B-1B-26	09Q
FMS-09R	26-16K-16K-16K	09R
FMS-09S	9-9-9-#6-6-6-6#-9-9-26	09S
FMS-09T	1-1-1-10-10-10-26	09T
FMS-09U	#10-10-10#-26-16	09U
FMS-09V	1-1K-1K-1K-1K-1K-1K-10-26	09V
FMS-09W	10-26-1-10-10-10	09W
FMS-09X	1-1G-1-26-10-10-10	09X
FMS-09Y	#1K-1K-1K-1K#-#6-6-6-6#-24-26	09Y
FMS-09Z	2-26-9-10-10-10	09Z
FMS-10A	1-1-1-1-1-1-1-1-1-1	10A
FMS-10A1	1K-1K-1K-1K-1K-1K-1K-1K-1K-1K	0A1
FMS-10A1A	10R-10R-1E-1E-1E-1E-1E-1E	A1A
FMS-10A1B	1E-1E-10E-1E-1E-1E-1E-10E	A1B
FMS-10A1C	1E-1E-1K-1K-1K-1K-1E-1E-1E-1E	A1C

FMS 10 Pole Test Switches

Part Number	Arrangement	R19 Rack Code
FMS-10A1D	1K-1K-1K-1K-1K-1E-1E-1E-1E-1E	A1D
FMS-10A1E	10E-1E-1E-10E-1E-1E-10E	A1E
FMS-10A2	1B-1B-1B-1B-10-10-10	0A2
FMS-10A3	10-1-1-1-1-1-1-1-1-1	0A3
FMS-10A4	1K-1Y-1K-1K-1K-1-1-1-1-1	0A4
FMS-10A5	1W-1K-1K-1K-1K-1K-1K-1K-1K-1K	0A5
FMS-10A6	1N-1N-1Y-1Y-1Y-1Y-1E-1E-10	0A6
FMS-10A7	1-1-1-1-#10#-#10#-#10#	0A7
FMS-10A9	10-10-10-1-1G-10	0A9
FMS-10AA	6-6-6-9-1-1-1-1-1K-1K	0AA
FMS-10AB	1-10-10-10-10-1	0AB
FMS-10AC	10-9-9-9-9-9-9-1-1	0AC
FMS-10AD	10-10-10-1K-1K-1K-1	0AD
FMS-10AE	#1-1-1-1-1#-1-1-1-1-1	0AE
FMS-10AF	1-1-1-10-10-1-1-1	0AF
FMS-10AG	10-1K-1K-1K-1K-1K-1K-1K-1	0AG
FMS-10AH	1E-1E-1E-1E-1E-1E-1E-1E-1E	0AH
FMS-10AI	10-1-1-1-1K-1K-1K-1K-1K	0AI
FMS-10AJ	1-1-1K-1K-1K-1K-1K-1K-1-1	0AJ
FMS-10AK	1-1K-1-1K-1K-1K-1K-1-1K-1	0AK
FMS-10AL	1E-1E-1-1-1-1-1K-1K-1K-1K	0AL
FMS-10AM	2-1-1-10-10-10	0AM
FMS-10AN	6-6-6-9/6-6-90-1K-1K	0AN
FMS-10AP	1K-1-1K-1-1K-1-1K-1K-1K-1K	0AP
FMS-10AQ	1-1-1-1E-1E-1E-1E-1E-1E-1E	0AQ
FMS-10AR	1B-1B-10-10-10-10G	0AR
FMS-10AS	1-1K-1B-1B-10-10-10	0AS
FMS-10AT	1E-1E-1E-1E-10-10-10	0AT
FMS-10AU	1-1K-10-10-10-10	0AU
FMS-10AV	1W-1B-1B-1E-1E-1E-1E-1E-1E	0AV
FMS-10AW	1W-1E-1E-1E-10-10-10	0AW
FMS-10AX	1G-1G-1G-1G-1G-1W-1W-1W-1W-1W	0AX
FMS-10AY	2K-2K-2K-#1K-1K-1K-1K#	0AY
FMS-10AZ	#1K-1K-1K-1K#-13-13-13	0AZ
FMS-10B	9-9-9-9-9-9-9-9-9-9	10B
FMS-10B1	10-1W-1K-1B-1B-1-1-1-1	0B1
FMS-10B2	1B-1B-1-1-1B-1B-1-1-1B-1B	0B2
FMS-10B3	1-1-1B-1B-1-1-1B-1B-1-1	0B3
FMS-10B4	10-1-1-1-1-1W-1K-1B-1B	0B4
FMS-10B5	1K-1-1K-1K-1K-1K-1K-1K-1K-1K	0B5
FMS-10B6	1K-1-1K-1K-1K-1-1K-1K-1K-1K	0B6
FMS-10B7	1-1-1-1-1-1-1-1-1-1K	0B7
FMS-10B8	1E-1E-1E-10-10-10-1E	0B8
FMS-10B9	#10-10-10#-1B-1B-2K	0B9
FMS-10BA	1B-1B-1B-1B-1B-1B-1B-1K-1K	0BA
FMS-10BC	1-13-1-13-1-13-1	0BC
FMS-10BD	1Y-1K-1K-1K-1K-1K-1K-1K-2K	0BD
FMS-10BE	2K-1B-1B-1B-1B-1B-2K	0BE
FMS-10BF	1Y-1-1-1-1-1-1-1-1-1	0BF
FMS-10BG	1K-1W-10-10-10-2	0BG
FMS-10BH	1-1-1-1G-10-10-10	0BH
FMS-10BI	1W-1W-10-10-10-10	0BI

Color Key: k: Black b: Blue g: Green e: Orange r: Red w: White n: Brown y: Yellow p: Purple

FMS 10 Pole Test Switches

Part Number	Arrangement	R19 Rack Code
FMS-10BJ	1-1-1-1G-1Y-1B-1Y-1E-1E-1Y	OBJ
FMS-10BK	1W-1W-1-1-1Y-1B-1Y-1E-1E-1K	OBK
FMS-10BL	1W-1W-1E-1E-10-10-10	OBL
FMS-10BM	1K-1Y-1Y-1K-10-10-10	OBM
FMS-10BN	1W-1W-1Y-1E-10-10-10	OBN
FMS-10BO	2-2-2-2Y-2Y	OBO
FMS-10BP	2Y-2Y-2Y-2Y-2	OBP
FMS-10BQ	2-2-2W-2W-2BN	OBQ
FMS-10BR	2Y-2-2-2-2	OBR
FMS-10BS	2-2-2-2-2BN	OBS
FMS-10BT	2Y-2Y-2-2-2BN	OBT
FMS-10BU	1W-1W-1-1-1-1G-1K-1K-1K-1Y	OBU
FMS-10BV	1W-1W-1E-1E-1Y-1Y-1B-1B-1Y-1W	OBV
FMS-10BW	1W-1W-1Y-1K-1K-1K-1K-1K-1K-1K	OBW
FMS-10BX	1W-1Y-1Y-1E-10-10-10	OBX
FMS-10BY	1W-1W-1K-1K-1K-1K-1K-1K-1K-1K	OBY
FMS-10BZ	1K-1Y-1Y-1Y-10-10-10	OBZ
FMS-10C	1-10-1-10-1-10-1	10C
FMS-10C1	1K-10-1K-10-1K-10-1K	OC1
FMS-10C2	1B-1B-1B-1B-1-1-1B-1B-1B-1B	OC2
FMS-10C3	1-1-1B-1B-1B-1B-1-1-1B-1B	OC3
FMS-10C4	1B-1B-1-1-1B-1B-1-1-1-1	OC4
FMS-10C5	10R-10Y-10B-10R-10Y	OC5
FMS-10C6	10B-10R-10Y-10B-10R	OC6
FMS-10C7	10Y-10B-10R-10Y-10B	OC7
FMS-10C8	1K-1K-1K-1B-1B-1Y-1Y-1-1-1	OC8
FMS-10C9	1-1-1-1W-1K-1K-1K-1K-1K-1K	OC9
FMS-10CA	6-6-6-9-1-6-6-6-9-1	OCA
FMS-10CB	1K-1K-1K-1K-1E-1E-1E-1E-1E-1E	OCB
FMS-10CC	1-1Y-1B-1G-10-10-10	OCC
FMS-10CD	#1-1-10-1-10-1-10#	OCD
FMS-10CE	1E-1E-1E-1E-1E-1E-1E-1W-1W	OCE
FMS-10CF	10B-10B-10B-1K-1K-1K-1K	OCF
FMS-10CG	10Y-10Y-10Y-10G-1K-1K	OCG
FMS-10CH	1K-1K-1-1-10E-10E-10E	OCH
FMS-10CI	10Y-10Y-10Y-1K-1K-1K-1K	OCI
FMS-10CJ	1-1K-1B-10R-10-10B-1W	OCJ
FMS-10CK	1B-10R-1B-10R-1B-10R-1B	OCK
FMS-10CL	#1K-1K-1K-1K#-2K-2K-2K	OCL
FMS-10CM	#10-10-10#-1K-1K-1K-1K	OCM
FMS-10CN	#10#-1K-1K-1K-1K-1K-1K-2K	OCN
FMS-10CO	1-1K-1K-1K-1K-1K-1K-1-1	OCO
FMS-10CP	1K-1K-1K-1K-1K-1K-10R-1K	OCP
FMS-10CQ	1W-1W-1Y-1B-10-10-10	OCQ
FMS-10CR	1K-1Y-1Y-1E-10-10-10	OCR
FMS-10CS	1-9-9-9-9-9-9-9-1	OCS
FMS-10CT	16-10-10-10-1	OCT
FMS-10CU	1B-1B-1G-1G-1W-1W-1Y-1Y-1Y-1Y	OCU
FMS-10CV	1W-1W-1Y-1Y-1Y-1Y-1Y-1Y-1Y	OCV
FMS-10CW	1Y-1Y-1Y-1Y-1K-1K-1-1-1-1	OCW
FMS-10CX	1K-1-1-1-1-1-1-1-1-1	OCX
FMS-10CY	10Y-10Y-10Y-10Y-10Y	OCY

FMS 10 Pole Test Switches

Part Number	Arrangement	R19 Rack Code
FMS-10CZ	1B-1B-1B-10Y-10Y-10Y-1B	OCZ
FMS-10D	1-1-1-1-10-10-10	10D
FMS-10D1	1-1-1-1G-1G-1G-1K-1K-1K-1W	OD1
FMS-10D2	1W-1K-1-1-1-1-1-1-1	OD2
FMS-10D3	1W-1K-1-1-10-10-10	OD3
FMS-10D4	1B-1W-1-1K-10B-10W-10R	OD4
FMS-10D5	10EK-10EK-10EK-2-2	OD5
FMS-10D6	1-1-1-1-1B-1B-1B-1B-1W-1K	OD6
FMS-10D7	1-1-10-1-1-1-1-1-1	OD7
FMS-10D8	1-1-1-1-10-10-1-1	OD8
FMS-10D9	1-1-1-1-10-1-1-1-1	OD9
FMS-10DA	1K-1K-1K-10Y-10Y-10Y-1K	ODA
FMS-10DB	1K-1K-1K-1K-1K-1K-10Y-1K	ODB
FMS-10DC	1E-1E-1E-1E-1E-1E-1Y-1Y-1Y-1Y	ODC
FMS-10DD	10R-10R-10R-1E-1E-1E-1E	ODD
FMS-10DE	1K-1K-1K-1K-1B-1B-1B-1B-1B	ODE
FMS-10DF	10R-10R-10R-1K-1K-1K-1K	ODF
FMS-10DG	1-1-1-1K-1K-1K-1-1-1	ODG
FMS-10DH	10R-1K-1K-10-10-10	ODH
FMS-10DI	#10-10-10#-10-2K	ODI
FMS-10DJ	#1K-1K-1K-1K#-1-1-1-1-1-1	ODJ
FMS-10DK	1Y-1B-1B-1B-1B-1B-1B-2K	ODK
FMS-10DL	1B-1B-1B-10R-10R-10R-1B	ODL
FMS-10DM	1E-1W-1K-1K-1K-1K-1K-1K-1K	ODM
FMS-10DN	1-1K-1K-10-10-10-1K	ODN
FMS-10DO	10B-10B-10B-10B-1W-1W	ODO
FMS-10DP	1Y-1Y-1Y-1Y-1Y-1Y-1-1-1K-1K	ODP
FMS-10DQ	1K-1K-1-1-1K-1K-1K-1E-1E	ODQ
FMS-10DR	10-10-10-1E-1E-1E-1E	ODR
FMS-10DS	10-10-10-1-1K-1B-1B	ODS
FMS-10DT	1K-1K-1K-1K-1K-1K-10R-10R	ODT
FMS-10DU	1-1-1W-1K-1B-1B-1-1-1-1	ODU
FMS-10DV	1-1W-1W-1W-1W-1K-1K-1K-1K	ODV
FMS-10DW	10W-10W-10W-1W-1W-1W-1W	ODW
FMS-10DX	10-9-9-9-9-9-9-9-9	ODX
FMS-10DY	9-9-9-9-1-1-1-1-1-1	ODY
FMS-10DZ	1-1-1-1-2K-#1K-1K-1K-1K#	ODZ
FMS-10E	1-1-1-10-10-10-1	10E
FMS-10E1	1K-1K-1K-10-10-10-1K	OE1
FMS-10E2	10-10-10-1-1-1-1	OE2
FMS-10E3	10-10-10-10-1-1	OE3
FMS-10E4	1K-10-10-10-10-1K	OE4
FMS-10E6	1-1K-1E-1E-10-10-10	OE6
FMS-10E7	1W-1B-1B-1E-1E-1E-1E-1-1K	OE7
FMS-10E9	2B-10-10-10-10	OE9
FMS-10EA	9-9-9-9-9-9-1K-1K-1K-1K	0EA
FMS-10EB	1-1-1-1-2K-1K-1K-1K-1K	0EB
FMS-10EC	1W-1K-1B-1B-1B-1B-1B-1-1	0EC
FMS-10ED	10-10-10-1-1-1B-1B	0ED
FMS-10EE	10B-10B-10B-1B-1B-1B-1B	0EE
FMS-10EF	10B-10B-10B-10B-1B-1B	0EF
FMS-10EG	1K-1K-1K-1-1K-1-1K-1-1K-1K	0EG

Color Key: k: Black b: Blue g: Green e: Orange r: Red w: White n: Brown y: Yellow p: Purple

FMS Semiflush-Mounted Test Switches

FMS Test Switches

FMS 10 Pole Test Switches

Part Number	Arrangement	R19 Rack Code
FMS-10EH	6-6-6-9-10-6-6-6-9	0EH
FMS-10EJ	10R-10R-10R-10R-1K-1K	0EJ
FMS-10EL	1K-1K-10-10-10-10	0EL
FMS-10EM	#1K-1K-1K-1K-1K-1K-1K-1K-1K-1K#	0EM
FMS-10EN	2-2-2-#1K-1K-1K-1K#	0EN
FMS-10EO	1-1-1-1-1-1-1-1-1-1Y	0EO
FMS-10EP	#1K-1K-1K-1K#-1B-1B-1B-1B-1B-1B	0EP
FMS-10EQ	1B-1B-1B-1-1-1-1-1-1-1	0EQ
FMS-10ER	#10-10-10-10-1K-1K#	0ER
FMS-10ES	#10-10-10-1K-1K-1K-1K#	0ES
FMS-10ET	1W-1K-1B-1B-1B-1B-1-1-1-1	0ET
FMS-10EU	1-10-10-1-10-10	0EU
FMS-10EV	1-10-10-1-1-1-1-1	0EV
FMS-10EW	1-1-1W-1K-1B-1B-1B-1B-1-1	0EW
FMS-10EX	1K-1K-1K-1K-1K-1K-1K-1K-2K	0EX
FMS-10EY	1-1W-1-1K-1K-1K-1K-1B-1K	0EY
FMS-10EZ	10-1-1K-1K-1-1K-1K-1K-1K	0EZ
FMS-10F	10-10-10-10-10	10F
FMS-10F1	1K-1K-1K-1K-1K-1-1-1-1-1K	0F1
FMS-10F2	1K-1-1-1-1K-1-1-1-1-1	0F2
FMS-10F3	1K-1K-1K-1K-1K-1-1K-1-1-1	0F3
FMS-10F4	1K-1-1-1K-1K-1K-1K-1K-1K	0F4
FMS-10F5	1K-1-1K-1K-1K-1K-1K-1-1	0F5
FMS-10F6	1K-1-1K-1K-1K-1K-1-1-1	0F6
FMS-10F8	#1-1-1-1-1-1-1-1-1-1#-1K-1K	0F8
FMS-10F9	#1-1-1-1-1#-1K-1K-1K-1K-1K-1K	0F9
FMS-10FA	1-1K-1K-1K-1K-1K-1K-1K-1K-1K	0FA
FMS-10FB	1K-1K-10-10-10-1-1	0FB
FMS-10FC	1K-1K-1K-1K-1K-1K-1K-1-1	0FC
FMS-10FD	10-1B-10-10-10-1B	0FD
FMS-10FE	10E-10E-10E-10E-10E	0FE
FMS-10FF	10-10-10-1K-1K-1K-1K	0FF
FMS-10FG	1-1-1-1-1-1-1-1-10-1	0FG
FMS-10FH	1K-1K-1K-1K-1K-1K-1K-10-1	0FH
FMS-10FI	1-10-10-10-10-1K	0FI
FMS-10FJ	1K-1K-10-1K-1K-1K-1K-1K-1K	0FJ
FMS-10FK	1K-1K-1K-10-10-10-1	0FK
FMS-10FL	1-1K-1K-10-1K-1K-10-1K	0FL
FMS-10FM	1-10-10-10-1K-1K-1K	0FM
FMS-10FN	1B-1B-10-10-10-10	0FN
FMS-10FO	1N-1N-1-1-1-1-1-1-1-1	0FO
FMS-10FP	1-1-10-10-10-10	0FP
FMS-10FQ	# 1-1-1 #-10-10-10-1	0FQ
FMS-10FR	1K-1K-1K-1K-1K-1K-10-1K-1K	0FR
FMS-10FS	1-1G-10-10-10-10	0FS
FMS-10FT	1B-1B-1B-1B-1B-1B-1K-1K-1W-1W	0FT
FMS-10FU	1B-1B-1B-1B-1K-1K-1K-1K-1W-1W	0FU
FMS-10FV	1K-1K-1K-1K-1-1-1K-1K-1K-1K	0FV
FMS-10FW	1K-1K-1K-1K-1K-1K-1K-1K-10R	0FW
FMS-10FX	1K-1K-1K-1K-1K-1K-1K-1K-1K - 1	0FX
FMS-10FY	1-1K-1K-1K-1K-1K-1K-1K-1	0FY
FMS-10FZ	10-10-10-10-2	0FZ

FMS 10 Pole Test Switches

Part Number	Arrangement	R19 Rack Code
FMS-10G	10-10-10-10-1K-1K	10G
FMS-10G1	1-1-1-10-10-10-1Y	0G1
FMS-10G2	1-1-1-1-1-1-1-1E-1E-1Y-1Y	0G2
FMS-10G3	1-1-1-1-1-1-1-1Y-1Y-1Y-1Y	0G3
FMS-10G4	1-1-1-1-1E-1E-1E-1E-1Y-1Y	0G4
FMS-10G5	1-1-1-1-1W-1W-1E-1E-1E-1E	0G5
FMS-10G6	1B-1B-1-1-1-1-1-1-1Y-1Y	0G6
FMS-10G7	1B-1B-1-1-1-1-1E-1E-1Y-1Y	0G7
FMS-10G8	1N-1N-1-10-1E-1E-1E-1Y-1Y	0G8
FMS-10G9	1N-1N-1-1-1E-1E-1E-1Y-1Y-1Y	0G9
FMS-10GA	1-1-1-1-1-1-1K-1K-1K-1K	0GA
FMS-10GB	1K-1K-1K-1K-1K-1K-1K-10	0GB
FMS-10GC	10-10-10-1B-1B-1B-1B	0GC
FMS-10GD	1E-1G-1-1K-1E-1K-1K-1K-1K-1K	0GD
FMS-10GE	1E-1G-1-1K-1K-1E-1G-1-1K-1K	0GE
FMS-10GF	1E-1G-1-10KE-10KG-10KR-1K	0GF
FMS-10GG	6R-6R-6R-9R-1K-1K-1K-1K-1K-1K	0GG
FMS-10GH	1E-1E-1E-10-10-10-1G	0GH
FMS-10GI	1-1-1-24-10-10-10	0GI
FMS-10GJ	1K-1-1K-1K-1-1K-1K-1-1K-1K	0GJ
FMS-10GK	1K-1K-1K-1K-10-10-10	0GK
FMS-10GL	1K-1K-1K-1K-1-1-1-1-1-1	0GL
FMS-10GM	1-1-1K-1K-1K-1K-1K-1K-1K-1K	0GM
FMS-10GN	1K-1K-1K-1K-1K-1K-1K-1B-1B	0GN
FMS-10GO	10R-10R-10R-1Y-1Y-1Y-1Y	0GO
FMS-10GP	1-1-1-1-1-1-1B-1B-1B-1B	0GP
FMS-10GQ	#6-6-6-24#-#6-6-6-24#-1-1	0GQ
FMS-10GR	1B-1B-1B-1B-1B-1B-1K-1K-1K-1K	0GR
FMS-10GS	1K-1K-10-10-10-10	0GS
FMS-10GT	1B-1B-1B-1B-1B-1B-1B-1B-1B	0GT
FMS-10GU	10-1B-1B-1B-1B-1B-1B-1B	0GU
FMS-10GV	2K-10-10-10-10	0GV
FMS-10GW	1-1-13R-1-1K-1K-1K-1K-1K	0GW
FMS-10GX	1K-1B-1-1W-10-10BB-10RR	0GX
FMS-10GY	1K-1K-10R-10R-10R-10R	0GY
FMS-10GZ	1K-10-10-10-10-1	0GZ
FMS-10H	10-10-10-9-1K-1K-1K	10H
FMS-10H1	1N-1N-1-1-1W-1W-1E-1E-1E-1E	0H1
FMS-10H2	1N-1N-1E-10-1E-1Y-1Y-1Y-1Y	0H2
FMS-10H3	1N-1N-1E-1E-1E-1E-1E-1Y-1Y	0H3
FMS-10H4	1N-1N-1N-1N-1-1-1E-1E-1Y-1Y	0H4
FMS-10H5	1Y-1Y-1-1-1-1-1E-1E-1E-1E	0H5
FMS-10H6	1Y-1Y-1Y-10-10-10-1E	0H6
FMS-10H7	1Y-1Y-1Y-1Y-1Y-1Y-1E-1E-1E-1E	0H7
FMS-10H8	16-1K-1K-1K-1K-1K-1K-1K	0H8
FMS-10H9	#1-1-1-1-1-1-1#-1K-1K-1K-1K	0H9
FMS-10HA	6-6-6-24-1-1-1-1-1-1	0HA
FMS-10HB	6-6-6-24-10-10-10	0HB
FMS-10HC	#6-6-6-#-1K-1-1-1-1-1-1	0HC
FMS-10HD	1K-1K-1K-10-10-10-9	0HD
FMS-10HE	2-2-2-2-2	0HE
FMS-10HF	1B-1B-6B-1B-1B-1B-6B-1B-1B	0HF

Color Key: k: Black b: Blue g: Green e: Orange r: Red w: White n: Brown y: Yellow p: Purple

FMS 10 Pole Test Switches

Part Number	Arrangement	R19 Rack Code
FMS-10HG	1-1-1-24-1B-1B-1B-1B-1B-1B	OHG
FMS-10HH	1K-1K-1K-1K-9-9-9-9-1K-1K	OHH
FMS-10HI	10-10-1-1-1-1-1-1	OHI
FMS-10HJ	#1-1-1-1-#-10-10-10	OHI
FMS-10HK	1E-1E-10-10-10-10	OHK
FMS-10HL	10-10-10-10R-10R	OHL
FMS-10HM	1-10R-1Y-10Y-1B-10B-1K	OHM
FMS-10HN	1K-1K-1K-1K-1K-1K-1K-1K-#1K-1K#	OHN
FMS-10HO	10-#10#-1-1-1K-1K-1K-1K	OHO
FMS-10HP	#1-1-1-1-10-10-10#	OHP
FMS-10HQ	1-1-1-1-1-10-10-1	OHQ
FMS-10HR	1K-1K-10-10-10-1K-1K	OHR
FMS-10HS	1B-1B-1B-1B-1B-1B-1-1-1-1	OHS
FMS-10HT	#1-1-1-1-1-1-1-#-1-1-1	OHT
FMS-10HU	1-1-1-1-1-1-9-9-9-9	OHU
FMS-10HV	1-9-9-9-9-9-9-9-9-9	OHV
FMS-10HW	1-#10#-1-#10#-1-#10#-1	OHV
FMS-10HX	10R-10R-1K-1K-1K-1K-1K-1K	OHX
FMS-10HY	1K-1K-1K-1K-1K-1-1K-1-1K-1	OHY
FMS-10HZ	1K-1K-1K-1K-1K-1K-1-1-1-1	OHZ
FMS-10I	9-1K-1K-1K-1K-1K-1K-1K-1K-1K	10I
FMS-10I1	#1-1-1-1-1-1-1-#-1K-1K-1K	0I1
FMS-10I3	1-1-1B-1B-1B-1B-1B-1B-1W-1K	0I3
FMS-10I4	1-1-1-1-1Y-1Y-1Y-1Y-1Y-1Y	0I4
FMS-10I6	1K-1K-1K-1K-1K-1K-6-6-6-9	0I6
FMS-10I7	1K-1K-1K-1K-1K-1K-#1-1-1-1-#	0I7
FMS-10I8	1K-1K-1K-1K-#1-1-1-1-1-#	0I8
FMS-10I9	10-10-2-1K-1K-1K-1K	0I9
FMS-10IA	1-1W-1-1K-1-1-1K-1K-1-1	0IA
FMS-10IB	10-10-10-1-1K-1K-1K	0IB
FMS-10IC	1B-1B-1K-1B-1K-1B-1B-1K-1B-1K	0IC
FMS-10ID	1-1-1-1-1-1K-1-1K-1K-1B	0ID
FMS-10IE	1-1K-1-1K-1-1K-1K-1-1	0IE
FMS-10IF	1-1W-1-1K-1-1-1K-1K-1K-1K	0IF
FMS-10IG	1-1W-1-1K-1K-1K-1K-1B-1K-1	0IG
FMS-10IH	1-1-1K-1-1K-1K-1K-1K-1K	0IH
FMS-10IJ	1K-1K-1B-1K-1K-1K-1K-1K-1K	0IJ
FMS-10IK	1K-1K-1K-1K-1K-1K-1K-16K	0IK
FMS-10IL	2K-1K-1K-1K-1K-1K-1K-2K	0IL
FMS-10IM	1-1-1-1-1-1-1-1K-1K-2K	0IM
FMS-10IN	1-1K-1Y-1Y-1B-1B-1B-1B-1B	0IN
FMS-10IO	1-1-1-1-1K-1K-1K-1K-1B-1B	0IO
FMS-10IP	1-1-1-1-1Y-1Y-1W-1W-1-1K	0IP
FMS-10IQ	10-10-10-10-9-9	0IQ
FMS-10IR	1B-1B-1B-1B-1B-1B-1B-1-1K	0IR
FMS-10IS	1W-1K-1B-1B-1-1-1-1-1-1	0IS
FMS-10IT	1B-1B-1-1K-1K-1K-1K-1K-1	0IT
FMS-10IU	1-1K-1K-1K-1K-1K-1K-10-1	0IU
FMS-10IV	10-10-10-10-1W-1K	0IV
FMS-10IW	1B-1B-1-1-1-1-1-1-1-1	0IW
FMS-10IX	1K-1K-1K-1K-1K-1-1-1-1-1	0IX
FMS-10IY	1-1-1-10-10-10-24	0IY

FMS 10 Pole Test Switches

Part Number	Arrangement	R19 Rack Code
FMS-10IZ	1Y-1W-1B-24-10Y-10W-10B	0IZ
FMS-10J	1K-1K-1K-1K-1K-1K-10-1K	10J
FMS-10J1	10-10-#1-1-1-1-#-1K-1K	0J1
FMS-10J2	#1K-1K-1K-1K-1K-#-#1K-1K-1K-1K-1K#	0J2
FMS-10J3	1B-1B-1B-1B-1B-1W-1W-1W-1W-1W	0J3
FMS-10J4	10-10G-10R-1K-1G-1-1W	0J4
FMS-10J5	2K-1-1-1E-1E-1B-1B-1Y-1Y	0J5
FMS-10J6	10-10-10-1-1-1-1K	0J6
FMS-10J7	9-9-9-9-9-9-9-9-1-1	0J7
FMS-10J8	1B-1B-1B-1G-10-10-10	0J8
FMS-10J9	1Y-1Y-1Y-1G-10-10-10	0J9
FMS-10JA	24-1-1-1-10-10-10	0JA
FMS-10JB	10-10-10-1Y-1B-1B-1B	0JB
FMS-10JC	10-10-10-1E-1B-1B-1B	0JC
FMS-10JD	10-10-10-10W-1-1	0JD
FMS-10JE	10-10-10-10W-1E-1E	0JE
FMS-10JF	1B-1B-1B-1B-1G-1G-1E-1E-1-1	0JF
FMS-10JG	1-1K-1-1K-1-1K-1-1K-1-1K	0JG
FMS-10JH	1-1K-1K-1K-1K-1K-1K-1K-1E	0JH
FMS-10JI	10-10-10-1B-1B-1-1	0JI
FMS-10JJ	1-1-1-1-1K-1K-1K-1K-1K-1K	0JJ
FMS-10JK	10-1K-1K-1K-1K-1K-1K-1K-1K	0JK
FMS-10JL	16-16-10-10	0JL
FMS-10JM	1B-1G-1E-1-1W-1B-1G-1Y-10	0JM
FMS-10JN	1K-1K-1K-24-10-10-10	0JN
FMS-10JO	9-9-9-9-1-1-1-1-9-9	0JO
FMS-10JP	9-9-9-9-#-6-6-6-6-#9-9	0JP
FMS-10JQ	1-1K-1B-1B-1B-1B-1B-10G	0JQ
FMS-10JR	1W-1E-1E-1E-1E-1E-1E-1E-1E	0JR
FMS-10JS	1-1K-1B-1B-1B-1B-1B-1B-1B	0JS
FMS-10JT	1-1K-1B-1B-1B-1-1K-1B-1B-1B	0JT
FMS-10JU	1K-1K-1K-1K-1K-1K-1-1-1-1	0JU
FMS-10JV	1B-10-10-10-10-1B	0JV
FMS-10JW	16-24-1-24-1E-1E-1G-1G	0JW
FMS-10JX	1-1K-1K-1K-1K-1K-1K-1E-1-1	0JX
FMS-10JY	10-9-9-1K-1K-1K-1K-1K-1K	0JY
FMS-10JZ	1-1K-1E-1E-1E-1E-1-1-10	0JZ
FMS-10K	1K-1K-1K-1K-1K-1K-9-10-1K	10K
FMS-10K1	1-1-1-1-1-1-1K-1K-1B-1B	0K1
FMS-10K2	1K-1K-1K-1K-1K-1K-1W-1W-10R	0K2
FMS-10K3	1-1E-1Y-24-10KW-10BW-10NW	0K3
FMS-10K4	6-6-6-9-1K-1K-1K-1K-1	0K4
FMS-10K5	10W-10W-10W-10W-10W	0K5
FMS-10K7	1N-1N-1N-1N-10N-10N-10N	0K7
FMS-10K8	10-1-1-10-10-10	0K8
FMS-10K9	10-1-1-1-1-1-1-10	0K9
FMS-10KA	1K-1K-1K-1K-1K-1K-1K-2	0KA
FMS-10KB	1-1-1-10-1-1-1-1-1	0KB
FMS-10KC	2K-1K-1K-1K-1K-1K-1K-1K	0KC
FMS-10KD	10-10-10-9-1-1-1	0KD
FMS-10KE	#1K-1K-1K-1K-#-1-2-1-1-1	0KE
FMS-10KF	2-1-1-1-1-1-1-1-1	0KF

Color Key: k: Black b: Blue g: Green e: Orange r: Red w: White n: Brown y: Yellow p: Purple

FMS Semiflush-Mounted Test Switches

FMS 10 Pole Test Switches

Part Number	Arrangement	R19 Rack Code
FMS-10KG	2-1-1-1-1-1-1-2K	0KG
FMS-10KH	1-1-1W-1W-1-1E-1-1-1-1	0KH
FMS-10KI	2-2-1-1-1-1-1W-1W-1	0KI
FMS-10KJ	2-1B-1B-1-1W-1-1-1-1	0KJ
FMS-10KK	1-1W-1B-24-1K-1K-1-1W-1B-24	0KK
FMS-10KL	2-1-1W-1-1-1-1-1-1	0KL
FMS-10KM	2-1-1Y-1-1-1-1-1-1	0KM
FMS-10KN	1E-1-1W-1W-1W-1-1-1-1-1	0KN
FMS-10KO	2-1-1-1-1-1-1-1W-1W-1	0KO
FMS-10KP	#1-1-1-1-#-2K-1-1-1-1	0KP
FMS-10KQ	1-1KU-1KU-1KU-1KU-1K-1K-1K-1K	0KQ
FMS-10KR	1-1K-9-10-10-10-1K	0KR
FMS-10KS	1K-1-1-1-10-10-10	0KS
FMS-10KT	10R-10R-10R-9R-1-1-1	0KT
FMS-10KU	10R-10R-1-1-1-1-1-1	0KU
FMS-10KV	10R-10R-10R-1-1-1-1	0KV
FMS-10KW	1-16-10-10-10	0KW
FMS-10KX	#10-10-10-10-10#	0KX
FMS-10KY	1-1K-1E-1E-1E-1E-1E-1E-1E	0KY
FMS-10KZ	1-1K-1E-1E-1E-1E-1E-1E-1	0KZ
FMS-10L	1K-1K-1K-1K-1K-10-10-1K	10L
FMS-10L1	#10-10-10#-2-2K	0L1
FMS-10L2	1B-1B-1B-1B-2-2-2	0L2
FMS-10L3	1-1W-1B-1Y-24-1K-1K-1K-1K-1K	0L3
FMS-10L4	2Y-2KW-10E-10Y-10N	0L4
FMS-10L5	6-6-6-9-1N-1G-1N-1G-1N-1G	0L5
FMS-10L6	1P-1W-1Y-1Y-1Y-1P-1W-1-1-1	0L6
FMS-10L8	10-9-10-10-10-9	0L8
FMS-10L9	10-10-9-10-9-10	0L9
FMS-10LA	#6-6-6-9#-#10#-2-1-1	0LA
FMS-10LB	1K-1K-1K-1K-1-1-1-1K-1K-1K	0LB
FMS-10LC	1-10-10-10-1-1-1	0LC
FMS-10LD	1-1-1-1-1-1-10-10	0LD
FMS-10LE	1K-1K-1K-1K-1K-1K-10-10	0LE
FMS-10LF	10-10-1-1-1-1B-1B-1B	0LF
FMS-10LG	10-9-9-9-9-9-9-1K-1K	0LG
FMS-10LH	10-1-24-1B-1B-1B-1B-1B-1B	0LH
FMS-10LI	1-1K-1-1-1K-1-1-1K-1-1	0LI
FMS-10LJ	1-1K-13E-1-1-1-1-1-1	0LJ
FMS-10LK	1-1-1-9-10-10-10	0LK
FMS-10LL	10-10W-10-10W-10	0LL
FMS-10LM	1-1K-13E-1-1K-13E-1-1	0LM
FMS-10LN	16-1-1-1-1-1-1-1	0LN
FMS-10LO	1Y-1-1-1-10-10-10	0LO
FMS-10LP	1K-1K-1K-10-1K-1K-1K-1K	0LP
FMS-10LQ	1K-1-1W-1K-1-1W-1K-1-1W-1K	0LQ
FMS-10LR	1-1-1-10-10-10-1W	0LR
FMS-10LS	10-9-9-1-1-1-1-1-1	0LS
FMS-10LT	2-10-10-10-10	0LT
FMS-10LU	1B-1B-1B-1B-1K-1K-1K-1K-1K	0LU
FMS-10LV	1-1-1K-10-10-10-9	0LV
FMS-10LW	2Y-2Y-2Y-2Y-2Y	0LW

FMS 10 Pole Test Switches

Part Number	Arrangement	R19 Rack Code
FMS-10LX	1W-1W-1W-10EK-10EK-10EK-1W	0LX
FMS-10LY	1-2-2-2-16	0LY
FMS-10LZ	1-10-10-10-16	0LZ
FMS-10M	1K-1K-1K-10-1K-1K-10-1K	10M
FMS-10M2	1K-1K-#1-1-1-1-#-#1-1-1-1-#	0M2
FMS-10M3	10W-10W-10W-10W-1K-1K	0M3
FMS-10M4	10W-10W-10W-1K-1K-1K-1K	0M4
FMS-10M5	10R-10R-10R-10R-1E-1E	0M5
FMS-10M6	10-10-10-10-10R	0M6
FMS-10M7	10-10-10-10-1W-1W	0M7
FMS-10M8	10-10-1B-1B-1-1-2K	0M8
FMS-10M9	6W-6W-6W-9W-1K-1K-1K-1-1	0M9
FMS-10MA	1-1-1-24-1-24-10-10 (#24 with jaws)	0MA
FMS-10MB	10-10-1B-1B-1B-1B-1B-1B	0MB
FMS-10MC	1-1-1-1-1-1-1-1-1B-1B	0MC
FMS-10MD	1K-24-1K-#10R#-#10R#-#10R#-9W	0MD
FMS-10ME	1-10-1-1-1-1-10-1	0ME
FMS-10MF	10-10-10-1G-1-1-1	0MF
FMS-10MG	1K-1-1B-1B-1Y-1Y-1G-1-1-1	0MG
FMS-10MH	1N-1W-1B-1B-1G-1K-1Y-1Y-1K-1K	0MH
FMS-10MI	1K-1Y-1B-1B-1Y-1Y-1N-1W-1K-1K	0MI
FMS-10MJ	10-10-10-1N-1Y-1W-1W	0MJ
FMS-10MK	10-10-10-1N-1N-1W-1W	0MK
FMS-10ML	1K-1K-1K-1K-1K-1K-1K-1-1	0ML
FMS-10MM	1-10KW-1E-10KW-1B-10GW-1Y	0MM
FMS-10MN	10-10-10-10-1B-1B	0MN
FMS-10MP	1-1-1-1-1K-1K-1K-1G-1-1K	0MP
FMS-10MQ	#10-10-10#-#1K-1K-1K-1K#	0MQ
FMS-10MR	1Y-1K-1K-1K-1K-1K-1-1-1	0MR
FMS-10MS	2K-1K-1Y-1B-1B-1K-1-1-1	0MS
FMS-10MT	#1K-1K-1K-1K#-1K-1K-1K-1K-1K	0MT
FMS-10MU	1Y-1K-1K-1K-1K-1K-1K-1K-1	0MU
FMS-10MV	1K-10-10-10-1K-1K-1	0MV
FMS-10MW	1-1-1-1-1-1-1-1-1K-1K	0MW
FMS-10MX	1-2-2-2-2-1	0MX
FMS-10MY	1B-1B-1K-1K-1K-1K-1K-1K-1K	0MY
FMS-10MZ	1-1-1-1-1-1-1-1K-1K-1K	0MZ
FMS-10N	1K-10-1K-1K-1K-1K-10-1K	10N
FMS-10N1	10-10N-10E-10Y-1-1	0N1
FMS-10N2	6-6N-6E-9G-6-6N-6E-9G-1-1	0N2
FMS-10N3	6-6N-6E-9G-1-1-1-1-1-1	0N3
FMS-10N4	1K-1E-1E-1E-6W-6W-6W-1W-2	0N4
FMS-10N5	1-1-1-1K-9-1K-9-1K-9-1K	0N5
FMS-10N6	#1-1-10-10#-1-1-10	0N6
FMS-10N7	10-10-1W-1K-1B-1B-1B-1B	0N7
FMS-10N8	2-2-16-1-90R	0N8
FMS-10N9	1B-1B-1K-1K-1K-1K-1K-1W-1W	0N9
FMS-10NA	1-1K-1K-1K-1K-1K-10-1K	0NA
FMS-10NB	1N-1W-1B-1B-1G-1W-1Y-1Y-1W-1W	0NB
FMS-10NC	9-10-10-10-10-9	0NC
FMS-10ND	1K-1-1K-1-1K-1K-1K-1K-1K	0ND
FMS-10NE	9-9-9-9-9-9-9-10	0NE

Color Key: k: Black b: Blue g: Green e: Orange r: Red w: White n: Brown y: Yellow p: Purple

FMS 10 Pole Test Switches

Part Number	Arrangement	R19 Rack Code
FMS-10NF	1K-1-1K-1-1K-1-1K-1-1K-1	ONF
FMS-10NG	#6-6-6-24-1#-#6-6-6-24-1#	ONG
FMS-10NH	1-1-1-10-10-10-9	ONH
FMS-10NI	10B-10B-1B-1B-1B-1B-1B-1B	ONI
FMS-10NJ	1B-1B-1B-1B-1-1-1-1-1-1	ONJ
FMS-10NK	1B-1-1-1-1-1-1-1-1-1	ONK
FMS-10NL	1-1-1-24-1-24-1-24-1-24	ONL
FMS-10NM	2K-2K-10-2K-1-1	ONM
FMS-10NP	2K-10-2K-2K-1-1	ONP
FMS-10NQ	1-1-1K-1K-1K-1K-1K-1K-1-1W	ONQ
FMS-10NR	1-1-1-1-1-1K-1K-1K-1K-1K	ONR
FMS-10NS	1B-1B-1G-1G-1W-1W-1W-1W-1W-1W	ONS
FMS-10NT	1Y-1Y-1Y-1Y-1Y-1Y-1Y-1Y-1G-1G	ONT
FMS-10NU	1G-1G-1G-1G-1G-1Y-1Y-1Y-1Y-1Y	ONU
FMS-10NV	1Y-1Y-1Y-1Y-1Y-1Y-1Y-1Y-1Y-1Y	ONV
FMS-10NW	1K-10-10-10-10-9	ONW
FMS-10NX	1K-1K-1K-1K-1-1-1K-10-1K	ONX
FMS-10NY	2B-2Y-1-1-1-1-1-1	ONY
FMS-10NZ	1K-10-10-10-1K-1K-1K	ONZ
FMS-10P	10-10-1K-1K-1K-1K-1K-1K	10P
FMS-10P3	#6-6-6-9#-1-1-1-1-1-1	OP3
FMS-10P5	2K-1B-1B-2-2-2	OP5
FMS-10P6	10B-10B-10B-10E-10E	OP6
FMS-10P7	10E-10G-10G-10G-1K-1K	OP7
FMS-10P9	10-10-10-1B-1B-1B-1	OP9
FMS-10PA	1K-1K-1K-1K-1K-1K-1K-10R-1K	OPA
FMS-10PB	1K-1K-1K-1K-1K-10R-10R-1K	OPB
FMS-10PC	1K-10R-1K-1K-1K-1K-10R-1K	OPC
FMS-10PD	1K-1K-1K-10R-10R-10R-1K	OPD
FMS-10PE	1K-10R-1K-10R-1K-10R-1K	OPE
FMS-10PF	1K-10R-10R-10R-10R-1K	OPF
FMS-10PG	10R-10R-10R-10R-10R	OPG
FMS-10PH	1K-1K-1K-1K-10R-10R-10R	OPH
FMS-10PJ	1-1-1K-10-10-10-1K	OPJ
FMS-10PK	9-9-9-9-9-9-9-9-1	OPK
FMS-10PL	9R-9R-9R-10-10-10-9	OPL
FMS-10PM	1-1-9-10-10-10-1	OPM
FMS-10PN	1-1-2-1-2-1-1-1	OPN
FMS-10PQ	1-1-1-1-1-1K-1-1-9-9	OPQ
FMS-10PR	10-10-10-16-1	OPR
FMS-10PS	1kU-1kU-1kU-1kU-10-10-10	OPS
FMS-10PT	1-1kU-1kU-1kU-1kU-1-1-1-1-1	OPT
FMS-10PU	1-1-1-1K-1K-1K-1K-1K-1K-1K	OPU
FMS-10PV	1-1-1-1-1-1-1-1-10	OPV
FMS-10PW	1-1-1Y-1Y-1K-1K-1K-1K-1K-1K	OPW
FMS-10PX	1-1-1-1Y-1Y-1K-1K-1K-1K-1K	OPX
FMS-10PY	1-10-10-10-10-1Y	OPY
FMS-10PZ	13-13-13-13-13	OPZ
FMS-10Q1	1-1-1-1-13-13-13	QQ1
FMS-10Q3	10-10-10-1W-1W-1-1	QQ3
FMS-10Q5	1K-1-1B-1W-10E-10N-10Y	QQ5
FMS-10Q6	1-1-1-1-1-1-1-1-1W-1K	QQ6

FMS 10 Pole Test Switches

Part Number	Arrangement	R19 Rack Code
FMS-10Q8	1-1-1-1B-1B-1B-1B-1B-1B-1B	QQ8
FMS-10Q9	10R-10W-10B-24-24-24-24	QQ9
FMS-10QA	1-1Y-1K-1K-1K-1K-1K-1K-1K-1K	QQA
FMS-10QB	10-10-10-10-1K-1	QQB
FMS-10QC	1-1-1-1-1-1Y-1K-1K-1K-1B	QQC
FMS-10QD	1-1-1K-1Y-1K-1B-1K-1K-2K	QQD
FMS-10QE	#10-10-10#-1K-1K-10	QQE
FMS-10QF	#10-10-10#-1K-1K-1K-1B	QQF
FMS-10QG	6-6-6-9-6-6-6-9-1K-1K	QQG
FMS-10QH	6-6-6-9-6-6-6-9-10	QQH
FMS-10QI	6-6-6-9-1K-1K-1K-1K-1K-1K	QQI
FMS-10QJ	6-6-6-9-6-6-6-9-1-1	QQJ
FMS-10QK	6-6-6-9-1-1-1-1-1-1	QQK
FMS-10QL	1-1-1-1-1-1-10-1-1	QQL
FMS-10QM	#6-6-6#9-1-1-1-1-1	QQM
FMS-10QN	#6-6-6-#9-#6-6-6-#9-1-1	QQN
FMS-10QP	1G-1-1W-1K-10G-10R-10W	QQP
FMS-10QQ	1-1K-1K-10-10-10-9	QQQ
FMS-10QR	1-10-10-10-10-9	QQR
FMS-10QS	1Y-1Y-1Y-1Y-10-10-10	QQS
FMS-10QT	1B-1B-1B-24-10-10-10	QQT
FMS-10QU	1-1B-1K-1K-1K-24-#6-6-6-5#	QQU
FMS-10QV	1W-1W-1W-1W-10-10-10	QQV
FMS-10QW	10E-10E-10E-10B-10B	QQW
FMS-10QX	10B-1-1K-1K-1K-1-1K-10Y	QQX
FMS-10QY	10Y-10Y-10G-10G-10G	QQY
FMS-10QZ	1-1-1-1-2-2-2	QQZ
FMS-10R	1K-1K-9-10-10-10-1K	10R
FMS-10R1	10KG-10BG-10NG-1K-1K-1K-1K	OR1
FMS-10R2	1-1E-1Y-24-1E-24-1K-1K-1K-1K	OR2
FMS-10R3	10KG-10BG-10NG-10WG-1K-1K	OR3
FMS-10R4	1-1E-1Y-24-1W-24-1K-1K-1K-1K	OR4
FMS-10R5	1-1-1-1-1B-1B-1W-1K-10	OR5
FMS-10R6	1-1E-1Y-24-1W-1W-1K-1K-1K-1K	OR6
FMS-10R7	1-1-1-1-1-1-1W-1B-1B-1B	OR7
FMS-10R8	1-1-1-24-1B-1-1-1-24-1B	OR8
FMS-10R9	1E-1E-1-1-10-10-10	OR9
FMS-10RA	10-10-10-1-16	ORA
FMS-10RB	2-2-2-1-16	ORB
FMS-10RC	9-9-9-9-9-9-9-9-1K-1K	ORC
FMS-10RD	24-1-1-9-9-24-1-1-9-9	ORD
FMS-10RE	1-10-10-1-1-10-1	ORE
FMS-10RF	1-1K-1K-1K-10-10-10	ORF
FMS-10RG	1W-1W-1W-#10EK#-#10EK#-#10EK#-1W	ORG
FMS-10RH	1Y-1Y-1Y-1Y-1Y-1Y-#6-6-6-9	ORH
FMS-10RI	1B-1B-#6-6-6-9-#6-6-6-9	ORI
FMS-10RJ	1-1-1-1-1-1Y-1Y-1Y-1Y-1Y	ORJ
FMS-10RK	#6-6-6-9-#6-6-6-9-10	ORK
FMS-10RL	1B-1B-1-1-1-1Y-1Y-1Y-1Y	ORL
FMS-10RM	1B-1B-1-1-10-10-10	ORM
FMS-10RN	1B-1B-1-1Y-1Y-1Y-#6-6-6-9	ORN
FMS-10RO	1B-1B-1-1-1Y-1Y-1Y-1Y-1Y	ORO

Color Key: k: Black b: Blue g: Green e: Orange r: Red w: White n: Brown y: Yellow p: Purple

FMS Test Switches

FMS Semiflush-Mounted Test Switches

FMS Test Switches

FMS 10 Pole Test Switches

Part Number	Arrangement	R19 Rack Code
FMS-10RP	1B-1Y-1Y-1Y-10-10-10	ORP
FMS-10RQ	1-1-1-1-1-1kU-1kU-1kU-1kU-1	ORQ
FMS-10RR	1-10-10-10-1N-1N-1N	ORR
FMS-10RS	2K-1B-1B-1B-1B-1B-1B-1B	ORS
FMS-10RT	1-1-1-1-1-1-1-1-1-1Y	ORT
FMS-10RU	10-10-9-9-9-9-1K-1K	ORU
FMS-10RV	1E-1E-1E-1E-1E-1Y-1Y-1Y-1Y-1Y	ORV
FMS-10RW	1Y-1Y-1Y-1Y-1Y-1Y-1-1-1-1	ORW
FMS-10RX	#1K-1K-1K-1K#-#6-6-6-6#-24-1K	ORX
FMS-10RY	2K-#1K-1K-1K-1K#-2K-2K	ORY
FMS-10RZ	1K-1K-1-1-1K-1K-1K-1K-1K	ORZ
FMS-10S	1K-9-9-9-9-9-9-9-1K	10S
FMS-10S1	1K-1K-1K-1K-1-1G-1-1K-1K-1K	OS1
FMS-10S2	10-10W-10B-1-1-1-1	OS2
FMS-10S3	10-10W-10B-10-10	OS3
FMS-10S5	1K-1K-1K-1K-10W-10W-10W	OS5
FMS-10S6	1-1-1-10-10-10-1G	OS6
FMS-10S7	#10#-#10#-#10#-1-1-1-1	OS7
FMS-10S8	#10-1-1-1-1-1-1-1-1#	OS8
FMS-10SA	1K-1K-1-1-1-1-1K-1K-1K-1K	OSA
FMS-10SB	1K-1K-1K-1K-1-1-1-1-1K-1K	OSB
FMS-10SC	10-10-10-1Y-1Y-1Y-1Y	OSC
FMS-10SD	1K-1K-1K-1K-1K-1K-1K-1-1-1K	OSD
FMS-10SE	1B-1B-1B-10-10-10-1K	OSE
FMS-10SF	1K-1K-1B-1B-1K-1K-1K-1K-1K	OSF
FMS-10SG	1-1-1-1-1K-1K-1-1-1-1K	OSG
FMS-10SH	1-1-1K-1K-1-1-1-1K-1K-1K	OSH
FMS-10SI	10-1-10-1-1-1-1-1	OSI
FMS-10SJ	#6-6-6-6-24#-#6-6-6-6-24#	OSJ
FMS-10SK	2K-2K-2K-2K-2K	OSK
FMS-10SL	1-1-1K-1K-1K-1K-1K-1Y-1K	OSL
FMS-10SM	10-10R-10B-1K-1-1B-1K	OSM
FMS-10SN	1N-1N-1N-10-10-10-1	OSN
FMS-10SO	#10#-#10#-#10#-#10#-#10#	OSO
FMS-10SP	6-6-6-9-6-6-6-9-1K-1	OSP
FMS-10SQ	1G-1G-1G-1G-1G-1G-1G-1G-1G	OSQ
FMS-10SR	1W-1W-1W-1W-1W-1W-1W-1W-1W	OSR
FMS-10SS	1B-1B-1W-1W-1W-1W-1W-1W-1W	OSS
FMS-10ST	1W-1W-1Y-1Y-1Y-1Y-1Y-1G-1G	OST
FMS-10SU	1B-1B-1B-10-10-10-1	OSU
FMS-10SV	1K-1K-1K-1K-1K-1K-1K-16	OSV
FMS-10SW	1-24-1-24-1B-1B-1B-1B-1B	OSW
FMS-10SX	1K-1-1-1-1-1K-1K-1K-1K-1K	OSX
FMS-10SY	1-1-1-1-1-1Y-1Y-1Y-1K-1W	OSY
FMS-10SZ	10-10-10-9-10-9	OSZ
FMS-10T	9-9-9-9-9-9-9-9-1K	10T
FMS-10T1	1B-1B-1B-1B-1B-1Y-1Y-1Y-1Y	OT1
FMS-10T2	1K-1K-1K-10Y-10Y-10Y-1	OT2
FMS-10T3	#10-10-10-#-1K-1-1-1	OT3
FMS-10T4	1-1-1-1-1-1-1E-1-1-1	OT4
FMS-10T5	1-10R-1-10R-1-10R-1	OT5
FMS-10T6	1K-24-1K-24-1K-1K-1K-1K-1K	OT6

FMS 10 Pole Test Switches

Part Number	Arrangement	R19 Rack Code
FMS-10T7	1B-1B-1B-1B-1B-1W-1W-1W-1W	OT7
FMS-10T8	1W-1K-1K-1K-10B-10W-10R	OT8
FMS-10T9	1K-10-10B-10W-10R-1K	OT9
FMS-10TA	1K-1K-1-1-1-1B-1-1-1-1	OTA
FMS-10TB	1-1B-1-10-10-10-1	OTB
FMS-10TC	1K-1K-1K-1K-1-1-1-1B-1-1	OTC
FMS-10TD	1K-1K-1-1-1B-1-1-1-1-1	OTD
FMS-10TE	2K-2K-#1K-1K-1K-1K#-2K	OTE
FMS-10TF	2RK-2RK-2RK-2RK-2RK	OTF
FMS-10TG	10-10-1-1K-1-1K-1-1K	OTG
FMS-10TH	10-10-10-1K-1K-1-1	OTH
FMS-10TI	1K-1K-1K-1K-1K-1K-1K-1-1K-1	OTI
FMS-10TJ	1K-1B-1-1W-10KW-10YW-10EW	OTJ
FMS-10TK	16-1-10-10-10	OTK
FMS-10TL	10-10-10-1W-1W-1-1K	OTL
FMS-10TM	#1-1-1-1-1-1-1-1-1-1#	OTM
FMS-10TN	1Y-1Y-1Y-10-10-10-1Y	OTN
FMS-10TO	1-1-1-1W-10-10-10	OTO
FMS-10TP	1-1-1-1-1-1-10R-10R	OTP
FMS-10TQ	1E-1Y-1K-1K-1K-1K-1K-1K-1K	OTQ
FMS-10TR	1B-1B-1Y-1Y-1-1-1Y-1Y-1K-1K	OTR
FMS-10TS	1-1-1-1-1B-1B-1G-1G-1G-1G	OTS
FMS-10TT	1Y-1Y-1Y-1Y-1G-1G-1Y-1Y-1G-1G	OTT
FMS-10TU	1W-1W-1Y-1Y-1Y-1Y-1G-1Y-1Y-1G	OTU
FMS-10TV	1K-1K-1K-1K-1K-1K-10R-1K-1K	OTV
FMS-10TW	6-6-6-9-1-1-1-1-1B-1B	OTW
FMS-10TX	10-1W-1K-1B-1B-1B-1B-1-1	OTX
FMS-10TY	10-1B-1B-1-1-1-1-1-1	OTY
FMS-10TZ	1W-1K-1B-1B-1B-1B-1B-1B-1B	OTZ
FMS-10U	10-10-10-2-2	10U
FMS-10U1	2B-1K-1K-1-1-1-1K-1K-1K	OU1
FMS-10U2	1K-1K-1K-1K-16K-16K	OU2
FMS-10U3	2K-2K-2K-1-1-1-1	OU3
FMS-10U4	1-1W-1N-1N-1N-1N-#6-6-6-1K#	OU4
FMS-10U5	1E-1E-1E-1E-1E-1E-1K-1-1B	OU5
FMS-10U6	1E-1E-10-10R-10B-1-1K	OU6
FMS-10U7	1E-10-10R-10B-1K-1-1B	OU7
FMS-10U8	1B-1B-1-1-1B-1B-1W-1K-1W-1K	OU8
FMS-10U9	9R-9R-9R-9R-1K-1K-1K-1K-8-8	OU9
FMS-10UA	10-1B-1B-1B-1B-1B-1-1	OUA
FMS-10UB	1-1-1B-1B-1-1-1-1-1-1	OUB
FMS-10UC	1-1-1W-1K-1B-1B-1-1-1B-1B	OUC
FMS-10UD	1-1-1-1-1-1-10R-1-1	OUD
FMS-10UE	1B-1B-1B-10R-10R-10R-1K	OUE
FMS-10UF	1K-1K-1K-1-1K-1K-1K-1K-1K	OUF
FMS-10UG	10-10-10-1-1-1-1E	OUG
FMS-10UH	1-1-1-1-1K-1K-#1K-1K-1K-1K#	OUH
FMS-10UI	1-1-1-1-1-1-#1K-1K-1K-1K#	OUI
FMS-10UJ	1Y-1Y-1Y-1Y-10B-10B-10B	OUI
FMS-10UK	1Y-1Y-1K-1K-1K-1K-1K-1K-1K	OUI
FMS-10UL	10-1B-1B-1B-1B-1B-1W-1K	OUL
FMS-10UM	1-10-1-10-1-1-1-1	OUM

Color Key: k: Black b: Blue g: Green e: Orange r: Red w: White n: Brown y: Yellow p: Purple

FMS 10 Pole Test Switches

Part Number	Arrangement	R19 Rack Code
FMS-10UN	10EK-10EK-10EK-10EK-10EK	OUN
FMS-10UO	1W-10-10-10-10-1W	OZO
FMS-10UP	1W-1W-1W-10-10-10-1W	OUP
FMS-10UQ	#1K-1K-1K-1K-#10-10-10#	OUQ
FMS-10UR	#1K-6-6-9-6-6-9-6-9#	OUR
FMS-10US	#6-6-6-6-9#-#6-6-6-6-9#	OUS
FMS-10UT	2-2K-2K-2K-2K	OUT
FMS-10UV	2K-2K-2K-#6-6-6-5#	OUV
FMS-10UW	10-10-9-9-9-9-9	OYW
FMS-10UX	1-1W-10-10-10-10	OYX
FMS-10UY	1-1W-1-1W-10-10-10	OYU
FMS-10UZ	10-10-10-1-1-10	OYU
FMS-10V	1B-1B-1B-10-10-10-1B	10V
FMS-10V1	10R-10W-10B-1-1W-1B-1K	OV1
FMS-10V2	1E-1-1-1-10-10-10	OV2
FMS-10V3	10R-10W-10B-10-10	OV3
FMS-10V4	1-1-1-9W-10-10-10	OV4
FMS-10V5	10-10-10-#1-1-1-1#	OV5
FMS-10V6	1K-1K-1K-9W-10-10-10	OV6
FMS-10V7	13-13G-13R-1W-1W-1W-1W	OV7
FMS-10V8	2K-1-1-1-1-1-1-1K-1K	OV8
FMS-10V9	1E-1B-1Y-10R-10G-10-1W	OV9
FMS-10VA	1B-10-1B-10-1B-10-1B	OVA
FMS-10VB	1-1K-1K-1K-1K-1K-1K-1-1-1	OVV
FMS-10VC	1B-1B-1B-1B-1-1-1-1W-1K	OVC
FMS-10VD	1B-1B-1B-1B-1-1-1-1B-1B	OVD
FMS-10VE	1W-1W-1-1-1Y-1B-1Y-1E-1E-1Y	OVE
FMS-10VF	2-1K-1K-10-10-10	OVF
FMS-10VG	1-1Y-1G-10-10E-10-1	OVG
FMS-10VH	1K-10-10-1K-1K-1K-1K-1K	OVH
FMS-10VI	1K-1K-1K-1-1-1-1-1-1-1K	OVI
FMS-10VJ	#10-10-10#-#1-1-1-1#	OVJ
FMS-10VK	10-1K-1K-1K-1K-1K-1K-10	OVK
FMS-10VM	1-1-1-1-1K-1K-1-1-1-1	OVM
FMS-10VN	1K-1K-1-1-1-1-1-1-1K-1K	OVN
FMS-10VO	1-1Y-1B-1E-1K-1K-1K-1K-1K	OVO
FMS-10VP	6-6G-6N-9E-6-6G-6N-9E-1K-1K	OVP
FMS-10VQ	6-6G-6N-9E-1K-1K-1K-1K-1K	OVQ
FMS-10VR	10-10G-10N-10E-10	OVR
FMS-10VS	2-1-9-9-9-9-9-9-9	OVS
FMS-10VT	1P-1P-1P-1P-1P-1K-1-1Y-1B-1E	OVT
FMS-10VU	2-2-1K-1K-1K-1K-10	OVU
FMS-10VW	2W-2W-2W-2W-2W	OYW
FMS-10VV	1N-1N-1N-1N-10-10R-10B	OVV
FMS-10VX	1-1K-1E-1E-1E-1E-1E-1E-1W	OVX
FMS-10VY	16K-10-10-10-1K	OVY
FMS-10VZ	16K-1K-1K-1K-1K-1K-1K	OVZ
FMS-10W	90-90-90-90-90	10W
FMS-10W1	10B-10B-10B-10G-10G	OW1
FMS-10W2	10G-10E-10E-10E-10Y	OW2
FMS-10W3	10Y-10Y-1-1-1-1-1-1	OW3
FMS-10W5	#1-1-1-1#-#1-1-1-1#-2	OW5

FMS 10 Pole Test Switches

Part Number	Arrangement	R19 Rack Code
FMS-10W6	2-2-2-2-1-1	OW6
FMS-10W7	2-16-16-2	OW7
FMS-10W8	10-1B-1B-1B-1B-1B-1Y-1Y	OW8
FMS-10W9	1K-1K-1K-1K-16-16	OW9
FMS-10WA	1-1K-1K-1K-10E-10E-10E	OWA
FMS-10WB	1-1K-1-1K-1-1K-1-1K-1K	OWB
FMS-10WC	1-1K-1B-1B-1E-1E-1E-1E-1W	OWC
FMS-10WD	10-10-10-10-1Y-1Y	OWD
FMS-10WE	1-1-1-1-1K-10B-1K-1K-1K	OWE
FMS-10WF	10-10-10-1-1-1-1B	OWF
FMS-10WG	1-1-1-1G-10B-10E-10	OWG
FMS-10WH	10-10-10-10-1-1K	OWH
FMS-10WI	10B-10Y-10Y-10Y-1K-1K	OWI
FMS-10WJ	10-10-10-9-10-1	OWJ
FMS-10WK	10-10-10-9-10-1K	OWK
FMS-10WL	1K-1K-1K-1K-1-1K-1-1-1-1	OWL
FMS-10WM	1K-1K-1-10-10-10-1	OWM
FMS-10WN	1K-1K-1-1-1-1K-1K-1-1-1	OWN
FMS-10WO	1K-1K-1K-1K-1-1K-1K-1K-1	OWO
FMS-10WP	16-10-10-10-24	OWP
FMS-10WQ	1K-1K-1K-1K-1K-2-2	OWQ
FMS-10WR	10-10-1Y-1Y-1Y-1Y-1Y-1Y	OWR
FMS-10WS	6-6-6-9-1-1-1-1K-1K-1K	OWS
FMS-10WT	1K-1K-1K-1K-1K-9-9-9-9	OWT
FMS-10WU	1K-1-1B-1W-10-10R-10B	OWU
FMS-10WV	2RK-2-2-2-2	OWV
FMS-10WW	1E-1W-1W-1W-1B-1K-1K-1G-1Y-1N	OWW
FMS-10WX	1-1-1Y-1E-1-1-1Y-1-1-1K	OWX
FMS-10WY	9-9-9-9-1K-1K-1K-1K-1	OWY
FMS-10WZ	1W-16B-10R-10R-10R	OWZ
FMS-10X	16K-16K-2-2	10X
FMS-10X1	1Y-1Y-1Y-1Y-1W-1W-1W-1W-1W	OX1
FMS-10X2	1Y-1Y-1Y-1Y-1Y-1Y-1W-1W-1W	OX2
FMS-10X3	1K-1K-1K-1K-2-2-2	OX3
FMS-10X4	2K-1Y-1Y-1Y-1Y-1Y-1B-1B	OX4
FMS-10X5	1-1-1K-1K-1K-1K-1K-1B-1B	OX5
FMS-10X7	1N-1N-1N-1N-1N-1N-1N-1N	OX7
FMS-10X8	1-1-1-10W-10W-10W-1	OX8
FMS-10X9	1-1G-1Y-1G-1B-1G-1-1G-1Y-1G	OX9
FMS-10XA	1-1K-1-1K-1-1K-1K-1K-1K	OXA
FMS-10XB	1-1K-1-1K-1K-1K-1K-1K-1K	OXB
FMS-10XC	1-1-1-10-10-10-1K	OXC
FMS-10XD	16-16-2-2	OXD
FMS-10XE	1K-1K-1K-1-1-1-1-1-1-1	OXE
FMS-10XF	10G-10G-1K-1K-1K-1K-1K	OXF
FMS-10XG	10E-10E-10E-1K-1K-1K-1K	OXG
FMS-10XH	10B-10Y-10Y-10Y-10G	OXH
FMS-10XI	1-1-1-1-1B-1B-1B-1B-1B	OXI
FMS-10XJ	10-10G-10R-10W-1Y-1Y	OXJ
FMS-10XK	1K-1G-1-1W-1B-1B-1B-1B-1B	OXK
FMS-10XL	1W-1W-1W-1W-1W/6W-1W/6W-1W/1W	OXL
FMS-10XM	1G-1G-1Y-1Y-1E-1E-1W-1W-1B-1B	OXM

Color Key: k: Black b: Blue g: Green e: Orange r: Red w: White n: Brown y: Yellow p: Purple

FMS Semiflush-Mounted Test Switches

FMS Test Switches

FMS 10 Pole Test Switches

Part Number	Arrangement	R19 Rack Code
FMS-10XN	10-1K-1K-1K-1K-1K-1K-1-1	OXN
FMS-10XO	10R-10W-10B-24-24-10	OXO
FMS-10XP	1-1W-1B-24-10R-10W-10B	OXP
FMS-10XQ	1-1W-1B-1Y-1K-1K-1K-1K-1K-1K	OXQ
FMS-10XR	(6W-24)-(6W-24)-(6W-24)-1W-1W-1W-1W	OXR
FMS-10XS	1-1-1-1-1W-1W-1W-1W-1W-1W	OXS
FMS-10XT	(6W-24)-(6W-24)-1W-1W-1W-1W-1W-1W	OXT
FMS-10XU	10-10-10-9-9-9-9	OXU
FMS-10XV	1E-1E-10-10-10-1K-1K	OXV
FMS-10XW	6-24/6-24/6-24/1K-1K-1K-1K	OXW
FMS-10XY	1K-1K-1K-1K-1K-1K-1K-1K/6/24	OXY
FMS-10XZ	1K-10-10-1K-1K-10-1K	OXZ
FMS-10Y	9-9-9-10-10-10-9	10Y
FMS-10Y1	1B-1G-1-1G-1Y-1G-1B-1G-1-1G	OY1
FMS-10Y2	1Y-1G-1B-1G-10-10-10	OY2
FMS-10Y3	10-10-10-1-1K-1-1K	OY3
FMS-10Y4	1B-1G-10-10-10-10	OY4
FMS-10Y5	1-1K-1-1K-1-1K-10-10	OY5
FMS-10Y6	1K-10-10-10-16	OY6
FMS-10Y7	1K-1K-10-10-10-2	OY7
FMS-10Y9	1K-1K-2-2-2-2	OY9
FMS-10YA	1W-1W-1W-1W-10EK-10EK-10EK	OYA
FMS-10YB	1K-1K-1K-1K-10R-10W-10B	OYB
FMS-10YC	1-1W-1-1-1-24-#6-6-6-1K#	OYC
FMS-10YD	1W-1B-1K-1K-1K-1K-1K-1K-1K-1K	OYD
FMS-10YE	2-1K-1K-1K-1K-1K-1K-1K-1K	OYE
FMS-10YF	1-1-1K-1K-10-10-10	OYF
FMS-10YG	#10-10-10#-2K-2K	OYG
FMS-10YH	1-10-1-10-1-10-1W	OYH
FMS-10YI	16-2-1-1-1-1-1	OYI
FMS-10YJ	1-1-1-2K-1K-1K-1K-1K-1K	OYJ
FMS-10YK	6-6-6-6-24-6-6-6-6-24	OYK
FMS-10YL	#10-10-10#-1B-1B-1Y-1K	OYL
FMS-10YM	#10-10-10#-1-1-1-1	OYM
FMS-10YN	1-10-1-10-1-10-1W	OYN
FMS-10YO	1-1-10-10-10-1-1	OYO
FMS-10YP	10-1K-1W-1B-1B-1B-1B-1-1	OYP
FMS-10YQ	1K-1W-1B-1B-1B-1B-1-1-1-1	OYQ
FMS-10YR	10-1K-1W-1B-1B-1-1-1-1	OYR
FMS-10YS	1-1-1B-1B-1B-1B-1-1-1-1	OYS

FMS 10 Pole Test Switches

Part Number	Arrangement	R19 Rack Code
FMS-10YT	10-10-10-1W-1K-1-1	OYT
FMS-10YU	1-1-1-1-1B-1B-1B-1B-1-1	OYU
FMS-10YV	2-2-1K-1K-1K-1K-1K-1K	OYV
FMS-10YW	1B-1B-1G-1G-1G-1G-1G-1G-1W-1W	OYW
FMS-10YX	1B-1B-1B-1B-1B-1-1-1-1-1	OYX
FMS-10YY	1W-1W-1W-1W-1W-1W-1-1-1-1	OYY
FMS-10YZ	#10-10#-1-1-1-1-1-1	OYZ
FMS-10Z1	1E-1E-1E-1E-1E-1E-1E-1K-1K	OZ1
FMS-10Z3	1-1-1-1K-10-10-10	OZ3
FMS-10Z4	1E-1E-10E-1E-1E-10E-1E-1E	OZ4
FMS-10Z5	1E-1E-1E-10E-1E-1E-1E-1E	OZ5
FMS-10Z6	1E-1E-1K-1K-1K-1K-10R-1E-1E	OZ6
FMS-10Z7	1E-1E-10E-1E-1E-1E-1E-1E	OZ7
FMS-10Z8	1K-1K-1E-1E-1E-1E-1E-1E-1E	OZ8
FMS-10Z9	1E-1E-1E-1E-10E-1E-1E-10E	OZ9
FMS-10ZA	10-10-10-6-6-6-9	OZA
FMS-10ZB	1-1-1-1-1-1-1-1-1-#10#	OZB
FMS-10ZC	1-1-1B-1B-1B-1B-1B-1B-1B-1B	OZC
FMS-10ZD	1N-1N-1Y-1Y-1Y-1Y-1Y-1Y-1Y	OZD
FMS-10ZE	10R-10R-10R-1W-1W-1W-1W	OZE
FMS-10ZF	1W-1W-1W-1W-1K-1K-1K-1K-1K	OZF
FMS-10ZG	1-1-1-2K-1K-1K-1K-2K	OZG
FMS-10ZH	10-10-10-10-9-1K	OZH
FMS-10ZI	1-1-1W-1Y-1Y-1Y-1Y-1Y-1Y-1Y	OZI
FMS-10ZJ	1E-1E-1E-1E-1E-1E-1-1-1-1	OZJ
FMS-10ZK	10R-10B-2K-2K-2K	OZK
FMS-10ZL	10B-10-10R-10B-10	OZL
FMS-10ZM	10-10R-10B-10-10R	OZM
FMS-10ZN	10B-10-10R-10B-2	OZN
FMS-10ZO	10R-10R-10R-1G-1G-1G-1G	OZO
FMS-10ZQ	10R-10Y-10B-10-10	OZQ
FMS-10ZR	1B-1B-10R-10Y-10B-10	OZR
FMS-10ZS	1-1Y-1B-1K-10R-10Y-10B	OZS
FMS-10ZT	9-9-9-9-1K-1K-1K-1K-1K-1K	OZT
FMS-10ZU	1-1K-1N-1E-1Y-1W-1W-1-1-1	OZU
FMS-10ZV	2B-1Y-1Y-1Y-1Y-1Y-1Y-1Y	OZV
FMS-10ZW	1Y-1Y-1W-1K-1K-1K-1K-1K-1K	OZW
FMS-10ZX	10-10-1-1-1K-1K-1-1	OZX
FMS-10ZY	1-1W-1-1W-1K-1K-1K-1K-1K	OZY
FMS-10ZZ	1K-1K-1K-1-1-1-1-1K-1K-1K	OZZ

Please refer to the STATES website for more part numbers and up to date information

Color Key: k: Black b: Blue g: Green e: Orange r: Red w: White n: Brown y: Yellow p: Purple

FMS 14 Pole Test Switches

Part Number	Arrangement
FMS14-11A	1-1-1-1-1-1-1-1-1-1-26-26-26
FMS14-11B	10-10-10-10-1B-1B-1B-26-26-26
FMS14-11C	26-26-26-10-10-10-2-16
FMS14-11D	1-1-1K-1K-1K-10-10-10-26-26-26
FMS14-11E	1-1-1-10-10-10-1-1-26-26-26
FMS14-11F	10-10-10-10-1-90Y-26-26-26
FMS14-11G	10-10-10-9-26-26-26-1-1-1-1
FMS14-11H	10-6-6-6-9-10-1-1-1-26-26-26
FMS14-11I	1-1-1-13-13-13-13-26-26-26
FMS14-11J	1K-1K-1K-1K-10-10-10-9-26-26-26
FMS14-11K	1-1G-1-1G-1-1G-1W-1W-1E-1E-26-26-26
FMS14-11M	16-10-10-10-2-26-26-26
FMS14-11P	1K-1K-1K-10-10-10-1K-1K-26-26-26
FMS14-11Q	1K-1K-1K-1K-26-10-10-10-9-26-26
FMS14-11S	1K-1K-1K-1K-26-26-26-11-11-11-9
FMS14-11T	16-10-10-10-26-26-26-2
FMS14-12A	1-1-1-1-1-1-1-1-1-1-1-1-26-26
FMS14-12A1	1K-1K-1K-1K-1K-1K-1K-1K-1K-1K-1K-26-26
FMS14-12AB	1K-1K-1K-1K-1K-1K-1-1-1-1-1-1-26-26
FMS14-12AD	16-1K-26-26-10-10-10-10
FMS14-12AE	10-10-10-1-1-1-26-26-1-1-1
FMS14-12AF	#6-6-6-9#-26-#6-6-6-9#-26-#6-6-6-9#
FMS14-12AG	10R-10R-10R-10R-1G-1G-1G-1G-26-26
FMS14-12AH	10-10-10-1K-1K-1K-1K-1K-26-26
FMS14-12AI	6-6-6-9-10-10-1K-1K-1K-26-26
FMS14-12AJ	6-6-6-9-1-1-1-1-1K-1K-1K-26-26
FMS14-12AK	1-1-1-1-1-1-10-10-10-26-26
FMS14-12AL	10-10-10-10-10-1-1-26-26
FMS14-12AM	10-10-10-10-1K-1K-1K-26-26
FMS14-12AP	13-13-13-13-9-9-9-9-26-26
FMS14-12AQ	1K-1K-1K-1K-10-10-10-10-26-26
FMS14-12AT	16-10-10-10-24-26-26-1-24
FMS14-12AU	1-1-1-10-10-10-10-1-26-26
FMS14-12AV	26-10-10-10-10-1-1-1-1Y-26
FMS14-12AX	26-1K-1K-1K-1K-1K-10-10-10-10-26
FMS14-12AY	26-10-10-10-1Y-1Y-1Y-1Y-26
FMS14-12B	#10-10-10#--26-26-#10-10-10#
FMS14-12BA	1-10-1-10-1-10-1-2B-26-26
FMS14-12BC	16-16-16-16-26-26
FMS14-12BD	10KB-10KB-10KB-26-26-10KB-10KB-10KB
FMS14-12BE	1-1-9-10-10-10-1-10-26-26
FMS14-12BG	1Y-1G-1-1B-1Y-1G-1-1B-1Y-1G-1-1B-26-26
FMS14-12BH	1-1-1-10-10-10-1B-1B-1-26-26
FMS14-12C	1-1-1-1W-26-26-10-10-10-10
FMS14-12D	10-10-10-10-1-1-1K-1K-26-26
FMS14-12E	26-10-10-10-10-1-1-1-1-26
FMS14-12F	10-10-10-10-1B-1B-1B-26-26
FMS14-12G	1B-1B-1B-1B-1B-2B-1B-2B-26-26
FMS14-12H	10-10-10-10-10-10-26-26

FMS 14 Pole Test Switches

Part Number	Arrangement
FMS14-12I	1-1-1-10-1-10-1-10-1-26-26
FMS14-12J	1-1-1-1-10-10-10-1-1-26-26
FMS14-12K	1-10-1-10-1-10-1-1-1-26-26
FMS14-12L	10-10-10-1-1-1-1-26-26-2KW
FMS14-12M	1-10-1-10-1-10-1-10-26-26
FMS14-12N	10-10-10-26-26-10-10-10
FMS14-12P	1-1-1-1-10-10-10-10-26-26
FMS14-12Q	1K-1K-1K-24-10-10-10-26-26
FMS14-12R	1K-1K-1K-1-1-1-1-1-1-1-1K-26-26
FMS14-12S	1B-1B-1B-10-10-10-1B-26-26-1B-1B
FMS14-12T	10-10-10-26-10-10-10-26
FMS14-12U	1K-1K-1K-10-10-10-26-26-1-1
FMS14-12V	1K-1K-1K-1-1-1-1-1-1-1-1-26-26
FMS14-12W	1K-1K-1K-1K-10-10-10-1K-1K-26-26
FMS14-12X	1-1-1-10-10-10-1W-26-26-1-1W
FMS14-12Y	26-10-10-10-10-1K-1K-1K-26
FMS14-12Z	10R-10Y-10B-10-26-26-1-1Y-1B-1K
FMS14-13A	1-1-1-1-1-1-1-1-1-1-1-1-26
FMS14-13B	10-9-10-10-10-9-16-26
FMS14-13C	10-10-10-1-1-1-1-1-1-26
FMS14-13D	10-10-10-26-1-10-10-10
FMS14-13E	1N-1E-1Y-24-2-26-10-10-10-1B
FMS14-13ER	2-2B-16E-2W-2W-2W-26
FMS14-13F	1G-1-1G-1-1G-1-1-1W-1Y-1Y-1Y-26-1-1W
FMS14-14A	1-1-1-1-1-1-1-1-1-1-1-1-1
FMS14-14AB	1K-1K-2K-1-1Y-1B-1W-10R-10Y-10B
FMS14-14AC	2K-1-1Y-1B-1W-10R-10Y-10B-10W
FMS14-14AD	1B-1B-1B-1B-1B-10-10-10-10
FMS14-14AE	10-10-10-10-1B-1B-1B-2B
FMS14-14AF	1K-1K-1K-1K-1K-1K-1K-10-10-10
FMS14-14AG	1-1-1-24-1W-1W-1-1G-10-10-10
FMS14-14AH	2K-2K-2K-2K-2K-2K-1-1
FMS14-14AJ	1-1-1-10-10-10-10-1-1-1
FMS14-14AK	1K-1K-1K-1K-1K-1K-1K-10-10-10-9
FMS14-14AL	10E-10E-10E-1B-1B-10E-10E-1B
FMS14-14AM	10E-10E-10E-10E-1B-10E-10E-1B
FMS14-14AN	10-10-10-10-2Y-2-1-1
FMS14-14AP	1K-1K-1-1-1K-1K-1K-10-10-10-9
FMS14-14AQ	1-1-1-1B-1B-1B-10-10-10-10
FMS14-14AR	10-10-10-1K-1K-1K-1-1-1-1
FMS14-14AS	13B-13B-13B-1B-1B-1B-1B-1B-1B
FMS14-14AT	10-10-10-1-1-1-1-1-1-1-1
FMS14-14AU	1-1K-1K-10-10-10-9-10-1K-1K
FMS14-14AV	1-1-1-1-1-9-10-10-10-10
FMS14-14AW	9-10-10-10-9-10-10-10
FMS14-14AX	1Y-1Y-1-1-1-1-10-10-10-10
FMS14-14AY	1-1-1-1-10-10-10-10-10
FMS14-14AZ	1-1-1K-1K-1K-1K-1K-1K-1K-1K-1K-1K

Color Key: k: Black b: Blue g: Green e: Orange r: Red w: White n: Brown y: Yellow p: Purple

FMS Semiflush-Mounted Test Switches

FMS Test Switches

FMS 14 Pole Test Switches

Part Number	Arrangement
FMS14-14A1	1K-1K-1K-1K-1K-1K-1K-1K-1K-1K-1K-1K
FMS14-14B	2-2-2-2-2-2-2
FMS14-14BA	1-10-1-10-1-10-1-10-10
FMS14-14BB	10E-10E-10E-10E-10E-1K-1K-1K-1
FMS14-14BC	10E-10E-10E-10E-10E-10E-1K-1
FMS14-14BD	1Y-1Y-1Y-1Y-1Y-1Y-1Y-1Y-1Y-1Y-1Y-1Y
FMS14-14BE	2K-2K-2K-#1K-1K-1K-1K-#2K-2K
FMS14-14BF	1-1-1-1K-1K-1K-10-10-10-10
FMS14-14BG	10-10-10-10-1B-1B-1B-1B-1B-1B
FMS14-14BH	1K-1K-1K-1K-1-1-1-1-1-1-1-1-1
FMS14-14BI	10-10-10-10-10-10-1B-1B
FMS14-14BJ	1B-1B-10-10-10-10-10-10
FMS14-14BK	10-10-10-10B-1K-1K-1K-1-1-1
FMS14-14BL	1B-1B-1B-1B-1B-1B-1B-1B-1B-1B-1B-1B
FMS14-14BM	1-1-1-1-1-1-1B-1B-1B-1B-1B-1B-1B
FMS14-14BN	1K-1K-1K-1-1-1-1-1-1-1-1-1-1
FMS14-14BO	1K-1K-1K-1K-10-10-10-1K-1K-1K-1K
FMS14-14BP	1K-1K-1K-10-10-10-1K-1-1-1-1
FMS14-14BQ	1B-1B-1B-10-10-10-10-1B-1-1
FMS14-14BR	10-10-10-1K-1K-10-10-10
FMS14-14BS	1-1-1-1-1K-1K-1K-1K-1K-1K-1K-1K-1K
FMS14-14BT	2K-2K-2K-2K-2K-2K-2K
FMS14-14BU	10-10-10-10-1B-1E-1Y-1G-1K-1
FMS14-14BV	10-10-10-9-10-10-10-9
FMS14-14BW	1K-1K-1K-10-10-10-10-1K-1-1
FMS14-14BX	1K-1K-1K-1K-1K-1K-1K-1K-1K-1-1-1-1
FMS14-14BY	1-1-1-1-1-1-1K-1K-1Y-1Y-1Y-1Y-1Y-1Y
FMS14-14BZ	2Y-2Y-2-2-2-2-2BN
FMS14-14C	1-1-1-10-10-10-1-1-1-1-1
FMS14-14CA	1-1-2K-16K-10-10-10-1K
FMS14-14CB	1K-1K-1K-1K-10-10-10-10-10
FMS14-14CC	10R-10R-10R-1B-1B-1B-10R-24-1E-1E
FMS14-14CD	1K-1B-1-1E-10-10B-10R-10E-1K-1K
FMS14-14CE	10-10-10-1K-1K-1K-1K-1K-1K-1K-1K
FMS14-14CF	10-10-10-10-10-10-1K-1K
FMS14-14CG	2Y-2Y-2Y-2Y-2Y-2Y-2Y
FMS14-14CH	10R-10-10B-10R-10-10B-1K-1K
FMS14-14CI	1-1K-1B-1W-10R-10-10B-10W-1K-1K
FMS14-14CJ	1-1-1-10-10-10-1B-1B-1B-1B-1B
FMS14-14CK	10-10-10-10-1K-1K-1K-1K-1K-1K
FMS14-14CL	10-10-10-1-10-10-10-1
FMS14-14CM	1B-1B-1B-1B-10-10-10-10-1-1
FMS14-14CN	1-1-1-1-1E-1E-1Y-1Y-1Y-1Y-1W-1W-1W-1W
FMS14-14CO	1-1-1-1-1-1-1Y-1Y-1Y-1Y-1W-1W-1W-1W
FMS14-14CP	1K-1K-1K-1K-10-10-10-10-1K-1K
FMS14-14CQ	1-1-1-1-1-1-1-1-1K-1K-1K-1K-1K-1K
FMS14-14CR	1-1-1-1-10-10-10-9-1-1-1
FMS14-14CS	10-10-10-1B-1B-1B-1-1-1K-1K-1K
FMS14-14CT	#6-6-6-9#-1-1-1-1-1-1-1-1-1
FMS14-14CU	1-1-1-1-1B-1Y-10-10-10-10
FMS14-14CV	1-10-1-10-1-10-1-1-1-1-1
FMS14-14CW	1-1-1-1-1-1-1-1-1K-2K-1K-1K-1K

FMS 14 Pole Test Switches

Part Number	Arrangement
FMS14-14CX	1-1-1-10-10-10-10-1-1B-1K
FMS14-14CY	6-6-6-9-6-6-6-9-1K-1K-1K-1K-1K
FMS14-14CZ	6-6-6-9-1-1-1-1-1K-1K-1K-1K-1K
FMS14-14D	1K-1K-1K-1K-1K-1K-10-10-10-10
FMS14-14DA	10R-10Y-10B-10-1-1-1-1Y-1B-1K
FMS14-14DB	1-1-1-1-1-1-1K-1K-1K-1K-1K-1K-1K
FMS14-14DC	10-10-10-16-1-1-1-1-1
FMS14-14DD	1-1-1-1-1-1-1-1-1-1-2K-2K
FMS14-14DE	1B-1B-1B-10B-10B-10B-1B-1B-1B-1B
FMS14-14DF	1Y-1Y-1B-1B-1B-1B-1B-1B-1B-1B-1B
FMS14-14DG	1Y-1Y-1B-1B-1B-1B-1B-1B-1B-1B-1W-1W
FMS14-14DH	10-10-10-10-1-1-1-1-1-1K
FMS14-14DI	1-1K-1-1K-1-1K-1-1K-1-1K-1-1K-1-1K
FMS14-14DJ	1K-1K-10-10-10-10-10-10
FMS14-14DK	10-10-10-10-9-9-9-9-9-9
FMS14-14DL	1K-1K-1K-1K-10R-10R-10R-1B-1B-1E-1E
FMS14-14DM	9-9-9-9-9-9-9-9-9-9-9-9
FMS14-14DN	1B-1B-1B-1B-1Y-1Y-10-10-10-10
FMS14-14DO	1-1-1-24-1Y-1Y-10-10-10-10
FMS14-14DP	1B-1B-1B-1B-1Y-1Y-1-1-1-1-1-1-1
FMS14-14DQ	1-1-1B-1B-1B-1B-10-10-10-10
FMS14-14DS	6-6-6-9-1K-1K-1K-1K-1-1-1-1-1-1
FMS14-14DT	6-6-6-9-6-6-6-9-10-1-1-1-1
FMS14-14DU	1-1-1B-1B-1W-1W-1-1-1B-1B-1W-1W-1-1
FMS14-14DV	1-1K-1-1K-1-1K-10E-10Y-10W-10B
FMS14-14DW	1-1-10Y-10W-10B-10Y-10W-10B
FMS14-14DX	2Y-2Y-2-2-2-2-2
FMS14-14DY	10-10-10-10-10-1-1-1-1
FMS14-14DZ	1-1-1-1-10-10-10-10-1B-1B
FMS14-14E	10-10-10-10-10-10-1-1
FMS14-14EA	1-1K-1-1K-1-1K-10RK-10RK-10RK-1K-1K
FMS14-14EB	1-10-10-10-10-1-1K-1K-1-1
FMS14-14EC	10-10-10-1K-1K-1K-1K-1K-1K-1K-1
FMS14-14ED	1-1-10-1-1-10-1-1-10-10
FMS14-14EF	1-1-1-1-1-1-10-10-10-1K-1K
FMS14-14EG	10-10-10-1-1-1-1-1-1-24-24
FMS14-14EH	1K-1K-1K-1K-1K-1K-10-10-10-1K-1K
FMS14-14EI	1K-1K-1K-1K-1K-1K-1K-1-1-10-10
FMS14-14EJ	1K-1K-1K-1K-1K-1K-1K-1K-1K-1K-1K-1E
FMS14-14EK	1K-1K-1K-1K-1K-1K-1K-1K-1K-1K-1-1
FMS14-14EL	6-24/6-24/6-24/10-10-10-1K-1K
FMS14-14EM	1K-1K-1K-1K-1K-1K-1K-1K-1K-1K-1K-10
FMS14-14EN	1K-1K-1K-1K-1K-1-1-1-1-1-1-1-1
FMS14-14EO	1K-1K-1K-10-10-10-1K-1-1-1-1
FMS14-14EP	1K-1K-1K-1-1-1-1-1-1-1-1-1-1K
FMS14-14EQ	1K-1K-1K-1K-1K-1K-1-1-1-1-1-1-1
FMS14-14ER	2-2B-2W-2W-2W-2W-2W-2W
FMS14-14ES	2W-2W-2W-2W-2W-2W-2W
FMS14-14ET	#6-6-6#-9-#6-6-6#-9-#6-6-6#-9-1-1
FMS14-14EU	10B-10W-10R-10K-1B-1W-1-24-1W-24
FMS14-14EV	1-1-1-10-10-10-10-10-10
FMS14-14EW	1K-1K-1K-1K-1K-1K-10-1K-1K-1K-1K-1K

Color Key: k: Black b: Blue g: Green e: Orange r: Red w: White n: Brown y: Yellow p: Purple

FMS 14 Pole Test Switches

Part Number	Arrangement
FMS14-14EX	1Y-1Y-1Y-1Y-1Y-1Y-1Y-1Y-1-1-1-1-1-1
FMS14-14EY	10EK-10EK-10EK-10EK-10EK-10EK-10EK
FMS14-14F	10-10-10-10-1-1-1-1-1-1
FMS14-14FA	10R-10R-10R-10R-1K-1K-1K-1K-1E-1E
FMS14-14FB	1K-1-1-1K-1K-1K-10-10-10-10
FMS14-14FC	1K-1K-1-1-1-1-1-1-1-1-1-1-1
FMS14-14FD	1K-1K-1K-10-10-10-10-1-1-1
FMS14-14FE	1-1-1K-1K-10-10-10-10-1K-1K
FMS14-14FF	1K-1K-1K-10-10-10-10W-1-1-1
FMS14-14FG	10-10-10-1Y-1Y-1Y-1Y-1Y-1Y-1Y-1Y
FMS14-14FH	9-1-1Y-1B-1G-10-10-10-1E-1E-9W
FMS14-14FI	9-10-10-10-1N-1N-1N-1E-1E-1E-9W
FMS14-14FK	9-10-10-10-10-10-10-9W
FMS14-14FM	20-9-1K-1K-1K-1K-1K-1K-1K-1K-1K-1K
FMS14-14FN	10-10-10-1-1-1-1-1B-1B-1B-1W
FMS14-14FO	10-10-10-1B-1B-10-10-10
FMS14-14FP	10-10-10-10-1-1-10-10
FMS14-14FQ	10-1-1-1-1-1-1B-1B-1B-1B-1B-1B-1B
FMS14-14FR	1N-1B-1B-1B-1B-1B-1B-1B-1Y-1W-1W-1W-1W-1W
FMS14-14FS	1-1-1-1-10-10-10-2-2
FMS14-14FT	10-10-10-1B-1B-1B-1B-1-1-1-1
FMS14-14FU	1K-1K-1K-24-10-10-10-10-1K-1K
FMS14-14FV	10R-10R-10R-10R-1G-1G-1G-1G-1G-1G
FMS14-14FW	10Y-10Y-10Y-1K-1K-1K-1K-1K-1-1-1
FMS14-14FX	16-1B-2RK-10-10-10-10
FMS14-14FY	1-1-1-1-1-1-1-1-1-1-1B-1B-1B-1B
FMS14-14G	10-10-10-10-10-10-10
FMS14-14GA	10Y-10Y-10Y-10Y-10Y-10Y-10Y
FMS14-14GB	1W-1W-1W-1W-1-1-10Y-10Y-10Y-10Y
FMS14-14GH	1K-1K-1K-1K-10-10-10-10-1-1
FMS14-14GI	10-10-10-10-1K-1K-1K-1K-1-1
FMS14-14GJ	1-10-10-10-10-10-10-1
FMS14-14GK	1-#10#-#10#-#10#-#10#-#10#-#10#-1
FMS14-14GL	10-10-10-10-1-1-1K-1K-1K-1K
FMS14-14GM	10-10-10-10-1B-1B-1B-1B-2
FMS14-14GN	1-1K-1K-1K-1K-10-10-10-10-9
FMS14-14GO	2K-1E-1E-1E-1E-10R-10Y-10B-10W
FMS14-14GP	1-1-10-10-10-10-10-10
FMS14-14GQ	1-1-1-1-10-10-10-1-1-1-1
FMS14-14GR	10-10-10-1B-1B-1B-1B-1-1-1Y-1Y
FMS14-14GS	10-10-10-1-1-1Y-1Y-1Y-1Y-1Y-1Y
FMS14-14GT	10-10-10-10-1-1Y-1Y-1Y-1Y-1Y
FMS14-14GU	10-10-10-10-1B-1B-1B-1Y-1Y-1Y
FMS14-14GV	10-10-10-1B-1B-1B-1Y-1Y-1Y-1Y-1Y
FMS14-14GW	10-10-10-1-1-1-1-1K-1K-1K-1K
FMS14-14GX	10-10-10-1-1-1-1-1Y-1Y-1Y-1Y
FMS14-14GY	1K-1K-1K-10-10-10-1W-1K-1K-1B-1E
FMS14-14H	1K-1K-10-10-10-10-10-1K-1K
FMS14-14HA	1K-10-10-10-10-10-10-1K
FMS14-14HB	1E-1E-1E-1E-1E-1E-1E-1E-1W-1W-1W-1E-1E
FMS14-14HC	1W-1B-1B-1B-1B-1B-1B-1B-1B-1B-1W-1W
FMS14-14HD	1W-1W-1W-1W-1W-1W-1W-1W-1W-1W-1W-1W

FMS 14 Pole Test Switches

Part Number	Arrangement
FMS14-14HE	1-1-1-1-1-1-1-1-10-10-10
FMS14-14HF	1B-1B-1B-1B-1B-1Y-1Y-1-10-10-10
FMS14-14HG	10-10-10-10-1Y-1Y-1B-1B-1B-1B
FMS14-14HI	1B-1B-1B-1B-1Y-1Y-1-1-10-10-10
FMS14-14HJ	10R-10R-10R-1K-1K-10Y-10Y-10Y
FMS14-14HK	10-10-10-1B-1B-1B-1B-1B-1Y-1Y
FMS14-14HL	10R-10R-10R-10R-10R-10R-10R
FMS14-14HM	1B-1B-1B-10-10-10-1B-1K-1K-1K-1K
FMS14-14HN	1K-10-10-10-1K-1K-1K-1K-1K-1K
FMS14-14HO	1K-1K-1K-1K-1-1-1-1-1K-1K-1K-1K-1K
FMS14-14HP	1B-1B-1K-1K-1K-1K-1K-1K-1K-1K-1K-1K
FMS14-14HQ	1K-1K-1-1-1K-1K-1K-1K-1K-1K-1K-1
FMS14-14HR	1-1-1-1-1K-1K-1K-1K-1K-1K-1K-1K-1K
FMS14-14HS	1-1-1-1-10-10-10-1W-1W-1W-1W
FMS14-14HT	1K-10-10-10-10-1K-1K-1K-1K-1K
FMS14-14HU	1K-1K-1K-1K-1K-1-1-1-10-10-10
FMS14-14HV	10-10-10-1K-10-10-10-1K
FMS14-14HW	2Y-2Y-2K-2-2-2-2
FMS14-14HX	1-10-10-10-1-1-1-1B-1B-1B-1B
FMS14-14HY	1E-1B-1G-24-10KW-10YW-10RW-#1-1K-1Y-1Y#
FMS14-14HZ	1-10-1-10-1-10-1G-1G-1G-1G-1G
FMS14-14I	10-10-10-10-10-2-2
FMS14-14IA	10W-10W-10W-10W-1-1-1-1-1-1
FMS14-14IB	10W-10W-10W-10W-10W-10W-1-1
FMS14-14IC	10-10-10-6-6-6-9-10-1K-1K
FMS14-14ID	6-6-6-9-6-6-6-9-10-10-1K-1K
FMS14-14IE	1K-1K-1K-1K-10-10-10-1-1-1-1
FMS14-14IF	1-1-1B-1B-1B-1B-1B-1B-1B-1B-1B-1B
FMS14-14IG	1-1W-1G-1Y-1B-1E-1N-1K-1K-1K-1K-1K
FMS14-14IH	10-10-10-9-9-10-10-10 (#9 without blade)
FMS14-14IJ	10-10-10-10-1-1-1-1W-1Y-1Y
FMS14-14IK	1-10-10-10-10-1-1-1-1-1
FMS14-14IL	1-1Y-1B-1K-1K-1K-10R-10Y-10B-10
FMS14-14IM	10R-10Y-10B-10-10R-10Y-10B
FMS14-14IN	10-10-10-10-10W-10W-10W
FMS14-14IO	1E-1E-1E-10-10-10-1E-10-1-1G
FMS14-14IP	6-6-6-9-6-6-6-9-10-1K-1K-1K-1K
FMS14-14IQ	16-#6-6-6-5#-1B-1B-1B-1B-1B-1B
FMS14-14IR	10R-10Y-10B-1-1Y-1B-1K-1K-1K-1K-1K
FMS14-14IS	10B-10B-10B-10B-1-1-1-1-1-1
FMS14-14IT	10-10-10-10-2K-16K-24
FMS14-14IU	1K-1K-1K-10-10-10-24-1K-1K-1K-24
FMS14-14IV	10-1K-10-1K-10-1K-10-1K-1K-1K
FMS14-14IW	10-10-10-10-2-2-2
FMS14-14IX	10-10-10-2-2-2-2
FMS14-14IY	1-1-1-1-10-10-10-10-2
FMS14-14IZ	10-10-10-10-1K-1K-1K-2-1K
FMS14-14J	1K-1K-1G-1Y-1B-1B-1-1-1-1-1-1-1
FMS14-14JA	1K-1K-1K-10-10-10-10-1K-1-1K
FMS14-14JB	16-1-1K-1K-10-10-10-10
FMS14-14JC	1K-1K-1-1-1-1B-1B-1B-1Y-1Y-1Y-1Y-1Y
FMS14-14JD	1Y-1Y-1Y-1Y-1B-1B-1B-1B-1B-1B-1B

Color Key: k: Black b: Blue g: Green e: Orange r: Red w: White n: Brown y: Yellow p: Purple

FMS Semiflush-Mounted Test Switches

FMS Test Switches

FMS 14 Pole Test Switches

Part Number	Arrangement
FMS14-14JE	1B-1B-1-1-1-1-1-1-1-1-1-1-1-1-1-1
FMS14-14JF	10-10-10-10-1K-1K-1K-1-1-1-1
FMS14-14JG	10-10-10-1E-1E-1E-1E-1E-1B-1B-1B
FMS14-14JH	10-1B-1B-1B-1B-1B-1B-1B-1E-1E-1E-1E
FMS14-14JI	1-1-1-10-10-10-10-1-1-1-1B-1B
FMS14-14JJ	1-1-1-10-10-10-10-10-1B-1B-1B
FMS14-14JK	2-10-10-10-10-10-10
FMS14-14JL	1-1K-1K-1K-1K-10-1K-1K-1-1-1-1-1
FMS14-14JM	16-#6-6-6-6-5#-1B-1B-1B-1B-1B-1B
FMS14-14JN	1-1-1-1-#6-6-6-6-5#-1B-1B-1B-1B-1B
FMS14-14JO	10-10-10-10-1-1-1-1-1Y-1Y
FMS14-14JP	10-10-10-24-1-1-1-1-1-1-1
FMS14-14JQ	1K-1K-1K-1K-1K-1K-1W-1W-1W-1W-1W-1W-1W-1W-1W-1W
FMS14-14JR	1-1-1K-1K-1K-9-10-10-10-10
FMS14-14JT	1Y-1E-1E-1-1-1-10-10-10-10
FMS14-14JU	10-10-10-10-16-24-2
FMS14-14JV	1-1-1-1-1K-1K-1K-1K-10-10-10
FMS14-14JW	10B-10B-10B-10B-2K-16K-1K
FMS14-14JX	1-1-1-10-10-10-10-1K-1K-1K
FMS14-14JY	10-10-10-1-1-1K-1K-1K-1K-1K-1K
FMS14-14JZ	#6-6-6-9#-#6-6-6-9#-#6-6-6-9#-10
FMS14-14K	1K-1K-1K-10-10-10-1K-1-1K-1K-1K
FMS14-14KB	1Y-1-1-1-10-10-10-10
FMS14-14KC	#6-6-6-9#-10-10-1-1-1-1-1-1
FMS14-14KF	#6-6-6-9#-#6-6-6-9#-1-1-1-1-1-1
FMS14-14KG	1-1-1-1-2-10-10-10-10
FMS14-14KH	1-1-1-1-2RK-10-10-10-10
FMS14-14KI	10-1Y-1Y-1Y-1Y-1Y-1Y-1Y-1Y-1Y-1Y-1Y
FMS14-14KJ	1-1-9-10-10-10-1-10-10
FMS14-14KL	#6-6-6-9#-#6-6-6-9#-10-1-1-1-1-1
FMS14-14KM	1K-1K-1K-24-10-10-10-10-1-1
FMS14-14KN	1K-1K-1K-1E-1E-1E-6W-6W-6W-1W-2-2
FMS14-14KP	1-1K-1K-1K-1K-1K-1K-10-10-10-9
FMS14-14KQ	16-2-#6-6-6-6-5#-1B-1B-1B-1B
FMS14-14KR	#6-6-6-5#-#6-6-6-5#-#6-6-6-5#-1K-1K
FMS14-14KS	#1-1-1-1#-1B-1B-1B-1B-1B-1B-1B-1B-1B-1B
FMS14-14KT	2K-2K-2K-2K-2K-2K-2
FMS14-14KU	2K-2K-2K-2-2-2-2
FMS14-14KV	1E-1E-1E-1E-10-10-10-10-1G-1
FMS14-14KW	1-1-10-10-10-10-1-1-1-1
FMS14-14KZ	1-1-1-1-1-1-1-1-1-1-1-1-1-1-1-10
FMS14-14L	1-1-1-1-1B-1B-10-10-10-10

FMS 14 Pole Test Switches

Part Number	Arrangement
FMS14-14LA	10-10-10-10-1-1-1-1-1B-1B-1B
FMS14-14LB	10-10-10-9-10Y-10Y-10Y-9Y
FMS14-14LC	1-1-1-24-10-10-10-1B-1B-1B-1B
FMS14-14LD	#10-10#-#10B-10B#-#10G#-#10W#1Y-1
FMS14-14LE	1-10-1-10-1-10-1-1-1-1B-1B
FMS14-14LF	1-1-1-1-1-1-1-1-1-1-#6-6-6-9#
FMS14-14LG	#6-6-6-9#-1-1-1-1-1-1-#6-6-6-9#
FMS14-14LH	2-2-1-1-1-1-1-1-1-1-1-1
FMS14-14LI	2K-16-10-10-10-10-1W
FMS14-14LJ	2-2-2-2-2-2-1-1
FMS14-14LK	1-1-1-1-1-1-1-1-1-1K-1K-1K-1K-1K
FMS14-14LM	10-10-10-1K-1K-1K-1-1-1-1-1
FMS14-14LN	10-10-10-10-10-10-2K
FMS14-14LO	10-10-10-1K-1K-1K-1-1-1-2
FMS14-14LP	1-1G-1-1G-1-1G-1-1W-1Y-1Y-1Y-1N-1-1W
FMS14-14LQ	10-10R-10B-10-10R-10B-10W
FMS14-14LR	1E-1E-1E-10-10R-10B-10W-1K-1-1B
FMS14-14LS	1E-1E-1E-1E-1E-1E-1E-1K-1-1B-10-10R
FMS14-14LT	10B-10-10R-10B-10-10R-10B
FMS14-14LU	1E-1E-1E-1E-1E-1E-1E-1E-1E-1E-1E-1E
FMS14-14LV	10-10-10-10-1K-1K-1K-1K-1K-1
FMS14-14LW	10-10-10-10B-10B-10B-10W
FMS14-14LX	11-11-11-9-11-11-11-9
FMS14-14LY	1Y-1E-10-10-10-10-10-10
FMS14-14M	1-1-1-10-10-10-1W-1G-1E-1Y-1B
FMS14-14MA	10R-10R-10R-10R-1K-1K-1K-1K-1K-1K
FMS14-14MB	10Y-10Y-10Y-1K-1K-1K-1K-1-1-1-1
FMS14-14MC	1W-1W-1W-1W-1W-1W-1W-1W-1B-1B-1B-1B-1B
FMS14-14N	16-1-2-10-10-10-10
FMS14-14P	16-1-10-10-10-10-1B-1B
FMS14-14Q	1-1-1-10-10-10-1-10-1-1
FMS14-14R	10-10-10-10-10-10-2
FMS14-14S	#10#-#10#-#10#-1-#10#-#10#-#10#-1
FMS14-14T	1-10-1-10-1-10-1-10-1-1
FMS14-14U	1K-1K-1K-10-10-10-1K-1K-1K-1K-1K
FMS14-14V	1-1-1-10-10-10-10W-1W-1K-1K
FMS14-14W	1-1-1-1-10-10-10-10-1-1
FMS14-14X	1K-1K-2B-1-1Y-1B-1W-10R-10Y-10B
FMS14-14Y	1K-1K-1K-10-10-10-10-1K-1K-1K
FMS14-14Z	1-1-1-1-1-1-10-10-10-10

Please refer to the STATES website for more part numbers and up to date information.

Color Key: k: Black b: Blue g: Green e: Orange r: Red w: White n: Brown y: Yellow p: Purple

FMS

Rack Mount Systems

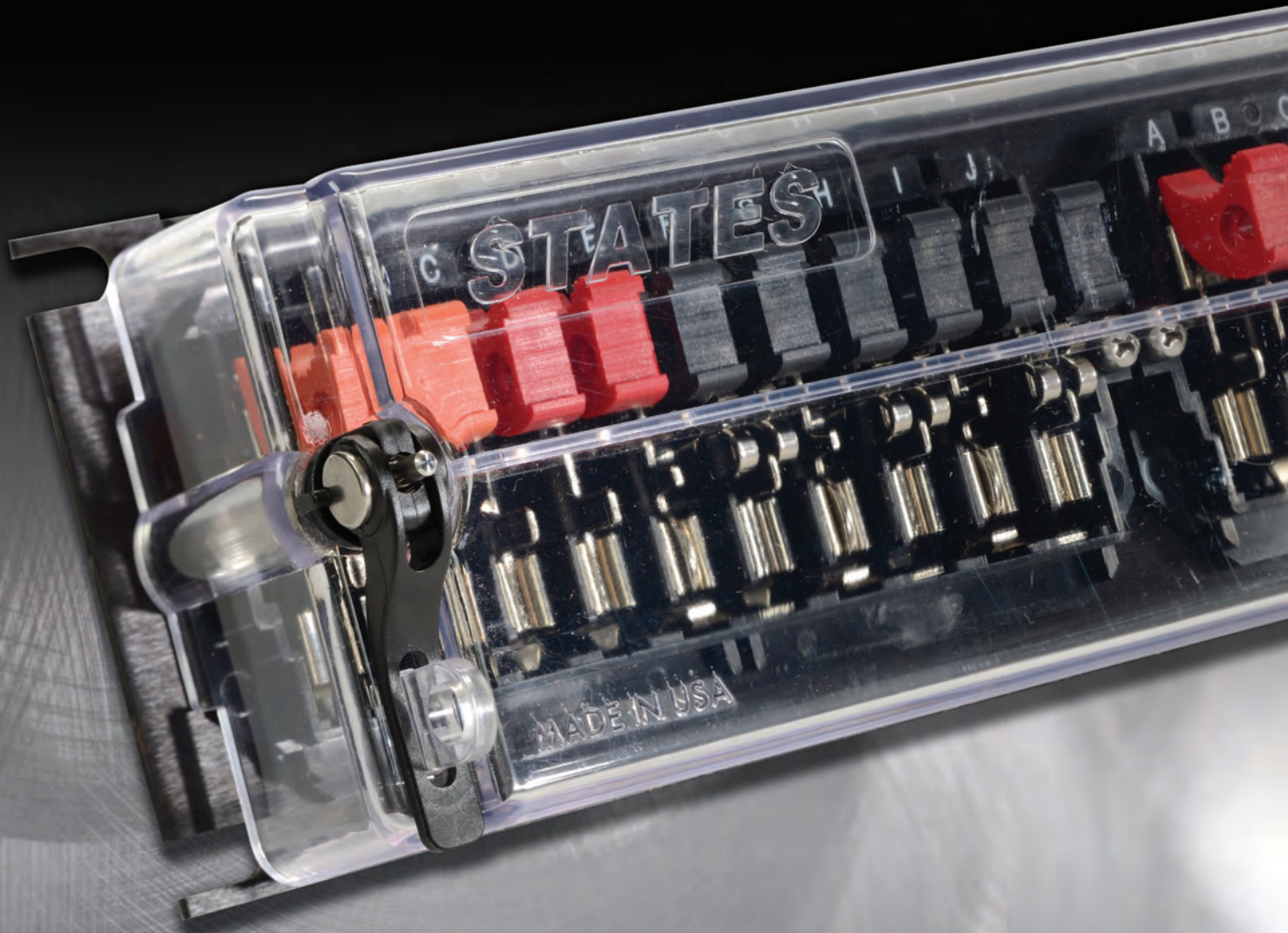

- Safe, durable, rugged and reliable
- Compact and versatile
- Constructed of 1/8 inch thick aluminum
- Both of the STATES Rack Mount Systems are recognized by UL and CSA

STATES®

FMS 19 INCH RACK MOUNTING SYSTEM

The STATES FMS 19" Rack Mount System has the capacity for up to 30 configurable poles in one platform with one continuous cover in order to meet the requirements of your protection system design. It comes conveniently installed in a 19 inch wide aluminum plate which comes in 3 different rack unit heights for your selection. The plates are available in standard brushed aluminum finish, with three additional colors as options. Please see the Ordering Information page for the color options.

FEATURES AND BENEFITS

- No downtime
- Easy access
- Secure
- Use standard plugs
- Safe to use
- Choice of operation
- Cost-saving advantage



FMS 19" Rack with deeper, wider, clear cover



See at a glance if a switch blade is open or closed when using the optional deeper, wider, clear cover



FMS 19" Rack with black cover

FMS Semiflush-Mounted Test Switches (19 inch Rack Mount)

COVERS

Both the double and triple rack units come standard with black covers. Optional clear covers, both deeper, wider and narrow, are available. Both cover types completely seal the test switches and are provided with captive nuts and provisions for lock out tags (only on deeper, wider, clear covers). Clear cover kits are also available to replace existing black covers.

FMS
Test Switches



FMS 19" Rack 30 Pole Black Cover



FMS 19" Rack 30 Pole Narrow Clear Cover



FMS 19" Rack 30 Pole Deeper, Wider, Clear Cover



STATES FMS 19" Rack 30 Pole with deeper, wider, clear cover shown above with lock-out feature

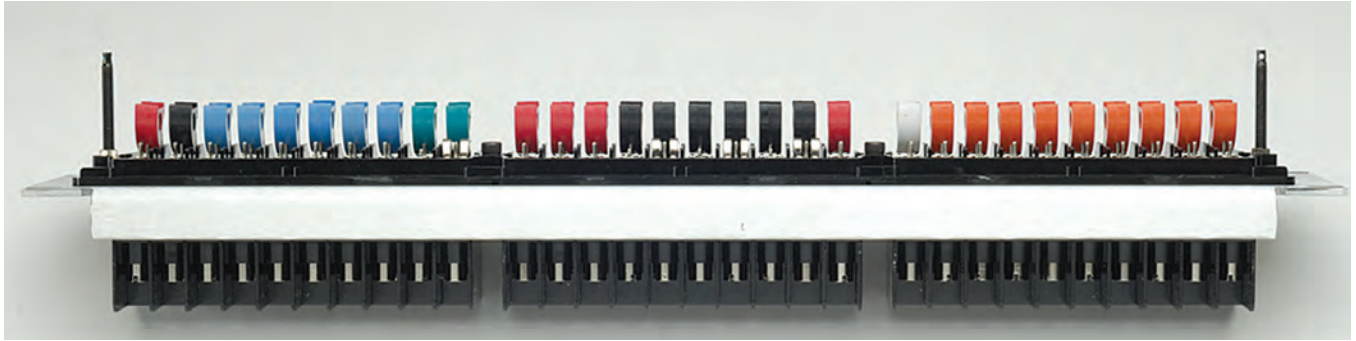

Side view of a 30 Pole FMS 19" Rack Mount System without cover

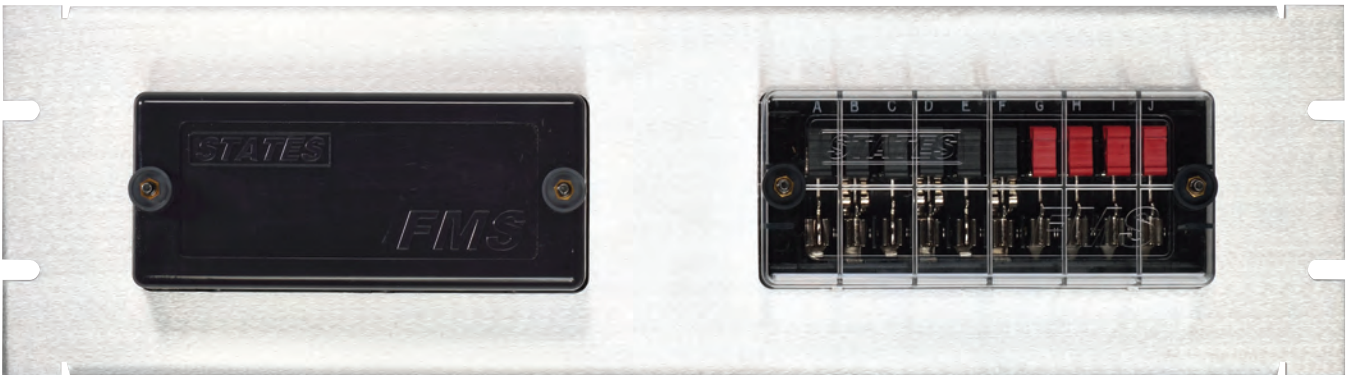

FMS 19" Rack 20 pole unit shown with a black cover and a narrow clear cover



FMS 19" Rack 20 pole unit shown without covers

For Rack Plate mounting dimensions, please refer to page 63.

FMS Semiflush-Mounted Test Switches (19 inch Rack Mount)

STATES 19" RACK MOUNT SYSTEM

FMS Test Switches

Understanding FMS 19" Rack Mount Part Numbers - 20 Pole Switch Units						
1	2	3	4	5	6	7
Lockout (optional)	Cover Type	Rack Size	Plate Type/Finish	Switch A	Switch B	Terminal Type
L = Lockout NOTE: The lockout is ONLY available with the No. 2 Clear Wide Cover	1 = Black Cover 2 = Deeper, Wider Clear Cover 3 = Narrow Clear Cover	2RU 92 = 19 x 3.5 3RU 93 = 19 x 5.25 4RU 94 = 19 x 7	Center Mount R = Brushed Aluminum RG = ANSI 61 Gray RH = ANSI 70 Gray RB = Black Anodized Lower Mount LR = Brushed Aluminum LRG = ANSI 61 Gray LRH = ANSI 70 Gray LRB = Black Anodized NOTE: Lower mounting plates are only available in the following sizes: 19 x 5.25 & 19 x 7	See catalog page 25, or visit our website at www.statesproducts.com for arrangement options	See catalog page 25, or visit our website at www.statesproducts.com for arrangement options	Switches are provided with screw terminals unless otherwise specified by adding -ST for Stud Terminals

Understanding FMS 19" Rack Mount Part Numbers - 30 Pole Switch Units							
1	2	3	4	5	6	7	8
Lockout (optional)	Cover Type	Rack Size	Plate Type / Finish	Switch A	Switch B	Switch C	Terminal Type
L = Lockout NOTE: The lockout is ONLY available with the No. 2 Clear Wide Cover	1 = Black Cover 2 = Deeper, Wider Clear Cover 3 = Narrow Clear Cover	2RU 92 = 19 x 3.5 3RU 93 = 19 x 5.25 4RU 94 = 19 x 7	Center Mount R = Brushed Aluminum RG = ANSI 61 Gray RH = ANSI 70 Gray RB = Black Anodized Lower Mount LR = Brushed Aluminum LRG = ANSI 61 Gray LRH = ANSI 70 Gray LRB = Black Anodized NOTE: Lower mounting plates are only available in the following sizes: 19 x 5.25 & 19 x 7	See catalog page 25, or visit our website at www.statesproducts.com for arrangement options	See catalog page 25, or visit our website at www.statesproducts.com for arrangement options	See catalog page 25, or visit our website at www.statesproducts.com for arrangement options	Switches are provided with screw terminals unless otherwise specified by adding -ST for Stud Terminals

EXAMPLES

<u>3</u> 2	-	<u>92</u> <u>R</u> 3 4	-	<u>220F</u> 5 6
---------------	---	---------------------------	---	--------------------

Part No. 392R-220F

2RU 20 Pole Rack - 2 Individual FMS-10A switches, with individual narrow clear covers, mounted on a center mount brushed aluminum plate with screw terminals.

<u>L</u> 1	<u>2</u> 2	<u>93</u> 3	<u>LRG</u> 4	-	<u>330S</u> 5 6 7	-	<u>ST</u> 8
---------------	---------------	----------------	-----------------	---	----------------------	---	----------------

Part No. L293LRG-330S-ST

3RU 30 Pole Rack - 30 pole deep, wide, clear cover with lockout feature installed on a 19x5.25 lower mounted ANSI 61 gray plate, consisting of 3 FMS-10A switches with stud terminals.

ORDERING INFORMATION

The catalog numbers under the arrangements beginning on page 25 will be helpful in determining the switch you need. Always use the front view, left to right, when specifying the layout.

To order switches with stud terminals, please specify the desired arrangement and add the suffix –ST to the part number.

Example: 192R-220A-ST

A black cover comes standard with the FMS switches, so there is no need for any special designations. To order the optional deeper, wider, clear cover, please substitute a “2” in place of the “1”.

Example: 292R-220A

To order the optional FMS Lockout Kit installed on the 19” Rack Mount System, please use prefix “L2”.

Example: L292R-220A

To order the FMS Lockout Kit separately, please use Part No. FMSLOCK-1. The lockout can only be used on the clear, wide (2) cover.

To order the optional narrow clear cover, please substitute a “3” in place of the “1”.

Example: 392R-220A

To order an optional plate color, please use the following:

“RG” for ANSI 61 Gray
“RH” for ANSI 70 Gray
“RB” for Black Anodized

Example: 192RG-220A

What you need to know before placing your order:

Size of mounting plate: 3½ x 19, 5¼ x 19, 7 x 19

Color of mounting plate: brushed aluminum, black anodized, ANSI 61 gray, ANSI 70 gray

Type of cover: black, clear (wide or narrow)

Terminal type: screw or stud

How many switches: 1 - 30

Switch layout: Please refer to the FMS Switch Elements on page 20 for customized layouts if you cannot find your desired switch listed in the 10 or 14 pole arrangements on pages 26 - 40.

Custom mounting plate colors are available, and are subject to minimum orders.

FMS 19” Rack Double 14 and 10/14 along with 22” Rack Mount Systems are also available upon request.

If you require additional information, pricing, lead times, please contact our sales office either by phone (800) 325-4574, fax (214) 331-7368 or by email at states@megger.com.

FMS Semiflush-Mounted Test Switches (19 inch Rack Mount)

FMS
Test Switches

2RU 19x3.5 Racks

Catalog No.	Switch A	Switch B	Switch C
192R-310A	FMS-10A	FMS-BLANK	FMS-BLANK
192R-310AH	FMS-10AH	FMS-BLANK	FMS-BLANK
192R-310A1	FMS-10A1	FMS-BLANK	FMS-BLANK
192R-310CH	FMS-10E1	FMS-BLANK	FMS-BLANK
192R-310E4	FMS-10E4	FMS-BLANK	FMS-BLANK
192R-310F8	FMS-10F8	FMS-BLANK	FMS-BLANK
192R-310FY	FMS-10C	FMS-BLANK	FMS-BLANK
192R-310G2	FMS-10F9	FMS-BLANK	FMS-BLANK
192R-310GN	FMS-BLANK	FMS-10GN	FMS-BLANK
192R-310H8	FMS-10H8	FMS-BLANK	FMS-BLANK
192R-310HE	FMS-10HE	FMS-BLANK	FMS-BLANK
192R-310HT	FMS-10FF	FMS-BLANK	FMS-BLANK
192R-310JN	FMS-BLANK	FMS-BLANK	FMS-10HZ
192R-310W9	FMS-BLANK	FMS-BLANK	FMS-10W9
192R-310WQ	FMS-10WQ	FMS-BLANK	FMS-BLANK
192R-310XV	FMS-10G	FMS-BLANK	FMS-BLANK
192R-310YE	FMS-10YE	FMS-BLANK	FMS-BLANK
192R-310Z	FMS-BLANK	FMS-10E	FMS-BLANK
192R-314CC	FMS-04AG	FMS-10NU	FMS-BLANK
192R-318AV	FMS-06AV	FMS-06AV	FMS-06AV
192R-318DC	FMS-08G	FMS-10A1	FMS-BLANK
192R-318FV	FMS-06AF	FMS-06AV	FMS-06AF
192R-318WR	FMS-04W	FMS-04W	FMS-10NV
192R-320A3A	FMS-10A3	FMS-10A	FMS-BLANK
192R-320AB	FMS-10E	FMS-BLANK	FMS-10E
192R-320AB1	FMS-10E1	FMS-BLANK	FMS-10E1
192R-320AC	FMS-10A	FMS-BLANK	FMS-10A
192R-320AC1	FMS-10A1	FMS-10E1	FMS-BLANK
192R-320AC2	FMS-10A1	FMS-10A	FMS-BLANK
192R-320AC3	FMS-10E1	FMS-10A1	FMS-BLANK
192R-320AC4	FMS-10A	FMS-10A	FMS-BLANK
192R-320AC5	FMS-10Z	FMS-BLANK	FMS-10A1
192R-320AC6	FMS-10E3	FMS-10A	FMS-BLANK
192R-320AC7	FMS-10A1	FMS-BLANK	FMS-10A1
192R-320AC8	FMS-10F8	FMS-10F9	FMS-BLANK
192R-320AC9	FMS-10F8	FMS-10A1	FMS-BLANK
192R-320AF	FMS-10A1	FMS-10F9	FMS-BLANK
192R-320AGN	FMS-10A	FMS-10GN	FMS-BLANK
192R-320AK	FMS-10JS	FMS-10JS	FMS-BLANK
192R-320AK1	FMS-10G	FMS-10A1	FMS-BLANK
192R-320AK2	FMS-10FF	FMS-10A1	FMS-BLANK
192R-320AK3	FMS-10E4	FMS-10A1	FMS-BLANK
192R-320AK4	FMS-10H8	FMS-10F9	FMS-BLANK
192R-320AK5	FMS-10F9	FMS-10A1	FMS-BLANK
192R-320AK6	FMS-10K1	FMS-BLANK	FMS-10A1
192R-320AK7	FMS-10GN	FMS-BLANK	FMS-10A1
192R-320BA	FMS-10F	FMS-BLANK	FMS-10A
192R-320BC	FMS-10TM	FMS-10GA	FMS-BLANK
192R-320BD	FMS-10TM	FMS-10A1	FMS-BLANK
192R-320BE	FMS-10G	FMS-10F9	FMS-BLANK
192R-320BF	FMS-10IO	FMS-10GS	FMS-BLANK
192R-320BK	FMS-10C	FMS-10A	FMS-BLANK
192R-320BL	FMS-10IO	FMS-10JJ	FMS-BLANK
192R-320CE	FMS-10HE	FMS-10HE	FMS-BLANK
192R-320CH	FMS-10GK	FMS-BLANK	FMS-10GK
192R-320CQ	FMS-10FI	FMS-BLANK	FMS-10FA
192R-320CW	FMS-08CH	FMS-08CI	FMS-04W
192R-320DA	FMS-10H9	FMS-10H9	FMS-BLANK

2RU 19x3.5 Racks

Catalog No.	Switch A	Switch B	Switch C
192R-320DB	FMS-10A1	FMS-10A1	FMS-BLANK
192R-320DC	FMS-10F9	FMS-10F9	FMS-BLANK
192R-320DG	FMS-10F	FMS-BLANK	FMS-10A1
192R-320DQ	FMS-10GM	FMS-10A1	FMS-BLANK
192R-320DV	FMS-10JS	FMS-BLANK	FMS-10JR
192R-320DX	FMS-10W5	FMS-10A1	FMS-BLANK
192R-320DY	FMS-BLANK	FMS-10A	FMS-10GT
192R-320EM	FMS-BLANK	FMS-10FF	FMS-10FF
192R-320ET	FMS-10A1	FMS-10JJ	FMS-BLANK
192R-320FA	FMS-10E1	FMS-10E1	FMS-BLANK
192R-320FF	FMS-10F	FMS-10F	FMS-BLANK
192R-320F5	FMS-10C	FMS-BLANK	FMS-10C
192R-320GF	FMS-10G	FMS-10A1	FMS-BLANK
192R-320GG	FMS-10G	FMS-10A	FMS-BLANK
192R-320GH	FMS-10A1	FMS-BLANK	FMS-10GS
192R-320GS	FMS-10F	FMS-10UF	FMS-BLANK
192R-320GV	FMS-10E	FMS-10A	FMS-BLANK
192R-320HA	FMS-10Z	FMS-10A1	FMS-BLANK
192R-320HF	FMS-10H9	FMS-10F9	FMS-BLANK
192R-320HL	FMS-10UH	FMS-BLANK	FMS-10GV
192R-320HM	FMS-10UI	FMS-BLANK	FMS-10GV
192R-320HQ	FMS-10GT	FMS-BLANK	FMS-10GT
192R-320HU	FMS-10FF	FMS-10FF	FMS-BLANK
192R-320HV	FMS-10Z	FMS-10Z	FMS-BLANK
192R-320HW	FMS-10G	FMS-10G	FMS-BLANK
192R-320IV	FMS-10A	FMS-10A	FMS-BLANK
192R-320JA	FMS-10D	FMS-10D	FMS-BLANK
192R-320JA1	FMS-10J1	FMS-10H9	FMS-BLANK
192R-320JE	FMS-10FF	FMS-BLANK	FMS-10A
192R-320JL	FMS-10XU	FMS-BLANK	FMS-10JU
192R-320JS	FMS-10JZ	FMS-10A1	FMS-BLANK
192R-320JT	FMS-10WQ	FMS-10G	FMS-BLANK
192R-320JU	FMS-BLANK	FMS-10E1	FMS-10E1
192R-320JV	FMS-10W9	FMS-10W9	FMS-BLANK
192R-320JW	FMS-10A1	FMS-10P	FMS-BLANK
192R-320JX	FMS-10A1	FMS-10HE	FMS-BLANK
192R-320JY	FMS-10A1	FMS-10X3	FMS-BLANK
192R-320JZ	FMS-10JK	FMS-10A1	FMS-BLANK
192R-320KG	FMS-10A1	FMS-10G	FMS-BLANK
192R-320Y9	FMS-BLANK	FMS-10Y9	FMS-10WQ
192R-320ZK	FMS-10G	FMS-10HZ	FMS-BLANK
192R-322IR	FMS-06Q	FMS-06Q	FMS-10E1
192R-322KA	FMS-10E1	FMS-06Q	FMS-06Q
192R-322KN	FMS-10K7	FMS-10K7	FMS-02N
192R-324BZ	FMS-08G	FMS-08G	FMS-08G
192R-324ED	FMS-08BD	FMS-08BD	FMS-08BD
192R-324JF	FMS-08V	FMS-08V	FMS-08V
192R-324JX	FMS-08A	FMS-08F	FMS-08A
192R-324JY	FMS-08F	FMS-08A	FMS-08F
192R-324S	FMS-08F	FMS-06F	FMS-10A
192R-326DH	FMS-08G	FMS-08G	FMS-10A1
192R-326EW	FMS-08F	FMS-08F	FMS-10A
192R-326FX	FMS-08G	FMS-10A1	FMS-08G
192R-326KL	FMS-08V	FMS-10FF	FMS-08V
192R-327AY	FMS-09AY	FMS-09AY	FMS-09AY
192R-328BC	FMS-08AK	FMS-10F	FMS-10F
192R-328BE	FMS-08G	FMS-10A1	FMS-10A1
192R-328BY	FMS-08G	FMS-10NB	FMS-10A1

2RU 19x3.5 Racks

Catalog No.	Switch A	Switch B	Switch C
192R-328CN	FMS-08CI	FMS-10HS	FMS-10NV
192R-328DA	FMS-08F	FMS-10A1	FMS-10A1
192R-328FV	FMS-10A1	FMS-10A1	FMS-08G
192R-328FW	FMS-10A1	FMS-08G	FMS-10A1
192R-329JZ	FMS-10A	FMS-10F	FMS-09D
192R-330A	FMS-10V	FMS-10A	FMS-10FC
192R-330AB	FMS-10G	FMS-10TM	FMS-10A1
192R-330AC	FMS-10G	FMS-10A1	FMS-10JK
192R-330AD	FMS-10JV	FMS-10JW	FMS-10A1
192R-330AE	FMS-10A1	FMS-10A1	FMS-10A1
192R-330AF	FMS-10JH	FMS-10E	FMS-10GT
192R-330AG	FMS-10JX	FMS-10E	FMS-10GT
192R-330AH	FMS-10JH	FMS-10AH	FMS-10GT
192R-330AI	FMS-10GK	FMS-10JY	FMS-10A1
192R-330AJ	FMS-10JZ	FMS-10E	FMS-10GT
192R-330AL	FMS-10JV	FMS-10JV	FMS-10JV
192R-330AM	FMS-10B	FMS-10B	FMS-10B
192R-330AN	FMS-10PG	FMS-10PG	FMS-10A1
192R-330AP	FMS-10PG	FMS-10PG	FMS-10PG
192R-330AQ	FMS-10PG	FMS-10AH	FMS-10AH
192R-330AR	FMS-10KY	FMS-10E	FMS-10GT
192R-330AS	FMS-10KZ	FMS-10E	FMS-10GT
192R-330AT	FMS-10KY	FMS-10AH	FMS-10GT
192R-330AU	FMS-10AB	FMS-10A	FMS-10A
192R-330AV	FMS-10A	FMS-10A	FMS-10A
192R-330AW	FMS-10LD	FMS-10F	FMS-10F
192R-330AX	FMS-10E1	FMS-10E1	FMS-10E1
192R-330AY	FMS-10GK	FMS-10LG	FMS-10A1
192R-330AZ	FMS-10A1	FMS-10AH	FMS-10AH
192R-330A2	FMS-10F9	FMS-10A1	FMS-10A1
192R-330A3	FMS-10H9	FMS-10H9	FMS-10H9
192R-330A4	FMS-10G	FMS-10A1	FMS-10GA
192R-330A5	FMS-10A7	FMS-10A7	FMS-10A
192R-330A6	FMS-10E	FMS-10A3	FMS-10A
192R-330B	FMS-10V	FMS-10A	FMS-10A1
192R-330BA	FMS-10F9	FMS-10F9	FMS-10F9
192R-330BD	FMS-10GH	FMS-10LS	FMS-10A1
192R-330BF	FMS-10E	FMS-10A	FMS-10A
192R-330BG	FMS-10F	FMS-10F	FMS-10AG
192R-330BH	FMS-10FF	FMS-10B	FMS-10A1
192R-330BI	FMS-10E	FMS-10E	FMS-10E
192R-330BJ	FMS-10E	FMS-10PV	FMS-10A
192R-330BL	FMS-10E1	FMS-10FA	FMS-10E1
192R-330BM	FMS-10D	FMS-10F	FMS-10A
192R-330BP	FMS-10JY	FMS-10JY	FMS-10JY
192R-330BQ	FMS-10MQ	FMS-10MQ	FMS-10MS
192R-330BR	FMS-10F	FMS-10MT	FMS-10MU
192R-330BS	FMS-10V	FMS-10A	FMS-10MY
192R-330BT	FMS-10B	FMS-10NE	FMS-10F
192R-330BU	FMS-10E	FMS-10GT	FMS-10E
192R-330BV	FMS-10E	FMS-10HE	FMS-10E
192R-330BW	FMS-10HE	FMS-10HE	FMS-10HE
192R-330BX	FMS-10E	FMS-10GT	FMS-10HE
192R-330C	FMS-10E	FMS-10GA	FMS-10E
192R-330C1	FMS-10E	FMS-10F	FMS-10A
192R-330CA	FMS-10GK	FMS-10A1	FMS-10JU
192R-330CB	FMS-10AB	FMS-10AB	FMS-10AB
192R-330CD	FMS-10FP	FMS-10X	FMS-10FP

2RU 19x3.5 Racks

Catalog No.	Switch A	Switch B	Switch C
192R-330CF	FMS-10FI	FMS-10A1	FMS-10A1
192R-330CG	FMS-10F	FMS-10G	FMS-10E1
192R-330CI	FMS-10NV	FMS-10NV	FMS-10NV
192R-330CJ	FMS-10GS	FMS-10GS	FMS-10GS
192R-330CK	FMS-10JJ	FMS-10A1	FMS-10GS
192R-330CL	FMS-10GM	FMS-10A1	FMS-10GS
192R-330CM	FMS-10A1	FMS-10GS	FMS-10GS
192R-330CN	FMS-10LE	FMS-10LE	FMS-10GK
192R-330CP	FMS-10FM	FMS-10FM	FMS-10FM
192R-330CR	FMS-10E1	FMS-10A	FMS-10E1
192R-330CS	FMS-10E1	FMS-10A	FMS-10A
192R-330CT	FMS-10E4	FMS-10A	FMS-10A
192R-330CU	FMS-10E1	FMS-10A1	FMS-10A1
192R-330CV	FMS-10E1	FMS-10E1	FMS-10A
192R-330CW	FMS-10E	FMS-10HE	FMS-10HE
192R-330CX	FMS-10E	FMS-10E	FMS-10F
192R-330CY	FMS-10LE	FMS-10F	FMS-10PG
192R-330CZ	FMS-10LE	FMS-10P	FMS-10A1
192R-330D	FMS-10GP	FMS-06Q	FMS-10GA
192R-330D3	FMS-10G	FMS-10F8	FMS-10A1
192R-330D4	FMS-10G	FMS-10G	FMS-10ZH
192R-330D5	FMS-10G	FMS-10JK	FMS-10F8
192R-330D6	FMS-10F8	FMS-10F8	FMS-10A1
192R-330D7	FMS-10G	FMS-10G	FMS-10F8
192R-330D8	FMS-10G	FMS-10F9	FMS-10F8
192R-330D9	FMS-10F8	FMS-10A1	FMS-10F8
192R-330DE	FMS-10FM	FMS-10A1	FMS-10A1
192R-330DF	FMS-10C1	FMS-10A1	FMS-10A1
192R-330DG	FMS-10G	FMS-10A1	FMS-10F8
192R-330DI	FMS-10F	FMS-10HI	FMS-10A
192R-330DJ	FMS-10A1	FMS-10A1	FMS-10GS
192R-330DK	FMS-10E1	FMS-10E1	FMS-10A1
192R-330DL	FMS-10E4	FMS-10E4	FMS-10A1
192R-330DM	FMS-10SL	FMS-10A1	FMS-10SM
192R-330DN	FMS-10E3	FMS-10SP	FMS-10JJ
192R-330DO	FMS-10JJ	FMS-10FC	FMS-10GK
192R-330DP	FMS-10GM	FMS-10GS	FMS-10GS
192R-330DR	FMS-10D	FMS-10A3	FMS-10A
192R-330DS	FMS-10JN	FMS-10GL	FMS-10A
192R-330DT	FMS-10JS	FMS-10LR	FMS-10AQ
192R-330DU	FMS-10JS	FMS-10AR	FMS-10AH
192R-330DW	FMS-10JS	FMS-10E	FMS-10JR
192R-330DX	FMS-10FZ	FMS-10A	FMS-10A
192R-330DZ	FMS-10A	FMS-10A	FMS-10GT
192R-330E	FMS-10GA	FMS-10A	FMS-10A
192R-330E1	FMS-10G	FMS-10A1	FMS-10YE
192R-330E2	FMS-10E1	FMS-10E4	FMS-10E1
192R-330E3	FMS-10MW	FMS-10MZ	FMS-10MZ
192R-330E5	FMS-10A	FMS-10E1	FMS-10E1
192R-330E6	FMS-10E1	FMS-10E4	FMS-10A1
192R-330E7	FMS-10MW	FMS-10MW	FMS-10MW
192R-330E8	FMS-10A1	FMS-10H8	FMS-10H8
192R-330E9	FMS-10A1	FMS-10A1	FMS-10H8
192R-330EA	FMS-10MQ	FMS-10MQ	FMS-10BD
192R-330EB	FMS-10MQ	FMS-10BE	FMS-10BF
192R-330EC	FMS-10BG	FMS-10BG	FMS-10BG
192R-330ED	FMS-10F8	FMS-10H8	FMS-10A1
192R-330EE	FMS-10LW	FMS-10LW	FMS-10BP

FMS
Test Switches

FMS Semiflush-Mounted Test Switches (19 inch Rack Mount)

FMS
Test Switches

2RU 19x3.5 Racks

Catalog No.	Switch A	Switch B	Switch C
192R-330EF	FMS-10HE	FMS-10HE	FMS-10BQ
192R-330EG	FMS-10LW	FMS-10BR	FMS-10BS
192R-330EH	FMS-10A	FMS-10E	FMS-10A
192R-330EJ	FMS-10A	FMS-10FP	FMS-10A
192R-330EK	FMS-10F	FMS-10A	FMS-10A
192R-330EL	FMS-10JS	FMS-10AR	FMS-10CE
192R-330EN	FMS-10F	FMS-10F	FMS-10F
192R-330EP	FMS-10A	FMS-10A	FMS-10F
192R-330EQ	FMS-10FM	FMS-10A1	FMS-10FA
192R-330ER	FMS-10G	FMS-10A1	FMS-10A1
192R-330ES	FMS-10G	FMS-10G	FMS-10A1
192R-330EU	FMS-10G	FMS-10A1	FMS-10GM
192R-330EV	FMS-10JS	FMS-10FP	FMS-10AH
192R-330EX	FMS-10G	FMS-10G	FMS-10G
192R-330EY	FMS-10GK	FMS-10GK	FMS-10A1
192R-330EZ	FMS-10E4	FMS-10A1	FMS-10A1
192R-330F	FMS-10GA	FMS-10A1	FMS-10A1
192R-330F1	FMS-10G	FMS-10A1	FMS-10H9
192R-330F2	FMS-10FF	FMS-10A1	FMS-10I1
192R-330F3	FMS-10I1	FMS-10H8	FMS-10A1
192R-330F4	FMS-10G	FMS-10I7	FMS-10I7
192R-330F5	FMS-10G	FMS-10I8	FMS-10I9
192R-330F6	FMS-10G	FMS-10F	FMS-10F
192R-330F7	FMS-10G	FMS-10G	FMS-10JK
192R-330F8	FMS-10MW	FMS-10A1	FMS-10A1
192R-330F9	FMS-10A1	FMS-10F8	FMS-10F8
192R-330FB	FMS-10A	FMS-10E	FMS-10E
192R-330FC	FMS-10A	FMS-10AB	FMS-10E
192R-330FD	FMS-10GA	FMS-10GA	FMS-10GA
192R-330FE	FMS-10F	FMS-10EA	FMS-10EA
192R-330FF	FMS-10E1	FMS-10E1	FMS-10GB
192R-330FG	FMS-10A1	FMS-10A1	FMS-10FF
192R-330FH	FMS-10CX	FMS-10CX	FMS-10Z
192R-330FI	FMS-10A1	FMS-10E4	FMS-10A1
192R-330FJ	FMS-10CX	FMS-10CX	FMS-10CX
192R-330FK	FMS-10A1	FMS-10A1	FMS-10E4
192R-330FL	FMS-10CX	FMS-10Z	FMS-10A1
192R-330FM	FMS-10E4	FMS-10E4	FMS-10E4
192R-330FN	FMS-10CX	FMS-10A1	FMS-10Z
192R-330FO	FMS-10Z	FMS-10E4	FMS-10A1
192R-330FP	FMS-10IK	FMS-10IL	FMS-10GS
192R-330FQ	FMS-10GA	FMS-10IM	FMS-10IM
192R-330FR	FMS-10C	FMS-10CX	FMS-10C
192R-330FT	FMS-10GK	FMS-10GK	FMS-10GK
192R-330FU	FMS-10D	FMS-10A	FMS-10D
192R-330FZ	FMS-10A	FMS-10C	FMS-10C
192R-330G	FMS-10E	FMS-10A	FMS-10E
192R-330G2	FMS-10K7	FMS-10K7	FMS-10ZD
192R-330G3	FMS-10FE	FMS-10FE	FMS-10FE
192R-330G4	FMS-10K7	FMS-10ZD	FMS-10K7
192R-330G5	FMS-10F	FMS-10F	FMS-10MC
192R-330G6	FMS-10E4	FMS-10E4	FMS-10E1
192R-330G7	FMS-10GA	FMS-10A1	FMS-10E1
192R-330G8	FMS-10GA	FMS-10E1	FMS-10HR
192R-330G9	FMS-10C	FMS-10A	FMS-10C
192R-330GA	FMS-10F	FMS-10F	FMS-10IQ
192R-330GB	FMS-10LE	FMS-10F	FMS-10A1
192R-330GC	FMS-10GK	FMS-10NE	FMS-10A1

2RU 19x3.5 Racks

Catalog No.	Switch A	Switch B	Switch C
192R-330GD	FMS-10G	FMS-10HZ	FMS-10A
192R-330GE	FMS-10G	FMS-10A	FMS-10A
192R-330GH	FMS-10G	FMS-10F	FMS-10G
192R-330GI	FMS-10HI	FMS-10G	FMS-10HZ
192R-330GJ	FMS-10TQ	FMS-10A1	FMS-10A1
192R-330GK	FMS-10V	FMS-10J	FMS-10A
192R-330GL	FMS-10A	FMS-10MC	FMS-10TR
192R-330GM	FMS-10G	FMS-1GK	FMS-10F
192R-330GN	FMS-10GS	FMS-10G	FMS-10GK
192R-330GO	FMS-10G	FMS-10F	FMS-10FF
192R-330GP	FMS-10F	FMS-10P	FMS-10G
192R-330GR	FMS-10F	FMS-10UF	FMS-10F
192R-330GT	FMS-10D	FMS-10D	FMS-10D
192R-330GU	FMS-10LE	FMS-10F	FMS-10P
192R-330GW	FMS-10JS	FMS-10AH	FMS-10JR
192R-330GY	FMS-10UG	FMS-10DR	FMS-10DR
192R-330GZ	FMS-10DR	FMS-10DR	FMS-10DR
192R-330H	FMS-10C	FMS-10B	FMS-10B
192R-330H2	FMS-10H9	FMS-10A1	FMS-10A1
192R-330H3	FMS-10A1	FMS-10A1	FMS-10F9
192R-330H4	FMS-10F	FMS-10A1	FMS-10F9
192R-330H5	FMS-10S1	FMS-10A1	FMS-10A1
192R-330H6	FMS-10F	FMS-10S1	FMS-10A1
192R-330H7	FMS-10A1	FMS-10FF	FMS-10A1
192R-330H8	FMS-10FY	FMS-10A	FMS-10A
192R-330H9	FMS-10E3	FMS-10E3	FMS-10A1
192R-330HB	FMS-10A1	FMS-10B	FMS-10B
192R-330HC	FMS-10A1	FMS-10A1	FMS-10Z
192R-330HD	FMS-10Z	FMS-10Z	FMS-10A1
192R-330HE	FMS-10FF	FMS-10G	FMS-10A1
192R-330HF	FMS-10FF	FMS-10FF	FMS-10A1
192R-330HG	FMS-10FF	FMS-10A1	FMS-10A1
192R-330HI	FMS-10G	FMS-10G	FMS-10F
192R-330HJ	FMS-10F	FMS-10A1	FMS-10A1
192R-330HK	FMS-10GL	FMS-10Z	FMS-10A1
192R-330HN	FMS-10G	FMS-10A1	FMS-10GL
192R-330HO	FMS-10E2	FMS-10E3	FMS-10GT
192R-330HP	FMS-10E2	FMS-10E5	FMS-10GT
192R-330HR	FMS-10E2	FMS-10E2	FMS-10GT
192R-330HS	FMS-10E2	FMS-10E3	FMS-10CT
192R-330HX	FMS-10A1	FMS-10Z	FMS-10A1
192R-330HY	FMS-10A1	FMS-10Z	FMS-10Z
192R-330HZ	FMS-10Z	FMS-10GL	FMS-10A1
192R-330I	FMS-10PD	FMS-10AH	FMS-10AH
192R-330I2	FMS-10LE	FMS-10GS	FMS-10GS
192R-330I3	FMS-10K1	FMS-10A1	FMS-10GS
192R-330I5	FMS-10Q1	FMS-10A	FMS-10A
192R-330I6	FMS-10E	FMS-10LD	FMS-10A
192R-330IA	FMS-10G	FMS-10A1	FMS-10Z
192R-330IB	FMS-10Z	FMS-10Z	FMS-10Z
192R-330IC	FMS-10GI	FMS-10GC	FMS-10GT
192R-330ID	FMS-10GI	FMS-10GT	FMS-10FT
192R-330IE	FMS-10LC	FMS-10LC	FMS-10VB
192R-330IF	FMS-10LW	FMS-10LW	FMS-10LW
192R-330IG	FMS-10E	FMS-10LW	FMS-10E
192R-330IH	FMS-10LW	FMS-10HE	FMS-10HE
192R-330IJ	FMS-10E	FMS-10A	FMS-10HE
192R-330IK	FMS-10E2	FMS-10E3	FMS-10FA

2RU 19x3.5 Racks

Catalog No.	Switch A	Switch B	Switch C
192R-330IL	FMS-10C	FMS-10C	FMS-10C
192R-330IM	FMS-10A1	FMS-10G	FMS-10G
192R-330IN	FMS-10FF	FMS-10FF	FMS-10FF
192R-330IO	FMS-10FP	FMS-10FP	FMS-10A
192R-330IP	FMS-10FP	FMS-10A	FMS-10A
192R-330IS	FMS-10FF	FMS-10A1	FMS-10FF
192R-330IT	FMS-10C	FMS-10C	FMS-10A
192R-330IU	FMS-10DF	FMS-10A1	FMS-10PH
192R-330IW	FMS-10WS	FMS-10A1	FMS-10A1
192R-330IX	FMS-10E3	FMS-10FA	FMS-10A1
192R-330IY	FMS-10PU	FMS-10A1	FMS-10A1
192R-330IZ	FMS-10D	FMS-10A	FMS-10A
192R-330J	FMS-10PG	FMS-10A1	FMS-10AH
192R-330J1	FMS-10A1	FMS-10A1	FMS-10GB
192R-330J2	FMS-10E3	FMS-10A1	FMS-10A1
192R-330J6	FMS-10G	FMS-10H9	FMS-10H9
192R-330J7	FMS-10H9	FMS-10H9	FMS-10A1
192R-330J8	FMS-10A1	FMS-10F8	FMS-10A1
192R-330JB	FMS-10DL	FMS-10A5	FMS-10A4
192R-330JC	FMS-10G	FMS-10LE	FMS-10JK
192R-330JD	FMS-10D	FMS-10D	FMS-10A
192R-330JG	FMS-10HK	FMS-10FF	FMS-10FF
192R-330JH	FMS-10HK	FMS-10FF	FMS-10IX
192R-330JM	FMS-10F	FMS-10F	FMS-10A1
192R-330JO	FMS-10XV	FMS-10FF	FMS-10A
192R-330JP	FMS-10DL	FMS-10YD	FMS-10A4
192R-330JS	FMS-10A	FMS-10E2	FMS-10E2
192R-330JT	FMS-10A	FMS-10B	FMS-10B
192R-330JU	FMS-10B	FMS-10A	FMS-10A
192R-330JV	FMS-10G	FMS-10A1	FMS-10G
192R-330K	FMS-10AH	FMS-10AH	FMS-10AH
192R-330KB	FMS-10A1	FMS-10A1	FMS-10G
192R-330KC	FMS-10G	FMS-10G	FMS-10YV
192R-330KD	FMS-10WK	FMS-10YV	FMS-10A1
192R-330KH	FMS-10WK	FMS-10MW	FMS-10A1
192R-330KI	FMS-10G	FMS-10JJ	FMS-10JJ
192R-330KJ	FMS-10C5	FMS-10C6	FMS-10C7
192R-330KN	FMS-10D	FMS-10A1	FMS-10A1
192R-330KO	FMS-10F8	FMS-10F8	FMS-10F8
192R-330KP	FMS-10HZ	FMS-10HZ	FMS-10GM
192R-330KQ	FMS-10F	FMS-10HZ	FMS-10MW
192R-330KR	FMS-10MN	FMS-10HZ	FMS-10GM
192R-330KS	FMS-10A1	FMS-10JJ	FMS-10JJ
192R-330KT	FMS-10E2	FMS-10E2	FMS-10E2
192R-330KW	FMS-10GS	FMS-10GS	FMS-10A1
192R-330KZ	FMS-10D	FMS-10KC	FMS-10A1
192R-330L	FMS-10PH	FMS-10AH	FMS-10AH
192R-330L4	FMS-10FZ	FMS-10V5	FMS-10A1
192R-330LA	FMS-10A	FMS-10R5	FMS-10F
192R-330LB	FMS-10FF	FMS-10F	FMS-10A1
192R-330LC	FMS-10H8	FMS-10H8	FMS-10H8
192R-330LD	FMS-10G	FMS-10G	FMS-10F9

2RU 19x3.5 Racks

Catalog No.	Switch A	Switch B	Switch C
192R-330LE	FMS-10G	FMS-10H9	FMS-10F9
192R-330LF	FMS-10G	FMS-10F9	FMS-10A1
192R-330LG	FMS-10A1	FMS-10A1	FMS-10W5
192R-330LH	FMS-10A1	FMS-10A1	FMS-10W6
192R-330LI	FMS-10A1	FMS-10A1	FMS-10W7
192R-330LJ	FMS-10JZ	FMS-10A1	FMS-10W5
192R-330LK	FMS-10G	FMS-10JZ	FMS-10A1
192R-330LM	FMS-10A1	FMS-10G	FMS-10A1
192R-330LN	FMS-10A1	FMS-10A1	FMS-10M2
192R-330LO	FMS-10M2	FMS-10M2	FMS-10M2
192R-330LP	FMS-10G	FMS-10A1	FMS-10WQ
192R-330LQ	FMS-10M2	FMS-10M2	FMS-10WQ
192R-330LR	FMS-10A1	FMS-10M2	FMS-10M2
192R-330LS	FMS-10G	FMS-10A1	FMS-10M2
192R-330LT	FMS-10M2	FMS-10A1	FMS-10M2
192R-330LU	FMS-10JZ	FMS-10A1	FMS-10A1
192R-330LV	FMS-10G	FMS-10G	FMS-10JZ
192R-330LW	FMS-10A1	FMS-10W5	FMS-10W5
192R-330LX	FMS-10W9	FMS-10W9	FMS-10W9
192R-330LY	FMS-10G	FMS-10G	FMS-10X3
192R-330LZ	FMS-10JZ	FMS-10X3	FMS-10Z1
192R-330M	FMS-10G	FMS-10A1	FMS-10A
192R-330MA	FMS-10F	FMS-10JZ	FMS-10X3
192R-330MB	FMS-10IO	FMS-10GS	FMS-10LE
192R-330MC	FMS-10F	FMS-10JK	FMS-10X3
192R-330MD	FMS-10JK	FMS-10X3	FMS-10A1
192R-330ME	FMS-10JK	FMS-10A1	FMS-10A1
192R-330MF	FMS-10JK	FMS-10A1	FMS-10W5
192R-330MN	FMS-10G	FMS-10JK	FMS-10A1
192R-330MO	FMS-10X5	FMS-10GS	FMS-10GS
192R-330MP	FMS-10IO	FMS-10GS	FMS-10A1
192R-330MQ	FMS-10HK	FMS-10FF	FMS-10A
192R-330MW	FMS-10FA	FMS-10A1	FMS-10A
192R-330N	FMS-10FF	FMS-10A1	FMS-10A
192R-330P	FMS-08AF	FMS-10E	FMS-08AG
192R-330Q	FMS-10V	FMS-10A	FMS-10A
192R-330R	FMS-10F	FMS-10F	FMS-10A
192R-330T	FMS-10E	FMS-10E	FMS-10A
192R-330U	FMS-10GH	FMS-10E	FMS-10GT
192R-330V	FMS-10GK	FMS-10JK	FMS-10A1
192R-330W	FMS-10JQ	FMS-10E	FMS-10JR
192R-330X	FMS-10JS	FMS-10JS	FMS-10JS
192R-330X1	FMS-10W1	FMS-10W2	FMS-10W3
192R-330XA	FMS-10E2	FMS-10A	FMS-10A
192R-330XG	FMS-10FP	FMS-10E2	FMS-10E2
192R-330XH	FMS-10FP	FMS-10E2	FMS-10A
192R-330Y	FMS-10JS	FMS-10JS	FMS-10JT
192R-330YA	FMS-10D	FMS-10A1	FMS-10D
192R-330ZA	FMS-10S	FMS-10S	FMS-10A
192R-330ZJ	FMS-10G	FMS-10G	FMS-10A

FMS
Test Switches

FMS Semiflush-Mounted Test Switches (19 inch Rack Mount)

FMS
Test Switches

3RU 19x5.25 Racks

Catalog No.	Switch A	Switch B	Switch C
193R-300-XX	FMS-BLANK	FMS-BLANK	FMS-BLANK
193R-306AD	FMS-06Q	FMS-BLANK	FMS-BLANK
193R-307AF	FMS-07AD	FMS-BLANK	FMS-BLANK
193R-308KG	FMS-BLANK	FMS-BLANK	FMS-08F
193R-309HZ	FMS-09S	FMS-BLANK	FMS-BLANK
193R-310AC	FMS-BLANK	FMS-10E	FMS-BLANK
193R-310AH	FMS-BLANK	FMS-10AH	FMS-BLANK
193R-310BG	FMS-10F	FMS-BLANK	FMS-BLANK
193R-310BI	FMS-10BI	FMS-BLANK	FMS-BLANK
193R-310C1	FMS-BLANK	FMS-10C1	FMS-BLANK
193R-310CC	FMS-10FK	FMS-BLANK	FMS-BLANK
193R-310CD	FMS-10A1	FMS-BLANK	FMS-BLANK
193R-310D	FMS-BLANK	FMS-10D	FMS-BLANK
193R-310DK	FMS-BLANK	FMS-10A1	FMS-BLANK
193R-310DZ	FMS-10DZ	FMS-BLANK	FMS-BLANK
193R-310E1	FMS-10E1	FMS-BLANK	FMS-BLANK
193R-310E2	FMS-10E2	FMS-BLANK	FMS-BLANK
193R-310ES	FMS-BLANK	FMS-10LP	FMS-BLANK
193R-310GB	FMS-BLANK	FMS-10A	FMS-BLANK
193R-310GC	FMS-BLANK	FMS-10GC	FMS-BLANK
193R-310GS	FMS-BLANK	FMS-BLANK	FMS-10ML
193R-310GT	FMS-BLANK	FMS-BLANK	FMS-10GT
193R-310IA	FMS-BLANK	FMS-BLANK	FMS-10NT
193R-310KP	FMS-10QK	FMS-BLANK	FMS-BLANK
193R-310KW	FMS-10D	FMS-BLANK	FMS-BLANK
193R-310LB	FMS-10JP	FMS-BLANK	FMS-BLANK
193R-310LD	FMS-10LP	FMS-BLANK	FMS-BLANK
193R-310LG	FMS-10GA	FMS-BLANK	FMS-BLANK
193R-310PG	FMS-10PG	FMS-BLANK	FMS-BLANK
193R-310QF	FMS-10BW	FMS-BLANK	FMS-BLANK
193R-310RV	FMS-10EB	FMS-BLANK	FMS-BLANK
193R-310SI	FMS-10NV	FMS-BLANK	FMS-BLANK
193R-310SL	FMS-10AH	FMS-BLANK	FMS-BLANK
193R-310SX	FMS-10E	FMS-BLANK	FMS-BLANK
193R-310US	FMS-10TJ	FMS-BLANK	FMS-BLANK
193R-310UW	FMS-10A	FMS-BLANK	FMS-BLANK
193R-310XV	FMS-10G	FMS-BLANK	FMS-BLANK
193R-310YK	FMS-10YE	FMS-BLANK	FMS-BLANK
193R-310ZP	FMS-BLANK	FMS-BLANK	FMS-10A1
193R-312AC	FMS-06Q	FMS-06Q	FMS-BLANK
193R-312AY	FMS-04AY	FMS-04AY	FMS-04AY
193R-312F	FMS-04F	FMS-04F	FMS-04F
193R-312KW	FMS-08CK	FMS-04W	FMS-BLANK
193R-312X	FMS-04X	FMS-04X	FMS-04X
193R-314AG	FMS-07AD	FMS-07AD	FMS-BLANK
193R-314CC	FMS-04AG	FMS-10NU	FMS-BLANK
193R-315A	FMS-07AC	FMS-08CK	FMS-BLANK
193R-316AH	FMS-08G	FMS-BLANK	FMS-08G
193R-316CJ	FMS-08CJ	FMS-04W	FMS-04W
193R-316EB	FMS-06F	FMS-10D	FMS-BLANK
193R-316FG	FMS-06F	FMS-10GI	FMS-BLANK
193R-318DP	FMS-08G	FMS-BLANK	FMS-10A1
193R-318GI	FMS-06V	FMS-06V	FMS-06V
193R-318GL	FMS-06F	FMS-06F	FMS-06F
193R-318KT	FMS-09S	FMS-BLANK	FMS-09S
193R-318KV	FMS-09S	FMS-09S	FMS-BLANK
193R-318KY	FMS-06Q	FMS-06Q	FMS-06Q
193R-318ML	FMS-10YM	FMS-08BL	FMS-BLANK

3RU 19x5.25 Racks

Catalog No.	Switch A	Switch B	Switch C
193R-318WX	FMS-06BA	FMS-06BA	FMS-06BA
193R-320A1	FMS-10HI	FMS-10A	FMS-BLANK
193R-320A2	FMS-10A1	FMS-BLANK	FMS-10PG
193R-320AF	FMS-10A	FMS-10F	FMS-BLANK
193R-320AG	FMS-10A1	FMS-10GK	FMS-BLANK
193R-320B6	FMS-10EJ	FMS-10AH	FMS-BLANK
193R-320BK	FMS-10E1	FMS-BLANK	FMS-10A1
193R-320BL	FMS-10E1	FMS-BLANK	FMS-10E1
193R-320BP	FMS-10E2	FMS-BLANK	FMS-10A1
193R-320BQ	FMS-10GK	FMS-10GK	FMS-BLANK
193R-320BR	FMS-10A	FMS-10A	FMS-BLANK
193R-320BV	FMS-10E4	FMS-BLANK	FMS-10A1
193R-320BW	FMS-10A1	FMS-BLANK	FMS-10A1
193R-320BY	FMS-10A1	FMS-BLANK	FMS-10E4
193R-320BZ	FMS-10JP	FMS-BLANK	FMS-10JP
193R-320CA	FMS-10KA	FMS-10A	FMS-BLANK
193R-320CB	FMS-10FK	FMS-10FK	FMS-BLANK
193R-320CE	FMS-10FK	FMS-10A1	FMS-BLANK
193R-320CL	FMS-10E3	FMS-10A	FMS-BLANK
193R-320CM	FMS-10E2	FMS-10A	FMS-BLANK
193R-320CQ	FMS-10G	FMS-10A1	FMS-BLANK
193R-320CV	FMS-10AD	FMS-BLANK	FMS-10AD
193R-320DF	FMS-10D	FMS-10F	FMS-BLANK
193R-320DG	FMS-10A1	FMS-10E1	FMS-BLANK
193R-320DJ	FMS-BLANK	FMS-10FK	FMS-10A1
193R-320DQ	FMS-04Z	FMS-06AC	FMS-10KX
193R-320E2	FMS-10E2	FMS-10E2	FMS-BLANK
193R-320EA	FMS-10E2	FMS-10A1	FMS-BLANK
193R-320EC	FMS-10G	FMS-10LB	FMS-BLANK
193R-320ET	FMS-10E	FMS-BLANK	FMS-10A
193R-320EU	FMS-10E	FMS-BLANK	FMS-10E
193R-320EV	FMS-10E	FMS-BLANK	FMS-10LP
193R-320EZ	FMS-10E1	FMS-10A1	FMS-BLANK
193R-320FI	FMS-10E1	FMS-BLANK	FMS-10LP
193R-320FL	FMS-BLANK	FMS-10F	FMS-10F
193R-320FM	FMS-BLANK	FMS-10A1	FMS-10A1
193R-320FQ	FMS-10AB	FMS-BLANK	FMS-10A
193R-320FZ	FMS-10A	FMS-BLANK	FMS-10A
193R-320GA	FMS-10E	FMS-BLANK	FMS-10KB
193R-320GB	FMS-10E	FMS-10A	FMS-BLANK
193R-320GD	FMS-10E	FMS-10KB	FMS-BLANK
193R-320GF	FMS-BLANK	FMS-10E1	FMS-10A1
193R-320GH	FMS-10A1	FMS-10A1	FMS-BLANK
193R-320GN	FMS-10V4	FMS-10V6	FMS-BLANK
193R-320GU	FMS-10MM	FMS-10FA	FMS-BLANK
193R-320HW	FMS-10MA	FMS-10MB	FMS-BLANK
193R-320IR	FMS-BLANK	FMS-10NW	FMS-10NW
193R-320JK	FMS-10E1	FMS-10LP	FMS-BLANK
193R-320KS	FMS-10NV	FMS-BLANK	FMS-10NV
193R-320KX	FMS-10F	FMS-10GK	FMS-BLANK
193R-320LM	FMS-10GK	FMS-BLANK	FMS-10F
193R-320ML	FMS-10GM	FMS-BLANK	FMS-10HD
193R-320MX	FMS-10F	FMS-10JK	FMS-BLANK
193R-320MY	FMS-10C1	FMS-10C1	FMS-BLANK
193R-320NH	FMS-10F	FMS-10F	FMS-BLANK
193R-320NJ	FMS-BLANK	FMS-10GS	FMS-10GS
193R-320NY	FMS-10BL	FMS-10BZ	FMS-BLANK
193R-320PD	FMS-10A1	FMS-BLANK	FMS-10E1

3RU 19x5.25 Racks

Catalog No.	Switch A	Switch B	Switch C
193R-320PJ	FMS-10JD	FMS-10IT	FMS-BLANK
193R-320PK	FMS-10E3	FMS-10IA	FMS-BLANK
193R-320QB	FMS-10BX	FMS-10BY	FMS-BLANK
193R-320QC	FMS-10BI	FMS-BLANK	FMS-10BL
193R-320QD	FMS-10BJ	FMS-BLANK	FMS-10BZ
193R-320QN	FMS-10F	FMS-BLANK	FMS-10A
193R-320QP	FMS-10F	FMS-BLANK	FMS-10F
193R-320QW	FMS-10FF	FMS-BLANK	FMS-10JK
193R-320QX	FMS-10FF	FMS-BLANK	FMS-10FF
193R-320RA	FMS-10GK	FMS-BLANK	FMS-10GK
193R-320RB	FMS-10CU	FMS-BLANK	FMS-10CU
193R-320RC	FMS-10CU	FMS-10NV	FMS-BLANK
193R-320RD	FMS-10E4	FMS-10A1	FMS-BLANK
193R-320RN	FMS-10E	FMS-10E	FMS-BLANK
193R-320RQ	FMS-10D	FMS-BLANK	FMS-10D
193R-320TF	FMS-10ID	FMS-BLANK	FMS-10IE
193R-320TH	FMS-10F	FMS-10EZ	FMS-BLANK
193R-320TT	FMS-10NV	FMS-10NV	FMS-BLANK
193R-320UA	FMS-10U1	FMS-10A1	FMS-BLANK
193R-320UB	FMS-10U1	FMS-10LB	FMS-BLANK
193R-320UG	FMS-10TJ	FMS-10TJ	FMS-BLANK
193R-320UK	FMS-10E1	FMS-10E1	FMS-BLANK
193R-320UL	FMS-10FM	FMS-10FM	FMS-BLANK
193R-320UM	FMS-10F	FMS-10FX	FMS-BLANK
193R-320UN	FMS-10E	FMS-10TM	FMS-BLANK
193R-320UZ	FMS-10PG	FMS-10A1	FMS-BLANK
193R-320V3	FMS-10V3	FMS-10A	FMS-BLANK
193R-320VL	FMS-BLANK	FMS-10A	FMS-10SR
193R-320VN	FMS-10A	FMS-10SR	FMS-BLANK
193R-320VQ	FMS-10MA	FMS-10GC	FMS-BLANK
193R-320VR	FMS-10GI	FMS-10GC	FMS-BLANK
193R-320VT	FMS-10C	FMS-10C	FMS-BLANK
193R-320VVV	FMS-10A1	FMS-10AH	FMS-BLANK
193R-320WZ	FMS-10FF	FMS-BLANK	FMS-10A1
193R-320XF	FMS-10WP	FMS-BLANK	FMS-10WP
193R-320XJ	FMS-10GM	FMS-BLANK	FMS-10F
193R-320XP	FMS-10A	FMS-BLANK	FMS-10A1
193R-320YB	FMS-10XR	FMS-10SR	FMS-BLANK
193R-320YG	FMS-BLANK	FMS-10E4	FMS-10A1
193R-320YJ	FMS-10E3	FMS-10JJ	FMS-BLANK
193R-320YM	FMS-10E2	FMS-BLANK	FMS-10E2
193R-320YQ	FMS-10YE	FMS-10D	FMS-BLANK
193R-320YR	FMS-10YE	FMS-10A1	FMS-BLANK
193R-320Z1	FMS-10D	FMS-10A3	FMS-BLANK
193R-320Z2	FMS-10XP	FMS-10A	FMS-BLANK
193R-320Z3	FMS-10YB	FMS-10A	FMS-BLANK
193R-320Z4	FMS-10Q9	FMS-10A	FMS-BLANK
193R-320ZC	FMS-10D	FMS-10D	FMS-BLANK
193R-321AE	FMS-07AD	FMS-07AD	FMS-07AD
193R-321AF	FMS-07AC	FMS-07AC	FMS-07AC
193R-321BM	FMS-07AC	FMS-08CK	FMS-06BM
193R-321BN	FMS-07AC	FMS-08CK	FMS-06BN
193R-322AF	FMS-08AC	FMS-08AB	FMS-06AF
193R-322CK	FMS-07AC	FMS-07AC	FMS-08CK
193R-322FG	FMS-06V	FMS-06V	FMS-10F
193R-322FH	FMS-06Q	FMS-06Q	FMS-10A1
193R-322HS	FMS-06AK	FMS-06AK	FMS-10F
193R-322KZ	FMS-08G	FMS-06Q	FMS-08X

3RU 19x5.25 Racks

Catalog No.	Switch A	Switch B	Switch C
193R-322VM	FMS-06Q	FMS-06Q	FMS-10A
193R-323CK	FMS-07AC	FMS-08CK	FMS-08CK
193R-323TA	FMS-10J8	FMS-03L	FMS-10J9
193R-323TU	FMS-04AG	FMS-10NU	FMS-09S
193R-324AB	FMS-08AB	FMS-08AB	FMS-08AB
193R-324AC	FMS-07AC	FMS-10SZ	FMS-07AC
193R-324AP	FMS-10E2	FMS-04V	FMS-10A1
193R-324V	FMS-08G	FMS-08G	FMS-08G
193R-324W	FMS-08G	FMS-08AC	FMS-08G
193R-324DY	FMS-08AJ	FMS-08AJ	FMS-08AJ
193R-324HE	FMS-08AQ	FMS-06AK	FMS-10F
193R-324HF	FMS-08AN	FMS-08AN	FMS-08AN
193R-324HG	FMS-08CK	FMS-08CK	FMS-08CK
193R-324HK	FMS-09BB	FMS-09BC	FMS-06BL
193R-324LR	FMS-08F	FMS-08F	FMS-08F
193R-324LS	FMS-08CV	FMS-08CU	FMS-08A
193R-326CP	FMS-08G	FMS-08G	FMS-10A1
193R-326CQ	FMS-08G	FMS-10A1	FMS-08X
193R-326DE	FMS-10E	FMS-10E	FMS-06F
193R-326FV	FMS-10E1	FMS-06Q	FMS-10E1
193R-326FX	FMS-10F	FMS-10A	FMS-06Q
193R-326LS	FMS-10A	FMS-08F	FMS-08F
193R-326LU	FMS-10D	FMS-10D	FMS-06A
193R-326MH	FMS-06H	FMS-10A1	FMS-10A1
193R-326QS	FMS-08F	FMS-08F	FMS-10A
193R-327IC	FMS-09S	FMS-09S	FMS-09S
193R-328EE	FMS-08G	FMS-10A	FMS-10A
193R-328GP	FMS-08AQ	FMS-10F	FMS-10F
193R-328HQ	FMS-08G	FMS-10NB	FMS-10A1
193R-328HR	FMS-08G	FMS-10A1	FMS-10ND
193R-328HS	FMS-09BB	FMS-09BC	FMS-10L8
193R-328HT	FMS-09BB	FMS-10L9	FMS-09BD
193R-328KH	FMS-10E	FMS-10E	FMS-08E
193R-328KL	FMS-10J4	FMS-08CF	FMS-10SR
193R-328LK	FMS-08G	FMS-10A1	FMS-10A1
193R-328LT	FMS-10D	FMS-10D	FMS-08F
193R-328UO	FMS-08G	FMS-10GZ	FMS-10GZ
193R-328VD	FMS-10GS	FMS-08AI	FMS-10GS
193R-329GW	FMS-10F	FMS-09R	FMS-10A
193R-329XD	FMS-09AM	FMS-10A	FMS-10A
193R-330A	FMS-10A1	FMS-10B	FMS-10E1
193R-330AB	FMS-10PZ	FMS-10PZ	FMS-10PZ
193R-330AC	FMS-10A	FMS-10A1	FMS-10AB
193R-330AJ	FMS-10B	FMS-10B	FMS-10B
193R-330AK	FMS-10GK	FMS-10JY	FMS-10A1
193R-330AM	FMS-10JJ	FMS-10BA	FMS-10F
193R-330AN	FMS-10GA	FMS-10JJ	FMS-10GS
193R-330AP	FMS-10JJ	FMS-10A1	FMS-10F
193R-330AR	FMS-10MW	FMS-10A1	FMS-10F
193R-330AS	FMS-10GA	FMS-10A1	FMS-10GS
193R-330AT	FMS-10GA	FMS-10A1	FMS-10F
193R-330AU	FMS-10MW	FMS-10A1	FMS-10GS
193R-330AW	FMS-10LD	FMS-10F	FMS-10F
193R-330AY	FMS-10M	FMS-10M	FMS-10M
193R-330AZ	FMS-10A	FMS-10SR	FMS-10SR
193R-330A2	FMS-10A1	FMS-10FE	FMS-10FE
193R-330A3	FMS-10A6	FMS-10NV	FMS-10A
193R-330A4	FMS-10F	FMS-10B	FMS-10A1

**FMS
Test Switches**

FMS Semiflush-Mounted Test Switches (19 inch Rack Mount)

FMS Test Switches

3RU 19x5.25 Racks

Catalog No.	Switch A	Switch B	Switch C
193R-330A6	FMS-10SQ	FMS-10SQ	FMS-10SQ
193R-330A7	FMS-10A	FMS-10HS	FMS-10A
193R-330A8	FMS-10A	FMS-10YS	FMS-10A
193R-330A9	FMS-10AH	FMS-10P1	FMS-10P1
193R-330B	FMS-10A1	FMS-08G	FMS-08G
193R-330B1	FMS-10F	FMS-10F	FMS-10YT
193R-330B2	FMS-10A	FMS-10NJ	FMS-10A
193R-330B3	FMS-10D	FMS-10D	FMS-10NV
193R-330B4	FMS-10HI	FMS-10MC	FMS-10GT
193R-330B5	FMS-10HI	FMS-10GP	FMS-10GT
193R-330B6	FMS-10D	FMS-10F	FMS-10WR
193R-330B7	FMS-10V	FMS-10V	FMS-10V
193R-330B8	FMS-10A	FMS-10IW	FMS-10A
193R-330B9	FMS-10F	FMS-10A3	FMS-10D6
193R-330BA	FMS-10E1	FMS-10A1	FMS-10A1
193R-330BB	FMS-10HR	FMS-10HR	FMS-10HR
193R-330BC	FMS-10A1	FMS-10A1	FMS-10E1
193R-330BD	FMS-10A1	FMS-10FJ	FMS-10E1
193R-330BE	FMS-10FK	FMS-10FK	FMS-10E
193R-330BF	FMS-10D	FMS-10D	FMS-10D
193R-330BI	FMS-10FN	FMS-10FN	FMS-10FN
193R-330BJ	FMS-10GJ	FMS-10GJ	FMS-10A1
193R-330BM	FMS-10E1	FMS-10FJ	FMS-10A1
193R-330BN	FMS-10GK	FMS-10A	FMS-10A
193R-330BP	FMS-10GK	FMS-10Z	FMS-10A
193R-330BS	FMS-10A1	FMS-10GL	FMS-10G
193R-330BT	FMS-10GS	FMS-10A	FMS-10JJ
193R-330BU	FMS-10HR	FMS-10HR	FMS-10GS
193R-330BX	FMS-10A1	FMS-10A1	FMS-10GK
193R-330C	FMS-10V	FMS-10A	FMS-10A1
193R-330C1	FMS-10E3	FMS-10A	FMS-10D6
193R-330C2	FMS-10C	FMS-10A	FMS-10D6
193R-330C3	FMS-10E2	FMS-10D8	FMS-10A
193R-330C4	FMS-10E2	FMS-10D8	FMS-D9
193R-330C5	FMS-10D7	FMS-10A3	FMS-10PV
193R-330C6	FMS-10GK	FMS-10GK	FMS-10GM
193R-330C8	FMS-10C	FMS-10A	FMS-10I3
193R-330C9	FMS-10GK	FMS-10GK	FMS-10GB
193R-330CA	FMS-10V	FMS-10A	FMS-10A
193R-330CB	FMS-10GA	FMS-10A	FMS-10A
193R-330CC	FMS-10GA	FMS-10A1	FMS-10A1
193R-330CD	FMS-10E4	FMS-10E4	FMS-10A1
193R-330CE	FMS-10E2	FMS-10A1	FMS-10E2
193R-330CF	FMS-10F	FMS-10A	FMS-10A
193R-330CG	FMS-10E3	FMS-10E2	FMS-10E2
193R-330CH	FMS-10E4	FMS-10A1	FMS-10A1
193R-330CI	FMS-10E	FMS-10A	FMS-10E
193R-330CJ	FMS-10E4	FMS-10E4	FMS-10E4
193R-330CK	FMS-10E2	FMS-10A	FMS-10A
193R-330CL	FMS-10AT	FMS-10A	FMS-10D
193R-330CN	FMS-10FF	FMS-10A1	FMS-10A1
193R-330CP	FMS-10G	FMS-10FF	FMS-10FF
193R-330CR	FMS-10G	FMS-10FF	FMS-10G
193R-330CS	FMS-10G	FMS-10A1	FMS-10A1
193R-330CT	FMS-10C	FMS-10B	FMS-10B
193R-330CU	FMS-10AD	FMS-10AD	FMS-10E3
193R-330CW	FMS-10FK	FMS-10FK	FMS-10FP
193R-330CX	FMS-10FK	FMS-10FK	FMS-10FK

3RU 19x5.25 Racks

Catalog No.	Switch A	Switch B	Switch C
193R-330CY	FMS-10FK	FMS-10FK	FMS-10E3
193R-330CZ	FMS-10A	FMS-10A	FMS-10E
193R-330D	FMS-10V	FMS-10A	FMS-10FC
193R-330D1	FMS-10F	FMS-10E3	FMS-10NV
193R-330D2	FMS-10F	FMS-10F	FMS-10E2
193R-330D3	FMS-10F	FMS-10RJ	FMS-10E2
193R-330D4	FMS-10XJ	FMS-10XK	FMS-10XL
193R-330D5	FMS-10E	FMS-10A1	FMS-10V
193R-330D6	FMS-10E	FMS-10FG	FMS-10A
193R-330D7	FMS-10E1	FMS-10A1	FMS-10F
193R-330D8	FMS-10A1	FMS-10A1	FMS-10GB
193R-330DA	FMS-10JP	FMS-10JP	FMS-10JP
193R-330DB	FMS-10GT	FMS-10GT	FMS-10GT
193R-330DC	FMS-10E	FMS-10E	FMS-10E
193R-330DF	FMS-10JU	FMS-10F	FMS-10F
193R-330DH	FMS-10A	FMS-10E	FMS-10A
193R-330DI	FMS-10F	FMS-10F	FMS-10A1
193R-330DL	FMS-10G	FMS-10A1	FMS-10A
193R-330DM	FMS-10FF	FMS-10FF	FMS-10FF
193R-330DN	FMS-10FF	FMS-10A	FMS-10A1
193R-330DP	FMS-10GK	FMS-10Z	FMS-10A3
193R-330DR	FMS-10A	FMS-10F	FMS-10F
193R-330DS	FMS-10E1	FMS-10E1	FMS-10E
193R-330DT	FMS-10GK	FMS-10E2	FMS-10E2
193R-330DU	FMS-10F	FMS-10F	FMS-10FK
193R-330DV	FMS-10E4	FMS-10E4	FMS-10GZ
193R-330DW	FMS-10E4	FMS-10E4	FMS-10A
193R-330DX	FMS-10E4	FMS-10A	FMS-10E4
193R-330DY	FMS-10F	FMS-10E1	FMS-10A1
193R-330DZ	FMS-10E1	FMS-10JK	FMS-10A1
193R-330E	FMS-10V	FMS-10A	FMS-10GB
193R-330EA	FMS-10FF	FMS-10FF	FMS-10G
193R-330ED	FMS-10G	FMS-10G	FMS-10G
193R-330EF	FMS-10E1	FMS-10E1	FMS-10FK
193R-330EG	FMS-10E1	FMS-10A	FMS-10A
193R-330EH	FMS-10E	FMS-10A	FMS-10A
193R-330EI	FMS-10A1	FMS-10E4	FMS-10E4
193R-330EJ	FMS-10G	FMS-10G	FMS-10A1
193R-330EK	FMS-10A	FMS-10E4	FMS-10A
193R-330EL	FMS-10A1	FMS-10A1	FMS-10FK
193R-330EM	FMS-10FK	FMS-10FK	FMS-10F
193R-330EN	FMS-10V	FMS-10V	FMS-10A1
193R-330EP	FMS-10A	FMS-10E	FMS-10E
193R-330EQ	FMS-10A1	FMS-10E1	FMS-10E1
193R-330ER	FMS-10AB	FMS-10AB	FMS-10AB
193R-330EW	FMS-10E	FMS-10A	FMS-10LP
193R-330EX	FMS-10E	FMS-10LP	FMS-10A
193R-330EY	FMS-10A	FMS-10B	FMS-10D
193R-330E1	FMS-10E1	FMS-10E1	FMS-10E1
193R-330F	FMS-10E	FMS-10GA	FMS-10E
193R-330F1	FMS-10E2	FMS-10HZ	FMS-10A
193R-330F2	FMS-10QG	FMS-10WS	FMS-10QI
193R-330F3	FMS-10QH	FMS-10AA	FMS-10JK
193R-330F4	FMS-10F	FMS-10F	FMS-10GT
193R-330F5	FMS-10E3	FMS-10E2	FMS-10GT
193R-330F6	FMS-10E9	FMS-10GS	FMS-10F
193R-330F7	FMS-10LD	FMS-10HI	FMS-10E3
193R-330F8	FMS-10K9	FMS-10E2	FMS-10FP

3RU 19x5.25 Racks

Catalog No.	Switch A	Switch B	Switch C
193R-330F9	FMS-10E3	FMS-10D	FMS-10K8
193R-330FA	FMS-10B	FMS-10PK	FMS-10PL
193R-330FB	FMS-10FF	FMS-10A1	FMS-10FF
193R-330FC	FMS-10FF	FMS-10JK	FMS-10A1
193R-330FD	FMS-10FX	FMS-10PQ	FMS-10Y
193R-330FE	FMS-10AB	FMS-10A	FMS-10A
193R-330FJ	FMS-10E1	FMS-10A1	FMS-10LP
193R-330FK	FMS-10E1	FMS-10LP	FMS-10A1
193R-330FN	FMS-10HE	FMS-10HE	FMS-10HE
193R-330FP	FMS-10E	FMS-10E	FMS-10A
193R-330FR	FMS-10FF	FMS-10A1	FMS-10FA
193R-330FS	FMS-10G	FMS-10A1	FMS-10PU
193R-330FT	FMS-10A1	FMS-10GM	FMS-10A1
193R-330FU	FMS-10E	FMS-10E	FMS-10AF
193R-330FW	FMS-10FG	FMS-10E	FMS-10E
193R-330FY	FMS-10GN	FMS-10A	FMS-10A
193R-330G	FMS-10G	FMS-10A1	FMS-10GM
193R-330G1	FMS-10KK	FMS-10A	FMS-10A
193R-330G2	FMS-10XP	FMS-10A	FMS-10A
193R-330G3	FMS-10YB	FMS-10YB	FMS-10A
193R-330G4	FMS-10XP	FMS-10XP	FMS-10XP
193R-330G5	FMS-10A	FMS-10A	FMS-10E4
193R-330G6	FMS-10A	FMS-10A	FMS-10D
193R-330G7	FMS-10A1	FMS-10AH	FMS-10AH
193R-330GC	FMS-10E	FMS-10A	FMS-10KB
193R-330GE	FMS-10F	FMS-10F	FMS-10HI
193R-330GJ	FMS-10MA	FMS-10MB	FMS-10GT
193R-330GK	FMS-10A1	FMS-10A	FMS-10A
193R-330GM	FMS-10D	FMS-10A	FMS-10D
193R-330GN	FMS-10AB	FMS-10A	FMS-10AB
193R-330GQ	FMS-10D	FMS-10F	FMS-10A
193R-330GR	FMS-10D	FMS-10A	FMS-10A
193R-330GT	FMS-10GN	FMS-10A	FMS-10A
193R-330GV	FMS-10C	FMS-10C	FMS-10C
193R-330GX	FMS-10G	FMS-10A1	FMS-10GA
193R-330GY	FMS-10G	FMS-10A1	FMS-10MW
193R-330GZ	FMS-10F	FMS-10A1	FMS-10A
193R-330H	FMS-10F	FMS-10A1	FMS-10GM
193R-330H1	FMS-10P6	FMS-10P7	FMS-10A1
193R-330H2	FMS-10GK	FMS-10EL	FMS-10A1
193R-330H3	FMS-10GK	FMS-10GK	FMS-10A1
193R-330H4	FMS-10F	FMS-10F	FMS-10N7
193R-330H5	FMS-10A1	FMS-10G	FMS-10JJ
193R-330H6	FMS-10A	FMS-10A	FMS-10E3
193R-330H7	FMS-10XP	FMS-10EO	FMS-10A
193R-330H8	FMS-10HK	FMS-10FF	FMS-10A
193R-330H9	FMS-10QG	FMS-10QG	FMS-10QI
193R-330HA	FMS-10F	FMS-10HZ	FMS-10A
193R-330HB	FMS-10GK	FMS-10A1	FMS-10A1
193R-330HC	FMS-10D	FMS-10F	FMS-10F
193R-330HD	FMS-10MZ	FMS-10GK	FMS-10NC
193R-330HG	FMS-10JJ	FMS-10A1	FMS-10HD
193R-330HI	FMS-10FF	FMS-10FF	FMS-10A1
193R-330HJ	FMS-10F	FMS-10F	FMS-10A
193R-330HK	FMS-10GA	FMS-10A1	FMS-10HD
193R-330HL	FMS-10E	FMS-10JG	FMS-10E3
193R-330HM	FMS-10E	FMS-10E	FMS-10E3
193R-330HN	FMS-10E1	FMS-10E1	FMS-10A1

3RU 19x5.25 Racks

Catalog No.	Switch A	Switch B	Switch C
193R-330HP	FMS-10E1	FMS-10E4	FMS-10A1
193R-330HT	FMS-10E1	FMS-10E1	FMS-10A
193R-330HU	FMS-10NL	FMS-10F	FMS-10GU
193R-330HV	FMS-10F	FMS-10F	FMS-10MB
193R-330HX	FMS-10G	FMS-10GL	FMS-10FB
193R-330HY	FMS-10D	FMS-10NS	FMS-10NT
193R-330I	FMS-10E	FMS-10A1	FMS-10A1
193R-330IB	FMS-10NV	FMS-10NV	FMS-10NV
193R-330ID	FMS-10A1	FMS-10A1	FMS-10G
193R-330IE	FMS-10D	FMS-10D	FMS-10A
193R-330IE1	FMS-10D	FMS-10F	FMS-10D
193R-330IE2	FMS-10D	FMS-10D	FMS-10F
193R-330IF	FMS-10C	FMS-10C	FMS-10F
193R-330IG	FMS-10AB	FMS-10E	FMS-10E
193R-330IH	FMS-10FI	FMS-10E	FMS-10E
193R-330IJ	FMS-10A	FMS-10HD	FMS-10F
193R-330IK	FMS-10A1	FMS-10G	FMS-10G
193R-330IL	FMS-10GM	FMS-10A1	FMS-10HD
193R-330IM	FMS-10GM	FMS-10A1	FMS-10NV
193R-330IN	FMS-10GM	FMS-10HD	FMS-10HD
193R-330IP	FMS-10HD	FMS-10HD	FMS-10HD
193R-330IQ	FMS-10GM	FMS-10GK	FMS-10NC
193R-330IS	FMS-10FA	FMS-10FA	FMS-10FI
193R-330IT	FMS-10AB	FMS-10AB	FMS-10A
193R-330IU	FMS-10PG	FMS-10A1	FMS-10AH
193R-330IV	FMS-10FI	FMS-10FA	FMS-10FA
193R-330IW	FMS-10E3	FMS-10GA	FMS-10JG
193R-330IX	FMS-10E2	FMS-10E2	FMS-10JG
193R-330IY	FMS-10JG	FMS-10JG	FMS-10JG
193R-330IZ	FMS-10LV	FMS-10HD	FMS-10HD
193R-330J	FMS-10A1	FMS-10A1	FMS-10A1
193R-330J1	FMS-10FP	FMS-10FB	FMS-10FB
193R-330J2	FMS-10A2	FMS-10A	FMS-10Q6
193R-330J3	FMS-10E2	FMS-10A	FMS-10GT
193R-330J6	FMS-10S2	FMS-10A	FMS-10A
193R-330J7	FMS-10S3	FMS-10S3	FMS-10S3
193R-330J8	FMS-10S3	FMS-10A	FMS-10S3
193R-330J9	FMS-10A	FMS-10A	FMS-10GA
193R-330JA	FMS-10E2	FMS-10E2	FMS-10G
193R-330JB	FMS-10FM	FMS-10NZ	FMS-10A1
193R-330JC	FMS-10U	FMS-10U	FMS-10HE
193R-330JD	FMS-10KW	FMS-10HE	FMS-10HE
193R-330JE	FMS-10JD	FMS-10HE	FMS-10HE
193R-330JF	FMS-10E2	FMS-10E2	FMS-10A
193R-330JG	FMS-10E4	FMS-10E1	FMS-10A1
193R-330JH	FMS-10GZ	FMS-10A1	FMS-10A1
193R-330JI	FMS-10JV	FMS-10JV	FMS-10JV
193R-330JJ	FMS-10JV	FMS-10JW	FMS-10A1
193R-330JL	FMS-10F	FMS-10F	FMS-10P
193R-330JM	FMS-10A	FMS-10AB	FMS-10A
193R-330JN	FMS-10FI	FMS-10A1	FMS-10A1
193R-330JP	FMS-10A	FMS-10E	FMS-10E3
193R-330JQ	FMS-10MQ	FMS-10QE	FMS-10QC
193R-330JR	FMS-10QF	FMS-10QF	FMS-10QF
193R-330JS	FMS-10MQ	FMS-10MQ	FMS-10QD
193R-330JT	FMS-10QH	FMS-10A1	FMS-10A
193R-330JU	FMS-10Z	FMS-10Z	FMS-10Z
193R-330JV	FMS-10QH	FMS-10E2	FMS-10Z

FMS
Test Switches

FMS Semiflush-Mounted Test Switches (19 inch Rack Mount)

FMS
Test Switches

3RU 19x5.25 Racks

Catalog No.	Switch A	Switch B	Switch C
193R-330JW	FMS-10QI	FMS-10Z	FMS-10Z
193R-330JX	FMS-10E2	FMS-10Z	FMS-10Z
193R-330JY	FMS-10QG	FMS-10QG	FMS-10QG
193R-330JZ	FMS-10QG	FMS-10QG	FMS-10A
193R-330K	FMS-10F	FMS-10A1	FMS-10A1
193R-330KA	FMS-10QI	FMS-10A	FMS-10A
193R-330KB	FMS-10QH	FMS-10QH	FMS-10QH
193R-330KC	FMS-10QG	FMS-10QG	FMS-10QJ
193R-330KE	FMS-10QJ	FMS-10QJ	FMS-10A
193R-330KF	FMS-10QK	FMS-10A	FMS-10A
193R-330KI	FMS-10GT	FMS-10GT	FMS-10F
193R-330KJ	FMS-10QJ	FMS-10QJ	FMS-10QJ
193R-330KL	FMS-10QJ	FMS-10A	FMS-10A
193R-330KM	FMS-10A	FMS-10FG	FMS-10A
193R-330KN	FMS-10E3	FMS-10E3	FMS-10E3
193R-330KQ	FMS-10GK	FMS-10GK	FMS-10A
193R-330KR	FMS-10E2	FMS-10E2	FMS-10E3
193R-330KS	FMS-10R1	FMS-10A1	FMS-10A1
193R-330KT	FMS-10R3	FMS-10R4	FMS-10A1
193R-330KU	FMS-10PU	FMS-10NH	FMS-10NH
193R-330KV	FMS-10R1	FMS-10R2	FMS-10A1
193R-330KW	FMS-10R1	FMS-10R1	FMS-10A1
193R-330L	FMS-10F	FMS-10F	FMS-10F
193R-330L2	FMS-10F	FMS-10U1	FMS-10A1
193R-330L3	FMS-10U1	FMS-10A1	FMS-10A1
193R-330LA	FMS-10GK	FMS-10A1	FMS-10A
193R-330LC	FMS-10E1	FMS-10A	FMS-10A1
193R-330LE	FMS-10QW	FMS-10QX	FMS-10QY
193R-330LF	FMS-10A1	FMS-10A	FMS-10A1
193R-330LG	FMS-10A	FMS-10A	FMS-10QR
193R-330LH	FMS-10A	FMS-10QR	FMS-10QR
193R-330LI	FMS-10A	FMS-10NH	FMS-10NH
193R-330LJ	FMS-10F	FMS-10P	FMS-10A1
193R-330LN	FMS-10GP	FMS-10V	FMS-10V
193R-330LP	FMS-10GM	FMS-10GS	FMS-10GS
193R-330LQ	FMS-10D	FMS-10PV	FMS-10A
193R-330LV	FMS-10C1	FMS-10C1	FMS-10C1
193R-330LW	FMS-10PV	FMS-10D	FMS-10PV
193R-330LX	FMS-10FP	FMS-10D	FMS-10PV
193R-330LY	FMS-10A	FMS-10A	FMS-10V
193R-330LZ	FMS-10E1	FMS-10A1	FMS-10E1
193R-330M	FMS-10GS	FMS-10A	FMS-10A1
193R-330MA	FMS-10GK	FMS-10LG	FMS-10A1
193R-330MB	FMS-10E4	FMS-10E1	FMS-10E1
193R-330MC	FMS-10MQ	FMS-10RS	FMS-10GT
193R-330MD	FMS-10MQ	FMS-10A	FMS-10RT
193R-330ME	FMS-10GK	FMS-10RU	FMS-10A1
193R-330MF	FMS-10MQ	FMS-10GT	FMS-10GT
193R-330MG	FMS-10A1	FMS-10P	FMS-10A1
193R-330MI	FMS-10FM	FMS-10NZ	FMS-10NZ
193R-330MJ	FMS-10GM	FMS-10HD	FMS-10NW
193R-330MK	FMS-10MQ	FMS-10GT	FMS-10RV
193R-330MM	FMS-10E1	FMS-10E1	FMS-10RZ
193R-330MN	FMS-10E4	FMS-10SA	FMS-10A1
193R-330MP	FMS-10FV	FMS-10A1	FMS-10FV
193R-330MQ	FMS-10SB	FMS-10JJ	FMS-10SB
193R-330MR	FMS-10SC	FMS-10SC	FMS-10NV
193R-330MS	FMS-10F	FMS-10RJ	FMS-10NV

3RU 19x5.25 Racks

Catalog No.	Switch A	Switch B	Switch C
193R-330MT	FMS-10F	FMS-10A3	FMS-10A
193R-330MU	FMS-10SE	FMS-10SF	FMS-10SG
193R-330MV	FMS-10SE	FMS-10SF	FMS-10SH
193R-330MW	FMS-10FA	FMS-10A1	FMS-10A1
193R-330MZ	FMS-10SQ	FMS-10SR	FMS-10NV
193R-330N	FMS-10A	FMS-10A	FMS-10F
193R-330NA	FMS-10D	FMS-10SS	FMS-10ST
193R-330NB	FMS-10F	FMS-10E3	FMS-10A1
193R-330NC	FMS-10F	FMS-10G	FMS-10A1
193R-330ND	FMS-10JJ	FMS-10GS	FMS-10GS
193R-330NE	FMS-10GS	FMS-10GS	FMS-10GS
193R-330NF	FMS-10E1	FMS-10AP	FMS-10A1
193R-330NG	FMS-10AP	FMS-10A1	FMS-10A1
193R-330NI	FMS-10AB	FMS-10FX	FMS-10A
193R-330NK	FMS-10JJ	FMS-10A1	FMS-10GS
193R-330NL	FMS-10FI	FMS-10FI	FMS-10FI
193R-330NN	FMS-10BH	FMS-10BH	FMS-10BV
193R-330NP	FMS-10BN	FMS-10BN	FMS-10BM
193R-330NR	FMS-10BI	FMS-10BJ	FMS-10BN
193R-330NS	FMS-10BN	FMS-10BN	FMS-10BN
193R-330NT	FMS-10BN	FMS-10BN	FMS-10BU
193R-330NU	FMS-10G	FMS-10LE	FMS-10JK
193R-330NV	FMS-10BH	FMS-10BH	FMS-10BH
193R-330NW	FMS-10BV	FMS-10BV	FMS-10BV
193R-330NX	FMS-10BI	FMS-10BJ	FMS-10BW
193R-330NZ	FMS-10BX	FMS-10BX	FMS-10BX
193R-330P	FMS-10V	FMS-10A	FMS-10GN
193R-330PA	FMS-10CF	FMS-10FC	FMS-10FC
193R-330PB	FMS-10CG	FMS-10FC	FMS-10CH
193R-330PC	FMS-10CI	FMS-10FC	FMS-10CH
193R-330PE	FMS-10PG	FMS-10A1	FMS-10PG
193R-330PH	FMS-10PH	FMS-10PH	FMS-10PH
193R-330PI	FMS-10TM	FMS-10TM	FMS-10TM
193R-330PM	FMS-10VD	FMS-10IW	FMS-10A
193R-330PN	FMS-10F	FMS-10WD	FMS-10NV
193R-330PQ	FMS-10DL	FMS-10J	FMS-10A4
193R-330PR	FMS-10TQ	FMS-10A1	FMS-10A1
193R-330PS	FMS-10QW	FMS-10XH	FMS-10XF
193R-330PT	FMS-10YG	FMS-10GT	FMS-10BF
193R-330PU	FMS-10MQ	FMS-10GT	FMS-10BF
193R-330Q	FMS-10E2	FMS-10A	FMS-10E2
193R-330QA	FMS-10BX	FMS-10BN	FMS-10BU
193R-330QE	FMS-10BX	FMS-10BX	FMS-10BU
193R-330QG	FMS-10PD	FMS-10AH	FMS-10AH
193R-330QH	FMS-10AH	FMS-10AH	FMS-10AH
193R-330QI	FMS-10PH	FMS-10AH	FMS-10AH
193R-330QJ	FMS-10PG	FMS-10PG	FMS-10A1
193R-330QK	FMS-10PG	FMS-10PG	FMS-10PG
193R-330QL	FMS-10PG	FMS-10AH	FMS-10AH
193R-330QM	FMS-10PG	FMS-10CB	FMS-10AH
193R-330QR	FMS-10AH	FMS-10PG	FMS-10PG
193R-330QT	FMS-10F	FMS-10JK	FMS-10A1
193R-330QU	FMS-10MQ	FMS-10CM	FMS-10CN
193R-330QV	FMS-10A	FMS-10RT	FMS-10GT
193R-330QY	FMS-10D	FMS-10D	FMS-10NT
193R-330QZ	FMS-10D	FMS-10D	FMS-10CU
193R-330R	FMS-10E2	FMS-10E2	FMS-10E2
193R-330RA	FMS-10FP	FMS-10NV	FMS-10SR

3RU 19x5.25 Racks

Catalog No.	Switch A	Switch B	Switch C
193R-330RB	FMS-10E3	FMS-10E2	FMS-10A
193R-330RD	FMS-10D	FMS-10CU	FMS-10NV
193R-330RE	FMS-10F	FMS-10A	FMS-10A1
193R-330RI	FMS-10AB	FMS-10A	FMS-10DC
193R-330RJ	FMS-10E3	FMS-10E3	FMS-10E2
193R-330RK	FMS-10E	FMS-10E3	FMS-10A
193R-330RL	FMS-10MQ	FMS-10RS	FMS-10BF
193R-330RM	FMS-10DI	FMS-10DJ	FMS-10DK
193R-330RO	FMS-10D	FMS-10GT	FMS-10D
193R-330RP	FMS-10LT	FMS-10A	FMS-10PN
193R-330RR	FMS-10C	FMS-10DU	FMS-10A
193R-330RS	FMS-10DV	FMS-10A1	FMS-10A1
193R-330RT	FMS-10DW	FMS-10SR	FMS-10SR
193R-330RU	FMS-10DZ	FMS-10GS	FMS-10GS
193R-330RW	FMS-10C	FMS-10EC	FMS-10A
193R-330RX	FMS-10LD	FMS-10A	FMS-10A
193R-330RY	FMS-10GC	FMS-10MC	FMS-10GC
193R-330RZ	FMS-10EE	FMS-10EF	FMS-10EE
193R-330S	FMS-10A	FMS-10A	FMS-10A
193R-330S1	FMS-10AD	FMS-10AD	FMS-10JU
193R-330S2	FMS-10AD	FMS-10AD	FMS-10HZ
193R-330S3	FMS-10A1	FMS-10F	FMS-10F
193R-330S4	FMS-10PG	FMS-10PG	FMS-10HX
193R-330S5	FMS-10XO	FMS-10L3	FMS-10A
193R-330S6	FMS-10E2	FMS-10E2	FMS-10F
193R-330S7	FMS-10FF	FMS-10I	FMS-10A1
193R-330S8	FMS-10HZ	FMS-10A1	FMS-10A1
193R-330S9	FMS-10SK	FMS-10SK	FMS-10SK
193R-330SA	FMS-10GC	FMS-10GT	FMS-10GC
193R-330SB	FMS-10GC	FMS-10MN	FMS-10GC
193R-330SC	FMS-10GC	FMS-10ED	FMS-10GC
193R-330SD	FMS-10AD	FMS-10AD	FMS-10AD
193R-330SE	FMS-10GC	FMS-10GT	FMS-10E2
193R-330SF	FMS-10GC	FMS-10JI	FMS-10GC
193R-330SG	FMS-10E1	FMS-10EG	FMS-10A1
193R-330SH	FMS-10F	FMS-10E	FMS-10A
193R-330SJ	FMS-10F	FMS-10AC	FMS-10A
193R-330SK	FMS-10DF	FMS-10AH	FMS-10AH
193R-330SM	FMS-10PG	FMS-10EJ	FMS-10AH
193R-330SN	FMS-10E2	FMS-10E2	FMS-10GT
193R-330SO	FMS-10E2	FMS-10E3	FMS-10GT
193R-330SP	FMS-10F	FMS-10HI	FMS-10A
193R-330SQ	FMS-10GL	FMS-10A	FMS-10A
193R-330SR	FMS-10DZ	FMS-10DZ	FMS-10DZ
193R-330SS	FMS-10A	FMS-10E2	FMS-10A
193R-330ST	FMS-10A	FMS-10E1	FMS-10E1
193R-330SU	FMS-10FI	FMS-10A1	FMS-10FJ
193R-330SV	FMS-10AB	FMS-10A1	FMS-10A1
193R-330SW	FMS-10AB	FMS-10A1	FMS-10FJ
193R-330SY	FMS-10EU	FMS-10EV	FMS-10ET
193R-330SZ	FMS-10GP	FMS-10A	FMS-10A
193R-330T	FMS-10A	FMS-10A	FMS-10A1
193R-330T1	FMS-10L5	FMS-10L6	FMS-10A
193R-330T2	FMS-10C	FMS-10TX	FMS-10IW
193R-330T3	FMS-10FF	FMS-10FF	FMS-10FF
193R-330T4	FMS-10TH	FMS-10TH	FMS-10FC
193R-330T5	FMS-10TH	FMS-10TH	FMS-10TH
193R-330T7	FMS-10FF	FMS-10AD	FMS-10JK

3RU 19x5.25 Racks

Catalog No.	Switch A	Switch B	Switch C
193R-330T8	FMS-10E	FMS-10FP	FMS-10E
193R-330T9	FMS-10CF	FMS-10A1	FMS-10A1
193R-330TA	FMS-10C	FMS-10EW	FMS-10A
193R-330TB	FMS-10E2	FMS-10EY	FMS-10PU
193R-330TC	FMS-10F	FMS-10EZ	FMS-10A1
193R-330TD	FMS-10E2	FMS-10IA	FMS-10GM
193R-330TE	FMS-10IB	FMS-10PU	FMS-10FA
193R-330TG	FMS-10E2	FMS-10IG	FMS-10FA
193R-330TI	FMS-10E2	FMS-10IF	FMS-10IH
193R-330TJ	FMS-10IB	FMS-10IJ	FMS-10FA
193R-330TK	FMS-10D	FMS-10E3	FMS-10A
193R-330TL	FMS-10E3	FMS-10IG	FMS-10PU
193R-330TM	FMS-10E3	FMS-10IA	FMS-10GM
193R-330TN	FMS-10E3	FMS-10IG	FMS-10FA
193R-330TO	FMS-10E3	FMS-10IG	FMS-10IH
193R-330TP	FMS-10E3	FMS-10A	FMS-10A
193R-330TQ	FMS-10FF	FMS-10A	FMS-10A
193R-330TR	FMS-10E2	FMS-10A	FMS-10D
193R-330TS	FMS-10FF	FMS-10JJ	FMS-10HZ
193R-330TV	FMS-10C1	FMS-10FJ	FMS-10A1
193R-330TW	FMS-10FF	FMS-10G	FMS-10A1
193R-330TX	FMS-10G	FMS-10A1	FMS-10HY
193R-330TY	FMS-10F	FMS-10JK	FMS-10HY
193R-330TZ	FMS-10F	FMS-10G	FMS-10HY
193R-330U	FMS-10E	FMS-10A	FMS-10GA
193R-330U1	FMS-10F	FMS-10NV	FMS-10NV
193R-330U2	FMS-10J4	FMS-10T7	FMS-10SR
193R-330U3	FMS-10F	FMS-10A3	FMS-10U8
193R-330U4	FMS-10A	FMS-10A	FMS-10Q6
193R-330U6	FMS-10XO	FMS-10A	FMS-10XO
193R-330U7	FMS-10FB	FMS-10A	FMS-10A
193R-330U8	FMS-10A1	FMS-10GK	FMS-10A1
193R-330U9	FMS-10AH	FMS-10AH	FMS-10GM
193R-330UA	FMS-10F	FMS-10F	FMS-10TG
193R-330UB	FMS-10F	FMS-10G	FMS-10TH
193R-330UC	FMS-10F	FMS-10F	FMS-10TI
193R-330UD	FMS-10FM	FMS-10FM	FMS-10FM
193R-330UE	FMS-10E3	FMS-10IF	FMS-10IH
193R-330UF	FMS-10TJ	FMS-10TJ	FMS-10TJ
193R-330UH	FMS-10E2	FMS-10E2	FMS-10A1
193R-330UI	FMS-10E2	FMS-10A1	FMS-10A1
193R-330UJ	FMS-10AB	FMS-10E2	FMS-10E2
193R-330UP	FMS-10GK	FMS-10GK	FMS-10GK
193R-330UR	FMS-10F	FMS-10A1	FMS-10F
193R-330UT	FMS-10F	FMS-10A	FMS-10F
193R-330UV	FMS-10A	FMS-10F	FMS-10A
193R-330UW	FMS-10HI	FMS-10A	FMS-10GT
193R-330UX	FMS-10IS	FMS-10A	FMS-10A
193R-330UY	FMS-10IV	FMS-10IW	FMS-10A
193R-330V	FMS-10GK	FMS-10JK	FMS-10A1
193R-330VA	FMS-10F	FMS-10TX	FMS-10A
193R-330VB	FMS-10F	FMS-10TY	FMS-10A
193R-330VC	FMS-10C	FMS-10TZ	FMS-10NJ
193R-330VE	FMS-10F	FMS-10FX	FMS-10F
193R-330VF	FMS-10F	FMS-10IV	FMS-10UA
193R-330VG	FMS-10C	FMS-10TX	FMS-10A
193R-330VH	FMS-10A	FMS-10A	FMS-10A1
193R-330VI	FMS-10DL	FMS-10UD	FMS-10DM

FMS
Test Switches

FMS Semiflush-Mounted Test Switches (19 inch Rack Mount)

3RU 19x5.25 Racks

Catalog No.	Switch A	Switch B	Switch C
193R-330VJ	FMS-10DL	FMS-10DL	FMS-10DM
193R-330VK	FMS-10LE	FMS-10F	FMS-10P
193R-330VO	FMS-10V	FMS-10A1	FMS-10V
193R-330VP	FMS-10NL	FMS-10NF	FMS-10GV
193R-330VS	FMS-10AB	FMS-10AB	FMS-10E
193R-330VU	FMS-10NL	FMS-10F	FMS-10GV
193R-330VW	FMS-10UJ	FMS-10UK	FMS-10A1
193R-330VX	FMS-10GP	FMS-10IW	FMS-10A
193R-330VY	FMS-10F	FMS-10UL	FMS-10A
193R-330VZ	FMS-10FI	FMS-10FA	FMS-10A1
193R-330WA	FMS-10C	FMS-10DU	FMS-10UB
193R-330WB	FMS-10C	FMS-10UC	FMS-10A
193R-330WC	FMS-10FM	FMS-10FA	FMS-10A1
193R-330WD	FMS-10A1	FMS-10E1	FMS-10A1
193R-330WE	FMS-10MB	FMS-10MB	FMS-10MB
193R-330WF	FMS-10FP	FMS-10A	FMS-10A
193R-330WG	FMS-10FP	FMS-10FP	FMS-10A
193R-330WH	FMS-10FC	FMS-10FC	FMS-10FC
193R-330WI	FMS-10FC	FMS-10FC	FMS-10A
193R-330WJ	FMS-10C1	FMS-10A1	FMS-10C1
193R-330WK	FMS-10C1	FMS-10VK	FMS-10C1
193R-330WL	FMS-10E1	FMS-10E1	FMS-10GB
193R-330WM	FMS-10E3	FMS-10E3	FMS-10HI
193R-330WO	FMS-10CG	FMS-10JG	FMS-10WA
193R-330WP	FMS-10E	FMS-10E	FMS-10PV
193R-330WQ	FMS-10E	FMS-10E	FMS-10TM
193R-330WR	FMS-10VY	FMS-10VY	FMS-10SR
193R-330WS	FMS-10E4	FMS-10E4	FMS-10VZ
193R-330WT	FMS-10CF	FMS-10WB	FMS-10FA
193R-330WU	FMS-10CI	FMS-10WB	FMS-10WA
193R-330WV	FMS-10PG	FMS-10PG	FMS-10AH
193R-330WW	FMS-10FP	FMS-10FB	FMS-10A
193R-330WY	FMS-10F	FMS-10F	FMS-10A
193R-330W1	FMS-10C	FMS-10B1	FMS-10A
193R-330W2	FMS-10C	FMS-10IS	FMS-10A
193R-330W3	FMS-10C2	FMS-10C3	FMS-10C4
193R-330W4	FMS-10F	FMS-10B4	FMS-10IW
193R-330W5	FMS-10E3	FMS-10DU	FMS-10A
193R-330W6	FMS-10D	FMS-10QV	FMS-10QV
193R-330W8	FMS-10R3	FMS-10R6	FMS-10A1
193R-330W9	FMS-10A	FMS-10A	FMS-10B
193R-330X1	FMS-10Y7	FMS-10Y6	FMS-10A1
193R-330X3	FMS-10G	FMS-10PU	FMS-10Z3
193R-330X4	FMS-10G	FMS-10HZ	FMS-10A1
193R-330X5	FMS-10Z5	FMS-10Z6	FMS-10AH
193R-330X6	FMS-10AH	FMS-10Z7	FMS-10AH
193R-330X7	FMS-10PG	FMS-10Z8	FMS-10AH
193R-330X8	FMS-10AH	FMS-10AH	FMS-10Z4
193R-330X9	FMS-10A1E	FMS-10Z4	FMS-10Z4
193R-330XA	FMS-10MN	FMS-10GC	FMS-10GC
193R-330XB	FMS-10GC	FMS-10GC	FMS-10GC
193R-330XC	FMS-10WF	FMS-10WF	FMS-10GC

3RU 19x5.25 Racks

Catalog No.	Switch A	Switch B	Switch C
193R-330XE	FMS-10QW	FMS-10WI	FMS-10FX
193R-330XG	FMS-10FP	FMS-10E2	FMS-10E2
193R-330XH	FMS-10FP	FMS-10E2	FMS-10A
193R-330XI	FMS-10A	FMS-10WR	FMS-10NV
193R-330XK	FMS-10WY	FMS-10WY	FMS-10WY
193R-330XL	FMS-10A	FMS-10E1	FMS-10GS
193R-330XM	FMS-10GS	FMS-10FF	FMS-10FF
193R-330XN	FMS-10A	FMS-10A1	FMS-10A
193R-330XO	FMS-10E4	FMS-10A1	FMS-10E4
193R-330XP	FMS-10D	FMS-10D	FMS-10SR
193R-330XQ	FMS-10SR	FMS-10SR	FMS-10SR
193R-330XR	FMS-10A	FMS-10E1	FMS-10GK
193R-330XS	FMS-10GS	FMS-10FF	FMS-10E1
193R-330XT	FMS-10CS	FMS-10CS	FMS-10CS
193R-330XW	FMS-10A1	FMS-10SR	FMS-10A
193R-330XY	FMS-10SQ	FMS-10GT	FMS-10AH
193R-330XZ	FMS-10XR	FMS-10XR	FMS-10XT
193R-330Y2	FMS-10Z9	FMS-10A1E	FMS-10Z4
193R-330Y3	FMS-10Z9	FMS-10A1E	FMS-10A1E
193R-330Y4	FMS-10GY	FMS-10A1A	FMS-10AH
193R-330Y5	FMS-10AH	FMS-10A1B	FMS-10AH
193R-330Y6	FMS-10A1D	FMS-10AH	FMS-10AH
193R-330Y7	FMS-10Z5	FMS-10A1C	FMS-10AH
193R-330Y8	FMS-10A	FMS-10A	FMS-10AB
193R-330YA	FMS-10XR	FMS-10SR	FMS-10SR
193R-330YC	FMS-10TH	FMS-10TH	FMS-10TH
193R-330YD	FMS-10TH	FMS-10XN	FMS-10A1
193R-330YE	FMS-10TH	FMS-10TH	FMS-10A1
193R-330YF	FMS-10HI	FMS-10A	FMS-10A
193R-330YH	FMS-10E	FMS-10E	FMS-10A1
193R-330YI	FMS-10WU	FMS-10HE	FMS-10SK
193R-330YL	FMS-10YE	FMS-10A1	FMS-10A1
193R-330YN	FMS-10GI	FMS-10GI	FMS-10GI
193R-330YO	FMS-10A	FMS-10A	FMS-10E1
193R-330YP	FMS-10YE	FMS-10D	FMS-10D
193R-330YT	FMS-10A	FMS-10A	FMS-10IW
193R-330YW	FMS-10C	FMS-10TX	FMS-10NJ
193R-330YX	FMS-10YT	FMS-10YS	FMS-10A
193R-330YZ	FMS-10A	FMS-10YU	FMS-10A
193R-330Z1	FMS-10A1	FMS-10E1	FMS-10D
193R-330Z2	FMS-10E1	FMS-10D	FMS-10A1
193R-330Z3	FMS-10K3	FMS-10A1	FMS-10A1
193R-330Z4	FMS-10A1	FMS-10A1	FMS-10F
193R-330Z6	FMS-10E	FMS-10E	FMS-10AB
193R-330Z8	FMS-10E2	FMS-10E3	FMS-10E2
193R-330ZA	FMS-10A	FMS-10GP	FMS-10A
193R-330ZB	FMS-10F	FMS-10F	FMS-10WR
193R-330ZR	FMS-10F	FMS-10E2	FMS-10A
193R-330ZS	FMS-10ZM	FMS-10ZN	FMS-10HE
193R-330ZT	FMS-10ZM	FMS-10ZL	FMS-10ZK
193R-330ZX	FMS-10E2	FMS-10F	FMS-10F

Please refer to the STATES website for more part numbers and up to date information

FMS R19 RACK SYSTEM

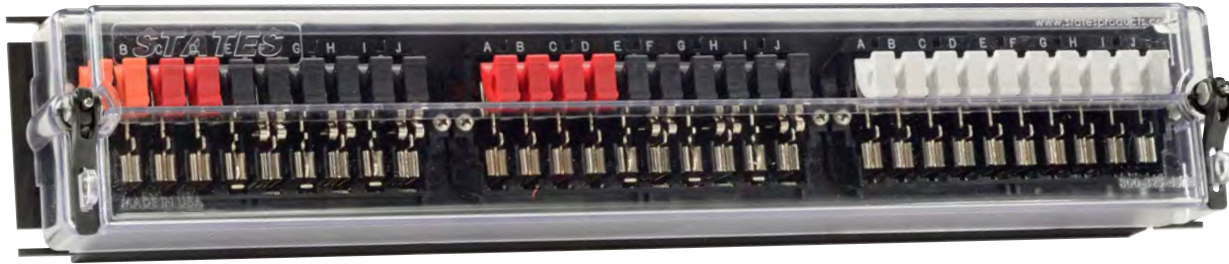

STATES R19 30 Pole rack System with lock-out clear option



R19 rear view with an optional 10 Pole back cover shown installed. See page 64 for back cover ordering information



FEATURES AND BENEFITS

- No downtime
- Easy access
- Secure
- Safe, durable, rugged and reliable
- Safe to use
- Choice of operation
- Cost-saving advantage
- Compact and versatile
- Constructed of 1/8 inch thick aluminum
- UL File No. E225664

R19 RACK SYSTEM

The STATES New R19 Rack System is very similar to our popular FMS 19" Rack Mount System. This new R19 Rack System makes it easier to replace individual test switches without interrupting the operation of the other test switches in the rack.

The changes can be done through the front without the need to remove the mounting plate.

The new 30 pole R19 Rack System comes standard with a clear cover which has an integrated quick release latch with a lock-out provision that can be used with any tags or pad-lock to help aid in your safety procedures. This unit can also be made available with a narrow black cover, without the integrated quick release latch system.

FMS Semiflush-Mounted Test Switches (R19 Rack Mount)

FMS
Test Switches

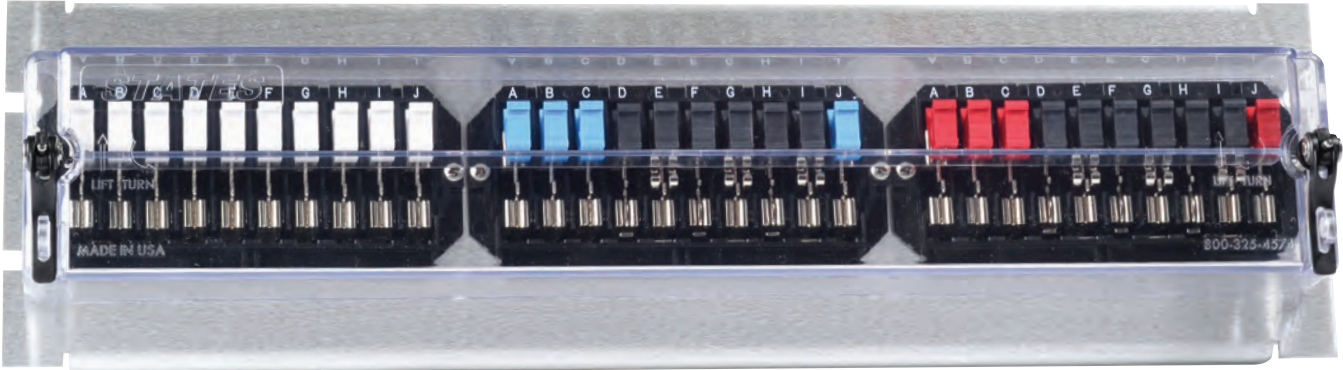

R19 with clear 30 pole lock-out cover

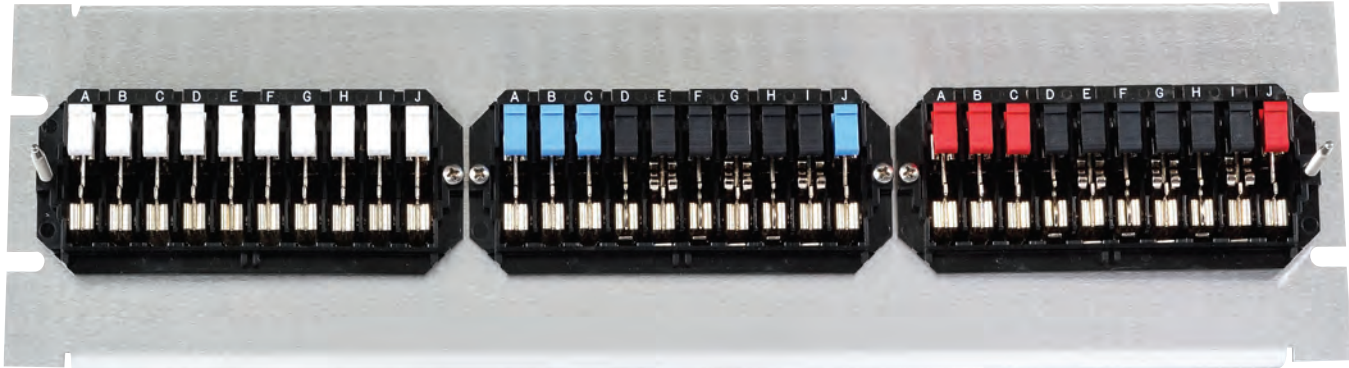

R19 view with cover removed



R19 rear view with optional back cover installed

R19 Lock-out Lever



STATES TYPE R19 RACK SYSTEM

Understanding R19 Rack Mount Part Numbers - 30 Pole Units						
1	2	3	4	5	6	7
Cover Type	Connection Type	Rack Size	Plate Type / Finish	Switch	Switch	Switch
B = Narrow Black 30 Pole Cover N = Narrow Clear 30 Pole Cover C = Clear 30 Pole Lock-out Cover *I = Individual Clear 10 Pole Covers *K = Individual Black 10 Pole Covers	S = Screw Terminals T = Stud Terminals	2 = 19 x 3.5 3 = 19 x 5.25 4 = 19 x 7 N = No Plate	Center Mount CR = Brushed Aluminum CG = ANSI 61 Gray CH = ANSI 70 Gray CB = Black Anodized Lower Mount LR = Brushed Aluminum LG = ANSI 61 Gray LH = ANSI 70 Gray LB = Black Anodized Upper Mount UR = Brushed Aluminum UG = ANSI 61 Gray UH = ANSI 70 Gray UB = Black Anodized NOTE: Lower & Upper mounting plates are only available on the following plates: 3 = 19 x 5.25 4 = 19 x 7	3-Digit Switch Code	3-Digit Switch Code	3-Digit Switch Code
				See catalog pages 26-36 or visit our website at www.statesproducts.com for arrangement options and switch codes		
				NOTE: All switch codes are 3 digits For blank spaces, please use XXX		

*Coming soon

EXAMPLES

<u>C</u> 1	<u>S</u> 2	<u>3</u> 3	<u>CG</u> 4	-	<u>10A</u> 5	-	<u>10A</u> 6	-	<u>10A</u> 7	Part No. CS3CG-10A-10A-10A 30 Pole Switch with a clear 30 pole cover, screw terminals, 19 x 5.25 center mounting ANSI 61 plate, and three FMS-10A switches.
---------------	---------------	---------------	----------------	---	-----------------	---	-----------------	---	-----------------	---

<u>C</u> 1	<u>T</u> 2	<u>4</u> 3	<u>LR</u> 4	-	<u>0E1</u> 5	-	<u>0E1</u> 6	-	<u>0E1</u> 7	Part No. CT4LR-0E1-0E1-0E1 30 Pole Switch with a clear 30 pole cover, stud terminals, 19 x 7 lower brushed aluminum plate, and three FMS-10E1 switches.
---------------	---------------	---------------	----------------	---	-----------------	---	-----------------	---	-----------------	---

To order individual switch replacements for the R19 Rack System, please replace the prefix "FMS-" with the letter "R" to the switch codes found in the FMS 10 pole arrangements listed under R19 Rack Code, on pages 26-36.

Example: R10A = all red single pole potentials in the modified R19 rack base

FMS Semiflush-Mounted Test Switches (R19 Rack Mount)

FMS LOCKOUT COVER

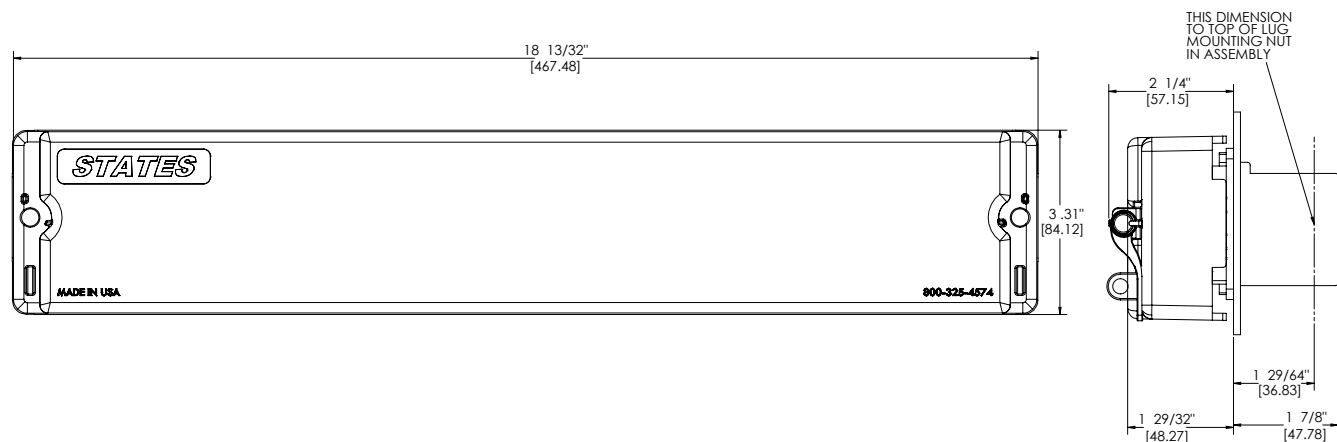

R19 LOWER MOUNT (3RU 19X5.25)

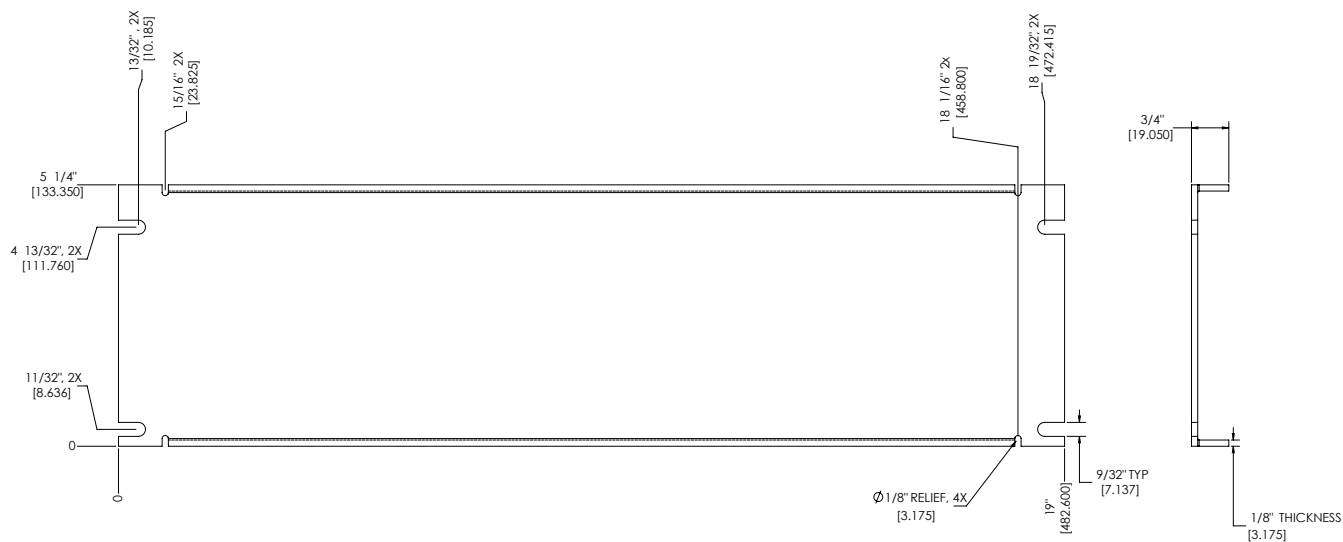

FMS Test Switches

2RU Mounting Dimensions

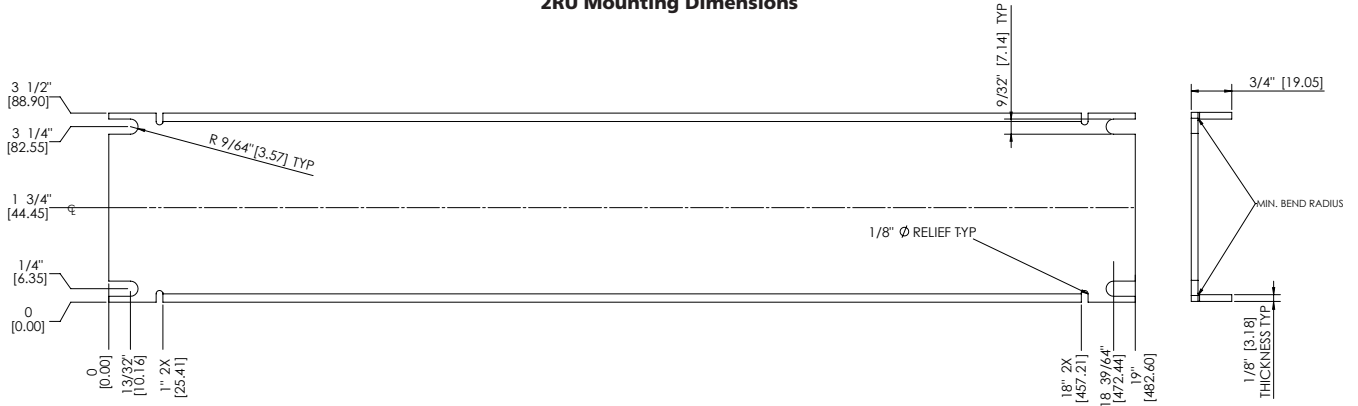

3RU Mounting Dimensions

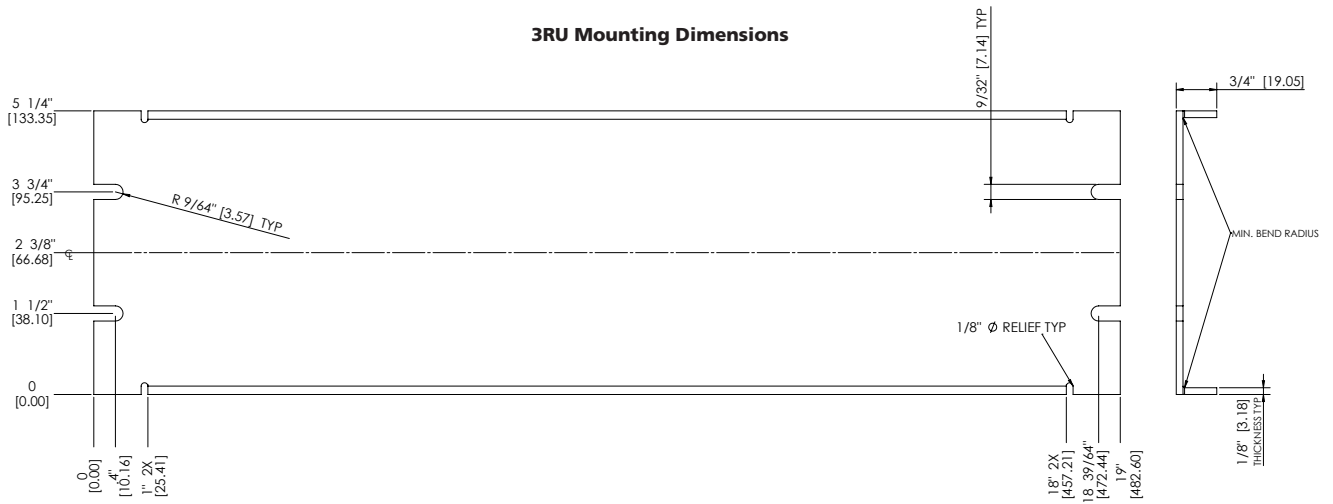

4RU Mounting Dimensions

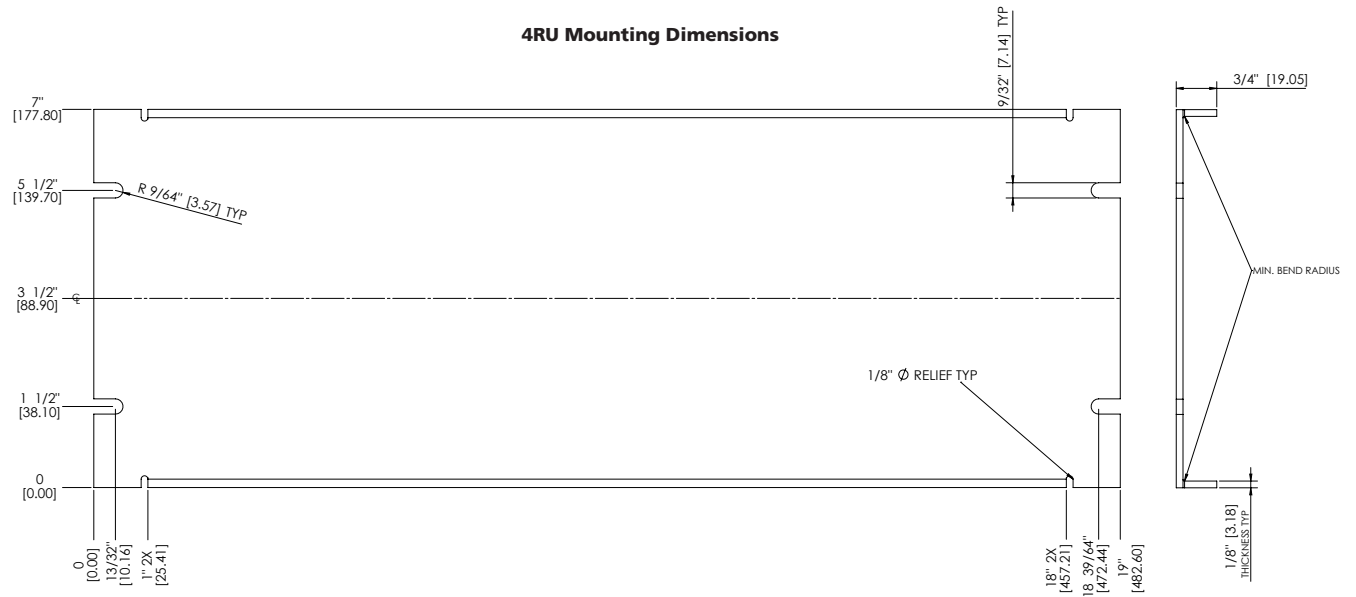

FMS ACCESSORIES

PART No. DESCRIPTION

680001 White Marker Handle Tags

50548-xx Handle Ganging Kit - Replace the "xx" with the required number of adjacent poles to be ganged together
(example: 50548-2 - 2 Pole Kit)

50898 10 Pole Hardware Kit (for Screw Terminals)

801034 14 Pole Hardware Kit (for Screw Terminals)

PR1404-100 Hex Nut 10-32 x 5/16 W x 14/64 Thick, Brass Nickel Plate (100pcs per bag)

XNT126-100 Hex Nut 10-32 x 5/16 W x 7/64 Thick, Brass Nickel Plate (100pcs per bag)

FMSLOCK-1 Cover Lock-out Kit for 10, 14, or 30 Pole Clear Wide Cover (includes lock-out bracket and mounting screws)

2003-016 10 Pole Black BACK Cover (for bases that include insert on back of switch base - see picture on page 59 for example)

2003-017 14 Pole Black BACK Cover (for bases that include insert on back of switch base - see picture on page 59 for example)

FMSKIT-10N 10 Pole Clear Narrow Cover Kit - includes cover, cover knobs and cover stud hardware

FMSKIT-14N 14 Pole Clear Narrow Cover Kit - includes cover, cover knobs and cover stud hardware

FMSKIT-30N 30 Pole Clear Narrow Cover Kit - includes cover, cover knobs and cover stud hardware

FMSKIT-10 10 Pole Clear Wide Cover Kit - includes cover, cover knobs and cover stud hardware

FMSKIT-14 14 Pole Clear Wide Cover Kit - includes cover, cover knobs and cover stud hardware

FMSKIT-30 30 Pole Clear Wide Cover Kit - includes cover, cover knobs and cover stud hardware

FMSKIT-10B 10 Pole Black Narrow Cover Kit - includes cover, cover knobs and cover stud hardware

FMSKIT-14B 14 Pole Black Narrow Cover Kit - includes cover, cover knobs and cover stud hardware

FMSKIT-30B 30 Pole Black Narrow Cover Kit - includes cover, cover knobs and cover stud hardware

Please refer to our website for accessory pictures.

MTS & JTS

Miniature Test Switches



- Compact and versatile
- Front- and back-connected styles
- Safe, durable, rugged and reliable
- Recognized by UL and cUL

STATES®

In many panelboard, switchgear, metering, control circuit and instrumentation applications, space is at a premium. Yet provisions must be made to facilitate troubleshooting, testing, calibration and checkout of relays, meters, transducers, instruments and control systems. STATES Type MTS Miniature Test Switches are the compact, versatile solution for disconnecting and testing these devices and circuits.

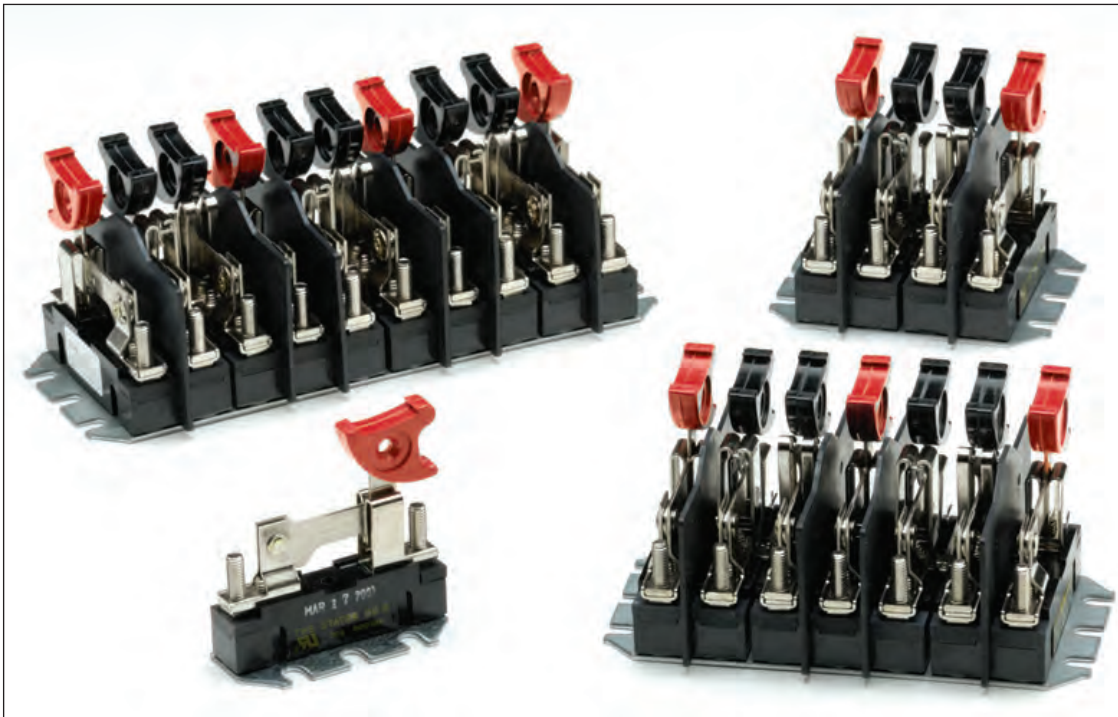

Space-saving miniaturization means full test capability; yet, a Type MTS 10-pole switch requires just 7 inches of mounting space. Unit-pole construction permits virtually any pole arrangement from 1 to 52 poles mounted on a single base.

DESCRIPTION

They are the result of many decades of experience in the design and manufacture of test switches, and make use of the latest improvements in material composition and construction techniques.

Many features are incorporated for increased safety, durability, ruggedness and reliability. All the features you need, including potential elements, current elements and make-before-break short-circuiting elements for current transformer circuits and test jacks, are available in test switches ranging from 1 to 52 poles on one base, and in a miniature size.

Each switch blade can be operated independently or, where required, adjacent handles can be ganged for simultaneous operation.

All Type MTS Test Switches are available in both front- and back-connected styles. Protective covers (available up to 30 poles in clear or opaque) are automatically included with all back-connected styles and may be ordered as an optional item with front-connected switches.

Underwriters Laboratories Inc., recognizes STATES Type MTS Miniature Test Switches under its component program, File No. E75355, with a rating of 600 volts, 30 amperes.

MTS & JTS Miniature Test Switches

FEATURES AND BENEFITS

- **Self-extinguishing materials:** All non-metallic components are made of self-extinguishing, flame-retardant materials with Underwriters Laboratories' best rating for self-extinguishing materials (V-O).
- **Nonferrous material:** All current-carrying metallic components, including hardware, are made of highest quality nonferrous materials such as copper, bronze, brass or phosphor bronze. This ensures excellent conductivity and minimizes galvanic action between dissimilar metals.
- **Nickel plating:** All current-carrying metallic components, including hardware, have a corrosion-resistant nickel finish that ensures good electrical contact and smooth operation of moving parts even after years of inactivity.
- **Safety-grip handle:** A molded handle covers the terminal and includes a lower lip that projects over the metal parts of the switch, thus protecting the operator from contact with live components.
- **One-piece jaw and hinge:** One-piece construction of hinge and jaw eliminates unnecessary, multiple connection points.
- **Special blade shape:** All blades are shaped so that the edge of the blade enters at a right angle to the jaw; thus, the blade enters and exits the full width of the jaw simultaneously.
- **Switch jaws:** All STATES Test Switches have uniform contact pressure over the full width of the blade. The "ping" heard when opening the blade is due to the special, spring-grade phosphor bronze used in the jaw. This design ensures an excellent low-resistant contact that will not overheat.
- **High barriers:** Maximum circuit isolation is obtained by extra-high barriers that provide uncompromised protection. Barriers are permanently mounted and cannot fall out or be knocked out, as in some "snap-in" designs.
- **Short-circuit jaw:** A rugged, make-before-break element is used to short the secondary of a current transformer.
- **Fixed terminal studs:** The screw terminals on which wiring connections are made are a part of a rigid, immovable assembly and cannot be turned or backed out.
- **Test jack:** The test jack eliminates the possibility of opening current transformer secondaries and permits safe, easy measurements to be made in current circuits without disturbing permanent wiring. A dual-circuit test plug, such as the STATES Part No. 15000, inserted into the test jack puts the measuring instrument in series with the current circuit. The test jack does not carry current except when making a test because it is shunted by a standard switch blade that is opened only when the test jack is used.
- **Color-coded handles:** Unless otherwise specified, **potential** elements have **red handles** and **current** elements have **black handles**; however, the following other colors are available at additional cost: blue, orange, white, yellow, green.
- **Identification card holder:** Each safety grip handle is slotted for insertion of an identification card for marking or coding. Cards are available under Part No. MTS28-100 (MTS28 packaged 100 pieces per bag).

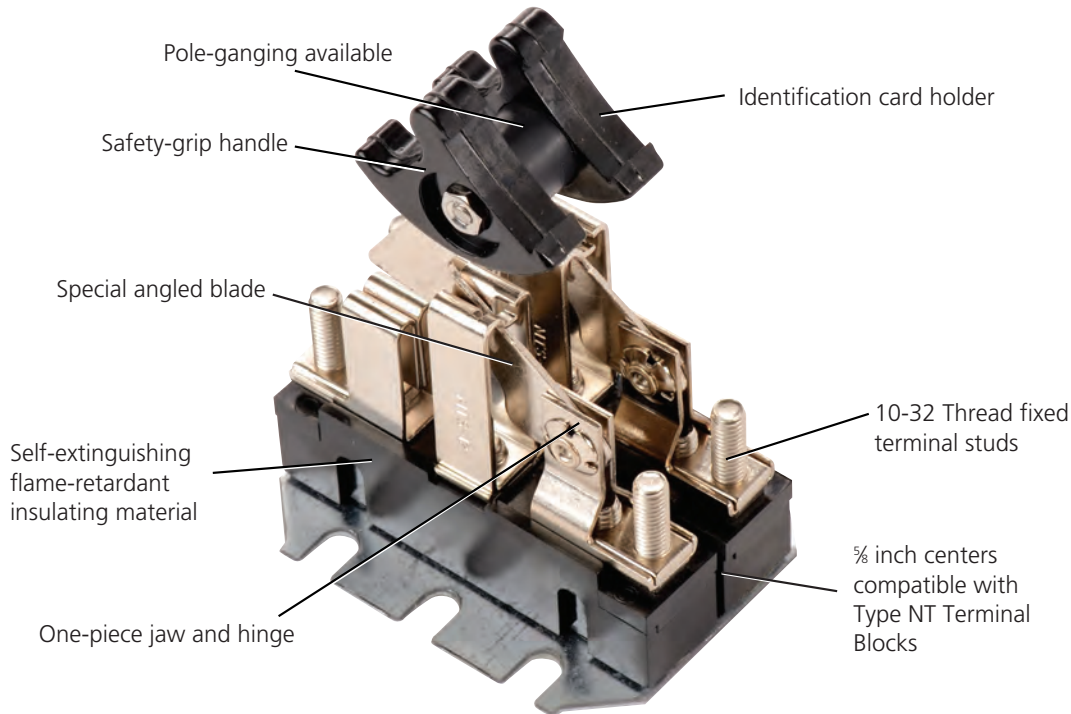

STATES Type MTS Test Switch
Part No. 202-E (ARR: 13) shown

All configurations are available in either a front- or back-connected style.

FRONT-CONNECTED SWITCHES

The front-connected test switch usually is used where wiring entering and leaving the test switch is located on the same side of the panel that the test switch is mounted.

To order front-connected switches, refer to **Ordering Information**.



Front-connected type

BACK-CONNECTED SWITCHES

All switches can be provided in a back-connected version so that the switch is mounted on one side of a panel and the wiring connections are made on the opposite side.

Back-connected switches have factory-installed insulated barriers that project from the rear of the switch. They include either clear or opaque covers, up to 30 poles.

To order back-connected switches, refer to **Ordering Information**.



Bottom view of Back-connected switch

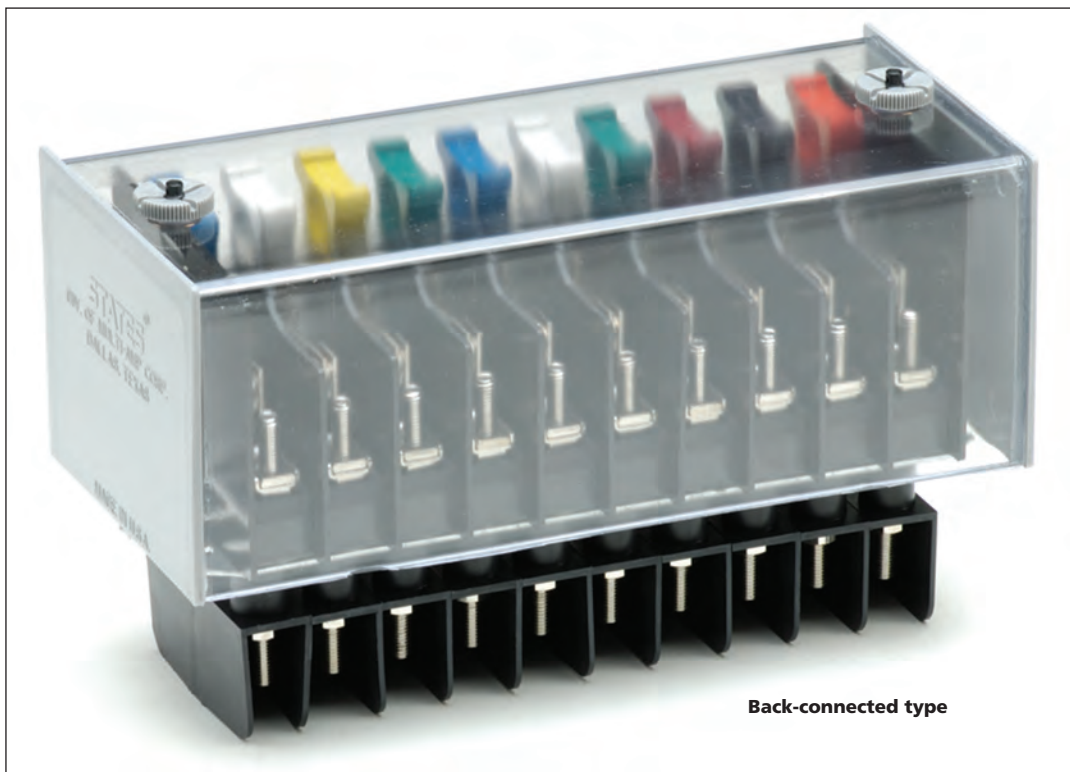

Back-connected type

MTS & JTS Miniature Test Switches

COVERS

STATES Type MTS Test Switches feature rugged, virtually unbreakable covers available in clear or opaque styles. These covers are manufactured from tough, self-extinguishing, flame-retardant polycarbonate. The covers are constructed so that

all switch blades must be closed when the cover is properly sealed. Switches provided with covers include two insulated studs that have holes for wire seals. To add a cover, refer to **ORDERING INFORMATION**.

COVERS FOR FRONT-CONNECTED SWITCHES

Covers for front-connected switches are open or slotted at the bottom of each side to permit wiring to enter and exit between the cover and the panel.

COVERS FOR BACK-CONNECTED SWITCHES

A cover is automatically included with a back-connected test switch. However, you must select either a clear or opaque style.



Slotted, front-connected clear cover

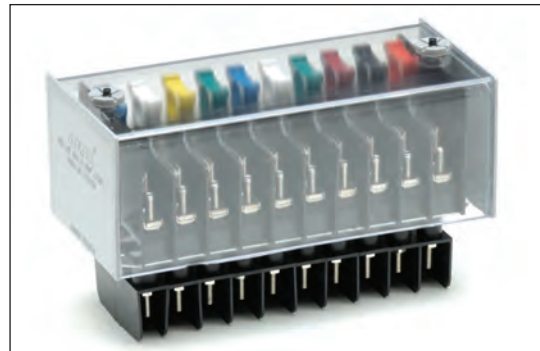

Nonslotted, back-connected clear cover – The nonslotted covers for back-connected switches fit flush with the panel because all wiring exits at the rear of the test switch

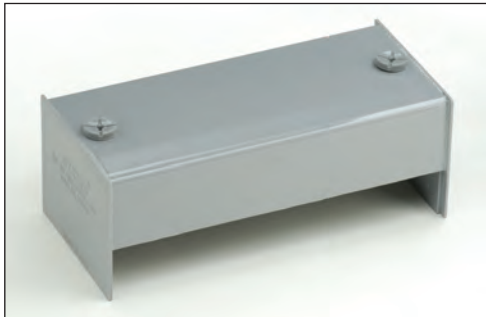

Front-connected opaque (C1) cover



Back-connected opaque (C2) cover



Front-connected clear (C3) cover



Back-connected clear (C4) cover

Covers, up to 30 poles, must be specified at order placement as cover studs are factory installed and cannot be added after shipment.

SPECIFICATIONS

MTS TECHNICAL SPECIFICATIONS		
Class	Front Connected	Back Connected
Brief Description	Metering Test Switch with Stud Terminals	Metering Test Switch with Stud Terminals
Typical Applications	Metering Sub-Station Monitoring Relay Panels	Metering Sub-Station Monitoring Relay Panels
Number of Poles Available	1 - 52 Poles	1 - 52 Poles
Certifications	UL, cUL UL File E75355	UL, cUL UL File E75355
Voltage Rating	600VAC	600VAC
Current Rating	30A	30A
Recommended Wire Size Range	Min 14awg / Max 10awg	Min 14awg / Max 10awg
Recommended Wire Lug Size	#10	#10
Stud Thread	10-32	10-32
Recommended Torque for Stud Wiring Connections	Max 25in/lbs	Max 25in/lbs
#25A - Fuse Clip Dimensions - 250 VAC 30 AMP *Fuse not included	1/4" Diameter 1 1/4" Length	1/4" Diameter 1 1/4" Length
#25 Fuse Clip Dimensions - 600 VAC 30 AMP *Fuse not included	13/32" Diameter 1 1/2" Length	13/32" Diameter 1 1/2" Length
Ambient Temperature	104° F (40° C)	104° F (40° C)

MTS & JTS
Test Switches

Understanding MTS Part Numbers				
1	2	3	4	5
Covers (Optional)	Front-Connected Part Number	Number of Poles	Arrangement Designator	Back-Connected
FRONT-CONNECTED C1 - Slotted, Opaque C3 - Slotted, Clear BACK-CONNECTED C2 - Solid, Opaque C4 - Solid, Clear NOTE: Covers can ONLY be installed by the factory	2	01 - 52	This is the letter and/or number designation that has been assigned for a particular arrangement See catalog page 81, or visit our website at www.statesproducts.com for arrangement options	Add a -B for back-connection Back-connected switches automatically come with a cover. Please specify either C2 = nonslotted, opaque or C4 = nonslotted, clear NOTE: Covers are available up to 30 poles. *Back-connection is available on higher poles if desired
*Switches excluding one of the cover designations above will be supplied front-connected without a cover				

EXAMPLES

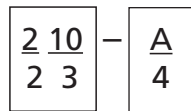

Part No. 210-A
Front-connected 10 pole test switch, no cover.

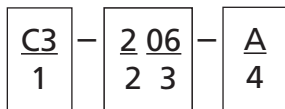

Part No. C3-206-A
Front-connected 6 pole test switch, with a clear slotted front-connected cover.

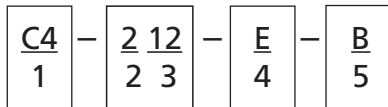



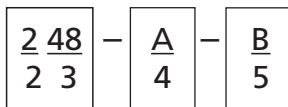







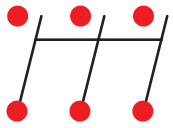

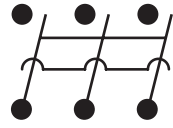

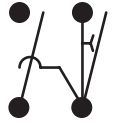
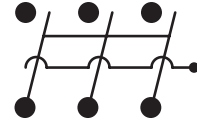

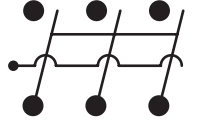
Part No. C4-212-E-B
Back-connected 12 pole test switch, with a clear solid back-connected cover.



Part No. 248-A-B
Back-connected 48 pole test switch, no cover.

MTS SWITCH ELEMENTS

<p>1</p>  <p>Single-Pole Potential</p>	<p>2</p>  <p>Ganged Double-Pole Potential</p>	<p>16</p>  <p>Ganged Three-Pole Potential</p>
<p>13</p>  <p>Ganged Two-Pole Short-Circuiting Current Assembly</p>	<p>17</p>  <p>Ganged Three-Pole Short-Circuiting Current Assembly</p>	<p>9</p>  <p>Current Test Jack</p>
<p>6</p>  <p>Short-Circuiting Assembly With Right-Hand Common Bar</p>	<p>10</p>  <p>Right-Hand Current Assembly Consists of Test Jack and Short-Circuiting Current Assemblies</p>	<p>20</p>  <p>Ganged Three-Pole Short-Circuiting Current Assembly, Right Extension</p>
<p>5</p>  <p>Short-Circuiting Assembly With Left-Hand Common Bar</p>	<p>11</p>  <p>Left-Hand Current Assembly Consists of Test Jack and Short-Circuiting Current Assemblies</p>	<p>19</p>  <p>Ganged Three-Pole Short-Circuiting Current Assembly, Left Extension</p>
<p>90</p>  <p>Right-Hand Short-Circuiting Assembly Ending at a Terminal</p>	<p>91</p>  <p>Left-Hand Short-Circuiting Assembly Ending at a Terminal</p>	<p>24</p>  <p>Through Bar</p>
<p>25</p>  <p>600-Volt Fuse Holder</p>	<p>25A</p>  <p>250-Volt Fuse Holder</p>	<p>26</p>  <p>Blank Space</p>
<p>7</p>  <p>Current Test Jack With Left-Hand Common Bar</p>	<p>8</p>  <p>Current Test Jack With Right-Hand Common Bar</p>	

NOTES:

- Barriers are provided between poles of opposite polarity.
- Potential** handles are **red** and **current** handles are **black** unless otherwise specified.
- Specify adjacent handles to be ganged (yoked) if desired.
- Arrange elements left to right, front view.
- Element No. 25A accepts standard cartridge fuses rated 250 VAC 30 AMP. **Fuse not included.** Fuse dimensions must be 1/4" diameter and 1 1/4" in length.
- Element No. 25 accepts standard cartridge fuses rated 600 VAC 30 AMP. **Fuse not included.** Fuse dimensions must be 9/32" diameter and 1 1/2" in length.

Color Key: k: Black b: Blue g: Green e: Orange r: Red w: White y: Yellow

ORDERING INFORMATION

The part numbers under the arrangements beginning on page 81 are for front-connected switches without covers. These same numbers are also used as the basis for ordering back-connected.

The part numbers are three digits followed by a letter or letter and number combination.

Example: 203-A

1/1/1

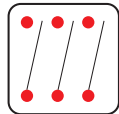

The slashes "/" in the arrangements represent barriers that are installed standard between any adjoining elements of opposite polarity.

203-A

SPECIAL ORDERS

Special Arrangements: These can be made of any combination of potential or current elements, with a maximum of 52 poles. For more information, refer to the following example and illustrations on page 75.

To order a customized, 10-pole, back-connected switch with a clear, back-connected cover, specify:

Switch Type: STATES Type MTS
No. of poles: 10-pole test switch
***Arrangement:** 10/2/11/1/16
Style: Back-connected
Cover: Clear, back-connected

Handle Colors: The standard colors for handles are **red** for **potential** and **black** for **current**. Handles are also available in other colors.

***Arrangements should be given as front view of switch, left to right, using the elements listed on page 72.**

To specify non-standard colors, add to the element number the appropriate color code:

Color	Color Code	Color	Color Code
Black	k	Red	r
Blue	b	White	w
Green	g	Yellow	y
Orange	e		

To order a switch with handles in non-standard colors, you must specify the arrangement with colors indicated. For example, to order a 10-pole switch with special handle colors, specify: **Arrangement:** 10/10r/10g/10w/1k/1k

Ganged handles: You may specify a yoking bar to gang adjacent handles. For example, to order a switch with the adjacent potentials ganged, you must specify: **Gang all potentials**

Ganged handles are represented with the number (#) sign.

Example: #1/1/1/1# (all handles in between the "#" are ganged together)

Hinge position: The "U" in an arrangement (next to an element) indicates the hinge is positioned upside down from the typical arrangement.

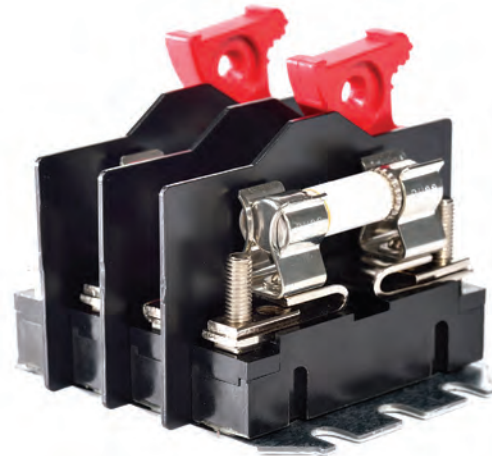

MTS shown with fuse holder (Fuse not included)

OPTIONAL ACCESSORIES



Socket Wrench and Insert

To speed installation of the terminal nuts on States Test Switches, the socket wrench (Part No. 16028) and 3/8 inch insert (Part No. 16027) are available. Pictures available in the Testing Accessories section on page 134.

Also available are the 5/16 inch insert (Part No. 16025) for use in installing the terminal nuts on STATES Type Terminal Blocks and States Type MTS Test Switches.

The screwdriver attachment (Part No. 16022) makes this wrench your complete meter installation tool.

Dual Circuit Plug

By inserting the STATES Dual Circuit Plug (Part No. 15000) into the test jack, safe measurement can be made of current transformer secondary current.



STATES recommends the use of Part No. 15000 on all of its' test switches.

Use of any other manufacturer's plug could damage the switch and may void the warranty.

Jumper Strips

Part No. TBT168

(The TBT168, which is 3ft long, can be cut to the required length by the user)

This nickel-plated jumper strip is made specially for the STATES Type NT & ZWM Terminal Blocks and the STATES Type MTS Test Switches.



See Testing Accessories on page 128.

JTS TEST SWITCHES

STATES' new JTS Test Switch is similar to the MTS platform when it comes to flexibility of pole arrangements, elements available and types of connections. It also provides a new safe and efficient approach to field measuring and testing for commercial and industrial metering applications.

By allowing the technician to connect directly to the block, it eliminates false readings and the possibility of personnel accidents from a loose connection due to over-used and worn out tools. This makes it safer for technicians and improves their efficiency when performing their routine tests.

The base for these units comes numbered for ease of circuit identification in order to avoid connection mistakes.

These can be ordered with; Safety Banana Jack barrel connectors, Standard Banana Jack connectors and Round head pan screws.

Safe, easy, fast to short the connection.

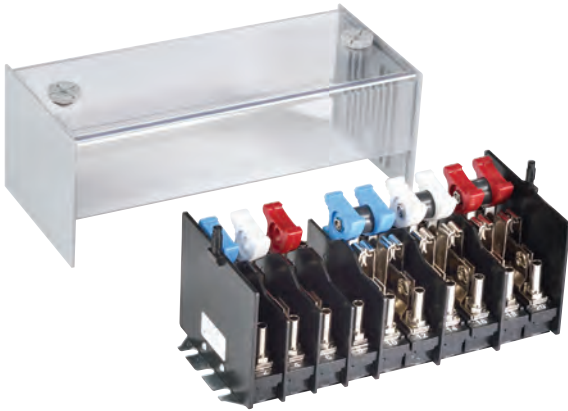

JTS 10 Pole Switch with safety jacks and clear cover

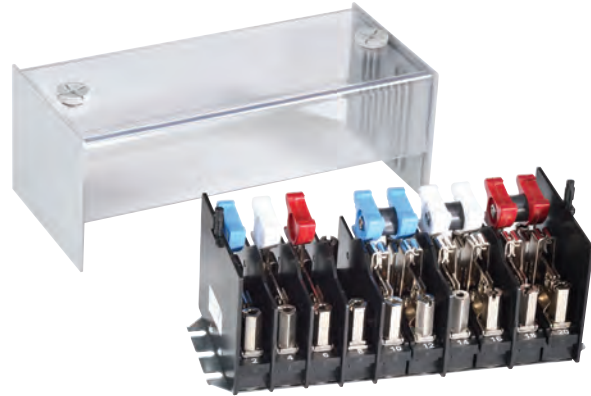

JTS 10 Pole Switch with hex jacks and clear cover



JTS 10 Pole Switch with plain screws and clear cover

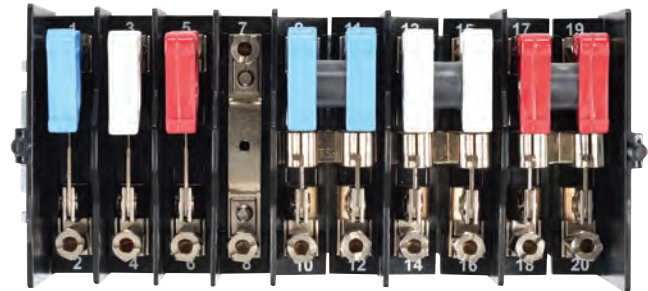

Front view of hex jack switch



JTS shown with test leads attached

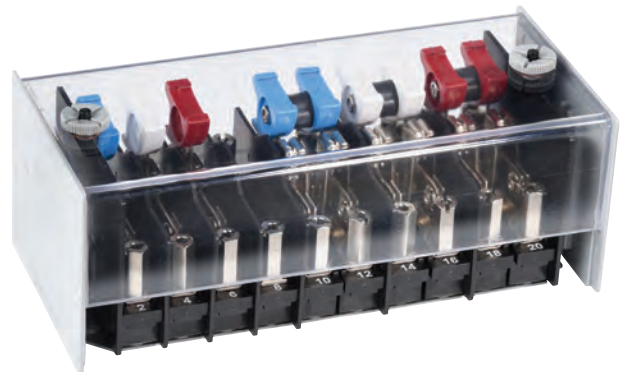

JTS shown with clear cover

SPECIFICATIONS

JTS TECHNICAL SPECIFICATIONS			
Class	Safety Jack Test Switch	Hex Jack Test Switch	Plain Screw Test Switch
Brief Description	Front Connected or Back Connected Semi-Flush Mounted Test Switch with Safety Banana Jack Bolt	Front Connected or Back Connected Semi-Flush Mounted Test Switch with Hex Banana Jack Bolt	Front Connected or Back Connected Semi-Flush Mounted Test Switch with Plain Screw
Typical Applications	Metering Sub-Station Monitoring Relay Panels	Metering Sub-Station Monitoring Relay Panels	Metering Sub-Station Monitoring Relay Panels
Number of Poles Available	1 - 52 Poles	1 - 52 Poles	1 - 52 Poles
Certifications	UL, cUL UL File E75355	UL, cUL UL File E75355	UL, cUL UL File E75355
Voltage Rating	600VAC / 300VDC	600VAC / 300VDC	600VAC / 300VDC
Current Rating	30A	30A	30A
Recommended Wire Size Range	Min 14awg / Max 10awg	Min 14awg / Max 10awg	Min 14awg / Max 10awg
Recommended Wire Lug Size	#10	#10	#10
Recommended Torque for Stud Wiring Connections	Max 25in/lbs	Max 25in/lbs	Max 25in/lbs
#25A - Fuse Clip Dimensions - 250 VAC 30 AMP *Fuse not included	1/4" Diameter 1 1/4" Length	1/4" Diameter 1 1/4" Length	1/4" Diameter 1 1/4" Length
#25 - Fuse Clip Dimensions - 600 VAC 30 AMP *Fuse not included	13/32" Diameter 1 1/2" Length	13/32" Diameter 1 1/2" Length	13/32" Diameter 1 1/2" Length
Ambient Temperature	104° F (40° C)	104° F (40° C)	104° F (40° C)

MTS & JTS
Test Switches

Understanding JTS Part Numbers					
1	2	3	4	5	6
Covers (Optional)	Front-Connected Part Number	Number of Poles	Arrangement Designator	Back-Connected	Optional (Special Printing)
FRONT-CONNECTED C1 - Slotted, Opaque C3 - Slotted, Clear BACK-CONNECTED C2 - Solid, Opaque C4 - Solid, Clear NOTE: Covers can ONLY be installed by the factory	S (Safety) H (Hex) P (Plain Screw) NOTE: Replace the "2" in any MTS part number with the desired option above	01 - 52	This is the letter and/or number designation that has been assigned for a particular arrangement See catalog page 81, or visit our website at www.statesproducts.com for arrangement options	Add a -B for back-connection Back-connected switches automatically come with a cover. Please specify either C2 = nonslotted, opaque or C4 = nonslotted, clear NOTE: Covers are available up to 30 poles. *Back-connection is available on higher poles if desired	-SP = for Special Printing This designation to be used when ordering custom printing. The JTS version is supplied with standard numbering 1 - xx (however many poles ordered) Example: S10-A will have standard numbering 1 - 20
*Switches excluding one of the cover designations above will be supplied front-connected without a cover					

EXAMPLES

H	10	-	A
2	3		4

Part No. H10-A

Front-connected 10 pole test switch, no cover, hex head connection.

C3	S	06	-	A
1	2	3		4

Part No. C3-S06-A

Front-connected 6 pole test switch, with a clear slotted front-connected cover, safety jack connection.

C4	P	12	-	E	-	B
1	2	3		4		5

Part No. C4-P12-E-B

Back-connected 12 pole test switch, with a clear solid back-connected cover, plain screw connection.

Typical Wiring Diagram

MTS & JTS
Test Switches

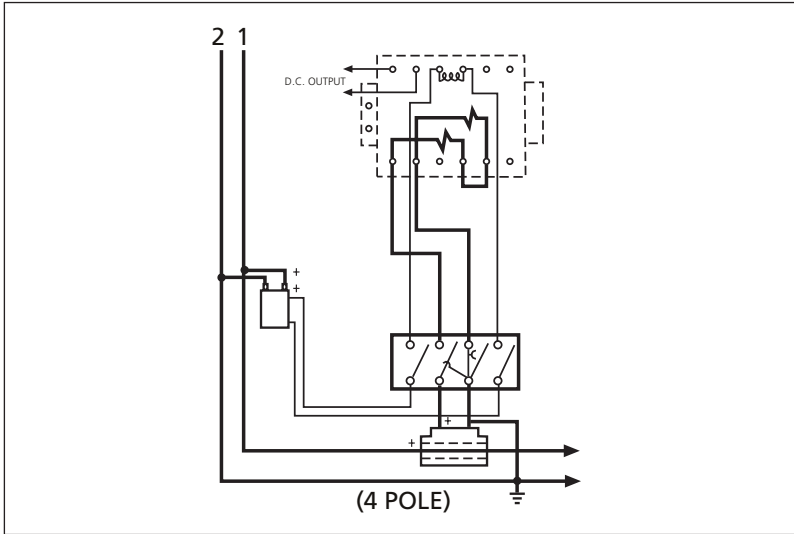

1 ϕ Watt Transducer



4-Pole Test Switch - Part No. 204-N (ARR: 1/10/1)

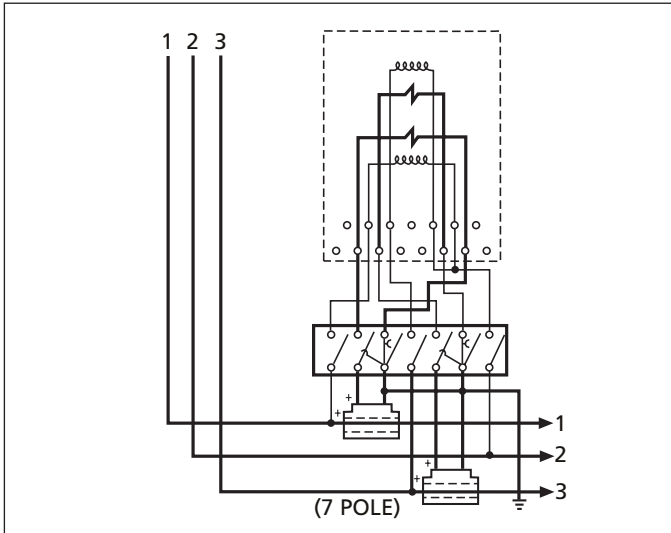

3 ϕ Watthour Meter



7-Pole Test Switch - Part No. 207-K (ARR: 1/10/1/10/1)

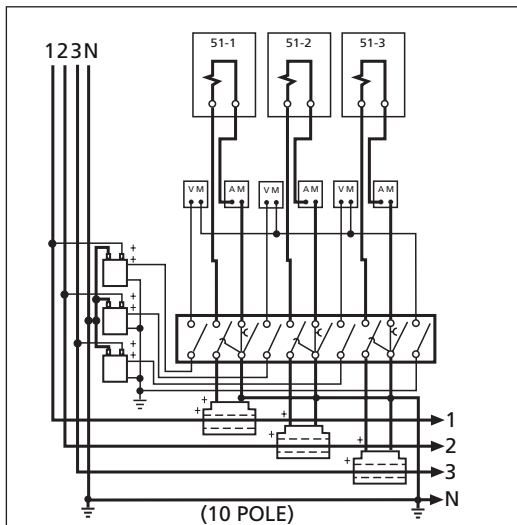

Overcurrent Relays



10-Pole Test Switch - Part No. 210-E (ARR: 1/10/1/10/1/10/1)

DIMENSIONS IN INCHES [MM]

STATES Type MTS & JTS Back-Connected Switches

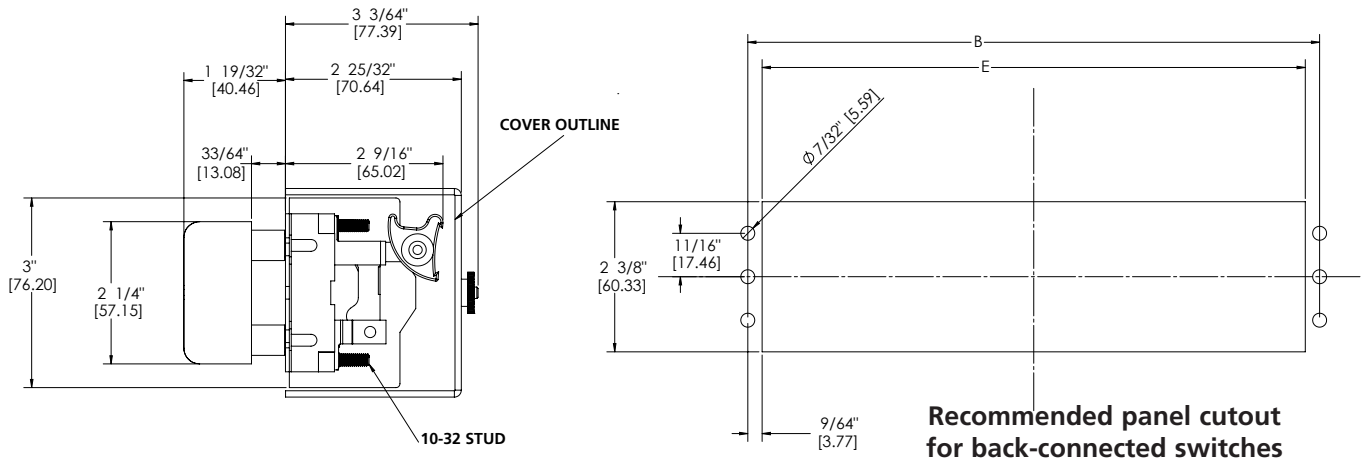

**MTS & JTS
Test Switches**

STATES Type MTS & JTS Front-Connected Switches

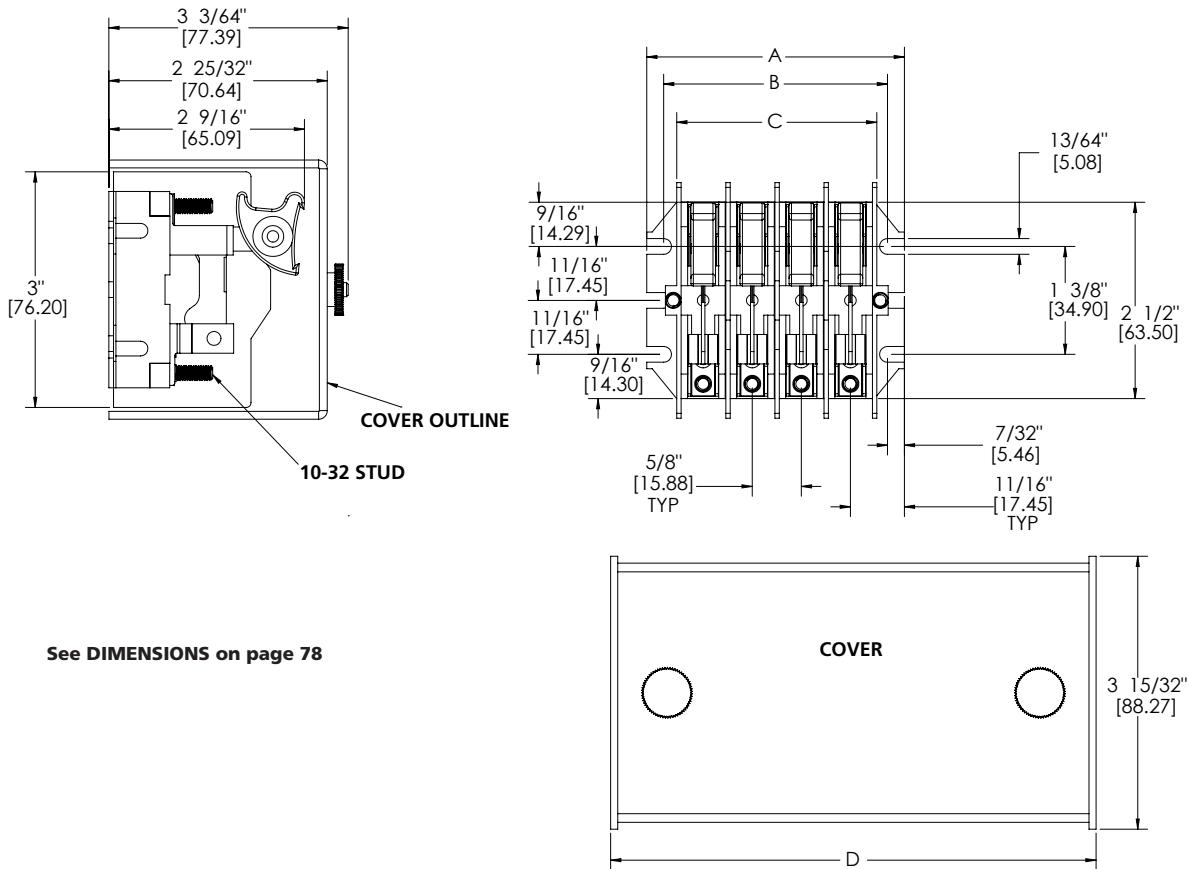

See DIMENSIONS on page 78

Covers are OPTIONAL on front-connected switches and come standard on back-connected switches. Please specify which cover type, clear or opaque, you require when ordering a back-connected switch. Please refer to page 70 for cover information.

MTS & JTS Miniature Test Switches

DIMENSIONS

NO. OF POLES	A			B			C			D			E		
	FRACTIONS	DECIMAL	MM	FRACTIONS	DECIMAL	MM	FRACTIONS	DECIMAL	MM	FRACTIONS	DECIMAL	MM	FRACTIONS	DECIMAL	MM
1	1 3/8	1.38	34.93	31/32	0.97	24.61	35/64	0.55	13.89	1 13/16	1.81	46.04	43/64	0.67	17.07
2	2	2.00	50.80	1 19/32	1.59	40.48	1 11/64	1.17	29.77	2 1/2	2.50	63.50	1 19/64	1.30	32.94
3	2 5/8	2.63	66.68	2 7/32	2.22	56.36	1 51/64	1.80	45.64	3 1/8	3.13	79.38	1 59/64	1.92	48.82
4	3 1/4	3.25	82.55	2 27/32	2.84	72.23	2 27/64	2.42	61.52	3 3/4	3.75	95.25	2 35/64	2.55	64.69
5	3 7/8	3.88	98.43	3 15/32	3.47	88.11	3 3/64	3.05	77.39	4 3/8	4.38	111.13	3 11/64	3.17	80.57
6	4 1/2	4.50	114.30	4 3/32	4.09	103.98	3 43/64	3.67	93.27	5	5.00	127.00	3 51/64	3.80	96.44
7	5 1/8	5.13	130.18	4 23/32	4.72	119.86	4 19/64	4.30	109.14	5 5/8	5.63	142.88	4 27/64	4.42	112.32
8	5 3/4	5.75	146.05	5 11/32	5.34	135.73	4 59/64	4.92	125.02	6 1/4	6.25	158.75	5 3/64	5.05	128.19
9	6 3/8	6.38	161.93	5 31/32	5.97	151.61	5 35/64	5.55	140.89	6 7/8	6.88	174.63	5 43/64	5.67	144.07
10	7	7.00	177.80	6 19/32	6.59	167.48	6 11/64	6.17	156.77	7 1/2	7.50	190.50	6 19/64	6.30	159.94
11	7 5/8	7.63	193.68	7 7/32	7.22	183.36	6 51/64	6.80	172.64	8 1/8	8.13	206.38	6 59/64	6.92	175.82
12	8 1/4	8.25	209.55	7 27/32	7.84	199.23	7 27/64	7.42	188.52	8 3/4	8.75	222.25	7 35/64	7.55	191.69
13	8 7/8	8.88	225.43	8 15/32	8.47	215.11	8 3/64	8.05	204.39	9 3/8	9.38	238.13	8 11/64	8.17	207.57
14	9 1/2	9.50	241.30	9 3/32	9.09	230.98	8 43/64	8.67	220.27	10	10.00	254.00	8 51/64	8.80	223.44
15	10 1/8	10.13	257.18	9 23/32	9.72	246.86	9 19/64	9.30	236.14	10 5/8	10.63	269.88	9 27/64	9.42	239.32
16	10 3/4	10.75	273.05	10 11/32	10.34	262.73	9 59/64	9.92	252.02	11 1/4	11.25	285.75	10 3/64	10.05	255.19
17	11 3/8	11.38	288.93	10 31/32	10.97	278.61	10 35/64	10.55	267.89	11 7/8	11.88	301.63	10 43/64	10.67	271.07
18	12	12.00	304.80	11 19/32	11.59	294.48	11 11/64	11.17	283.77	12 1/2	12.50	317.50	11 19/64	11.30	286.94
19	12 5/8	12.63	320.68	12 7/32	12.22	310.36	11 51/64	11.80	299.64	13 1/8	13.13	333.38	11 59/64	11.92	302.82
20	13 1/4	13.25	336.55	12 27/32	12.84	326.23	12 27/64	12.42	315.52	13 3/4	13.75	349.25	12 35/64	12.55	318.69
21	13 7/8	13.88	352.43	13 15/32	13.47	342.11	13 3/64	13.05	331.39	14 3/8	14.38	365.13	13 11/64	13.17	334.57
22	14 1/2	14.50	368.30	14 3/32	14.09	357.98	13 43/64	13.67	347.27	15	15.00	381.00	13 51/64	13.80	350.44
23	15 1/8	15.13	384.18	14 23/32	14.72	373.86	14 19/64	14.30	363.14	15 5/8	15.63	396.88	14 27/64	14.42	366.32
24	15 3/4	15.75	400.05	15 11/32	15.34	389.73	14 59/64	14.92	379.02	16 1/4	16.25	412.75	15 3/64	15.05	382.19
25	16 3/8	16.38	415.93	15 31/32	15.97	405.61	15 35/64	15.55	394.89	16 7/8	16.88	428.63	15 43/64	15.67	398.07
26	17	17.00	431.80	16 19/32	16.59	421.48	16 11/64	16.17	410.77	17 1/2	17.50	444.50			
27	17 5/8	17.63	447.68	17 7/32	17.22	437.36	16 51/64	16.80	426.64	18 1/8	18.13	460.38			
28	18 1/4	18.25	463.55	17 27/32	17.84	453.23	17 27/64	17.42	442.52	18 3/4	18.75	476.25			
29	18 7/8	18.88	479.43	18 15/32	18.47	469.11	18 3/64	18.05	458.39	19 3/8	19.38	492.13			
30	19 1/2	19.50	495.30	19 3/32	19.09	484.98	18 43/64	18.67	474.27	20	20.00	508.00			
31	20 1/8	20.13	511.18	19 23/32	19.72	500.86	19 19/64	19.30	490.14						
32	20 3/4	20.75	527.05	20 11/32	20.34	516.73	19 59/64	19.92	506.02						
33	21 3/8	21.38	542.93	20 31/32	20.97	532.61	20 35/64	20.55	521.89						
34	22	22.00	558.80	21 19/32	21.59	548.48	21 11/64	21.17	537.77						
35	22 5/8	22.63	574.68	22 7/32	22.22	564.36	21 51/64	21.80	553.64						
36	23 1/4	23.25	590.55	22 27/32	22.84	580.23	22 27/64	22.42	569.52						
37	23 7/8	23.88	606.43	23 15/32	23.47	596.11	23 3/64	23.05	585.39						
38	24 1/2	24.50	622.30	24 3/32	24.09	611.98	23 43/64	23.67	601.27						
39	25 1/8	25.13	638.18	24 23/32	24.72	627.86	24 19/64	24.30	617.14						
40	25 3/4	25.75	654.05	25 11/32	25.34	643.73	24 59/64	24.92	633.02						
41	26 3/8	26.38	669.93	25 31/32	25.97	659.61	25 35/64	25.55	648.89						
42	27	27.00	685.80	26 19/32	26.59	675.48	26 11/64	26.17	664.77						
43	27 5/8	27.63	701.68	27 7/32	27.22	691.36	26 51/64	26.80	680.64						
44	28 1/4	28.25	717.55	27 27/32	27.84	707.23	27 27/64	27.42	696.52						
45	28 7/8	28.88	733.43	28 15/32	28.47	723.11	28 3/64	28.05	712.39						
46	29 1/2	29.50	749.30	29 3/32	29.09	738.98	28 43/64	28.67	728.27						
47	30 1/8	30.13	765.18	29 23/32	29.72	754.86	29 19/64	29.30	744.14						
48	30 3/4	30.75	781.05	30 11/32	30.34	770.73	29 59/64	29.92	760.02						
49	31 3/8	31.38	796.93	30 31/32	30.97	786.61	30 35/64	30.55	775.89						
50	32	32.00	812.80	31 19/32	31.59	802.48	31 11/64	31.17	791.77						
51	32 5/8	32.63	828.68	32 7/32	32.22	818.36	31 51/64	31.80	807.64						
52	33 1/4	33.25	844.55	32 27/32	32.84	834.23	32 27/64	32.42	823.52						
53	33 7/8	33.88	860.43	33 15/32	33.47	850.11	33 3/64	33.05	839.39						
54	34 1/2	34.50	876.30	34 3/32	34.09	865.98	33 43/64	33.67	855.27						
55	35 1/8	35.13	892.18	34 23/32	34.72	881.86	34 19/64	34.30	871.14						
56	35 3/4	35.75	908.05	35 11/32	35.34	897.73	34 59/64	34.92	887.02						
57	36 3/8	36.38	923.93	35 31/32	35.97	913.61	35 35/64	35.55	902.89						
58	37	37.00	939.80	36 19/32	36.59	929.48	36 11/64	36.17	918.77						

MTS & JTS Test Switches

DIMENSIONS

NO. OF POLES	A			B			C		
	FRACTIONS	DECIMAL	MM	FRACTIONS	DECIMAL	MM	FRACTIONS	DECIMAL	MM
59	37 5/8	37.63	955.68	37 7/32	37.22	945.36	36 51/64	36.80	934.64
60	38 1/4	38.25	971.55	37 27/32	37.84	961.23	37 27/64	37.42	950.52
61	38 7/8	38.88	987.43	38 15/32	38.47	977.11	38 3/64	38.05	966.39
62	39 1/2	39.50	1003.30	39 3/32	39.09	992.98	38 43/64	38.67	982.27
63	40 1/8	40.13	1019.18	39 23/32	39.72	1008.86	39 19/64	39.30	998.14
64	40 3/4	40.75	1035.05	40 11/32	40.34	1024.73	39 59/64	39.92	1014.02
65	41 3/8	41.38	1050.93	40 31/32	40.97	1040.61	40 35/64	40.55	1029.89
66	42	42.00	1066.80	41 19/32	41.59	1056.48	41 11/64	41.17	1045.77
67	42 5/8	42.63	1082.68	42 7/32	42.22	1072.36	41 51/64	41.80	1061.64
68	43 1/4	43.25	1098.55	42 27/32	42.84	1088.23	42 27/64	42.42	1077.52
69	43 7/8	43.88	1114.43	43 15/32	43.47	1104.11	43 3/64	43.05	1093.39
70	44 1/2	44.50	1130.30	44 3/32	44.09	1119.98	43 43/64	43.67	1109.27
71	45 1/8	45.13	1146.18	44 23/32	44.72	1135.86	44 19/64	44.30	1125.14
72	45 3/4	45.75	1162.05	45 11/32	45.34	1151.73	44 59/64	44.92	1141.02
73	46 3/8	46.38	1177.93	45 31/32	45.97	1167.61	45 35/64	45.55	1156.89

"C" dim is outside edge of block

To provide extra mounting support, at 26 poles one blank space is added and at 51 poles, two blank spaces are added.
 If you order part number 248-A-B, which is a 48 pole test switch, you will need to use the mounting dimension for the 49 pole strip.
 If you order part number 252-A, which is a 52 pole test switch, you will need to use the mounting dimension for the 54 pole strip.

MTS & JTS Miniature Test Switches

MTS & JTS ACCESSORIES

PART NUMBER	DESCRIPTION
MTS28-100	White Marker Handle Tags (100pcs per bag)
MTS20-xx	Handle Ganging Kit - Replace the "xx" with the required number of adjacent poles to be ganged together (example: MTS20-2 - 2 Pole Kit)
XNT126-100	Hex Nut 10-32 x 5/16 W x 7/64 Thick, Brass Nickel Plate (100pcs per bag)
MTS Covers are available from 1 - 30 Poles Only - Replace the "xx" below with the required number of poles to cover	
MTC1-xx	C1 - Front Connected Opaque Cover - includes cover cut to size and cover knobs
MTC2-xx	C2 - Back Connected Opaque Cover - includes cover cut to size and cover knobs
MTC3-xx	C3 - Front Connected Clear Cover - includes cover cut to size and cover knobs
MTC4-xx	C4 - Back Connected Clear Cover - includes cover cut to size and cover knobs

***NOTE:** MTS covers cannot be added to switches that were not originally purchased with a cover.

JTS Accessories



2005-286
Banana Jack Hex w/Slot



2005-287
Safety Banana Jack Receptacle



3704-JTS
Panhead Phillips Screw

2005-286-20	10-32 Male Banana Jack Hex w/Slot, Brass Nickel Plated (20pcs per bag)
2005-287-20	10-32 Male Safety Banana Jack Receptacle, Brass, Nickel Plated (20pcs per bag)
3704-JTS-20	10-32 x 5/16 Screw, Panhead Phillips, Stainless Steel (20pcs per bag)

Mounting bars are available from 1 to 73 poles, call the sales office, 1-800-325-4574, for part numbers.
Please refer to our website for accessory pictures.

**FRONT VIEW
1-POLE**



201-A

Color Options:

- 1k**
201-C
- 1y**
201-D



201-B

**2-POLE
1/1**



202-A

Color Options:

- 1k/1k**
202-H
- 1y/1y**
202-D



202-B

2k
202-J



202-C



202-F

Color Option:

- 11r**
202-L



202-E

Other 2-Pole
Standard Arrangement:

6-24
202-G

3-POLE

1/1/1



203-A

16



203-D

1/10



203-B

10/1



203-C

13/1



203-H

1/13



203-J

17



203-E

Other 3-Pole
Standard Arrangements:

6-6-5
203-K

6-6-24
203-L

9/9/9
203-F

9/24-5
203-G

4-POLE

1/1/1/1



204-A

2/2



204-D

Color Option:

- 2k/2k**
204-A2

1/1/1/1

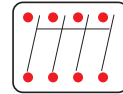

204-E

1/1/10

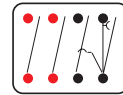

204-F

1/1/11



204-J

10/1/1

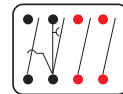

204-K

10/2

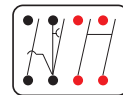

204-G

1/10/1

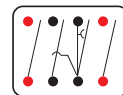

204-N

11/10

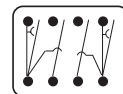

204-Q

4-POLE (CONT.)

1/1/13

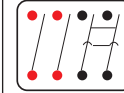

204-B

1/13/1

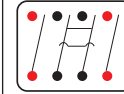

204-L

13/1/1

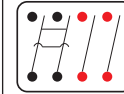

204-M

13/13

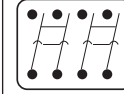

204-H

20-24

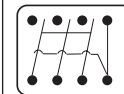

204-C

Other 4-Pole
Standard Arrangements:

1/10/24
204-A3

1/16
204-A5

9/9/9/9
204-R

9/24-14
204-S

11/11
204-W

11b/11e
204-Z

20-9
204-A4

20r-24
204-U

24-19r
204-T

FRONT VIEW

5-POLE

1/1/1/1/1

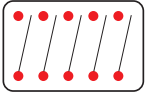

205-A

1/1/16

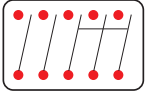

205-H

1/1/1/10

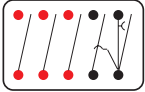

205-B

1/1/10/1



205-C

1/10/1/1



205-D

10/1/10

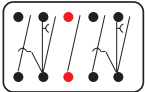

205-F

11/1/10

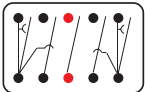

205-G

9/9/9/9/24

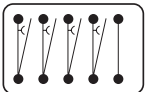

205-J

1/1/1/13

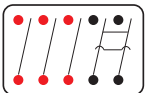

205-E

6-POLE

1/1/1/1/1/1

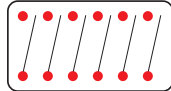

206-A

2/2/2

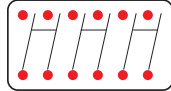

206-D

16/16

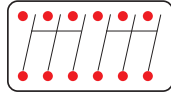

206-E

1/1/1/10/1

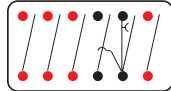

206-F

1/10/10/1

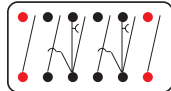

206-G

1/1/10/10

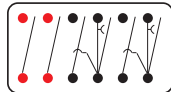

206-J

11/11/11

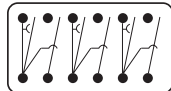

206-K

10/10/10

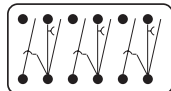

206-C

1/13/13/1

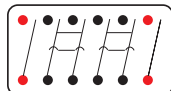

206-H

6-Pole (CONT.)

1/1/13/13

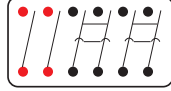

206-S

13/13/13

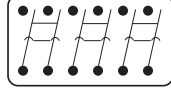

206-B

Other 6-Pole Standard Arrangements:

1/1/1/1/11

206-P

2/2/13

206-L

7-POLE

1/1/1/1/1/1/1

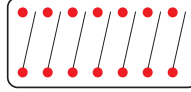

207-A

1/10/1/1/1/1

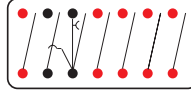

207-G

1/1/10/1/1/1



207-F

1/1/1/1/10/1

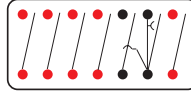

207-H

16/10/10



207-J

7-Pole (CONT.)

1/10/1/10/1

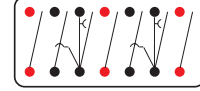

207-K

1/10/1/11/1

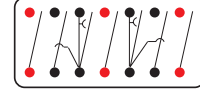

207-B

1/1/1/10/10



207-C

Color Option:

1k/1k/1k/10/10
207-P

1/1/1/10/11



207-E

1/13/1/13/1

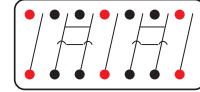

207-D

13/13/13/9

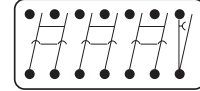

207-L

Other 7-Pole Standard Arrangements:

#1/1/1/1/1/1/1#
207-M

1/1/1/1/11/11
207-Q

1/6-1-6-9-9/1
207-N

6-6-6-6-6-6-24
207-S

9/9/9/24-19
207-R

FRONT VIEW

8-POLE

1/1/1/1/1/1/1/1

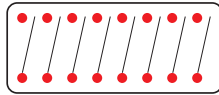

208-D

1/1/1/10/1/1/1/1



208-E

1/10/1/1/11/1

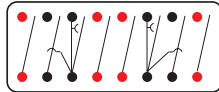

208-A

10/10/1/1/1/1

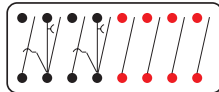

208-B

1/1/1/1/10/10

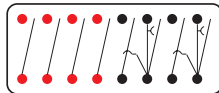

208-G

1/10/10/10/1

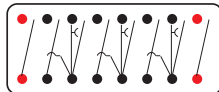

208-K

10/10/10/1/1

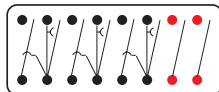

208-L

10/10/10/10

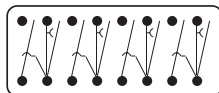

208-P

1/1/1/13/1/1/1

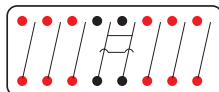

208-Q

8-Pole (CONT.)

1/1/1/1/1/1/1/13

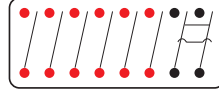

208-C

1/13/1/1/13/1



208-H

1/1/1/1/13/13



208-J

16/24/13/13



208-F

1/13/13/13/1

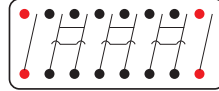

208-M

13/13/13/1/1

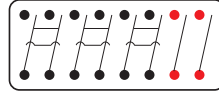

208-N

13/13/13/13

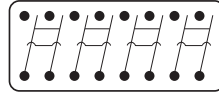

208-W

Other 8-Pole
Standard Arrangements:

#1/1/1/1/1/1/1/1#
208-T

1/6-1-6-9-1-9/1
208-R

2/2/2/2
208-S

9-POLE

1/1/1/1/1/1/1/1/1

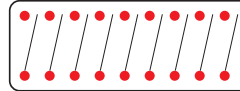

209-A

16/16/16

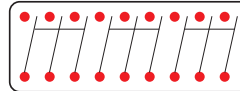

209-B

1/1/1/10/10/10

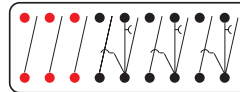

209-U

16/10/10/10

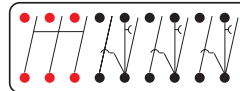

209-E

1/10/1/10/1/10

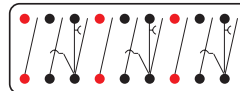

209-K

1/13/1/13/1/13

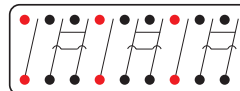

209-H

1/1/1/13/13/13

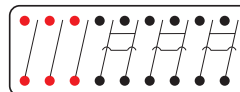

209-D

6-6-6-6-6-6-6-24

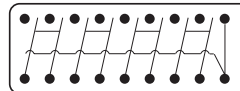

209-C

Other 9-Pole
Standard Arrangements:

1/1/24/10/10/10
209-F

9/9/9/9/9/9/9/1
209-G

11/9/11/9/11/9
209-J

10-POLE

1/1/1/1/1/1/1/1/1/1

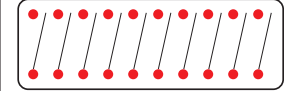

210-A

1/1/1/1/1/1/1/10/1

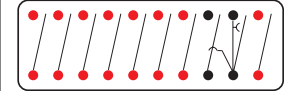

210-B

1/1/1/1/1/10/10/1

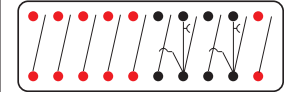

210-C

1/1/1/10/1/1/10/1

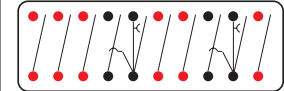

210-D

1/10/1/1/1/1/10/1

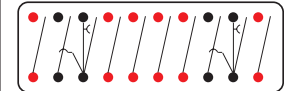

210-F

1/10/1/10/1/10/1

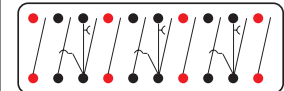

210-E

1/1/1/1/10/10/10

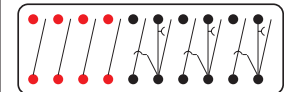

210-H

1/1/1/10/10/10/1

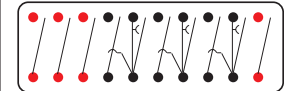

210-J

1/10/10/10/10/1

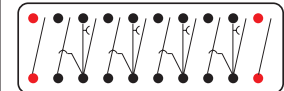

210-K

10/10/10/10/1/1

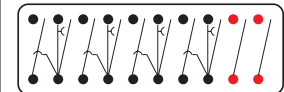

210-L

Color Key: k: Black b: Blue g: Green e: Orange r: Red w: White y: Yellow

FRONT VIEW

10-Pole (CONT.)

10/10/10/10/10

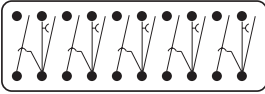

210-M

1/13/1/13/1/13/1

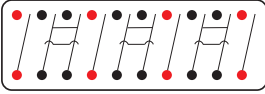

210-G

13/13/13/13/13

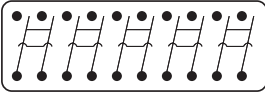

210-N

13/13/13/1/1/1/24

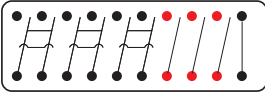

210-P

Other 10-Pole
Standard Arrangements:

1/1/1/24/10/10/10
210-T

1/1/1/24/13/13/13
210-AA

1/10/1/10/1/10/24
210-R

2/2/2/2/2
210-Y

9/9/9/9/9/9/9/9/9/9
210-Q

9/9/9/9/24-5-5-5-5-5
210-V

9/9/9/24#-19-19#
210-U

10/10/10/1/1/1/1
210-W

13/13/13/13/13
210-X

1/1/1/1/9-5-9-5-9-5
210-S

11-POLE

1/1/1/1/1/1/1/1/1/1/1
211-A

10/10/9/10/9/9/2
211-C

13/13/1/1/1/1/1/1/1
211-B

12-POLE

1/1/1/1/1/1/1/1/1/1/1/1

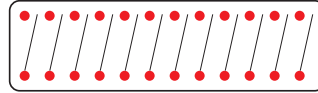

212-A

2/2/2/2/2/2

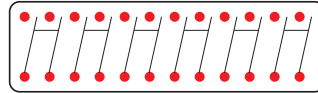

212-B

1/1/1/1/1/1/1/1/1/1/1/1

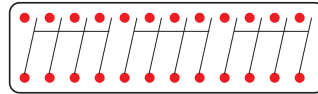

212-C

10/10/10/10/10/10

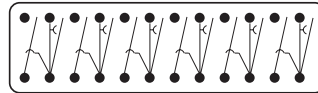

212-D

Other 12-Pole
Standard Arrangements:

1/1/10/1/10/1/10/1/1
212-F

1/10/1/10/1/10/1/10
212-E

9/9/9/9/9/9/9/9/9/16
212-H

13/13/13/13/13/13
212-G

16-POLE

16 - #1 elements

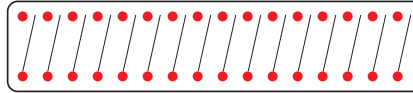

216-A

8 - #2 elements

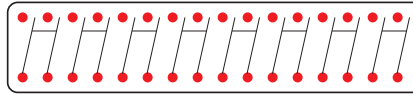

216-B

Other 16-Pole
Standard Arrangements:

1/1/1/1/13/13/1/1/1/1/1/1/1/1/1
216-D

1/1/1/24/10/10/10/10/10/10
216-C

21-POLE

21 - #1 elements
221-A

13/13/13/24/13/13/13/24/13/13/13/24
221-B

24/13w/13g/13k/24/13w/13g/13k/24/13w/13g/13k
221-C

13k/13g/13w/24/13k/13g/13w/24/13k/13g/13w/24
221-D

22-POLE

22 - #1 elements
222-A

2/2/2/2/2/2/2/2/2/2/2/2/2/2/2/2
222-B

24-POLE

24 - #1 elements
224-A

12 - #2 elements
224-B

12 - #13 elements
224-E

26-POLE

26 - #1 elements
226-A

26 - #1k elements
226-K

40-POLE

40 - #1 elements
240-A

20 - #13 elements
240-B

52-POLE

52 - #1 elements
252-A

26 - #13 elements
252-B

Please refer to the STATES website for more part numbers and up to date information

Notes

Lined area for taking notes, consisting of 25 horizontal green lines.

SJK

Test Switches

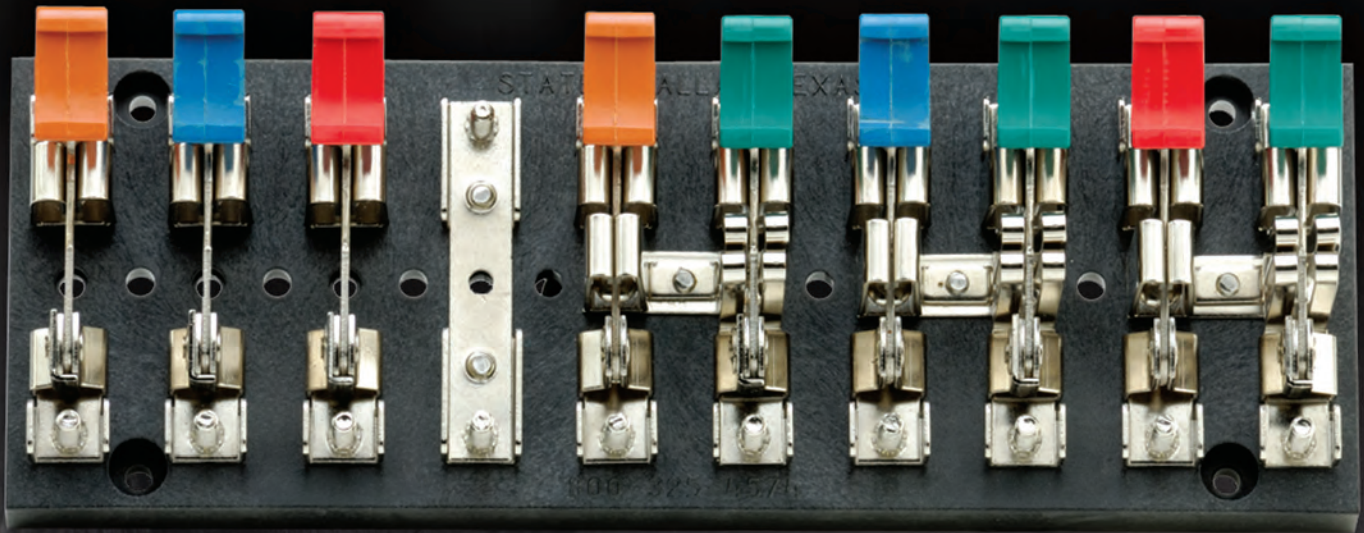

- No-barrier design
- Self-extinguishing materials
- Front-connected, back-connected and flush-mounted styles
- Blades operate independently or can be ganged together
- Recognized by UL and cUL

STATES®

STATES Type SJK Test Switches have long been used for providing a reliable, simple means to test meters, relays and instrument transducers and for control system calibration, disconnection, troubleshooting, checkout and testing.

Make-before-break short-circuiting elements for current transformer circuits and test jacks are available. Each switch blade can be operated independently or, where necessary, adjacent handles can be ganged for simultaneous operation.

All configurations are available in front-connected, back-connected or flush-mounted styles.

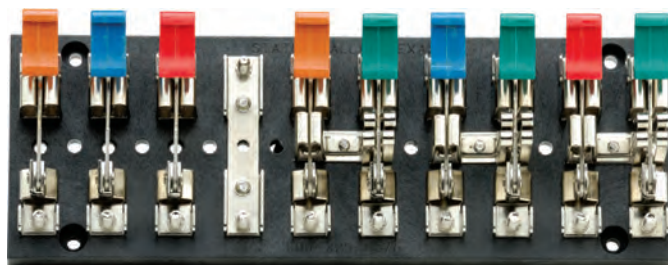

DESCRIPTION

Front-connected switches usually are mounted on the same side of the panel as the wiring. Back-connected switches are mounted on one side of the panel, and the wiring is on the other side. As an option, clear or opaque plastic covers are available for both front-connected or back-connected switches.

Flush-mounted switches match flush- or semiflush-mounted relays, meters, etc., furnished on steel panelboards. They consist of a back-connected switch mounted in an insulated metal cabinet with cover.

FEATURES AND BENEFITS

- **Self-extinguishing materials:** All non-metallic components are made of self-extinguishing, flame-retardant materials with Underwriters Laboratories' best rating for self-extinguishing materials (V-O).
- **Nonferrous material:** All current-carrying metallic components, including hardware, are made of highest quality nonferrous materials such as copper, bronze, brass or phosphor bronze. This ensures excellent conductivity and minimizes galvanic action between dissimilar metals.
- **Nickel plating:** All current-carrying metallic components, including hardware, have a corrosion-resistant nickel finish that ensures good electrical contact and smooth operation of moving parts even after years of inactivity.
- **Safety-grip handle:** A molded handle covers the terminal and includes a lower lip that projects over the metal parts of the switch, thus protecting the operator from contact with live components.
- **One-piece jaw and hinge:** One-piece construction of hinge and jaw eliminates unnecessary, multiple connection points.
- **Special blade shape:** All blades are shaped so that the edge of the blade enters at a right angle to the jaw; thus, the blade enters and exits the full width of the jaw simultaneously.
- **Test lug:** The large corrugated test lug provided for each terminal stud is a secure surface for attaching test clips.
- **Switch jaws:** All STATES Test Switches have uniform contact pressure over the full width of the blade. The "ping" heard when opening the blade is due to the special, spring-grade phosphor bronze used in the jaw. This design ensures an excellent low-resistance contact that will not overheat.
- **Short-circuit jaw:** A rugged, make-before-break element is used to short the secondary of a current transformer.
- **Fixed terminal studs:** The screw terminals on which wiring connections are made are a part of a rigid, immovable assembly and cannot be turned or backed out.
- **Test jack:** The test jack eliminates the possibility of opening current transformer secondaries and permits safe, easy measurements to be made in current circuits without disturbing permanent wiring. A dual-circuit test plug, such as the STATES Part No. 15000, inserted into the test jack puts the measuring instrument in series with the current circuit. The test jack does not carry current except when making a test because it is shunted by a standard switch blade that is opened only when the test jack is used.
- **Color-coded handles:** Unless otherwise specified, **potential** elements have **red** handles and **current** elements have **black**; however, the following other colors are available at additional cost: blue, orange, white, yellow, brown and green.
- **Identification card holder:** Each safety grip handle is slotted for insertion of an identification card for marking or coding. Cards are available under Part No. SB678.
- **Bases:** Type SJK Test Switches are available in 1-, 2-, 3-, 4-, 7- and 10-pole base sizes. The bases are made of rugged, 3/8 inch, non-tracking material with excellent insulating properties. Covers are only available for 4-, 7- and 10-pole base sizes.
- **Extra-wide element separation:** Elements are 11/16 inches center-to-center to allow for easy installation of test leads.
- **Recognized by UL and cUL**
Underwriters Laboratories recognizes States Type SJK Test Switches under its component program, File No. E225664, with a rating of 600 volts, 30 amperes.

FRONT-CONNECTED SWITCHES

The front-connected test switch usually is used where wiring entering and leaving the test switch is located on the same side of the panel that the test switch is mounted.

To order front-connected test switches, refer to **Ordering Information**.

BACK-CONNECTED SWITCHES

All switches can be provided in a back-connected version so that the switch is mounted on one side of a panel and the wiring connections are made on the opposite side. Back-connected switches have factory-installed insulated studs that project from the rear of the switch.

To order back-connected switches, refer to **Ordering Information**.

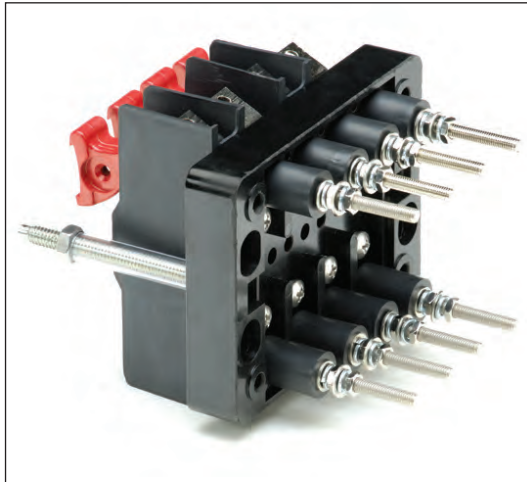

Back-connected switch view
Please Note: barriers are not typically installed on SJK switches (back-connected SMH Test Switch shown)

COVERS

Rugged, virtually unbreakable covers for STATES Test Switches are available in clear or opaque styles. The covers are manufactured from tough, self-extinguishing, flame-retardant polycarbonate and are available for front- or back-connected versions. Covers are available for 4-, 7- and 10-pole base sizes.

The covers are constructed so that all switch blades must be closed when the cover is properly sealed. Switches provided with covers include two insulated, cadmium-plated steel cover studs that have holes for wire seals.

Covers for front-connected switches are open or slotted at the bottom of each side to permit wiring to enter and exit between the cover and the panel.

Covers for back-connected switches fit flush with the panel because all wiring exits at the rear of the test switch.

To add a cover, refer to **Ordering Information**.

FLUSH-MOUNTED SWITCHES

Flush-mounted switches consist of a standard back-connected test switch mounted in an insulated metal cabinet with cover. Flush-mounted switches match flush-mounted or semi-flush-mounted relays, instruments, meters, etc., furnished on steel panelboards.

The switch cabinet has a black finish to match the panelboard and/or devices mounted in the panelboard. The cabinet cover, which has a protective clear insert, can be sealed. Self-extinguishing, flame-retardant insulating material lines the cabinet. The cabinet is mounted by inserting it into a panel cutout and fastening it with screws that are hidden when the cover is attached.

NOTE: Flush-mounted switches are special order products, longer lead times may apply.

To order flush-mounted switches, refer to **Ordering Information**.

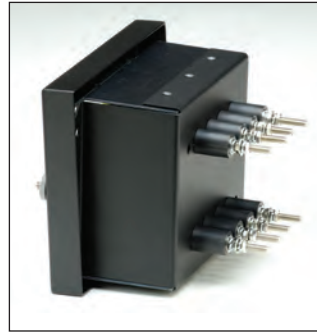

Side view of flush-mounted G unit option



Front view of flush-mounted G unit option



Front-connected opaque (80K) cover



Front-connected clear (60K) cover



Back-connected opaque (90K) cover



Back-connected clear (70K) cover

Cover style must be specified at order placement

SPECIFICATIONS

SJK TECHNICAL SPECIFICATIONS		
Class	Front Connected	Back Connected / Flush Mounted
Brief Description	Metering Test Switch with Stud Terminals	Metering Test Switch with Stud Terminals
Typical Applications	Metering Sub-Station Monitoring Relay Panels	Metering Sub-Station Monitoring Relay Panels
Number of Poles Available	1 - 10	1 - 10
Certifications	UL, cUL UL File E225664	UL, cUL UL File E225664
Voltage Rating	600VAC	600VAC
Current Rating	30A	30A
Wire Size Range	Min 14awg / Max 10awg	Min 14awg / Max 10awg
Recommended Wire Lug Size	#10	#10
Stud Thread	10-32	10-32
Recommended Torque for Stud Wiring Connections	Max 25in/lbs	Max 25in/lbs
#25 Fuse Clip Dimensions - 600 VAC 30 AMP *Fuse not included	1/2" Diameter 2" Length	1/2" Diameter 2" Length
Max Operating Temperature	104° F (40° C)	104° F (40° C)

SJK
Test Switches

Understanding SJK Part Numbers				
1	2	3	4	5
Covers (Optional)	Front-Connected Part Number	Number of Poles	Arrangement Designator	Back-Connected
FRONT-CONNECTED 60K - Slotted, Clear 80K - Slotted, Opaque BACK-CONNECTED 70K - Solid, Clear 90K - Solid, Opaque G - Flush-Mounted w/Cover & Case Enclosure	20K	01 - 10	This is the letter and/or number designation that has been assigned for a particular arrangement See catalog page 97, or visit our website at www.statesproducts.com for arrangement options	Add a -B for back-connection
*Although you can order 1, 2, & 3 pole switches either front-connected or back-connected, covers are not available for those size switch bases. Covers are only available for 4, 7, & 10 pole base sizes.				

EXAMPLES

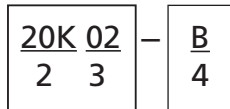

Part No. 20K02-B
SJK 2 Pole Switch - Front-connected, no cover.

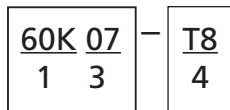

Part No. 60K07-T8
SJK 7 Pole Switch - Front-connected with a clear front-connected cover.





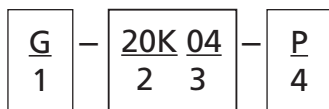







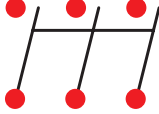







Part No. 70K10-E-B
SJK 10 Pole Switch - Back-connected with a clear back-connected cover.

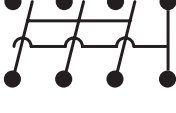

Part No. G-20K04-P
SJK 4 Pole Switch - Mounted in case enclosure with back connections.

SJK SWITCH ELEMENTS

<p>1</p>  <p>Single-Pole Potential</p>	<p>2</p>  <p>Ganged Double-Pole Potential</p>	<p>16</p>  <p>Ganged Three-Pole Potential</p>	<p>13</p>  <p>Ganged Two-Pole Short-Circuiting Current Assembly</p>	<p>17</p>  <p>Ganged Three-Pole Short-Circuiting Current Assembly</p>
<p>9</p>  <p>Current Test Jack</p>	<p>6</p>  <p>Short-Circuiting Assembly With Right-Hand Common Bar</p>	<p>10</p>  <p>Right-Hand Current Assembly Consists of Test Jack and Short-Circuiting Current Assemblies</p>	<p>20</p>  <p>Ganged Three-Pole Short-Circuiting Current Assembly, Right Extension</p>	<p>5</p>  <p>Short-Circuiting Assembly With Left-Hand Common Bar</p>
<p>11</p>  <p>Left-Hand Current Assembly Consists of Test Jack and Short-Circuiting Current Assemblies</p>	<p>19</p>  <p>Ganged Three-Pole Short-Circuiting Current Assembly, Left Extension</p>	<p>22</p>  <p>Left-Hand Through Bar and Three-Pole Short-Circuiting Current Assembly</p>	<p>23</p>  <p>Right-Hand Through Bar and Three-Pole Short-Circuiting Current Assembly</p>	<p>24</p>  <p>Through Bar</p>
<p>26</p>  <p>Blank Space</p>	<p>25</p>  <p>30-Amp Fuse Mounting Clip</p>	<p>3</p>  <p>Current Test Jack With Left-Hand Common Bar</p>	<p>4</p>  <p>Current Test Jack With Right-Hand Common Bar</p>	

NOTES:

1. Barriers are typically not provided on SJK Test Switches.
2. **Potential** handles are **red** and **current** handles are **black** unless otherwise specified.
3. Arrange elements left to right, front view.
4. Covers are only available on 4, 7 and 10 pole bases.
5. Element No. 25 accepts standard cartridge fuses rated 600 VAC 30 AMP Fuse dimensions must be 1/2" diameter and 2" length. Fuse not included.

ORDERING INFORMATION

The part numbers under the arrangements beginning on page 97 are for front-connected switches without covers, which are designated by the first three characters in the Part No., 20K.

Example: 20K10-E

SPECIAL ORDERS

Special Arrangements: These can be made of any combination of potential or current elements, with a maximum of 10 poles. For more information, refer to the following example and illustrations on Page 89.

Example: To order a customized, 10-pole, back-connected switch with a clear, back-connected cover, specify:

Switch Type: STATES Type SJK
No. of poles: 10-pole test switch
Arrangement*: 1-10-1-10-1-10-1
Style: Back-connected
Cover: Clear, back-connected

***Arrangements should be given as front view of switch, left to right, using the elements listed on page 90.**

Handle Colors: The standard colors for handles are **red** for **potential** and **black** for **current**. Handles are also available in other colors.

To specify non-standard colors, add to the element number the appropriate color code:

Color	Color Code
Black	k
Blue	b
Green	g
Orange	e
Red	r
White	w
Yellow	y
Brown	n

To order a switch with handles in non-standard colors, you must specify the arrangement with colors indicated. For example, to order a 10-pole switch with special handle colors, specify: **Arrangement:** 1k-10g-1y-10b-1e-10r-1w

Ganged handles: You may specify a yoking bar to gang adjacent handles.

For example, to order a switch with the adjacent potentials ganged, you must specify: **Gang all potentials**

Ganged handles are represented with the number (#) sign.

Example: #1-1-1-1# (all handles in between the “#” are ganged together)

Hinge position: The “U” in an arrangement indicates the hinge is positioned upside down from the typical arrangement.

Bases: An 8- or 9-pole test switch is built on a 10-pole base. A 5-, 6-, or 7-pole test switch usually is built on a 7-pole base but can be provided on a 10-pole base if desired.

OPTIONAL ACCESSORIES



Socket Wrench and Insert

To speed installation of the terminal nuts on STATES Test Switches, the socket wrench (Part No. 16028) and $\frac{3}{8}$ inch insert (Part No. 16027) are available. Pictures available in the Testing Accessories section on page 134.

The screwdriver attachment

(Part No. 16022) makes this wrench your complete meter installation tool.

Dual Circuit Plug

By inserting the STATES Dual Circuit Plug (Part No. 15000) into the test jack, safe measurement can be made of current transformer secondary current.

See Testing Accessories on page 128.



TYPICAL WIRING DIAGRAM

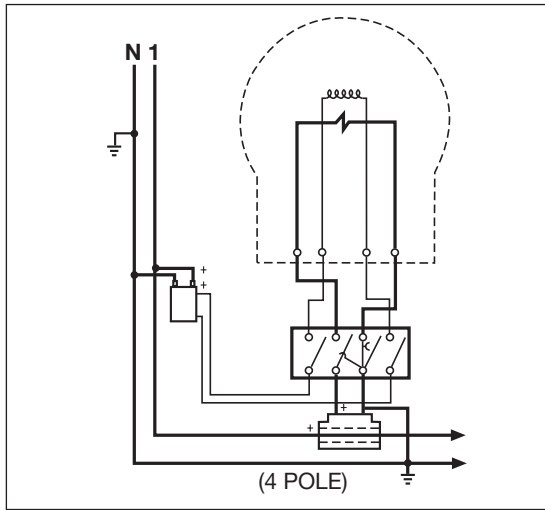

1 ϕ 2-Wire with CT and PT

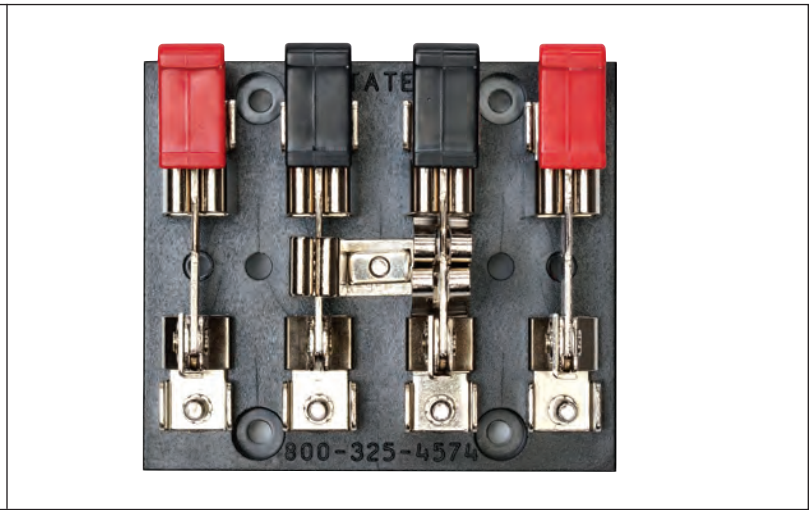

4-Pole Test Switch - Part No. 20K04-M (ARR: 1-10-1)

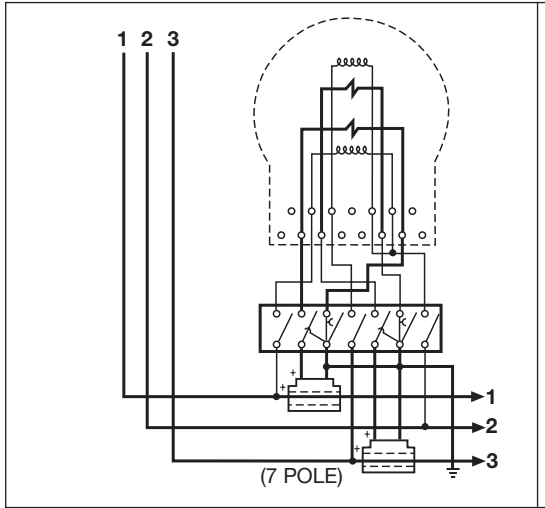

3 ϕ 3-Wire 2-Element

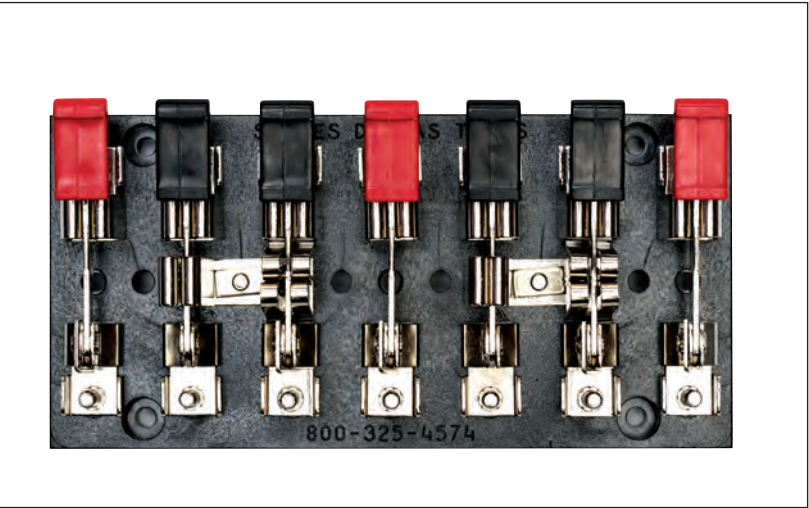

7-Pole Test Switch - Part No. 20K07-K (ARR: 1-10-1-10-1)

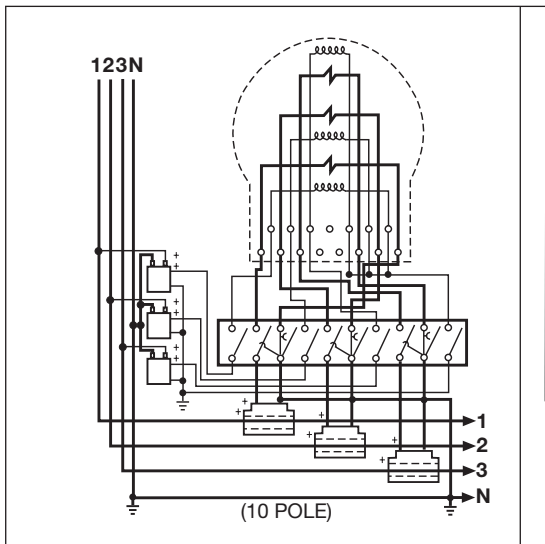

3 ϕ 4-Wire Y 3-Element

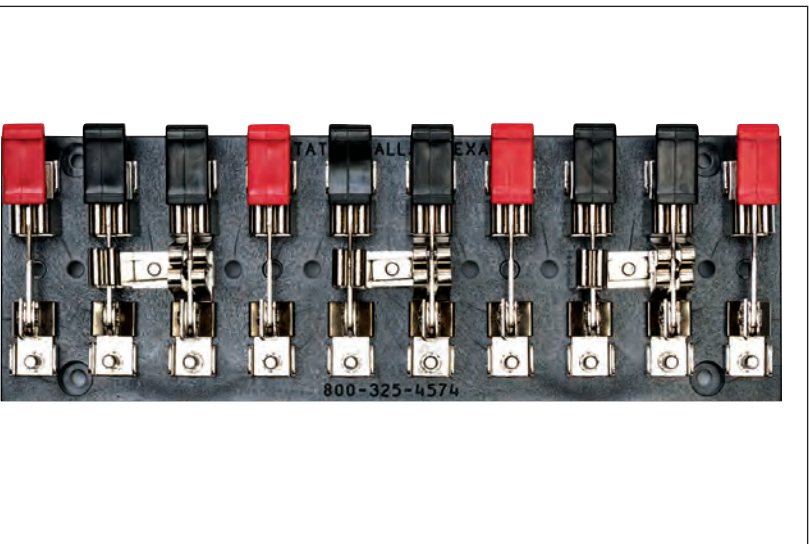

10-Pole Test Switch - Part No. 20K10-E (ARR: 1-10-1-10-1-10-1)

**FRONT-CONNECTED SWITCHES
DIMENSIONS IN INCHES [MM]**

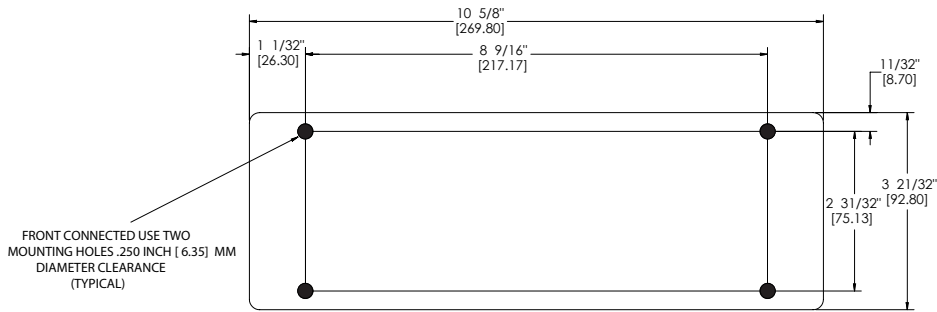

FRONT CONNECTED USE TWO MOUNTING HOLES. .250 INCH [6.35] MM DIAMETER CLEARANCE (TYPICAL)

10 POLE BASE

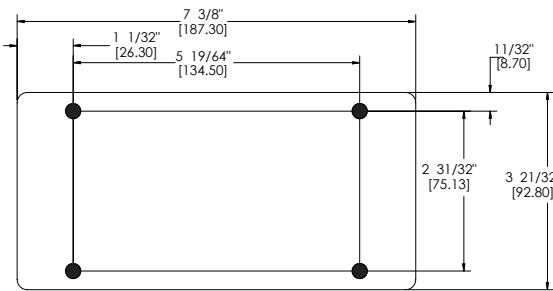

7 POLE BASE

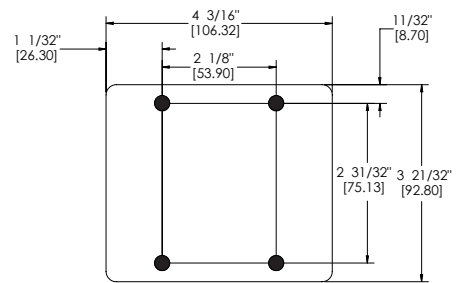

4 POLE BASE

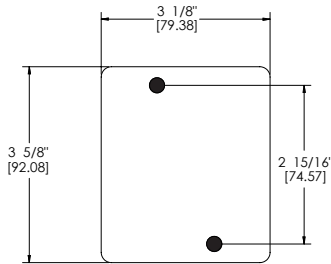

3 POLE BASE

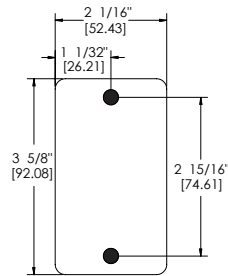

2 POLE BASE

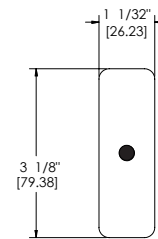

1 POLE BASE

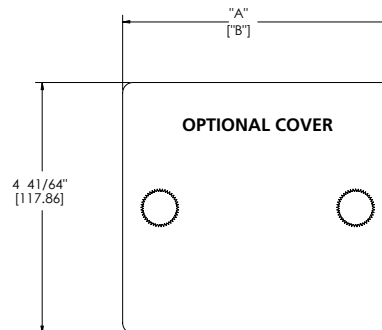
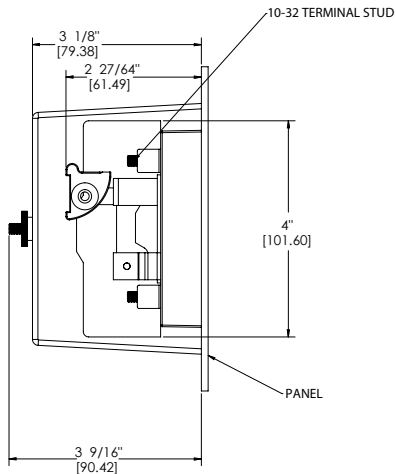

POLE	"A" DIMENSION	"B" DIMENSION
4	4 13/16"	[122.2]
7	8 1/8"	[206.3]
10	11 1/8"	[282.5]

SJK
Test Switches

BACK-CONNECTED SWITCHES DIMENSIONS IN INCHES [MM]

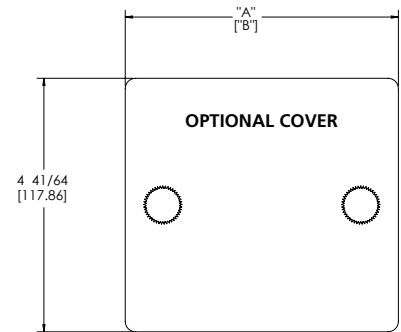
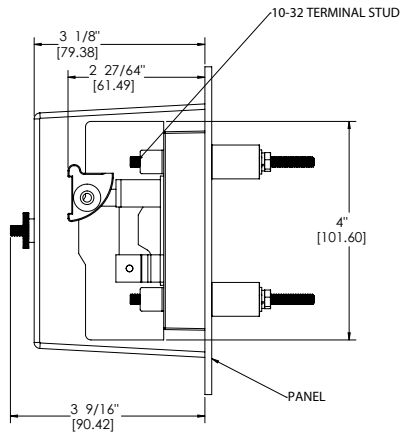
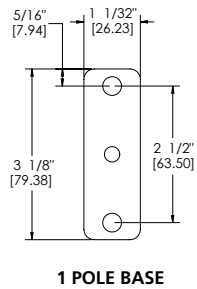
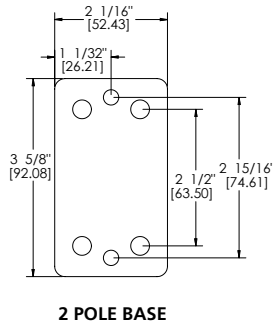
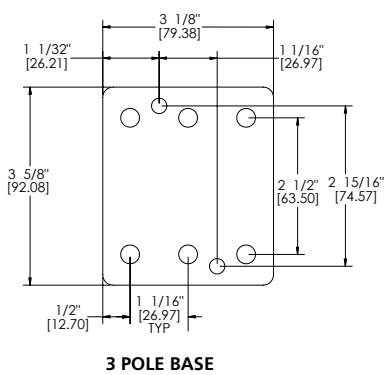
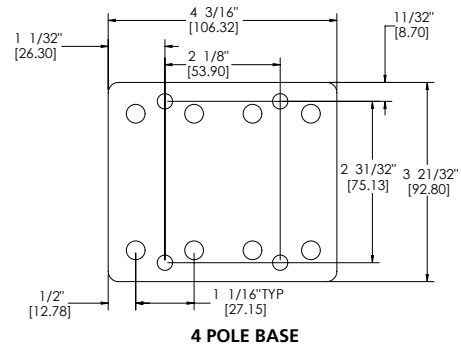
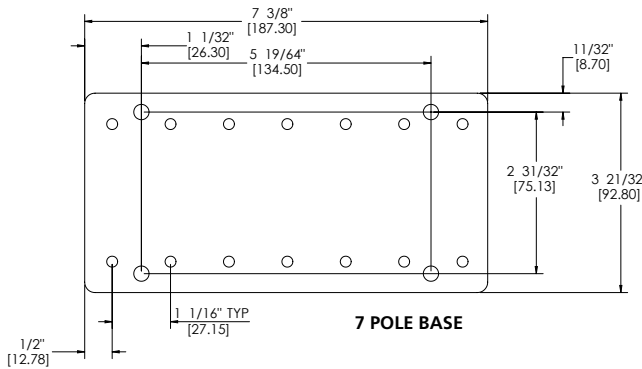
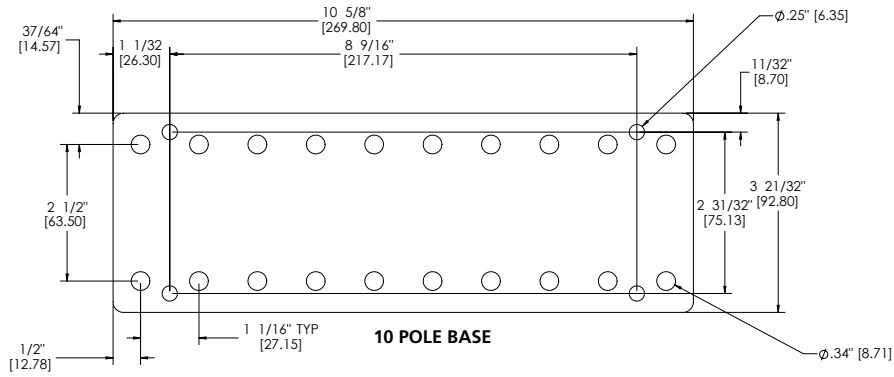

POLE	"A" DIMENSION	"B" DIMENSION
4	4 13/16"	[122.2]
7	8 1/8"	[206.3]
10	11 1/8"	[282.5]

SJK Test Switches

**FLUSH-MOUNTED SWITCHES
DIMENSIONS IN INCHES [MM]**

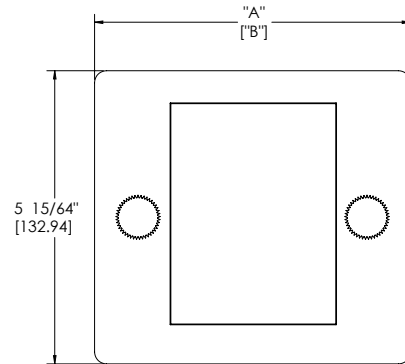
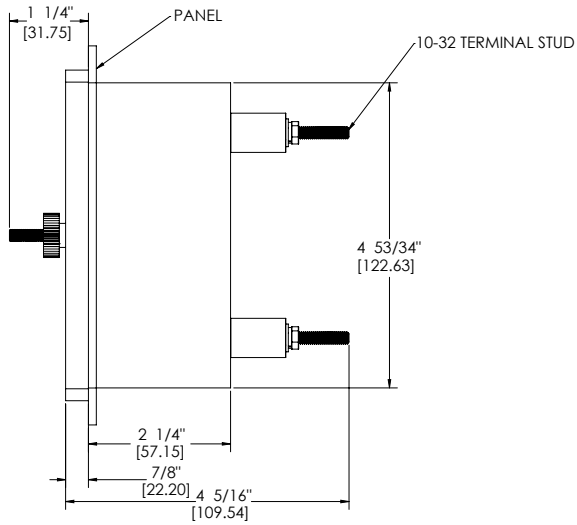
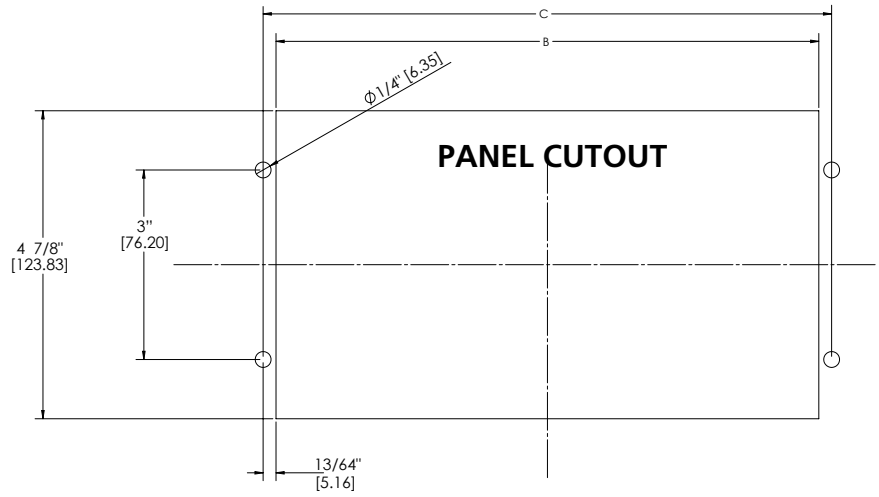

DIMENSIONS IN [] ARE IN MM , NO [] DIMENSIONS IN INCHES

BASE SIZE (POLES)	"A" DIMENSION	"B" DIMENSION	"C" DIMENSION
4	6 7/16" [163.5]	5 7/32" [132.5]	5 5/8" [142.9]
7	9 39/64" [244]	8 13/32" [213.5]	8 26/32" [223.8]
10	12 13/16" [325.4]	11 19/32" [294.5]	12 [304.8]

SJK
Test Switches

SJK ACCESSORIES

PART NUMBER	DESCRIPTION
SB678-100	White Marker Handle Tags (100pcs per bag)
SBK50-xx	Handle Ganging Kit - Replace the "xx" with the required number of adjacent poles to be ganged together (example: SBK50-2 - 2 Pole Kit)
17192	2 Pole Hardware Kit
10550	4 Pole Hardware Kit
10551	7 Pole Hardware Kit
10552	10 Pole Hardware Kit
SJ60K-4	4 Pole Front Connected Clear Cover - includes cover, cover knobs and cover stud hardware
SJ70K-4	4 Pole Back Connected Clear Cover - includes cover, cover knobs and cover stud hardware
SJ80K-4	4 Pole Front Connected Opaque Cover - includes cover, cover knobs and cover stud hardware
SJ90K-4	4 Pole Back Connected Opaque Cover - includes cover, cover knobs and cover stud hardware
SJ60K-7	7 Pole Front Connected Clear Cover - includes cover, cover knobs and cover stud hardware
SJ70K-7	7 Pole Back Connected Clear Cover - includes cover, cover knobs and cover stud hardware
SJ80K-7	7 Pole Front Connected Opaque Cover - includes cover, cover knobs and cover stud hardware
SJ90K-7	7 Pole Back Connected Opaque Cover - includes cover, cover knobs and cover stud hardware
SJ60K-10	10 Pole Front Connected Clear Cover - includes cover, cover knobs and cover stud hardware
SJ70K-10	10 Pole Back Connected Clear Cover - includes cover, cover knobs and cover stud hardware
SJ80K-10	10 Pole Front Connected Opaque Cover - includes cover, cover knobs and cover stud hardware
SJ90K-10	10 Pole Back Connected Opaque Cover - includes cover, cover knobs and cover stud hardware

Please refer to our website for accessory pictures.

FRONT VIEW

1-POLE

(On 1-Pole base unless otherwise noted)

1



20K01-B (1-Pole base)

Color Options: **1y**
20K01-F

1k
20K01-K
(1-pole base)

9



20K01-E (1-Pole base)

Other 1-Pole
Standard Arrangements:

1-26
20K01-P (2-Pole base)

9-26
20K01-E2 (2-Pole base)

2-POLE

(On 2-pole base unless otherwise noted)

1-1



20K02-D2 (2-Pole base)

2



20K02-B (2-Pole base)

Color Option: **2y**
20K02-N2
(2-Pole base)

11



20K02-D (2-Pole base)

10



20K02-G (2-Pole base)

2-POLE (CONT.)

13



20K02-E (2-Pole base)

Other 2-Pole
Standard Arrangements:

1/1g
20K02-J4 (2-Pole base)

26-1-1-26
20K02-K2 (4-Pole base)

26-2-26
20K02-A (4-Pole base)

26-13-26
20K02-V2 (4-Pole base)

3-POLE

(On 4-Pole base unless otherwise noted)

1-1-1-26
20K03-B2 (4-Pole base)

Color Option: **1y-1y-1y-26**
20K03-N3
(4-Pole base)

16-26

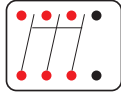

20K03-T (4-Pole base)

Color Option: **16K-26**
20K03-D4
(4-Pole base)

9-9-9-26

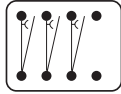

20K03-V2 (4-Pole base)

17



20K03-E2 (3-Pole base)

Other 3-Pole
Standard Arrangements:

1-10-26
20K03-E3 (4-Pole base)

3-POLE (CONT.)

1-11
20K03-C6 (3-Pole base)

1-25-25-26
20K03-A7 (4-Pole base)

15-24-26
20K03-A2 (4-Pole base)

16
20K03-D (3-Pole base)

17-26
20K03-A3 (4-Pole base)

4-POLE

(On 4-pole base unless otherwise noted)

1-1-1-1

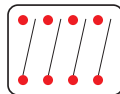

20K04-P

1-10-1

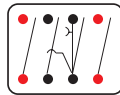

20K04-M

20-24

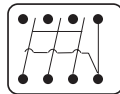

20K04-S3

1-13-1



20K04-D

Other 4-Pole
Standard Arrangements:

1-1-1-1
20K04-SA

1/1/10
20K04-X

1-1-11
20K04-C

1-1-25-25
20K04-A3

1-26-1-26-26-11
20K04-T6 (7-Pole base)

1-26-10-26-1-26
20K04-AK (7-Pole base)

4-POLE (CONT.)

4-1-1-5
20K04-E2

6-6-6-7
20K04-G5

9-24-14
20K04-GA

9-9-9-9
20K04-W

9-26-9-26-9-26-9
20K04-Z8 (7-Pole base)

10-1-1
20K04-K

10-2
20K04-C7

10-10
20K04-B

13-13
20K04-H

22
20K04-Q2

25-25-1-1
20K04-YA

26-26-26-4-1-1-5
20K04-RA (7-Pole base)

5-POLE

(On 7-pole base)

26-1-1-1-1-1-26

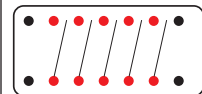

20K05-P

26-9-9-9-9-26

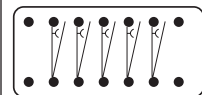

20K05-G5

26-16-10-26

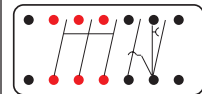

20K05-S3

FRONT VIEW

5-POLE (CONT.)

26-25-25-25-25-26

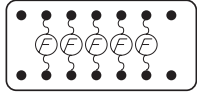

20K05-N5

Other 5-Pole
Standard Arrangements:

1-26-1-26-13-24
20K05-C8

1-26-26-10-11
20K05-B6

13-26-26-16
20K05-J4

26-10-1-10-26
20K05-K

26-1-1-1-1-1-26
20K05-L5

26-2/1/1-1-26
20K05-B8

6-POLE (ON 7-POLE BASE)

2-2-2-26

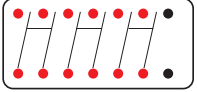

20K06-N4

13-13-13-26

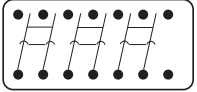

20K06-F

1-10-1-11-26

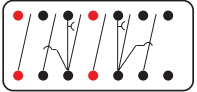

20K06-T

Other 6-Pole
Standard Arrangements:

1-1-1-1-1-1-26
20K06-B

1-1-1-1-1-1-26
20K06-V8

1y-1y-1y-1y-1y-26
20K06-B8

1-1-1-26-25-25-25
20K06-LC

2-2/26-13
20K06-S5

4-6-4-6-4-5-26

6-POLE (CONT.)

20K06-S2

9-9-9-9-9-26
20K06-P5

11-11-11-26
20K06-Q3

10-10-10-26
20K06-R7

13-13-26/1/1
20K06-A

13-13-26/2
20K06-C5

13-13-13-26
20K06-DC

13r-13r-13r-26
20K06-FR

7-POLE (ON 7-POLE BASE, UNLESS OTHERWISE NOTED)

1-10-1-11-1

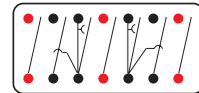

20K07-A

16-10-10



20K07-BZ

1-1-1-1-1-1-1

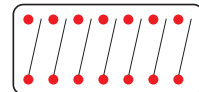

20K07-S

Color Option: **1y-1y-1y-1y-1y-1y-1y**
20K07-BJ

9-9-9-9-9-9-9

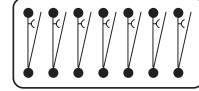

20K07-RA

9-9-9-24-19

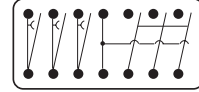

20K07-T8

Other 7-Pole
Standard Arrangements:

/1/1/1/10-10
20K07-B2

1e-1b-1g-10eg-10bg
20K07-B7

1-1-1-10-11
20K07-E

1-1-1-1-11-1
20K07-R1

1/1/1-26-26-26-10-10
20K07-CE (10-Pole base)

1-10-1-10-1
20K07-K

/1/10/1/11/1/1
20K07-M

/1k/10wg/1b/10gy/1/1
20K07-CC

1-11-1-11-1
20K07-Z

1-13-1-13-1
20K07-D

1-13-1-13-1
20K07-AZ

/1/13/1y/13/1
20K07-DY3

1-26-1-26-1-26-10-11
20K07-CF (10-Pole base)

/1/26-10-26/1/26-10/1/1
20K07-CG 10-Pole base)

1-26-10-26-1-26-11/1/1
20K07-C2 10-Pole base)

1-26-13-26-1-26-13/1/1
20K07-CD 10-Pole base)

9-11-9-11-9
20K07-NA

10-11-1-1-1
20K07-G

13-13-13-1
20K07-AX

8-POLE (ON 10-POLE BASE)

26-1-10-1-1-11-1-26

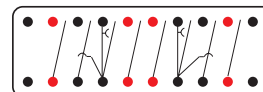

20K08-B

26-1-1-1-1-13-13-26



20K08-CD

9-9-9-9-26-26-9-9-9-9

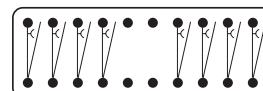

20K08-U9

Color Key: k: Black b: Blue g: Green e: Orange r: Red w: White n: Brown y: Yellow

FRONT VIEW

Color Option:
9r-9r-9r-9r-26-26-9r-9r-9r-9r
20K08-XA

Other 8-Pole
Standard Arrangements:

1b/1g/1/24/-26-10-26-11rr
20K08-CF

26-1-1-1-1-1-1-1-1-26
20K08-N

26-1-1-1-1-1-1-1-1-26
20K08-AB

26-1-1-1-1-10-10-26
20K08-PE

26-1-1-1-1-10-11-26
20K08-E2

26-1/1/1/1/13-13-26
20K08-B6

26/1/6/1/6-4/1/3/1/26
20K08-CG

26-1r-6r-9k/1k/1w-9w-5g-1g-26
20K08-P6

26-1-10ek-1y-1w-10gk-1k-26
20K08-ME

26-1-10-10-10-1-26
20K08-F7

26-1-13-1-1-13-1-26
20K08-J

26-9-9-9-9-9-9-9-26
20K08-T9

26-9-9-9-24-19-5-26
20K08-TE

26-10-10-10-1-1-26
20K08-V

26-10-10-10-10-26
20K08-K6

26-16-24-13-13-26
20K08-JE

9-POLE (ON 10-POLE BASE)

1-1-1-13-13-13-26

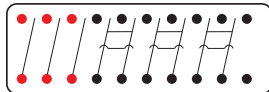

20K09-C

1-1-1-26-4-6-4-6-4-5

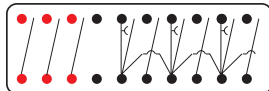

20K09-D8

1-10-1-10-1-10-26

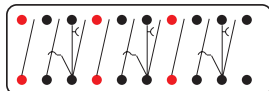

20K09-K

16-10-10-10-26

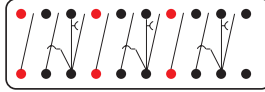

20K09-XU

Other 9-Pole
Standard Arrangements:

1-1-1-1-1-1-1-1-26
20K09-W

1-1-1-1-1-13-13-26
20K09-C7

1-1-1-10-10-10-26
20K09-U

1-1-1-11-11-11-26
20K09-P

1-1-24-26-4-6-4-6-4-5
20K09-F8

1-10-10-1-10-1-26
20K09-G

1-11-1-11-1-11-26
20K09-N

1-13-1-13-1-13-26
20K09-H

9-9-9-9-9-9-9-9-26
20K09-Q4

9-10-10-10-10-26
20K09-U7

10-10-10-1-1-1-26
20K09-D

10-10-10-10-9-26
20K09-AB

11-9-11-9-11-9-26
20K09-XB

10-POLE (ON 10-POLE BASE)

1-10-1-10-1-10-1

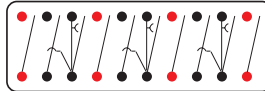

20K10-E

Color Options:

1-10bw-1y-10gw-1e-10nw-1w
20K10-BZ

1-10rk-1w-10wb-1g-10ge-1k
20K10-Z5

1-1-1-1-13-13-13

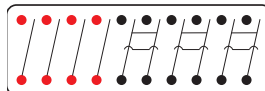

20K10-C

9-9-9-9-24-14-19

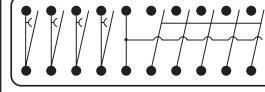

20K10-MA

1-1-1-1-1-1-1-1-1-1

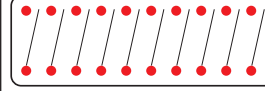

20K10-Y

Color Options:

1y-1y-1y-1y-1y-1y-1y-1y-1y
20K10-H8

1k-1k-1k-1k-1k-1k-1k-1k-1k
20K10-K8

1-1-1-1-10-10-10
20K10-BT

1e-1b-1-24-10eg-10bg-10rg
20K10-BV

/1/1/1/24-11-11-11
20K10-D7

1-1-10-10-1-1-1-1
20K10-BB

1-6-1-6-1-6-4-4-4-24
20K10-X

/1/10/1/10/1/10/1/
20K10-EM

1-13-1-13-1-13-1
20K10-G

/1/13/1/13/1/13/1y/
20K10-W5

1-13-1-13-1-13-24
20K10-F

/1/13/1/13/1/13/24/
20K10-M

2-2-2-2-2
20K10-AA

2-2-2-2-13
20K10-CK

9-9-9-9-9-24-19
20K10-M9

9-9-9-24-5-5-5-5-5
20K10-B5

9-9-9-24-19-19
20K10-G9

9-9-9-24-19-19
20K10-V9

10-10-10-10-10
20K10-M4

13-13-13-1-1-1-24
20K10-BU

Please refer to the STATES website
for more part numbers and
up to date information.

2RK1

Test Switches



- No-barrier design
- Compact
- Front connected
- Safety-grip handle

STATES®

The 2RK1 Test Switch is a single potential pole knife blade switch with wiring connections on the side for those applications where space is limited. These are available with different color handles to meet your specifications.



SPECIFICATIONS

2RK1 TEST SWITCH TECHNICAL SPECIFICATIONS	
Brief Description	Side Connected Test Switch
Voltage Rating	600VAC
Current Rating	30A
Recommended Wire Size Range	Min 14awg / Max 10awg
Recommended Wire Lug Size	#10
Stud Thread	10-32
Recommended Torque for Stud Wiring Connections	Max 25in/lbs
Ambient Temperature	104° F (40° C)

ORDERING INFORMATION

- Part No. 2RK1-A** 1 Pole Switch ARR: 1Y - Single pole potential with a yellow handle
- Part No. 2RK1-B** 1 Pole Switch ARR: 1 - Single pole potential with a red handle
- Part No. 2RK1-C** 1 Pole Switch ARR: 1K - Single pole potential with a black handle
- Part No. 2RK1-D** 1 Pole Switch ARR: 1W - Single pole potential with a white handle
- Part No. 2RK1-E** 1 Pole Switch ARR: 1B - Single pole potential with a blue handle
- Part No. 2RK1-F** 1 Pole Switch ARR: 1G - Single pole potential with a green handle

2RK1
Test Switches

2RK1 Test Switches



DIMENSIONS IN INCHES [MM]

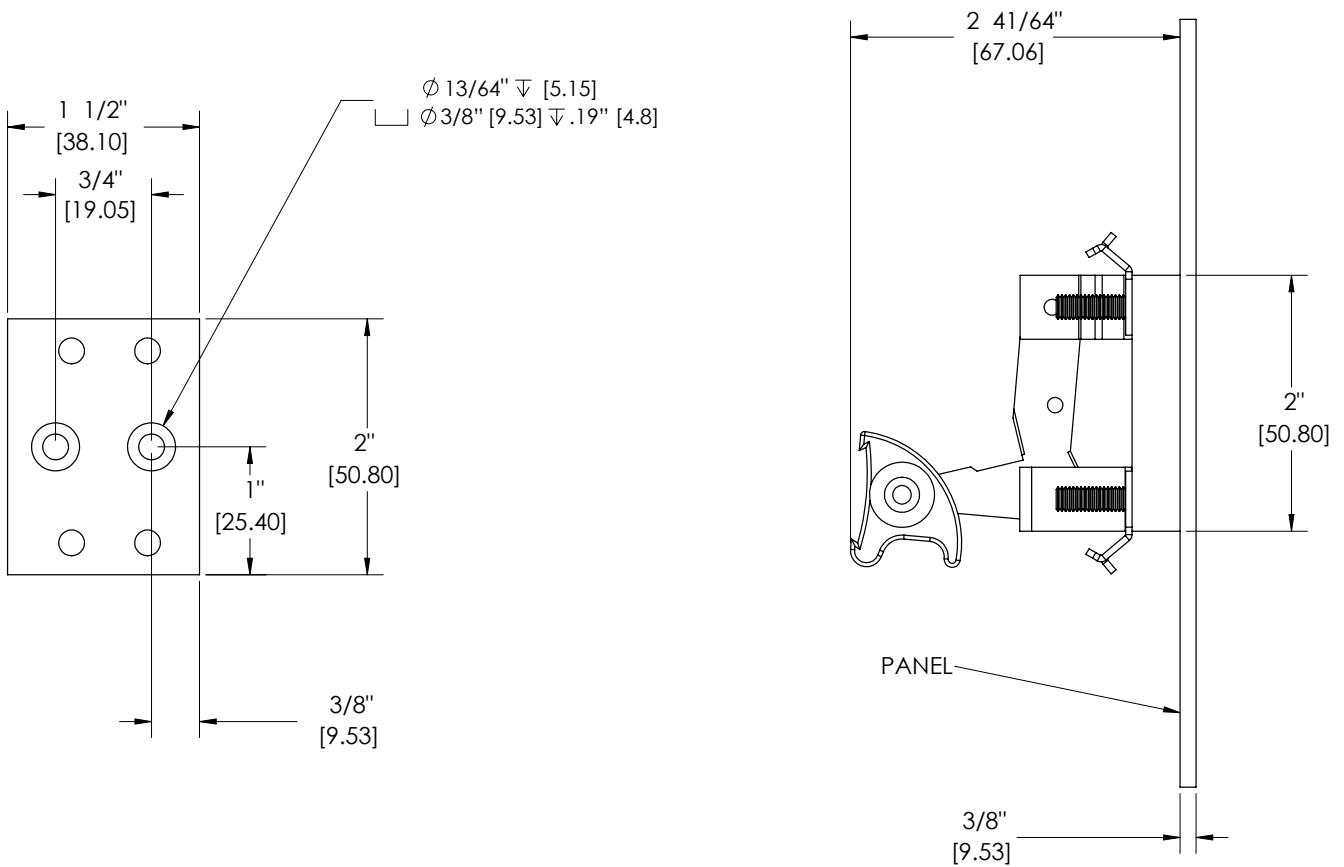

Covers are not available for these switches.

2RK1
Test Switches

Notes

SMH

Test Switches

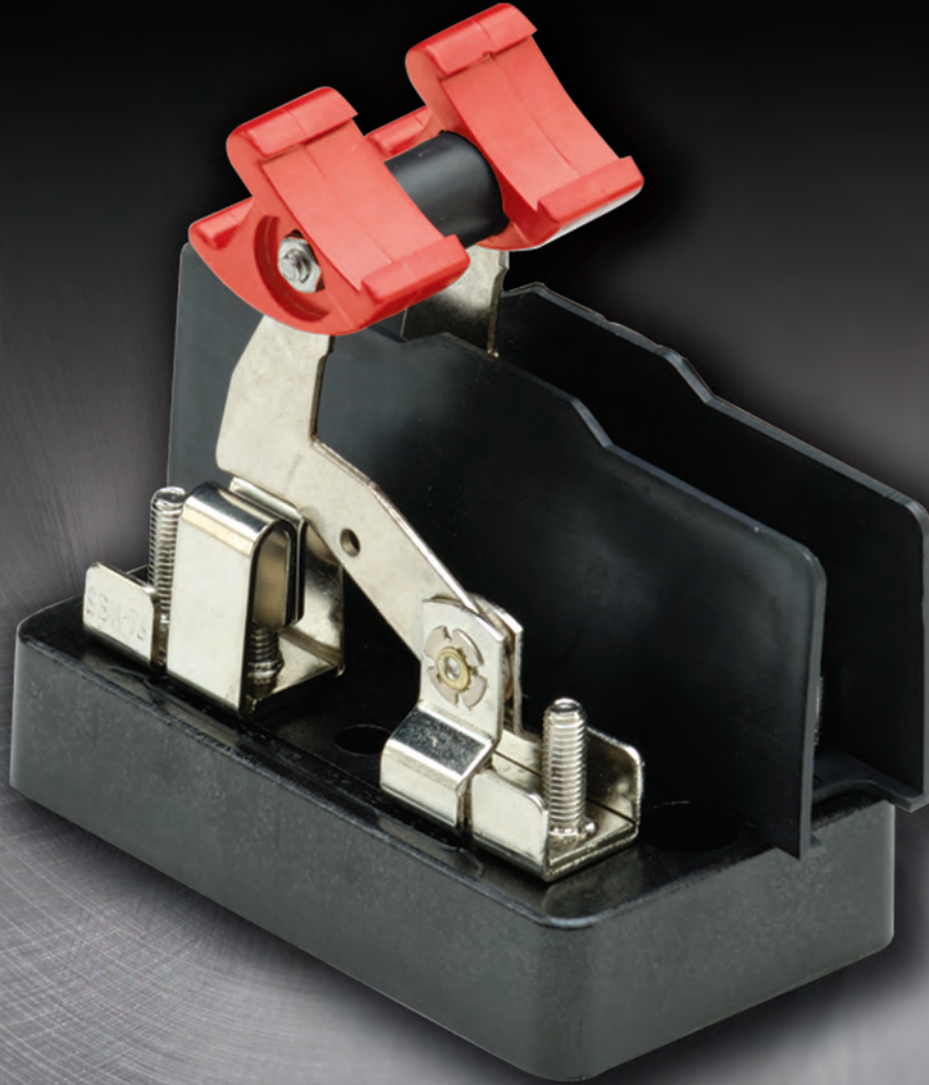

- High barriers
- Recognized by UL and cUL
- Self-extinguishing materials
- Nonferrous material
- Corrosion-resistant nickel finish
- Safety-grip handle

STATES[®]

A complete line of switches is available for meter, relay, instrument, transducer and control system calibration, disconnection, troubleshooting, checkout and testing.

All the features you need for any application: potential elements, current elements, make-before-break short-circuiting elements for current transformer circuits. Test jacks are included.



DESCRIPTION

STATES Type SMH Test Switches combine many decades of experience in the design and manufacture of test switches with the latest improvements in material composition and construction techniques.

Each switch blade can be operated independently or, where requirements dictate, adjacent handles can be ganged for simultaneous operation.

Features are incorporated for safety, durability, ruggedness and reliability. Where applicable, dimensions are in accordance with EEI-AEIC Meter and Service Committee Standards.

All configurations are available in front-connected, back-connected or flush-mounted styles.

RECOGNIZED BY UL AND cUL

Underwriters Laboratories recognizes STATES Type SMH Test Switches under its component program, File No. E75355, with a rating of 600 volts, 30 amperes.

FEATURES AND BENEFITS

- **Self-extinguishing materials:** All non-metallic components are made of self-extinguishing, flame-retardant materials with Underwriters Laboratories' best rating for self-extinguishing materials (V-O).

- **Nonferrous material:** All current-carrying metallic components, including hardware, are made of highest quality nonferrous materials such as copper, bronze, brass or phosphor bronze. This ensures excellent conductivity and minimizes galvanic action between dissimilar metals.
- **Nickel plating:** All current-carrying metallic components, including hardware, have a corrosion-resistant nickel finish that ensures good electrical contact and smooth operation of moving parts even after years of inactivity.
- **One-piece jaw and hinge:** One-piece construction of hinge and jaw eliminates unnecessary, multiple connection points.
- **Special blade shape:** All blades are shaped so that the edge of the blade enters at a right angle to the jaw; thus, the blade enters and exits the full width of the jaw simultaneously.
- **Test lug:** The large corrugated test lug provided for each terminal stud is a secure surface for attaching test clips.
- **Switch jaws:** All STATES Test Switches have uniform contact pressure over the full width of the blade. The "ping" heard when opening the blade is due to the special, spring-grade phosphor bronze used in the jaw. This design ensures an excellent low-resistance contact that will not overheat.

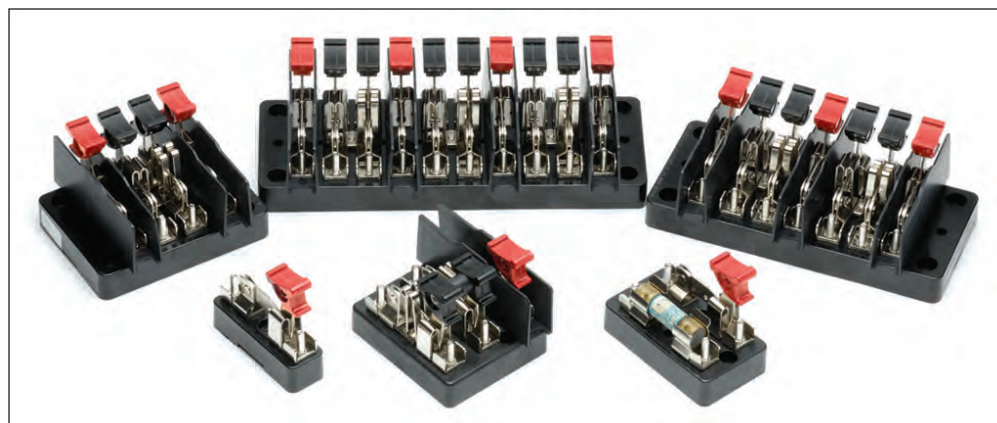

Type SMH Test Switches are available in 1-, 2-, 3-, 4-, 7- and 10-pole base sizes. The bases are made of rugged, 1/8 inch, nontracking material with excellent insulating properties and are impervious to moisture. Mounting dimensions of the 4-, 7-, and 10-pole bases conform to applicable EEI-AEIC Meter and Service Committee Standards.

SMH Test Switches

- **Short-circuit jaw:** A rugged, make-before-break element is used to short the secondary of a current transformer.
- **Fixed terminal studs:** The screw terminals on which wiring connections are made are part of a rigid, immovable assembly and cannot be turned or backed out.
- **Test jack:** The test jack eliminates the possibility of opening current transformer secondaries and permits safe, easy measurements to be made in current circuits without disturbing permanent wiring. A dual-circuit test plug, such as the STATES Part No. 15000, inserted into the test jack puts the measuring instrument in series with the current circuit. The test jack does not carry current except when making a test because it is shunted by a standard switch blade that is opened only when the test jack is used.
- **Color-coded handles:** Unless otherwise specified, **potential** elements have **red handles** and **current** elements have **black handles**; however, the following other colors are available at additional cost: blue, orange, white, yellow, brown and green.
- **Identification card holder:** Each safety grip handle is slotted for insertion of an identification card for marking or coding. Cards are available under Part No. SB678.



Safety-grip handle
A molded handle covers the terminal and includes a lower lip that projects over the metal parts of the switch, thus protecting the operator from contact with live components.



High barriers
Maximum circuit isolation is obtained by extra-high barriers that provide uncompromised protection. Barriers are permanently mounted and cannot fall out or be knocked out, as in some "snap-in" designs.

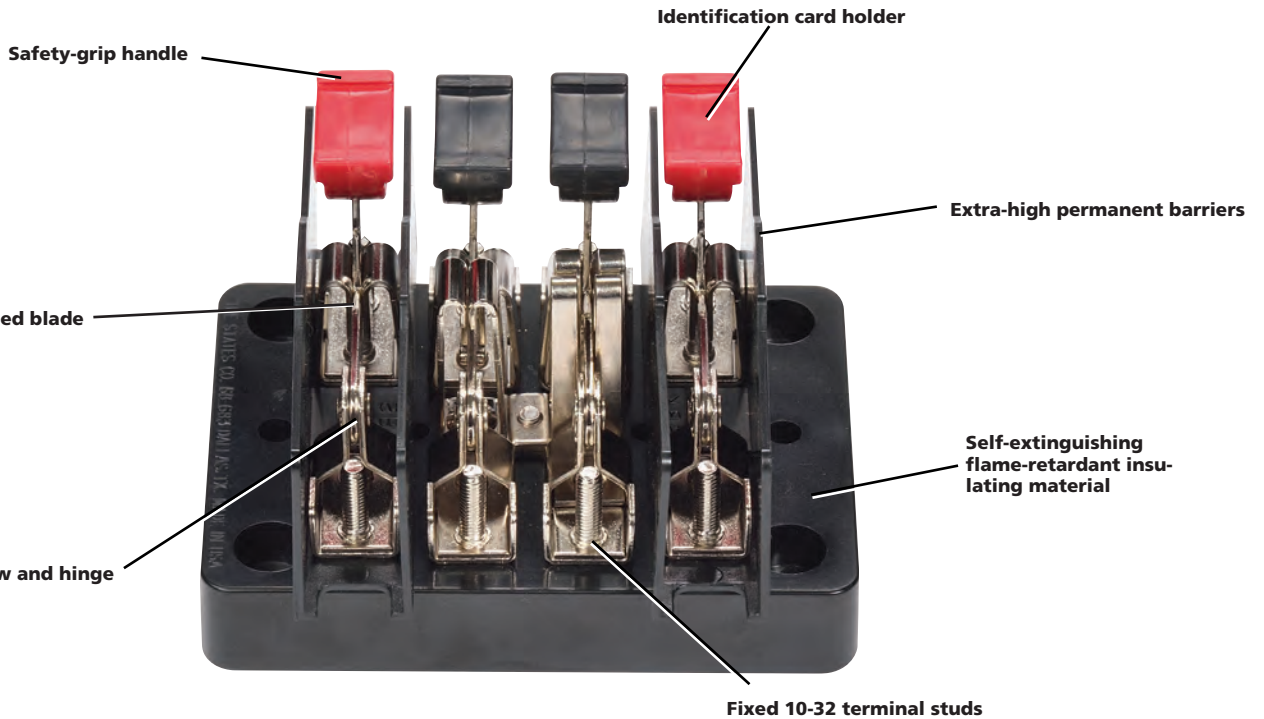

Safety-grip handle

Identification card holder

Extra-high permanent barriers

Special angled blade

Self-extinguishing flame-retardant insulating material

One-piece jaw and hinge

Fixed 10-32 terminal studs

FRONT-CONNECTED SWITCHES

The front-connected test switch usually is used where wiring entering and leaving the test switch is located on the same side of the panel that the test switch is mounted.

To order front-connected test switches, refer to **Ordering Information**.



BACK-CONNECTED SWITCHES

All switches can be provided in a back-connected version so that the switch is mounted on one side of a panel and the wiring connections are made on the opposite side. Back-connected switches have factory-installed insulated studs that project from the rear of the switch.

To order back-connected switches, refer to **Ordering Information**.

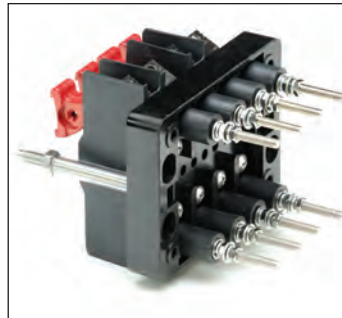

Back-connected switch view

FLUSH-MOUNTED SWITCHES

Flush-mounted switches consist of a standard back-connected test switch mounted in an insulated metal cabinet with cover. Flush-mounted switches match flush-mounted or semi-flush-mounted relays, instruments, meters, etc., furnished on steel panelboards.

The switch cabinet has a black finish to match the panelboard and/or devices mounted in the panelboard. The cabinet cover, which has a protective clear insert, can be sealed. Self-extinguishing, flame-retardant insulating material lines the cabinet. The cabinet is mounted by inserting it into a panel cutout and fastening it with screws that are hidden when the cover is attached.

To order flush-mounted switches, refer to **Ordering Information**.



Front view of flush-mounted G unit option



Side view of flush-mounted G unit option

NOTE: Flush-mounted switches are special order and require longer lead times.

SMH Test Switches

COVERS

Rugged, virtually unbreakable covers for STATES Test Switches are available in clear or opaque styles. The covers are manufactured from tough, self-extinguishing, flame-retardant polycarbonate and are available for front- or back-connected versions. Covers are available on 4-, 7- and 10-pole base sizes.

The covers are constructed so that all switch blades must be closed when the cover is properly sealed. Switches provided with covers include two insulated, cadmium-plated steel cover studs that have holes for wire seals.

Covers for front-connected switches are open or slotted at the bottom of each side to permit wiring to enter and exit between the cover and the panel.

Covers for back-connected switches fit flush with the panel because all wiring exits at the rear of the test switch.

To add a cover, refer to **Ordering Information**.



Front-connected opaque (C1) cover



Front-connected clear (C3) cover



Back-connected opaque (C2) cover



Back-connected clear (C4) cover

SMH
Test Switches

Cover style must be specified at order placement

SPECIFICATIONS

SMH TECHNICAL SPECIFICATIONS		
Class	Front Connected	Back Connected / Flush Mounted
Brief Description	Metering Test Switch with Stud Terminals	Metering Test Switch with Stud Terminals
Typical Applications	Metering Sub-Station Monitoring Relay Panels	Metering Sub-Station Monitoring Relay Panels
Number of Poles Available	1 - 10	1 - 10
Certifications	UL, cUL UL File E75355	UL, cUL UL File E75355
Voltage Rating	600VAC	600VAC
Current Rating	30A	30A
Wire Size Range	Min 14awg / Max 10awg	Min 14awg / Max 10awg
Recommended Wire Lug Size	#10	#10
Stud Thread / (Nut Size)	10-32 / (3/8 x 3/8)	10-32 (3/8 x 3/8)
Recommended Torque for Stud Wiring Connections	Max 25in/lbs	Max 25in/lbs
#73 - Fuse Clip Dimensions - 600 VAC 30 AMP *Fuse not included	1/2" Diameter 2" Length	1/2" Diameter 2" Length
Ambient Temperature	104° F (40° C)	104° F (40° C)

Understanding SMH Part Numbers				
1	2	3	4	5
Covers (Optional)	Front-Connected Part Number	Number of Poles	Arrangement Designator	Back-Connected
FRONT-CONNECTED C1 - Slotted, Opaque C3 - Slotted, Clear BACK-CONNECTED C2 - Solid, Opaque C4 - Solid, Clear G - Flush-Mounted w/Cover & Case Enclosure	4	01 - 10	This is the letter and/or number designation that has been assigned for a particular arrangement See catalog page 117, or visit our website at www.statesproducts.com for arrangement options	Add a -B for back-connection
*Although you can order 1, 2, & 3 pole switches either front-connected or back-connected, covers are not available for those size switch bases. Covers are only available for 4, 7, & 10 pole base sizes.				

EXAMPLES

<u>4</u> 2	<u>02</u> 3	-	<u>A</u> 4
---------------	----------------	---	---------------

Part No. 402-A
SMH 2 Pole Switch - Front-connected, no cover.

<u>C3</u> 1	-	<u>4</u> 2	<u>04</u> 3	-	<u>E</u> 4
----------------	---	---------------	----------------	---	---------------

Part No. C3-404-E
SMH 4 Pole Switch - Front-connected with a clear front-connected cover.













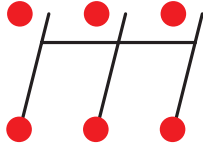

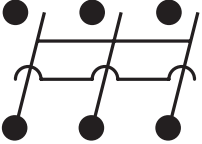
<u>C4</u> 1	-	<u>4</u> 2	<u>07</u> 3	-	<u>A</u> 4	-	<u>B</u> 5
----------------	---	---------------	----------------	---	---------------	---	---------------

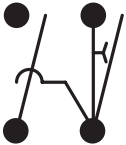
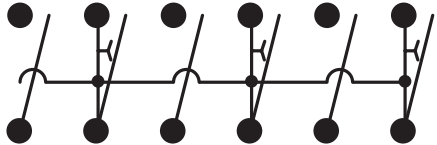
Part No. C4-407-A-B
SMH 7 Pole Switch - Back-connected with a clear back-connected cover.

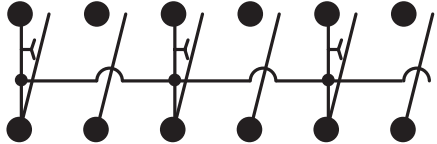
<u>G</u> 1	-	<u>4</u> 2	<u>10</u> 3	-	<u>E</u> 4
---------------	---	---------------	----------------	---	---------------

Part No. G-410-E
SMH 10 Pole Switch - Mounted in a case enclosure with back connections.

SMH SWITCH ELEMENTS

<p>35</p>  <p>Blank Space</p>	<p>42</p>  <p>Single-Pole Potential</p>	<p>62</p>  <p>Ganged Double-Pole Potential</p>	<p>78</p>  <p>Ganged Three-Pole Potential</p>
<p>44</p>  <p>Ganged Two-Pole Short-Circuiting Current Assembly</p>	<p>79</p>  <p>Ganged Three-Pole Short-Circuiting Current Assembly</p>	<p>61</p>  <p>Through Bar</p>	
<p>46</p>  <p>Right-Hand Current Assembly Consists of Test Jack and Short-Circuiting Current Assemblies</p>	<p>84</p>  <p>Three Interconnected Right-Hand Current Assemblies</p>		
<p>45</p>  <p>Left-Hand Current Assembly Consists of Test Jack and Short-Circuiting Current Assemblies</p>	<p>85</p>  <p>Three Interconnected Left-Hand Current Assemblies</p>		
<p>72</p>  <p>Current Test Jack</p>	<p>68</p>  <p>Current Test Jack With Left-Hand Common Bar</p>	<p>69</p>  <p>Current Test Jack With Right-Hand Common Bar</p>	<p>71</p>  <p>Short-Circuiting Assembly With Right-Hand Common Bar</p>
<p>70</p>  <p>Short-Circuiting Assembly With Left-Hand Common Bar</p>	<p>73</p>  <p>30-Amp Fuse Mounting Clips</p> <p>NOTES:</p> <ol style="list-style-type: none"> 1. Barriers are provided between poles of opposite polarity. 2. Potential handles are red and current handles are black unless otherwise specified. 3. Arrange elements left to right, front view. 4. Covers are only available on 4, 7 and 10 pole bases. 5. Element No. 73 accepts standard cartridge fuses rated 600 VAC 30 AMP. Fuse dimensions must be 1/2" diameter and 2" in length. (Fuses Not Included) 		

ORDERING INFORMATION

The part numbers under the arrangements beginning on page 117 are for front-connected switches without covers. These same numbers are also used as the basis for ordering back-connected and flush-mounted switches.

The part numbers are three digits followed by a letter or letter and number combination. **Example: 402-A**

42/42/



402-A

The slashes (/) in the arrangements represent barriers that are installed standard between any adjoining elements of opposite polarity.

SPECIAL ORDERS

Special Arrangements: These can be made of any combination of potential or current elements, with a maximum of 10 poles. For more information, refer to the following example and illustrations on Page 109.

Example: To order a unique switch in a back-connected version and with a clear back-connected cover, specify:

Switch Type: STATES Type SMH
No. of poles: 10-pole test switch
Arrangement*: /42/44/42/46/61/45/73/
Style: Back-connected
Cover: Clear, back-connected

***Arrangements should be given as frontview of switch, left to right, using the elements listed on page 110.**

Handle Colors: The standard colors for handles are **red** for **potential** and **black** for **current** handles are also available in other colors.

To specify non-standard colors, add to the element number the appropriate color code:

Color	Color Code
Black	k
Blue	b
Green	g
Orange	e
Red	r
White	w
Yellow	y
Brown	n

To order a switch with handles in non-standard colors, you must specify the arrangement with colors indicated. For example, to order a 4-pole switch with special handle colors, specify: **Arrangement: 71g/42/42b/68w**

STATES Type SMH Test Switches are available in literally thousands of configurations.

Ganged handles: You may specify a yoking bar to gang adjacent handles.

For example, to order a switch with the adjacent potentials ganged, you must specify: **Gang all potentials**

Ganged handles are represented with the number (#) sign.

Example: #42/42/42/42#/ (all handles in between the “#” are ganged together)

Hinge position: The “U” (next to an element) in an arrangement indicates the hinge is positioned upside down from the typical arrangement.

Bases: An 8- or 9-pole test switch is built on a 10-pole base. A 5-, 6-, or 7-pole test switch usually is built on a 7-pole base but can be provided on a 10-pole base if desired.

OPTIONAL ACCESSORIES



Socket Wrench and Insert

To speed installation of the terminal nuts on Type SMH Test Switches, the socket wrench (Part No. 16028) and 3/8 inch insert (Part No. 16027) are available. Pictures are available in the Testing Accessories section.

The screwdriver attachment (Part No. 16022) makes this wrench your complete meter installation tool.

Dual Circuit Plug

By inserting the STATES Dual Circuit Plug (Part No. 15000) into the test jack, safe measurement can be made of current transformer secondary current.

See Testing Accessories on page 128.



TYPICAL WIRING DIAGRAM

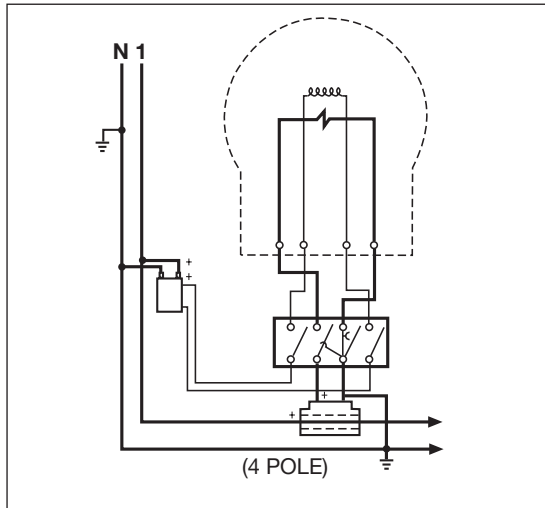

1 ϕ 2-Wire with CT and PT

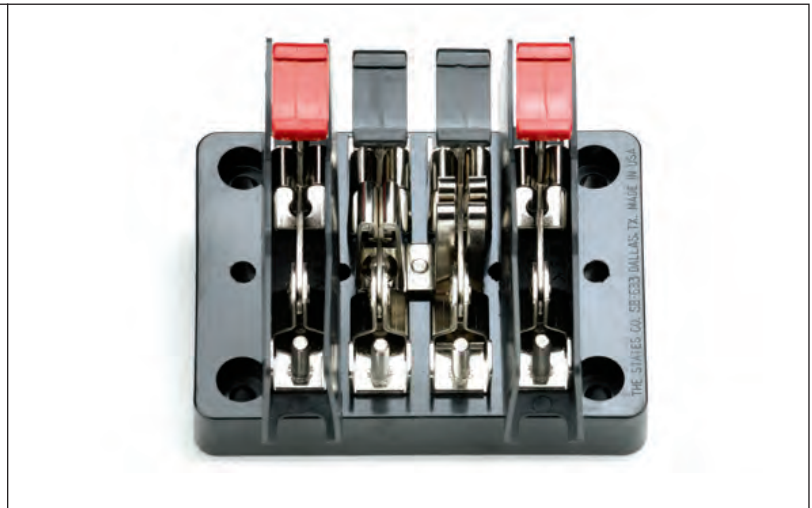

4-Pole Test Switch - Part No. 404-N (ARR:/42/46/42/)

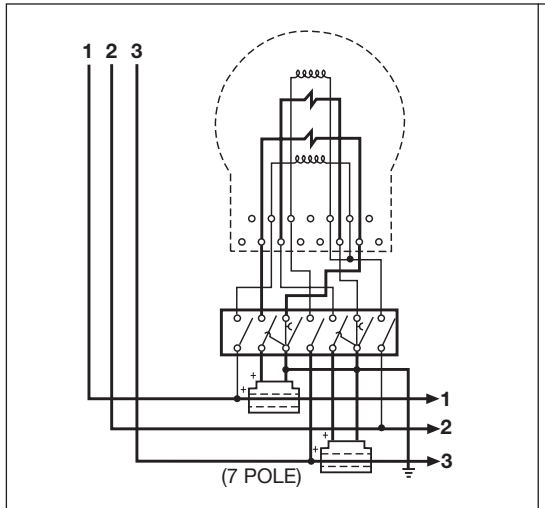

3 ϕ 3-Wire 2-Element



7-Pole Test Switch - Part No. 407-K (ARR: /42/46/42/46/42/)

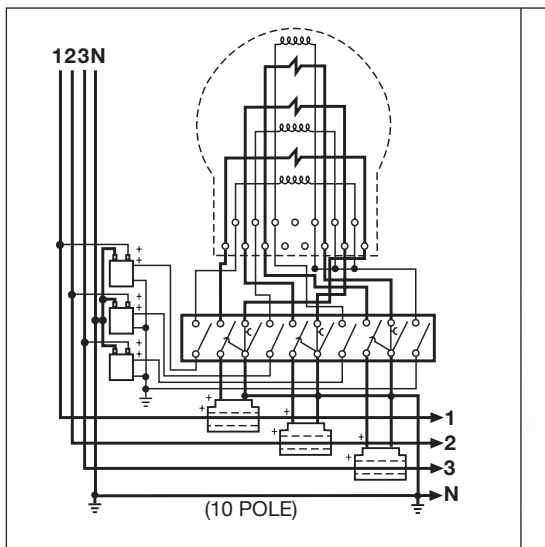

3 ϕ 4-Wire Y 3-Element

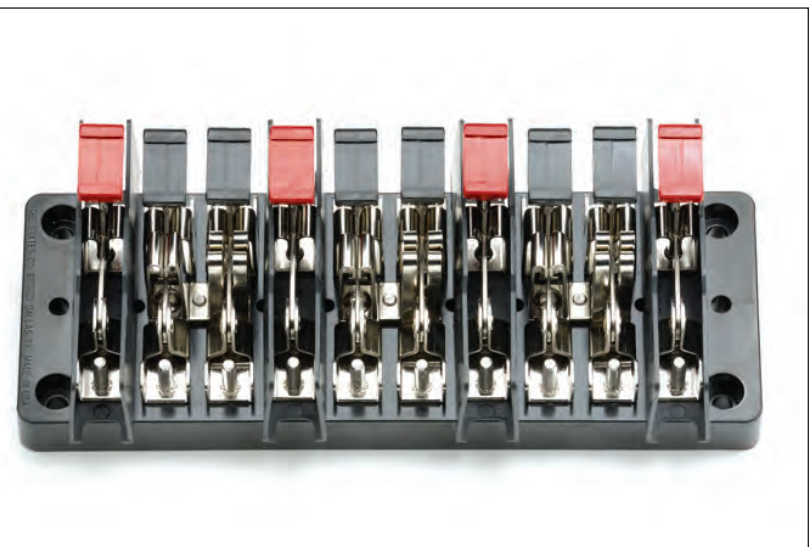

10-Pole Test Switch - Part No. 410-E (ARR: /42/46/42/46/42/46/42/)

SMH
Test Switches

**FRONT-CONNECTED SWITCHES
DIMENSIONS IN INCHES [MM]**

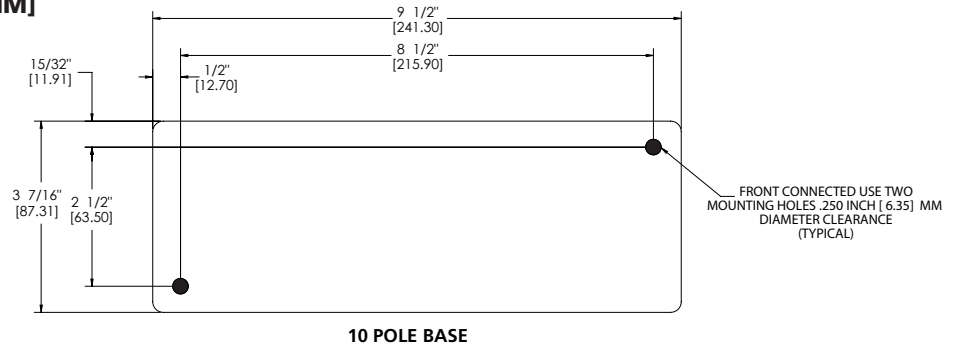

10 POLE BASE

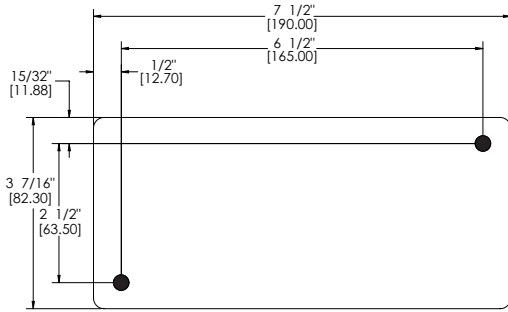

7 POLE BASE

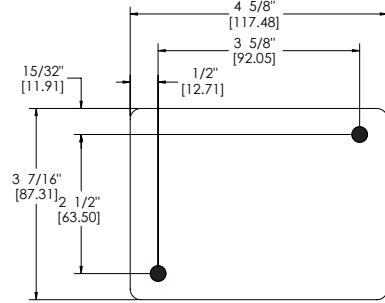

4 POLE BASE

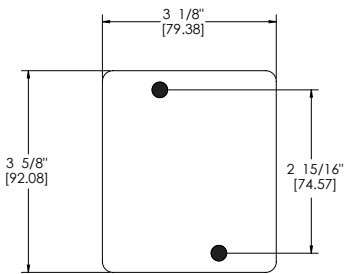

3 POLE BASE

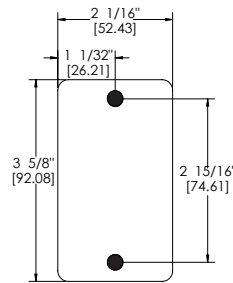

2 POLE BASE

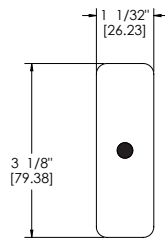

1 POLE BASE

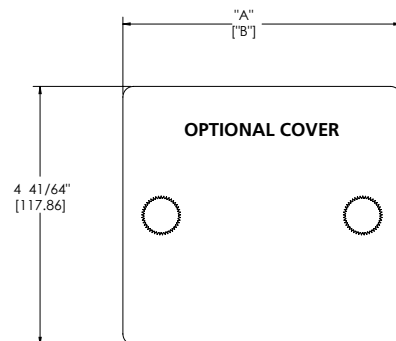
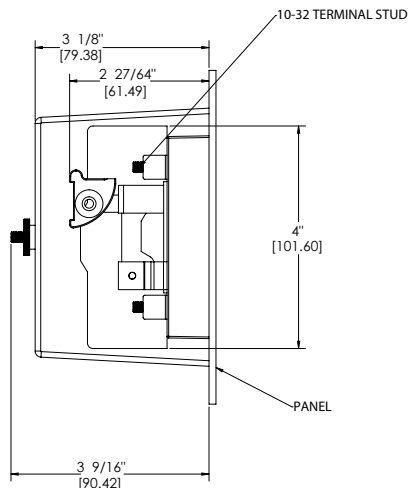

POLE	"A" DIMENSION	"B" DIMENSION
4	5 1/16"	[128.5]
7	7 15/16"	[201.6]
10	10 1/8"	[257.2]

SMH
Test Switches

BACK-CONNECTED SWITCHES DIMENSIONS IN INCHES [MM]

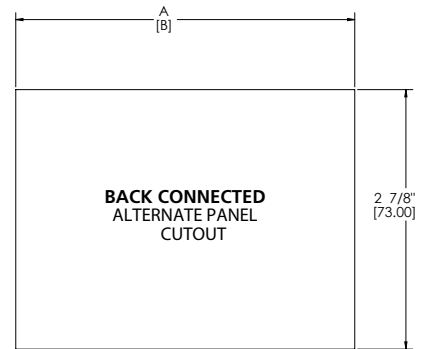
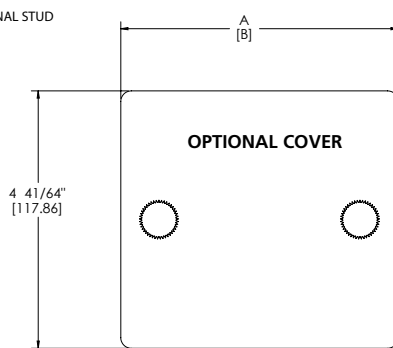
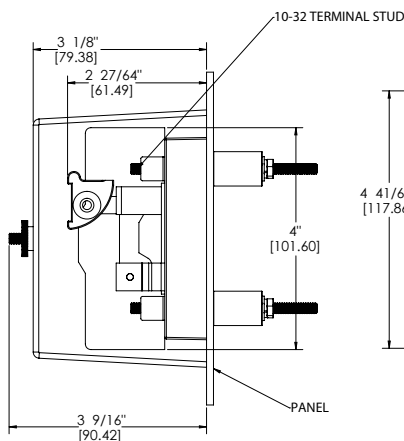
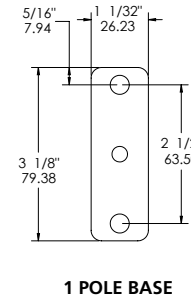
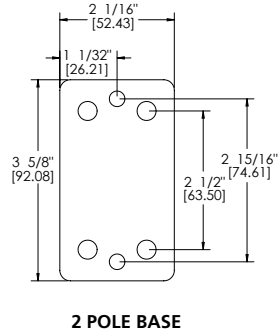
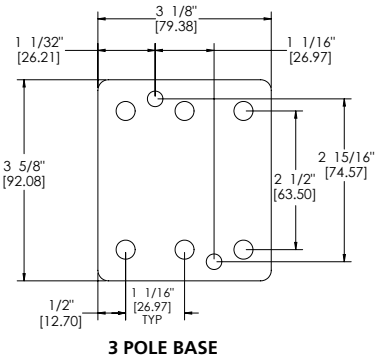
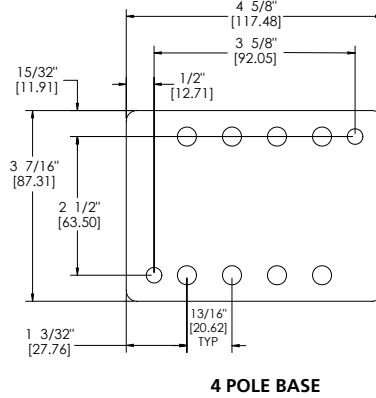
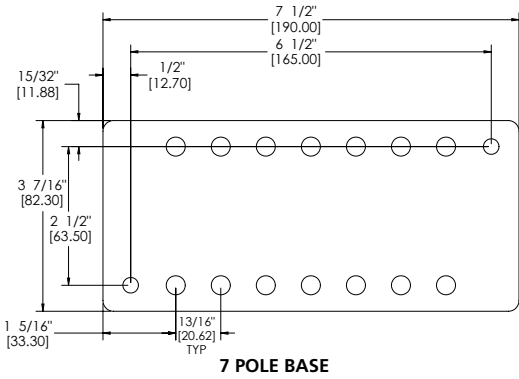
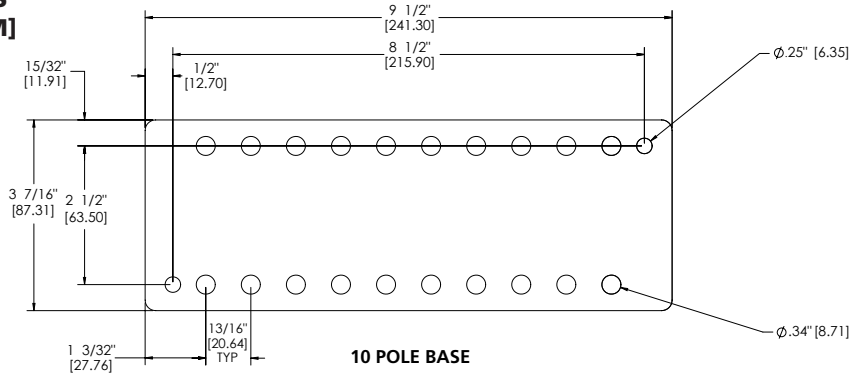

BACK CONNECTED
ALTERNATE PANEL
CUTOUT TABLE

POLE	"A" DIMENSION	"B" DIMENSION
4	5 1/16"	[128.6]
7	7 15/16"	[201.6]
10	10 1/8"	[257.2]

POLE	"A" DIMENSION	"B" DIMENSION
4	2 13/16"	[71.4]
7	5 1/4"	[133.35]
10	7 11/16"	[195.26]

SMH Test Switches

**FLUSH-MOUNTED SWITCHES
DIMENSIONS IN INCHES [MM]**

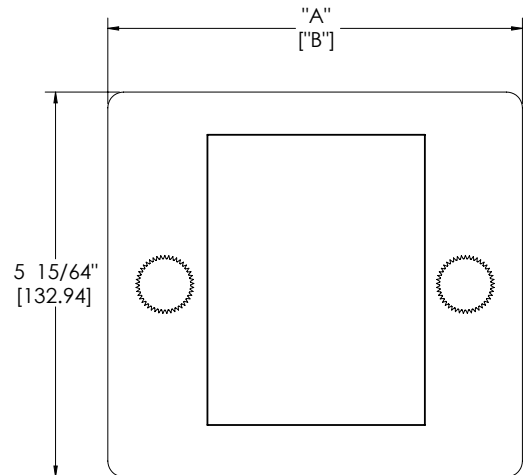
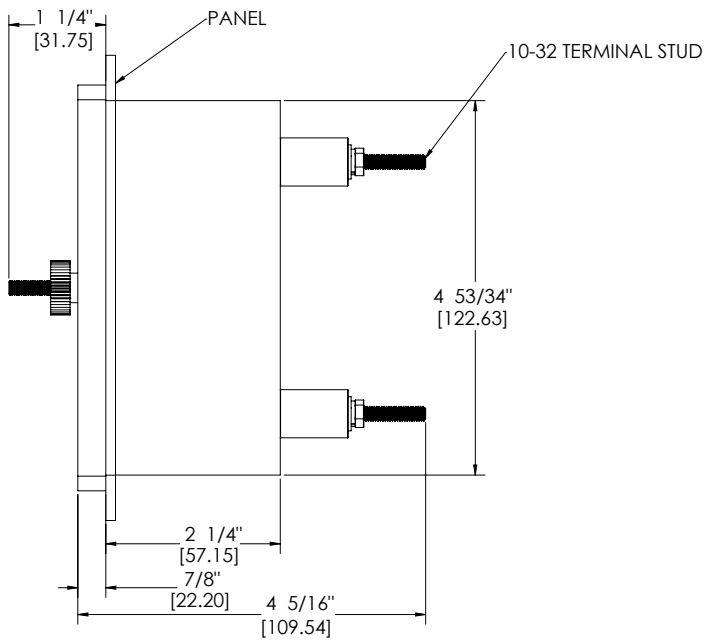
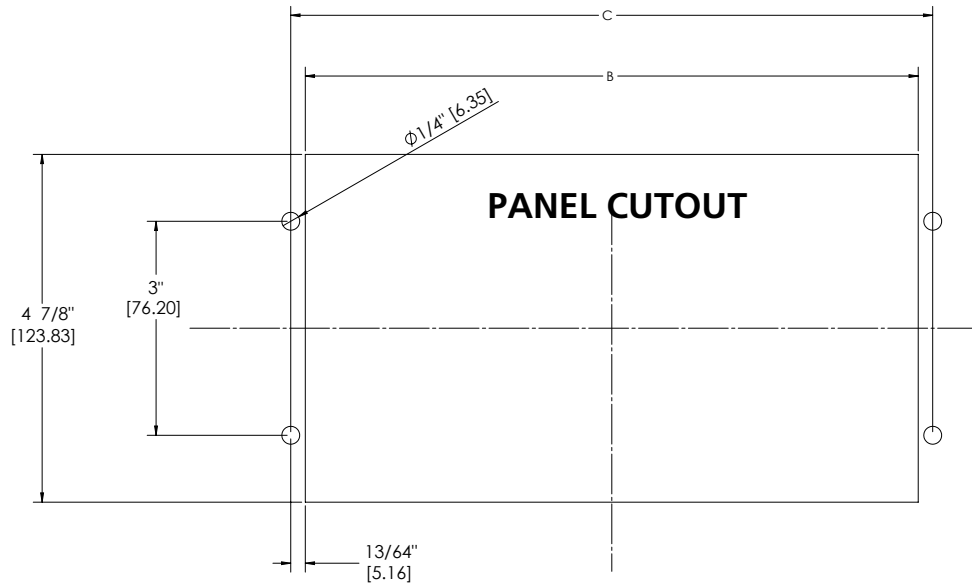

DIMENSIONS IN [] ARE IN MM , NO [] DIMENSIONS IN INCHES

BASE SIZE (POLES)	"A" DIMENSION	"B" DIMENSION	"C" DIMENSION
4	6 7/16" [163.5]	5 7/32" [132.5]	5 5/8" [142.9]
7	9 39/64" [244]	8 13/32" [213.5]	8 26/32" [223.8]
10	12 13/16" [325.4]	11 19/32" [294.5]	12 [304.8]

SMH
Test Switches

SMH ACCESSORIES

PART NUMBER	DESCRIPTION
SBM25-xx	Handle Ganging Kit - Replace the "xx" with the required number of adjacent poles to be ganged together (example: SBM-2 - 2 Pole Kit)
SB678-100	White Marker Handle Tags (100pcs per bag)
17191	2 Pole Hardware Kit
10547	4 Pole Hardware Kit
10548	7 Pole Hardware Kit
10549	10 Pole Hardware Kit
SMC1-4	4 Pole Front Connected Opaque Cover - includes cover, cover knobs and cover stud hardware
SMC2-4	4 Pole Back Connected Opaque Cover - includes cover, cover knobs and cover stud hardware
SMC3-4	4 Pole Front Connected Clear Cover - includes cover, cover knobs and cover stud hardware
SMC4-4	4 Pole Back Connected Clear Cover - includes cover, cover knobs and cover stud hardware
SMC1-7	7 Pole Front Connected Opaque Cover - includes cover, cover knobs and cover stud hardware
SMC2-7	7 Pole Back Connected Opaque Cover - includes cover, cover knobs and cover stud hardware
SMC3-7	7 Pole Front Connected Clear Cover - includes cover, cover knobs and cover stud hardware
SMC4-7	7 Pole Back Connected Clear Cover - includes cover, cover knobs and cover stud hardware
SMC1-10	10 Pole Front Connected Opaque Cover - includes cover, cover knobs and cover stud hardware
SMC2-10	10 Pole Back Connected Opaque Cover - includes cover, cover knobs and cover stud hardware
SMC3-10	10 Pole Front Connected Clear Cover - includes cover, cover knobs and cover stud hardware
SMC4-10	10 Pole Back Connected Clear Cover - includes cover, cover knobs and cover stud hardware

Please refer to our website for accessory pictures

**FRONT VIEW
1-POLE**

42



401-A (1-Pole Base)

Color Option: 42Y
401-D
(1-Pole Base)

72



401-B (1-Pole Base)

73



401-C (1-Pole Base)

Other 1-Pole
Standard Arrangements:
/42/
401-G (1-Pole Base)
72-35
401-F (2-Pole Base)

2-POLE

42/42/



402-A (2-Pole Base)

72-72



402-B (2-Pole Base)

73/73/



402-C (2-Pole Base)

62



402-D (2-Pole Base)

2-POLE (CONT.)

44



402-E (2-Pole Base)

45



402-F (2-Pole Base)

46



402-G (2-Pole Base)

Other 2-Pole
Standard Arrangements:
35-44-35
402-N (4-Pole Base)

35-45-35
402-S (4-Pole Base)

35-46-35
402-J (4-Pole Base)

35-62/35
402-Y (4-Pole Base)

42-35-42
402-T (3-Pole Base)

42-35-42
402-U (3-Pole Base)

42-35-42-35
402-M (4-Pole Base)

42-35-42-35
402-P (4-Pole Base)

42-42
402-Q (2-Pole Base)

42-42
402-R (2-Pole Base)

/62/
402-W (2-Pole Base)

3-POLE

42/42/42-35

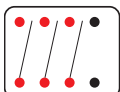

403-A (4-Pole Base)

Color Option:
42Y/42Y/42Y-35
403-M (4-Pole Base)

72-72-72-35

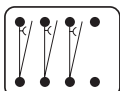

403-B (4-Pole Base)

3-POLE (CONT.)

73/73/73-35

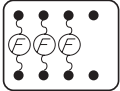

403-C (4-Pole Base)

78-35

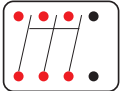

403-D (4-Pole Base)

79-35

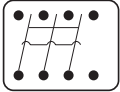

403-E (4-Pole Base)

77-61-35

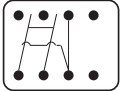

403-F (4-Pole Base)

42-35-46

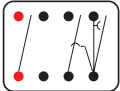

403-G (4-Pole Base)

44/42/35

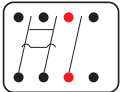

403-H (4-Pole Base)

/42/44-35

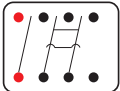

403-J (4-Pole Base)

46/42/35

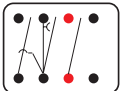

403-K (4-Pole Base)

/42/46



403-S (3-Pole Base)

Other 3-Pole
Standard Arrangements:

#42-42-42#
403-N (3-Pole Base)

42Y/42Y/42Y
403-P (3-Pole Base)

42/42/42
403-T (3-Pole Base)

42-42-42
403-V (3-Pole Base)

42-46
403-R (3-Pole Base)

78
403-U (3-Pole Base)

79
403-Q (3-Pole Base)

4-POLE

42/42/42/42/



404-A

42/42K/35-35-35-45RWRK

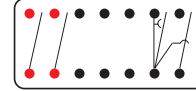

404-AA (7-Pole Base)

35-46RW-35/42R/42W/35

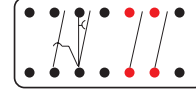

404-AB (7-Pole Base)

35-42-35-35-42-35-35-46-35

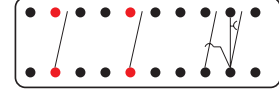

404-AC (10-Pole Base)

35-42-35-35-46-35-35-42-35

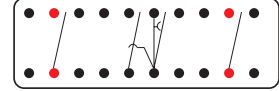

404-AD (10-Pole Base)

35/42/35-35-44-35-35/42/35

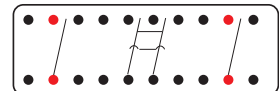

404-AE (10-Pole Base)

SMH
Test Switches

FRONT VIEW

4-POLE (CONT.)

35-46-35-35-35-35-46-35

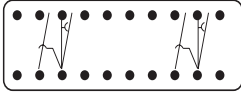

404-AF (10-Pole Base)

72-72-72-72

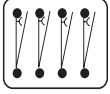

404-B

73/73/73/73/

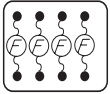

404-C

/62/62/

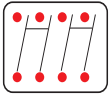

404-D

Color Option:

**/62RK/62RK/
404-AR**

#42/42/42/42/#

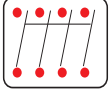

404-E

42/42/46

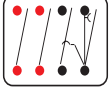

404-F

46/62

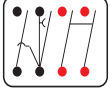

404-G

44-44

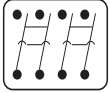

404-H

42/42/45



404-J

4-POLE (CONT.)

46/42/42

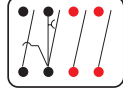

404-K

/42/44/42



404-L

44/42/42

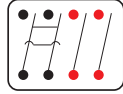

404-M

/42/46/42/

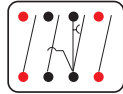

404-N

45-46

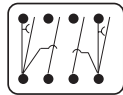

404-P

42/42/44



404-Q

81-61

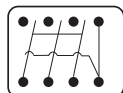

404-R

71-71-71-70

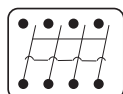

404-S

Other 4-Pole
Standard Arrangements:

35-35/42/46/42/35
404-AP

35-35-69/42/42/70-35
404-AH

42-35-42-35-35-45
404-AK

42-35-42-35-35-46
404-AL (7-Pole Base)

4-POLE (CONT.)

42-35-46-35-42-35
404-AG (7-Pole Base)

42-42-42-42
404-AZ

46-45
404-AY

69/42/42/70
404-Y

71G/42/42B/68W
404-X

72-35-72-35-72-35-72
404-AJ (7-Pole Base)

5-POLE

35-42/42/42/42/42-35

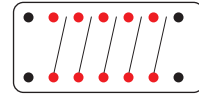

405-A

35-72-72-72-72-72-35

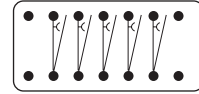

405-B

35-73/73/73/73/73-35

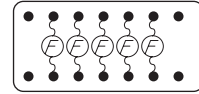

405-C

35/42/46/42/42-35



405-D

35/42/42/42/44-35



405-E

35-46/42/46-35

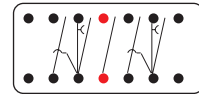

405-F

FRONT VIEW

5-POLE (CONT.)

35-45/42/46-35

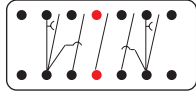

405-G

35-42/42/78-35

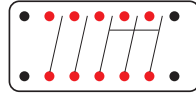

405-H

35-72/72/72/72/61-35

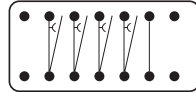

405-J

42-35-42-35-44-61

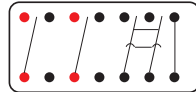

405-K

35/42/46-45-35

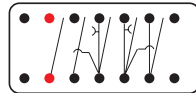

405-L

35-44/78/35

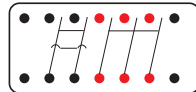

405-M

35/42/42/42/46-35



405-N

35-42/42/46/42/35

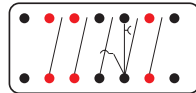

405-P

Other 5-Pole

Standard Arrangements:

35-72/72/72/72/72-35

405-U (7-Pole Base)

35-71-71-71-71-61-35

405-Y (7-Pole Base)

42-35-35-46-45

405-S (7-Pole Base)

5-POLE (CONT.)

42-35-42/42/42-35-42

405-V (7-Pole Base)

44-35-35-35-42-35-42-35-42

405-T (10-Pole Base)

6-POLE

42/42/42/42/42/42/35

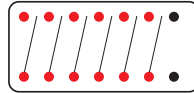

406-A

72-72-72-72-72-72-35

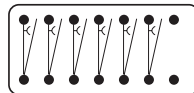

406-B

73/73/73/73/73/73/35

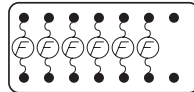

406-C

62/62/62/35

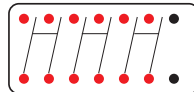

406-D

78/78/35

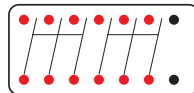

406-E

/42/42/42/46/42/35

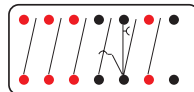

406-F

/42/46-46/42/35

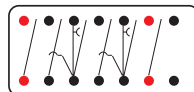

406-G

/42/44-44/42/35

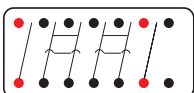

406-H

6-POLE (CONT.)

42/42/46-46-35

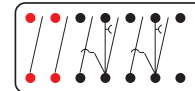

406-J

45-45-45-35

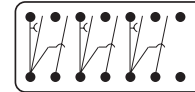

406-K

46-46-46-35

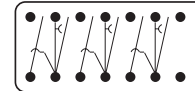

406-L

42/42/44-44-35

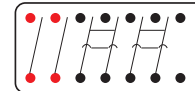

406-M

44-44-44-35

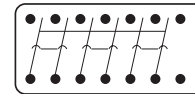

406-N

69-71-69-71-69-70-35

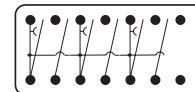

406-P

Other 6-Pole

Standard Arrangements:

/42/35-46-35-35-45-35/42/

406-T (10-Pole Base)

/42/46-35-46/42/

406-AB (7-Pole Base)

7-POLE

42/42/42/42/42/42/42

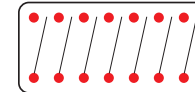

407-A

72-72-72-72-72-72-72

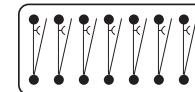

407-B

FRONT VIEW 7-POLE (CONT.)

73/73/73/73/73/73/73

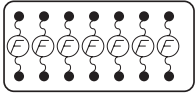

407-C

/42/44/42/44/42/

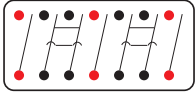

407-D

/42/42/42/46-45



407-E

42/42/46/42/42/42/

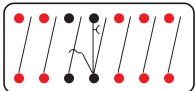

407-F

/42/46/42/42/42/42

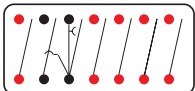

407-G

42/42/42/42/46/42



407-H

78/46-46



407-J

/42/46/42/46/42/

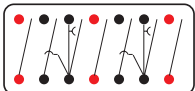

407-K

44-44-44-72

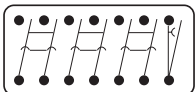

407-L

/42/46/42/45/42/

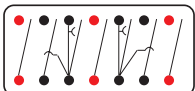

407-M

7-POLE (CONT.)

/42/42/42/46-46



407-N

35-81-61-80-35-35

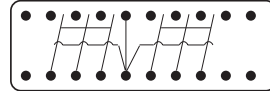

407-Q (10-Pole Base)

44-44-35/42/35/42/35/42/

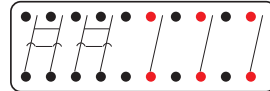

407-AA (10-Pole Base)

/42/35-46-35/42/35-46/42/

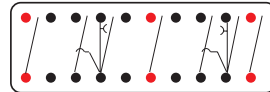

407-P (10-Pole Base)

73-35-73-35-73-35-46-46

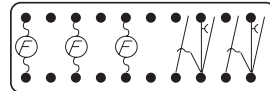

407-AC (10-Pole Base)

/42/35/42/35/42/35-46-46

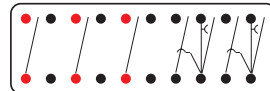

407-T (10-Pole Base)

42-35-44-35-42-35-44/42/

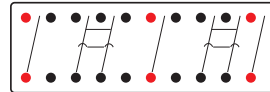

407-U (10-Pole Base)

Other 7-Pole
Standard Arrangements:

42-35-42-35-42-35-46-45

407-AF (10-Pole Base)

/42/35-44-35/42/35-44/42/

407-AS (10-Pole Base)

42-35-46-35-42-35-45/42/

407-AD (10-Pole Base)

/42/42W/42K/46EG-46BG

407-AE

79-61/78

407-AB

8-POLE

35-42/42/42/42/42/42/42/35

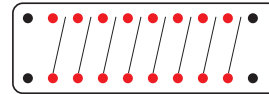

408-A

35-72-72-72-72-72-72-35

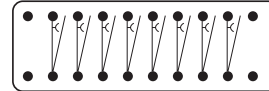

408-B

35-73/73/73/73/73/73/73/35

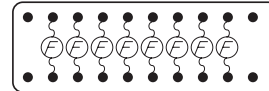

408-C

35/42/46/42/42/46/42/35

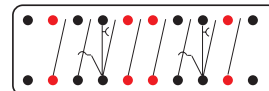

408-D

35/42/42/42/46/42/42/35

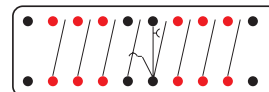

408-E

35-42/42/42/61/44-44-35



408-F

35-42/42/42/46-46-35



408-G

35/42/44/42/42/44/42/35

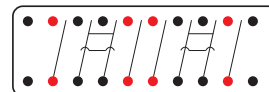

408-H

SMH
Test Switches

Color Key: k: Black b: Blue g: Green e: Orange r: Red w: White n: Brown y: Yellow

FRONT VIEW - 8-POLE (CONT.)

35-42/42/42/42/44-44-35

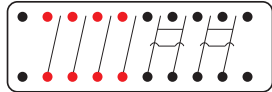

408-J

35/42/46-46-46/42/35

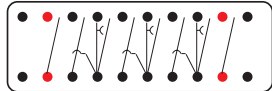

408-K

35-46-46-46/42/42-35

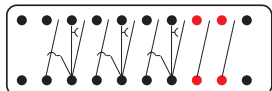

408-L

35/42/44-44-44/42/35

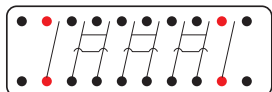

408-M

35-44-44-44/42/42-35

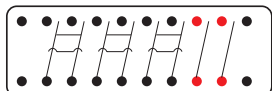

408-N

35-46-46-46-35

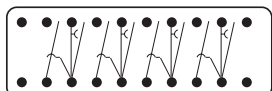

408-P

35/42/42/42/44/42/42/42/35



408-Q

35-42/42/42/42/42/42/44-35

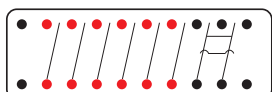

408-R

35-42/42/42/42/46-45-35

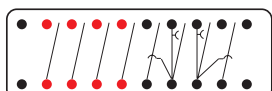

408-S

35-42/42/42/61/46-45-35

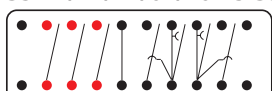

408-T

8-POLE (CONT.)

35-46-46/42/42/42/42-35

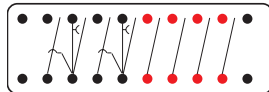

408-U

35-44-44-44-35

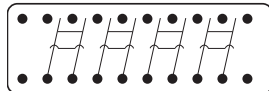

408-W

9-POLE

42/42/42/42/42/42/42/42/42-35

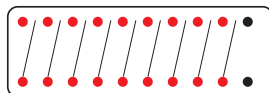

409-A

72-72-72-72-72-72-72-72-35

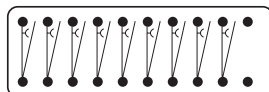

409-B

73/73/73/73/73/73/73/73-35

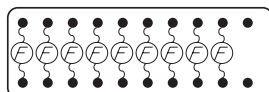

409-C

/42/42/42/44-44-44-35

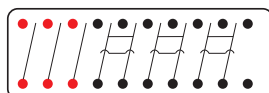

409-D

/78/46-46-46-35

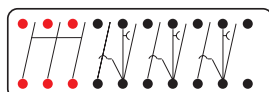

409-E

/42/42/61/46-46-46-35

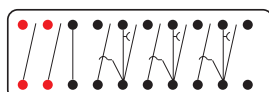

409-F

78/78/78-35

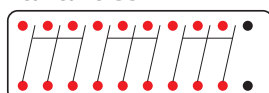

409-G

9-POLE (CONT.)

/42/44/42/44/42/44-35

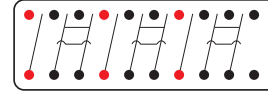

409-H

77-77-77-77-61-35

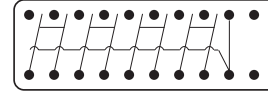

409-J

/42/46/42/46/42/46-35



409-K

42/42/42-35-69-71-69-71-69-70

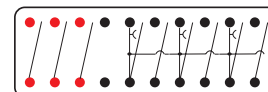

409-L

/42/42/61-35-69-71-69-71-69-70

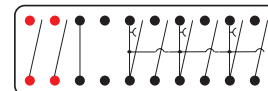

409-M

/42/42/42/35-45-45-45

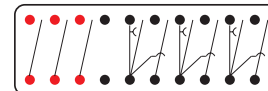

409-N

/42/42/42/35-46-46-46

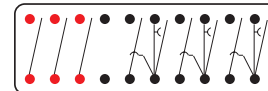

409-P

Other 9-Pole
Standard Arrangement:
/42/42/61/35-45-45-45
409-S

SMH
Test Switches

Color Key: k: Black b: Blue g: Green e: Orange r: Red w: White n: Brown y: Yellow

SMH Test Switches

FRONT VIEW - 10-POLE

42/42/42/42/42/42/42/42/42/42/

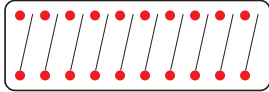

410-A

/42K/42G/42/61-46-46G-46R

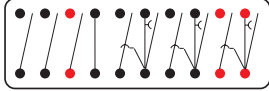

410-A1

72-72-72-72-72-72-72-72-72-72/

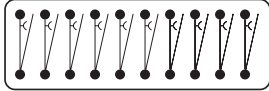

410-B

73/73/73/73/73/73/73/73/73/73/

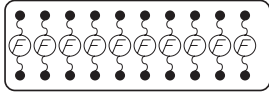

410-C

/42/42/42/46/42/42/46/42/

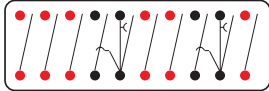

410-D

/42/46/42/46/42/46/42/

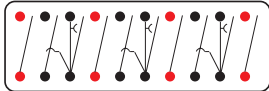

410-E

/42/46/42/42/42/42/46/42/

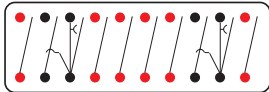

410-F

/42/44/42/44/42/44/42/



410-G

42/42/42/42/46-46-46

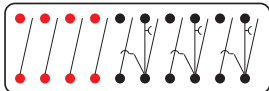

410-H

/42/42/42/46-46-46/42/

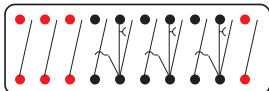

410-J

10-POLE (CONT.)

/42/46-46-46-46-/42/

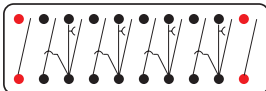

410-K

46-46-46-46/42/42

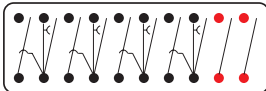

410-L

46-46-46-46-46

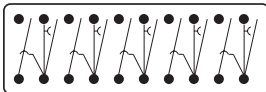

410-M

44-44-44-44-44

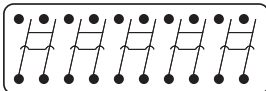

410-N

44-44-44/42/42/42/61/

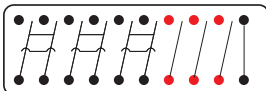

410-P

/42/42/42/42/42/42/42/46/42/

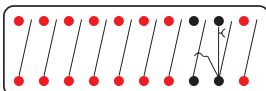

410-Q

/42/42/42/42/42/46-46/42/

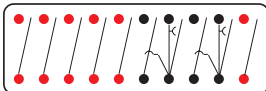

410-R

42/42/42/42/45-45-45

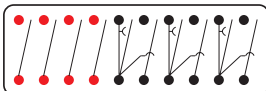

410-S

42/42/42/61/44-44-44

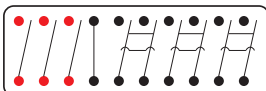

410-T

42/42/42/42/71-69-71-69-71-72

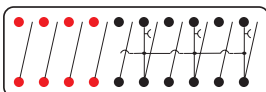

410-U

10-POLE (CONT.)

42/42/42/61/69-71-69-71-69-70

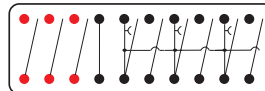

410-V

42/42/42/61/71-69-71-69-71-72

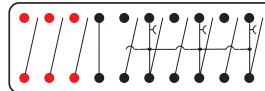

410-W

42/42/42/42/69-71-69-71-69-70

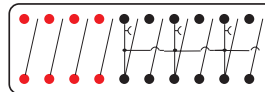

410-X

71/42/71/42/71/42/42/69-69-72

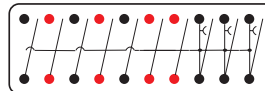

410-Y

42/42/42/61/45-45-45

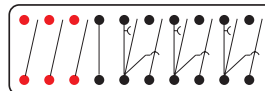

410-Z

Other 10-Pole
Standard Arrangements:

42/42/42/61/46-46-46
410-T1

/42/46/42/46/42/71-69-42
410-Z1

50/50/50/50/50
410-B5

73/73/73/61/46-46-46
410-D7

Please refer to the STATES website
for more part numbers and up to date
information.

SMH
Test Switches

Color Key: k: Black b: Blue g: Green e: Orange r: Red w: White n: Brown y: Yellow

DTE

Test Switches

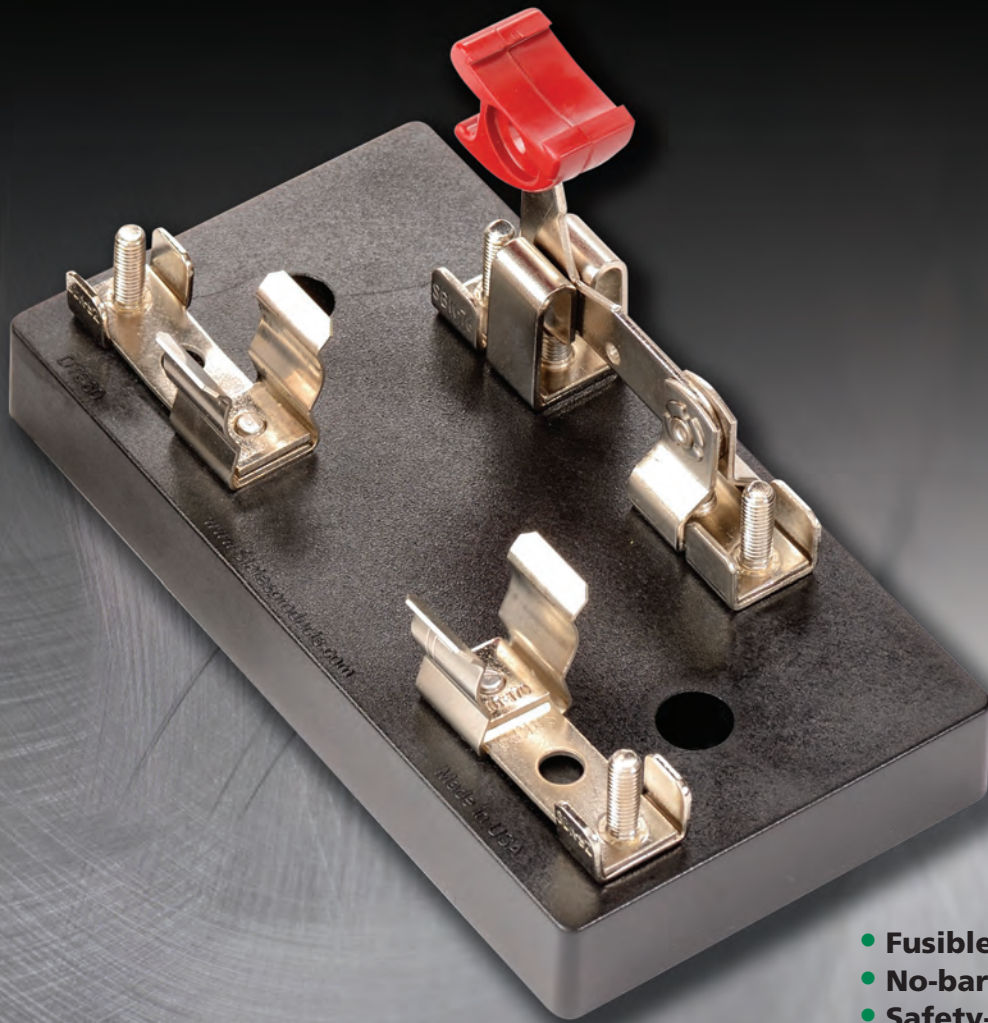

- Fusible switch
- No-barrier design
- Safety-grip handle

STATES®

The STATES DTE Test Switches are a single pole fusible knife blade switch for testing applications where overcurrent protection is required. These are available with different color handles to meet your specifications.

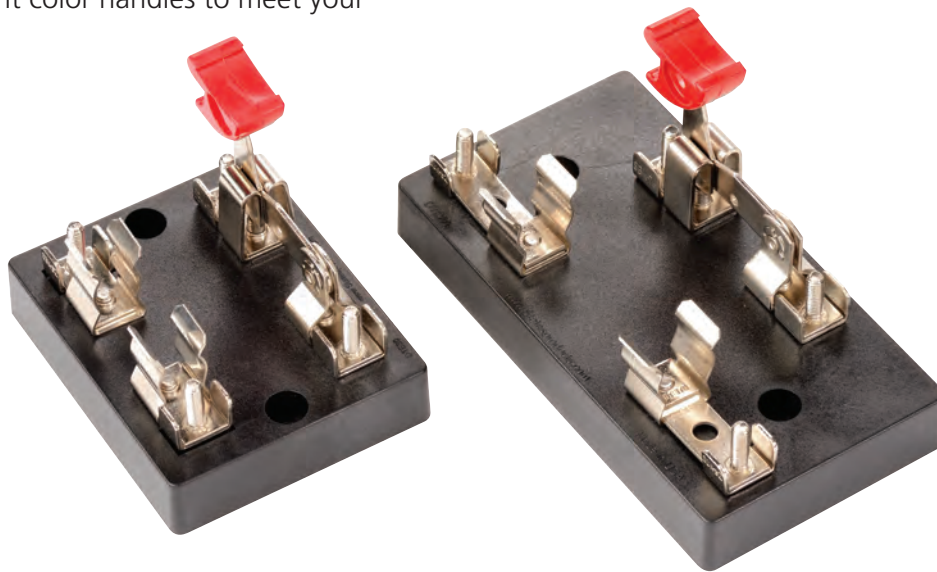

SPECIFICATIONS

DTE TEST SWITCH TECHNICAL SPECIFICATIONS	
DTE30	Fusible Test Switch
Voltage Rating	600VAC
Current Rating	30A
Recommended Wire Size Range	Min 14awg / Max 10awg
Recommended Wire Lug Size	#10
Stud Thread	10-32
Recommended Torque for Stud Wiring Connections	Max 25in/lbs
Fuse Clip Rating	30A
Fuse Clip Dimensions - 250 VAC 30 Amp *Fuse Not Included	1/2" Diameter 2" Length
Ambient Temperature	104° F (40° C)
#42	Single Potential Switch Element
DTE60	Fusible Test Switch
Voltage Rating	600VAC
Current Rating	60A
Recommended Wire Size Range	Min 14awg / Max 10awg
Recommended Wire Lug Size	#10
Stud Thread	10-32
Recommended Torque for Stud Wiring Connections	Max 25in/lbs
Fuse Clip Rating	60A
Fuse Clip Dimensions - 600 VAC 60 Amp *Fuse Not Included	3/4" Diameter 3" Length
Ambient Temperature	104° F (40° C)
#42	Single Potential Switch Element

ORDERING INFORMATION

Part No. DTE30

DTE 2 Pole ARR: #42 with a 30 amp fuse holder (red potential handle)

Part No. DTE30K

DTE 2 Pole ARR: #42K with a 30 amp fuse holder (black potential handle)

Part No. DTE30B

DTE 2 Pole ARR: #42B with a 30 amp fuse holder (blue potential handle)

Part No. DTE30G

DTE 2 Pole ARR: #42G with a 30 amp fuse holder (green potential handle)

Part No. DTE30E

DTE 2 Pole ARR: #42E with a 30 amp fuse holder (orange potential handle)

Part No. DTE30W

DTE 2 Pole ARR: #42W with a 30 amp fuse holder (white potential handle)

Part No. DTE30N

DTE 2 Pole ARR: #42N with a 30 amp fuse holder (brown potential handle)

Part No. DTE30Y

DTE 2 Pole ARR: #42Y with a 30 amp fuse holder (yellow potential handle)

Part No. DTE60

DTE 2 Pole ARR: #42 with a 60 amp fuse holder (red potential handle)

Part No. DTE60K

DTE 2 Pole ARR: #42K with a 60 amp fuse holder (black potential handle)

Part No. DTE60B

DTE 2 Pole ARR: #42B with a 60 amp fuse holder (blue potential handle)

Part No. DTE60G

DTE 2 Pole ARR: #42G with a 60 amp fuse holder (green potential handle)

Part No. DTE60E

DTE 2 Pole ARR: #42E with a 60 amp fuse holder (orange potential handle)

Part No. DTE60W

DTE 2 Pole ARR: #42W with a 60 amp fuse holder (white potential handle)

Part No. DTE60N

DTE 2 Pole ARR: #42N with a 60 amp fuse holder (brown potential handle)

Part No. DTE60Y

DTE 2 Pole ARR: #42Y with a 60 amp fuse holder (yellow potential handle)

FUSE NOT INCLUDED

FUSE NOT INCLUDED

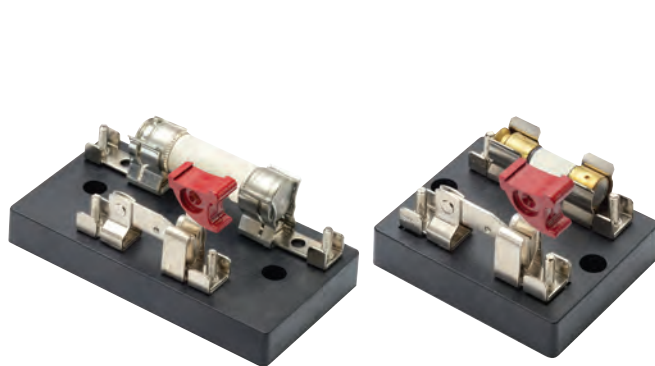

DTE60 (on left) DTE30 (on right) shown with fuses

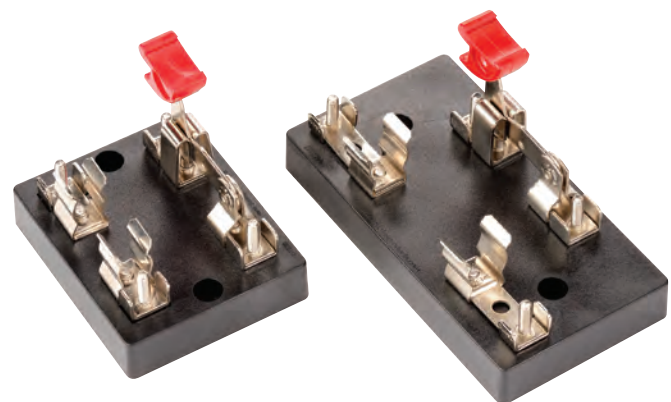

DTE30 (on left) DTE60 (on right) without fuses

Covers are not available for these switches.

DTE30 BASE
DIMENSIONS IN INCHES [MM]

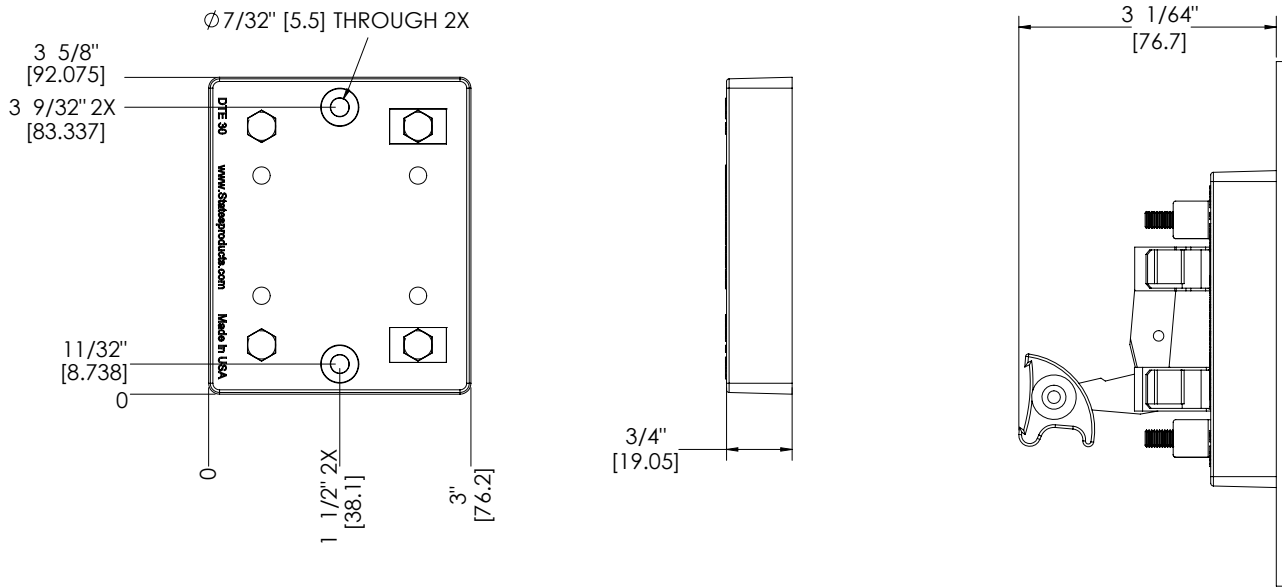

DTE60 BASE
DIMENSIONS IN INCHES [MM]

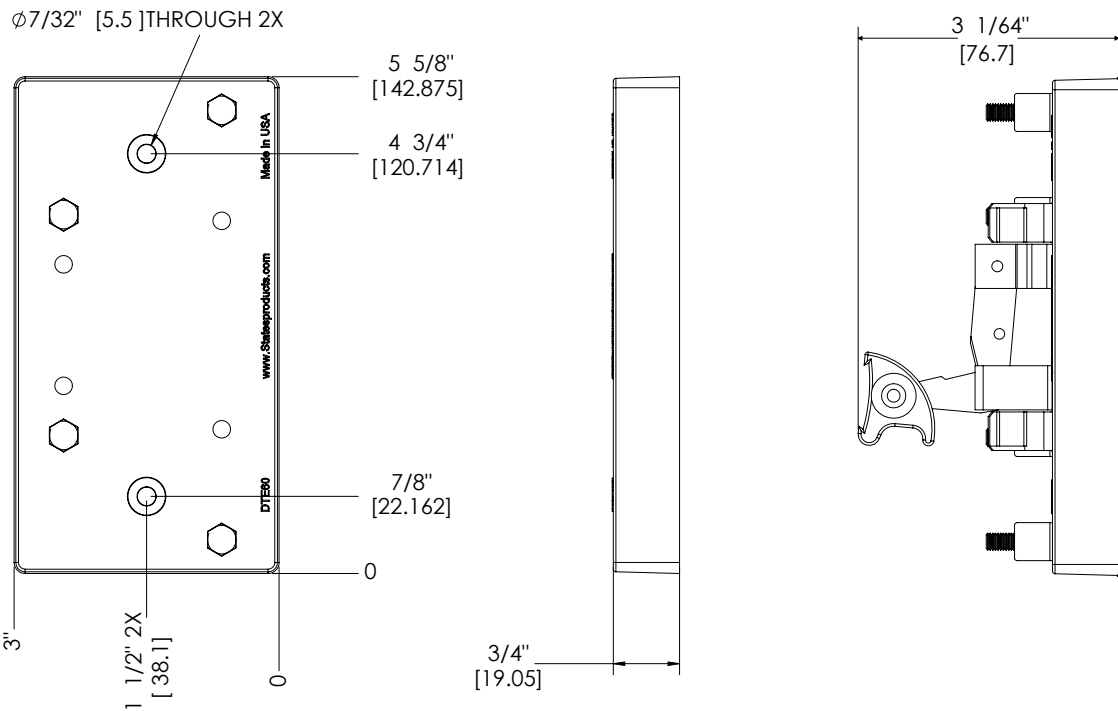

DTE
Test Switches

Testing Accessories



STATES®

TEST PADDLES

The 10 and 14 pole potential test paddles are feature packed and have been designed to make a test technician's job easier.

Handle – use one hand to connect to test switch

Labeled – locate connector to corresponding switch

Use for STATES FMS Test Switch and most competitor 10 pole switches.

Part No. V1TP10 - 10 Pole Test Paddle

Part No. FTP14 - 14 Pole Test Paddle

The FTP14 is only compatible with the STATES FMS 14 pole test switches.



10 Pole Test Paddle



10-32 Thread Stud

The TPA10 Test Paddle Attachment gives you more ways to connect when using the STATES FTP10, 10 Pole Test Paddle, for testing.

Part No. TPA10 - 10 Pole Test Paddle Attachment



Part No. 677099 - Test Paddle Knobs



Test Paddle Knob with brass insert includes a test jack receptacle that accommodates both banana and safety plugs on top and a 10-32 thread on the bottom to accommodate lug adapters.



14 Pole Test Paddle

The STATES V1TP10 & FTP14 are now UL recognized components with UL File No. E469997

FMS 10 POLE TEST LEAD KIT



This kit can be used with STATES FMS 10 Pole Test Switches as well as many competitor 10 pole test switches.

To order the kit above, please use Part No. FTPKIT-V1

Part No. FTPKIT-V1 contains the following

Item	Part No.	Description	QTY
A	V1TP10	FMS 10 Pole Potential Test Paddle	1
B	150LS	I PROBE - (15000) Leads W/Red and Black Lugs	1
C	620088	*15923 - Test lead, red, 6 mm dia., 150 cm long, use with current outputs (up to 30 Amps) CAT II Insulation *15924 - Test lead, black, 6 mm dia., 150 cm long, use with current outputs (up to 30 Amps) CAT II Insulation *We do not sell the 15923 and 15924 individually, only combined/twisted into Part No. 620088.	1
D	684025	Test lead, red, 200 cm long, use with voltage / current (up to 15 Amps) and timer, CAT II insulation	1
D	684026	Test lead, black, 200 cm long, use with voltage / current (up to 15 Amps) outputs and timer, CAT II insulation	1
E	684027	Lug adapter, red, 6.2 mm, use with voltage / current (up to 30 Amps) outputs and timer, CAT II Insulation	1
E	684028	Lug adapter, black, 6.2 mm, use with voltage / current (up to 30 Amps) outputs and timer, CAT II Insulation	1
F	684029	Lug adapter, red, 4.1 mm, use with voltage / current (up to 20 Amps) outputs and timer, CAT II Insulation	1
F	684030	Lug adapter, black, 4.1 mm, use with voltage / current (up to 20 Amps) outputs and timer, CAT II Insulation	1

FMS 10 POLE TEST LEAD KIT WITH ATTACHMENT



This kit can be used with STATES FMS 10 Pole Test Switches as well as many competitor 10 pole test switches.

To order the kit above, please use Part No. CV1TPKIT

Part No. CV1TPKIT contains the following

Item	Part No.	Description	QTY
A	V1TP10	FMS 10 Pole Potential Test Paddle	1
B	150LS	I PROBE - (15000) Leads W/Red and Black Lugs	1
C	620088	*15923 - Test lead, red, 6 mm dia., 150 cm long, use with current outputs (up to 30 Amps) CAT II Insulation *15924 - Test lead, black, 6 mm dia., 150 cm long, use with current outputs (up to 30 Amps) CAT II Insulation *We do not sell the 15923 and 15924 individually, only combined/twisted into Part No. 620088.	1
D	684025	Test lead, red, 200 cm long, use with voltage / current (up to 15 Amps) and timer, CAT II insulation	1
D	684026	Test lead, black, 200 cm long, use with voltage / current (up to 15 Amps) outputs and timer, CAT II insulation	1
E	684027	Lug adapter, red, 6.2 mm, use with voltage / current (up to 30 Amps) outputs and timer, CAT II Insulation	1
E	684028	Lug adapter, black, 6.2 mm, use with voltage / current (up to 30 Amps) outputs and timer, CAT II Insulation	1
F	684029	Lug adapter, red, 4.1 mm, use with voltage / current (up to 20 Amps) outputs and timer, CAT II Insulation	1
F	684030	Lug adapter, black, 4.1 mm, use with voltage / current (up to 20 Amps) outputs and timer, CAT II Insulation	1
G	TPA10	Test paddle attachment	1
H	DK-41	Black ABS plastic 3/4 10-32 knurled knob w/brass insert	10

FMS 14 POLE TEST LEAD KIT



This kit can be used with STATES FMS 14 Pole Test Switches.

To order the kit above, please use Part No. FTPKIT14

Part No. FTPKIT14 contains the following

Item	Part No.	Description	QTY
A	FTP14	FMS 14 Pole Potential Test Paddle	1
B	150LS	I PROBE - (15000) Leads W/Red and Black Lugs	1
C	620088	*15923 - Test lead, red, 6 mm dia., 150 cm long, use with current outputs (up to 30 Amps) CAT II Insulation *15924 - Test lead, black, 6 mm dia., 150 cm long, use with current outputs (up to 30 Amps) CAT II Insulation *We do not sell the 15923 and 15924 individually, only combined/twisted into Part No. 620088.	1
D	684025	Test lead, red, 200 cm long, use with voltage / current (up to 15 Amps) and timer, CAT II insulation	1
D	684026	Test lead, black, 200 cm long, use with voltage / current (up to 15 Amps) outputs and timer, CAT II insulation	1
E	684027	Lug adapter, red, 6.2 mm, use with voltage / current (up to 30 Amps) outputs and timer, CAT II Insulation	1
E	684028	Lug adapter, black, 6.2 mm, use with voltage / current (up to 30 Amps) outputs and timer, CAT II Insulation	1
F	684029	Lug adapter, red, 4.1 mm, use with voltage / current (up to 20 Amps) outputs and timer, CAT II Insulation	1
F	684030	Lug adapter, black, 4.1 mm, use with voltage / current (up to 20 Amps) outputs and timer, CAT II Insulation	1

V1AT10 TEST PADDLE ATTACHMENT KIT

Part No. V1AT10

Consists of one V1TP10 test paddle, one TPA10, and 10pcs DK-41 black knobs. (Green paddle knobs are not included in this kit).

All items can also be sold separately.



BINDING POST

PHENOLIC HEAD BINDING POST

Part No. 40091B (black)

The body is a bolt with internal and external thread and can be fastened securely to the switchboard or other base by one hex nut. The binding head and stud collar are made of molded phenolic. The head screws into the body with a long thread that makes a good contact and prevents the tendency of the head to fall off and become lost. All metal parts are brass.



KNOBS

PHENOLIC KNURLED KNOBS

Part No. DK-41

ABS Plastic Knurled Knob
Black Phenolic Knurled Knob
3/4 10-32 w/brass insert.



JUMPER STRIP

TBT168 - Jumper Bar (or Jumper Strip)

Part No. TBT168

(The TBT168, which is 3ft long (58 poles), can be cut to the required length by the user)

This nickel-plated jumper strip is made specially for the STATES Type NT & ZWM Terminal Blocks and the STATES Type MTS Test Switches.



Jumper bars use the terminal block or test switch openings for linking connections together. Multi-pole jumpers can be cut into a smaller number of poles to accommodate your needs. These have a rating of 600VAC and 30A.

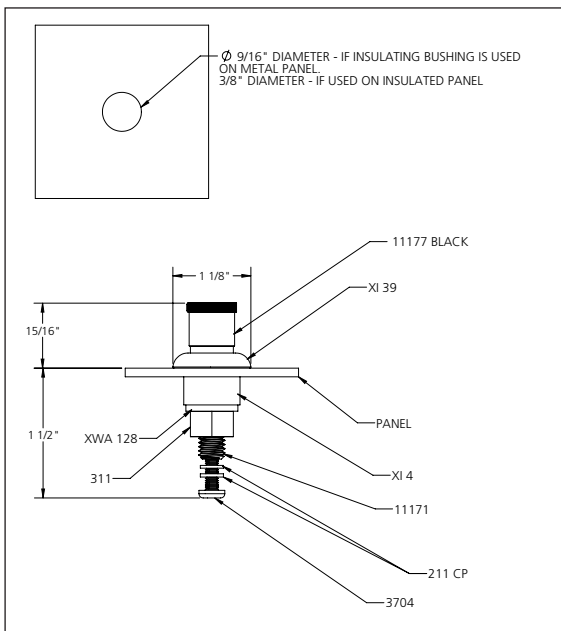

PLUGS

TEST PLUG

Part No. 15000



Used in connection with the current shunt jack on STATES test switches, this plug provides a safe, quick connection for indicating or testing instruments without opening current transformer secondaries or disturbing permanent wiring. The plug is easily inserted at right angles to the test block.

INSULATED SOCKET WRENCH



Part No. 16028

This compact, lightweight, 7 inch wrench with insulation to the socket head has a hollow shank that extends 2½ inches over a ⅜ inch stud and 1⅜ inches over a ⅝ inch stud. It is designed for use as a ½ inch socket wrench or as the handle for the following screwdriver and socket adapters:

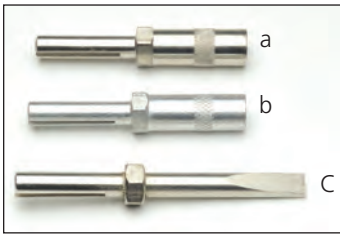

(a) Socket, ⅜ in.
Part No. 16027

(b) Socket, ⅝ in.
Part No. 16025

(c) Screwdriver
Part No. 16022

TEST LEADS



PROBE

Part No. 150LS

1 probe - 15000 with leads, red and black lugs.

Part No. 150LB

1 probe - 15000 with leads, red and black jacks.

(Not pictured)



620088

Consists of a twisted black and red test lead wire, 6 mm dia., 150 cm long, use with current outputs (up to 30 amps) CAT II insulation.



684025 (RED) & 684026 (BLACK)

684025 – Test lead, red, 200 cm long, use with voltage/current (up to 15 amps) outputs and timer, CAT II insulation.

684026 – Test lead, black, 200 cm long, use with voltage/ current (up to 15 amps) outputs and timer, CAT II insulation.

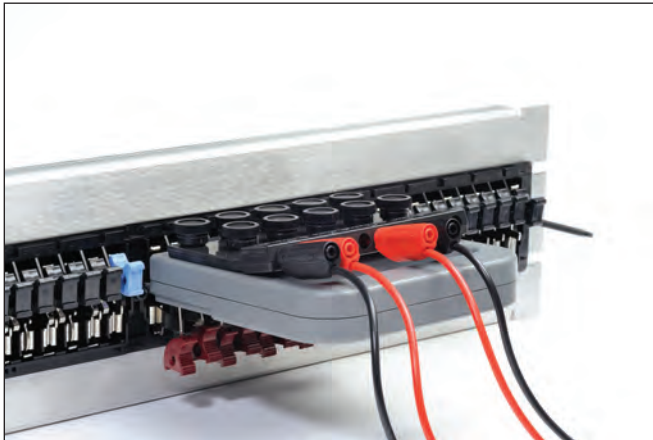

V1AT10 in use with 684025 & 684026 test leads



V1TP10 in use with TPA10 and 620088, twisted test lead wire

Notes



ADVANTAGE AVO



After our first 50 years, AVO Training Institute continues to lead the industry by developing the courses, the curriculum and the tools that make working with electrical systems safer. Our commitment to leadership still means analyzing industry needs in terms of education, safety, and maintenance with the passion to deliver the AVO difference. That's what we do.

A One-Stop Electrical Safety Resource

Building a strong electrical safety program begins with understanding the needs of our customers and their employees. Identifying critical issues that stand in the way of a successful electrical safety program and addressing the specific regulatory requirements of all types of industries are just two ways we offer total electrical safety and maintenance solutions.

Hands-On Skills You Can Use Today

No other electrical training provider dedicates the resources we do to ensure each student has hands-on time with the equipment. To enhance the hands-on experience our labs are equipped with substations, buried cable fields, switchgear, motor controls, relays, transformers and more.

OVER 52 ELECTRICAL SAFETY & MAINTENANCE TRAINING COURSES ARE OFFERED, INCLUDING:

- PROTECTIVE RELAY MAINTENANCE
- CIRCUIT BREAKER MAINTENANCE
- NFPA 70E ELECTRICAL SAFETY
- 6 CERTIFICATION PROGRAMS
- ONLINE TRAINING COURSES

**TO REGISTER FOR COURSES VISIT:
WWW.AVOTRAINING.COM/STATES
 OR CALL 877-594-3156**

STATES[®]

TERMINAL BLOCKS & TEST SWITCHES
A DIVISION OF MEGGER

www.statesproducts.com

4271 Bronze Way
Dallas, TX 75237-1019
1-800-325-4574
Fax: 214-331-7368
STATES@Megger.com

