



Window & Door Technical Guide

Details, Sizing & Specifications

Every project begins with an innate desire to create something great.

History

Founded in 1905, Loewen has earned a reputation for inspirational products, design leadership and custom capability. Our history helps describe our journey and foundation on which the Loewen brand of windows and doors is built.

Loewen is a manufacturer of wood windows and doors designed and built for premium residential new construction, renovation/restoration and distinctive light commercial construction.



Table of Contents

Introduction

- A2 Introduction to Loewen
 - A14 Environment & Certifications
-

Custom Options

- A18 Colors & Cladding
 - A22 Hardware
 - A28 Glass & Glazing Options
 - A40 Exterior Casing
 - A51 Mullion & Pocket Details
-

Windows

- B1 Casement Windows
 - C1 Awning Windows
 - D1 Picture/Direct Set Windows
 - E1 Double/Single Hung Windows
 - F1 Bow, Bay & Corner Windows
 - G1 Specialty Windows
-

Doors

- H1 Swinging Terrace & French Terrace Doors
 - J1 Sliding Patio & French Patio Doors
 - K1 BiFold Doors
 - L1 LiftSlide Doors
 - M1 MultiSlide Doors
 - N1 Timber Curtain Wall
-

Cyprum Collection

- P1 Refer to our Cyprum Guide for more information
-

StormForce™

Refer to StormForce™ Technical Guide for our Impact certified products.

Brand Overview

Loewen is the premium window and door company focused exclusively on the architectural market.

Loewen crafts luxurious windows and doors that are the statement pieces of custom residential architecture. Elevate homes into distinctive havens with Loewen's seamless blend of authentic materials and obsessive engineering. Our spectrum of products are built with precision to match the sophisticated vision of the most creative and exacting architectural designs.



Open your imagination and realize your designs the way they were intended to be. With a growing scope of offerings that range from premium to ultra luxurious, Loewen is ready to support your creative freedom.

Custom configurations, curtain wall systems, exotic custom operating products, multiple wood species, and unique cladding are all available in your architectural arsenal.

CY CU



CW CL



WD CU



Clad Wood

Excellence in Design and Performance

Loewen clad engineering creates extraordinary strength and durability, enabling dramatic design, innovation and inspiration. Loewen Clad fenestration products use coastal Douglas Fir or plantation-grown Mahogany in frames and sashes. Our low maintenance extruded aluminum ensures the ultimate in strength, performance and finish longevity.

Loewen uses only pre-finished extruded aluminum cladding to better protect window and door exteriors and eliminate the need for painting.

Robust design and engineering can achieve the ideal solution for any opening. Complete your vision with sharp design, customizable options, and the wide-open views that only Loewen can provide.

Available in many window and door configurations:

Windows	Awning, Casement, Double Hung, Direct Set, Specialty shapes and Custom configurations
Doors	Terrace Swing, Sliding Patio, Bifold, MultiSlide and LiftSlide



Wood

Traditional Beauty, Endless Variety

Loewen Wood products feature Coastal Douglas Fir or plantation-grown Mahogany in our frames and sashes. These woods do more than just provide our windows a rich, warm texture - they're also naturally tough and resilient, yet remarkably workable, meaning they are ideal for precision milling and capable of holding the smallest, most intricate detailing.

Douglas Fir is North America's most plentiful softwood species, accounting for one-fifth of the continent's total softwood reserves. It is beautiful and durable, making it the ideal species for fenestration and a hallmark of the Loewen all wood offering.

To enhance our woods' high natural resistance to moisture absorption, decay and insect infestation, every Loewen wood component is treated with a water repellent, wood preservative before assembly.

Available in many window and door configurations:

Windows Awning, Casement, Double Hung, Direct Set, Specialty shapes and Custom configurations

Doors Terrace Swing, Sliding Patio, and LiftSlide



Timber Curtain Wall

Stunning Panoramic
Vistas are Here

The Loewen Timber Curtain Wall system embodies the spirit of contemporary architecture with minimal framing and cleaner sightlines, allowing for the most expansive views. Configuration options are limitless, including vertical walls, rake-heads, corner units, and integrated operable windows and doors.



Cyprium Collection

Living Finishes in Copper and Bronze

Loewen Cyprium features copper and bronze clad windows and doors unique in design and construction. The Cyprium collection is artisanal in detail, including hand-soldered exterior joints and rich, tactile depth of texture in the thick metal cladding and deep profiles.

These hand-wrought living surfaces develop distinctive patinas that adopt and define the individual aesthetic character of the homes to which they belong.

Available in many window and door configurations:

Windows	Awning, Casement, Double Hung, Direct Set, Specialty shapes and Custom configurations
Doors	Terrace Swing, Sliding Patio, Bifold, MultiSlide and LiftSlide



Custom Wood

Dramatic Window and Door Design

Loewen introduces a true custom hand crafted wood product line of windows and doors. Countless options and features are available to tailor each unique opening in any style of home. Whether you are looking to retrofit an elegant, traditional-style home, or aiming for a highly contemporary look, Loewen Custom can create the ideal solution.

For your unique architectural vision investigate our alternative species:

- White Oak
- Walnut
- Mahogany
- Teak
- Cherry
- Accoya®

Available in many window and door configurations



Architectural Services

Loewen's Architectural Services division was created with the imagination and passion of Architects in mind. This consultative service exists to collaborate Loewen's technical expertise and manufacturing experience with visionaries who live to design, create and inspire.

Contact us by Email

architecture@loewen.com

Contact us by phone

United States or Canada: 800.563.9367

Outside of North America: 204.326.6446

Dealer Network

In addition to Loewen's Architectural Services, we also have a large dealer network including territory managers and sales professionals available throughout Canada and the United States to serve and assist the architectural community. These Loewen professionals are able to provide detailed information, service and pricing for all Loewen products.

Loewen representatives are available for informative product demonstrations, office/site visits, architectural luncheons (which may qualify for AIA Continuing Education Credits), or other functions that require fenestration expertise.

Product Samples & Displays

Portable product samples and displays are available through Loewen Territory Managers and the dealer network. These tools aid in understanding product differences and features.

Loewen products are displayed at trade and home shows, including both large national conferences and local exhibitions.



Performance

We take great pride in our windows and doors are among the highest performing in the industry. Performance keeps homes comfortable and energy efficient, and strength protects against the worst nature can deliver. We achieve this through a commitment to produce the highest quality products that we can, using only the highest quality materials. Loewen offers several solutions ideal for a variety of different environments, from the cold harsh northern climate, to the warm, sunny, south and tropical storm threatened regions.

Loewen products are engineered to comply with and exceed building codes in North America. Each test is conducted by an independent agency and is based on extreme conditions and varying product sizes. Code compliance is a fundamental aspect of our product design. Many of our products meet the performance requirements for Energy Star in all United States climate zones. The National Fenestration Rating Council empirically shows that Loewen products are among the industry's best in terms of thermal performance.



Loewen Basics

Loewen windows are highly customizable. Whether you are looking to retrofit an elegant, traditional-style home, or aiming for a highly contemporary look, Loewen has the ideal solution.

Loewen engineering results in uncommon strength and durability, enabling dramatic design, innovation and inspiration.

- 1 Coastal Douglas Fir for strength and rigidity (other species available).
- 2 Laminated sash for enhanced structural stability and a tight weather seal.
- 3 Dual seal on glass units for long hermetic seal life.
- 4 Natural clear wood interior, ideal for staining or painting.
- 5 Profiled sash edge for a finished look and integration with Simulated Divided Lite (SDL) bars.
- 6 Optional extruded aluminum cladding, for low maintenance, available in a wide range of colors. (Cyprium cladding available)
- 7 Minimal use of exposed exterior caulking on glass surface.
- 8 No metal-to-glass contact, ensures improved energy efficiency.
- 9 Triple seal glazing system available on metal clad units to effectively block moisture infiltration.
- 10 Hidden venting channel to allow built-up condensation to escape, increasing seal and sash life.
- 11 Authentic stile and rail construction. No mitered sash corners.
- 12 Mortise and tenon sash corner joinery, for structural stability.
- 13 Tall bottom rail available to create a custom architectural look reminiscent of traditional joinery and to enhance structural stability and strength.
- 14 Airspace between wood and window cladding, for air circulation and added insulation value.

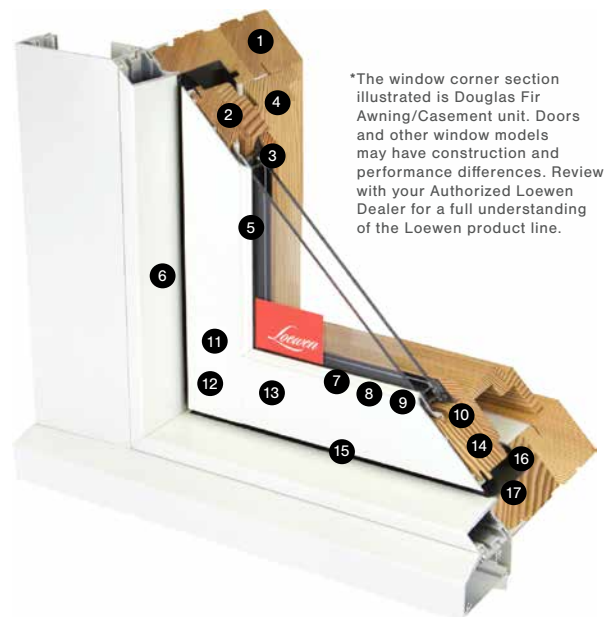

*The window corner section illustrated is Douglas Fir Awning/Casement unit. Doors and other window models may have construction and performance differences. Review with your Authorized Loewen Dealer for a full understanding of the Loewen product line.

- 15 Secondary weatherstrip to deflect wind-driven rain from primary seal.
- 16 Continuous primary weather-stripping, for maximum protection against air and water infiltration.
- 17 Polypropylene liner for added protection from the weather.



ENVIRONMENT

Environmental Commitment

Environmental stewardship is aligned with many of the core values that are present in Loewen. We understand our customers' commitment to environmental sensibility and our brand reflects our commitment to alleviating our environmental footprint.

We practice environmental stewardship in not only our manufacturing processes, but in our product offering as well. Nearly 100% of the wood fiber used in the production of Loewen products is derived from forests that are Stewardship certified, Canadian Standards Association (CSA) certified, or Programme for the Endorsement of Forest Certification (PEFC) certified.



Loewen's outstanding energy efficiency attributes and use of sustainable materials are ideal for use in structures designed under LEED (Leadership in Energy and Environmental Design).

Loewen is a socially responsible corporation, buying ethically manufactured products and recognized for our leadership in energy conservation and environmental protection. We prove the success of our brand through our environmental commitment.

Loewen was the recipient of the Tree Canada Foundation Eterne Award, honoring us for "environmental leadership and commitment to taking action on global climate change through the planting of trees."

We recycle virtually all of the wood waste created in the manufacturing process. For example, during our frigid Canadian winters, we even heat our plant with sawdust. We also recycle glass, aluminum, weatherstripping, solvents, motor oil and paper.

Certifications & Associations

Loewen windows and doors are engineered to comply with – and exceed – building codes in North America and beyond. Each test is conducted by an independent agency, based on extreme conditions and varying product sizes. Code compliance is a fundamental aspect of Loewen design and engineering.



National Fenestration Rating Council (NFRC)
Our products are empirically shown to be among the industry's best in terms of thermal performance.



Window & Door Manufacturers Association (WDMA)
Hallmark Certification verifies that manufactured products are the same as tested products.



Energy Star Partner
Many Loewen windows and doors meet the performance requirements for Energy Star in all United States climate zones.



Texas Department Of Insurance (TDI)
The TDI is a dynamic leader in responsible state, national, and global regulation, consumer protection, and market viability.



Florida Building Code
The Florida Building Code is the strictest code in the United States for resistance to wind-borne debris and wind-loading for fenestration products. Many Loewen certified products meet high velocity wind zone 4 standards.



Efficient Windows Collaborative
Loewen is a founding member of the U.S. Department of Energy's Efficient Windows Collaborative.

*Not all products meet every certification.

We actively seek to reduce-reuse-recycle. We understand the real world dynamics of downcycling and so we aggressively design systems that are optimally efficient in consumption and produce windows of the highest quality, as to assure long product life.

To this end, our products are made to be repaired and can be removed and re-installed. Once again, product quality is at the crossroads of efficiency and responsible design.

By manufacturing wood windows and doors, we are using a renewable resource and an efficient natural insulator that consumes less energy than alternative materials in a home. And, because wood is the foundation of our business – everything that we do relies on this resource – we recognize that we must support re-forestation initiatives.

Our Guarantee

Support, Consideration and Service

Our solid warranty is the written proof of our commitment to quality. Loewen windows and doors are made to last, and we have always stood behind our product with unsurpassed support, followup, and service.

The strength of a warranty is based on the quality of the windows and doors and the confidence of the company behind them. When you have been building custom windows and doors for decades, you know that the first step in having a credible warranty is the integrity of your products.



The Loewen Advantage

- Full 20-year warranty on glass, wood components, and paint finishes on clad product.
- We guarantee our products for the full length of our warranty, meaning our support does not reduce over time.
- Complete coverage for all color finishes on our aluminum clad exterior including protection against fading and chalking for 20 years.
- Full 10-year coastal warranty on painted finishes within one mile of the coastline.
- Fully supported warranty service with our network of Loewen experts and regional dealer inspections.
- Full 2 years labor warranty.

Competition Warranties

- May promote a longer warranty even if it is limited or not inclusive for all parts.
- May be prorated warranties that reduce the manufacturer's liability as the product ages.
- Vinyl and wood fiber clad exteriors may carry a color fade only warranty or none at all.
- Warranties on paint that extend past those of the paint specifications will not extend the life of the paint finish and are always limited.
- Warranties that cover various distances from the coast often do not consider the specific effects of coastal weather conditions.
- Confusing language - for example: a lifetime warranty against corrosion for an exterior component that contains no metals really needs to cover against UV deterioration and chalking.



Color and Cladding

Superior Aluminum Cladding

Loewen uses only pre-finished extruded aluminum cladding to better protect window and door exteriors and eliminate the need for painting. Our thick extruded aluminum cladding retains its shape, resists denting and lasts longer than roll-formed aluminum. In addition, Loewen's window cladding is set away from the underlying wood, creating an airspace that improves thermal performance.

The broad variation in Loewen sizes, shapes and designs and the demanding environmental conditions that our product encounters require an alloy that has the ability to:

- Withstand serious impact without sustaining damage
- Allow intricate extrusion detailing
- Provide the malleability necessary to clad many sizes and shapes
- Deliver unequaled environmental durability
- Provide a stable substrate that enhances colorfast paint performance



AAMA 2605 / 70% Kynar Finishes

Loewen's finish palette provides the perfect finishing touch for fulfilling your vision, while also providing industry leading quality and performance. Loewen's paint formula includes 70% Kynar 500 PVDF (polyvinylidene fluoride) resin, which offers the greatest resistance to weathering, fading and chalking. This ensures a beautiful finish that will last when cared for properly. With excellent appearance and durability, these paints meet the specifications of the American Architectural Manufacturers Association (AAMA) 2605.

Metal Clad Painted Finishes

We have worked with industry professionals and designers to define our palette of exterior metal clad colors and finishes. These paints meet the specifications of the American Architectural Manufacturers Association (AAMA) 2605. The qualities of this paint provide robust weathering, fade and chalk resistance and a beautiful finish that lasts for decades when cared for properly.

AAMA 2605 / 70% Kynar Finishes

Color Palette



Anodized

For a durable alternative to paints and organic coatings, our Anodized Finishes offer a rich matte look that reduces sunlight glare and allows the aluminum to maintain its metallic appearance.

In addition to the aesthetically desirable etching, our Anodized Finishing also increases resistance to abrasion and corrosion on aluminum*. This aluminum is 100% recyclable and uses a waterbased process with no volatile organic compounds for eco-friendliness.

For those projects that specify a truly unique look, with the superior performance of anodized. These select anodized finishes are available as part of the Architectural Finishes offering.

Meets AAMA 611 Specification

Anodized Finishes



*Anodized finishes are not recommended in coastal environments

Due to technical print limitations colors and finishes may not be exactly as shown

Custom Color Cladding

Additional Colors

When personal style or design dictates a unique color solution, just tell us what your wish is. Our standard range of aluminum clad colors is enhanced with the choice of true custom color specification. The integral cross matching system and color approval process ensures that you get the exact color you want every time.

AAMA 2605 / 70% Kynar Finishes

Expanded Color Palette



Durability & Versatility

Versatility is one of the key elements in the Loewen product offering – there are more than ten trillion possible combinations of standard Loewen products.

In addition to this massive standard selection matrix, Loewen products are available in custom shapes, sizes and configurations.

Each Loewen product, whether standard or custom, may be further personalized by choosing the Loewen Cyprum™ Collection or through the use of Simulated Divided Lites, exterior casing options and metal clad paint selection in a variety of colors and finishes. An array of hardware finishes further expand the variety and customization of each window order.

Douglas Fir Durability

Douglas Fir outperforms Hemlock & Pine

Wood Species	Specific Gravity (density)	Impact Strength (height of drop causing complete failure)	Compression Strength (parallel to grain)	Compression Strength (perpendicular to grain)	Hardness (load perpendicular to grain)	Resistance to Decay USFS Grade
	Weight Over Volume	Inch	psi	psi	lbs	
Douglas Fir	0.48	31.0	7,230	800	710	Moderate
Mahogany	0.42	Untested	6,460	1,500	830	Slight
Western Hemlock	0.45	23.0	7,200	550	540	Slightly to non-resistant
Ponderosa Pine	0.40	19.0	5,320	580	420	Slightly to non-resistant

Douglas Fir Fastener Retention

This chart shows the force required to remove fasteners

Wood Species	Nail	Screw	Hinge
Douglas Fir	189 lbs	527 lbs	743 lbs
Ponderosa Pine	98 lbs	392 lbs	486 lbs

Window Hardware

Selecting a style and finish that reflects your unique taste is a critical part of creating the right look.

But choosing hardware involves more than just appearance – function and operation are essential, which is why Loewen offers a wide range of handles, locking systems and other hardware choices – from the most traditional to the most contemporary. Hardware must also offer intelligent design and flexibility. This is why Loewen provides designs such as the foldaway handle, useful when drapes or blinds fit tight against a window or when access space is limited.

For hard-to-reach windows, optional motorized operators can be activated by a simple wall switch or battery operated remote control.



Contemporary Casement and Awning Handle and Cover (Black)



Tango Casement and Awning Handle and Cover (Satin Nickel)



Provence Casement and Awning Handle and Cover (Oil Rubbed Bronze)



Contemporary Push Out Casement/Awning Multi Point Locking Handle (Satin Nickel)



Push Out Casement/Awning Multi Point Locking Handle (Satin Nickel)

Finishes



Antique Brass



Bright Brass



Bronze



Oil Rubbed Bronze



Brushed Chrome



Black



Linen



Faux Bronze



Matte Black



White



Satin Nickel



Rustic Bronze

	Contemporary A/C Cover	Tango A/C Cover	Provence A/C Cover	Push Out Contemporary	Push Out Standard	Double Hung
Satin Nickel	•	•	•	•	•	•
Bright Brass		•	•	•	•	•
Bronze		•	•	•	•	•
Oil Rubbed Bronze		•	•	•	•	•
Black		•	•	•	•	•
Linen		•	•	•	•	•
Brushed Chrome		•	•		•	•
Antique Brass		•	•		•	•
White	•					
Faux Bronze	•					
Matte Black	•					
Rustic Bronze					•	
Unlacquered Brass					•	



Concealed Multipoint Lock Handler
(Satin Nickel)



Push Out Casement/Awning Screen Knob
(Brushed Chrome)



Double/Single Hung Sash Lock
(Oil Rubbed Bronze)



Double/Single Hung Sash Lift
(Oil Rubbed Bronze)

Door Hardware

Loewen doors are available with a wide range of hardware options. We constantly review our hardware selection and new options are regularly added. Consult your Authorized Loewen Dealer for the most current information.

Terrace Door and Bifold Handle Sets



Rodos Handle
(Antique Brass)



Meran Handle
(Black)

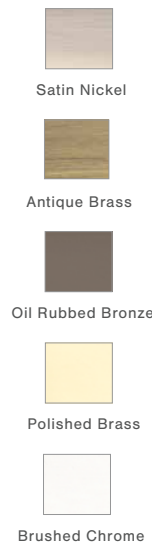

Verona Handle
(Polished Brass)

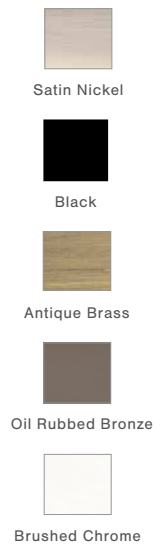

Dallas Handle
(Dark Bronze Metallic)

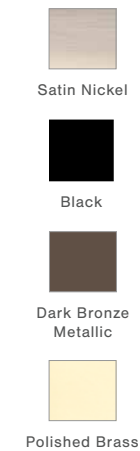

Athinia Handle
(Satin Nickel)



Churchill Handle
(Rustic Bronze only)



Shropshire Handle
(Rustic Bronze only)

FINISH OPTIONS



Terrace & BiFold Door Hardware	Meran	Rodos	Verona	Dallas	Athinia	Shropshire	Churchill
Satin Nickel	●*	●*	●*	●*	●*		
Polished Brass	●*	●*	●*	●*	●*		
Black	●	●	●	●			
Oil Rubbed Bronze	●	●	●				
Brushed Chrome	●*	●*	●*				
Antique Brass	●	●	●				
Dark Bronze Metallic				●			
Polished Brass w/ Satin Brass					●		
Polished Chrome w/ Satin Chrome					●		
Rustic Bronze						●	●

*Selected handles are available in Resista(R) or PVD finish coatings. These are extremely durable finishes that are suitable for harsh environments such as coastal locations. Oil Rubbed Bronze finishes are living finishes that wear and change over time and with use. This is an expected and desired effect with ORB finishes.

Patio Door & MultiSlide Handle Sets

Selected handles are available in Resista or PVD finish coatings. These are extremely durable finishes that are suitable for harsh environments such as coastal locations. Oil Rubbed Bronze finishes are living finishes that wear and change over time and with use. This is an expected and desired effect with ORB finishes.

Handle sets for Sliding Doors are available in a wide selection of styles and finishes. Finishes chart on page A15.



Botticelli Handle
(Oil Rubbed Bronze)



Satin Nickel



Black Matte



Antique Brass



Bronze (PVD)



Oil Rubbed Bronze



Fontana Handle
(PVD Bronze)



Satin Nickel



Black



Antique Brass



Bronze (PVD)



Oil Rubbed Bronze



Miami Handle
(Black)



Satin Nickel
(PVD)



Black



Bronze (PVD)



Bright Brass
(PVD)



Flush Handle
(Black)



Satin Nickel



Bronze (PVD)



Black



Churchill Handle
(Rustic Bronze only)



Rustic Bronze

FINISH OPTIONS

MultiSlide & Patio Door Hardware	Fontana	Botticelli	Miami	Flush Handle MultiSlide	Churchill
Satin Nickel	●**	●**	●**	●**	
Black	●	●	●	●	
Oil Rubbed Bronze	●	●	●		
Bronze	●**	●**	●**	●**	
Antique Brass	●	●			
Rustic Bronze					●

**Available in PVD finishes

LiftSlide Door Handle Sets

BiFold Door Twin-Point Lockset



Interior Flush Handle
(Silicone Bronze Dark)



Bronze Dark
Lustre



White Bronze
Brushed



Marcos Handle
(Satin Nickel)



Bright Brass
(PVD)



Oil Rubbed
Bronze



BiFold and
LiftSlide Shoot Bolt
(Satin Nickel)



Black



Bronze



Twin Point
Lockset
(Black)



Bronze



Brushed
Stainless Steel



White

Glazing Options

Loewen Sealed Units offer ideal solutions for any environment. With countless glazing configurations and LowE coating options, we ensure that you can choose the perfect blend of protection and comfort - no matter where you live.

LowE Window Systems

LowE Window Systems offer varying levels of thermal protection. They also protect furnishings by screening out much of the damaging ultraviolet radiation that causes fading and related damage. The charts on the next page show the comparative performance of each Loewen Window System. LowE is a high-performance glazing system that offers great thermal value in a variety of climate zones.



LowE Double

Double glazed, with one or more layers of LowE coating and on 1/2" (13mm) airspace filled with Argon gas and stainless steel thermal spacer bar.

- Loewen standard 1/8" (3 mm) double strength glass offers greater strength and clarity over thinner glass, making our products more insulative, more soundproof, more resistant to impact and considerably more resistant to stresses caused by fluctuations in temperature.
- Loewen standard sealed units contain Argon gas and machine applied primary and secondary sealants reducing the chance of seal failure, improving Argon gas retention, and increasing strength.

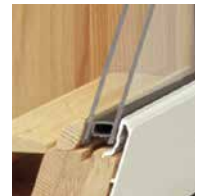

More than 40 years ago Loewen Windows and Doors introduced our sealed triple-pane to the marketplace. This longevity and concentration on performance glazing means our products accommodate a triple glazing within standard options. It is not an afterthought, it is part of our core identity.

True Triple Sealed Units

with LowE surface coatings for maximum performance

Triple glazed, with multiple layers of LowE coatings and two 1/2" airspaces filled with Argon gas and stainless steel thermal spacer bars. Unlike other window systems we offer sealed units with the optimum 1/2" cavities between panes to maximize energy efficiency.

- Loewen standard 1/8" (3mm) double strength glass offers greater strength and clarity over thinner glass, making our products more insulative, more soundproof, more resistant to impact and considerably more resistant to stresses caused by fluctuations in temperature
- Loewen standard sealed units contain Argon gas and machine applied primary and secondary sealants, reducing the chance of seal failure, improving Argon gas retention and increasing strength
- Argon gas in all air-spaces
- Venting channel built into the sash under every sealed unit to allow for a weeping system in the event moisture or condensation ever were to be present.
- Stainless steel spacer bar is less conductive than aluminum and structurally superior to silicone foam type spacers
- Sash cladding does not touch the glass which reduces the opportunity for thermal conduction
- Available across all window and door products categories
- Airspace between wood and window cladding
- Spacer bars available in all airspaces with SDL muntins

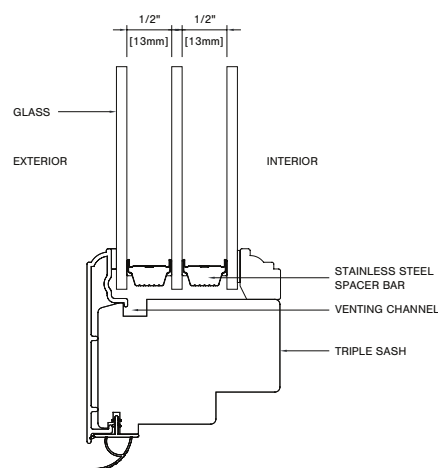

LowE Compared With Clear Double & Triple Pane Glass Units

U-Value*

This chart illustrates the resistance of heat transfer through the glass. Lower U-Value indicates greater insulating capabilities. U-Value measured at center of glass.

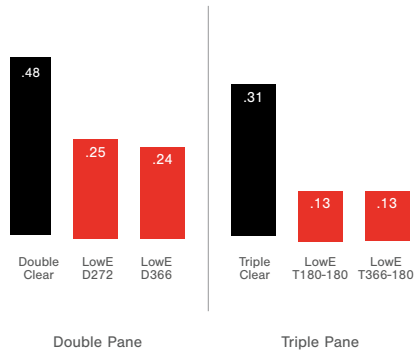

Solar Heat Gain (SHGC)*

This chart measures the ratio of solar heat gain through a glazing system compared to an unobstructed opening.

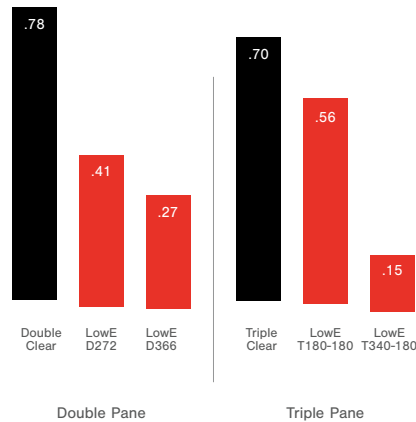

UV Transmittance*

This chart measures the percentage of ultraviolet radiated wavelengths allowed to be transmitted through the glazing system.

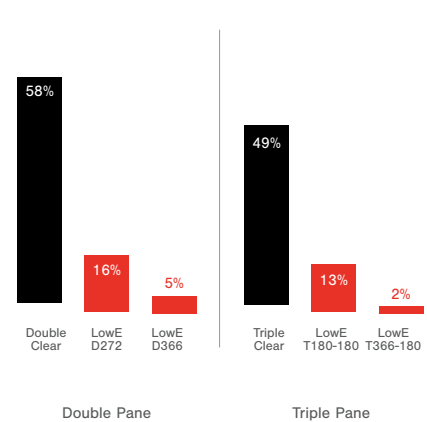

*ASHRAE calculated values Window 5.2 | 1/2" airspace (13 mm) | Does not apply to sealed units with capillary tubes installed

Note: Information in these charts compares the center of glass performance levels of the sealed unit only when manufactured with different glazing options. They are not representative of overall window performance, which depends on many factors including grille options, such as simulated divided lites, grilles between glass, product size and configuration. This information cannot be used to calculate energy performance, to determine resistance to condensation or to develop assumptions about suitability for use or compliance with energy codes. For overall performance of specific windows or doors, refer to "NFRC U-factor and SHGC/VT" information.

LowE Coating Options

We offer as many glazing configurations and LowE coatings as there are climates so our window performance can be built to provide comfort in any environment.

LoE³ – 366 Ultimate Performance

- Highest level of year-round comfort for every climate
- Better insulator (low u-value) and solar heat blockage (low SHGC)
- Three layers of silver (LoE³ 366)

LoE³ – 340 Ultimate Solar Control

- Greatly reduces oppressive solar heat gain & glare
- Best insulator (low u-value)
- Three layers of silver (LoE³ 340)

LoE² – 272 All-Climate

- Year-round, well balanced performance and comfort
- Better insulator (low u-value) and moderate solar heat blockage
- Two layers of silver (LoE² 272)

LoE – 180 Passive Solar Gain

- Ideal for passive solar applications
- Good insulator (low u-value) and high solar heat gain
- One layer of silver

LoE – i89 Roomside LoE

- Indoor lite, surface #4 (double) or #6 (triple) reflecting more heat back into the room
- Enhanced insulation (lowers u-value)
- Iridium Tin Oxide coating

Specialty Glazing

Neat® Glass or Preserve™ Protective Film

Added Value Solutions

Neat® Glass is an ultra smooth surface made from silicon dioxide that harnesses UV rays to loosen dirt. Neat® Glass helps leave windows spotless with a quick rinse of water and preserves their cleanliness longer. Neat® Glass also comes with Preserve™ as a standard to protect the Neat® Glass surface.

Loewen windows may also be equipped with added value solutions, such as Preserve™ protective film. Preserve is made from a low-density polyethylene and water-based adhesive that helps reduce cleanup costs and masking off for painting and staining. Available for the exterior or interior of your windows, Preserve™ peels off quickly and easily.

Tranquility®

Solutions To Traffic & Other Urban Noise

Loewen's heavy frames, thick glass and superior fit and finish result in above-average sound attenuation. For problem applications, we've developed an upgraded glazing system that offers even better resistance to sound transmission.

Tranquility® Glazing Systems Greatly Reduce Sound Transmission

- Tranquility® Glazing Systems consist of a 1/4" (6 mm) glass on the exterior, a 13/16" (21 mm) Argon filled space, and a 9/32" (7 mm) laminate pane of glass on the interior. (no storm panel is required to achieve this rating). Visit www.loewen.com for details.
- Operating casement units test out at STC40
- Laminated glass used in the sealed unit provides increased security and helps to filter out damaging ultraviolet rays.

Tranquility® Sound Transmission Class (STC)

Using a single number, the STC rating identifies the sound transmission reduction of a glazing unit over a range of frequencies.

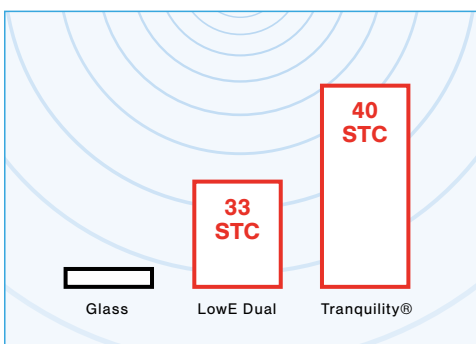

Tranquility® available on product configured for triple pane only.

Tranquility® Glazing

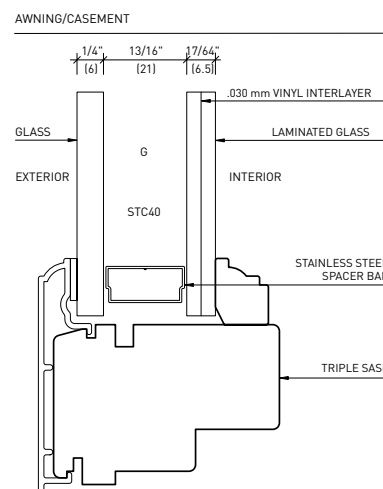

SPECIALTY GLAZING

Additional options include a wide variety of novelty glass treatments. These images are a sample of the offerings that can be added to selected Loewen windows and doors. Please contact your local dealer for the full range of options and applications.



3.9 Austral



Aqualite

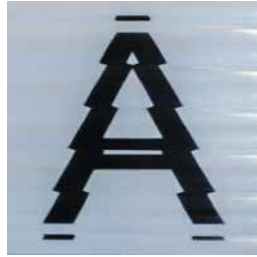

English Reed

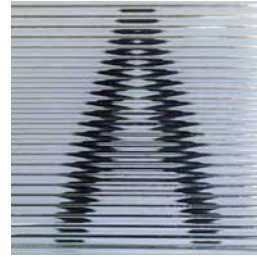

Narrow Reed

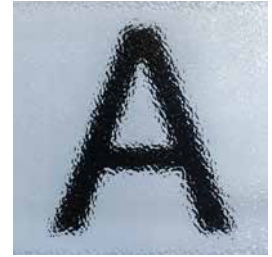

Pattern #62



Rain

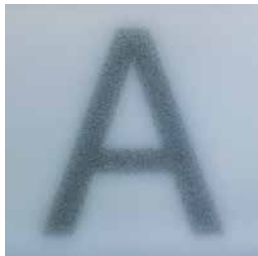

Sandblast

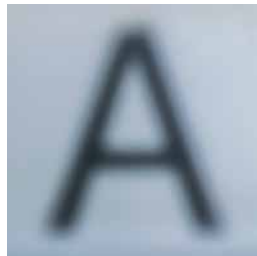

Satin Etch



Single Glue Chip

Glazing Fabrication

TINTED GLAZING

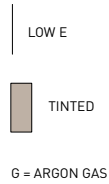
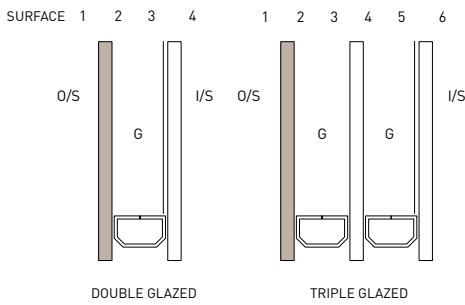

LowE® Glazing Fabrication

STANDARD GLAZING

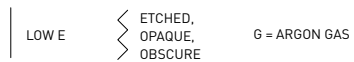
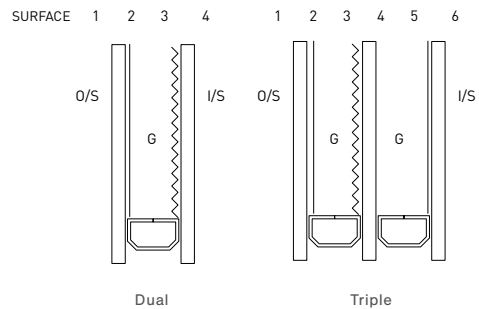

Divided Lites and Grilles

Simulated Divided Lite (SDL) bars add a distinctive design feature to full-size panes of glass. Wood or metal bars securely bonded to the outer surfaces of the sealed glass unit simulate the appearance of traditional true divided lites.

Available with straight or radius bars.

Additional airspace bars (between the glass) complete a convincing reproduction of a multi-paned window or door. Our spacer bars function among the best in the industry and provide an intriguing aesthetic appearance in stainless steel or black color options. Wide shadow bars fill more of the airspace replicating the look of True Divided Lites. Narrow shadow bars also provide a similar appearance while allowing for improved sealed unit performance.

Exterior Bar Options

	Ogee	Putty
Cross Section		
5/8" [16]		
3/4" [19]		
7/8" [22]		
1 1/8" [30]		
2" [51]		

Simulated Divided Lite (SDL) Standard Patterns

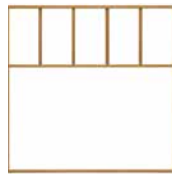

Craftsman

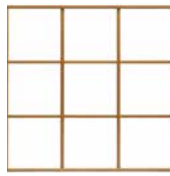

Colonial

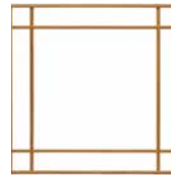

Heritage

Extended Half Round

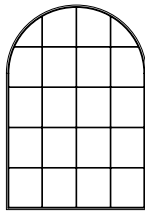

STYLE GR1

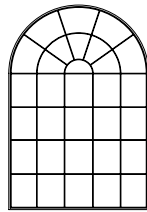

STYLE GR2

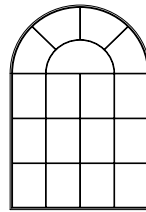

STYLE GR3

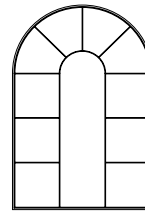

STYLE GR4

Extended Half Ellipse

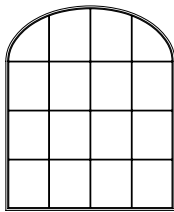

STYLE GR5

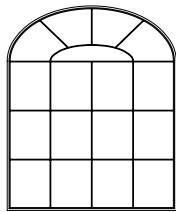

STYLE GR6

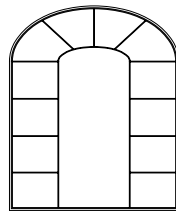

STYLE GR7

Extended Quarter Round

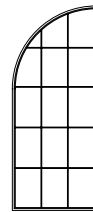

STYLE GR8

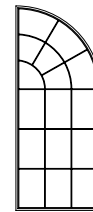

STYLE GR9

Extended Full Chord

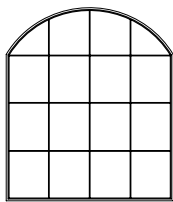

STYLE GR10

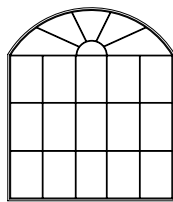

STYLE GR11

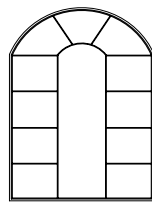

STYLE GR12

Full Round

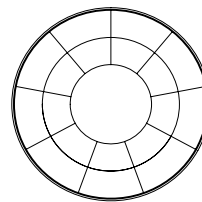

STYLE GR13

Sunburst

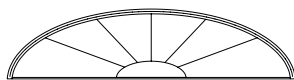

STYLE GR14

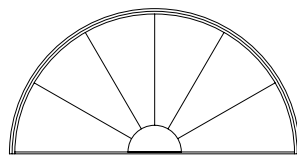

STYLE GR15

Oval

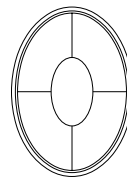

STYLE GR16

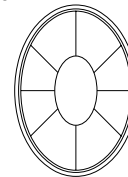





















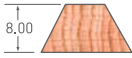







STYLE GR17

Note: Number of grille bars and spacing is determined by the size of the unit. Grille type may not be available in all units. Custom patterns available for approval.

Awning & Casement Units



Types of Simulated Divided Lite

Application	Available SDL	5/8" [16mm]	3/4" [19mm]	7/8" [22mm]	1-1/8" [30mm]	2" [50mm]
MC Exterior	Standard					
Interior	Standard					
MC Exterior	Putty					
NC Exterior / Interior	Putty					
Interior	Square					
Interior	Impact					
NC Exterior	Ogee					



Double/Single Hung Units































Types of Simulated Divided Lite

Application	Available SDL	5/8" [16mm]	3/4" [19mm]	7/8" [22mm]	1-1/8" [30mm]	2" [50mm]
MC Exterior	Standard					
Interior	Standard					
MC Exterior	Putty					
NC Exterior / Interior	Putty					
Interior	Square					
Interior	Impact					
NC Exterior	Standard					



Picture Units























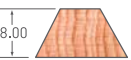













Types of Simulated Divided Lite & Glazing Stops

Application	Available SDL	5/8" [16mm]	3/4" [19mm]	7/8" [22mm]	1-1/8" [30mm]	2" [50mm]
MC Exterior	Standard					
Interior	Standard					
MC Exterior	Putty					
NC Exterior / Interior	Putty					
Interior	Square					
Interior	Impact					
NC Exterior	Standard					



Patio Door Unit

Types of Simulated Divided Lite & Glazing Stops

Application	Available SDL	5/8" [16mm]	3/4" [19mm]	7/8" [22mm]	1-1/8" [30mm]	2" [50mm]
MC Exterior	Standard					
Interior	Standard					
MC Exterior	Putty					
NC Exterior / Interior	Putty					
Interior	Square					
Interior	Impact [MP]					
Interior	Impact [MP]					
NC Exterior	Standard					



Terrace/French & Bifold Door Unit

Types of Simulated Divided Lite

Application	Available SDL	5/8" [16mm]	3/4" [19mm]	7/8" [22mm]	1-1/8" [30mm]	2" [50mm]
MC Exterior	Standard					
Interior	Standard					
MC Exterior	Putty					
NC Exterior / Interior	Putty					
Interior	Square					
Interior	Impact [MP]					
Interior	Impact [MP]					
NC Exterior	Standard					

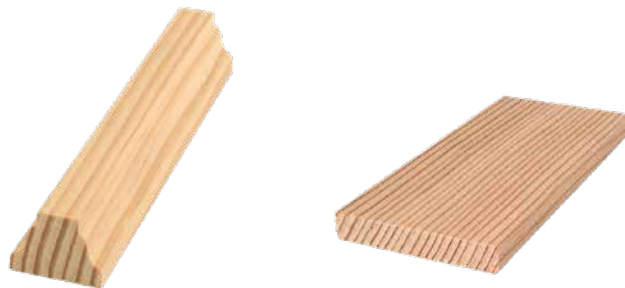

Casing, Jamb & Opening Definitions

Head & Sill Detail

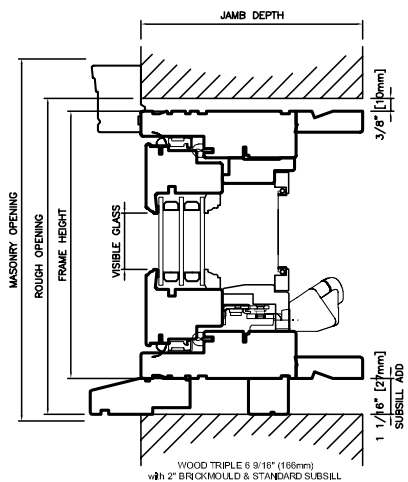
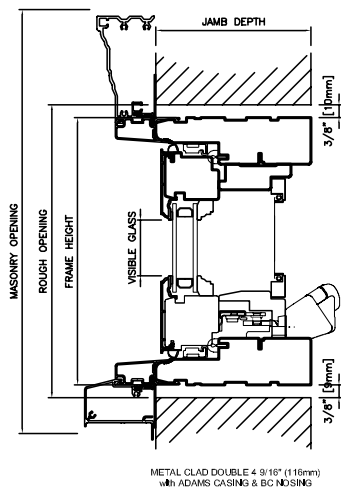
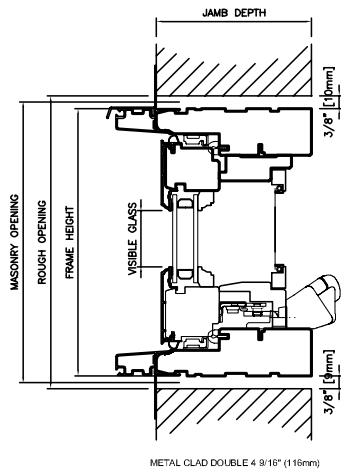

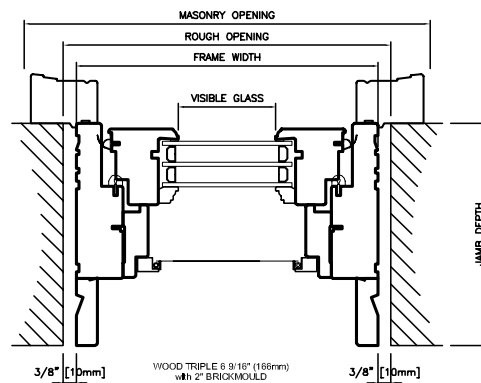
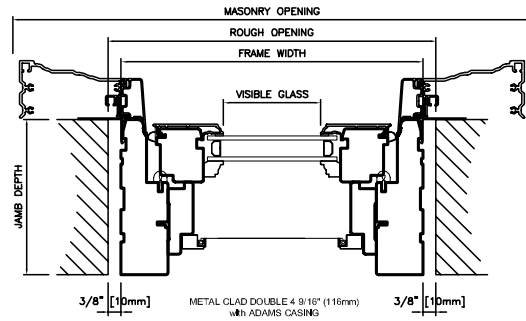
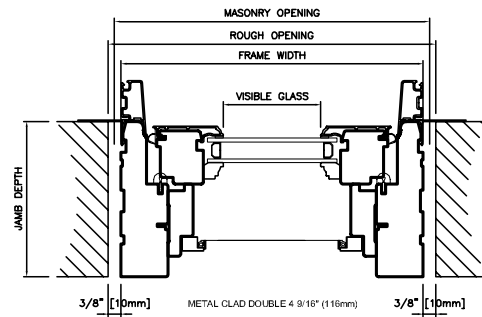

Plan View





Metal Clad Casing, Sill Nose & Accessories

 Direct Mull Cover

 1/4" Spread Mull Cover

 1" Spread Mull Cover

 1 1/2" Spread Mull Cover

 2" Spread Mull Cover

 2 1/2" Spread Mull Cover

 3" Spread Mull Cover

 4" Spread Mull Cover

 6" Spread Mull Cover

 1" Frame Expander

 2" Frame Expander

 3" Frame Expander

 4" Frame Expander

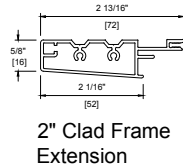
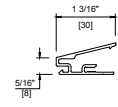
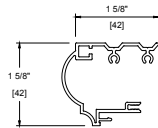
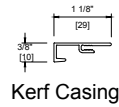

Nose & Cove Casing

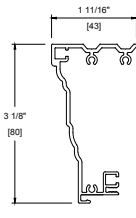
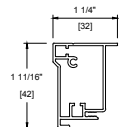
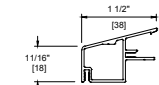
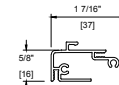

Standard Sill Nose

Double Hung Standard Sill Nose

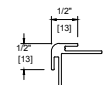
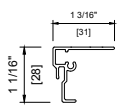
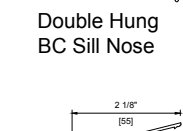
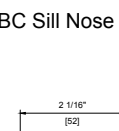
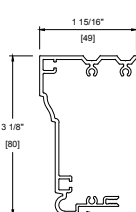
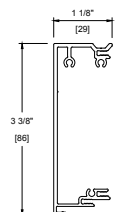
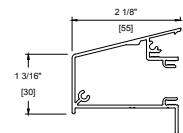
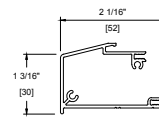

Adjustable Brickmould

H-Clip

L-Clip

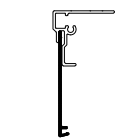

Add frame expander for custom height brickmould.



Add frame expander for custom mull cover.

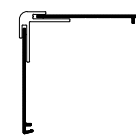

Add frame expander for custom corner cover.

Note: • Other jamb widths available.

Contemporary Frame Cladding Detail

Head & Sill Detail

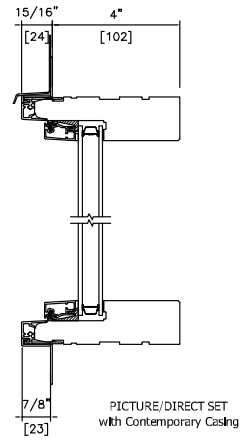
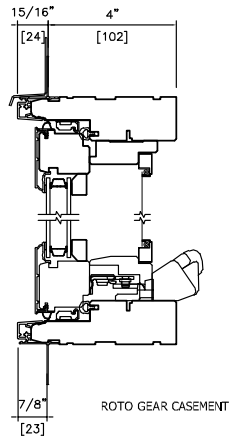
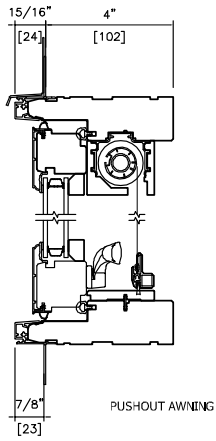

Head & Sill Detail

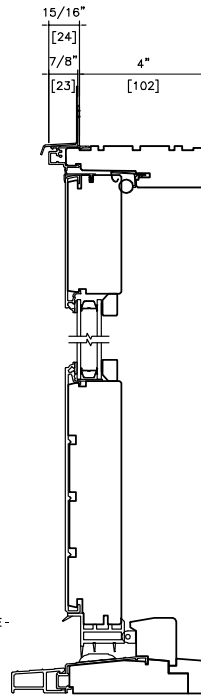
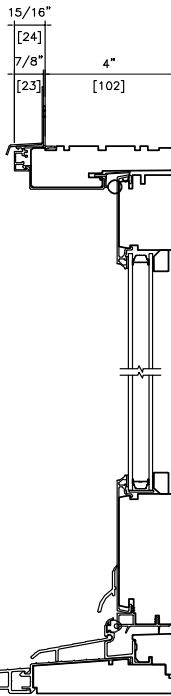

Casing

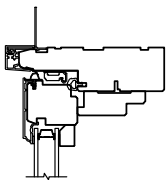

AWNING/CASEMENT

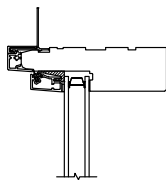

PICTURE/DIRECT SET

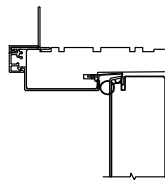

INSWING TERRACE/FRENCH TERRACE

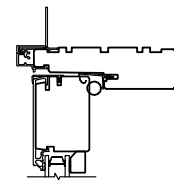

OUTSWING TERRACE/FRENCH TERRACE -

Wood Exterior Casing Options

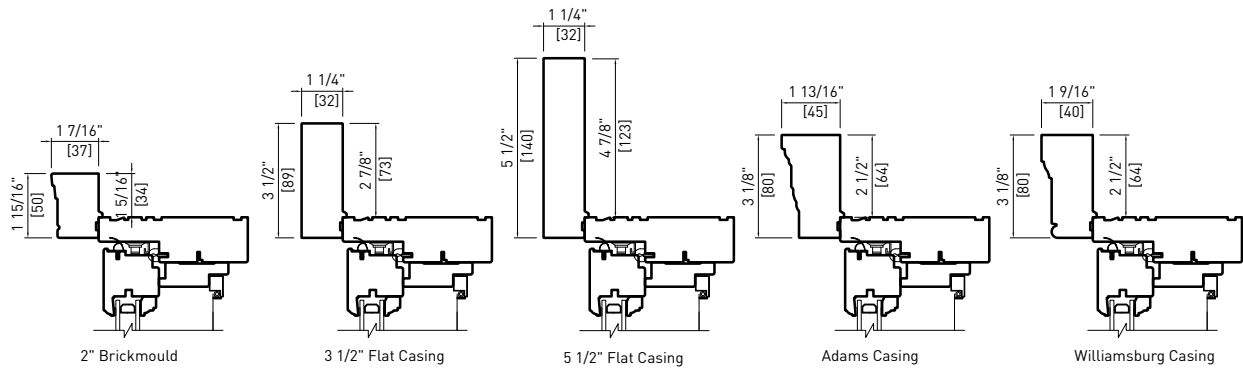

Flat Casing Option

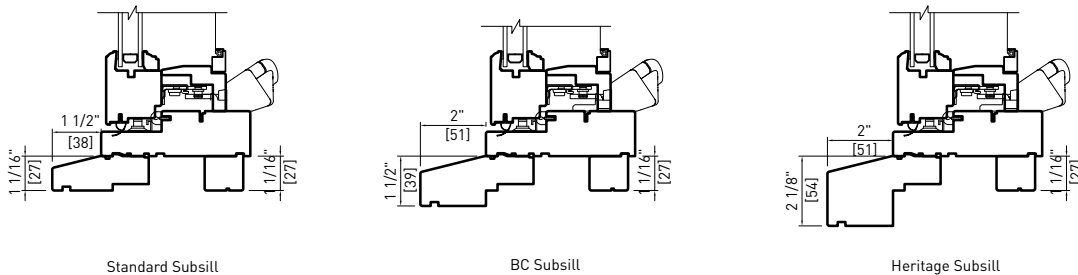
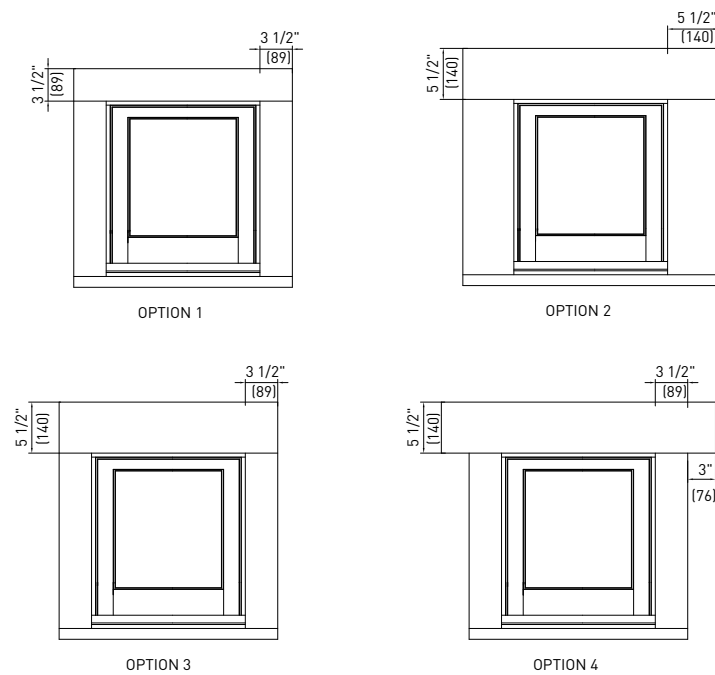

Note: • Other jamb widths available.

Masonry Opening Metal Clad

Casing Options

Frame Cladding Only.
Add 3/16" (5mm) to
Frame Dimensions at
Head & Sides.

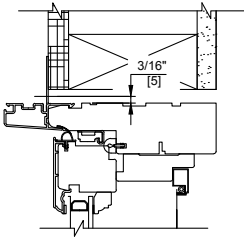

Kerf Casing.
Add 3/8" (10mm) to
Frame Dimensions at
Head & Sides.

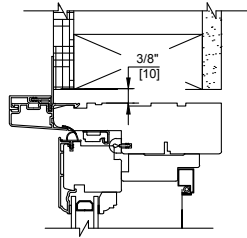

2" Clad Frame Extension.
Add 3/8" (10mm) to
Frame Dimensions at
Head & Sides.

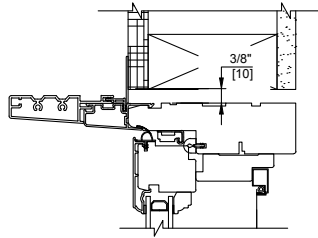

2" Brickmould.
Add 1 11/16" (43mm) to
Frame Dimensions at
Head & Sides.

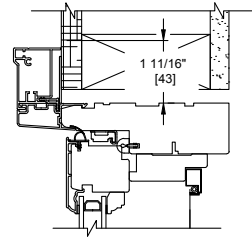

Sill Nose Options

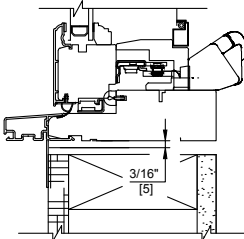

Frame Cladding Only.
Add 3/16" (5mm) to
Frame Dimension at Sill.

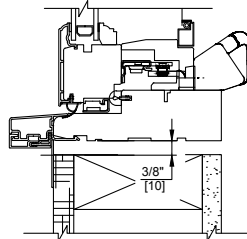

Kerf Casing.
Add 3/8" (10mm) to
Frame Dimension at Sill.

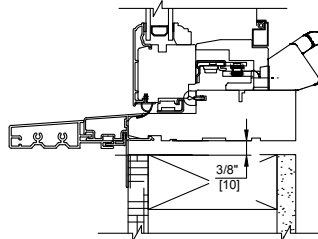

2" Clad Frame Extension.
Add 3/8" (10mm) to
Frame Dimension at Sill.

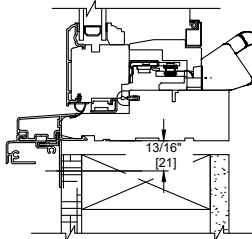

Standard Sill Nose.
Add 13/16" (21mm) to
Frame Dimension at Sill.

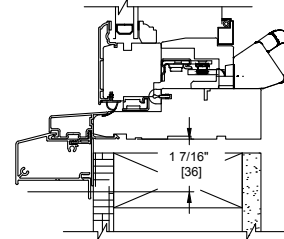

BC Sill Nose.
Add 1 7/16" (36mm) to
Frame Dimension at Sill.

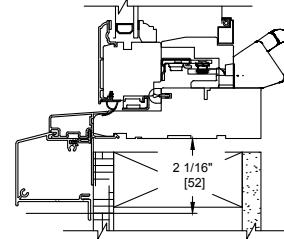

Heritage Sill Nose.
Add 2 1/16" (52mm) to
Frame Dimension at Sill.

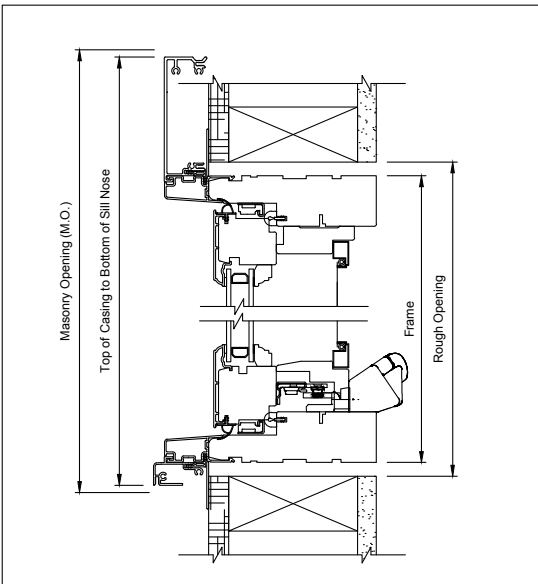

Note: • Other jamb widths available.

Masonry Opening Metal Clad

Casing Options

3 1/2" Flat Casing.
Add 3 7/16" (87mm) to
Frame Dimensions at
Head & Sides.

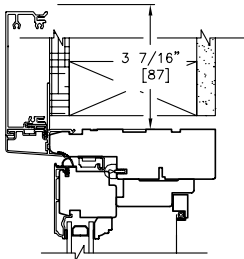

Nose & Cove Casing.
Add 1 9/16" (40mm) to
Frame Dimensions at
Head & Sides.

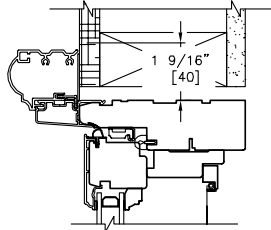

Adams Casing.
Add 3 3/16" (81mm) to
Frame Dimensions at
Head & Sides.

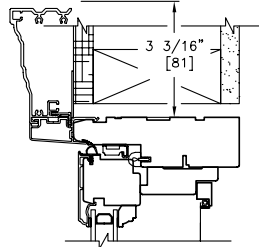

Williamsburg Casing.
Add 3 3/16" (81mm) to
Frame Dimensions at
Head & Sides.

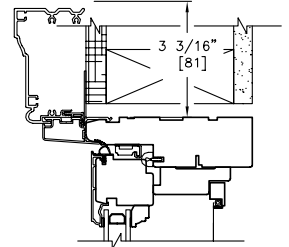

Sill Nose Options

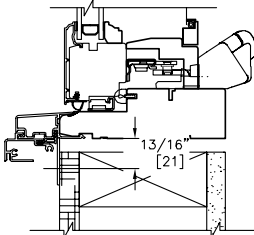

Standard Sill Nose.
Add 13/16" (21mm) to
Frame Dimension at Sill.

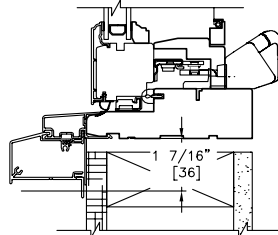

BC Sill Nose.
Add 1 7/16" (36mm) to
Frame Dimension at Sill.

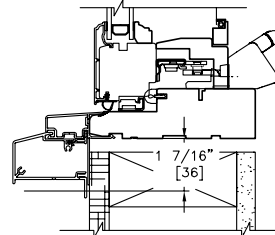

BC Sill Nose.
Add 1 7/16" (36mm) to
Frame Dimension at Sill.

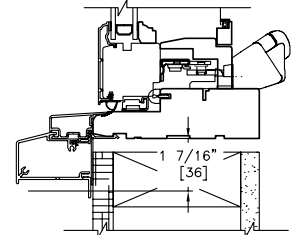

BC Sill Nose.
Add 1 7/16" (36mm) to
Frame Dimension at Sill.

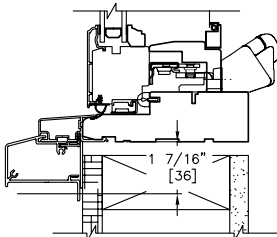

BC Sill Nose.
Add 1 7/16" (36mm) to
Frame Dimension at Sill.

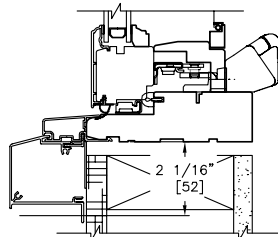

Heritage Sill Nose.
Add 2 1/16" (52mm) to
Frame Dimension at Sill.

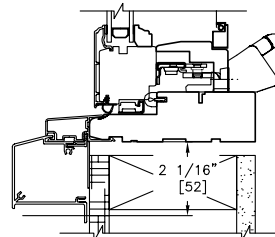

Heritage Sill Nose.
Add 2 1/16" (52mm) to
Frame Dimension at Sill.

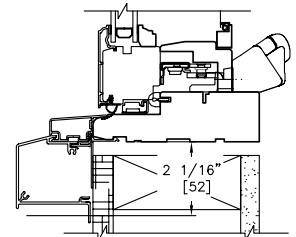

Heritage Sill Nose.
Add 2 1/16" (52mm) to
Frame Dimension at Sill.

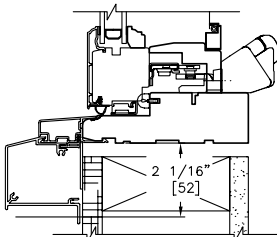

Heritage Sill Nose.
Add 2 1/16" (52mm) to
Frame Dimension at Sill.

EXAMPLE #1: CA1 7515 with 2" Brickmould & Standard sill nose.

Frame dimensions, 29 1/2" (750mm) x 59 1/16" (1500mm).
Masonry width = 29 1/2" (750mm) + [1 11/16" (43mm) x 2] = 32 7/8" (836mm)
Masonry height = 59 1/16" (1500mm) + 1 11/16" (43mm) + 13/16" (21mm) = 61 9/16" (1564mm)

EXAMPLE #2: CA1 0918 with Adams casing & BC sill nose.

Frame dimensions, 35 7/16" (900mm) x 70 7/8" (1800mm).
Masonry width = 35 7/16" (900mm) + [3 3/16" (81mm) x 2] = 41 13/16" (1062mm)
Masonry height = 70 7/8" (1800mm) + 3 3/16" (81mm) + 1 7/16" (36mm) = 75 1/2" (1917mm)

Note: • Other jamb widths available.

Masonry Opening Metal Clad - Double Hung

Casing Options

Frame Cladding Only.
Add 3/16" (5mm) to
Frame Dimensions at
Head & Sides.

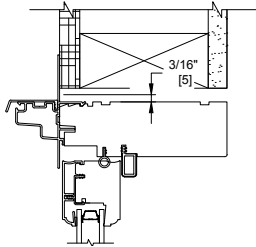

Frame Cladding Only.
Add 3/16" (5mm) to
Frame Dimensions at
Head & Sides.

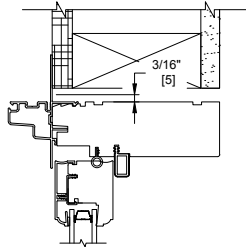

2" Brickmould.
Add 1 11/16" (43mm) to
Frame Dimensions at
Head & Sides.

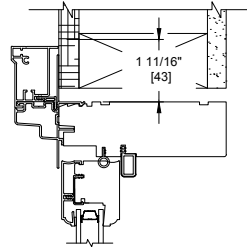

3/2" Flat Casing.
Add 3 7/16" (87mm) to
Frame Dimensions at
Head & Sides.

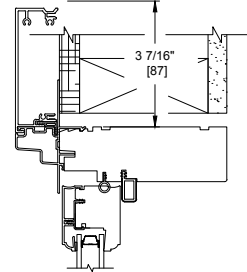

Sill Nose Options

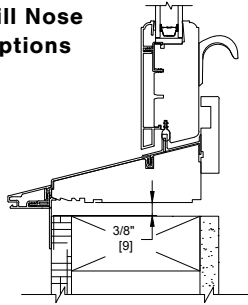

Multi Lite Sill Nose.
Add 3/8" (9mm) to Frame
Dimension at Sill.

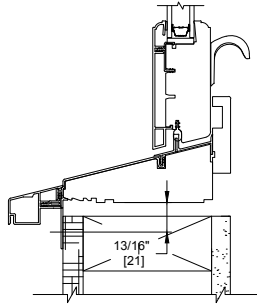

Standard Sill Nose.
Add 13/16" (21mm) to
Frame Dimension at Sill.

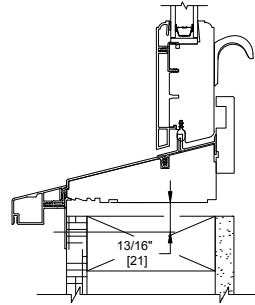

Standard Sill Nose.
Add 13/16" (21mm) to
Frame Dimension at Sill.

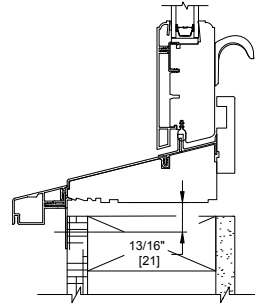

Standard Sill Nose.
Add 13/16" (21mm) to
Frame Dimension at Sill.

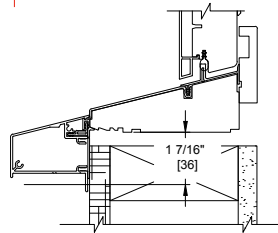
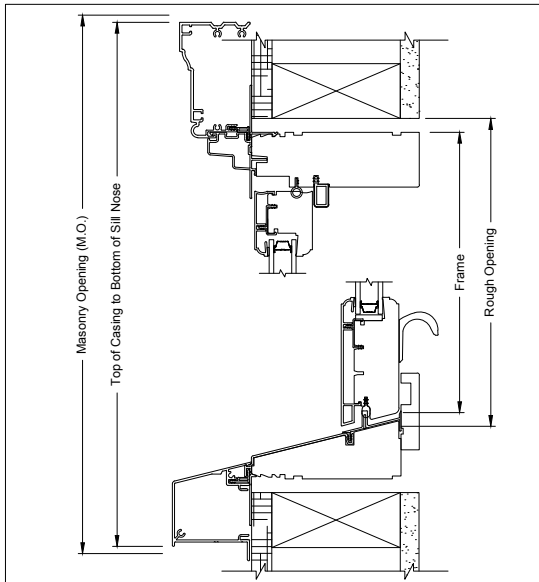

BC Sill Nose.
Add 1 7/16" (36mm) to
Frame Dimension at Sill.

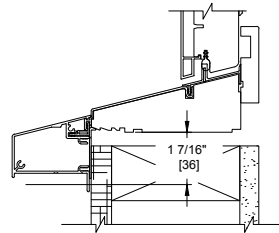

BC Sill Nose.
Add 1 7/16" (36mm) to
Frame Dimension at Sill.

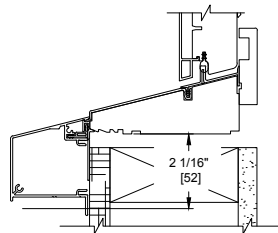

Heritage Sill Nose.
Add 2 1/16" (52mm) to
Frame Dimension at Sill.

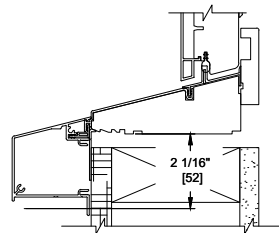

Heritage Sill Nose.
Add 2 1/16" (52mm) to
Frame Dimension at Sill.

Note: • Other jamb widths available.

Masonry Opening Metal Clad - Double Hung

Casing Options

Nose & Cove Casing.
Add 1 9/16" (40mm) to
Frame Dimensions at
Head & Sides.

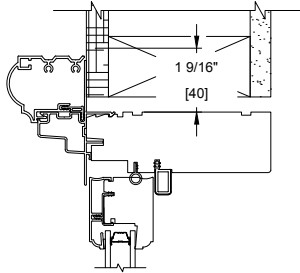

Adams Casing.
Add 3 3/16" (81mm) to
Frame Dimensions at
Head & Sides.

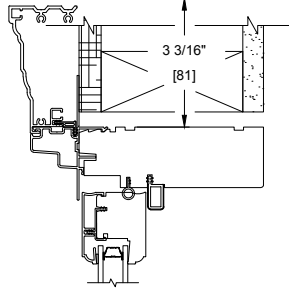

Williamsburg Casing.
Add 3 3/16" (81mm) to
Frame Dimensions at
Head & Sides.

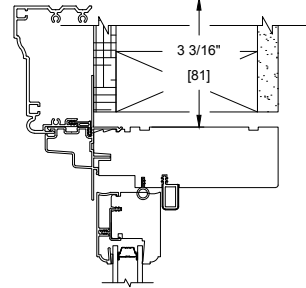

Sill Nose Options

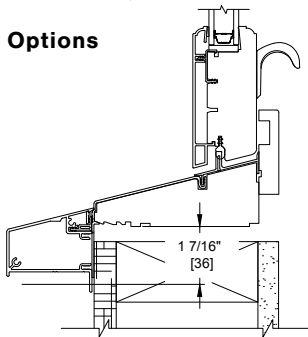

BC Sill Nose.
Add 1 7/16" (36mm) to
Frame Dimension at Sill.

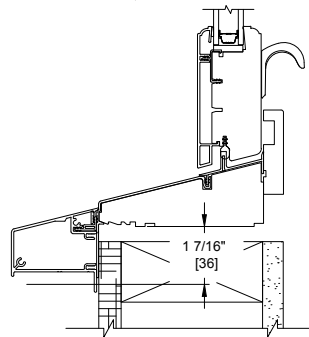

BC Sill Nose.
Add 1 7/16" (36mm) to
Frame Dimension at Sill.

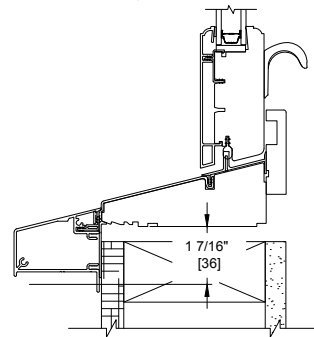

BC Sill Nose.
Add 1 7/16" (36mm) to
Frame Dimension at Sill.

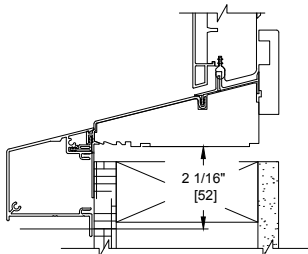

Heritage Sill Nose.
Add 2 1/16" (52mm) to
Frame Dimension at Sill.

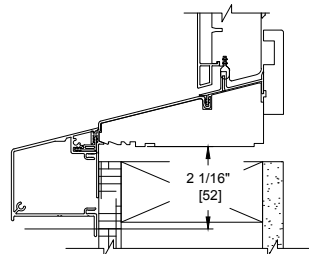

Heritage Sill Nose.
Add 2 1/16" (52mm) to
Frame Dimension at Sill.

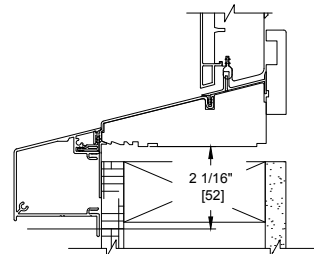

Heritage Sill Nose.
Add 2 1/16" (52mm) to
Frame Dimension at Sill.

EXAMPLE #1: DH1 2828 with Frame Cladding Only & Standard sill nose.

Frame dimensions, 33 1/16" (859mm) x 64 1/14" (1632mm).

Masonry width = 33 13/16" (859mm) + [3/16" (5mm) x 2] = 34 3/16" (869mm)

Masonry height = 64 1/14" (1632mm) + 3/16" (5mm) + 13/16" (21mm) = 65 1/4" (1658mm)

EXAMPLE #2: DH1 3238 with Nose & Cove casing & Heritage sill nose.

Frame dimensions, 37 13/16" (961mm) x 84 1/4" (2140mm).

Masonry width = 37 13/16" (961mm) + [1 9/16" (40mm) x 2] = 40 15/16" (1041mm)

Masonry height = 84 1/4" (2140mm) + 1 9/16" (40mm) + 2 1/16" (52mm) = 87 7/8" (2232mm)

Note: • Other jamb widths available.

Masonry Opening Wood Exterior

Casing Options

2" BRICKMOULD.
ADD 1 9/16" (39 mm) TO FRAME DIMENSIONS AT HEAD & SIDES.

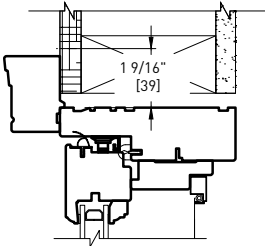

3 1/2" FLAT CASING.
ADD 3 3/16" (78 mm) TO FRAME DIMENSIONS AT HEAD & SIDES.

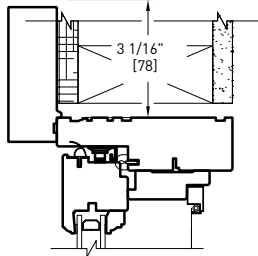

5 1/2" FLAT CASING.
ADD 5 1/16" (129 mm) TO FRAME DIMENSIONS AT HEAD & SIDES.

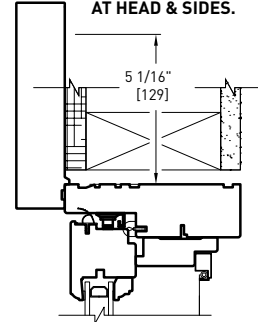

Sill Nose Options

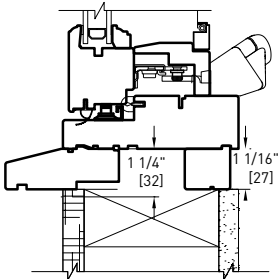

STANDARD SUB SILL.
ADD 1 1/4" (32 mm) TO FRAME DIMENSION AT SILL.

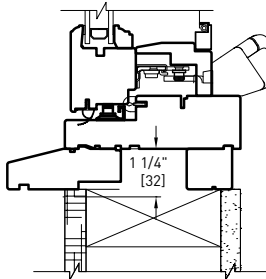

STANDARD SUB SILL.
ADD 1 1/4" (32 mm) TO FRAME DIMENSION AT SILL.

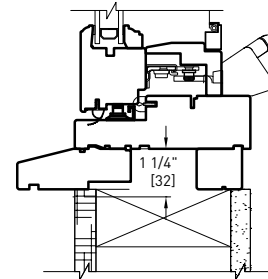

STANDARD SUB SILL.
ADD 1 1/4" (32 mm) TO FRAME DIMENSION AT SILL.

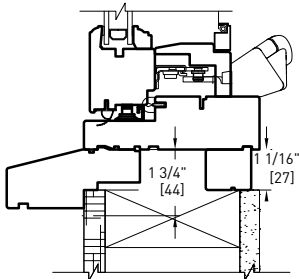

BC SUB SILL.
ADD 1 3/4" (44 mm) TO FRAME DIMENSION AT SILL.

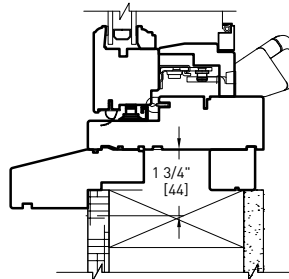

BC SUB SILL.
ADD 1 3/4" (44 mm) TO FRAME DIMENSION AT SILL.

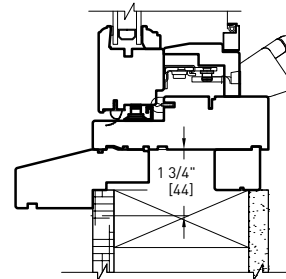

BC SUB SILL.
ADD 1 3/4" (44 mm) TO FRAME DIMENSION AT SILL.

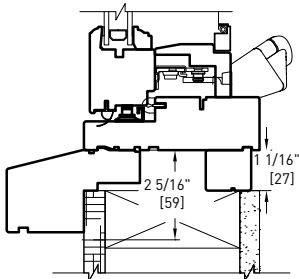

HERITAGE SUB SILL.
ADD 2 5/16" (59 mm) TO FRAME DIMENSION AT SILL.

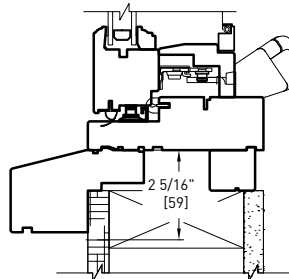

HERITAGE SUB SILL.
ADD 2 5/16" (59 mm) TO FRAME DIMENSION AT SILL.

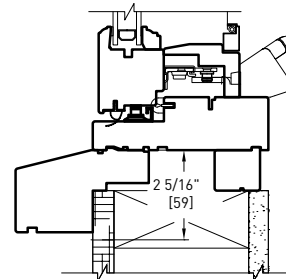

HERITAGE SUB SILL.
ADD 2 5/16" (59 mm) TO FRAME DIMENSION AT SILL.

Note: • Other jamb widths available.

Masonry Opening Wood Exterior

Casing Options

ADAMS CASING.
ADD 2 11/16" (69 mm)
TO FRAME DIMENSIONS
AT HEAD & SIDES.

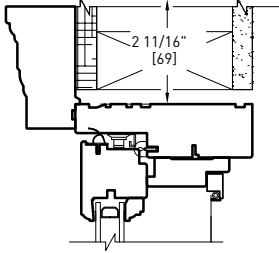

WILLIAMSBURG CASING.
ADD 2 11/16" (69 mm)
TO FRAME DIMENSIONS
AT HEAD & SIDES.

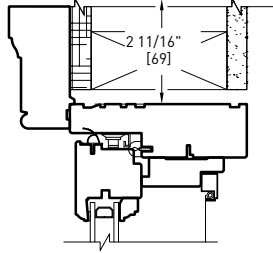

Sub Sill Options

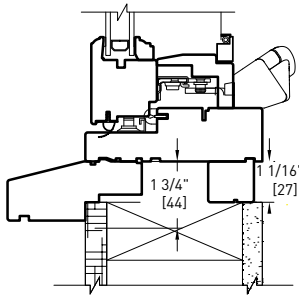

BC SUB SILL.
ADD 1 3/4" (44 mm) TO FRAME
DIMENSION AT SILL.

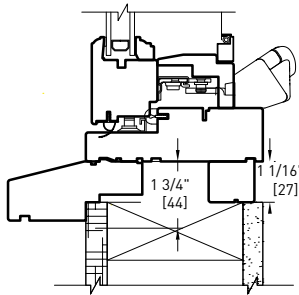

BC SUB SILL.
ADD 1 3/4" (44 mm) TO FRAME
DIMENSION AT SILL.

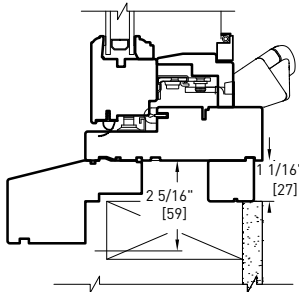

HERITAGE SUB SILL.
ADD 2 5/16" (59 mm) TO
FRAME DIMENSION AT SILL.

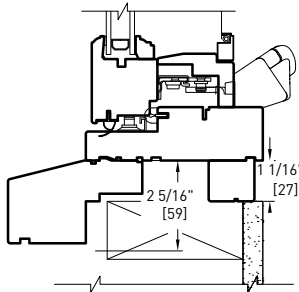

HERITAGE SUB SILL.
ADD 2 5/16" (59 mm) TO
FRAME DIMENSION AT SILL.

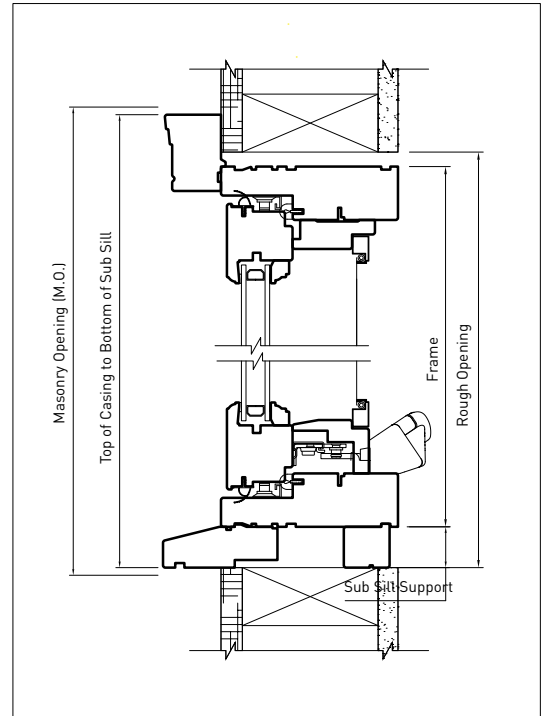

EXAMPLE #1: CA1 7515 with 2" Brickmould & Standard sill nose.
Frame dimensions, 29 1/2" (750mm) x 59 1/16" (1500mm).
Masonry width = 29 1/2" (750mm) + [1 9/16" (39mm) x 2] = 32 5/8" (828mm)
Masonry height = 59 1/16" (1500mm) + 1 9/16" (39mm) + 1 1/4" (32mm) = 61 15/16" (1571mm)

EXAMPLE #2: CA1 0918 with Adams casing & BC sill nose.
Frame dimensions, 35 7/16" (900mm) x 70 7/8" (1800mm).
Masonry width = 35 7/16" (900mm) + [2 11/16" (69mm) x 2] = 40 13/16" (1038mm)
Masonry height = 70 7/8" (1800mm) + 2 11/16" (69mm) + 1 3/4" (44mm) = 75 5/16" (1913mm)

Note: • Other jamb widths available.

Masonry Clip Installation Universal

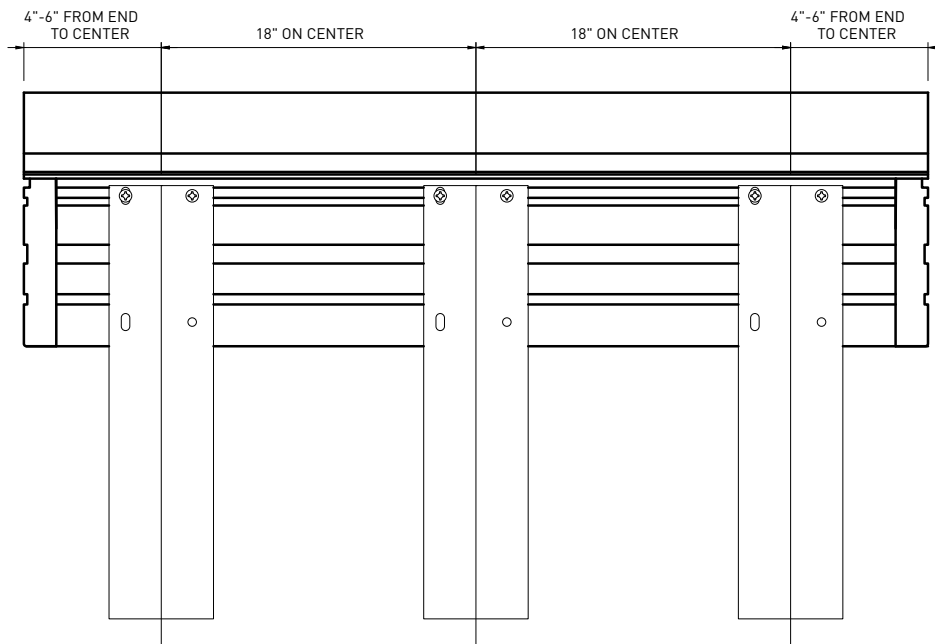

1. Start installation of masonry clips 4" to 6" from the ends of the unit to the center of the clip.
 2. After placing both of the outermost clips on the unit, install the remainder of the clips moving inward to the center of the unit, placing each clip approximately 18" on center.
 3. Fasten clips to unit using two 5/8" #8 Panhead screws.
-

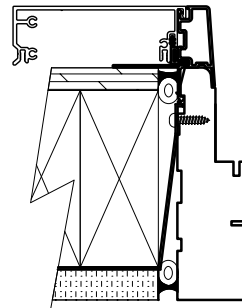
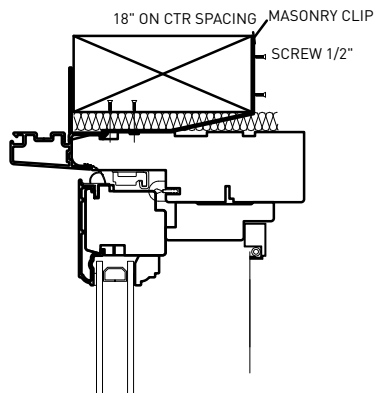

32mm Jamb Extension (1 1/4")

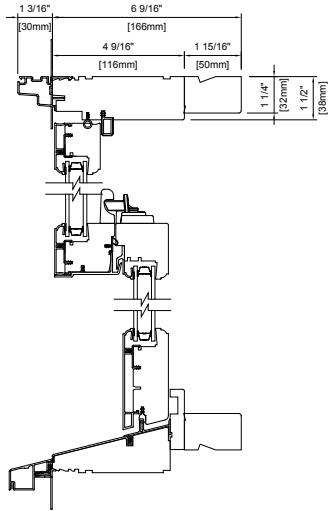

Double Hung [DH1]

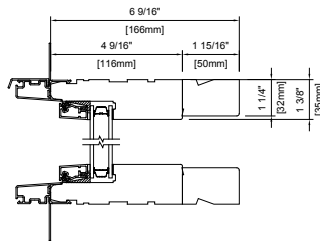

Picture [PS1]

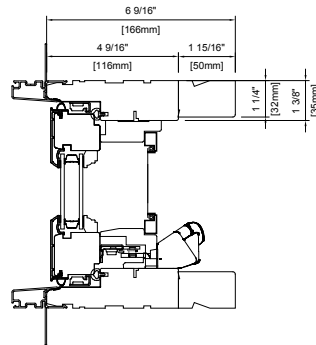

Casement [CA1]

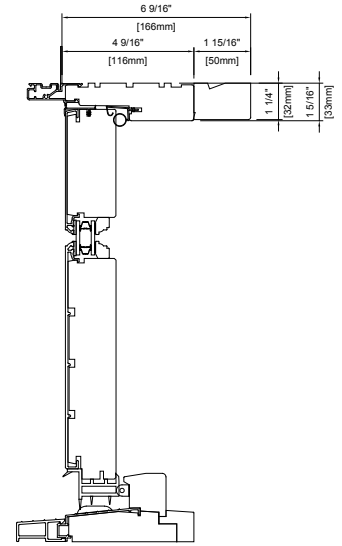

Outswing Terrace Door [TD1]

Metal Clad Spread Mullions

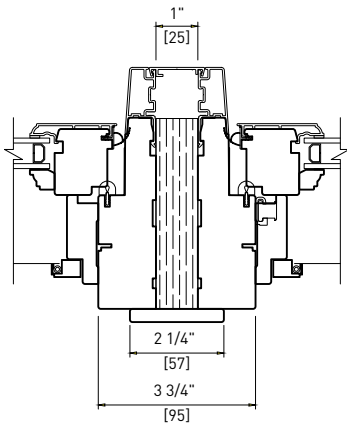

**1" (25 mm) SOLID FIR
SPREAD MULLION**

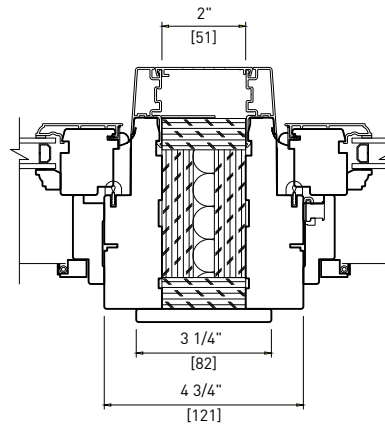

**2" (51 mm)
SPREAD MULLION**

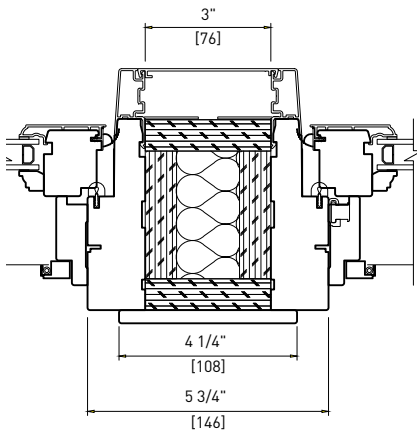

**3" (76 mm)
SPREAD MULLION**

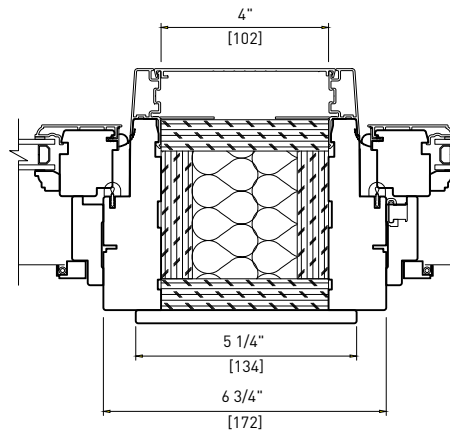

**4" (102 mm)
SPREAD MULLION**

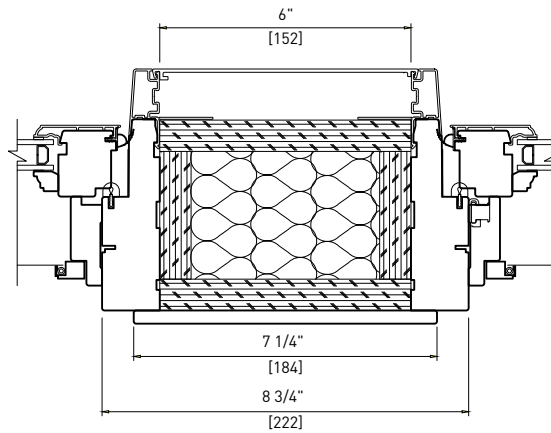

**6" (152 mm)
SPREAD MULLION**

Note:

- Other jamb widths available.
- All dimensions to have +/- 1/16" (2mm) tolerance.

Metal Clad Stud Pocket Detail

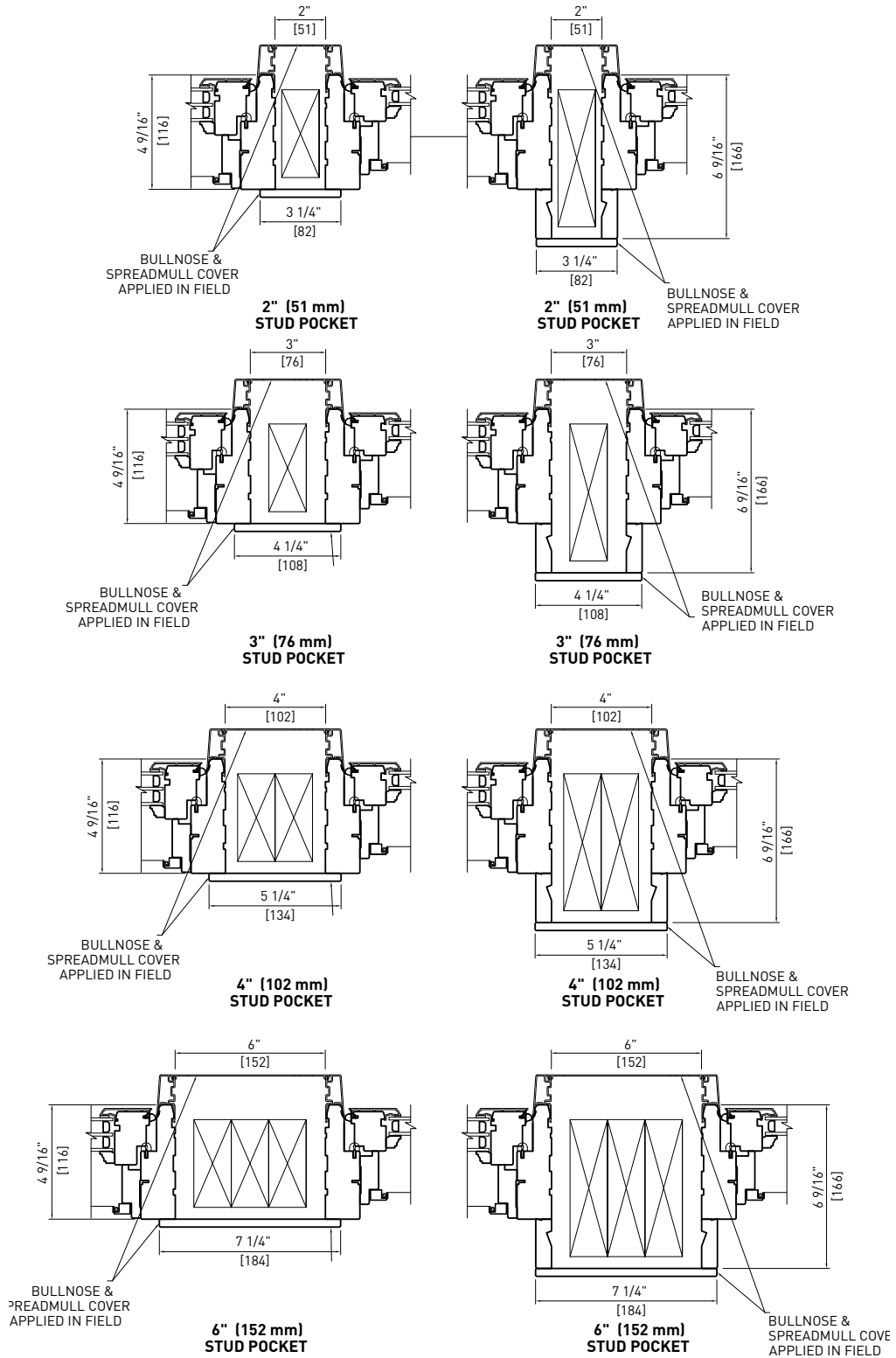

Note:

- Other jamb widths available.
- All dimensions to have +/- 1/16" (2mm) tolerance.
- Framing member designed and supplied by others.

Metal Clad Stud Pocket Detail - Double Hung

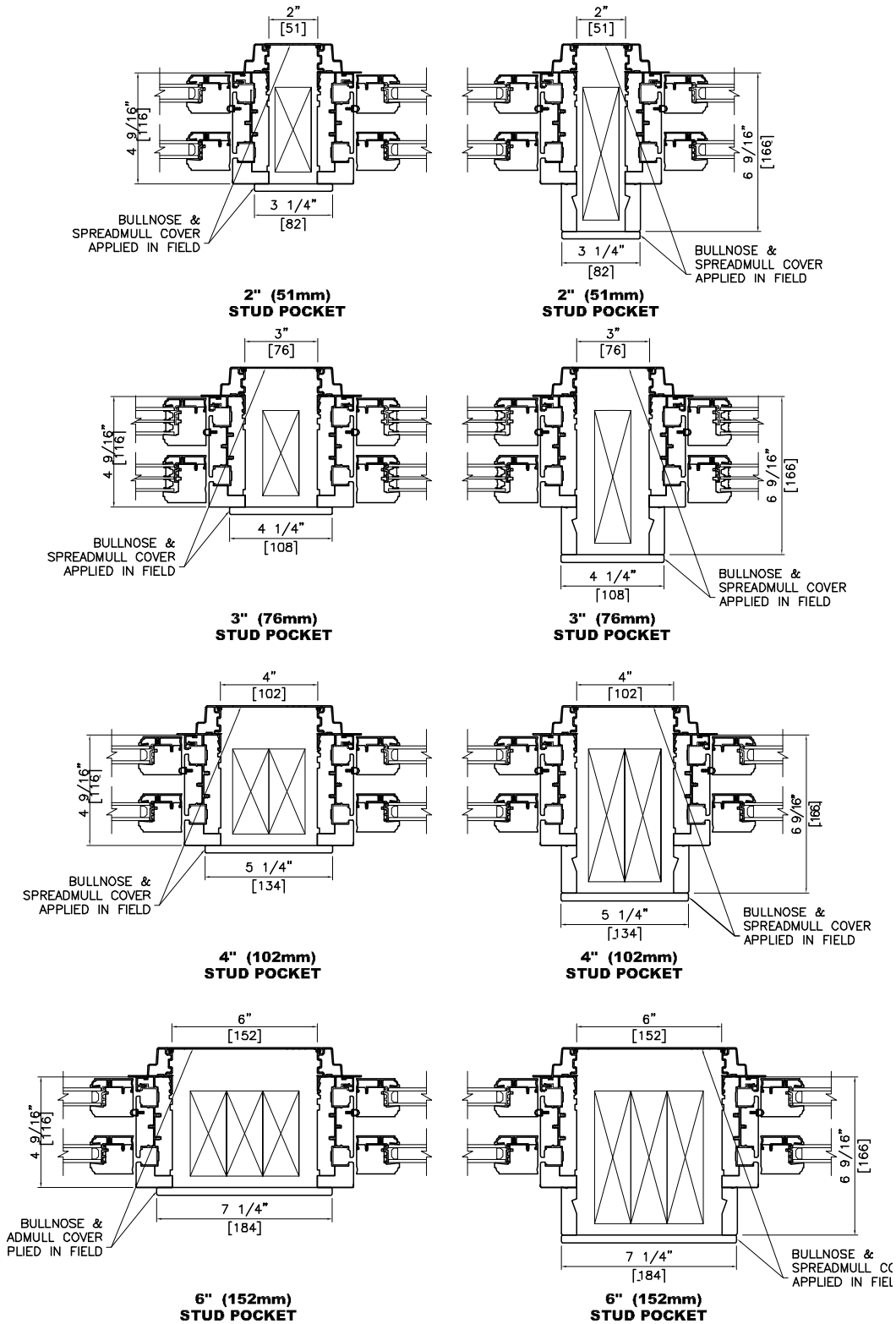

Note:

- Other jamb widths available.
- All dimensions to have +/- 1/16" (2mm) tolerance.
- Framing member designed and supplied by others.

Wood Exterior Spread Mullions

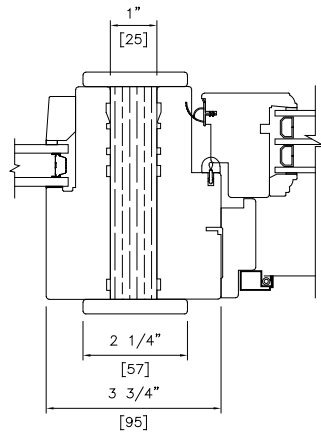

1" (25mm) SOLID FIR
SPREAD MULLION

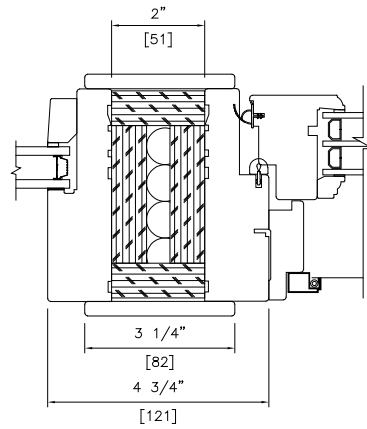

2" (51mm)
SPREAD MULLION

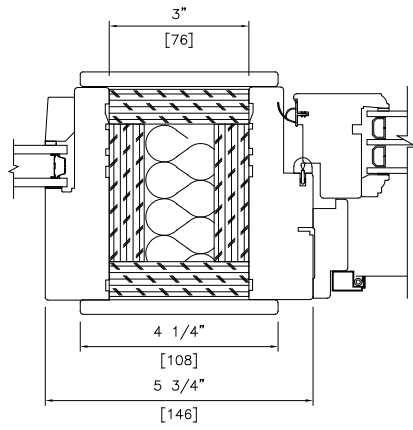

3" (76mm)
SPREAD MULLION

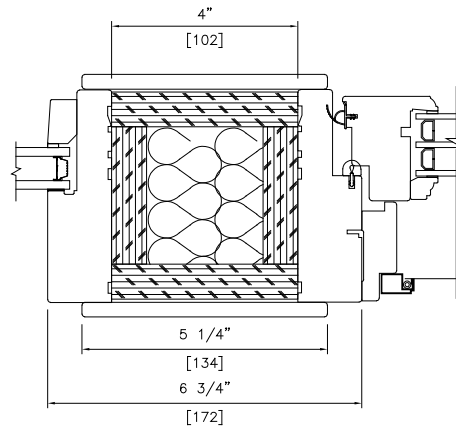

4" (102mm)
SPREAD MULLION

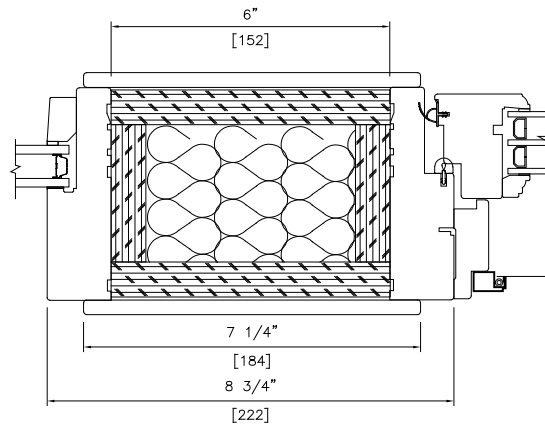

6" (152mm)
SPREAD MULLION

Note:

- Other jamb widths available.
- All dimensions to have +/- 1/16" (2mm) tolerance.

Wood Exterior Stud Pocket Detail

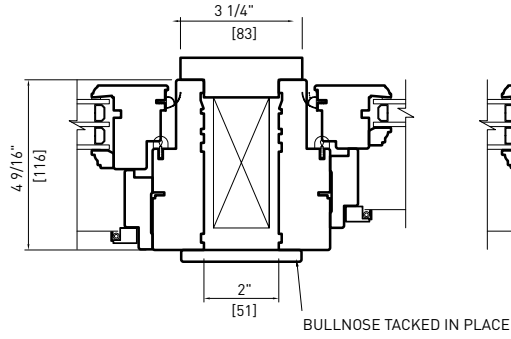

**2" (51 mm)
STUD POCKET**

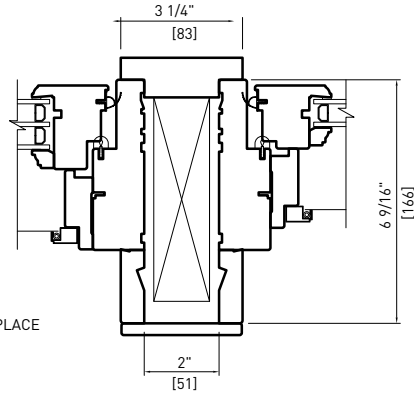

**2" (51 mm)
STUD POCKET**

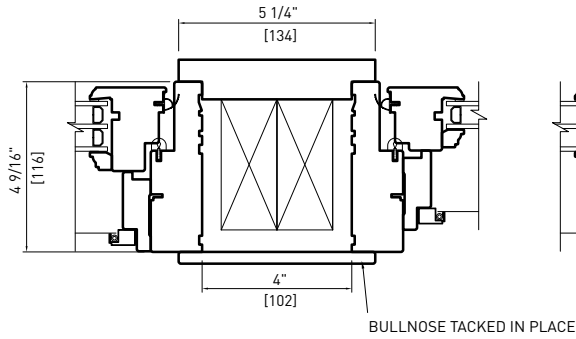

**4" (102 mm)
STUD POCKET**

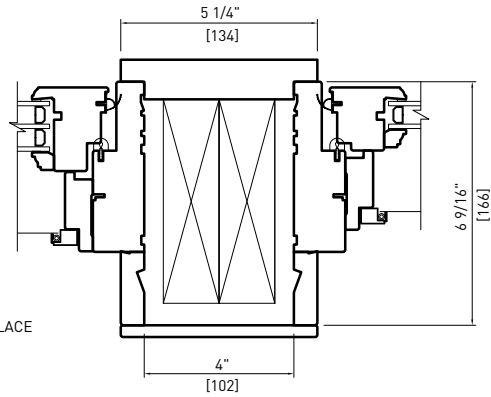

**4" (102 mm)
STUD POCKET**

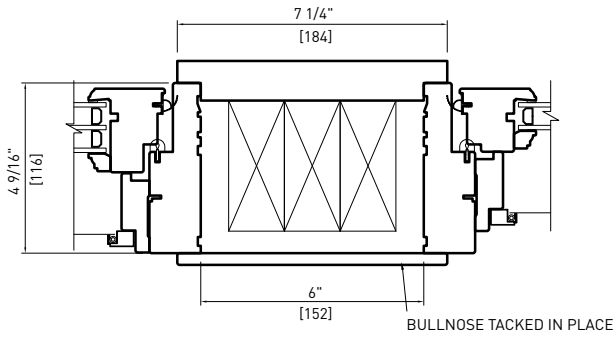

**6" (152 mm)
STUD POCKET**

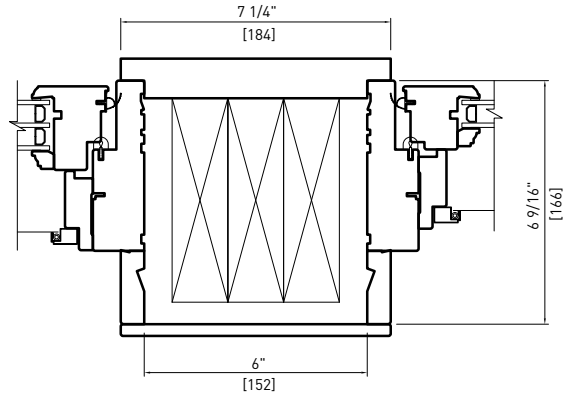

**6" (152 mm)
STUD POCKET**

- Note:**
- Other jamb widths available.
 - All dimensions to have +/- 1/16" (2mm) tolerance.
 - Framing member designed and supplied by others.

Wood Exterior Stud Pocket Detail - Double Hung

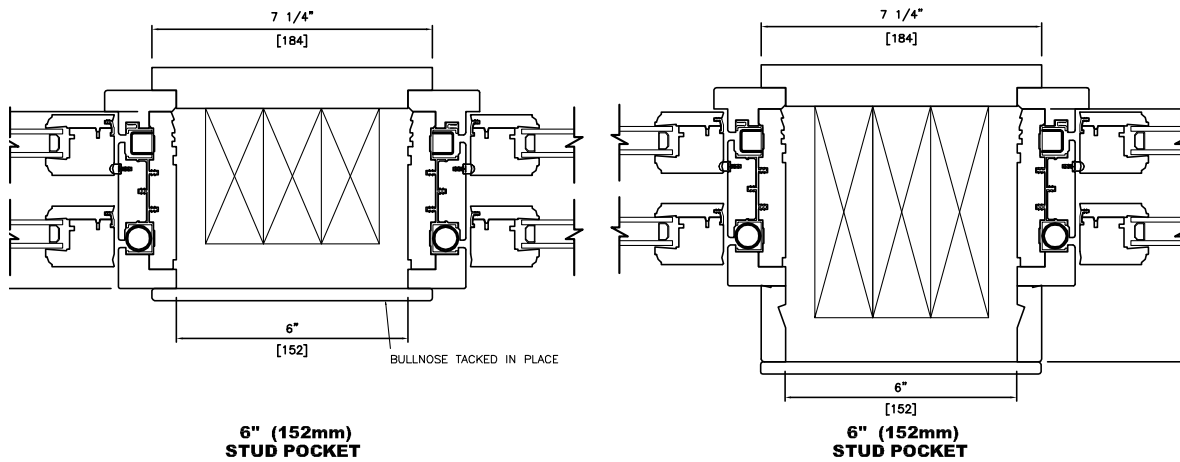
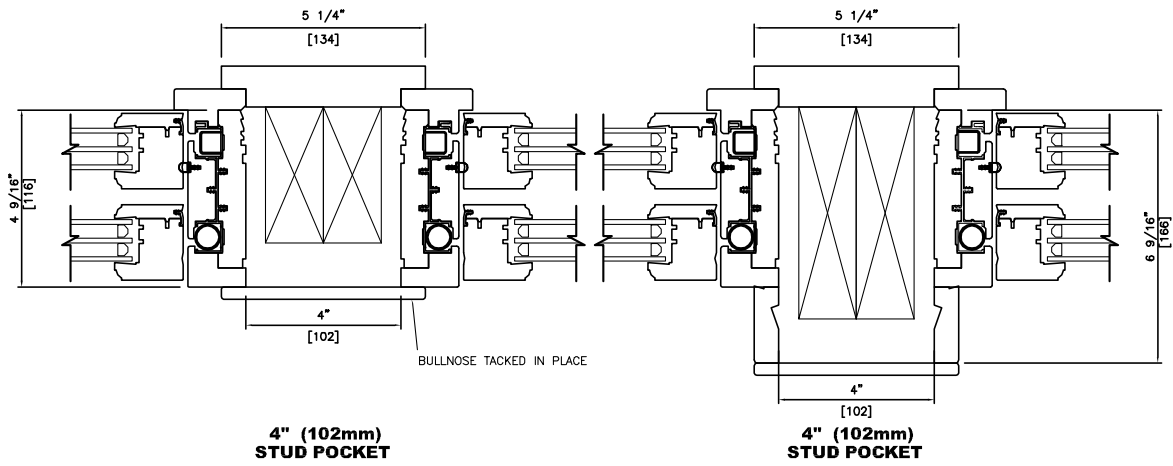
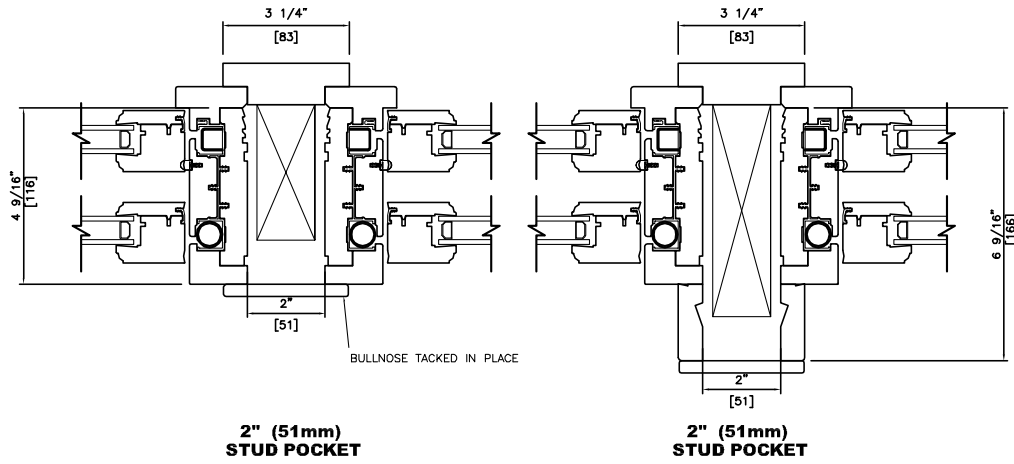

Note:

- Other jamb widths available.
- All dimensions to have +/- 1/16" (2mm) tolerance.
- Framing member designed and supplied by others.

Attribution

A Cover	Nastasi Architects - David Hartz Photography
A12	Marc Lemoine Architecture - Metaphysical
A14	Westrust - Cascade
A18	Landmark Builders - Landmark Residence
A28	McGlashan Architecture - Mill Valley House
A5	MAI Design Group - Pronghorn Clubhouse
A5	Republic Architecture - West Hawk Cabin
A5	Square Three Design Studios - FULTON
A6	Smith & Vasant Architects - Contemporary Weekend Home
A7	Schwartz and Architecture - Crook Cup Bow Twist, Schwartz and Architecture
A8	Republic Architecture - West Hawk Cabin
A9	Sharratt Design & Company - Remodeled Elegance on the Lake
B Cover	Nautilus Architects - Poolhouse
C Cover	TEA2 Architects - Lake Superior Residence
D Cover	Steve Wisenbaker Architects - Paul Dyer Photography - FEMA House
E Cover	Robson Bilgen Architects - New England Country House
F Cover	Victorian
G Cover	Photography by Landmark Photography, Courtesy of John Kraemer & Sons, Eskuche Design - Monaco Inspired Manor
H Cover	E3 Architecture - Windermere Project
J Cover	Sage Architects - Spa House
K Cover	Jakobsen Associates - Home in First Shaughnessy
L Cover	Landmark Builders - Landmark Residence
M Cover	Pismo House
N Cover	Nastasi Architects - David Hartz Photography
P Cover	Sharratt Design & Company - Remodeled Elegance on the Lake

Information subject to change without notice.

Distributed by Loewen Inc. in the USA and C.P. Loewen Enterprises Ltd. in Canada and internationally. Trade Marks owned by C.P. Loewen Enterprises Ltd. Used under license. © C.P. Loewen Enterprises Ltd. All rights reserved.



Recycled Paper
Printed in Canada
P2985A_1219