



Operating and installation instructions - INOA cellar conditioners

CONTENTS

WELCOME TO THE WORLD OF EUROCAVE	p.4
1 • CONDITIONER DESCRIPTION	p.5
2 • IMPORTANT SAFETY RECOMMENDATIONS	p.6
3 • ELECTRICAL POWER SUPPLY	p.6
4 • CARE FOR THE ENVIRONMENT AND ENERGY SAVING	p.6
5 • TECHNICAL SPECIFICATIONS	p.7
6 • CELLAR INSULATION	p.8
7 • INSTALLING YOUR CONDITIONER	p.9
I- General points	p.9
II- Drilling the wall	p.10
III- Fitting	p.10
Venting plate and wall mounting bracket dimensions	p.11
IV- Discharging condensate	p.13
8 • CONDITIONER OPERATION	p.14
9 • INSTALLING THE REMOTE CONTROL	p.15
I- Remote control description	p.15
II- Installing the remote control inside the cellar	p.15
III- Installing the remote control outside the cellar	p.16
10 • COMMISSIONING YOUR CONDITIONER	p.18
I- Connection	p.18
II- Switching on	p.18
III- Remote control description	p.18
IV- Installing the remote control	p.19
V- Setting the temperature	p.19
VI- Silent function	p.20
VII- “Heating” function	p.20
VIII- Changing the remote control batteries	p.20
IX- Discharging condensate	p.20
11 • MAINTENANCE	p.21
12 • OPERATING FAULTS	p.21

Solutions to meet all your needs

WINE CABINETS

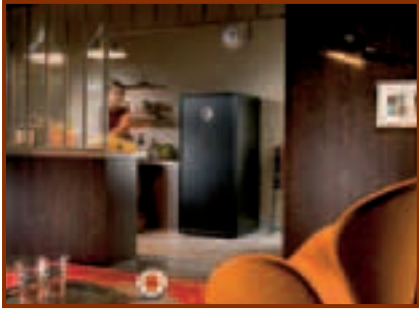

Origine



Classic



Compact



Leather



Meuble à Vins



Sommelier



Elite

STORAGE SYSTEMS



Modulothèque



Modulocube



Modulorack

CELLAR CONDITIONERS

SYSTEM TO SERVE WINES BY THE GLASS



Inoa*



Vin au Verre*

* Product not available in certain countries.

WELCOME TO THE WORLD OF EUROCAVE

Our greatest wish is to accompany your enthusiasm for wine throughout the years...

To do so, EuroCave puts all of its know-how into action to bring together the essential factors in optimal wine maturing:

Temperature:

The two worst enemies of your wine are extreme temperatures and sudden fluctuations in temperature.

A constant temperature of 10° to 14°C (50 to 57°F) is considered to be ideal for your wine to reach its full potential.

Owing to its electronic regulation system, your EuroCave INOA conditioner is activated as soon as the cellar temperature rises one degree above the programmed temperature. Furthermore, the presence of a heater built into the air distributor protects your wine from any significant fall in temperature.

Humidity:

This is an essential factor, enabling corks to retain their sealing qualities. The level of humidity must be higher than 50% (ideally between 60 and 75 %).

By maintaining a constant evaporation temperature, above 0°C, your EuroCave INOA conditioner ensures minimal drying out of the air of your cellar and an ideal level of humidity.

Protection from light:

Light, and more especially its ultra-violet component, will rapidly prove noxious to your wine by irreversible oxidation of its tannins. For this reason we strongly advise that wines be stored in the dark, far from U.V. light.

Protection from vibration:

Vibration disturbs the slow process of your wine's biochemical evolution, and is often fatal for the finest wines.

The housing of your EuroCave conditioner is fully sound-proofed (by 20 mm polyethylene foam) and the compressor and fans are fitted with silent blocks to absorb any residual vibration.

Natural aeration:

A constant supply of air from the outside is also indispensable.

All of these specific features can be found in the EuroCave INOA conditioner you have bought. We thank you for the confidence you have placed in us.

Usual wine serving temperatures

French wines

Alsace	10°C
Beaujolais	13°C
Bordeaux Sweet White	6°C
Bordeaux Dry White	8°C
Bordeaux Red	17°C
Bourgogne White	11°C
Burgundy Red	18°C
Champagne	6°C
Jura	10°C
Languedoc-Roussillon	13°C
Provence Rosé	12°C
Savoie	9°C
Vins de Loire Dry White	10°C
Vins de Loire Sweet	7°C
Vins de Loire Red	14°C
Vins du Rhône	15°C
Vins du Sud Ouest Sweet	7°C
Vins du Sud Ouest Red	15°C

Australian wines

Cabernet franc	16°C
Cabernet sauvignon	17°C
Chardonnay	10°C
Merlot	17°C
Muscat à petit grain	6°C
Pinot noir	15°C
Sauvignon White	8°C
Semillon	8°C
Shiraz	18°C
Verdhelo	7°C

Other wines

California	16°C
Chile	15°C
Spain	17°C
Italy	16°C

I - CONDITIONER DESCRIPTION

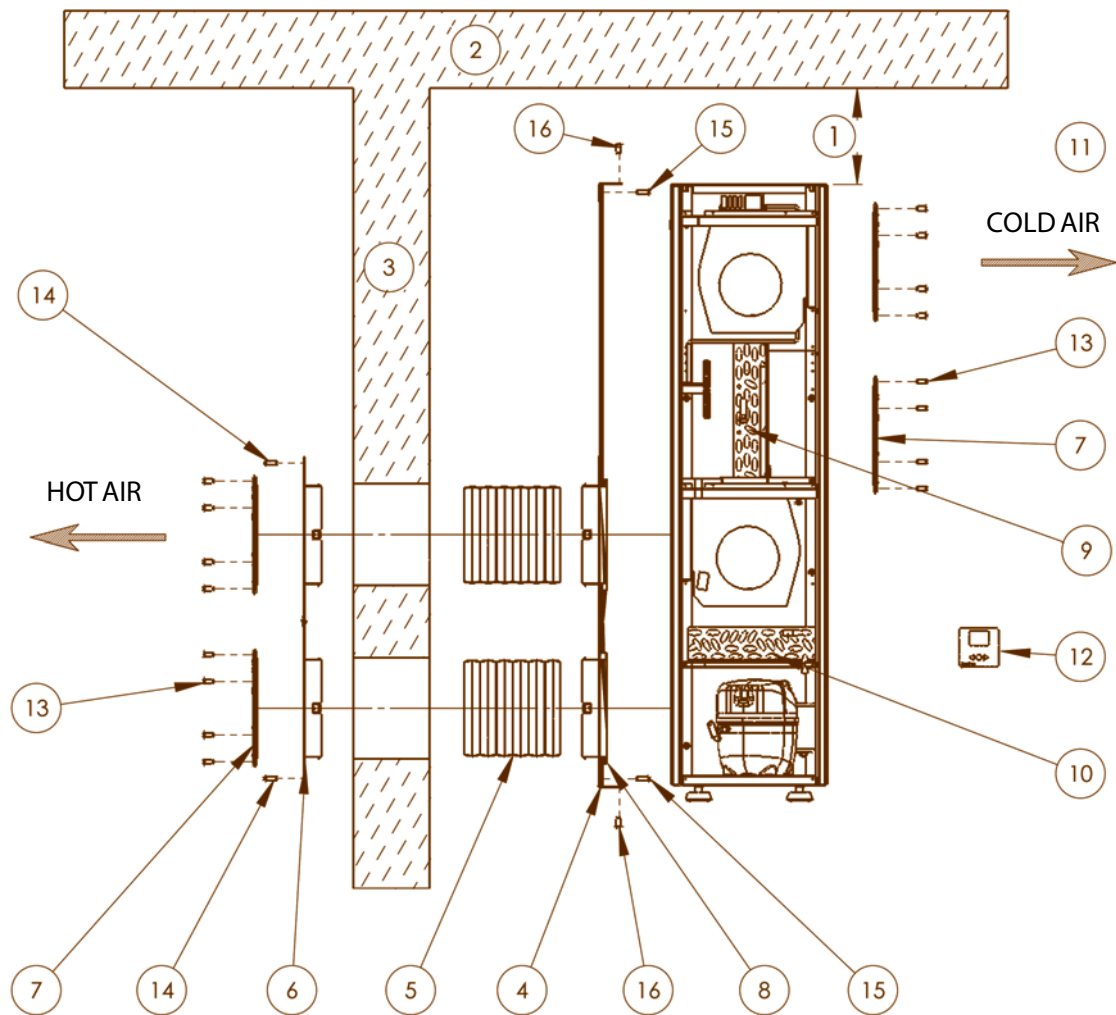

- | | |
|---|---|
| 1 - Conditioner / ceiling distance: 200 mm min. | 10 - Condenser, to be cleaned regularly |
| 2 - Ceiling | 11 - Inside of cellar |
| 3 - Cellar wall | 12 - Remote control |
| 4 - Metal mounting frame | 13 - Grid securing screws (quantity: 24) |
| 5 - Flexible ducting | 14 - Aesthetic front panel securing screws (quantity: 4) |
| 6 - Aesthetic front panel | 15 - Screws to fix frame to the wall (quantity: 4) |
| 7 - Grid, to be cleaned regularly (see p.11) | 16 - Screws to fix conditioner to the frame (quantity: 4) |
| 8 - Mounting frame / conditioner seal | |
| 9 - Evaporator, to be cleaned regularly | |



2 - IMPORTANT SAFETY RECOMMENDATIONS

Warning

When using your conditioner, you should always observe certain basic precautions, especially:

Never use your conditioner for anything other than its specific purpose as described in this guide.

Never unplug the conditioner by pulling on the supply lead. Take a firm hold on the plug and pull out smoothly in a straight line from the wall socket.

If the power lead is damaged, it must be replaced by a qualified electrician.

Do not allow children to climb, sit, stand on or hang from the conditioner. They could damage the conditioner, as well as badly hurting themselves.

 Never damage your appliance's refrigeration unit.



3 - ELECTRICAL POWER SUPPLY

For your personal safety, the conditioner must be correctly earthed.

Your conditioner's power lead is supplied without a plug. Installation of a power plug or connection of the conditioner to a junction box must be carried out by a qualified electrician.

In all cases, the connection of your conditioner must be carried out on an earthed socket to prevent any risk of electric shock.

Have an electrician carry out the installation. He will tell you whether or not the socket is correctly earthed and, if necessary, will perform any work required to bring your installation in line with standards.

IMPORTANT: any electrical work must be carried out by a qualified electrician.

Electric connection must be carried out by means of a device to ensure isolation from the mains system. The isolating device should open all of the contacts of all the poles ensuring complete disconnection in line with the conditions in over-voltage category III. Installation must be carried out in compliance with national installation regulations.

Should you move to another country, check that the conditioner's electrical rating (see grey identification label) complies with the country (voltage, frequency).

Ensure that the plug (230V – 13 A*) is correctly earthed and that your installation is protected by a differential circuit breaker (30 mA*).

*not valid for some countries



4 - CARE FOR THE ENVIRONMENT AND ENERGY SAVING

Disposal of packaging

The packaging used by EuroCave is made of recyclable materials.

After unpacking your conditioner, take the packaging to a waste disposal centre. For the most part it will be recycled.

Recycling: A caring gesture

Electrical and electronic equipment have potentially hazardous effects on the environment and public health due to the presence of noxious substances.

You should therefore never dispose of electrical or electronic equipment with unsorted municipal waste.

When buying a new EuroCave product (wine cabinet, cellar conditioner, Vin au Verre), you can take advice about the recycling of your old appliance from your EuroCave dealer.



In compliance with legal provisions covering respect and care for the environment, your conditioner does not contain CFCs.

Energy saving

- Install your conditioner in an appropriate place and within the recommended temperature ranges.
- Keep the door open for as short a time as possible.

N.B.: Care for the environment: when replacing your conditioner, consult your local municipal refuse department in order to observe the appropriate recycling procedure.

For refrigerant gases, substances and some parts contained in the conditioner, EuroCave uses recyclable materials which require a special packaging disposal procedure to be followed.

Place unusable appliances out of use by unplugging them.



5 - TECHNICAL SPECIFICATIONS

INOA CELLAR CONDITIONER

inoA

FUNCTION

The purpose of the cellar conditioner is to climate control any kind of fully insulated room creating an ideal wine cellar environment by monitoring and adjusting the temperature and humidity.

TECHNOLOGY

The conditioner's housing is dampened against sound and the compressor and fans are fitted with silent blocks to absorb any residual vibration.

A quiet conditioner: the system automatically adjusts speeds to ambient temperature conditions, combined with the use of particularly quiet fans, allows the conditioner to operate very discreetly.

Energy efficiency: Inoa conditioners use the compressor infrequently, insulation between the condenser and the evaporator minimises any exchange between the cold and hot sections of the appliance, thus favouring energy efficiency.

The Inoa come as standard with the hot air discharge opposite the cold air exit. It can be ordered with the hot air exit on the left or the right side as an option.



SPECIFICATIONS

<u>INOA 25</u>	<u>INOA 50</u>
<p>EuroCave Inoa 25 Cellar conditioner Dimension W385 x D322 x H1250 mm Weight: 43 KG Power supply 230V / 50 Hz Volume up to 25 m3 (*) Cooling Capacity 600W Electrical Power 500W (**) Heater element 650W Cooling Gas: R134a External Temp -5°C to 35°C Noise level: 44dbA – 50dbA Supplied with a 3.50 m power lead without plug Ref: INOA 25</p>	<p>EuroCave Inoa 50 Cellar conditioner Dimension W385 x D322 x H1250 mm Weight: 46 KG Power supply 230V / 50 Hz Volume up to 50 m3 (*) Cooling Capacity 1200W Electrical Power 800W (**) Heater element 650W Cooling Gas: R134a External Temp -5°C to 35°C Noise level: 44dbA – 50dbA Supplied with a 3.50 m power lead without plug Ref: INOA 50</p>

* for an isolated wine cellar following our advice please refer to our insulation guide

** for an internal temperature of 12°C and an external temperature of 32°C

Important information

For insulation, installing, positioning and more please make sure you have read our Installation guide and our Insulation guide.



2 - TECHNICAL SPECIFICATIONS

	Dimensions in mm	Power supply	Sample volume m ³	Cooling capacity W	Weight Kg	Electrical power W	Heating resistance W	Refrigerant	External temperatures
Inoa 25	W385 x D322 x H1250	230V / 50 Hz	up to 25 m ³ *	600W**	43 Kg	550W**	650W	R134a (without CFCs)	-5°C to 35°C
Inoa 50	W385 x D322 x H1250	230V / 50 Hz	up to 50 m ³ *	1200W**	46 Kg	800W**	650W	R134a (without CFCs)	-5°C to 35°C

* in a very well insulated room - ** for an internal temperature of 12° C and an external temperature of 32° C.
Supplied with a 3.50 m power lead without plug.



3 - CELLAR INSULATION

Traditional building materials such as stone, concrete and brick are very poor insulators and only underground sections represent any real insulation. It is therefore essential, in the majority of cases, to insulate the entire room to be conditioned.

Insulate – yes but how?

We recommend that you use extruded polystyrene, currently the most efficient product on the market. It is the least flammable and the most durable material. It also has the advantage of not being attacked by rodents. Furthermore, extruded polystyrene boards can be layered and therefore prevent thermal bridges. To increase your conditioner's lifespan and reduce electricity consumption, we recommend that you use extruded polystyrene which is at least 80 mm thick.

80 mm of extruded polystyrene provides the same amount of insulation as a 5m thick stone wall.

The insulation must be completely continuous (no gaps).

Insulation boards: different methods of fitting are possible

How can you determine whether or not a material is a good insulator? The insulation performance of a material is established by its R thermal resistance (m².°C/W). It determines the material's ability to conduct heat.

$R = e/\lambda$ - The greater the R coefficient, the better the insulation. (λ = thermal conductivity coefficient)

There are 3 types of insulation boards:

Insulator only, complex (with plaster cover) or sandwich (plaster both sides)

Depending on the type of insulator chosen, several methods of fitting are possible:

• Against the walls

- Standard extruded polystyrene board: pre-cut to the dimensions of the area to be conditioned, they are fitted using high-bond mortar. For a more acceptable finish, it is possible to fix rails onto which you screw the plaster board panels over the polystyrene.

- Sandwich or complex boards: the polystyrene is already integrated into the plaster board.

Whatever the method used, all kinds of decorative finishes are possible to obtain an attractive wall.

If you only want to condition a section of your room, install a plaster board dividing wall then insulate the side of the room to be conditioned.

N.B.: Before being insulated, walls must be clean. If they are too damp, clean them with a wire brush then clean with a high pressure water jet and paint with an emulsion paint.

• On the ceiling and door

The process for insulating the ceiling and door is identical to that of the walls. We recommend that you use extruded polystyrene.

• On the floor (insulation optional)

- Original clay floor: not insulating favours the passage of humidity, which is good for the wine.

- Concrete floor (for example): Concrete is a very poor insulator. A few centimetres of fine gravel can, in some cases, improve insulation.



It is essential that the surface material used for the floor (whether or not covering insulation) can support the weight of wine racks and has resistance to compression.

Tools required

- handsaw, tape measure, bricklayer's ruler, trestles, screwdriver or screw gun, drill, hammer, level, plumb line, wood mallet, spatula, precision knife...

7 - INSTALLING THE CONDITIONER



I - General points

- If the power lead is damaged, it must be replaced by a qualified electrician.
- Never damage the appliance's refrigerating circuit.

Your conditioner's power lead is supplied without a plug. "Fitting a power plug or connecting the conditioner to a junction box must be carried out by a qualified electrician.

In all cases, connection of your conditioner must be carried out on an earthed socket to prevent any risk of electric shock.

230V-13A* earthed power outlet with differential circuit breaker (30mA*) protected by a fuse.

*not valid for some countries

IMPORTANT : any electrical work must be carried out by a qualified electrician. Power outlet not valid for some countries.

Electric connection must be carried out by means of a device to ensure isolation from the mains system. The isolating device should open all of the contacts of all the poles ensuring complete disconnection in line with the conditions in over-voltage category III. Installation must be carried out in compliance with national installation regulations.

• Positioning your conditioner:

- The conditioner produces cold air inside the cellar and expels hot air outside (see diagram A).
- Do not install the conditioner facing the door of the room (risk of condensation on the door joints).
- Do not place the external section of the conditioner above a source of heat.
- For insulation reasons, there must be no windows or bay windows in the room to be conditioned.
- No piped hot water must pass through the room to be conditioned (e.g. under-floor heating).
- Is it not better to state that pipes with hot water must be insulated so that there is no heat loss?
- The exterior of the conditioner must not be located in an area subject to ingress of rain, wind, snow or poor quality air.
- No heat-producing appliance must be located in the area to be conditioned (e.g. refrigerator, radiator, boiler).
- Do not obstruct the air entry and exit points.
- Never place a container or object containing liquid on top of the conditioner.
- The room where the hot air is expelled must, ideally, be approximately twice as large as the wine cellar and well ventilated so that the hot air can be properly expelled.
- **Wait 48 h** before plugging in so that the fluids in the internal circuits can settle.
- Never connect several conditioners to a multi-socket.

• Recommendations:

- Fit your conditioner as close as possible to the ceiling in order to ensure uniform dispersal of cold air in the cellar.
 - We recommend that you leave a space of 200 mm between the ceiling and conditioner housing to make it easier to fit the appliance onto its base.
 - Air outlets (hot and cold) must not be obstructed by any obstacles (minimum distance: 1500 mm).
- Direct the cold air outlet so it is facing the bottles (see diagram D).

• Installation: (see B diagrams)

The conditioner was designed to be completely modular and adapt to any type of cellar.

You can, amongst other options, install it either outside or inside your cellar, position it close to the floor (fixed to the wall) or at a height (we recommend, however, installing it at a height for improved air convection).

Additionally, hot air can be expelled from different angles (to be specified when ordering): facing forwards, right or left.

You also have the option of expelling hot air outside the room by way of extractor piping (standard piping, 160 mm in diameter, not supplied).

Finally, you can choose to fit the conditioner onto a door.

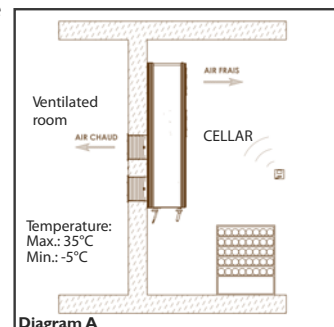

Diagram A

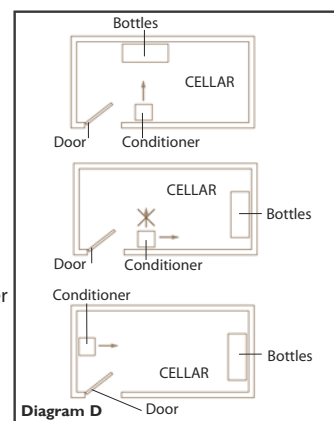

Diagram D

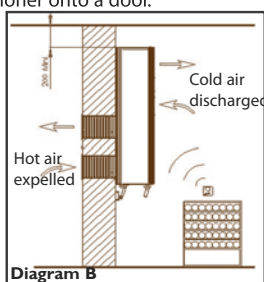

Diagram B

Conditioner housed inside the cellar with extraction facing forwards / aesthetic front panel on the outside

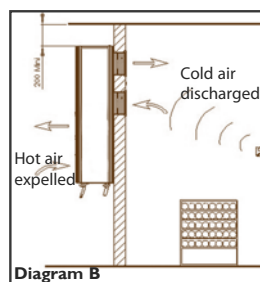

Diagram B

Conditioner housed outside the cellar with extraction facing forwards / aesthetic front panel on the inside

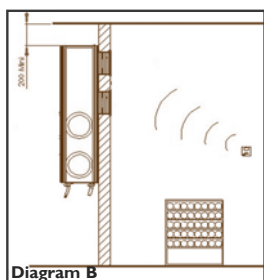

Diagram B

Conditioner housed outside the cellar with extraction on the left side / aesthetic front panel on the inside.

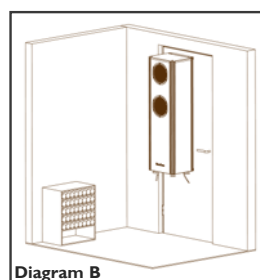

Diagram B

Conditioner housed inside the cellar, fitted onto an adapted door.



7 - INSTALLING THE CONDITIONER

• Fitting: (see C diagrams)

The conditioner comes supplied with a metallic mounting frame which simplifies the process of drilling air entry and exit holes.

It also has extendable ducting to be cut to length (75 cm each) in order to install the conditioner whatever the thickness of the wall.

Finally, the conditioner is supplied with an aesthetic front panel and 4 grids for an aesthetic appearance.

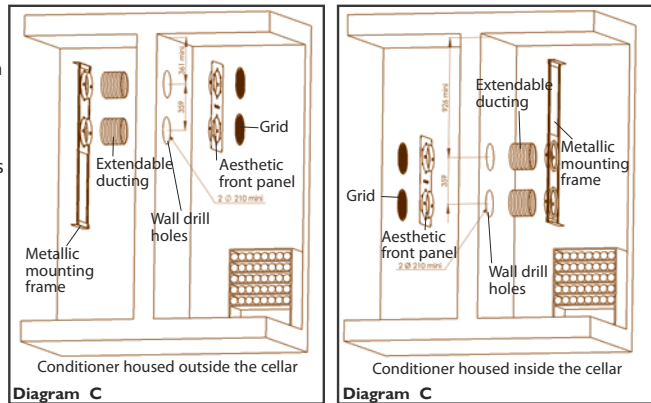

II- Drilling the wall

- Determine the location of the conditioner housing (inside or outside the cellar)

- Position the metallic mounting frame **(1)**

- in relation to the ceiling if fitting the conditioner at a height (maintain a distance of 200 mm between the top of the frame and the ceiling),
- in relation to the floor for a low fitting (maintain a distance of 80 mm between the bottom of the frame and the floor).

- Use the metallic frame to outline the position of the 2 drill holes **(2)**.

- Drill the wall. The holes must be larger than the outline drawn – between 210 mm min. and 280 mm max.

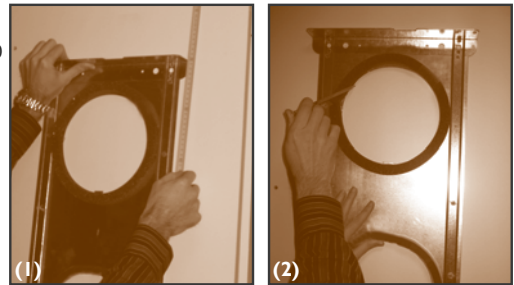

III- Fitting

- Fold the ring's 4 supports inwards **(1)**.

- Fit the 2 extendable ducts onto the rings of the metallic frame **(2)**.

- Screw the securing rings onto the ducts **(3)**.

- Position the metallic frame while passing the flexible ducts through the 2 holes drilled into the wall **(4)**.

- Push back the 4 supports towards the outside of the ring **(5)**.

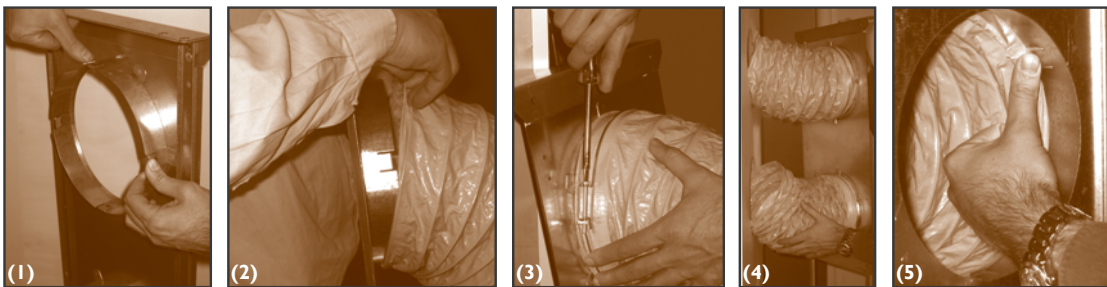

- Screw the metallic frame onto the wall with 2 high screws and two low screws (not supplied). Use screws suitable for the wall material **(6)**.

- We recommend that you put a bead of silicone between the plate and the wall to ensure effective sealing.

- Pull the 2 ducts (fixed to the metallic frame) through the other side of the wall **(7)**.

- Stretch the ducts to the maximum in order to make them as smooth as possible **(8)**.

- Cut the ducts flush with the wall using a Stanley knife for the material **(9)** and pliers for the metallic wiring **(10)**.

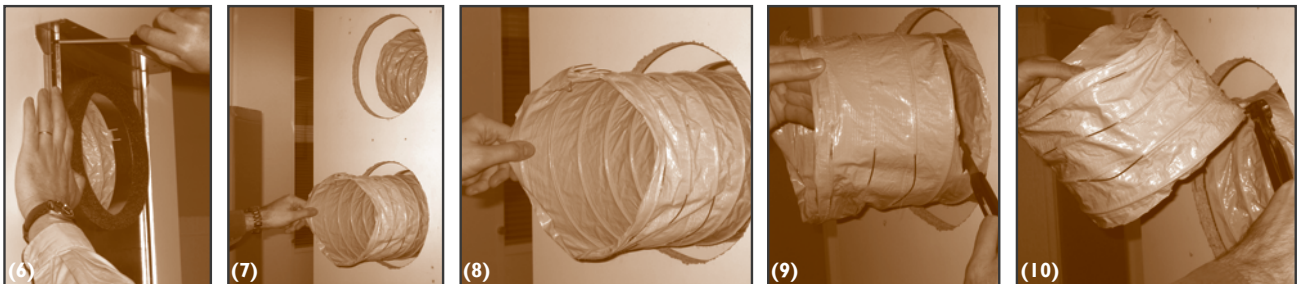

Wall mounting bracket dimensions

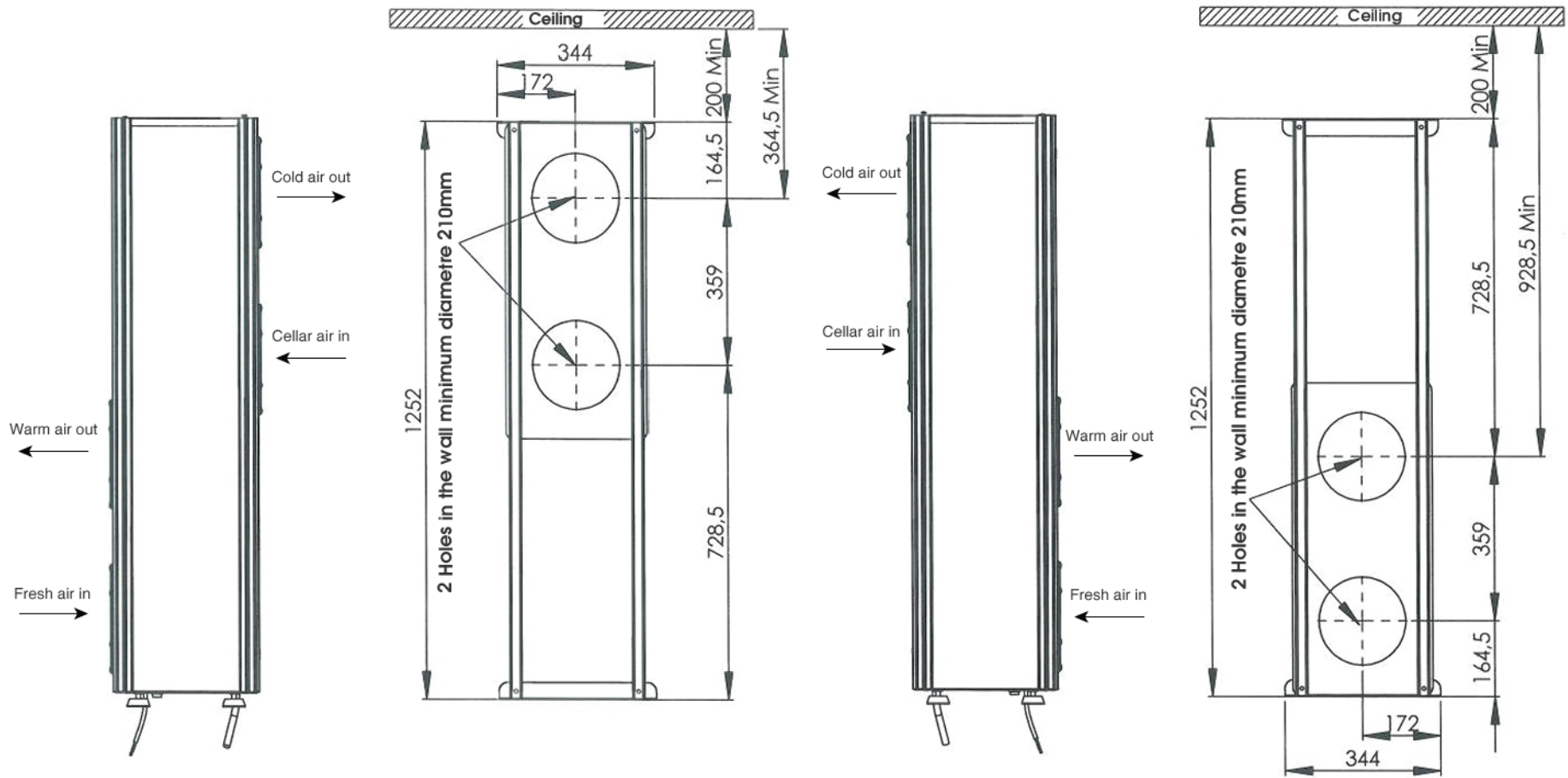

Cold side

Inoa located outside the cellar

Hot side

Inoa located inside the cellar



Subject: INOA-TECHNICAL DATAS AND TUBING

UNITS AFFECTED: **INOA25 et INOA50**

SERIAL NUMBER: **All**

DATE OF PRODUCTION: **Since June 2007**

Position of the panels :

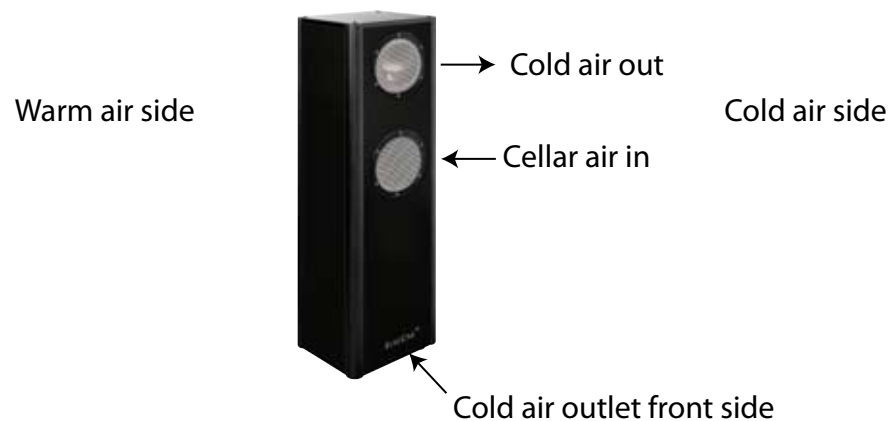

Maximum pipe lengths recommended:

Two parts, 7 linear meters of pipe diameter 160 mm without elbow.

Or

Two parts, 5 linear meters of pipe diameter 160 mm with 3 90°s elbows.

You can only duct the warm air side.
Do not duct cold air.



Subject: INOA-TECHNICAL DATAS AND TUBING

Extraction kit: AEVACLM or PEVACLM (not supplied with the air conditioner, option to be ordered), one kit per hole.

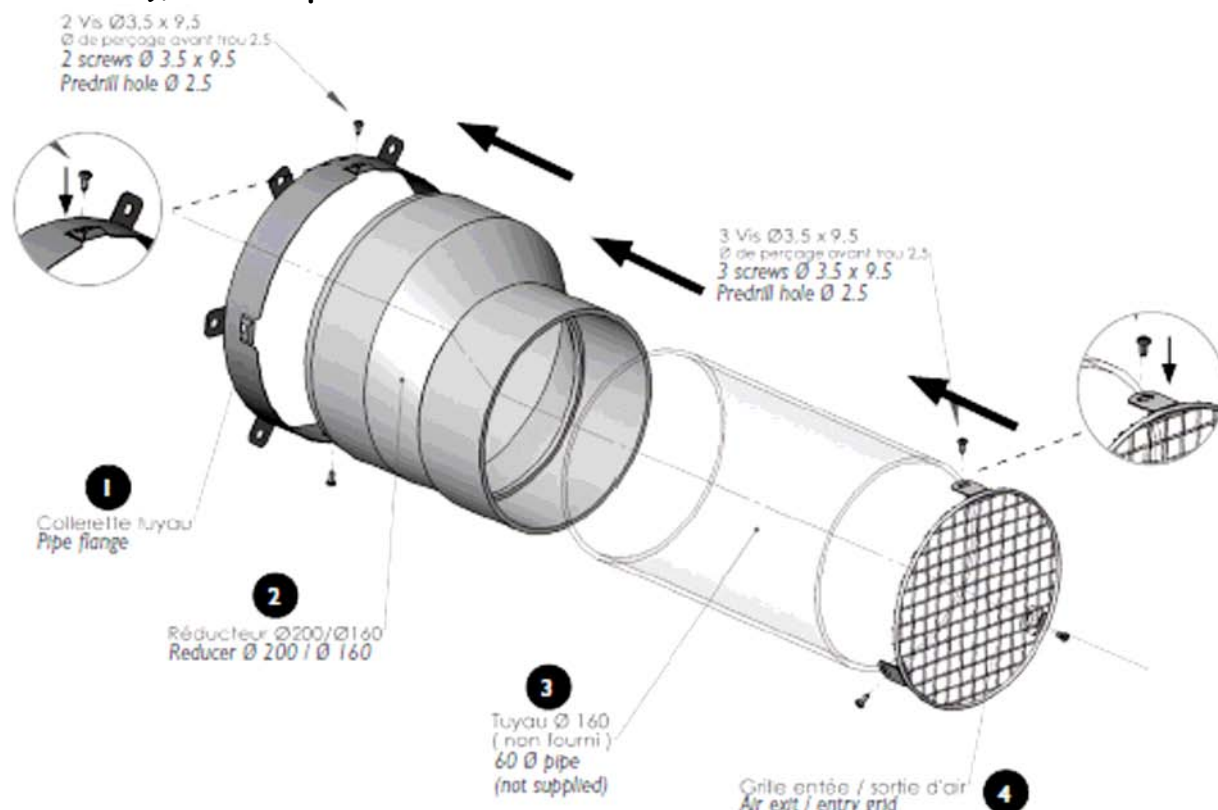

Technical datas: INOA 230 V 50 Hz	INOA25	INOA50
Maximum volume of the wine cellar	25 m ³	50 m ³
Cooling power	600 W	1200 W
Maximum distance for the remote control	10 m	10 m
Quantity of speeds for the condenser fan	4	4
Quantity of speeds of the evaporator fan	3	3
Condenser fan air flow (per speed : 1, 2, 3, 4) in m ³ /h	230, 335, 431, 563	273, 353, 473, 682
Evaporator fan air flow (per speed : 1, 2, 3) in m ³ /h	199, 285, 382	227, 352, 445
Gas load in R134a	400 grs	400 grs
Pressures BP and HP for 35°C (in bar)	2,3 ; 11,2	2,1 ; 10,5
Type of gas reducer	Capillary	Capillary
Condenser gas temperature	47°C	45°C

7 - INSTALLING THE CONDITIONER



- Position and fit the aesthetic front panel to the wall (screws not supplied). Use screws suitable for the wall material (11).
- We recommend that you put a bead of silicone between the panel and the wall to ensure effective sealing.
- Fold the flange's 4 supports inwards (12).
- Place the ducts onto the flanges ensuring that they are well secured on the support (13).
- Push the 4 supports towards the outside of the flange (14).
- On the side of the conditioner to be placed against the wall unscrew the 2 grids from the housing using the supplied Hex wrench and retain the screws. (15).

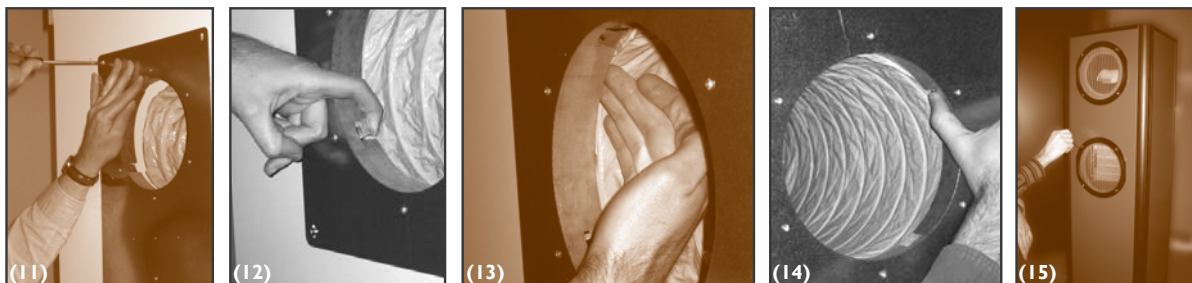

- Using the screws retained in the last instruction, screw the 2 grids onto the aesthetic front panel (16).
- Unscrew the 2 screws on the top of the conditioner using a Hex wrench (supplied), on the side to be placed against the wall. Retain the two screws (17).
- Fix the conditioner housing to the metallic frame, taking care to press firmly onto the foam (18).
- Screw down the conditioner housing using 2 screws at the top (those retained earlier) and 2 screws at the bottom (supplied in the accessories packet) (19).



• Fitting onto a door:

You can fit the conditioner onto a door.

In this case, it is ESSENTIAL to check that the door is capable of supporting a weight of 46 kg and that it does not produce vibration. The procedure for fitting is the same as for the wall.

• Fitting close to the floor:



When the conditioner is fitted close to the floor it is ESSENTIAL that it is fixed to the wall.

• Conditioner with air extraction via piping:

Repeat the steps described at the beginning of paragraph III.

Conditioner housed outside the cellar:

- On the conditioner housing, unscrew the 2 grids (openings that will not be placed against the wall) using a Hex wrench (supplied).
- Where the grids were located, position and screw, using a Hex wrench (supplied) the 2 flanges* onto the housing (1) and (2).
- Fit together the reducer* (3).
- Position the air extraction piping (standard piping, 160 mm in diameter, not supplied).



*Consult your EuroCave distributor



7 - INSTALLING THE CONDITIONER

Conditioner housed inside the cellar:

There are 2 methods for attaching the hot air extraction piping:

- Attaching the piping directly to the aesthetic front panel:

- Position and screw, using a Hex wrench (supplied), the two supplied flanges* onto the aesthetic front panel (1).
- Fit together the reducer (2).
- Position the air extraction piping (standard piping, 160 mm in diameter, not supplied) (3).

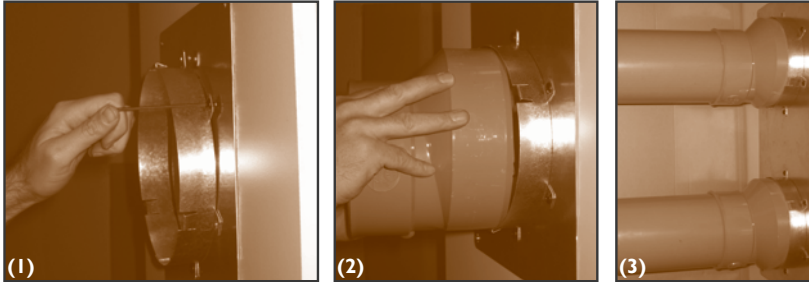

- Attaching the piping directly to the conditioner housing (the extraction piping passes through the wall):

 If using this method, you must not use the flexible ducting supplied with the conditioner.

- Fit the reducer* directly onto the mounting frame through the wall (1).
- Position the air extraction piping (standard piping, 160 mm in diameter, not supplied) (2) (3).

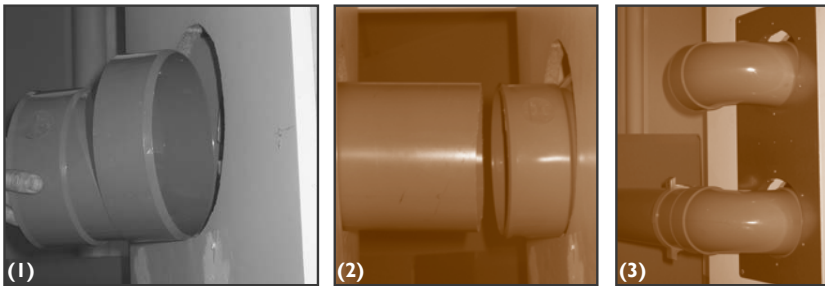

For this type of fitting, it is necessary to ensure sealing around the piping.

*Consult your EuroCave distributor

IV- Discharging condensate

The conditioner was designed to allow condensate to be discharged (discharge pipe located under the conditioner's housing) either inside the cellar, if the humidity level is too low, or outside the cellar. Simply pass the pipes through the wall to discharge the condensate into the room next to the conditioner housing.

 Ensure that the piping is not cramped.

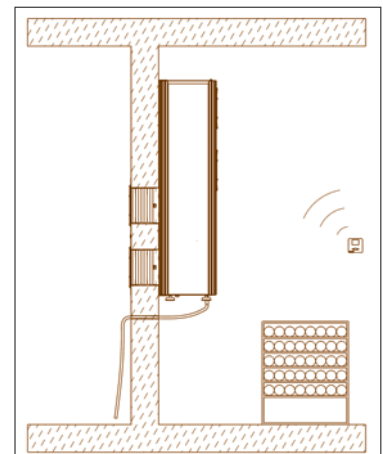

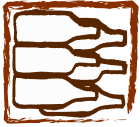

8 - CONDITIONER OPERATION

The INOA conditioner is fitted with a refrigerating unit:

- an evaporator forces cold air inside the room,
- a condenser expels the hot air outside.

The evaporator fan operates continuously to ensure that air is constantly mixed and that temperatures are as uniform as possible, in accordance with speeds automatically adjusted according to requirements.

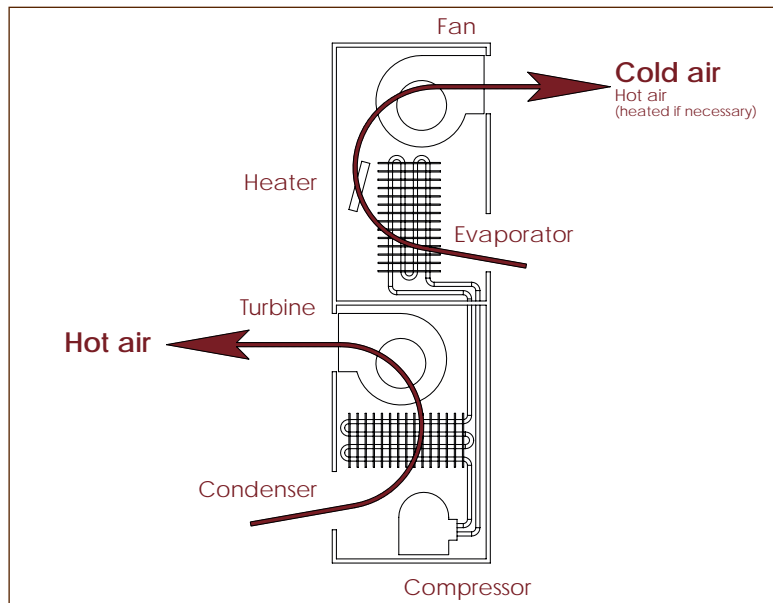

9 - INSTALLING THE REMOTE CONTROL



I- Remote control description

Radio frequency remote control (433.92 Mhz)
Each remote control has a personalised code matched to the conditioner.
Power supply: 2 x 3V (CR 2430 battery, supplied)

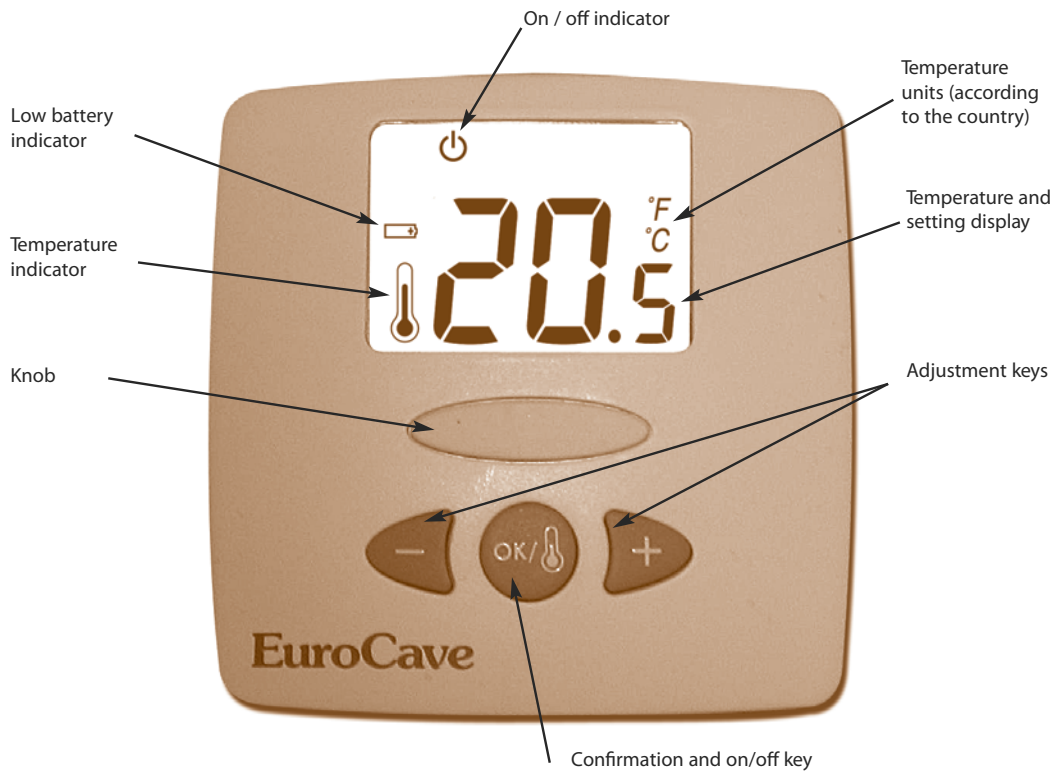

II- Installing the remote control inside the cellar

We recommend that you place the remote control as close as possible to the bottles.

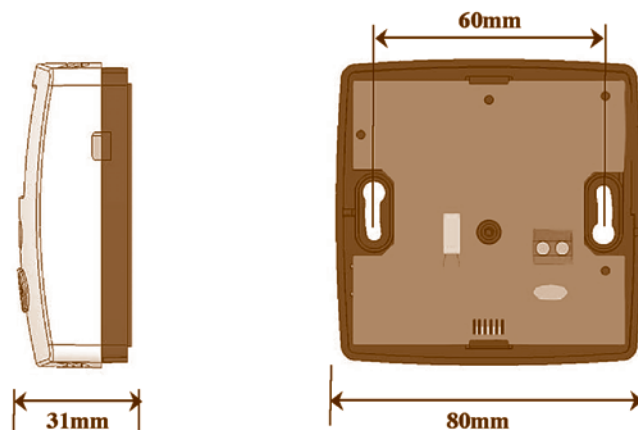

Fit the unit close to your bottles using the supplied pegs and screws (see diagram below)

NB: Do not place the remote control in the path of the conditioner's cold air flow.



9 - INSTALLING THE REMOTE CONTROL

III- Installing the remote control outside the cellar

The remote control can also be placed outside the cellar.

In this case, it is essential to connect a sensor (supplied with the appliance) to the remote control before installing it.

a- Connecting the sensor to the remote control

- On the back of the remote control, push the 2 batteries downwards using a screwdriver (see diagram below).

Battery CR2430

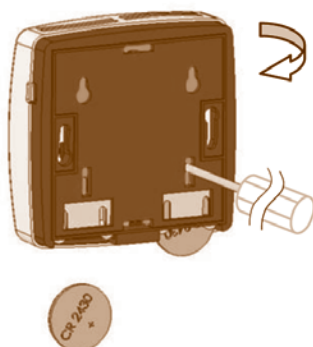

- Remove the central knob, unscrew the screw with a small screwdriver and open the unit (see diagram below)

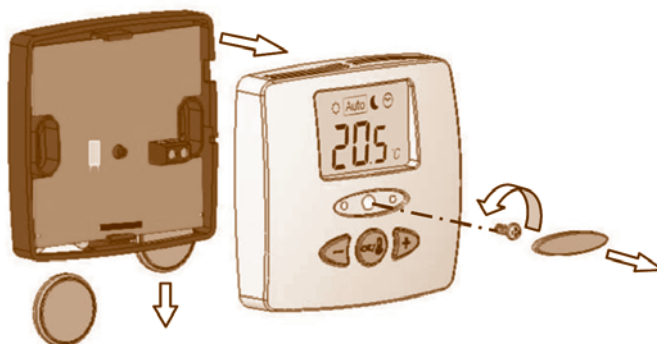

On the back, connect the sensor's 2 wires (blue and red) to the circuit connector using a small flat screwdriver (see diagram below). You can connect either the blue wire or the red wire to the circuit connector. Pass the wires through the recess on the top of the unit.

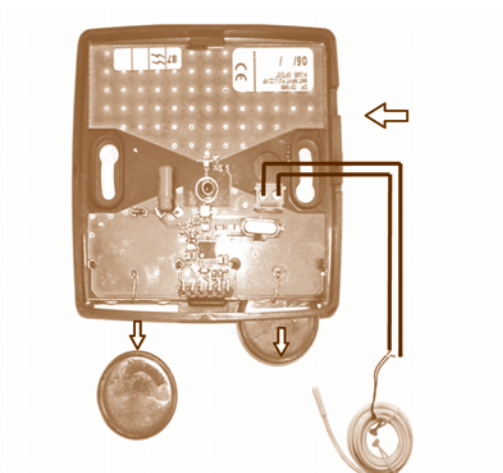

- Close the unit, ensuring that the wires pass through the recess and are not jammed

- Rescrew and replace the central knob

9 - INSTALLING THE REMOTE CONTROL





- Programming the remote control



When placing the remote control outside the cellar, having connected the external sensor, it is essential to reprogramme the unit.



- To turn on the remote control, press and hold down the  key for about 8 seconds until the  indicator goes off.



- First press and continuously hold down the  key, at the same time press and continuously hold down the  key for several seconds until three



lines  appear. The model number is then displayed and flashes .



- Press .

- The  screen appears indicating IN (IN= internal installation). Press the  key to change to OUT external mode.



- The  display appears indicating OUT (OUT= external installation). Press  to confirm.



- The  pictogram appears. Press .

- The  screen appears. Press .



- The  pictogram appears. Press .

- The  appears. Press .

- The  pictogram appears. Press .

- The  screen appears, then .

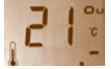
If you wish to reprogramme the remote control for an internal sensor, disconnect the wired sensor and reprogramme the remote control in internal mode (IN) by repeating the first two steps described in the paragraph above (see 5-III-b p.11):

The 2nd screen displays  indicating OUT (OUT= external installation). Press the  key to change to IN internal mode. Press  to confirm.

Then repeat the same steps, as indicated in the above paragraph (see 5-III-b).

c- Fitting

- Fit the remote control and sensor using the screws and pegs supplied (see diagram on page 9, chapter II).
 - Place the sensor inside the cellar.
 - Place the sensor as close as possible to the bottles
- N.B.: the sensor has a range of 3 metres.

10 - COMMISSIONING YOUR CONDITIONER





I- Connection

Check that the plug is connected to a power supply (presence of correct amp fuses, functioning 30 mA* differential circuit breaker - not applicable to certain countries). Wait 48 hours before plugging in your conditioner.

II- Switching on

- Place the switch, located under the conditioner, in position 1.

- Press and hold down the  key on your remote control for about 8 seconds, until the  indicator goes off.

To put your conditioner on standby, press and hold down the  key on your remote control for about 5 seconds and release it before the indicator  goes off.

III- Remote control description

Radio frequency remote control (433.92 Mhz).

Each remote control has a personalised code matched to the conditioner.





10 - COMMISSIONING YOUR CONDITIONER

IV- Installing the remote control

You can install the remote control inside your cellar.

We recommend that you place it as close as possible to the bottles.

Fix the unit close to your bottles using the supplied pegs and screws (see diagram below)

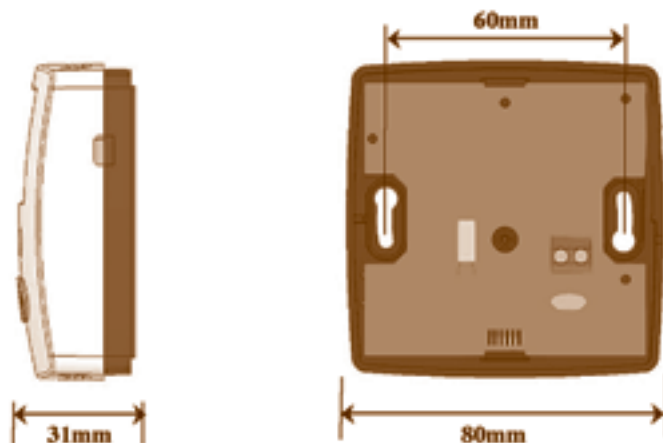

N.B.: Do not place the remote control in the path of the conditioner's cold air flow.

It is also possible to place the remote control outside the cellar.

In this case, an external sensor (supplied) must be connected to the remote control and then the remote control must be reprogrammed.

For further details, contact your EuroCave retailer.

V- Setting the temperature

Setting the temperature of your conditioner is carried out entirely from the remote control which has the following layout:

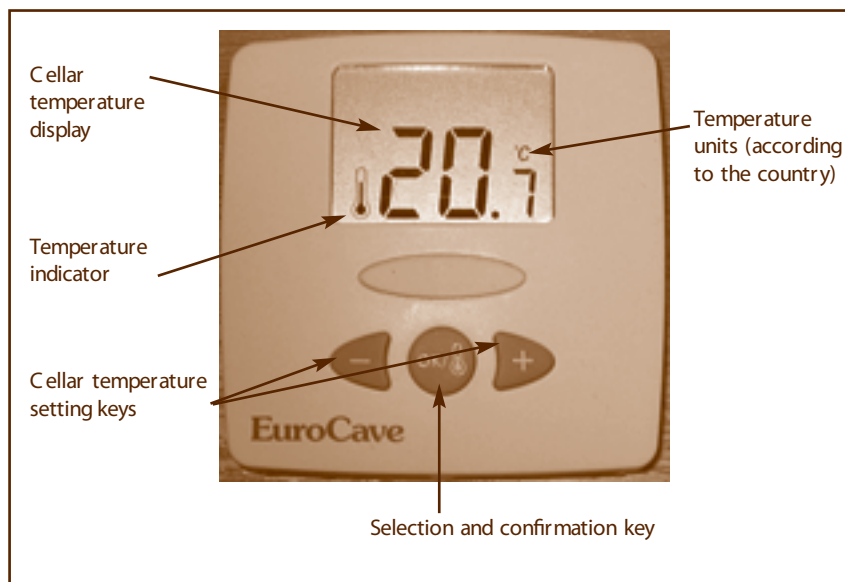

- Temperature display: displays the actual temperature inside your cellar.
- Setting keys: allow you to select the desired temperature inside the cellar.

To adjust the temperature:

- Press then immediately release the  key.
The setting then appears (the temperature flashes).

- - When the temperature flashes, you have 7 seconds to change the setting by pressing the  or  keys, otherwise the display automatically returns to the previous setting.

The recommended setting range for maturing wine: 10 to 14°C.

10 - COMMISSIONING YOUR CONDITIONER



- Press the  key to confirm the new setting, the display then returns to the new setting.

The setting can be adjusted between 9 and 15°C. Beyond this range, the  and  keys do not work.

WARNING: to operate correctly, your conditioner must be in a location where the ambient temperature is between -5°C is 35°C.

When making significant modifications to temperature settings, it can take several hours for the temperature in your cellar to stabilise and for the conditioner to display the desired temperature.

VI- Silent function

Your EuroCave conditioner is fitted with a silent function which allows the sound level to be reduced when you enter the cellar.

When the conditioner is on:

- Press and hold down the  key for 3 seconds.

The  display then appears. Next the current temperature is displayed.

You will be able to see this function via the  pictogram which flashes for 15 minutes.

The compressor then remains in operation and the fans change to slow speed for 15 minutes. After this, the conditioner returns to the default operating speed.

VII- Heating function

The EuroCave INOA conditioner has a heater (650 W) allowing the internal temperature in your cellar to be maintained at an optimal level. As soon as the temperature drops below the programmed temperature, the heating function is automatically activated.

VIII- Changing the remote control batteries

Remote control power supply: 1 x 3V (CR 2430 battery) (2 batteries supplied)

Battery life: 2 years approx

The remote control is supplied with 2 batteries. Only one battery is required (pull off the plastic strip to make it useable). The other battery is a spare.

- When the battery runs out, the  pictogram flashes on the remote control's display.
- Take the remote control off the wall.
- On the back of the remote control, push the used battery down using a screwdriver (see diagram opposite).
- Pull the strip from the spare battery, which will then be ready for use.
- Remember to buy a replacement for the spare battery.



IX - Discharging condensate

Your conditioner was designed to allow condensate to be discharged (discharge pipe located under the conditioner's housing) either inside the cellar, if the humidity level is too low, or outside the cellar.

Simply pass the pipe through the wall to discharge the condensate into the room next to the conditioner housing.

 Ensure that the piping is not kinked.





11 - MAINTENANCE

 It is necessary to thoroughly clean the conditioner's internal elements every year.

- Unplug the appliance.
- Place the appliance on the ground to disassemble it (4 screws).
- Vacuum the 4 air entry and exit grids.
- Remove the upper cover (2 screws) **(1)**.
- Snap off from the top the 2 columns in order to access the 8 screws of the 2 front sections **(2)**.
- Disassemble the front sections by removing the screws (square end pieces, not supplied).
- Thoroughly clean the ribs of the 2 exchangers with a vacuum cleaner **(3)**.
- Repeat these instructions in the opposite order to reassemble the appliance.

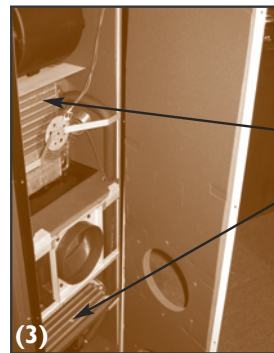
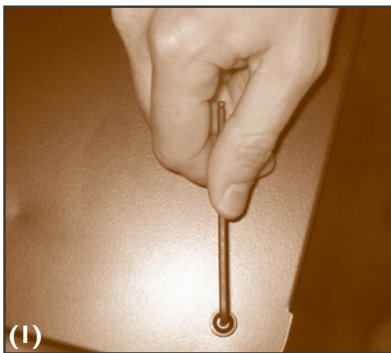

Ribs of the 2 exchangers





12 - OPERATING FAULTS

If the conditioner is not working, there may be loss of synchronism between the appliance and the remote control.

Synchronising procedure:

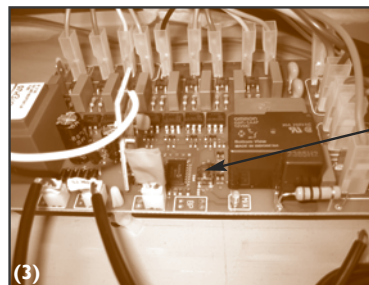
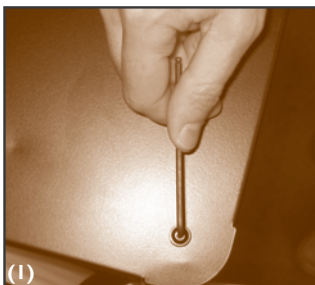

- Remove the conditioner housing upper cover (4 screws) **(1)**.

- To turn on the remote control, press and hold down the  key for about 8 seconds, until the  indicator goes off.
- Place the switch, located under the conditioner, in position 1. The green LED on the board comes on **(2)**.
- Press and hold down the On/Off button (brown button) on the board for more than 6 seconds, then release **(3)**. The green LED will then start to flash (synchronising mode).



On/ off button

Green LED

- Simultaneously press the  and  keys on the remote control until ! is displayed .

- As soon as the green LED on the board stops flashing (end of synchronising mode), the conditioner and remote control are then synchronised.

- Exit "RF" mode by pressing the  key on the remote control.

WARNING

The information in this document is subject to modification without prior notice.

EuroCave offers no guarantee on this equipment item if it is used for any specific purpose other than that for which it was designed. EuroCave cannot be held responsible for any errors in this manual, nor for any damage linked to or following the provision, performance or use of the equipment item.

All photocopying, reproduction, translation, wether partial or total, are strictly prohibited, without prior written consent from EuroCave.

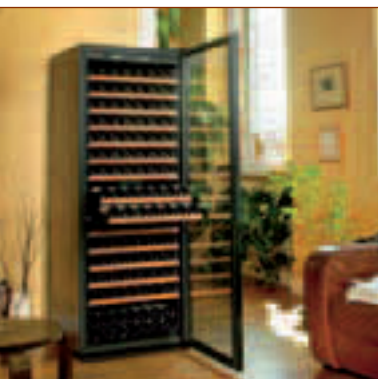

EUROCAVE

EuroCave UK
57 Chiltern Street
London W1U 6ND
020 7935 4679
info@eurocave.co.uk

www.eurocave.co.uk - info@eurocave.co.uk