

WINDOWS WITH VISION

rational[®]
WINDOWS & DOORS

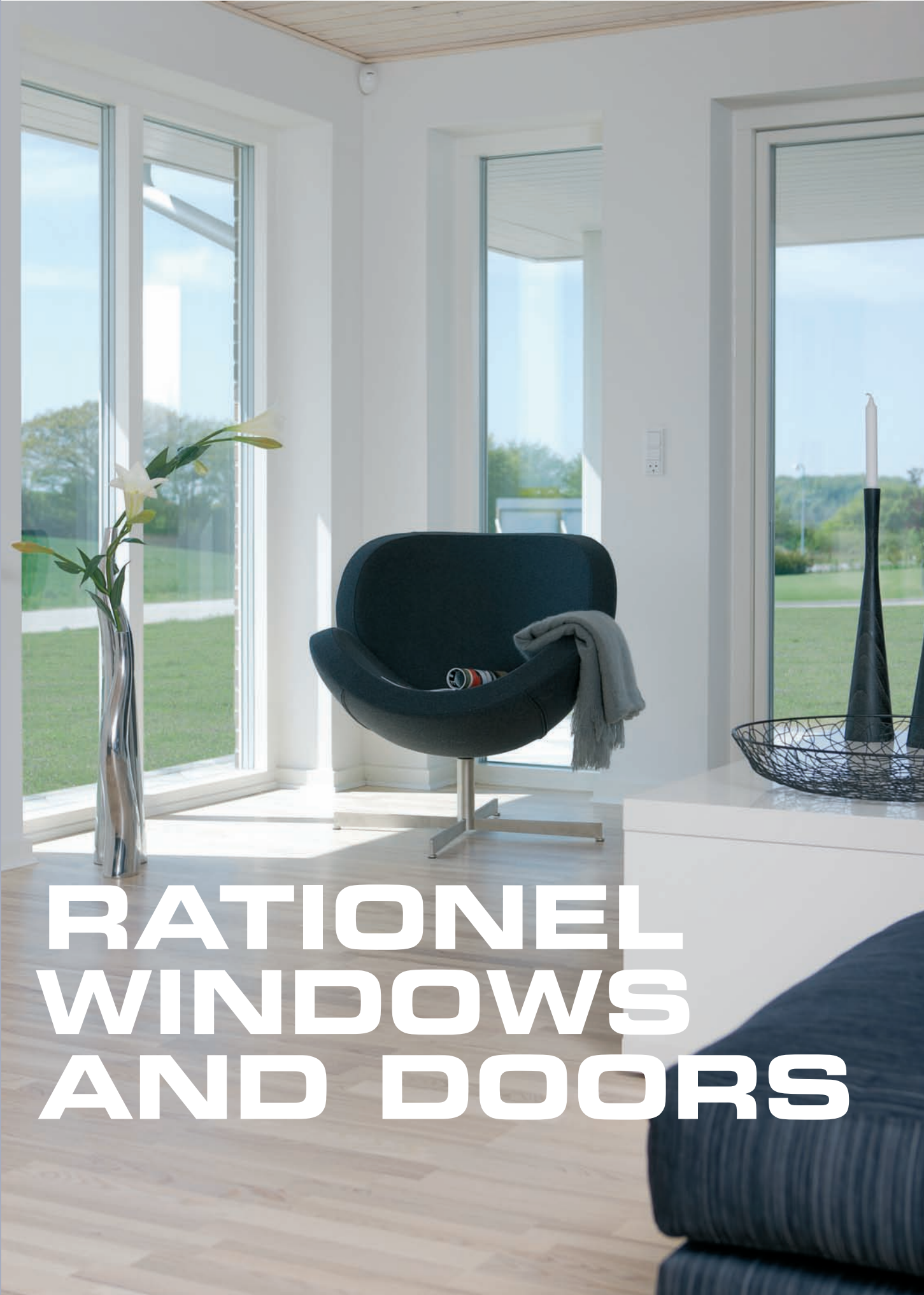

RATIONAL WINDOWS AND DOORS

Rationel Vinduer Ltd. **- Your partner for low-energy buildings.**

Windows and doors play a crucial role in reducing a building's heating consumption. However, the optimum window solution depends on a combination of several factors;

- The windows insulating properties
- The windows ability to make use of free solar heat
- The windows orientation in relation to the sun
- Sun screening and shading
- The glass ratio
- Installation methods and thermal bridges
- The number of windows and total window area
- Air tightness

Rationel Vinduer Ltd. can offer both products and guidance on how to reach the best energy solution. We are the leading supplier of windows and doors for Passive House construction and low-energy building in Scandinavia and have achieved great experience in energy optimisation of windows and doors. In low-energy buildings the window choice is very crucial - meeting Passive House level makes the interdependence between building design and energy concept even stronger.

We provide expert help in ensuring the right choice is made to bring optimum performance in terms of thermal insulation, light transmittance, use of passive solar heat gain, durability and aesthetics.

Read more about energy and the optimum energy solution in this catalogue or visit www.rationel.ie and be inspired.

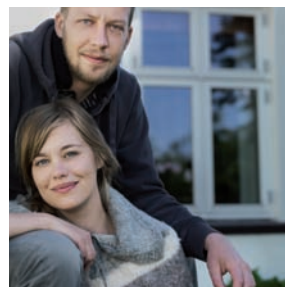

CONTENTS

Five important things to consider when buying windows and doors	4 - 7
Choose the right window for your home	8 - 9
PATUS	10 - 13
PATUS+	14 - 17
DOMUS	18 - 21
ALDUS	22 - 25
Panes	26 - 31
Energy efficient solutions	32 - 33
Security	34 - 35
Colours	36 - 37
Special solutions	38 - 39
Certifications, labels and warranties	40 - 41
Sustainability	42 - 43
Window opening types	44 - 45
Door opening types	46 - 47
Window and door measures	48 - 49
Choose the right door for your home	50 - 53
Accessories	54 - 55
Section drawings	56 - 69



**FACTS
WORTH
KNOWING
ABOUT OUR
WINDOWS**

Most people who haven't bought windows or doors before, or at least not for a long time, think there are many things to consider before choosing. This is because there are numerous options and the range is wider and more complex than ever.

The following is a short list of five important things which we think are important for you to consider so as to get the most out of your new windows and doors.

1. GO FOR HIGH QUALITY

Your new windows and doors must last for many years. And they only will if the quality is high and if they are treated properly. Product and installation expenses can be considered in the light of whether they will have to be replaced again in a few years, in many years, or not at all in your lifetime.

We offer sturdy, high-quality windows and doors which can and must last for many years. Windows and doors from Rationel are made of timber or timber with added external aluminium cladding. We use the finest pinewood from FSC-certified forests, with heartwood on visible surfaces and a beautiful finish where joints and glazing beads ensure a perfect tight seal.

All our products are impregnated using eco-friendly products and are tested and CE-marked.



5

important
things when
buying windows
and doors

2. CHOOSE THE RIGHT WINDOW FOR YOUR STYLE

A house with windows which does not match the architectural style is usually not a harmonious house to look at, from the outside nor the inside. In order to achieve a result which will match your home, take a critical look at your existing windows. Are they the original windows? Or have previous owners changed them to a different style? In any case, you now have an opportunity to choose new windows to match the appearance of your house, your needs and your personality. Inward or outward opening, right hand or left hand, fire-escape functionality – what is it going to be? Rationel offers you a wide range of window options. So consider your needs to find the perfect solution for your house and its occupants. We have windows and doors designed for almost any building or architectural style. You can see all of them here.

3. IMPROVE YOUR INDOOR CLIMATE AT THE SAME TIME

Free solar heat is best exploited with our new energy-saving and energy-contributing windows. Your heating expenses will be reduced significantly so that you can save money and help the environment at the same time. Your windows and doors are also important in terms of indoor climate. Draughts and down draughts are now a thing of the past. This means that you can place furniture right by the window and enjoy a perfect view. New windows are also tightly fitted, requiring good airing habits. If the window has an integrated vent, you can easily control the intake of fresh air.

4. MAINTENANCE PROLONGS SERVICE LIFE

In general, our windows and doors require only a minimum of maintenance. Nevertheless, keep an eye on them, because properly maintained windows can last for many years. This applies to painting, cleaning and adjustments. This way, you will get the most out of your investment. Timber windows should be painted as required and should be cleaned thoroughly once a year. You can adjust all our windows and doors yourself, as required, to ensure that they are always tight. See Rationel's Instructions for Use for information about how to treat your doors and windows to obtain maximum benefit from them throughout their service life. Or visit our website for sound advice.

5. WINDOWS WITH INTEGRATED SECURITY

Intruders are never welcome, no matter how they enter. Rationel's windows and doors are factory prepared to protect from burglary as they are extremely difficult to break through. However, if you live in an area of the country which is particularly exposed, or in an isolated area, or on the ground floor in the city, you can make it even more difficult and time-consuming for burglars to enter your home. Read more about Rationel's Security Packages in this Catalogue.

Rationel will gladly answer your questions - we look forward to hearing from you.

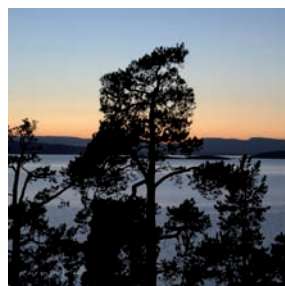
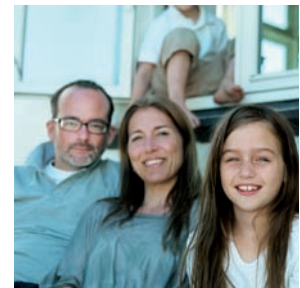



THE PERFECT WINDOW MUST MATCH YOUR HOME AND YOUR NEEDS



At Rationel we offer a wide range of windows and doors in modern and classic styles for both new-build and refurbishment projects. This makes it easy for you to find the products that match your house. We have developed and manufactured windows and doors since 1954 and today our product range covers almost any imaginable need or architectural style.

We offer prime-quality ranges in timber and timber/aluminium with numerous practical features, and no matter which product you choose, it will be the right one for you and your house in terms of energy efficiency. In the following pages we present our product ranges in a way that will make it easy for you to choose the most harmonious solution for your house.

PATUS®

PATUS® energy-efficient windows and doors in timber for classic houses are an ideal solution for older buildings. Or for new buildings, if a classic expression is desired.

PATUS+®

PATUS+® energy-efficient windows and doors in timber with external aluminium cladding. The aluminium cladding provides additional protection against the climate and requires a minimum of maintenance.

DOMUS®

DOMUS® energy-efficient windows or door in timber for modern buildings and refurbishment of 30-50-year-old buildings. With simple profiles and easy to join. Ideal for sun lounges and bays.

ALDUS®

ALDUS® energy-efficient windows and doors in timber with external aluminium cladding. ALDUS requires only a minimum of maintenance and is suited for both new-build and refurbishment projects. The timber section is identical to that of DOMUS.



NATURE'S OWN MATERIALS

inside as well as outside

PATUS®

Today, it is also possible for older and classic houses to be refurbished to enjoy the advantages of energy-efficient windows. Our PATUS range features all-timber windows with narrow glazing bars. Also ideal for new builds if a classic expression is desired.



PATUS®

Timber windows for refurbishment and modern new build

PATUS energy-efficient windows are available as country-style windows and classic windows. Both types are available in several versions, divided by glazing bars. Patio and front doors with glass and wood panels are also included in this range. They are easy to join and therefore suited for complex window solutions.







The window that requires a minimum of maintenance

PATUS+®

PATUS+ is made of a sturdy construction with external aluminium cladding attached with clips, which makes the window extremely resistant. This means natural timber on the inside and easy maintenance on the outside. PATUS+ is especially suited for refurbishment of older buildings but is also ideal if a classic façade appearance is desired.



PATUS+®

Timber/aluminium windows for refurbishment and new build in classic style

PATUS+ energy-efficient windows are available as country-style windows and classic windows. Both types are available in several versions, divided by glazing bars. Patio and front doors with glass and aluminium panels are also included in this range. They are easy to join and therefore suited for complex window solutions such as sun lounges, conservatories, bays, etc.







The natural window with the modern expression

DOMUS®

DOMUS windows and doors are made of a sturdy construction where natural timber is desired inside as well as outside. The design of DOMUS is especially suited for modern residential construction and refurbishment of detached houses from the last 30-50 years.

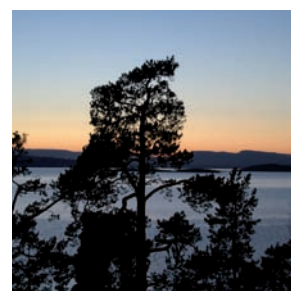

DOMUS®

Timber windows for refurbishment and new builds in a modern style

DOMUS are energy-efficient windows and doors which reduce energy consumption thanks to their construction and design. DOMUS windows are available with lots of different division options and many opening/closing features. They are easy to join and therefore suited for complex window solutions such as sun lounges, conservatories, bays, etc.







A window that keeps
itself in balance for
many years

ALDUS®

ALDUS are energy-efficient windows and doors in timber/aluminium, made of a sturdy construction, with external aluminium cladding attached with clips. The cladding adds to the protection against wind and weather. This means natural timber on the inside and easy maintenance on the outside, year after year. ALDUS is especially suited for modern residential construction and refurbishment of detached houses from the last 30-50 years.

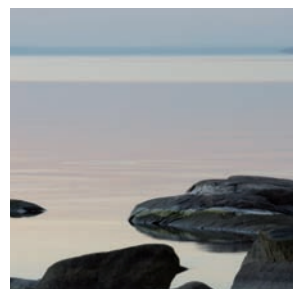

ALDUS®

Natural timber inside and easy maintenance outside

ALDUS is suited for new-build and refurbishment projects where a modern façade appearance is desired. ALDUS energy-efficient windows and doors reduce energy consumption in the house thanks to their construction, and the external aluminium cladding makes ALDUS maintenance-free and slightly better than DOMUS in terms of energy efficiency.



The windows are available with lots of different division options and many opening/closing features. They are easy to join and are therefore suited for complex window solutions such as sun lounges, conservatories, bays, etc.





Transparent information about

PAN

The primary functions of panes are to keep out rain, to retain heat and to ensure a good view and contribution of light. But they offer many other features which may be worth considering. Rational panes are able to shield against the sun, reduce noise, inhibit burglary and save energy. These features can even be combined in one and the same pane, thus offering more functions. Consider whether you want your new windows to be created with special features.



RATIONEL PANES AT A GLANCE



Energy-efficient panes reduce thermal loss, the extent to which cold air travels down the pane, and your heating bill. The space between the glass panes is filled with argon, which is a better insulator than ordinary gas. The inner glass layer of an energy-efficient pane has a thin metal coating that reflects the heat back into the room.

This coating is neutral, allowing maximum sunlight to provide the room with additional heat, free of charge. Rationel ENERGY panes not only create a bright, pleasant indoor environment but also reproduce colours as neutrally as technically possible. They meet energy class A requirements.



For a burglar, the window pane is often the easiest way into the house, especially if the burglar can work undisturbed and the sound of broken glass does not attract attention. Here, laminated glass can be an advantage. Thanks to the toughness of laminated glass, it takes a lot of vandalism and

time to break it. The Rationel SECURE pane has been tested and labelled according to several national and European standards. Read more about Rationel's security programme for windows and doors in this catalogue, or visit our website.



The SAFETY pane can be made of hardened glass, laminated glass or a combination of both. Safety glass reduces the risk of personal injury should a person fall into the pane. When hardened glass breaks, it falls out of the sash and is shattered into small, harmless pieces.

If the glass is laminated, the pane will remain as one unit if it is broken. You cannot cut yourself on either of the two types if they break. Rationel SAFETY has been tested and marked according to several national and European standards.



Rationel SOLAR

Rationel SOLAR is used mostly in office and commercial buildings that have large south and west glass façades where overheating may occur during the summer months. Five types of panes limit the amount of sunlight and heat, depending on the light and heat shielding levels required. SOLAR 70, 51 and 40 consist of coated glass sheets with an al-

most neutral reproduction of colour when looking from the inside out. SOLAR Green and Grey have tinted glass (green and grey). It is cheaper than coated glass and reduces the amount of both light and heat. In return, it slightly distorts colour.



Rationel FAÇADE

Rationel FAÇADE is used in buildings to create a visually coherent façade or special colour effects. Façade glass is well suited for ventilated and insulated panels and storey divisions. The type most

widely used is enamelled glass, which is available in 10 standard colours. FAÇADE is also available in special colours on request.



Rationel SOUND

If you live in an area with heavy traffic or near a railway, noise problems from the outside can be solved partly by using noise-reducing panes. Sound moves through the air as waves. These waves continue through one layer of glass almost unim-

peded, but two glass sheets – as in a modern double-glazed unit – act as a brake. The thicker the two glass sheets, and the larger the distance between them, the better they brake the sound waves.

Do you want to know more?
Read more about choosing the right pane at our website.



Rational OBSCURE panes are used for windows and doors to restrict the view into bathrooms, etc. As the patterns are located inside the pane, it can be cleaned like a traditional pane.

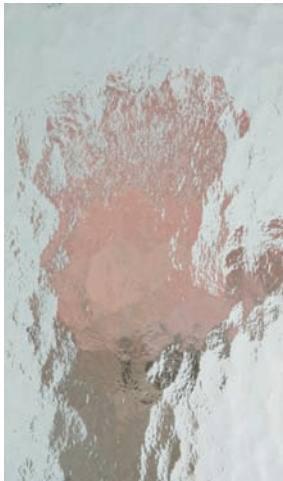

Small Cathedral,
white



Listral



Stippled



Satin, acid etched
glass

All Rational's panes have been approved according to the EN 1279 requirements and have a warm-edge spacer.



Silvit



Cotswold

Do you want to know more?
Read more about choosing the right pane at our website.



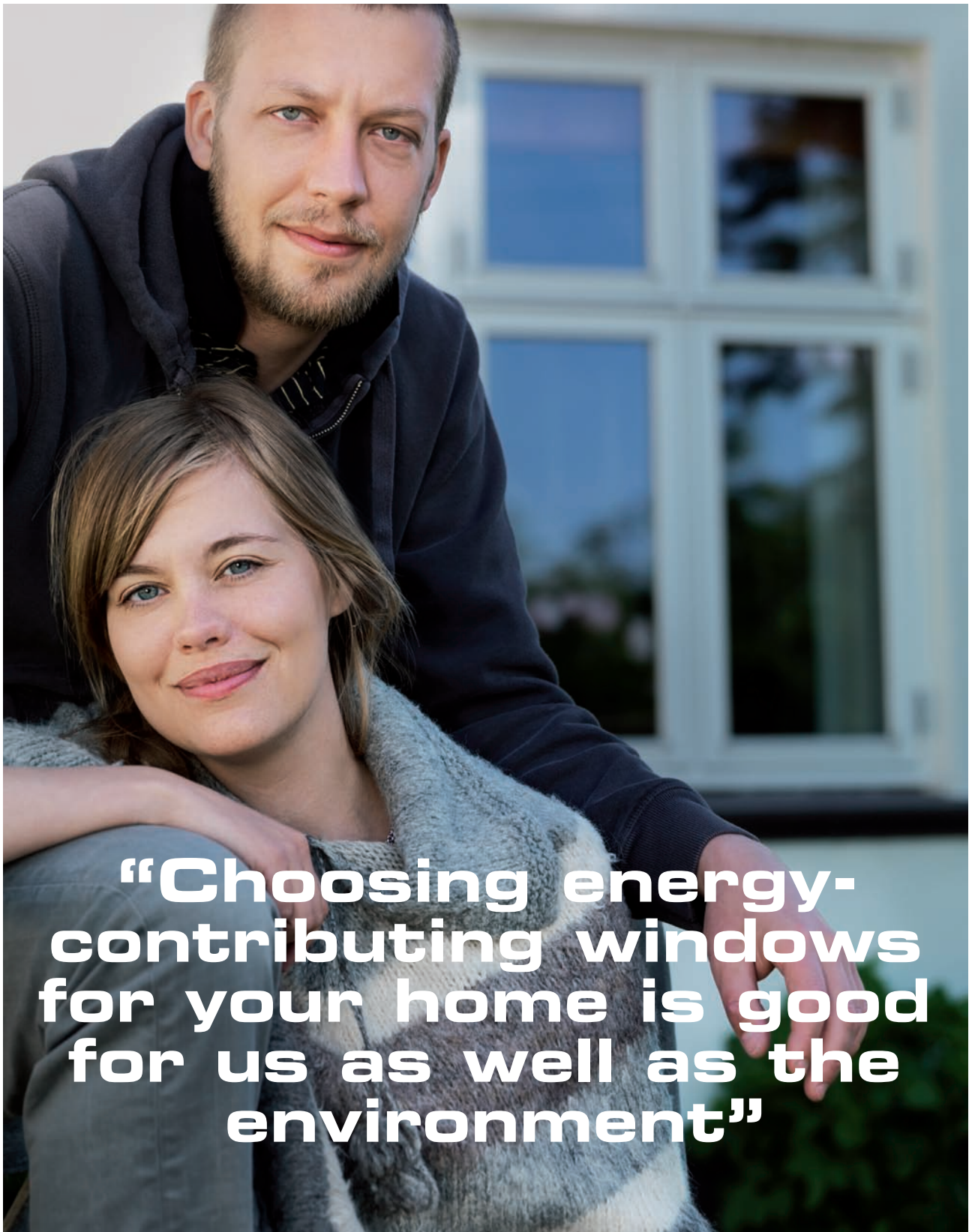

“Choosing energy-contributing windows for your home is good for us as well as the environment”

No matter whether you are building a new house or replacing your current windows and doors, you can save a lot of money on your heating bills and at the same time reduce CO₂ emissions significantly thanks to excellent insulating properties and a design that lets in lots of daylight and free solar heat. All our windows can be provided with fresh air vents and are designed to reduce draughts and

cold air from descending. This ensures the optimum indoor climate; furthermore, it allows you to make better use of space and the ability to place furniture right in front of the windows. Correct installation and the right solution based on the location of the house in relation to the sun mean that you can reduce your costs dramatically. Read more about energy solutions at our website.

Energy-efficient windows save you money on your heating bill and reduce CO₂ emissions

As standard, Rationel's windows are provided with double-glazed energy-efficient panes with argon gas and a warm-edge spacer.

ALDUS standard low energy window

Uw-value	1,33	W/m ² K
WER	-3	kWh/m ²

Our range includes several options should you want an even better energy solution. The best solution is to choose windows with the lowest possible Uw value to the north and the best possible Eref to the south, east and west. The Energy Simulator at our website makes it possible to calculate how much you can save on your heating bill by replacing your windows and doors.

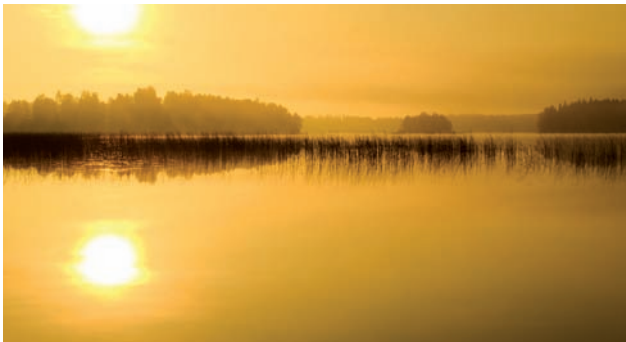

FACTS ABOUT WINDOW VALUES

Uw-value

This represents the ability of the window to retain heat. The lower the Uw value of the window, the better it retains heat indoors. You should choose windows with the lowest possible Uw value for north façades because north facing windows do not provide free heat.

WER

The WER value is an expression of how good the total energy balance of a window is. The WER value is the result of the amount of free solar heat through the window, less the thermal loss through the window during the heating season.

Because the sunlight through south, east and west windows helps heat your house, you should choose windows on the basis of the best possible WER value. This value is the energy balance of the window expressed in kWh/m²/year. If the value is positive (+), the amount of energy provided for heating exceeds the amount of energy disappearing out of the window.

Example 1: Façades facing north

Triple-glazed energy-efficient window designed to reduce thermal loss to a minimum. This window is especially suited for north façades in energy-efficient buildings.

Uw-value	0,79	W/m ² K
WER	-2.7	kWh/m ²

The calculation is based on a top-guided ALDUS window in EU standard size 1230 x 1480 mm.



Example 2: Façades facing south, east and west

Triple-glazed energy-efficient window designed to exploit the free solar heat as much as possible. This window is especially suited for south, east and west façades in energy-efficient buildings.

Uw-value	0,85	W/m ² K
WER	+23.9	kWh/m ²

The calculation is based on a top-guided ALDUS window in EU standard size 1230 x 1480 mm.



A combination of examples 1 and 2 will result in the following savings for a 150 m² house:

Approx. 2.000 kg CO₂ Approx. 630 l. oil Approx. £ 600
(£ 0.95/litre oil)

Calculation assumption: the calculation is based on a 150 m² detached house where Rationel ALDUS windows replace double-glazed windows. Heating is based on an oil-fired furnace.

Windows and doors that do not let in just anybody

Get peace of mind with Rationel's 'Secured by Design' windows and doors.



Rationel windows - 'Secured by Design'

Security performance will be a significant factor when it comes to selecting your windows and doors. Rationel's experience with Housing Associations, community developments and commercial projects, means that the security and safety of our windows and doors is second to none.

Our enhanced windows and doors have been tested and marked according to several national and Euro-

pean standards, including 'Secured by Design'.

To be certified under this initiative, a particular window frame or door frame and corresponding lock and hardware set has to withstand a series of physical tests based on common burglary methods. Rationel has a wide range of products available to 'Secured by Design' specifications.

SECURITY IN - WINDOWS

- Enhanced ironmongery
 - Solid bolts
 - Security receiver with angled screws
 - Hinges fixed with a security angle
- Security sealant is applied to the glass
- Toughened or laminated glass

SECURITY IN - DOORS

- Enhanced ironmongery
 - Three-point espagnolette locking mechanism and hook bolt
 - Security receiver for the bolts
 - Enhanced hinges and angled screws
- Security sealant is applied to the glass
- Toughened or laminated glass

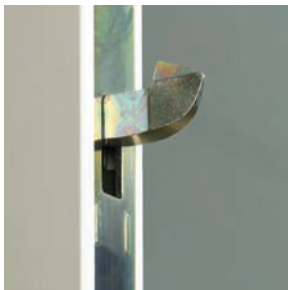

1. A three-point espagnolette locking mechanism and a solid hook bolt in hardened steel are one of the burglary inhibiting details in Rationel doors.



2. A reinforcement espagnolette which increases the strength of all the door closing points.



3. Extra-strong reinforcement espagnolette increases the strength of all door hinges.



4. Hook bolts in hardened steel combined with a reinforced front plate can resist even severe attacks from the burglars' tools.



5. A security receiver with inclined screws fixed in the sturdy part of the frame makes it difficult to break open the window.



6. Window hinges reinforced with extra-strong security angles which make it extremely difficult to pull the sash out of the frame.



7. The relatively long time it takes to break a laminated pane will discourage even the most persistent burglar.



8. Our enhanced windows and doors have been tested and marked according to the police-initiated scheme 'Secured by Design'.

COLOURS SHADES TONES!

CHOOSE BETWEEN STANDARD, SPECIAL, RAL AND GRANITE

When choosing windows and doors from Rationel, it is possible to spice up the appearance and character of your house with colours. Our standard colours cover the majority of architectural building styles and traditions in Ireland. In addition, we offer a range of special colours to accentuate the

special features of a house. Here you can read about how windows and doors are delivered from our factory. And about how you can put your mark on the choice of colours. You can also read more about colours and find inspiration for your choice of colours at rationel.ie.

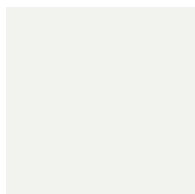

WHITE:
RAL 9010

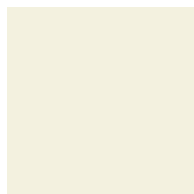

CREAM WHITE:
RAL 9001



LIGHT GREY:
RAL 7035



SLATE GREY:
RAL 7015



ANTHRACITE GREY:
RAL 7016



BLACK:
RAL 9005



ROWANBERRY:
RAL 3011*



SILVER GREY:
RAL 7001*



MID GREY:
RAL 7042*



PEBBLE GREY:
RAL 7032*



BEIGE:
RAL 1001*



BEIGE GREY:
RAL 7006*



YELLOW:
RAL 1018*



OLIVE GREEN:
RAL 6003*



DARK GREEN:
RAL 6007*



BLUE BLACK:
RAL 5008*



NAVY BLUE:
RAL 5013*

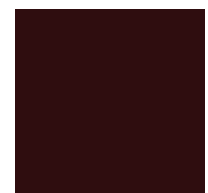

DARK BROWN:
RAL 8017*



PINE:
T129*



DARK PINE:
T990*



GOLDEN OAK:
T220*

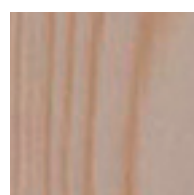

CLEAR LACQUER*

FACTS

The colours shown cannot be reproduced exactly. Therefore, always use an authorised RAL colour chart for accurate colour shades.

TIMBER SURFACE TREATMENT

We always treat the surfaces of our products using our water-based System 2 ECO. First we impregnate the wood, then we prime it and finally we apply a topcoat. The dry-coat thickness of the paint is 80-100 my and the standard colour is a RAL colour, gloss 20.

STANDARD RAL COLOURS

All Rationel's windows and doors are available in one standard RAL colour on the inside and outside according to your wishes. This applies both to timber and timber/aluminium ranges.

TWO COLOURS FOR TIMBER

If you want a standard RAL colour on the inside and a different one on the outside for our PATUS and DOMUS timber ranges. Please note that a surcharge will be applicable.

TRANSLUCENT COLOURS AND CLEAR LACQUER

Translucent colours and clear lacquer are available for the timber sections of DOMUS and ALDUS windows and doors. These types of surface treatment let the natural timber show.

SURFACE TREATMENT OF TIMBER/ALUMINIUM

A polyester powder coating is applied to the aluminium cladding of our timber/aluminium ranges. Our ALDUS range is offered in a standard RAL colour, gloss 77, and the PATUS+ ranges in a standard RAL colour, gloss 30.

TWO COLOURS FOR TIMBER/ALUMINIUM

If you want a two-coloured solution for PATUS+ or ALDUS, our timber/aluminium ranges, the actual timber construction always has the same colour and you can decide the colour of the aluminium cladding, attached with clips.

STANDARD GRANITE COLOURS FOR TIMBER/ALUMINIUM

Rationel offers granite colours for timber/aluminium products at no surcharge. Granite colours have a 'sand-blasted' surface, adding a rustic appearance to the aluminium cladding.

SPECIAL COLOURS

In addition to the standard colours shown here, we have lots of special colours from the RAL scale for you to choose from. Contact Rationel to learn about prices for special colours.

USE A RAL COLOUR CHART

Rationel does not guarantee that the colours shown in the colour examples are accurate. It is therefore important to use an authorised RAL colour chart to choose the desired colour.

WEATHER STRIPS

Weather strips are grey, irrespective of window or door colours or ranges.

SPECIAL SOLUTIONS

Most people choose the same colour inside and outside. However, we also offer special solutions, such as different colours for the sash and frame inside and the sash and frame outside. Various options can therefore help you accentuate the character of a building or special parts of it, such as bays or conservatories. Ask your approved installer for information about prices of special solutions.

GRANITE COLOURS

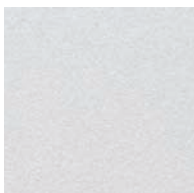

WHITE SAA10F
SABLE



GRIS 2150
SABLE

*Not available for AURA
and Rationel AURAPLUS

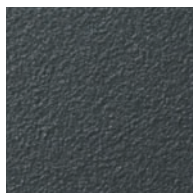

GRIS 2400
SABLE



GRIS 2900
SABLE

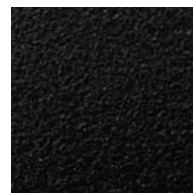

NOIR 2100
SABLE

You do not have to choose square solutions when rebuilding, extending or building a new home



Ideas and imagination are highly appreciated at Rational. No matter whether the creative ideas come from you, the architect or the carpenter, they should not be constrained by standard

solutions. We produce special units for both refurbishment and new-build projects. Here you can see a few examples of customised solutions. Visit rational.ie and be inspired.



Windows and doors are made in the size, shape and colour that suit your needs.



Peace of mind thanks to Rationel's certifications, labels and warranties

Like many others, the window industry also has certifications, labels and warranties intended to protect consumers and the environment. Some are compulsory, others have been developed by the window industry in order to make it even easier and safer for customers to decide what to choose.

Here you can gain an insight into the warranties, certifications and labels with which Rationel's products must comply. And perhaps also an idea of what is required to manufacture windows and doors which must be able to function for many years in the buildings and houses they are chosen for.

DVV CERTIFICATE

Rationel is DVV-certified. This means that DVV (Danish Window Verification) visit factories regularly to ensure that its certified members observe the product and production standards specified in its technical provisions.

CE MARKING

Rationel's products are tested in accordance with the CE marking scheme developed in 2008. This is your guarantee of a highly reliable product.

THE WOOD WINDOW ALLIANCE

Windows made from wood are increasingly seen as the most sustainable, as well as the most attractive, solution.

More than 40 members of the wood window industry have come together to market a range of high quality-products that meet independently audited performance and sustainability standards. The Wood Window Alliance provides reassurance that the windows from the member suppliers meet performance and sustainability standards.

SECURED BY DESIGN

Security performance will be a significant factor when it comes to selecting your windows and doors. Rationel's experience with Housing Associations, community developments and commercial projects, means that the security and safety of our windows is second to none.

Our enhanced windows and doors have been tested and marked according to several national and European standards, including 'Secured by Design', a police initiative to encourage the adoption of crime-prevention measures in the design of new developments and renovations.

BM Trada is the certification body that makes sure that the demands of 'Secured By Design' are met.

ENVIRONMENT

Rationel's windows and doors are made of timber from forests where systematic reforestation and incremental levels exceed felling levels. The vast majority of timber originates from FSC-certified forests. Waste glass and excess aluminium from our production are recycled.

Our production treats all windows and doors using System 2 ECO, which comprises eco-friendly impregnation, painting and finishing ensuring long lives for our products.

Rationel's products meet the requirements specified by Danish Indoor Climate Labelling. The label means that the products does not give off toxic substances when they are installed in buildings.

WARRANTY

Our guarantee covers defects in manufacturing and materials excluding paint finishes in windows and doors delivered and used in Ireland. The warranty is valid for six years for windows and doors and for three years for ironmongery from the date of production. Panes are covered by the Danish Glass Association's warranty against punctured panes (six years) and visual defects (one year). See rationel.ie for more information about the pane warranty and sound advice on double-glazed units.

Timber is a natural living product where colour differences, knots and weeping may occur and hence these occurrences are not covered by our warranty. Furthermore, Rationel's products are covered by product liability insurance covering damage caused by a Rationel product. The insurance applies if the damage is proved to be caused by a fault caused by Rationel. The insurance does not cover consequential loss, loss of profits or any other indirect loss.



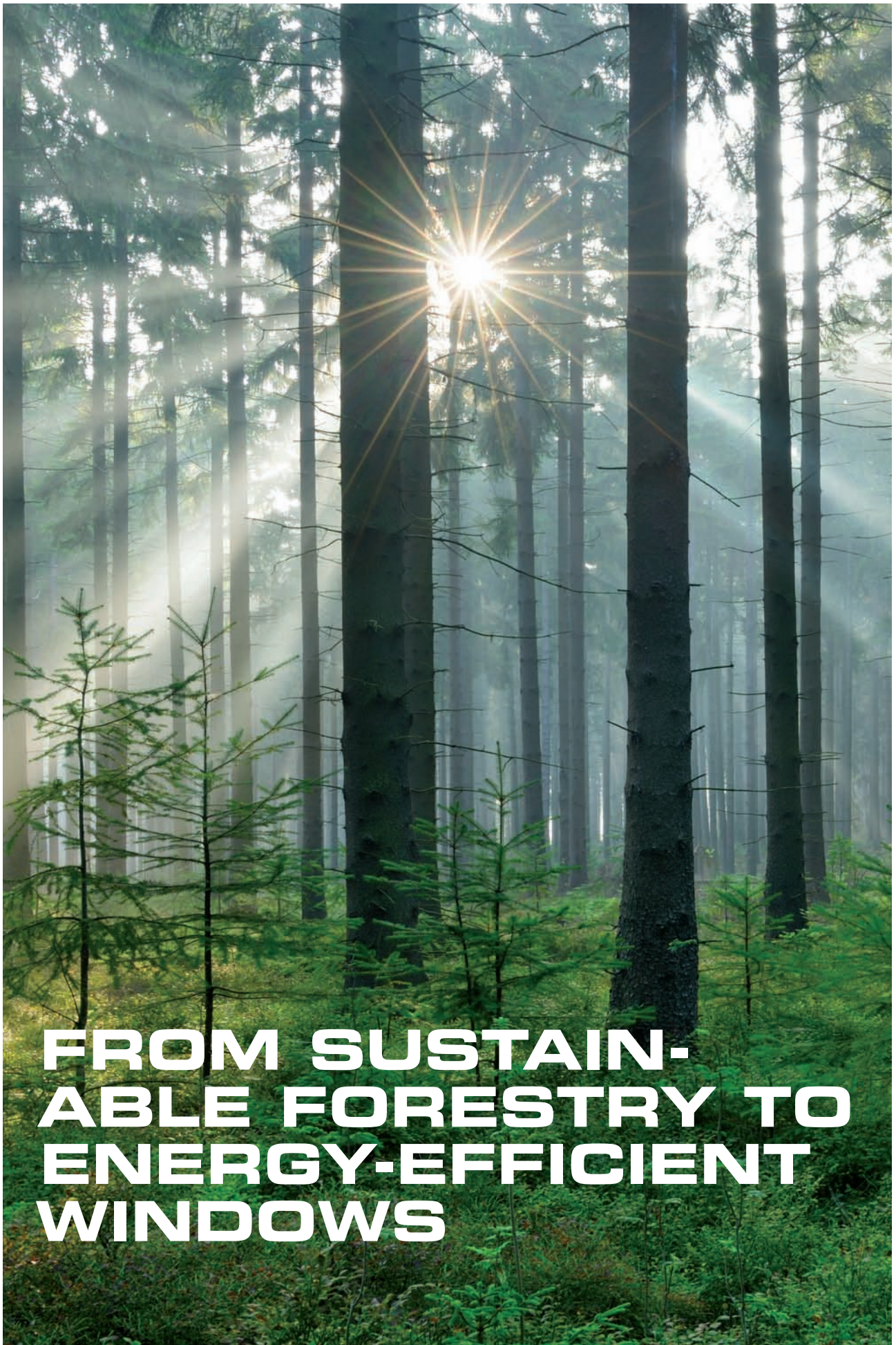

**FROM SUSTAIN-
ABLE FORESTRY TO
ENERGY-EFFICIENT
WINDOWS**

At Rationel, we decided to be certified according to the FSC's global labelling scheme for sustainable wood and paper. The FSC (Forest Stewardship Council) is an international not-for-profit organisation that makes it possible to buy wood and paper products with a clear conscience. Companies all over the world comply with FSC's guidelines for sustainability and legality in their production. As far as Rationel is concerned, the FSC label guarantees: that, due to our production, we fell no more trees than the forest is able to reproduce; that wildlife

and vegetation in the forests are protected; and that forest workers receive training, safety equipment and a decent wage. FSC is the only global labelling scheme which is widely supported by green organisations, such as WWF, Greenpeace and Nepenthes; social organisations, such as BAT; and companies all over the world.

See fsc.org for additional information about the FSC requirements which we and other FSC-labelled companies must meet.

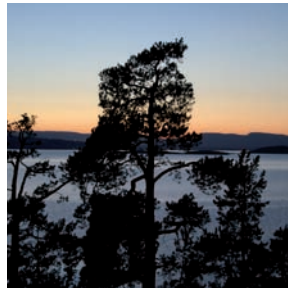

FSC ensures consideration for nature, wildlife and people.

The FSC label guarantees that no more trees are felled than the forest is able to reproduce naturally.

Parts of the forest are protected entirely in order to protect endangered animals and plants.

Indigenous people such as Indians and Samians are ensured their right to use the forest. Any sacred sites in the forest are exempt from felling.

Local workers receive training, safety equipment and a decent wage they can live on.

The local population benefits from income from the forest and local labour is used.

All timber can be traced back to the forest. All links between the forest and you are certified so that you always know what is FSC and what is not.

FSC certification is a business which the forest owner, the worker and the manufacturer can live on. FSC simply has the additional advantage that both nature and people enjoy better living conditions.

All types of forests can be FSC-certified, from Scandinavian coniferous forests to tropical rainforests – and plantations, too.

FSC is not only available in timber for furniture, it is also available for floors, patios, paper, charcoal for grilling – in other words, in everything made of timber.

10

good reasons
for choosing
FSC-labelled
products

WINDOW OPENING TYPES

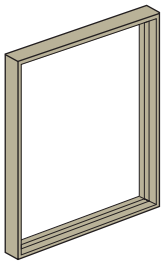

Fixed Light

All Rationel windows can be fitted with modern energy-efficient double-glazed units. This makes it possible to design buildings with large sections of glass, while keeping energy use and costs to a minimum.

Our Fixed Light windows are ideal wherever maximum internal light is required, or for glass sections that overlook gardens or attractive views.

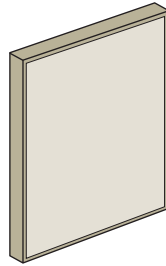

Ventilated Fixed Light

Rationel can provide covered ventilation in frame sections that are surrounded by a 115 mm frame or post. The construction principle is based on a 2-layered external plating system.

Available in DOMUS/
ALDUS



Louvred Panel

The unit is based on a Side Light where the glass has been replaced with horizontal louvres externally and with an insect screen internally.

Internally two insulated doors, one above the other, can be opened to control ventilation. Both doors have a friction brake to hold the doors open in any position.

Available in DOMUS/
ALDUS

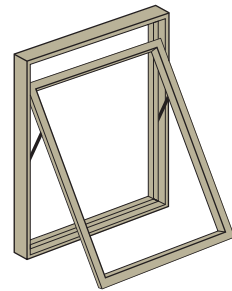

Top Guided

Top Guided windows are a simple, elegant and user-friendly design. Opening is controlled by tracks and slides. When opening the window the top of the sash slides downwards as the bottom of the sash opens outwards. Adjustable friction ironmongery allows an almost infinite choice of open positions.

The drawings shown below are examples of options available. Contact Rationel for information about further options.

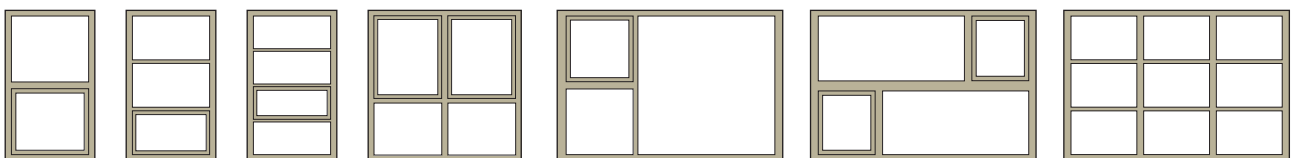
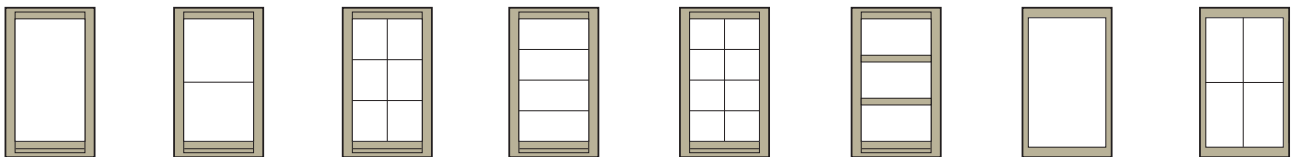

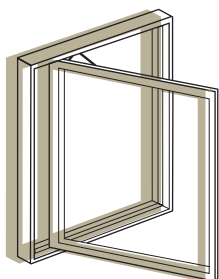

Side Guided

Side Guided windows are controlled by tracks and slides that allow the window to be fixed in any open position. However, when opened, the hinge side of the sash moves toward the middle to create an opening that allows the glass to be cleaned from the inside.

Windows over 708mm wide are fitted with an adjustable friction brake controlled by the handle.

Side Guided windows can also be used for emergency exits.

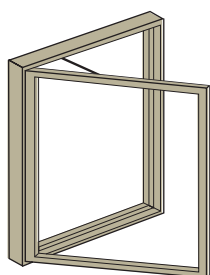

Side Hung

Like Top Guided windows, Side Hung windows are also controlled with tracks and slides. On windows over 588mm wide, the handle-controlled friction brake allows the window to be fixed in any open position.

Side Hung windows can also be used for emergency exits.

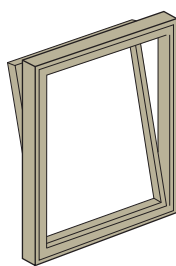

Tilt & Turn

Tilt & Turn windows function in two ways: they are hinged from the side and open inwards: or for ventilation the sash can be tilted in at the top. Tilt & Turn windows can be cleaned from the inside.

Tilt & Turn windows can also be used for emergency exits.

Available in DOMUS/ALDUS

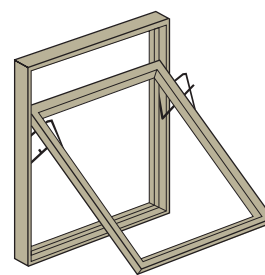

Top swing

In everyday operation the fully reversible window functions as a Top Guided window. However, an ingenious mechanism makes it possible to turn the sash through 180 degrees to clean the glass from the inside.

Available in DOMUS/ALDUS

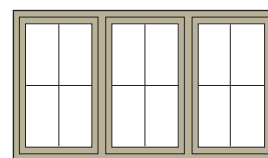
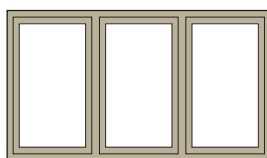
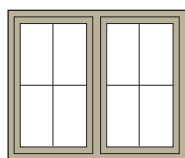
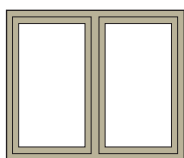

DOOR OPENING TYPES

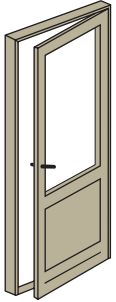

Entrance Doors

These are available as inward or outward opening. They are hung on grey powder-coated adjustable hinges and fitted with a minimum three-point locking espagnolette bolt.

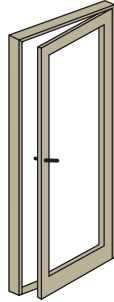

Tilt & Turn Doors

Tilt & Turn doors function in two ways: for ventilation the door tilts in at the top; to open the sash is side hung and opens inwards. Tilt & Turn doors can be cleaned from the inside and are suitable as emergency exits.

Available in DOMUS/ALDUS

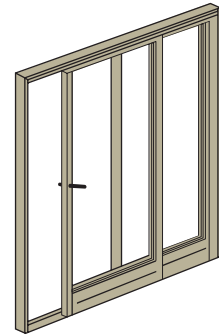

Sliding Patio Doors

Rational Patio Doors are designed to be as beautiful as the views they frame. Sliding Patio Doors, where one half slides and the other is fixed, are ideal when space is at a premium. The sliding part lifts easily and glides in front of the fixed section to create an opening of up to 1.55 metres.

Available in DOMUS/ALDUS

The drawings shown below are examples of options available. Contact Rational for information about further options.

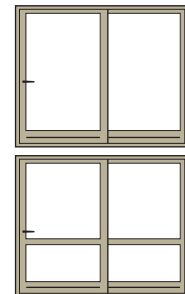
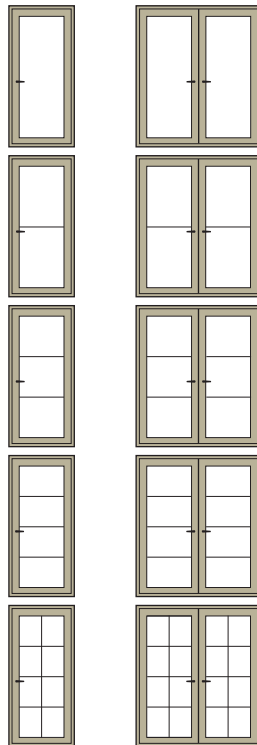

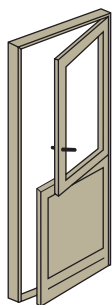

Stable Doors

These are available as outward-opening only. The top half of the door opens either independently or together with the bottom half.

They are hung on grey powder-coated adjustable hinges and fitted with a two-point locking espagnolette bolt on both halves of the door.

Available in DOMUS/ALDUS/
PATUS/PATUS+

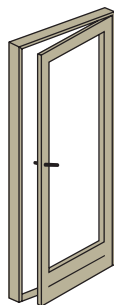

Terrace / Window Doors

Terrace Doors are available as either inward or outward opening, while Window Doors are available as outward opening. Both doors are ideal for access to balconies, gardens and patios.

Doors which open outwards have an inbuilt friction brake, operated by turning the handle down in any given position. They are hung on grey-powder coated adjustable hinges and fitted with a minimum three-point locking espagnolette bolt.

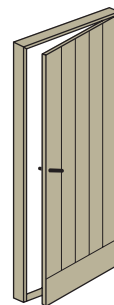

Panelled Door

These are available as inward or outward opening, hung on grey powder-coated adjustable hinges and fitted with a minimum three-point locking espagnolette bolt.

Available in DOMUS/ALDUS

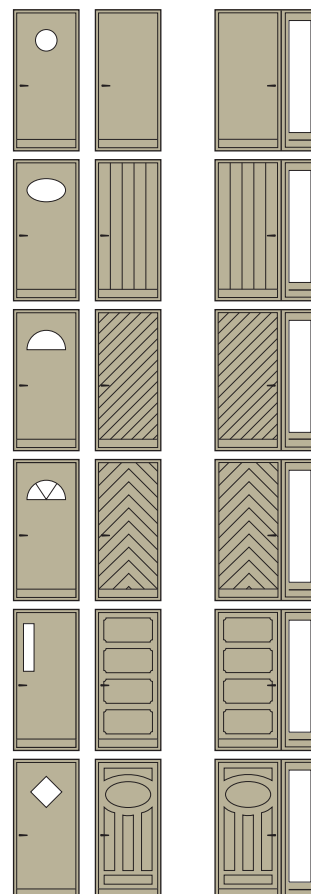
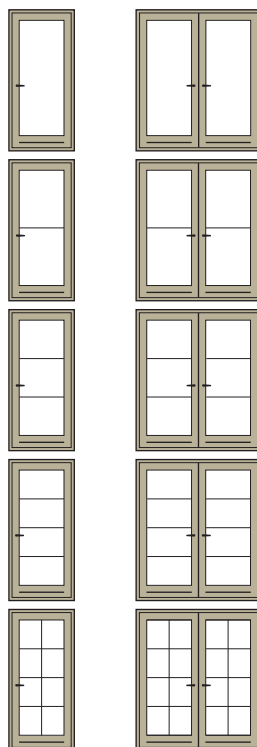

WINDOW MINIMUM AND MAXIMUM MEASUREMENTS

Fixed Light

	ALDUS	DOMUS	PATUS+	PATUS
Minimum frame width	228 mm	228 mm	228 mm	228 mm
Minimum frame height	588 mm	258 mm	258 mm	258 mm
Maximum frame width	2388 mm	2388 mm	2388 mm	2388 mm
Maximum frame height	2388 mm	2388 mm	2388 mm	2388 mm
Total maximum width & height	4776 mm	4776 mm	4776 mm	4776 mm

Side Hung Window (outward opening)

	ALDUS	DOMUS	PATUS+	PATUS
Minimum frame width	388 mm	388 mm	358 mm	358 mm
Minimum frame height	353 mm	353 mm	358 mm	358 mm
Maximum frame width	948 mm	948 mm	768 mm	768 mm
Maximum frame height	1788 mm	1788 mm	1788 mm	1788 mm
Total maximum width & height	2676 mm	2676 mm	-	-

Top Guided Window (outward opening)

	ALDUS	DOMUS	PATUS+	PATUS
Minimum frame width	353 mm	353 mm	328 mm	328 mm
Minimum frame height	538 mm	538 mm	328 mm	328 mm
Maximum frame width	1608 mm	1608 mm	1368 mm	1368 mm
Maximum frame height	1588 mm	1588 mm	1388 mm	1388 mm
Total maximum width & height	2776 mm	2776 mm	2696 mm	2696 mm

Topswing Window (outward opening)

	ALDUS	DOMUS	PATUS+	PATUS
Minimum frame width	353 mm	353 mm	-	-
Minimum frame height	488 mm	488 mm	-	-
Maximum frame width	1608 mm	1608 mm	-	-
Maximum frame height	1588 mm	1588 mm	-	-
Total maximum width & height	2876 mm	2876 mm	-	-

Tilt & Turn Window (inward opening)

	ALDUS	DOMUS	PATUS+	PATUS
Minimum frame width	538 mm	538 mm	-	-
Minimum frame height	588 mm	588 mm	-	-
Maximum frame width	1488 mm	1488 mm	-	-
Maximum frame height	1833 mm	1833 mm	-	-
Total maximum width & height	3276 mm	3276 mm	-	-

Side Guided Window (outward opening)

	ALDUS	DOMUS	PATUS+	PATUS
Minimum frame width	408 mm	408 mm	428 mm	428 mm
Minimum frame height	353 mm	353 mm	358 mm	358 mm
Maximum frame width	1188 mm	1188 mm	948 mm	948 mm
Maximum frame height	1788 mm	1788 mm	1788 mm	1788 mm
Total maximum width & height	2676 mm	2676 mm	2536 mm	2536 mm

DOOR MINIMUM AND MAXIMUM MEASUREMENTS

Entrance Door (inward or outward opening)

	ALDUS	DOMUS	PATUS+	PATUS
Minimum frame width	648 mm	648 mm	648 mm	648mm
Minimum frame height	1708 mm	1708 mm	1708 mm	1708mm
Maximum frame width	1068 mm	1068 mm	1068 mm	1068mm
Maximum frame height	2388 mm	2388 mm	2388 mm	2388mm

Terrace Door (inward or outward opening) / Window Door (outward opening)

	ALDUS	DOMUS	PATUS+	PATUS
Minimum frame width	648 mm	648 mm	648 mm	648 mm
Minimum frame height	1708 mm	1708 mm	1708 mm	1708 mm
Maximum frame width	1188 mm	1188 mm	1188 mm	1188 mm
Maximum frame height	2388 mm	2388 mm	2388 mm	2388 mm

Sliding Patio Door

	ALDUS	DOMUS	PATUS+	PATUS
Minimum frame width	1788 mm	1788 mm	-	-
Minimum frame height	1888 mm	1888 mm	-	-
Maximum frame width	3588 mm*	3588 mm*	-	-
Maximum frame height	2388 mm*	2388 mm*	-	-

At frame width bigger than 2988mm the maximum frame height is 2188mm.

Stable Door (outward opening)

	ALDUS	DOMUS	PATUS+	PATUS
Minimum frame width	648 mm	648 mm	648 mm	648 mm
Minimum frame height	1908 mm	1908 mm	1908 mm	1048 mm
Maximum frame width	1068 mm	1068 mm	1068 mm	1068 mm
Maximum frame height	2388 mm	2388 mm	2388 mm	2388 mm

Tilt & Turn Door (inward opening)

	ALDUS	DOMUS	PATUS+	PATUS
Minimum frame width	538 mm	538 mm	-	-
Minimum frame height	1838 mm	1838 mm	-	-
Maximum frame width	1008 mm	1008 mm	-	-
Maximum frame height	2208 mm	2208 mm	-	-

Panelled Door (inward or outward opening)

	ALDUS	DOMUS	PATUS+	PATUS
Minimum frame width	648 mm	648 mm	-	-
Minimum frame height	1708 mm	1708 mm	-	-
Maximum frame width	1068 mm	1068 mm	-	-
Maximum frame height	2388 mm	2388 mm	-	-

CHOOSE THE RIGHT DOOR FOR YOUR HOME

The door to your house is the gateway to your home. Your choice of entrance door and the way it looks influences your home's architectural expression. Therefore it is important that you carefully consider the opening and closing functions and the designs available from Rational. Colour is another important aspect of expression to consider.

We hope you are inspired by the following pages.

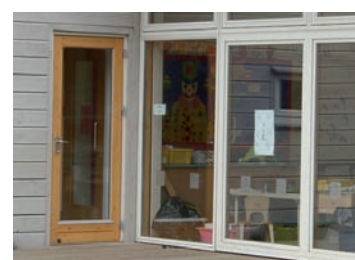



1 Entrance door with 2 glass panes and 3 raised panels
Colour: White RAL 9010



2 Entrance door with 8 raised panels
Colour: Light grey RAL 7035



3 Entrance door with 3 glass panes
Colour: White RAL 9010



4 Entrance door with 2 glass panes and 2 raised panels
Colour: Olive green RAL 6003



5 Entrance door with 3 glass panes
Colour: Slate grey RAL 7015



6 Entrance door with 2 glass panes
Colour: Slate grey RAL 7015



7 Entrance door with 4 glass panes and 3 raised panels
Colour: Silver grey RAL 7001



8 Entrance door with 4 glass panes and 3 raised panels
Colours: Light grey RAL 7035



9 Entrance door with 6 glass panes and 2 raised panels
Colour: Light grey RAL 7035

Entrance doors in DOMUS and PATUS can be delivered with either raised or smooth panels. Entrance doors in ALDUS and PATUS+ are available with smooth panels only.



10 Entrance door with 6 glass panes and 1 raised panel
Colour: Light grey RAL 7035



11 Entrance door with 8 glass panes
Colour: White RAL 9010



12 Panelled door with glass pane
Colour: Golden Oak T220

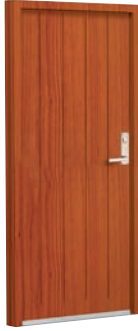

13 Panelled door with vertical pattern
Colour: Golden Oak T220



14 Panelled door with vertical pattern and glass pane
Colour: Golden Oak T220



15 Entrance door with 3 glass panes and side light with 3 glass panes
Colour: White RAL 9010



16 Panelled door with classical pattern
Colour: Slate grey RAL 7015



17 Panelled door with glass pane
Colour: Golden Oak T220



18 Panelled door with classical pattern and glass pane
Colour: Light grey RAL 7035



19 Panelled door, smooth with round glass pane
Colour: Slate grey RAL 7015



20 Panelled door with herringbone pattern and glass pane
Colour: Dark brown RAL 8017



21 Panelled door with vertical pattern and glass pane
Colour: White RAL 9010



22 Panelled door with vertical pattern and glass pane
Colour: White RAL 9010



23 Panelled door, smooth with glass pane
Colour: Slate grey RAL 7015



24 Panelled door with classical pattern
Colour: White RAL 9010



25 Panelled door, smooth with round glass pane
Colour: Slate grey RAL 7015



26 Panelled door, smooth with glass pane
Colour: Cobalt blue RAL 5013



27 Panelled door smooth
Colour: White RAL 9010



28 Panelled door with vertical pattern and glass pane
Colour: White RAL 9010



29 Panelled door with heeringbone pattern and side light
Colour: White RAL 9010



30 Panelled door, smooth with round glass pane
Colour: White RAL 9010



31 Panelled door with vertical pattern and glass pane
Colour: Golden Oak T220



32 Terrace door WML with 1 glass pane and 1 rail
Colour: White RAL 9010



33 Terrace door with 1 glass pane and 2 rails
Colour: White RAL 9010



34 Terrace door with 8 glass panes
Colour: White RAL 9010



35 Double terrace door with 8 glass panes
Colour: White RAL 9010



ACCESSORIES

Choose from our standard range of handles, locks and stays to suit your windows and doors



ID DOOR HANDLE WITH BACK PLATE



ID DOOR HANDLE WITH ROUND ROSES



ID DOOR HANDLE WITH ROUND ROSES



ID DOOR HANDLE WITH BACK PLATE

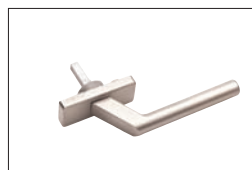

ID HANDLE
for tilt and turn windows and doors

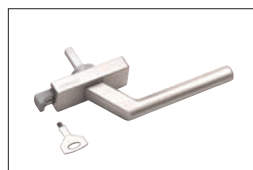

ID HANDLE WITH KEY
for tilt and turn windows and doors



ID HANDLE STRAIGHT



ID HANDLE WITH KEY
for outward-opening windows and terrace doors



ID HANDLE WITH CHILD LOCKING
for outward-opening windows and terrace doors



ID HANDLE
for outward-opening windows and terrace doors



ID HANDLE FOR SLIDING DOOR
for cylinder



ID HANDLE FOR SLIDING DOOR



ID BOWL FOR SLIDING DOOR



INTERNAL CYLINDER AND KEY



DOUBLE KEY CYLINDER



DOUBLE KEY CYLINDER
for sliding patio doors
Available in chrome or brass.



INTERNAL CYLINDER AND KEY FOR TERRACE DOORS ONLY
Item no. 2784 - outward opening
Item no. 2785 - inward opening



PN WINDOW STAY
for outward-opening windows
Item no. 3853 - silver
Item no. 3853,02 - gold
Item no. 3853,50 - white



170 MM PN WINDOW STAY
for outward-opening windows and terrace doors
Item no. 0904



FINGER PULL
for terrace doors
Item no. 4042



LETTER PLATE FOR ENTRANCE DOORS
Item no. 2722 - silver anodized
Item no. 2722,24 - gold anodized



LETTER PLATE FOR PANELLED DOORS
Item no. 2724 - silver anodized



SPY HOLE
For entrance doors
Item no. 2725



PUSH VENT
for outward-opening windows and terrace doors
Item no. 501124+4075

DOMUS® Section Drawings 1:5

Fixed Lights

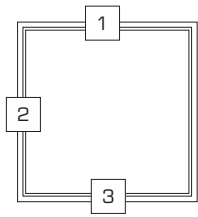

Type A11.00

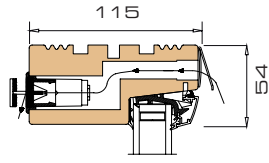

1 Vertical section head with vent

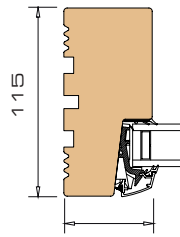

2 Horizontal section jamb

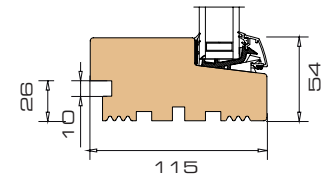

3 Vertical section sill

Outward Opening Windows

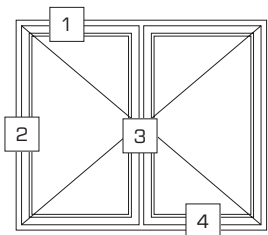

Type A21.00 - 21.11
A23.00 - 23.20
A24.00 - 24.2X

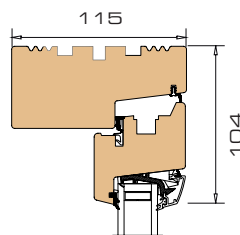

1 Vertical section head / -sash

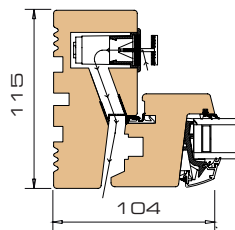

2 Horizontal section jamb / -sash with vent

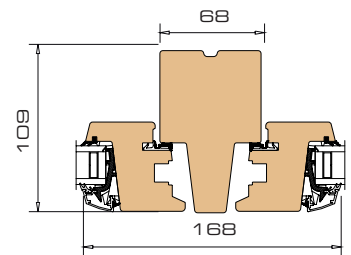

3 Horizontal section mullion / -sash

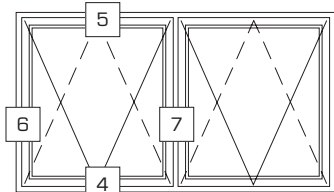

Type A27.00 - 27.10

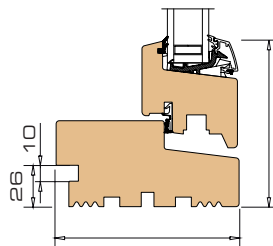

4 Vertical section sill / -sash

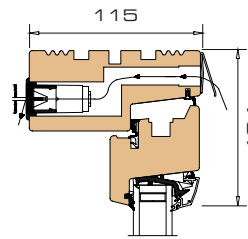

5 Vertical section head / -sash with vent

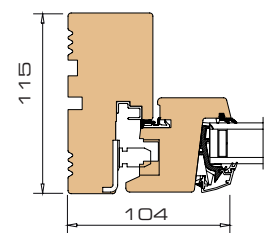

6 Horizontal section jamb / -sash

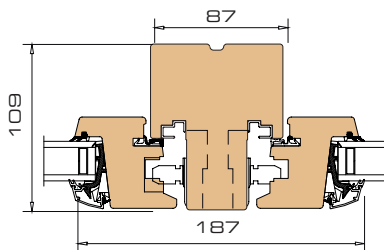

7 Horizontal section mullion / -sash

Tilt & Turn Windows

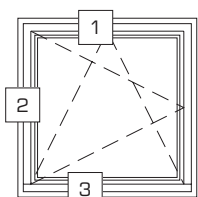

Type A26.00

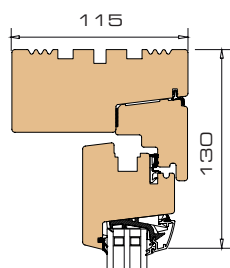

1 Vertical section head / -sash

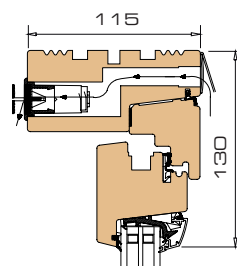

1 Vertical section head / -sash with vent

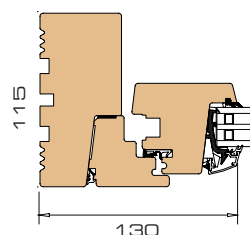

2 Horizontal section jamb / -sash

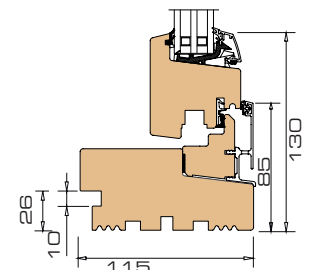

3 Vertical section sill / -sash

DOMUS® Section Drawings 1:5

Side Lights

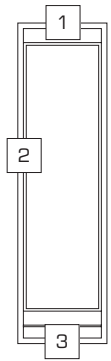

Type A12.00

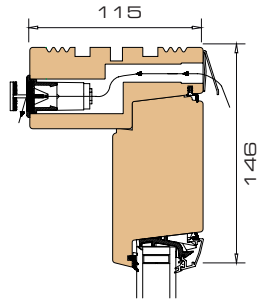

1 Vertical section head with rail and vent

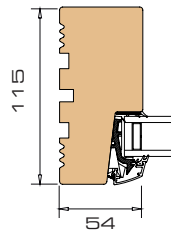

2 Horizontal section jamb

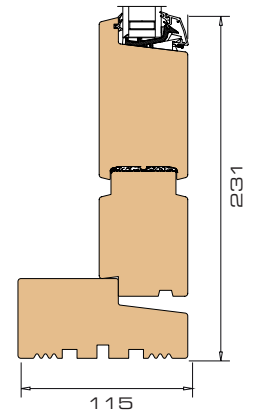

3 Vertical section sill with rails

Louvred Side Lights

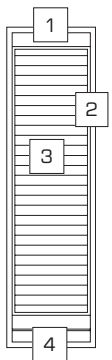

Type A14.00

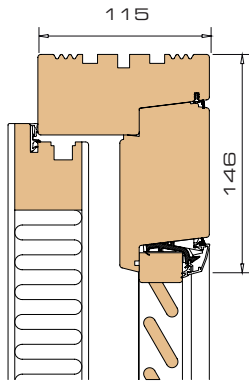

1 Vertical section head with rail

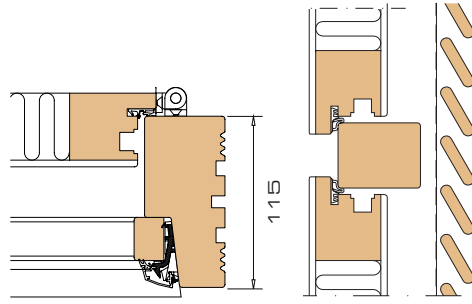

2 Horizontal section jamb

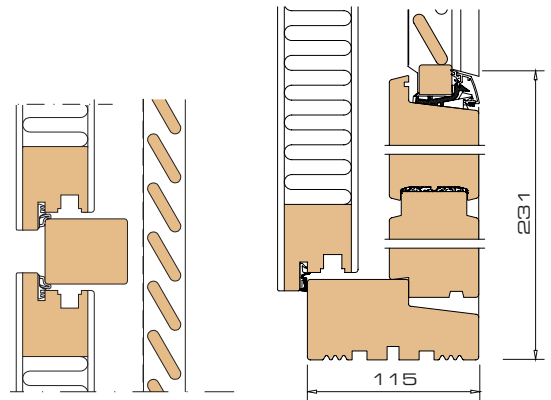

4 Vertical section sill with rails

3 Vertical section centre mullion

Outward Opening Doors

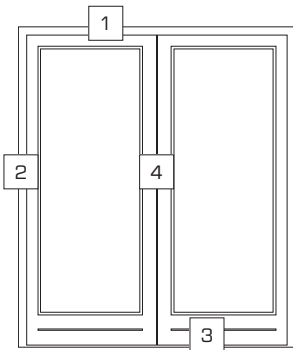

Type A41.00
A41.50

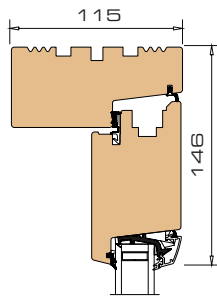

1 Vertical section head / -sash

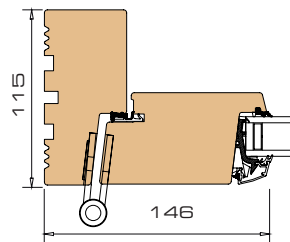

2 Horizontal section hinge side

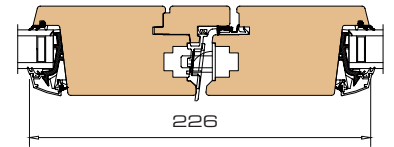

4 Horizontal section rebated sashes

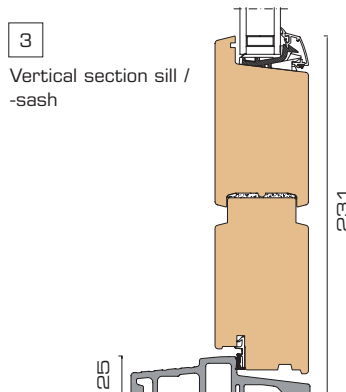

3 Vertical section sill / -sash

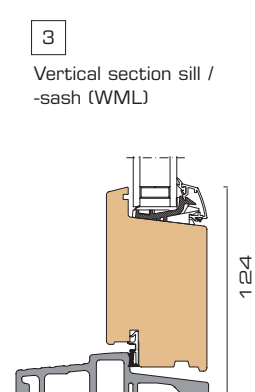

3 Vertical section sill / -sash (WML)

DOMUS® Section Drawings 1:5

Outward Opening Doors

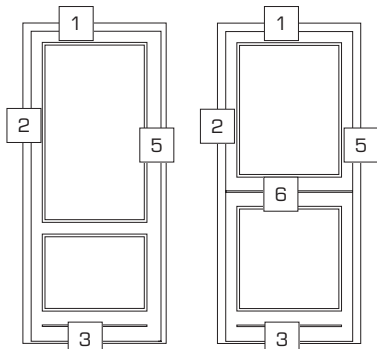

Type A31.00
A31.50
A32.11
A32.12

Type A33.00

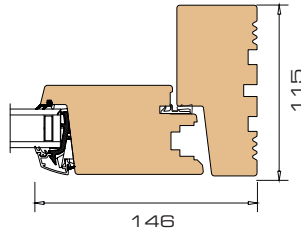

5 Horizontal section locking side

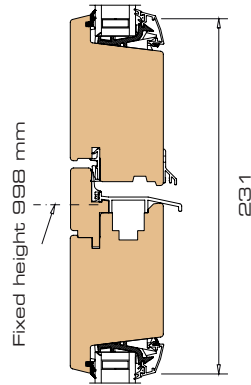

6 Vertical section rebated sashes

Inward Opening Doors

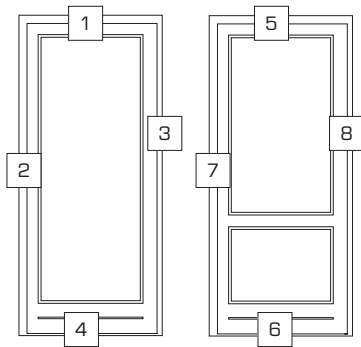

Type A34.00

Type A31.00
A32.11
A32.12

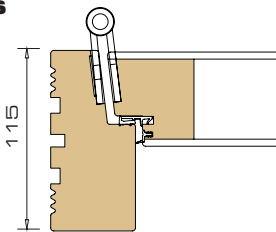

1 Vertical section head / door plate

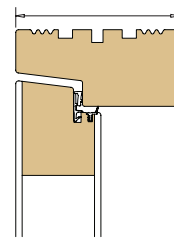

2 Horizontal section hinge side

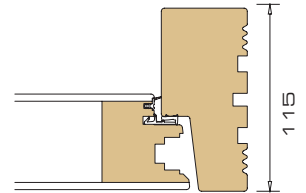

3 Horizontal section locking side

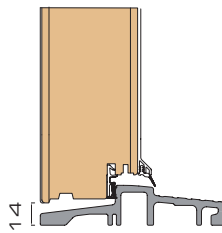

4 Vertical section sill / door plate

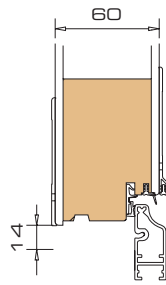

4 Vertical section bottom rail / door plate

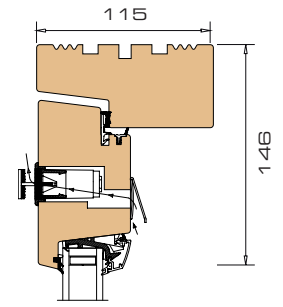

5 Vertical section head / sash with vent

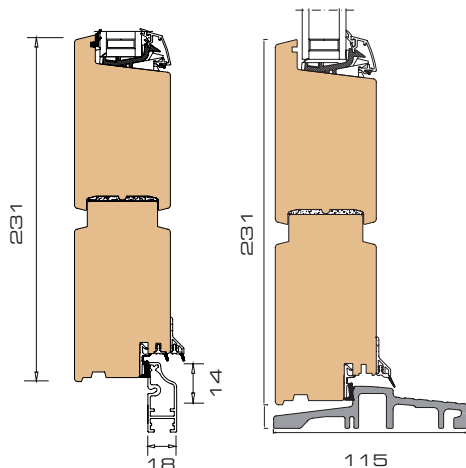

6 Vertical section bottom rail / -sash

6 Vertical section sill / -sash

7 Horizontal section hinge side

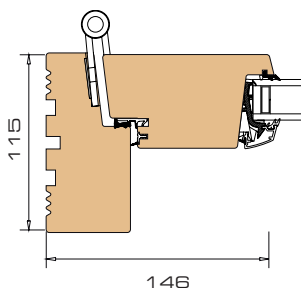

8 Horizontal section locking side

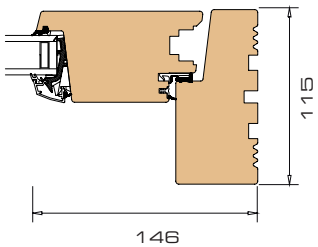

DOMUS® Section Drawings 1:5

Tilt & Turn Doors

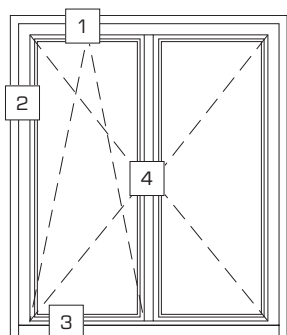

Type A36.00
A46.00

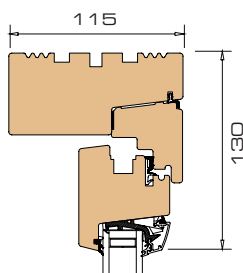

1 Vertical section head / -sash

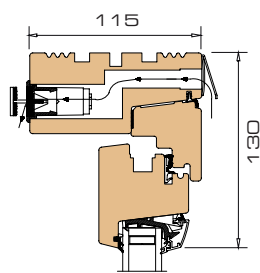

1 Vertical section head / -sash with vent

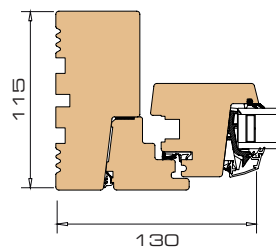

2 Horizontal section hinge side

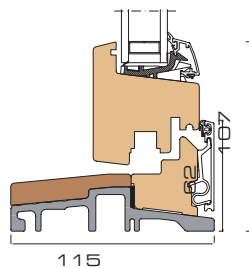

3 Vertical section sill / -sash

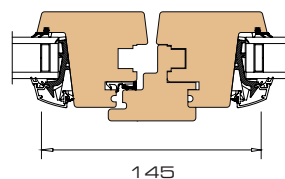

4 Horizontal section rebated sashes

Sliding Patio Doors

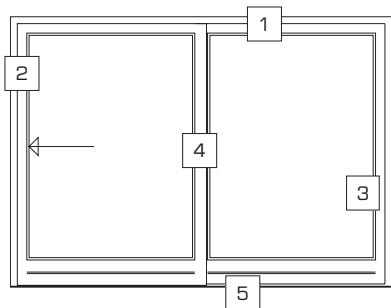

Type A48.00

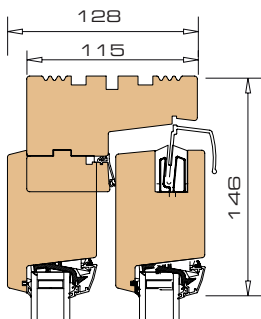

1 Vertical section head / -sash

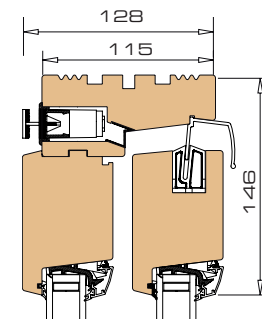

1 Vertical section head / -sash with vent

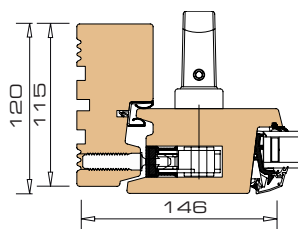

2 Horizontal section jamb / -sash

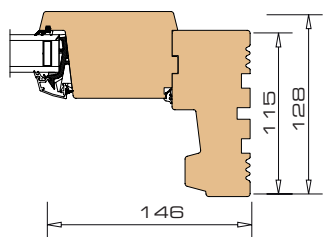

3 Horizontal section jamb / -sash

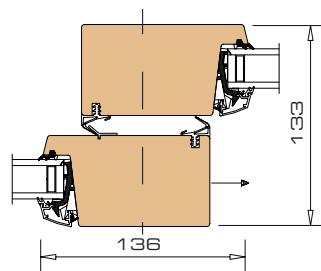

4 Horizontal section rebated sashes

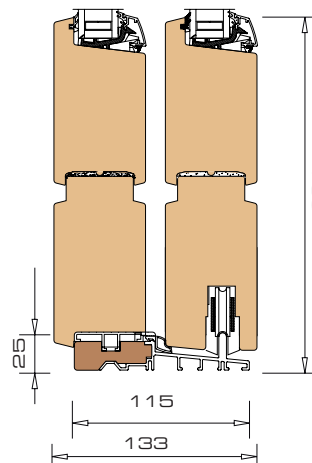

5 Vertical section sill / -sash

DOMUS® Section Drawings 1:5

Glazing Bars / rails

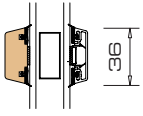

Vertical section 36 mm bonded glazing bar

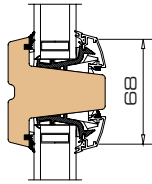

Vertical section 68 mm glazing bar

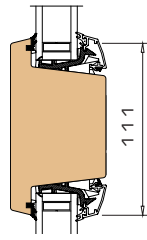

Vertical section 111 mm rail

Ventilated panels

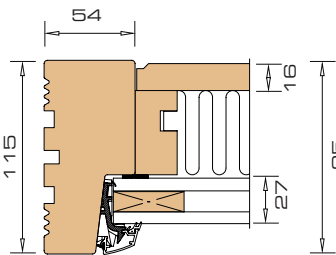

Horizontal section jamb

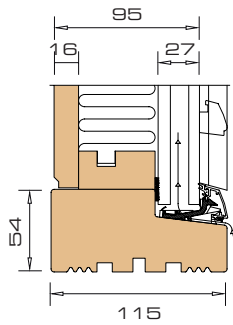

Vertical section sill

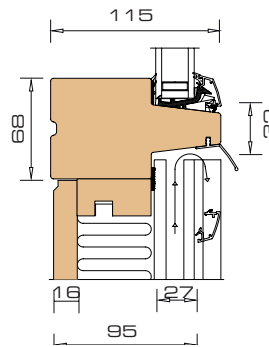

Vertical section transom

DOMUS® / PATUS® Section Drawings 1:5

Insulated panels

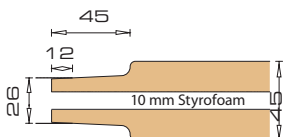

Raised timber panel

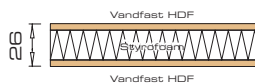

Smooth timber panel

ALDUS® Section Drawings 1:5

Fixed Lights

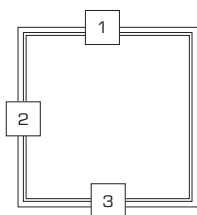

Type B11.00

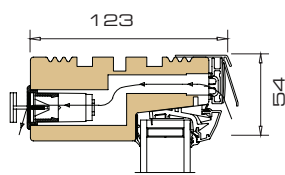

1 Vertical section head

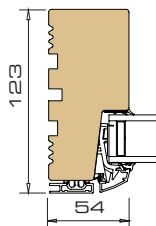

2 Horizontal section jamb

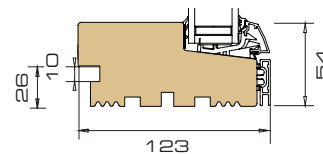

3 Vertical section sill

Outward Opening Windows

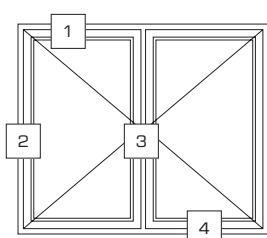

Type B21.00 - 21.11
B23.00 - 23.20
B24.00 - 24.2X

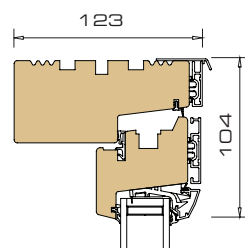

1 Vertical section head / -sash

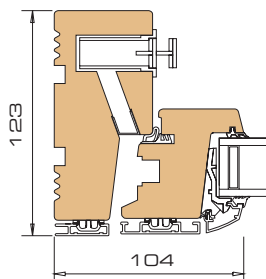

2 Horizontal section jamb / -sash with vent

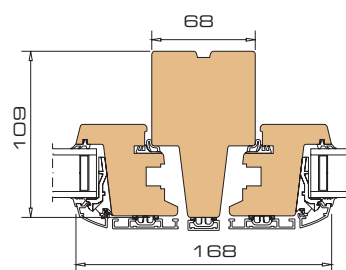

3 Horizontal section mullion / -sashes

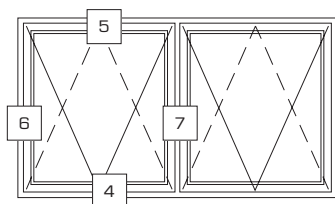

Type B27.00 - 27.10

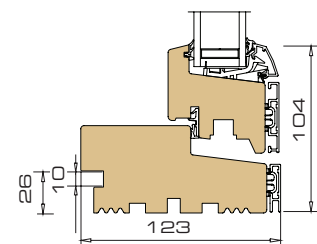

4 Vertical section sill / -sash

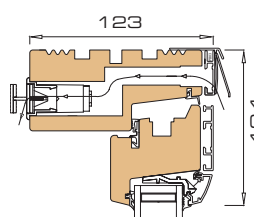

5 Vertical section head / -sash with vent

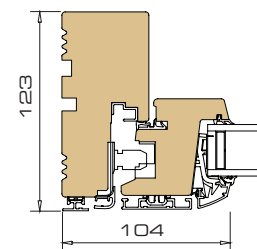

6 Horizontal section jamb / -sash

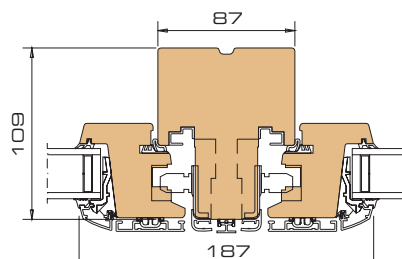

7 Horizontal section mullion / -sashes

Tilt & Turn Windows

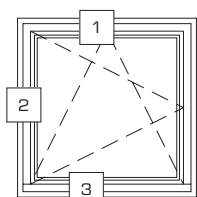

Type B26.00

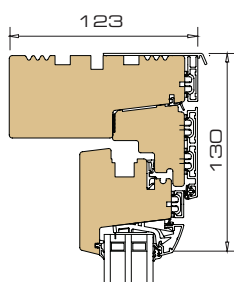

1 Vertical section head / -sash

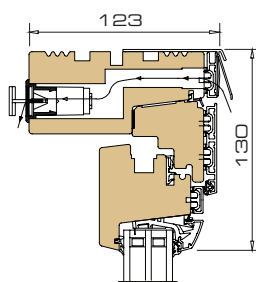

1 Vertical section head / -sash with vent

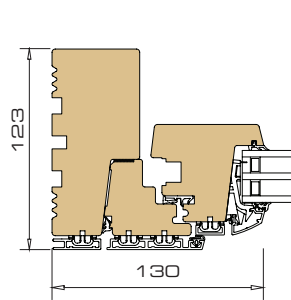

2 Horizontal section jamb / -sash

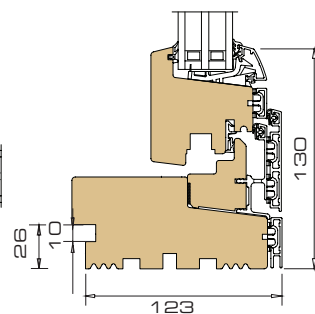

3 Vertical section sill / -sash

ALDUS® Section Drawings 1:5

Side Light

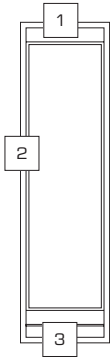

Type B12.00

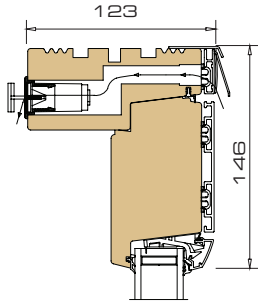

1 Vertical section head with rail with vent

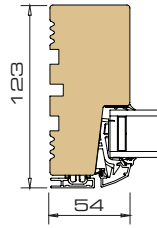

2 Horizontal section jamb

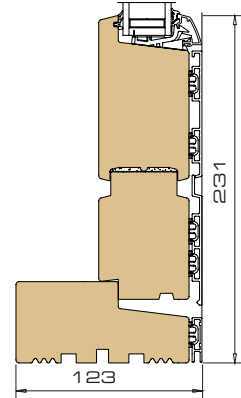

3 Vertical section sill with rails

Louvred Side Lights

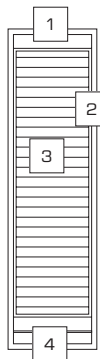

Type B14.00

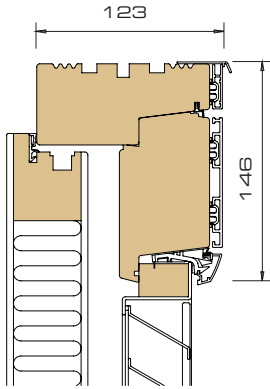

1 Vertical section head with rail

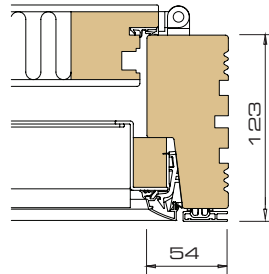

2 Horizontal section jamb

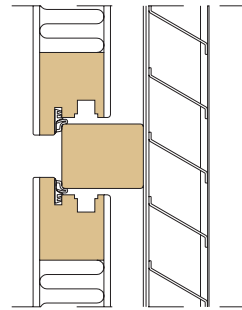

3 Vertical section centre mullion

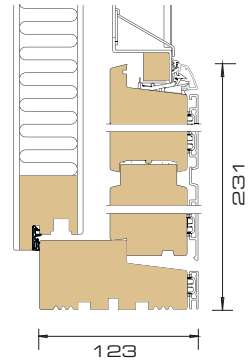

4 Vertical section sill with rails

Outward Opening Doors

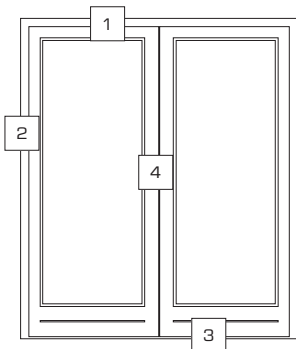

Type B41.00
B41.50

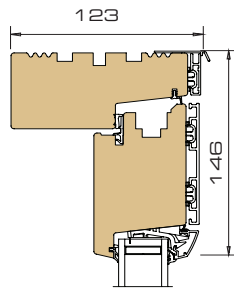

1 Vertical section head / -sash

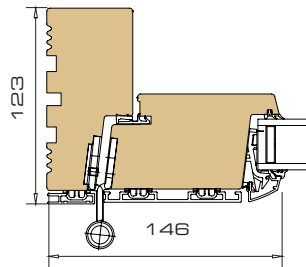

2 Horizontal section hinge side with vent

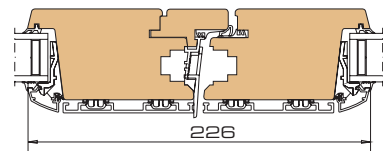

4 Horizontal section rebated sashes

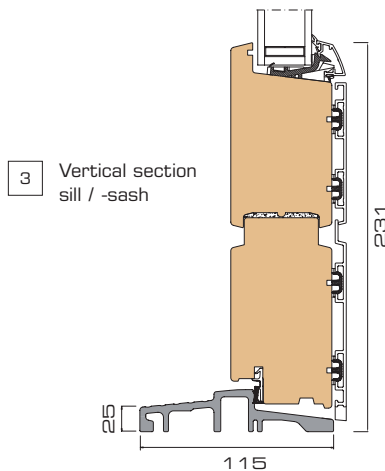

3 Vertical section sill / -sash

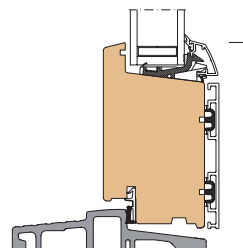

3 Sill with internal hardwood covering. Standard on terrace doors, optional for entrance doors. (WML)

ALDUS® Section Drawings 1:5

Outward Opening Doors

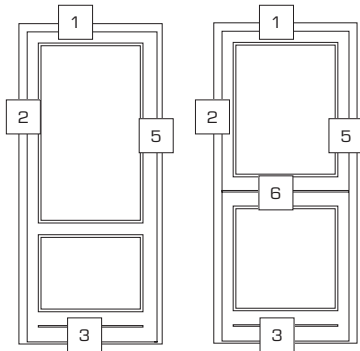

Type B31.00
B31.50
B32.11
B32.12

Type B33.00

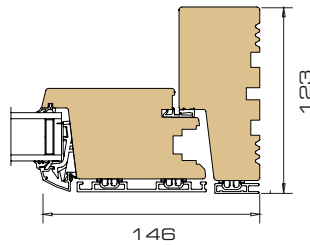

5 Horizontal section locking side

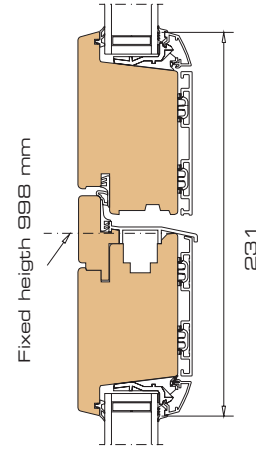

6 Vertical section rebated sashes

Inward Opening Doors

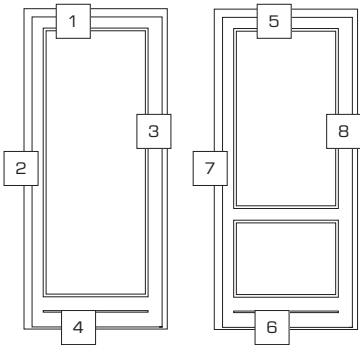

Type B34.00
B35.00

Type B31.00
B32.11
B32.12

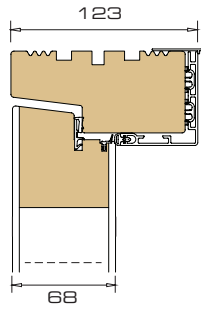

1 Vertical section head / door plate

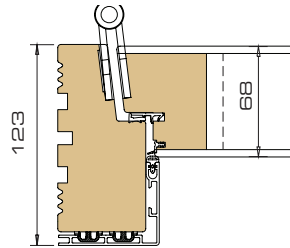

2 Horizontal section hinge side

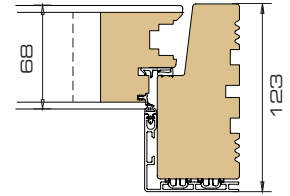

3 Horizontal section locking side

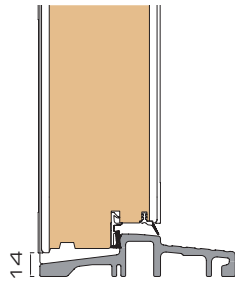

4 Vertical section sill / door plate

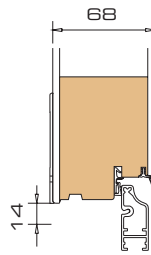

4 Vertical section bottom rail / door plate

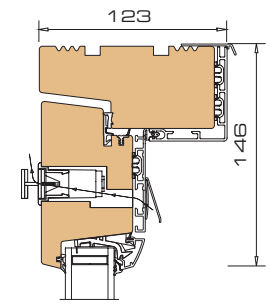

5 Vertical section head / -sash with vent

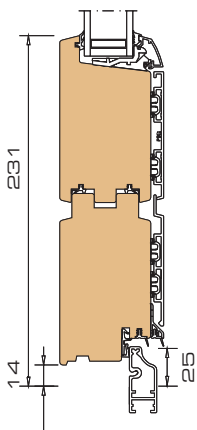

6 Vertical section bottom rail / -sash

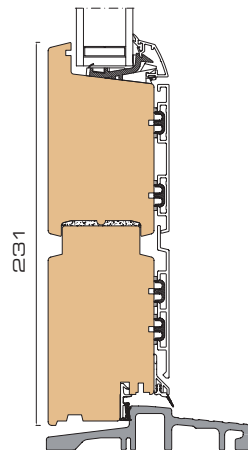

6 Vertical section sill / -sash

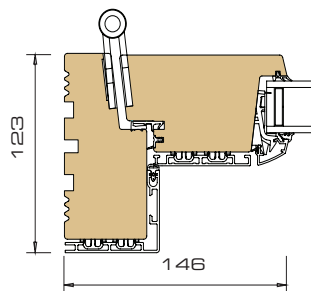

7 Horizontal section hinge side

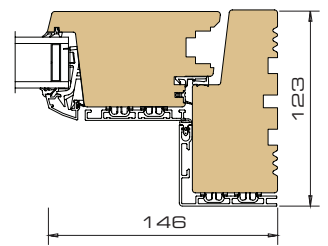

8 Horizontal section locking side

ALDUS® Section Drawings 1:5

Tilt & Turn Doors

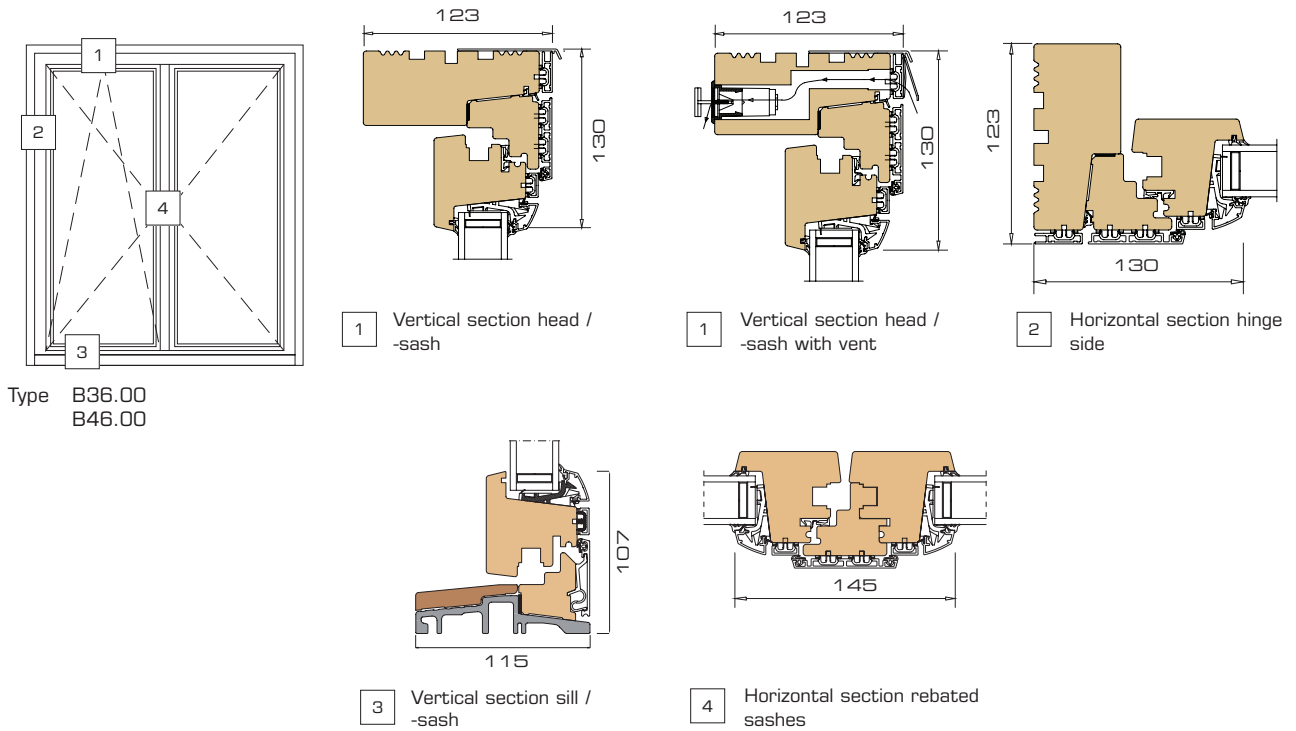

Type B36.00
B46.00

Sliding Patio Doors

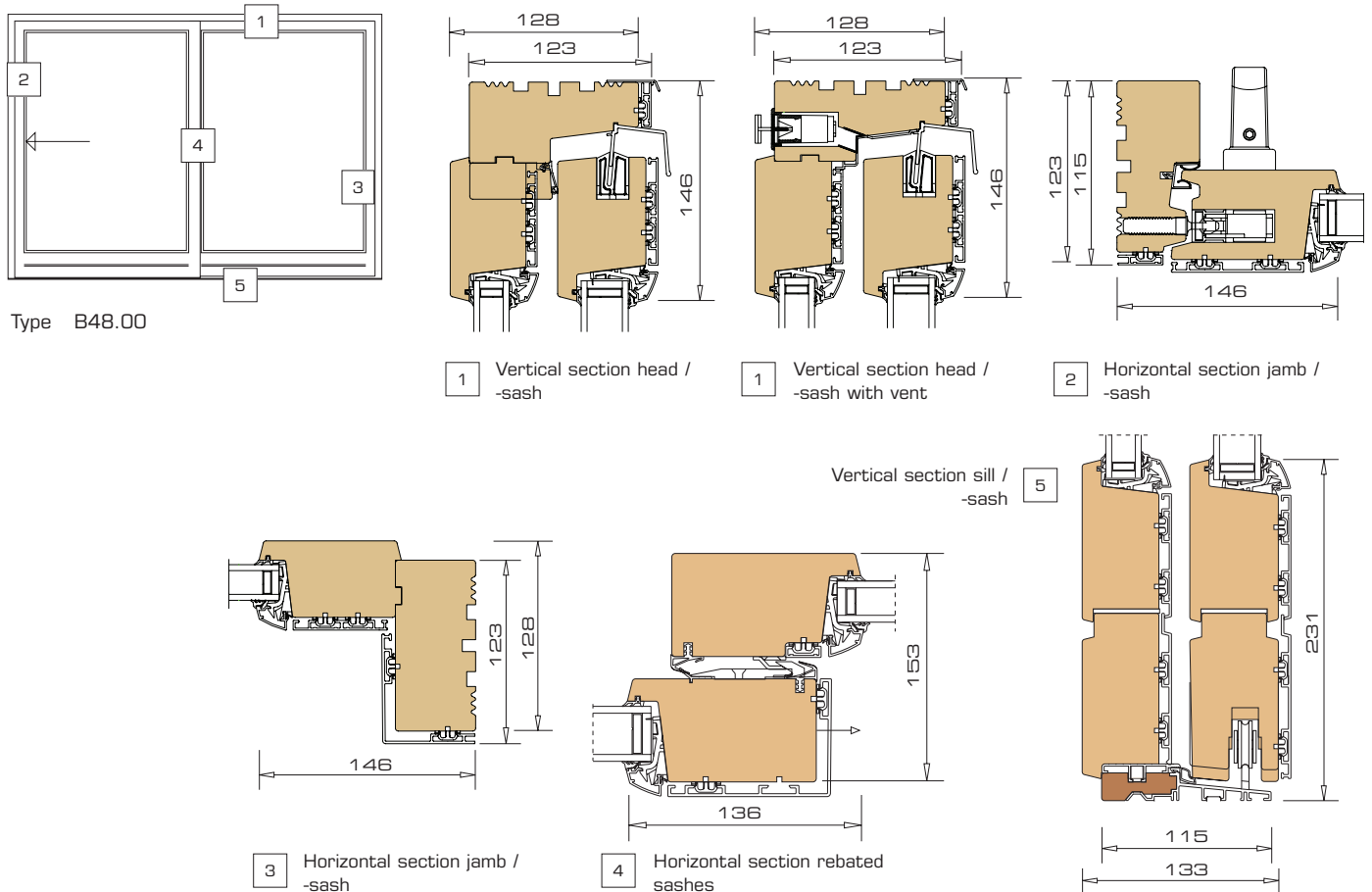

Type B48.00

ALDUS® Section Drawings 1:5

Glazing Bars / Rails

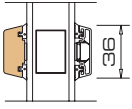

Vertical section 36 mm bonded glazing bar

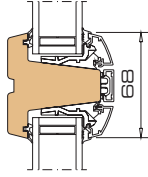

Vertical section 68 mm glazing bar

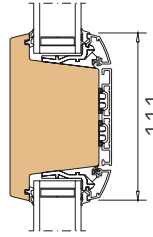

Vertical section 111 mm rail

Ventilated Panels

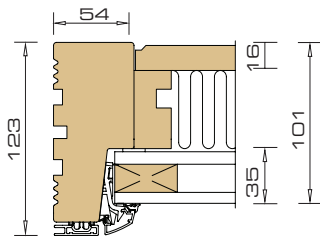

Horizontal section jamb

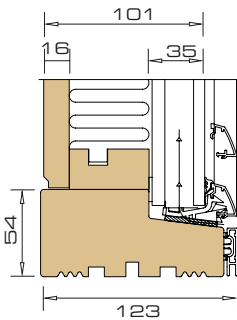

Vertical section sill

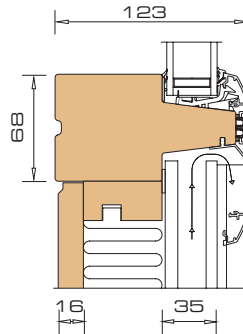

Vertical section transom

ALDUS / PATUS+ Section Drawings 1:5

Insulated Panels

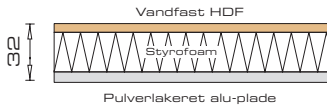

Smooth timber/aluminium panel

PATUS® Section Drawings 1:5

Glazing Bars / Rails

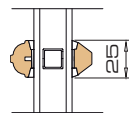

Vertical section 25 mm bonded glazing bar

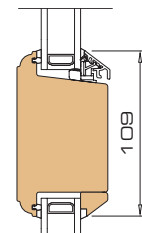

Vertical section 109 mm rail

PATUS+® Section Drawings 1:5

Glazing Bars / Rails

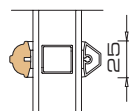

Vertical section 25 mm bonded glazing bar

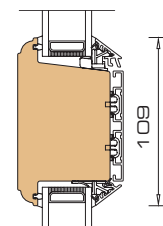

Vertical section 109 mm rail

PATUS® Section Drawings 1:5

Outward Opening Windows

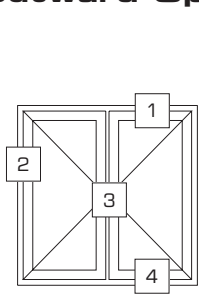

Type Z23.00

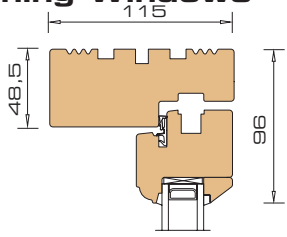

1 Vertical section head / -sash

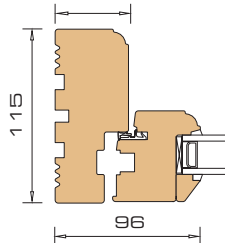

2 Horizontal section jamb / -sash

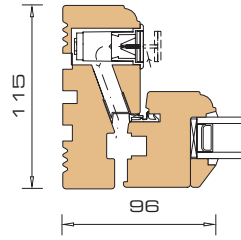

2 Horizontal section jamb / -sash with vent

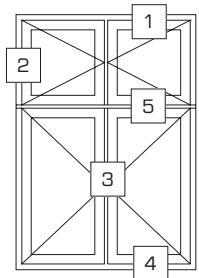

Type Z23.01

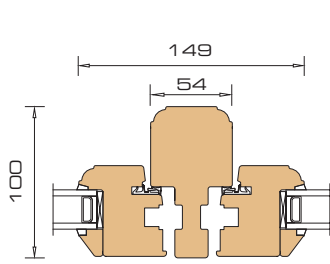

3 Horizontal section mullion / -sashes

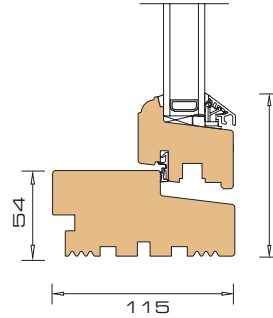

4 Vertical section sill / -sash

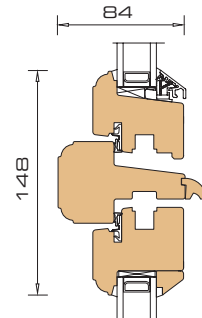

5 Vertical section transom / sashes

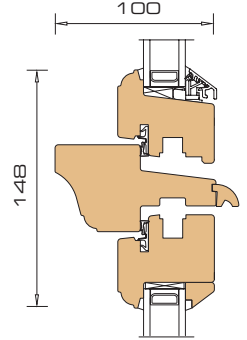

Terrace Doors / Entrance Doors

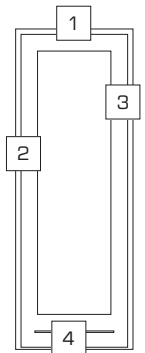

Type Z31.00
Z31.50
Z32.00

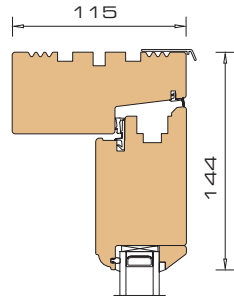

1 Vertical section head / -sash

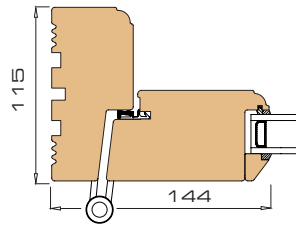

2 Horizontal section hinge side

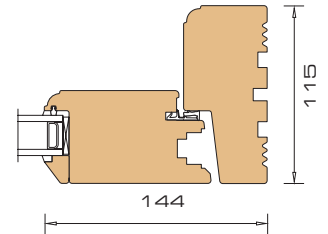

3 Horizontal section locking side

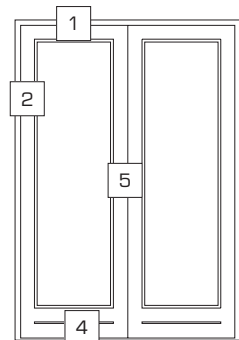

Type Z41.00
Z41.50

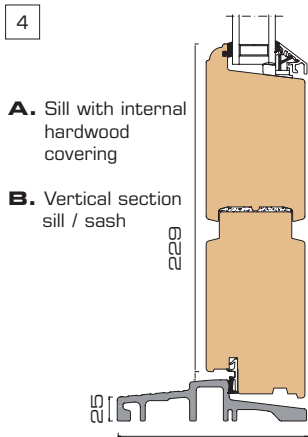

A. Sill with internal hardwood covering
B. Vertical section sill / sash

(outward opening)

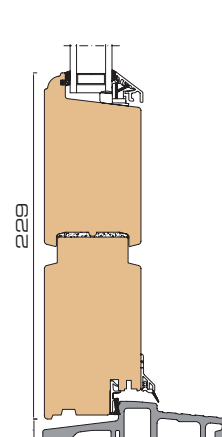

(inward opening)

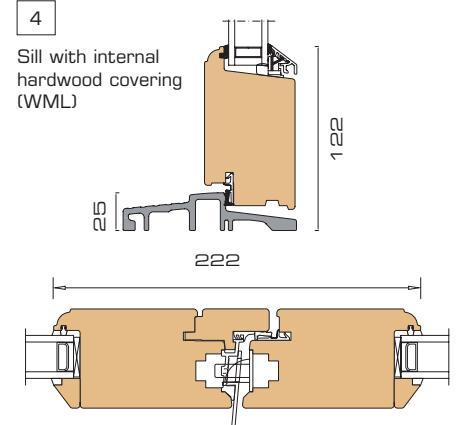

5 Horizontal section rebated sashes

PATUS+® Section Drawings 1:5

Outward Opening Windows

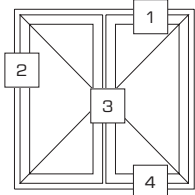

Type S23.00

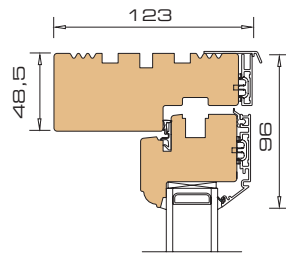

1 Vertical section head / -sash

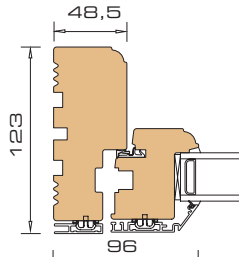

2 Horizontal section jamb / -sash

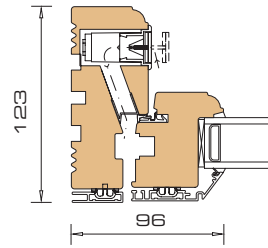

2 Horizontal section jamb / -sash with vent

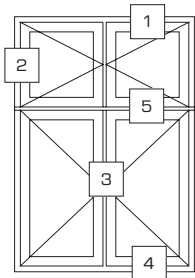

Type S23.01

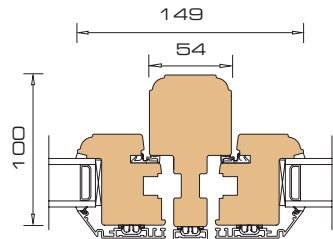

3 Horizontal section mullion / -sash

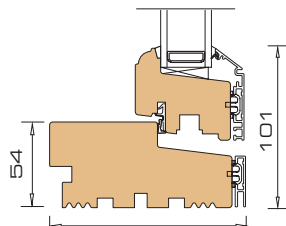

4 Vertical section sill / -sash

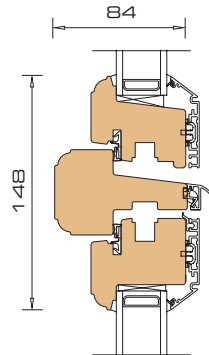

5 Vertical section transom / sashes

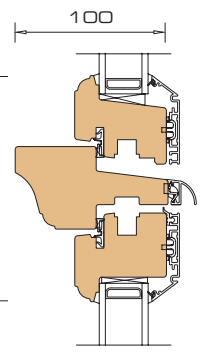

Terrace Doors / Entrance Doors

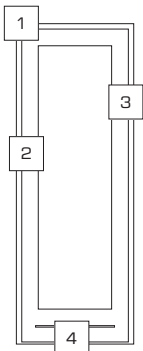

Type S31.00
S31.50
S32.00

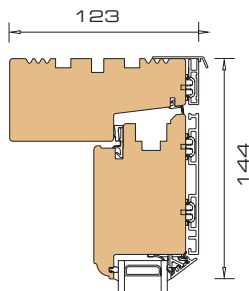

1 Vertical section head / -sash

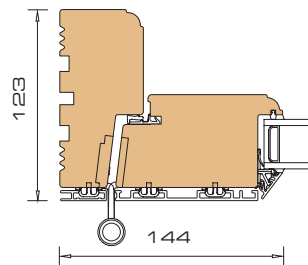

2 Horizontal section hinge side

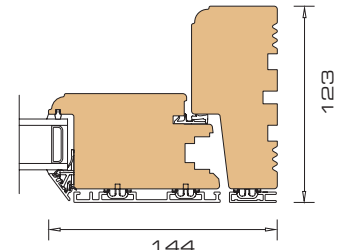

3 Horizontal section locking side

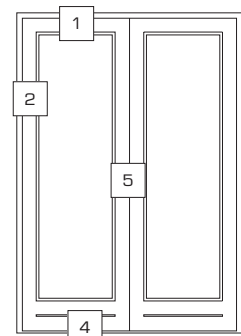

Type S41.00
S41.50

4
A. Sill with internal hardwood covering
B. Vertical section sill / sash

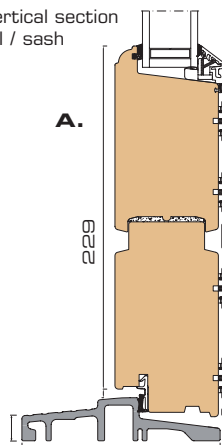

(outward opening)

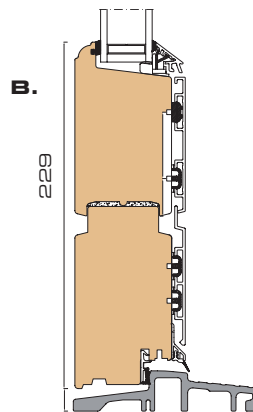

(inward opening)

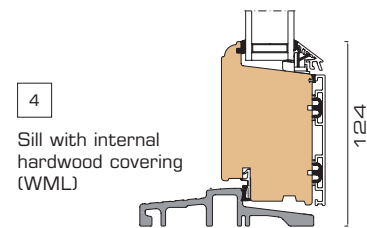

4
Sill with internal hardwood covering (WML)

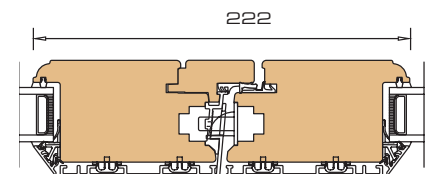

5 Horizontal section rebated sashes

DOMUS® / PATUS® Section Drawings 1:5

Corner Posts

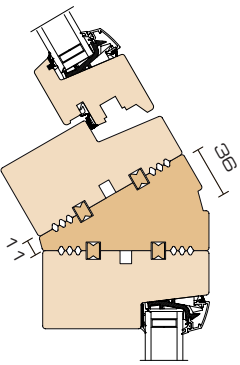

30° corner post

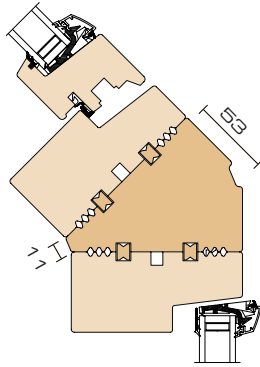

45° corner post

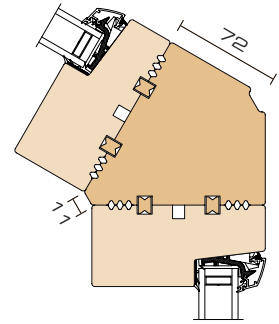

60° corner post

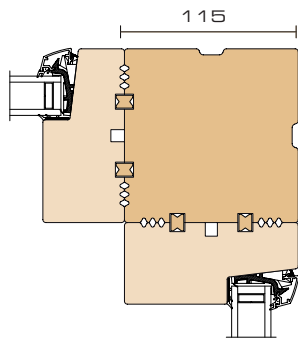

90° corner post

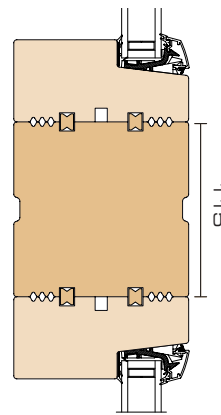

180° linking post

ALDUS® / PATUS+® Section Drawings 1:5

Corner Posts

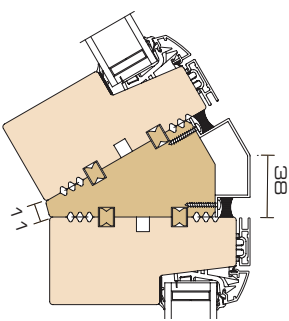

30° Corner post

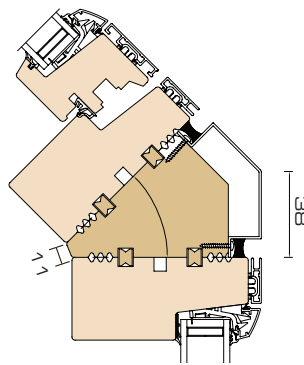

45° corner post

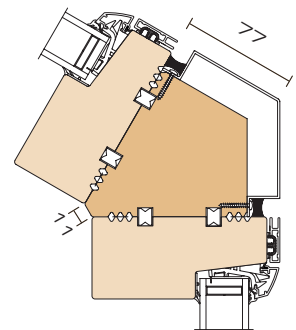

60° corner post

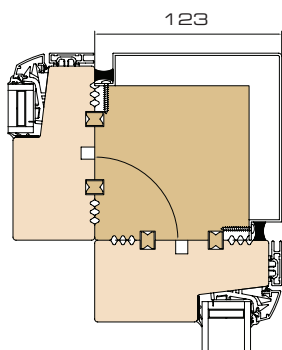

90° corner post

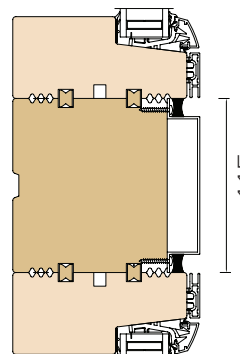

180° linking post

DOMUS® / PATUS® Section Drawings 1:5

Linking Strips and Packing Plankes

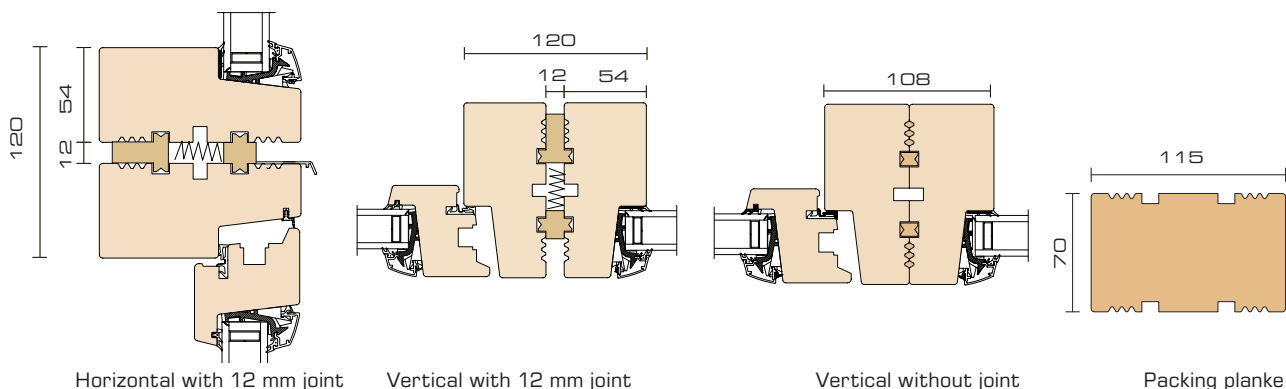

Horizontal with 12 mm joint

Vertical with 12 mm joint

Vertical without joint

Packing plankes

ALDUS® / PATUS+® Section Drawings 1:5

Linking Strips and Packing Plankes

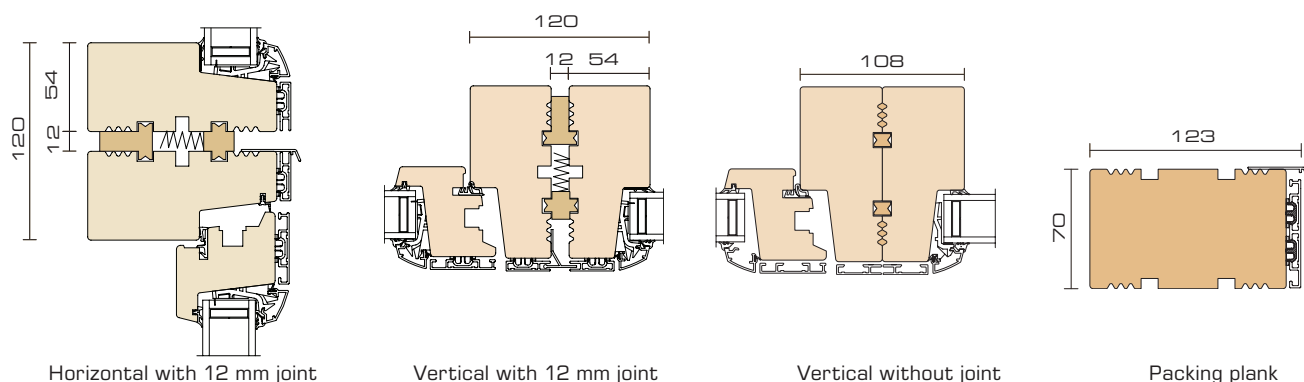

Horizontal with 12 mm joint

Vertical with 12 mm joint

Vertical without joint

Packing plank

12 mm joint distance is recommended at all horizontal assemblies.
 A steam open joint is recommended for all external assemblies.
 A watertight joint is recommended for internal assemblies.
 All linking strips must be ordered separately.

GROOVES Section Drawings 1:5

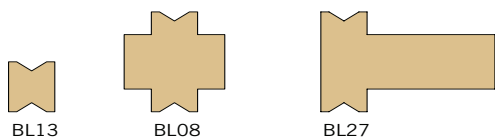

Grooves for ALDUS, DOMUS, PATUS, PATUS+,

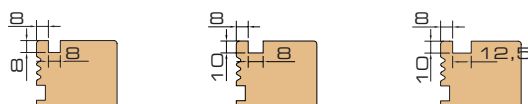

Grooves for ALDUS, DOMUS

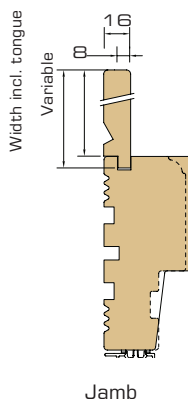
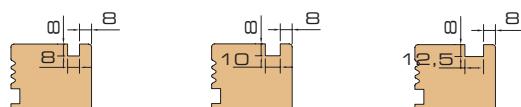

Jamb

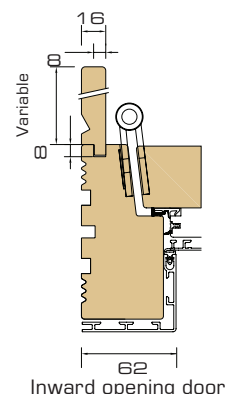

Inward opening door

03.12.03.12 © 2012 Rationel Vinduer A/S ® rational and rational logo, SECURITY, DOMUS, ALDUS, PATUS, PATUS+, logos are registered trademarks used under licence by Rationel Vinduer A/S. Rationel is not responsible for misprints and reserves the right to make technical changes.

Good, solid quality workmanship has characterised Rationel's windows and doors since the first products were shipped from our factory in Sdr. Felding in 1954. On that basis, Rationel has created a sound foundation, and is today an international company with sales activities in Denmark, Great Britain and Ireland.

Rationel manufactures energy saving windows and doors of premium quality in terms of comfort and security. We develop our windows and doors continuously, ensuring that they will always meet current statutory requirements as well as market requirements for design and functionality.

For further information about our wide range of windows and doors, for classic and modern buildings, please visit www.rationel.ie

Rationel is part of the DOVISTA Group which consists of nine leading door and window companies in Europe. DOVISTA A/S is owned by VKR Holding and employs approx. 15,000 people in more than 40 countries.

Rationel Vinduer Ltd
 2 Bridgecourt Office Park
 Walkinstown Avenue
 Dublin 12

Phone: 01 4092900
 Fax: 01 4501002
www.rationel.ie

