

flexiform

OLIO DESK
& STORAGE
SPECIFICATION GUIDE



Tea to talk

olio

Let your imagination go wild with Olio desk and storage range. Available with 3 tiers of storage, single, side-to-side and back-to-back desks.

Specifying Olio

Olio is a fully integrated desking and storage system, combining desks and various storage options into one product. Olio features shared components, multiple configurations and an innovative cable management system.

For guidance on specifying Olio see the examples on page 6-13

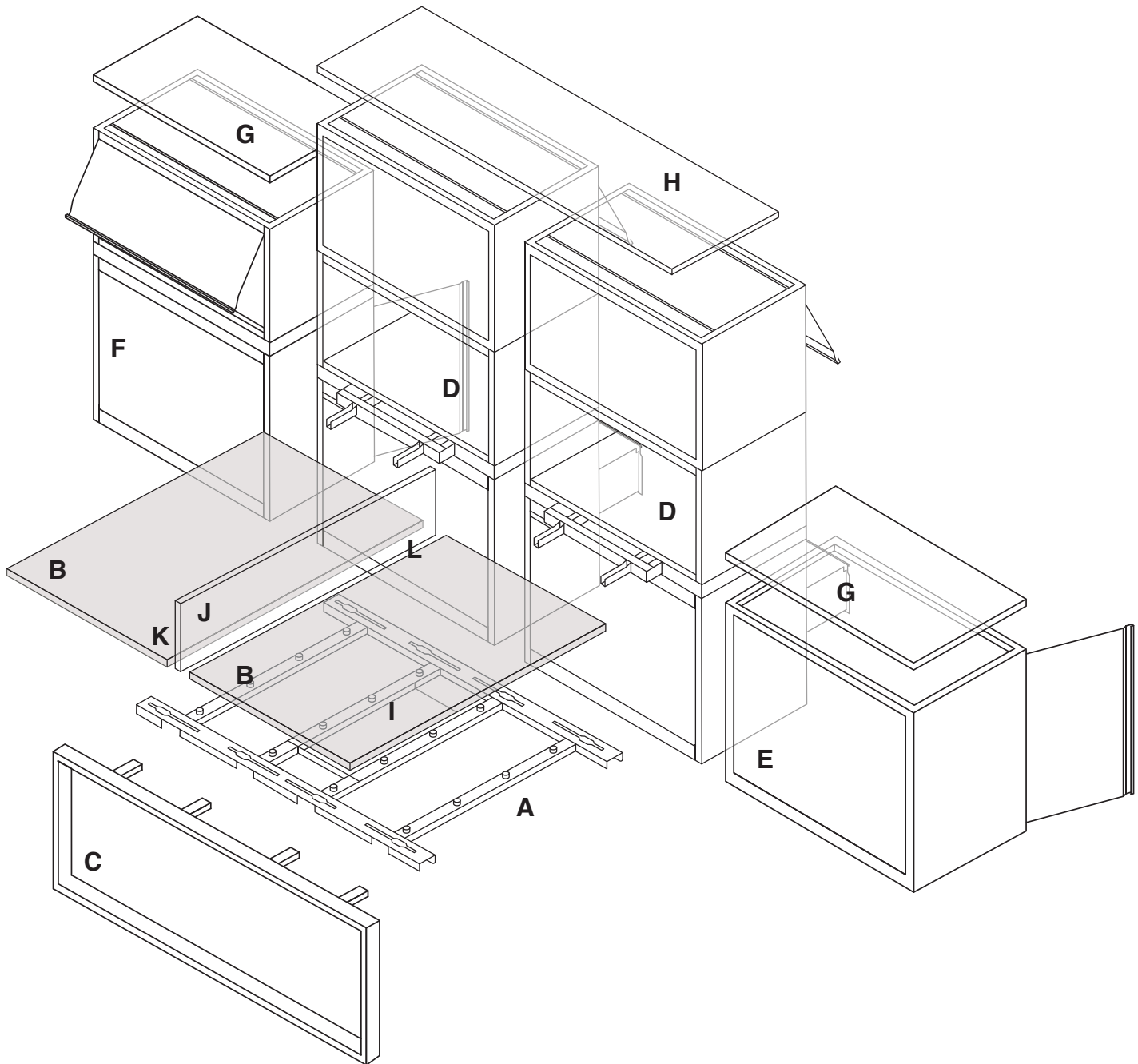

- A. 1x 1600mm sliding desk frame.
- B. 2x 775mm x 1600mm desk top.
- C. 1x Universal rectangular loop leg.
- D. 2x Desk connecting level 3 storage with pass through outwards facing flipper and drawers.
- E. 1x Freestanding level 1 hinged door unit.
- F. 1x Freestanding level 2 hinged door unit with desk facing flipper.

- G. 2x MFC 800mm single unit storage tops.
- H. 1x MFC 1600mm flyover storage tops.
- I. 1x back-to-back cable tray.
- J. 1x 1600mm desk mounted screen.
- K. 2x Screen end strips.
- L. 1x Screen post set.

Olio is built up from many parts, the following parts are required for the illustrated configuration.
 For help with specifying Olio please contact Flexiform on 01274 706206.

PARTS & ORDERING

DIAGRAM REF.	CODE	DESCRIPTION	QTY
A	OBB1616 ***	1600mm sliding desk frame	1
B	OTOP16X775 ***	775mm x 1600mm desk top	2
C	ORLEG16 ***	Universal rectangular Loop Leg	1
D	OL308S01 *** ** *	Desk connecting level 3 storage with pass through, outwards facing flipper and drawers	2
E	OL108S02X ***	Freestanding level 1 hinged door unit	1
F	OL208S05X *** ** *	Freestanding level 2 hinged door unit with desk facing flipper	1
G	OTPM475X800 ***	MFC 800mm single unit storage tops	2
H	OTPM475X1600 ***	MFC 1600mm flyover storage tops	1
I	PBBTRAY1600 ***	Back-to-back cable tray	1
J	SPB Required	1600mm desk mounted screen	1
K	JSCRENDCLR405	Screen end strips	2
L	JSCRDSBKT30JOS	Screen post set	1

CABLE MANAGEMENT - FEED OPTIONS

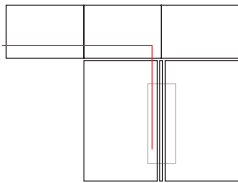

A. Power and data is fed from the walls through 33mm diameter “knock out” holes in the cabinets into cable trays – (rubber grommets supplied).

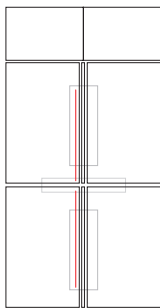

B. Power and data is fed up through central cable tower and into the underdesk cable trays.

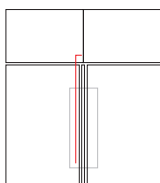

C. Power and data is fed up through the storage cabinets and into the underdesk cable trays

Popular single & side to-side configurations



A.	OTPM475X800 ***	MFC flyover top 475mm x 800mm front to back grain	x1
B.	OL208S08 *** **	Level 2 open unit and desk facing flipper	x1
C.	OTOP16X800 ***	Desktop 1600mm x 800mm x 25mm MFC	x1
D.	OSS1608 ***	1600mm single frame*	x1
E.	OGLEG08RH ***	800mm goalpost leg right handed**	x1
F.	PSTRAY1600 ***	Single cable tray	x1

Optional Extras: screen (x1), screen end strips (x2), modesty panel (x1)

* If a screen is to be added, order OSS16PUNI***

** Make sure you specify correct leg

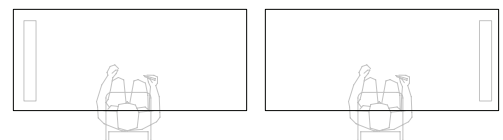

LH Leg

RH Leg

Side-to-side Desk

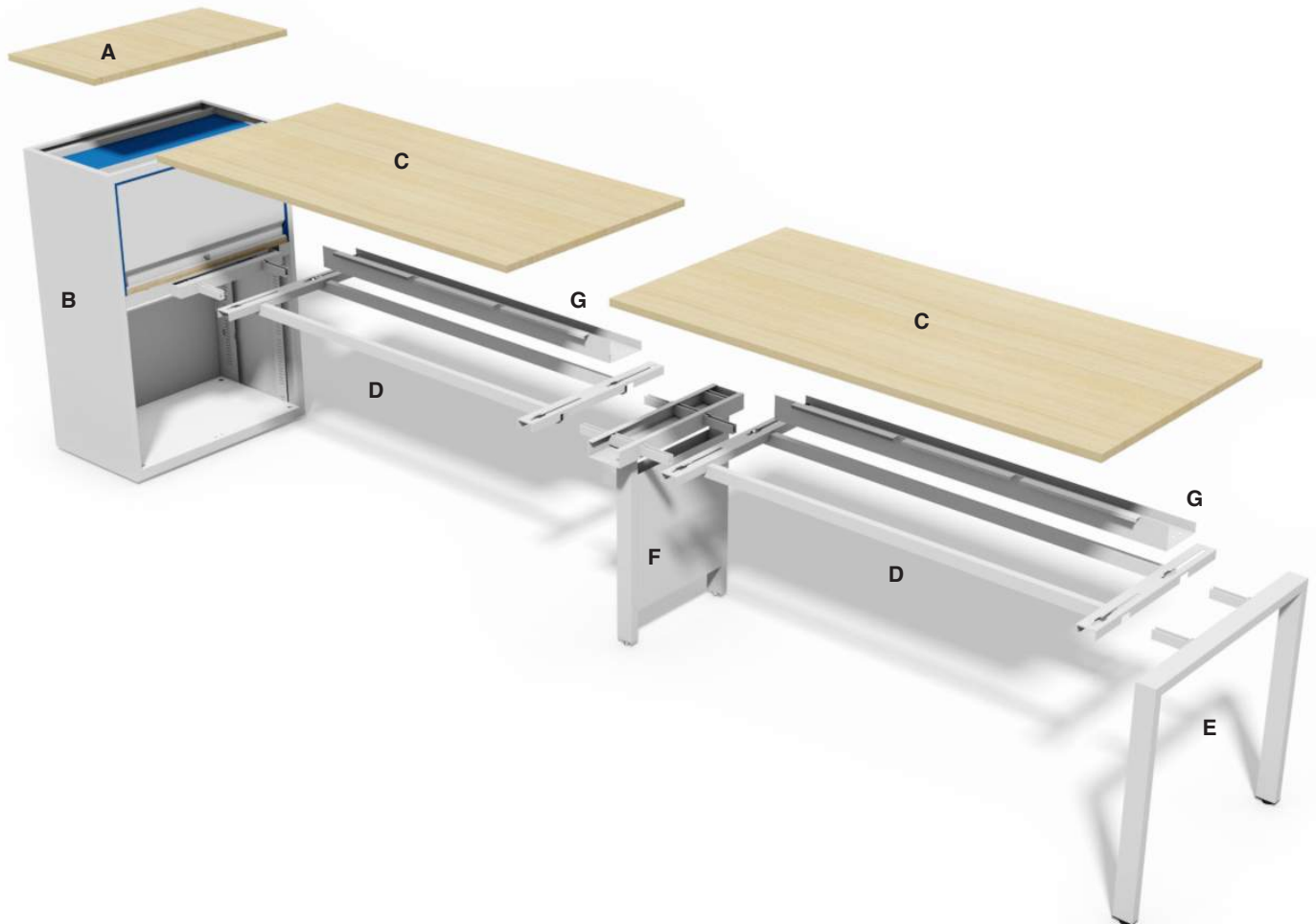

A.	OTPM475X800 ***	MFC flyover top 475mm x 800mm front to back grain	x1
B.	OL208S08 *** **	Level 2 open unit and desk facing flipper	x1
C.	OTOP16X800 ***	Desktop 1600mm x 800mm x 25mm MFC	x2
D.	OSS1608 ***	1600mm side-to-side frame with slide rails*	x2
E.	OGLEG08RH ***	800mm goalpost leg right handed**	x1
F.	OTWR08 ***	800mm tower	x1
G.	PSTRAY1600 ***	Single cable tray	x2

Optional Extras: screens (x2), screen fittings (top link (x1), bottom link (x1), end strips (x2), modesty panel (x2)

* If a screen is to be added, order OSS16PUNI***

** Make sure you specify correct leg

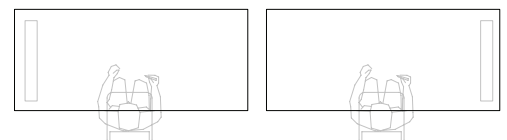

LH Leg

RH Leg

Popular back-to-back configurations

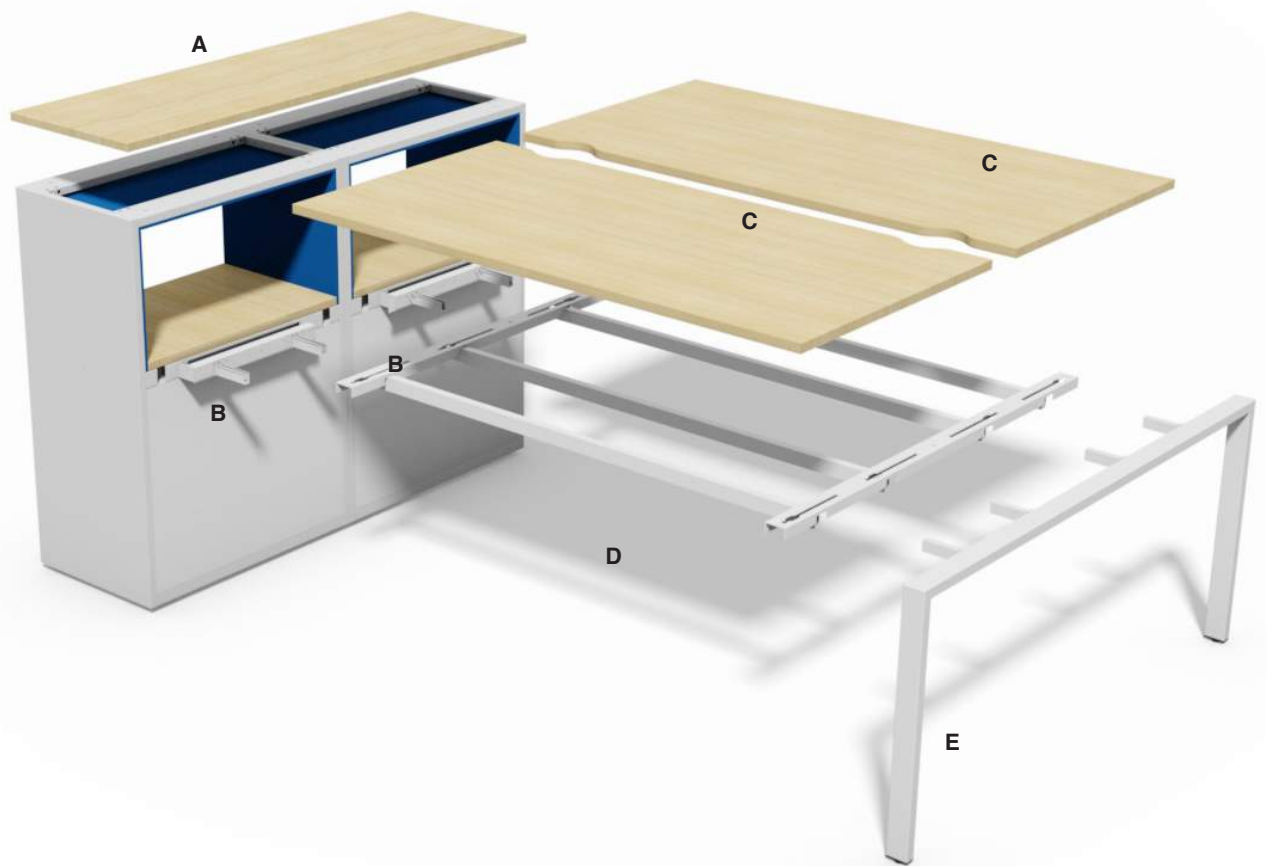

A.	OTPM475X1600 ***	MFC flyover top 475mm x 1600mm front to back grain	x1
B.	OL208S06 *** ** *	Level 2 door unit with desk facing box	x2
C.	OTOP16X800SCOOP ***	Desktop 1600mm x 800mm x 25mm MFC *	x2
D.	OBB1616 ***	1600mm back-to-back frame with slide rails	x2
E.	OGLEG16 ***	1600mm goalpost leg	x1

Optional Extras: cable tray (x1), screens (x1), screen end strips (x2), screen posts (x1)

* If a screen is to be added, order OTOP16X775 ***

Back-to-back Desks

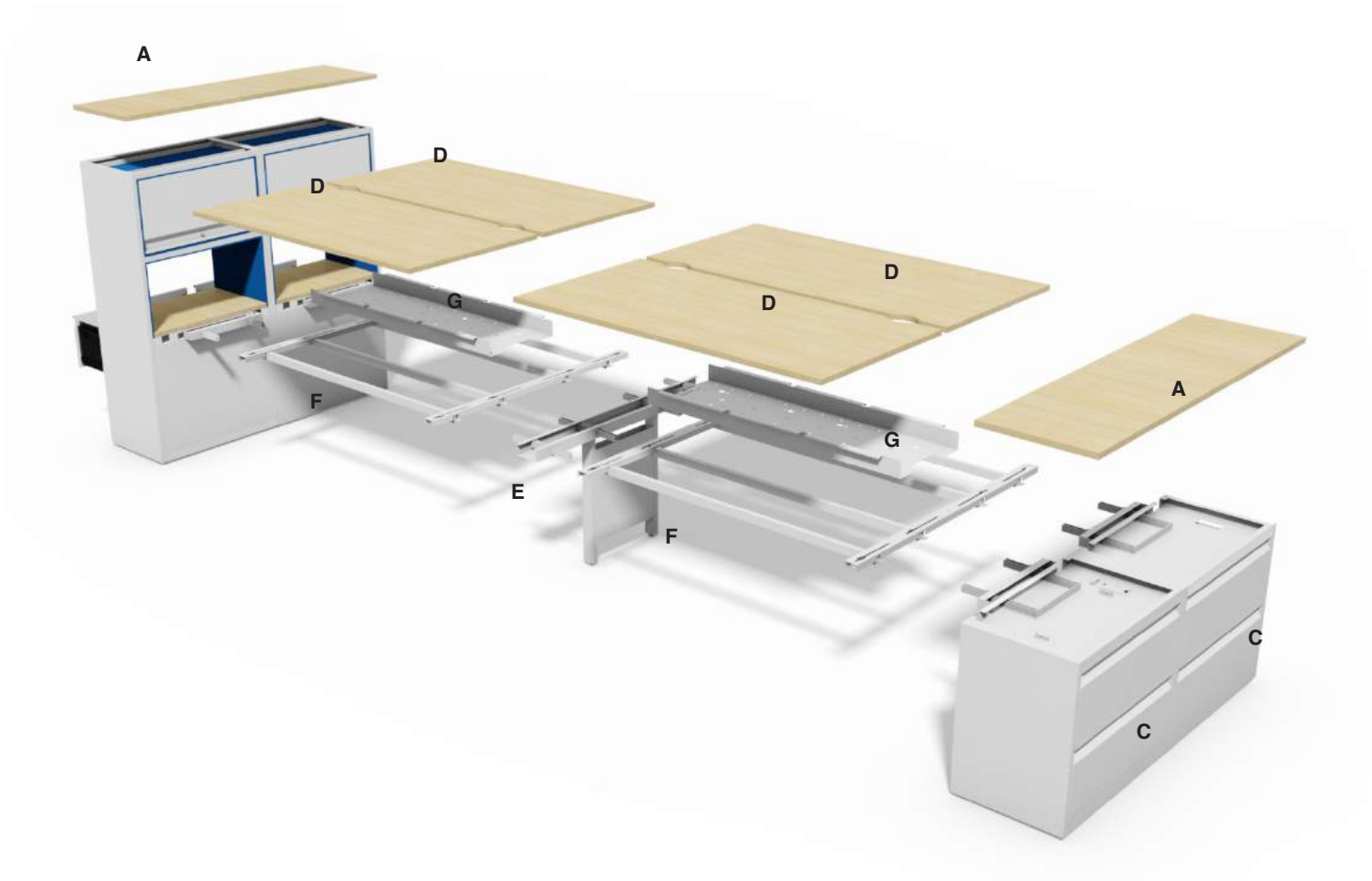

A.	OTPM475X1600 ***	MFC flyover top 475mm x 1600mm front to back grain	x2
B.	OL308S02 *** **	Level 3 drawer unit with pass through and desk facing flipper	x2
C.	OL108S01 ***	Level 1, 2 drawer lateral unit	x2
D.	OTOP16X800SCOOP ***	Desktop 1600mm x 800mm x 25mm MFC*	x4
E.	OTWR16 ***	1600mm tower and rail	x1
F.	OBB1616 ***	1600mm back-to-back frame with slide rails	x2
G.	PBBTRAY1600***	Back-to-back cable tray	x2

Optional Extras: screens (x2), screen fittings (top link (x1), bottom link (x1), end strips (x2), screen posts (x2)

* If a screen is to be added, order OTOP16X775 ***

Olio Configurations

Configuration 1

Against a wall. Plan view and side view.

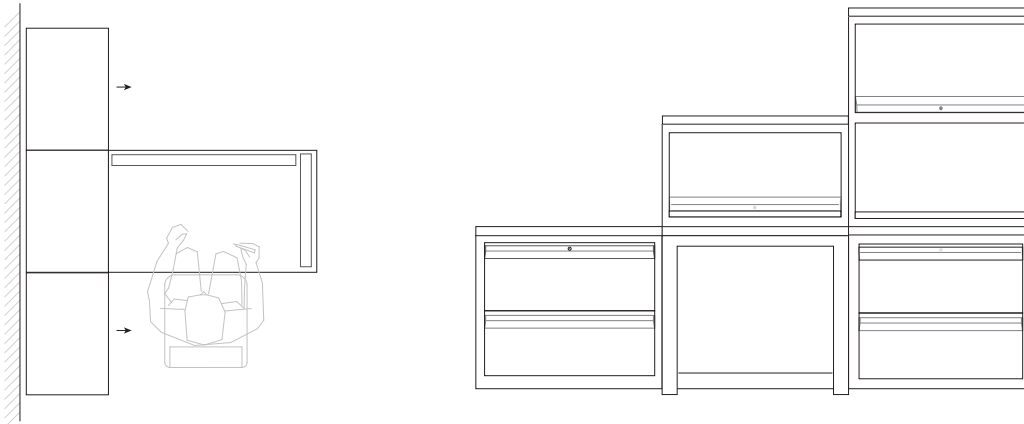

OSS1608 ***	1600mm side-to-side sliding frame	x1
OTOP16X800 ***	Desktop 1600mm x 800mm x 25mm (WxDxH)	x1
JMOD1600 *** P	1600mm modesty panel	x1
OGLEG08RH ***	800mm right hand single leg	x1
PSTRAY1600 ***	1600mm side-to-side cable tray	x1
OL108S01X ***	Level 1, 2 drawer lateral filer	x1
OL208S08 *** ** *	Level 2 open unit and flipper	x1
OL308S01X *** ** *	Level 3, 2 drawer lateral with pass through and flipper	x1
OTPM475X800 ***	MFC top with grain running front to back	x3
FSTORBAL08	Counterbalance weight	x2

Configuration 2

Plan view and side view.

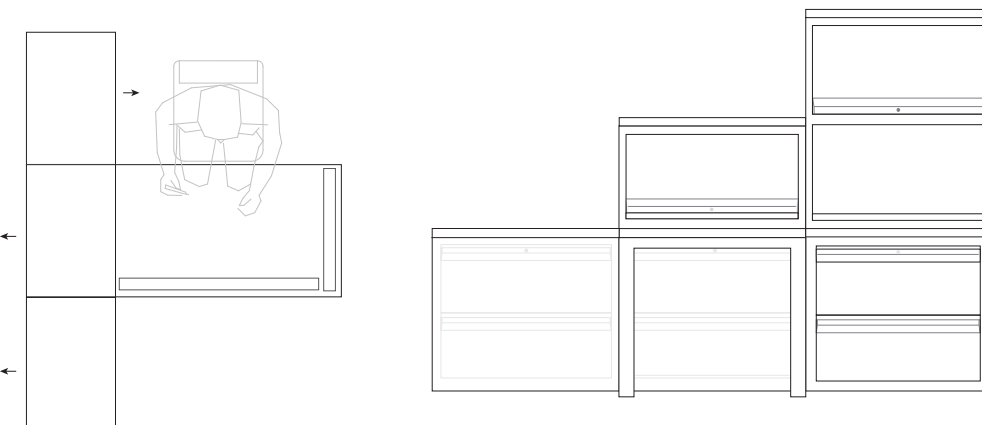

OSS1608 ***	1600mm side-to-side sliding frame	x1
OTOP16X800 ***	Desktop 1600mm x 800mm x 25mm (WxDxH)	x1
JMOD1600 *** P	1600mm modesty panel	x1
OGLEG08LH ***	800mm left hand single leg	x1
PSTRAY1600 ***	1600mm side-to-side cable tray	x1
OL108S01X ***	Level 1, 2 drawer lateral filer	x1
OL208S02 *** ** *	Level 2, 2 drawer and flipper	x1
OL308S01X *** ** *	Level 3, 2 drawer lateral with pass through and flipper	x1
OTPM475X800 ***	MFC top with grain running front to back	x3
FSTORBAL08	Counterbalance weight	x2

Configuration 3

Plan view and side view.

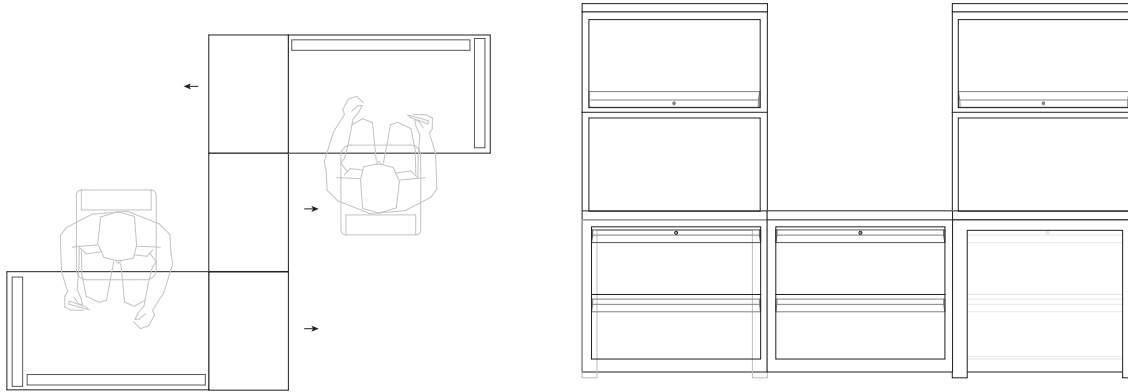

OSS1608 ***	1600mm side-to-side sliding frame	x2
OTOP16X800 ***	Desktop 1600mm x 800mm x 25mm (WxDxH)	x2
JMOD1600 *** P	1600mm modesty panel	x2
OGLEG08RH ***	800mm right hand single leg	x2
PSTRAY1600 ***	1600mm side-to-side cable tray	x2
OL108S01X ***	Level 1, 2 drawer lateral filer	x1
OL308S02 *** **	Level 3, 2 drawer lateral with pass through and flipper	x2
OTPM475X800 ***	MFC top with grain running front to back	x3
FSTORBAL08	Counterbalance weight	x1

Configuration 4

Plan view and side view.

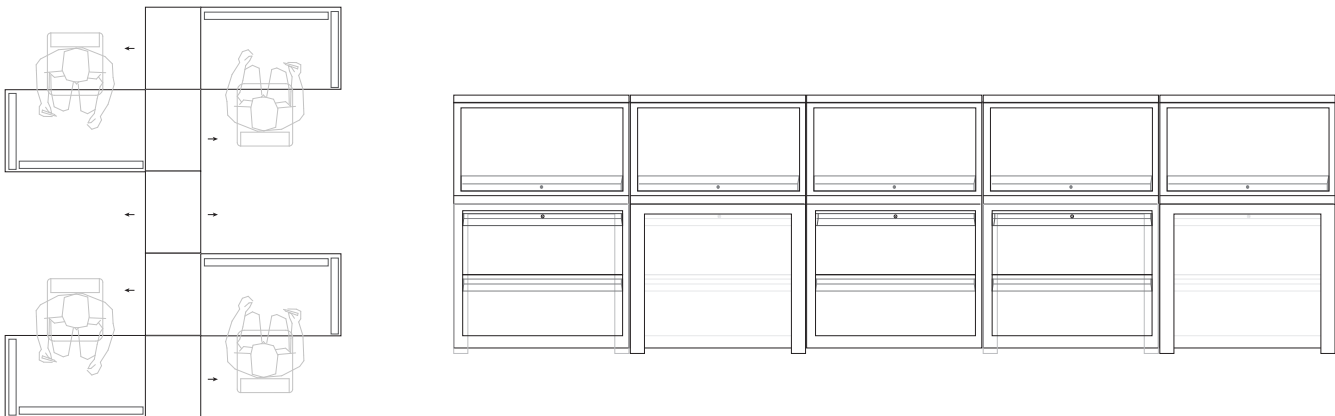

OSS1608 ***	1600mm side-to-side sliding frame	x4
OTOP16X800 ***	Desktop 1600mm x 800mm x 25mm (WxDxH)	x4
JMOD1600 *** P	1600mm modesty panel	x4
OGLEG08RH ***	800mm right hand single leg	x4
PSTRAY1600 ***	1600mm side-to-side cable tray	x4
OL208S02 *** **	Level 2, 2 drawer filer with flipper	x4
OL208S02X *** **	Freestanding Level 2 2 drawer filer with flipper	x1
OTPM475X1600 ***	Flyover MFC top with grain running front to back	x2
OTPM475X800 ***	MFC top with grain running front to back	x1
FSTORBAL08	Counterbalance weight	x1

Olio Configurations

Configuration 5

Plan view and side view.

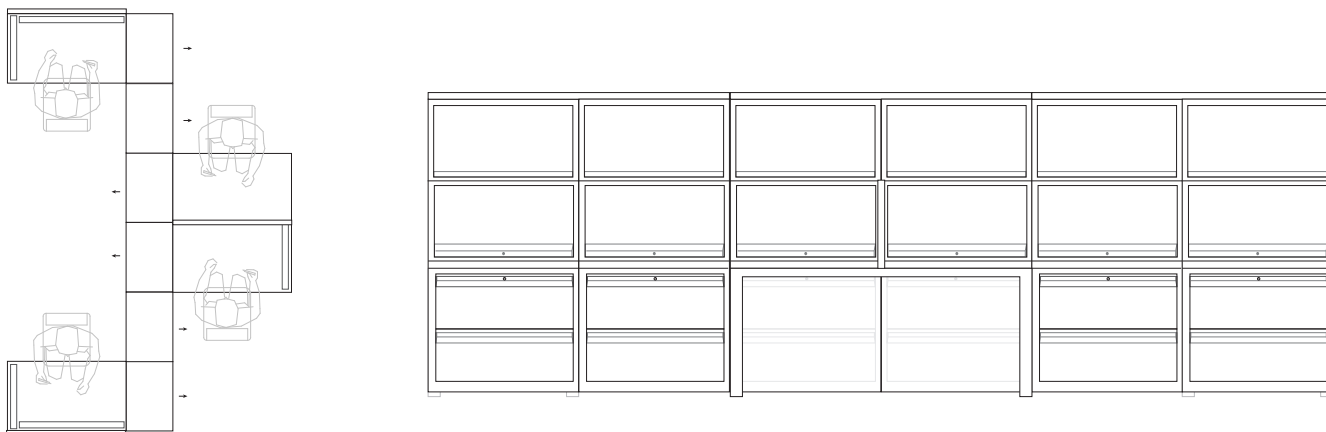

OBB1616 ***	1600mm back-to-back side frame	x1
OSS1608PUNI ***	1600mm side-to-side frame with PUNI rail	x2
OGLEG16 ***	1600mm universal goalpost leg	x1
OTOP16X775 ***	Desktop 1600mm x 775mm x 25mm (WxDxH)	x2
TOP16X80 ***	Desktop 1600mm x 800mm x 25mm (WxDxH)	x2
OGLEG08RH ***	800mm RH single leg	x1
OGLEG08LH ***	800mm LH single leg	x1
PBBTRAY1600 ***	1600mm back-to-back cable tray	x1
PSTRAY1600 ***	1600mm side-to-side cable tray	x1
JSCRDSBKT30	Screen posts	x3
JSCRENCVVR405	Screen end cover	x3
OL308S06 ***	Level 3, 2 drawer with flipper and pass through	x4
SPB SCREEN	1600mm screen	x3
OTPM475X1600 ***	Flyover top with grain running from front to back	x2
FSTORBAL08	Counterbalance weights	x2
OL308S06X ***	Freestanding level 3, 2 drawer with flipper and pass through	x2
JMOD1600 *** P	Modesty panels	x2

Configuration 6

Plan view and side view.

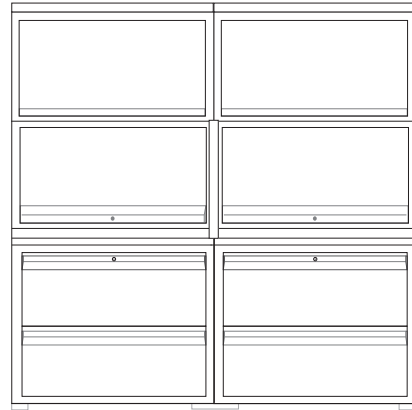
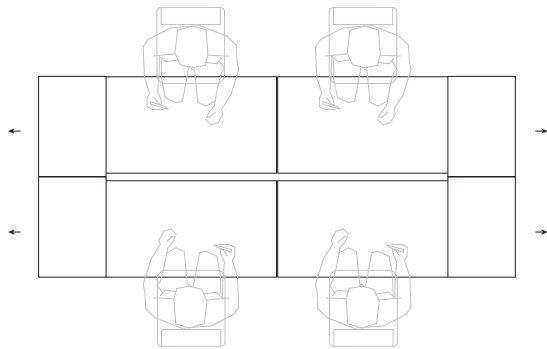

OBB1616 ***	1600mm back-to-back slide frame	x2
OTOP16X775 ***	Desktop 1600mm x 775mm x 25mm (WxDxH)	x4
OTWR16 ***	1600mm tower and rail	x1
SPB SCREEN	1600mm screen	x2
JSCRDSBKT30	Screen posts	x2
JSCREDCVR405	Screen end strips	x1
JSCR TL	Screen top link	x1
JSCR BL	Screen bottom link	x1
PBBTRAY1600 ***	1600mm back-to-back cable tray	x2
OL108S01 ***	Level 1, 2 drawer storage	x2
OL308S06 *** **	Level 3, 2 drawer with flipper and pass through	x2
OTPM475X1600 ***	MFC flyover top with front to back grain	x2

Olio Checklist

<input type="checkbox"/> Frame (s)	<input type="checkbox"/> Cable trays	<input type="checkbox"/> Storage	<input type="checkbox"/> Screen end strips
<input type="checkbox"/> Leg (s)	<input type="checkbox"/> Modesty panel	<input type="checkbox"/> Screen	<input type="checkbox"/> Screen top & bottom links
<input type="checkbox"/> Cable tower	<input type="checkbox"/> Desk tops	<input type="checkbox"/> Storage tops	<input type="checkbox"/> Screen post
<input type="checkbox"/> Counterbalance weight			

Olio QuickGuide

SELECT DESK TOP

Rectangular or a scoop top. The choice of top will change depending upon choice of underframe.

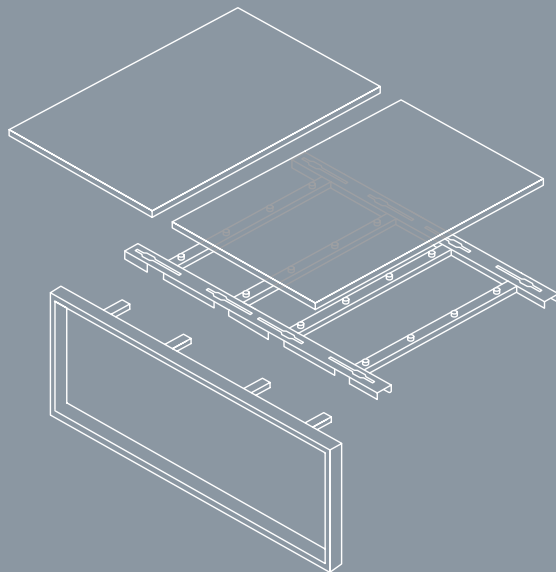
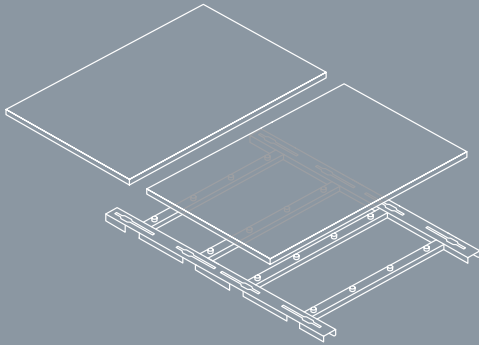

SELECT DESK FRAME(S)

The type of underframe will vary depending on the inclusion of desk mounted screens.

- If a screen is required on a single sided desk select a frame with PUNI rail. See page 19.
- Choose appropriate cable tower to link desks. See page 19.
- Choice of desks: Single desk, side-to-side desk or back-to-back desk See page 18 and 19.

DECISIONS TIME

- Storage. The desk is supported on storage units only.
- Storage and legs. The desk is supported by storage and legs.
- Storage can be included on either one side or both sides of the desk.

PLANNING CABLE MANAGEMENT

Choose a cable feed option: wall, cable tower, or up through the storage unit.

- Cables can be clamped and segregated via plastic holders inside cabinet.
- Cabinets are supplied with vertical cable tidy within lower part of carcass.
- Cable entry/exit is suitable for Wieland connectors only.
- Desk cable trays are at same height as cabinet cable tray allowing for easy cable routing.

STORAGE

Storage is available in 3 levels with various storage options – flipper, open, drawer, hinged door or tambour. One connecting unit is required per end of single or side-to-side desks. Two connecting units are required per end of a back-to-back desk configuration. (A) Freestanding units are available to extend the storage (B).

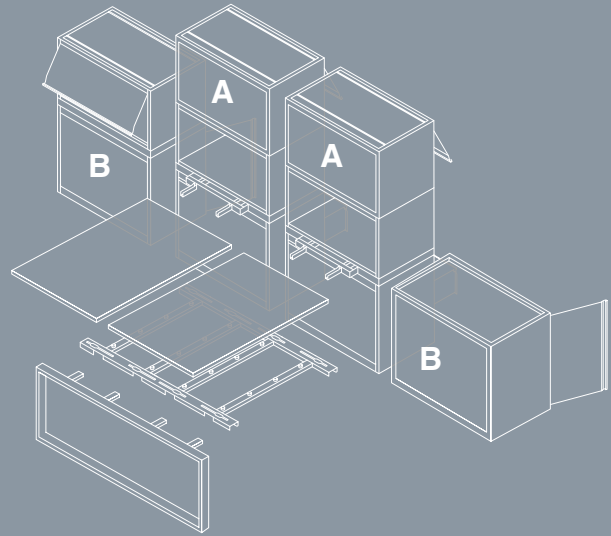

STORAGE & LEGS

If storage is desired on only one side, legs must be specified on the opposite side (as shown on diagram).

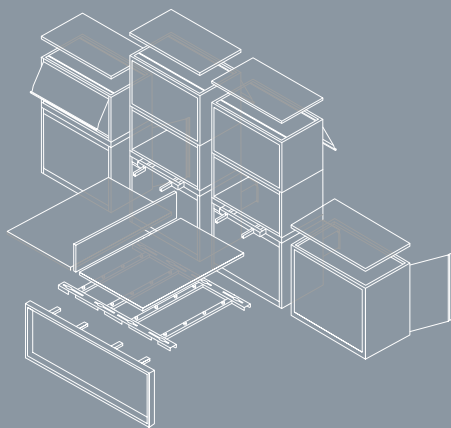

SCREENS, TOPS & CABLE TRAYS

Storage is not supplied with MFC tops. Tops must be specified separately. Flyover MFC tops are available to cover multiple units.

OLIO DESK TOPS



Pictured Right: Back-to-back worktops in oak MFC.
OTOP14X800SCOOPMOK (X2)

HOW TO SPECIFY OLIO DESK TOP



MFC TOP CODE
(For example: 'OTOP14X800SCOOP')



MFC FINISH
(For example: 'WHM')

Desktops are specified individually per workstation and change depending on whether a screen is to be used. For a 2 man desk with no screen, order 2 rectangular tops with a scoop edge for access to the cable tray. The code would be OTOP16X800SCOOP*** (x2).

Select a 800mm scoop top when no screen is required.

Select a 775mm deep desk top when a screen is to be fitted (back-to-back desks only).

Select a 800mm top for single or side-to-side.

MFC Finishes/ Matching Edge

Light Oak	MOK
White	WHM
Beech	MOB
Maple	MOM
Grey	MOG
Walnut	MOW
Romano Cherry	RCM

MFC Finishes/ Contrasting Edge

White/ oak edge	WHO
White/ Multiplex edge	WHX

OLIO DESKING & STORAGE

MFC TOPS

Rectangular MFC Top Suitable for Single and Side-to-side desks,

800mm deep rectangular desk top. Suitable for single or side-to-side desks.

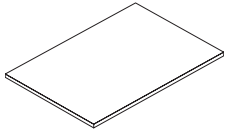

	WIDTH	DEPTH	HEIGHT
OTOP12X800 ***	1200mm	800mm	25mm
OTOP14X800 ***	1400mm	800mm	25mm
OTOP16X800 ***	1600mm	800mm	25mm
OTOP18X800 ***	1800mm	800mm	25mm

Rectangular MFC Top with Scoop, suitable for Single and Side-to-side desks, or Back-to-back Desks (when a screen isn't fitted).

800mm deep rectangular desk top. Suitable for single or side-to-side desks. Suitable for back-to-back desks where a screen is not fitted. Order 2 for a 2 man back-to-back desk.

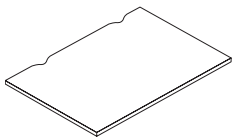

	WIDTH	DEPTH	HEIGHT
OTOP12X800SCOOP ***	1200mm	800mm	25mm
OTOP14X800SCOOP ***	1400mm	800mm	25mm
OTOP16X800SCOOP ***	1600mm	800mm	25mm
OTOP18X800SCOOP ***	1800mm	800mm	25mm

Rectangular MFC Top for Back-to-back Desks (when a screen is fitted).

775mm deep rectangular desk top. Suitable for back-to-back desks where a screen is fitted. Order 2 for a 2 man back-to-back desk.

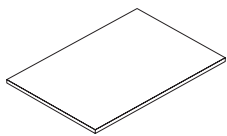

	WIDTH	DEPTH	HEIGHT
OTOP12X775 ***	1200mm	775mm	25mm
OTOP14X775 ***	1400mm	775mm	25mm
OTOP16X775 ***	1600mm	775mm	25mm
OTOP18X775 ***	1800mm	775mm	25mm

OLIO DESK FRAMES



Pictured Right: 2 man back-to-back frame
finished in white. OBB1416JWS

HOW TO SPECIFY OLIO DESK FRAME



FRAME CODE
(For example: 'OBB1616')



FRAME COLOUR
(For example: 'JWS')

To order the 2 man back-to-back frame (pictured above) the code would be - OBB1616JWS

To join two frames together to create a 4 man bench, a back-to-back cable tower is required - OTWR16JWS

To extend the bench, a further frame and cable tower is required for every 2 man extension. OBB1616JWS and OTWR16JWS

A single desk or side-to-side desk frame will accommodate 1 person. To extend to a 2 man side-to-side desk, a single cable tower and a single desk frame is required for every 1 man extension.

Steel Finishes

Silver	JOS	Regal Blue	RBS
Graphite	GGS	Signal Blue	SBS
Pale Grey	PGS	Ultramarine Blue	UBS
White	JWS	Tauben Blue	TGS
Black	BLS	Pastel Turquoise	PTS
Arrow Red	ARG	Pastel Mauve	PMS
Carmine Red	CRS	Khaki Green	KGS
Deep Orange	ORS		
Zinc Yellow	ZYS		
Fern Green	FGB		
Waterblue	WBS		
Sky Blue	SBB		

OLIO DESKING & STORAGE FRAMES

Single Desk or Side-to-side Desk Frame.

Single desk or side-to-side desk frame. Legs and storage not included. Order top separately. *Height measurement is final desk height.

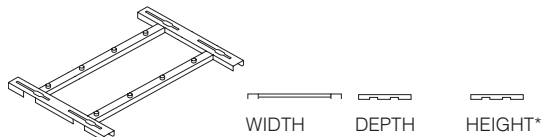

	WIDTH	DEPTH	HEIGHT*
OSS1208 ***	1200mm	800mm	740mm
OSS1408 ***	1400mm	800mm	740mm
OSS1608 ***	1600mm	800mm	740mm
OSS1808 ***	1800mm	800mm	740mm

Single Desk or Side-to-side Desk Frame with PUNI rail for screens.

Single desk or side-to-side desk frame. Legs and storage not included. Includes PUNI rails to attach screens. Order top separately. *Height measurement is final desk height.

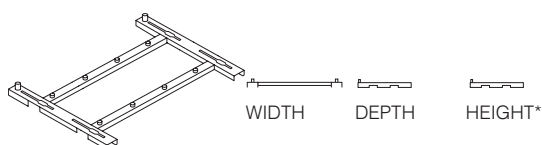

	WIDTH	DEPTH	HEIGHT*
OSS1208PUNI ***	1200mm	800mm	740mm
OSS1408PUNI ***	1400mm	800mm	740mm
OSS1608PUNI ***	1600mm	800mm	740mm
OSS1808PUNI ***	1800mm	800mm	740mm

Back-to-back Desk Frame.

Back-to-back desk frame. Legs and storage not included. Order top separately. *Height measurement is final desk height.

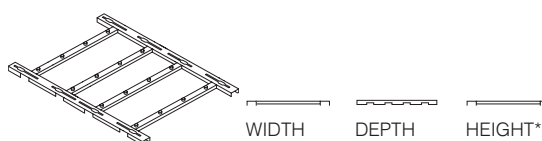

	WIDTH	DEPTH	HEIGHT*
OBB1216 ***	1200mm	1600mm	740mm
OBB1416 ***	1400mm	1600mm	740mm
OBB1616 ***	1600mm	1600mm	740mm
OBB1816 ***	1800mm	1600mm	740mm

Cable Tower.

800mm cable tower (suitable for single and side-to-side desk) or 1600mm cable tower (suitable for back-to-back desks). *Height measurement is final desk height. Includes height adjustable crank drilling.



	SUITABLE FOR	HEIGHT*
OTWR08 ***	800mm sng & S2S desk	740mm
OTWR16 ***	1600mm B2B desk	740mm

OLIO DESK LEGS



Pictured Right: 1600mm goalpost leg. OGLEG16JWS.

HOW TO SPECIFY OLIO DESK LEGS



LEG CODE
(For example: 'OGLEG16')

STEEL FINISH
(For example: 'JWS')

Olio has a choice of two leg frames – Goalpost or Rectangular loop.

To add a goalpost leg to the 2 man back-to-back desk previously selected with the intention of adding storage on to the other side (pictured above) the code would be OGLEG16JWS.

Single or side-to-side desks have right handed and left handed legs.

If legs are desired on both sides, see our Pico range.

Olio does not always require legs as it can be supported by storage on both sides.

Steel Finishes

Silver	JOS	Waterblue	WBS
Graphite	GGS	Sky Blue	SBB
Pale Grey	PGS	Regal Blue	RBS
White	JWS	Signal Blue	SBS
Black	BLS	Ultramarine Blue	UBS
Arrow Red	ARG	Tauben Blue	TGS
Carmine Red	CRS	Pastel Turquoise	PTS
Deep Orange	ORS	Pastel Mauve	PMS
Zinc Yellow	ZYS	Khaki Green	KGS
Fern Green	FGB		

OLIO DESKING & STORAGE

GOALPOST LEGS

Single or Side-to-side Desk Goalpost Leg.

Right handed (RH) or left handed (LH). Includes height adjustable crank drilling.



	WIDTH	DEPTH	HEIGHT
OGLEG08RH ***	60mm	800mm	715mm
OGLEG08LH ***	60mm	800mm	715mm

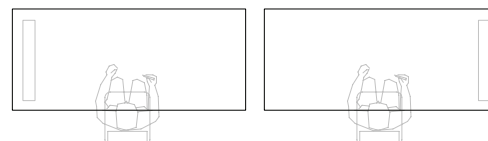

LH Leg

RH Leg

Back-to-back Desk Goalpost Leg.

Universal leg (can be fitted on either side). Includes height adjustable crank drilling.

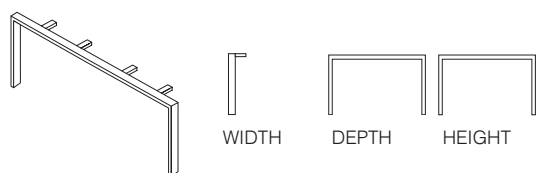

	WIDTH	DEPTH	HEIGHT
OGLEG16 ***	60mm	1600mm	715mm

RECTANGULAR LOOP LEGS

Single or Side-to-side Desk Rectangular Loop Leg.

Right handed (RH) or left handed (LH). Includes height adjustable crank drilling.

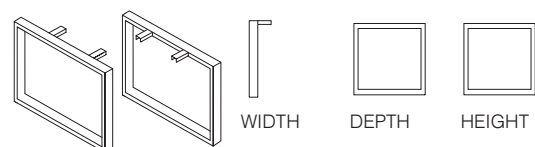

	WIDTH	DEPTH	HEIGHT
ORLEG08RH ***	60mm	800mm	715mm
ORLEG08LH ***	60mm	800mm	715mm

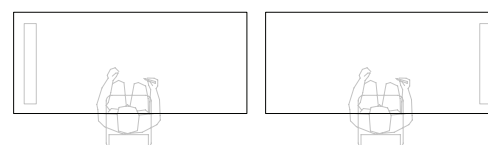

LH Leg

RH Leg

Back-to-back Desk Rectangular Loop Leg.

Universal leg (can be fitted on either side). Includes height adjustable crank drilling.

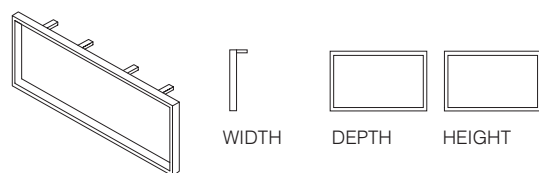

	WIDTH	DEPTH	HEIGHT
ORLEG16 ***	60mm	1600mm	715mm

OLIO STORAGE



Pictured Right: Level 2 unit attaching side filer unit with a pass through. Finished in white carcass, oak MFC and a sky blue frame. OL208S01JWSMOKSBB

HOW TO SPECIFY OLIO STORAGE

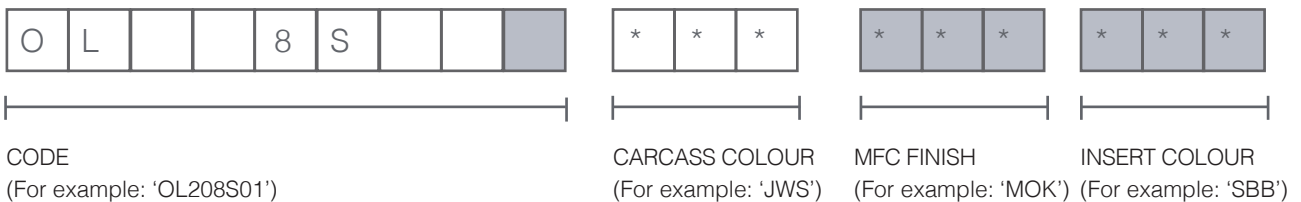

To specify a Level 2 unit with a side filer and a pass through section with a white carcass, white MFC and a sky blue frame (pictured above) the code would be OL208S02JWSMOKSBB.

Olío storage comes in 3 levels and is available to attach to the desk (replacing legs) or as a freestanding unit. For back-to-back desks, 2 desk connecting storage units are needed per end. For single or side-to-side storage a unit is required per end.

Freestanding units have holes drilled in the side for cable management.

The first level of storage and whole units (hinged door or tambour) only requires the carcass colour.

2nd level and 3rd level units all require a carcass colour, MFC finish and a insert colour. Insert colour refers to the steel insert.

The MFC finish should match the chosen desk MFC finish.

Steel Finishes

Silver	JOS	Waterblue	WBS
Graphite	GGG	Sky Blue	SBB
Pale Grey	PGS	Regal Blue	RBS
White	JWS	Signal Blue	SBS
Black	BLS	Ultramarine Blue	UBS
Arrow Red	ARG	Tauben Blue	TGS
Carmine Red	CRS	Pastel Turquoise	PTS
Deep Orange	ORS	Pastel Mauve	PMS
Zinc Yellow	ZYS	Khaki Green	KGS
Fern Green	FGB		

MFC Finishes/ Matching Edge

Light Oak	MOK
White	WHM
Beech	MOB
Maple	MOM
Grey	MOG
Walnut	MOW
Romano Cherry	RCM

MFC Finishes/ Contrasting Edge

White/ Oak edge
White/ Multiplex edge

OLIO DESKING & STORAGE

LEVEL 1 DESK CONNECTING STORAGE

Level 1 Side Filer.

Connects to desk. Side filer (2 drawers). Lockable. Order top separately.
 *Height measurement includes 25mm MFC top. Components not included.

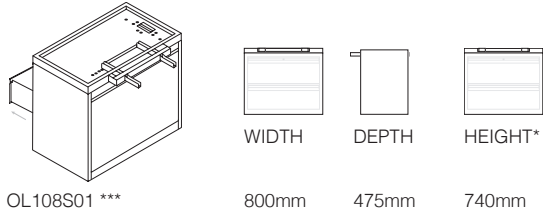

Accessories.

You may want to order this item.

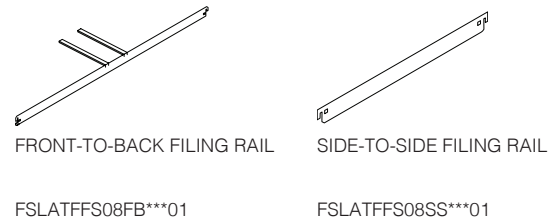

Level 1 Hinged Door.

Connects to desk. Hinged door. Lockable. Order top separately.
 *Height measurement includes 25mm MFC top. Components not included.

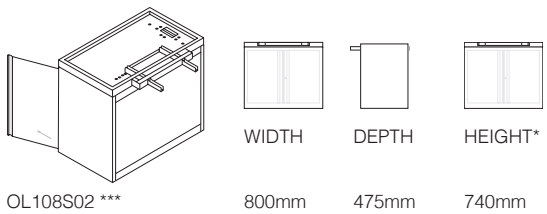

Level 1 Open Unit.

Connects to desk. Open unit at desk side. Order top separately.
 *Height measurement includes 25mm MFC top. Components not included.

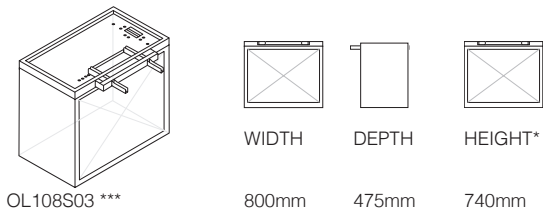

LEVEL 2 DESK CONNECTING STORAGE

Level 2 Side Filer with pass through section.

Connects to desk. Side filer (2 drawers) with pass through. Lockable drawers. Order top separately.
 Height measurement doesn't include 15mm steel or 25mm MFC top. Components not included.

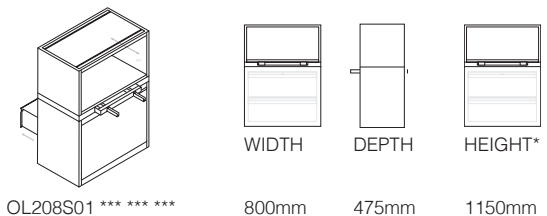

Level 2 Side Filer with desk facing Flipper.

Connects to desk. Side filer with 2 drawers with flipper facing towards the desk. Lockable. Order top separately.
 Height measurement doesn't include 15mm steel or 25mm MFC top. Components not included.

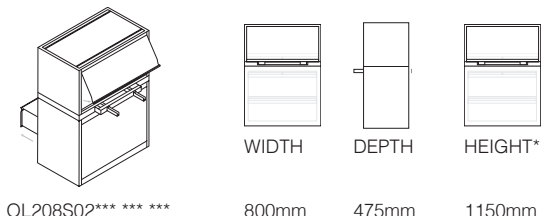

Level 2 Side Filer with desk facing Box.

Connects to desk. Side filer with 2 drawers with box facing towards the desk. Lockable drawers. Order top separately. Height measurement doesn't include 15mm steel or 25mm MFC top. Components not included.

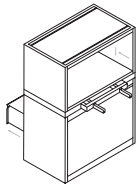

WIDTH

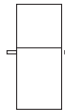

DEPTH



HEIGHT

OL208S03*** **

800mm

475mm

1150mm

Level 2 Hinged Door with Pass Through section.

Connects to desk. Hinged door with pass through. Lockable hinged door. Order top separately. Height measurement doesn't include 15mm steel or 25mm MFC top. Components not included.

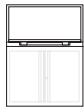
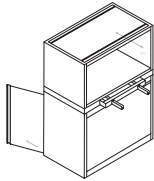

WIDTH

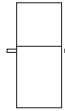

DEPTH

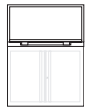

HEIGHT

OL208S04 *** **

800mm

475mm

1150mm

Level 2 Hinged Door with desk facing Flipper.

Connects to desk. Hinged door with flipper facing towards the desk. Lockable. Order top separately. Height measurement doesn't include 15mm steel or 25mm MFC top. Components not included.

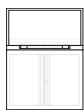
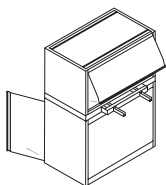

WIDTH

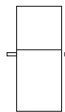

DEPTH

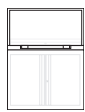

HEIGHT

OL208S05 *** **

800mm

475mm

1150mm

Level 2 Hinged Door with desk facing Box.

Connects to desk. Hinged door with box facing towards the desk. Lockable hinged door. Order top separately. Height measurement doesn't include 15mm steel or 25mm MFC top. Components not included.

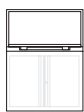
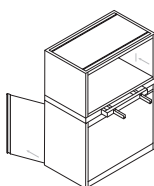

WIDTH

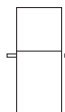

DEPTH

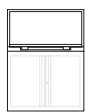

HEIGHT

OL208S06 *** **

800mm

475mm

1150mm

Level 2 Open Unit with Pass Through section.

Connects to desk. Open Unit with pass through. Order top separately. Height measurement doesn't include 15mm steel or 25mm MFC top. Components not included.

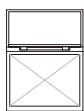
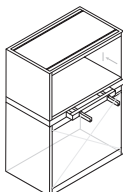

WIDTH

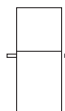

DEPTH

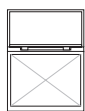

HEIGHT

OL208S07 *** **

800mm

475mm

1150mm

Level 2 Open Unit with desk facing Flipper.

Connects to desk. Open Unit with flipper facing towards the desk. Lockable flipper. Order top separately. Height measurement doesn't include 15mm steel or 25mm MFC top. Components not included.

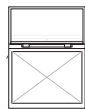
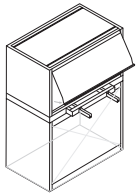

WIDTH

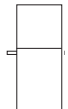

DEPTH



HEIGHT

OL208S08 *** ** *

800mm

475mm

1150mm

Level 2 Open Unit with desk facing Box.

Connects to desk. Open Unit with box facing towards the desk. Order top separately. Height measurement doesn't include 15mm steel or 25mm MFC top. Components not included.

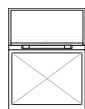
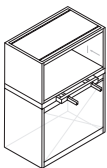

WIDTH

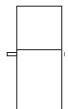

DEPTH



HEIGHT

OL208S09 *** ** *

800mm

475mm

1150mm

LEVEL 3 DESK CONNECTING STORAGE

Level 3 Side Filer with Pass Through section and outward facing Flipper.

Connects to desk. Side filer (2 drawers) with pass through and outward facing Flipper. Lockable. Order top separately. Height measurement doesn't include 15mm steel or 25mm MFC top. Components not included.

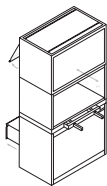

WIDTH

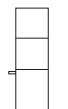

DEPTH



HEIGHT

OL308S01 *** ** *

800mm

475mm

1585mm

Accessories.

You may want to order this item.

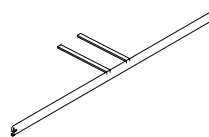

FRONT-TO-BACK FILING RAIL

FSLATFFS08FB***01

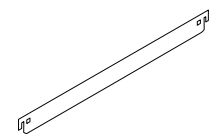

SIDE-TO-SIDE FILING RAIL

FSLATFFS08SS***01

Level 3 Side Filer with Pass Through section and desk facing Flipper.

Connects to desk. Side filer (2 drawers) with pass through and inward facing Flipper. Lockable. Order top separately. Height measurement doesn't include 15mm steel or 25mm MFC top. Components not included.

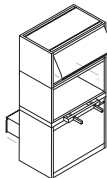

WIDTH

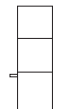

DEPTH



HEIGHT

OL308S02 *** ** *

800mm

475mm

1585mm

Accessories.

You may want to order this item.

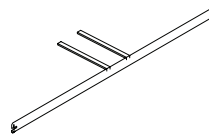

FRONT-TO-BACK FILING RAIL

FSLATFFS08FB***01

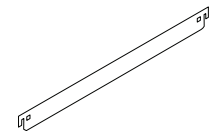

SIDE-TO-SIDE FILING RAIL

FSLATFFS08SS***01

Level 3 Side Filer with Pass Through section with desk facing box.

Connects to desk. Side filer (2 drawers) with pass through and desk facing box. Lockable drawers. Order top separately. Height measurement doesn't include 15mm steel or 25mm MFC top. Components not included.



WIDTH

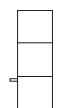

DEPTH



HEIGHT

OL308S03 *** ** *

800mm

475mm

1585mm

Accessories.

You may want to order this item.

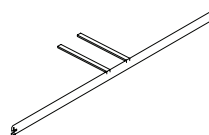

FRONT-TO-BACK FILING RAIL

FSLATFFS08FB***01

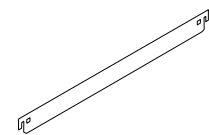

SIDE-TO-SIDE FILING RAIL

FSLATFFS08SS***01

Level 3 Side Filer with Pass Through section with outward box.

Connects to desk. Side filer (2 drawers) with pass through and outward facing box. Lockable drawers. Order top separately. Height measurement doesn't include 15mm steel or 25mm MFC top. Components not included.

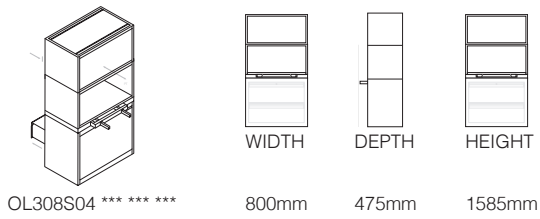

Level 3 Side Filer with 2 Pass Through sections.

Connects to desk. Side filer (2 drawers) with 2 pass through sections. Lockable drawers. Order top separately. Height measurement doesn't include 15mm steel or 25mm MFC top. Components not included.

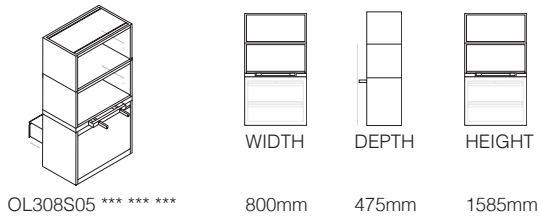

Level 3 Side Filer with desk facing Flipper and Pass Through section.

Connects to desk. Side filer (2 drawers) with inward facing Flipper and pass through. Lockable. Order top separately. Height measurement doesn't include 15mm steel or 25mm MFC top. Components not included.

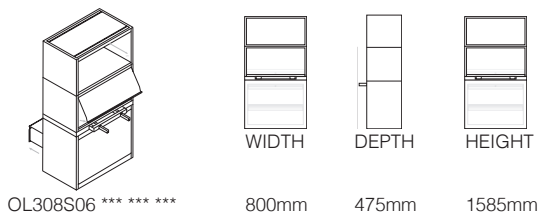

Level 3 Hinged Door with Pass Through section and outward facing Flipper.

Connects to desk. Hinged door with pass through and outward facing Flipper. Lockable. Order top separately. Height measurement doesn't include 15mm steel or 25mm MFC top. Components not included.

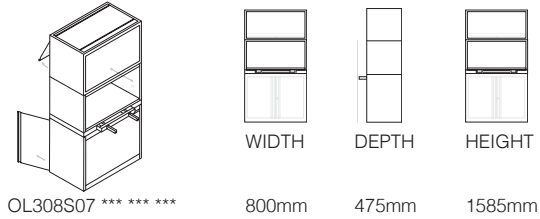

Level 3 Hinged Door with Pass Through section and desk facing Flipper.

Connects to desk. Hinged door with pass through and inward facing Flipper. Lockable. Order top separately. Height measurement doesn't include 15mm steel or 25mm MFC top. Components not included.

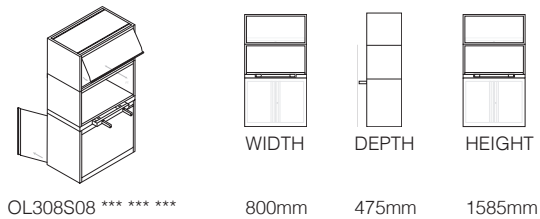

Level 3 Hinged Door with Pass Through section and desk facing box.

Connects to desk. Hinged door with pass through and inward facing box. Lockable hinged door. Order top separately. Height measurement doesn't include 15mm steel or 25mm MFC top. Components not included.

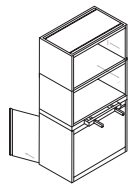

WIDTH

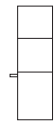

DEPTH

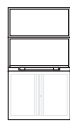

HEIGHT

OL308S09 *** **

800mm

475mm

1585mm

Level 3 Hinged Door with Pass Through section and outward facing box.

Connects to desk. Hinged door with pass through and outward facing box. Lockable hinged door. Order top separately. Height measurement doesn't include 15mm steel or 25mm MFC top. Components not included.

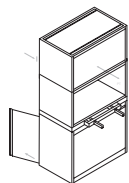

WIDTH

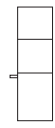

DEPTH

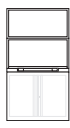

HEIGHT

OL308S010 *** **

800mm

475mm

1585mm

Level 3 Hinged Door with 2 Pass Through section.

Connects to desk. Hinged door with 2 pass through sections. Lockable hinged door. Order top separately. Height measurement doesn't include 15mm steel or 25mm MFC top. Components not included.

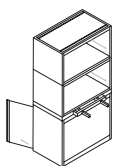

WIDTH

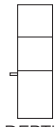

DEPTH



HEIGHT

OL308S011 *** **

800mm

475mm

1585mm

Level 3 Hinged Door with desk facing Flipper and Pass Through.

Connects to desk. Hinged door with inward facing flipper and pass through. Lockable. Order top separately. Height measurement doesn't include 15mm steel or 25mm MFC top. Components not included.

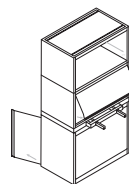

WIDTH

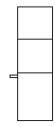

DEPTH



HEIGHT

OL308S012 *** **

800mm

475mm

1585mm

Level 3 Open Unit with Pass Through and outward facing Flipper.

Connects to desk. Open Unit with pass through and outward facing Flipper. Lockable Flipper. Order top separately. Height measurement doesn't include 15mm steel or 25mm MFC top. Components not included.

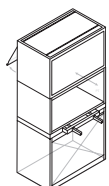

WIDTH

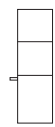

DEPTH



HEIGHT

OL308S013 *** **

800mm

475mm

1585mm

Level 3 Open Unit with Pass Through and desk facing Flipper.

Connects to desk. Open Unit with pass through and inward facing Flipper. Lockable Flipper. Order top separately. Height measurement doesn't include 15mm steel or 25mm MFC top. Components not included.

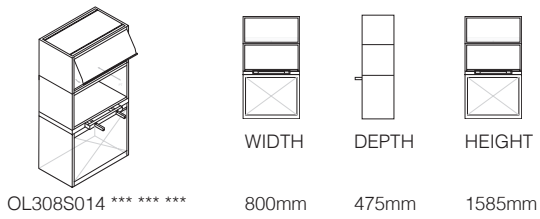

Level 3 Open Unit with Pass Through and desk facing box.

Connects to desk. Open Unit with pass through and inward facing box. Order top separately. Height measurement doesn't include 15mm steel or 25mm MFC top. Components not included.

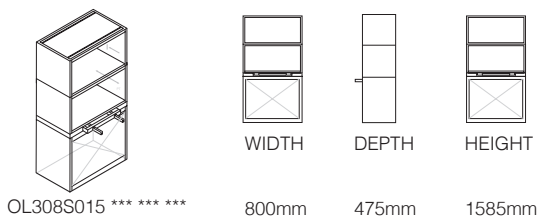

Level 3 Open Unit with Pass Through and outward facing box.

Connects to desk. Open Unit with pass through and outward facing box. Order top separately. Height measurement doesn't include 15mm steel or 25mm MFC top. Components not included.

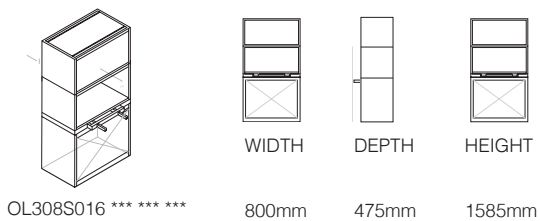

Level 3 Open Unit with 2 Pass Through sections.

Connects to desk. Open Unit with 2 pass through sections. Order top separately. Height measurement doesn't include 15mm steel or 25mm MFC top. Components not included.

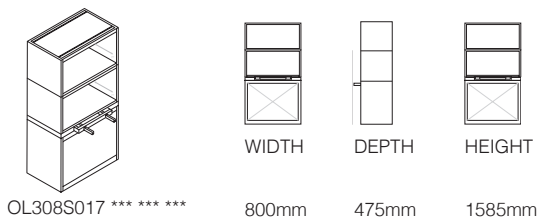

Level 3 Open Unit with desk facing Flipper and Pass Through.

Connects to desk. Open Unit with inward facing Flipper and pass through. Lockable Flipper. Order top separately. Height measurement doesn't include 15mm steel or 25mm MFC top. Components not included.

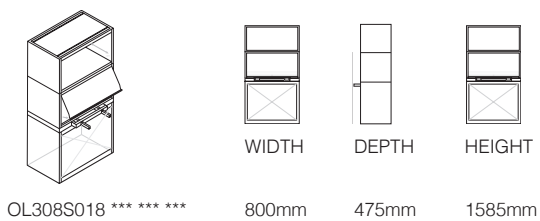

LEVEL 1 FREESTANDING STORAGE

Level 1 Side Filer

Freestanding. Side filer (2 drawers). Lockable. Order top separately.
 *Height measurement includes 25mm MFC top. Components not included.

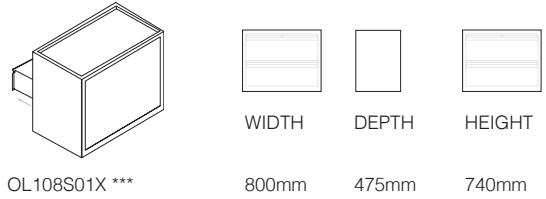

OL108S01X ***

WIDTH	DEPTH	HEIGHT
800mm	475mm	740mm

Accessories.

You need to order these items.

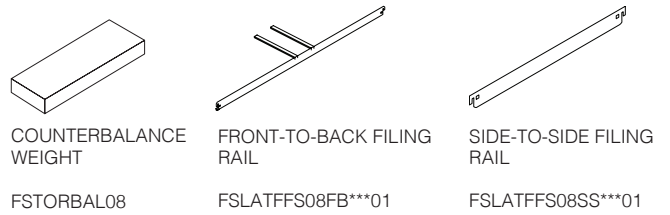

COUNTERBALANCE WEIGHT	FRONT-TO-BACK FILING RAIL	SIDE-TO-SIDE FILING RAIL
FSTORBAL08	FSLATFFS08FB***01	FSLATFFS08SS***01

Level 1 Hinged Door

Freestanding. Hinged door. Lockable. Order top separately.
 *Height measurement includes 25mm MFC top. Components not included.

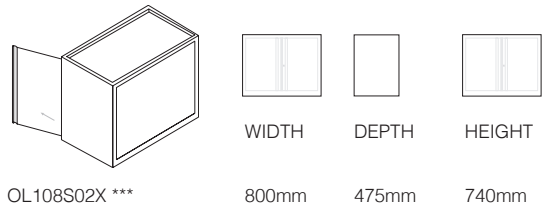

OL108S02X ***

WIDTH	DEPTH	HEIGHT
800mm	475mm	740mm

Level 1 Open Unit

Freestanding. Open unit at desk side. Order top separately.
 *Height measurement includes 25mm MFC top. Components not included.

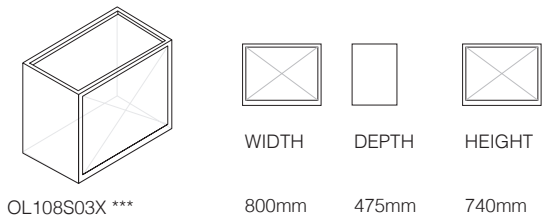

OL108S03X ***

WIDTH	DEPTH	HEIGHT
800mm	475mm	740mm

LEVEL 2 FREESTANDING STORAGE

Level 2 Side Filer with Pass Through section.

Freestanding. Side filer (2 drawers) with pass through. Lockable drawers.
 Order top separately. Height measurement doesn't include 15mm steel or 25mm MFC top. Components not included.

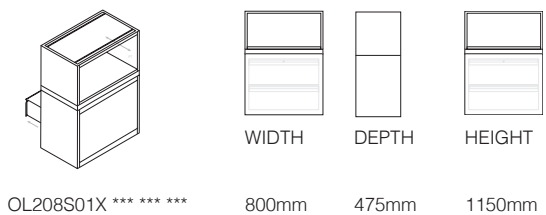

OL208S01X *** ** *

WIDTH	DEPTH	HEIGHT
800mm	475mm	1150mm

Accessories.

You need to order these items.

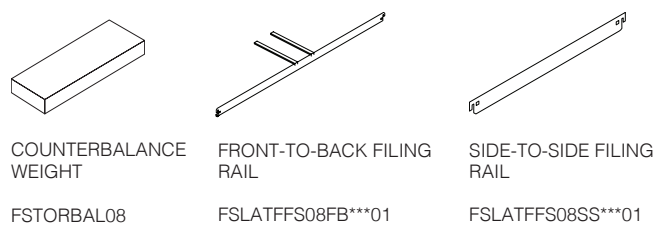

COUNTERBALANCE WEIGHT	FRONT-TO-BACK FILING RAIL	SIDE-TO-SIDE FILING RAIL
FSTORBAL08	FSLATFFS08FB***01	FSLATFFS08SS***01

Level 2 Side Filer with desk facing Flipper.

Freestanding. Side filer with 2 drawers with flipper facing towards the desk.
 Lockable. Order top separately. Height measurement doesn't include 15mm steel or 25mm MFC top. Components not included.

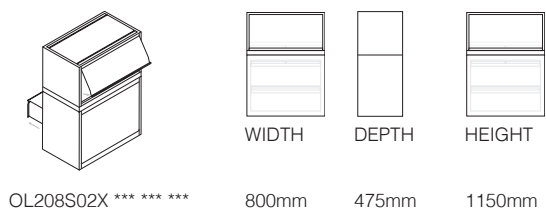

OL208S02X *** ** *

WIDTH	DEPTH	HEIGHT
800mm	475mm	1150mm

Accessories.

You need to order these items.

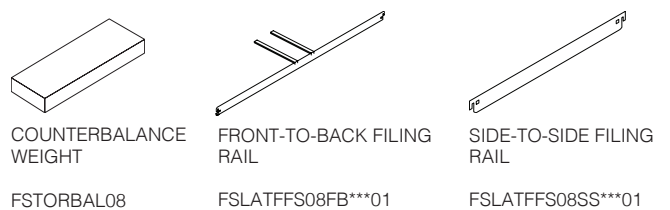

COUNTERBALANCE WEIGHT	FRONT-TO-BACK FILING RAIL	SIDE-TO-SIDE FILING RAIL
FSTORBAL08	FSLATFFS08FB***01	FSLATFFS08SS***01

Level 2 Side Filer with desk facing Box.

Freestanding. Side filer with 2 drawers with box facing towards the desk. Lockable drawers. Order top separately. Height measurement doesn't include 15mm steel or 25mm MFC top. Components not included.

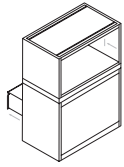

WIDTH



DEPTH



HEIGHT

OL208S03X*** **

800mm

475mm

1150mm

Accessories.

You need to order a counterbalance weight with this cabinet

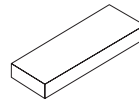

COUNTERBALANCE WEIGHT

FSTORBAL08

Level 2 Hinged Door with Pass Through section.

Freestanding. Hinged door with pass through. Lockable hinged door. Order top separately. Height measurement doesn't include 15mm steel or 25mm MFC top. Components not included.

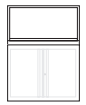
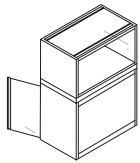

WIDTH

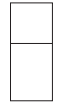

DEPTH

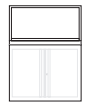

HEIGHT

OL208S04X *** **

800mm

475mm

1150mm

Level 2 Hinged Door with desk facing Flipper.

Freestanding. Hinged door with flipper facing towards the desk. Lockable. Order top separately. Height measurement doesn't include 15mm steel or 25mm MFC top. Components not included.

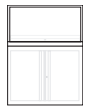
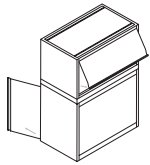

WIDTH

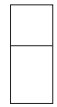

DEPTH

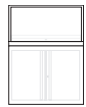

HEIGHT

OL208S05X *** **

800mm

475mm

1150mm

Level 2 Hinged Door with desk facing box.

Freestanding. Hinged door with box facing towards the desk. Lockable hinged door. Order top separately. Height measurement doesn't include 15mm steel or 25mm MFC top. Components not included.

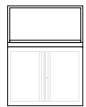
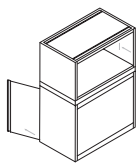

WIDTH

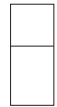

DEPTH

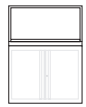

HEIGHT

OL208S06X *** **

800mm

475mm

1150mm

Level 2 Hinged Door.

Freestanding. Hinged door. Order top separately. Height measurement doesn't include 15mm steel or 25mm MFC top. Components not included.

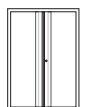
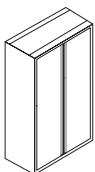

WIDTH



DEPTH

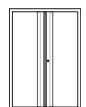

HEIGHT

FS115008 *** 28000

800mm

475mm

1150mm

FS115010 *** 28000

1000mm

475mm

1150mm

Level 2 Open Unit with Pass through section.

Freestanding. Open Unit with pass through. Order top separately.

Height measurement doesn't include 15mm steel or 25mm MFC top. Components not included.

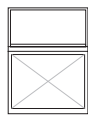
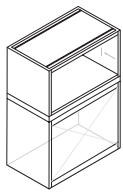

WIDTH



DEPTH



HEIGHT

OL208S07X *** **

800mm

475mm

1150mm

Level 2 Open Unit with desk facing Flipper.

Freestanding. Open Unit with flipper facing towards the desk. Lockable flipper. Order top separately.

Height measurement doesn't include 15mm steel or 25mm MFC top. Components not included.

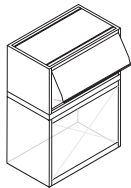

WIDTH

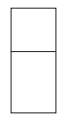

DEPTH

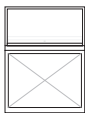

HEIGHT

OL208S08X *** **

800mm

475mm

1150mm

Level 2 Open Unit with desk facing Box.

Freestanding. Open Unit with box facing towards the desk. Order top separately.

Height measurement doesn't include 15mm steel or 25mm MFC top. Components not included.

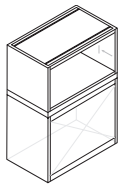

WIDTH

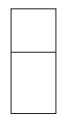

DEPTH

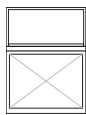

HEIGHT

OL208S09X *** **

800mm

475mm

1150mm

Level 2 Tambour.

Freestanding. Tambour. Order top separately.

Height measurement doesn't include 15mm steel or 25mm MFC top. Components not included.

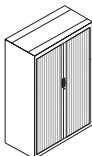

WIDTH



DEPTH

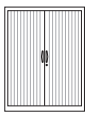

HEIGHT

FS115008 *** PL ** 000

800mm

475mm

1150mm

FS115010 *** PL ** 000

1000mm

475mm

1150mm

LEVEL 3 FREESTANDING STORAGE

Level 3 Side Filer with Pass Through section and outward facing Flipper.

Freestanding. Side filer (2 drawers) with pass through and outward facing Flipper. Lockable. Order top separately. Height measurement doesn't include 15mm steel or 25mm MFC top. Components not included.

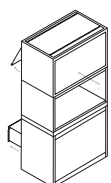

WIDTH



DEPTH



HEIGHT

OL308S01X *** **

800mm

475mm

1585mm

Accessories.

You need to order these items.

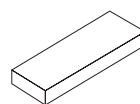

COUNTERBALANCE WEIGHT

FSTORBAL08

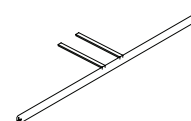

FRONT-TO-BACK FILING RAIL

FSLATFFS08FB***01

Level 3 Side Filer with Pass Through section and desk facing Flipper.

Freestanding. Side filer (2 drawers) with pass through and inward facing Flipper. Lockable. Order top separately. Height measurement doesn't include 15mm steel or 25mm MFC top. Components not included.

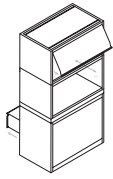

WIDTH



DEPTH



HEIGHT

OL308S02X *** **

800mm

475mm

1585mm

Accessories.

You need to order a counterbalance weight with this cabinet

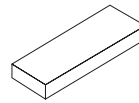

COUNTERBALANCE WEIGHT

FSTORBAL08

Level 3 Side Filer with Pass Through section with desk facing box.

Freestanding. Side filer (2 drawers) with pass through and desk facing box. Lockable drawers. Order top separately. Height measurement doesn't include 15mm steel or 25mm MFC top. Components not included.

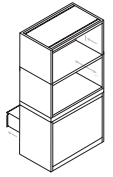

WIDTH

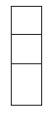

DEPTH



HEIGHT

OL308S03X *** **

800mm

475mm

1585mm

Accessories.

You need to order a counterbalance weight with this cabinet

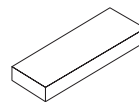

COUNTERBALANCE WEIGHT

FSTORBAL08

Level 3 Side Filer with Pass Through section with outward box.

Freestanding. Side filer (2 drawers) with pass through and outward facing box. Lockable drawers. Order top separately. Height measurement doesn't include 15mm steel or 25mm MFC top. Components not included.

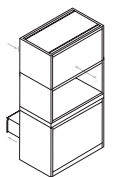

WIDTH



DEPTH



HEIGHT

OL308S04X *** **

800mm

475mm

1585mm

Accessories.

You need to order a counterbalance weight with this cabinet

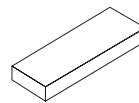

COUNTERBALANCE WEIGHT

FSTORBAL08

Level 3 Side Filer with 2 Pass Through sections.

Freestanding. Side filer (2 drawers) with 2 pass through sections. Lockable drawers. Order top separately. Height measurement doesn't include 15mm steel or 25mm MFC top. Components not included.

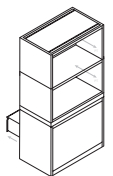

WIDTH



DEPTH



HEIGHT

OL308S05X *** **

800mm

475mm

1585mm

Accessories.

You need to order a counterbalance weight with this cabinet

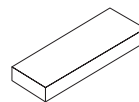

COUNTERBALANCE WEIGHT

FSTORBAL08

Level 3 Side Filer with desk facing Flipper and Pass Through section.

Freestanding. Side filer (2 drawers) with inward facing Flipper and pass through. Lockable. Order top separately. Height measurement doesn't include 15mm steel or 25mm MFC top. Components not included.

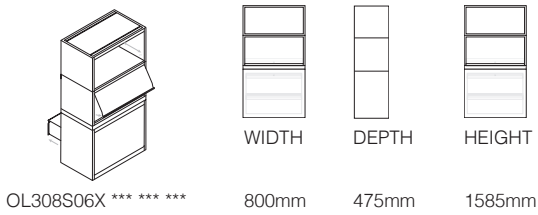

Accessories.

You need to order a counterbalance weight with this cabinet



Level 3 Hinged Door with Pass Through section and outward facing Flipper.

Freestanding. Hinged door with pass through and outward facing Flipper. Lockable. Order top separately. Height measurement doesn't include 15mm steel or 25mm MFC top. Components not included.

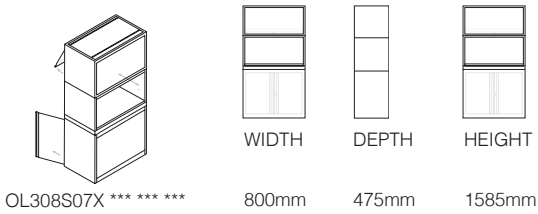

Level 3 Hinged Door with Pass Through section and desk facing Flipper.

Freestanding. Hinged door with pass through and inward facing Flipper. Lockable. Order top separately. Height measurement doesn't include 15mm steel or 25mm MFC top. Components not included.

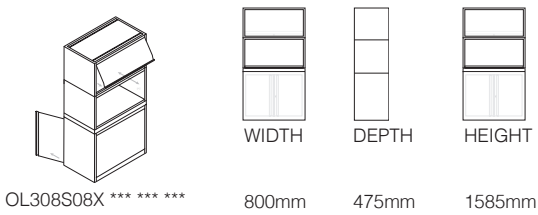

Level 3 Hinged Door with Pass Through section and desk facing box.

Freestanding. Hinged door with pass through and inward facing box. Lockable hinged door. Order top separately. Height measurement doesn't include 15mm steel or 25mm MFC top. Components not included.

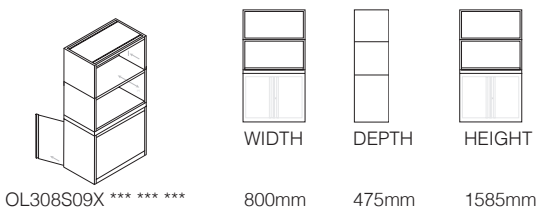

Level 3 Hinged Door with Pass Through sections and outward facing box.

Freestanding. Hinged door with pass through and outward facing box. Lockable hinged door. Order top separately. Height measurement doesn't include 15mm steel or 25mm MFC top. Components not included.

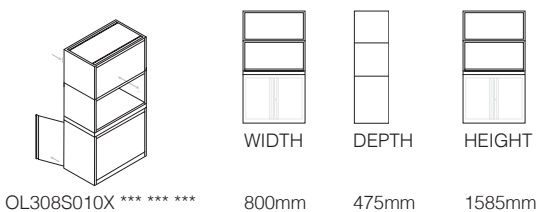

Level 3 Hinged Door with 2 pass through sections.

Freestanding. Hinged door with 2 pass through sections. Lockable hinged door. Order top separately. Height measurement doesn't include 15mm steel or 25mm MFC top. Components not included.

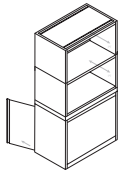

WIDTH



DEPTH



HEIGHT

OL308S011X *** **

800mm	475mm	1585mm
-------	-------	--------

Level 3 Hinged Door with desk facing Flipper and Pass Through.

Freestanding. Hinged door with inward facing flipper and pass through. Lockable. Order top separately. Height measurement doesn't include 15mm steel or 25mm MFC top. Components not included.

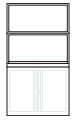
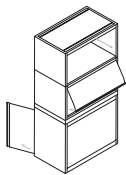

WIDTH



DEPTH

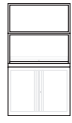

HEIGHT

OL308S012X *** **

800mm	475mm	1585mm
-------	-------	--------

Level 3 Hinged Door.

Freestanding. Hinged door. Lockable. Order top separately. Height measurement doesn't include 15mm steel or 25mm MFC top. Components not included.

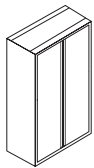

WIDTH



DEPTH



HEIGHT

FSL158508 *** 29000 800mm 475mm 1585mm
 FSL158510 *** 29000 1000mm 475mm 1585mm

Level 3 Open Unit with Pass Through and outward facing Flipper.

Freestanding. Open Unit with pass through and outward facing Flipper. Lockable Flipper. Order top separately. Height measurement doesn't include 15mm steel or 25mm MFC top. Components not included.

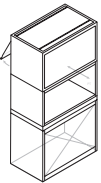

WIDTH



DEPTH



HEIGHT

OL308S013X *** **

800mm	475mm	1585mm
-------	-------	--------

Level 3 Open Unit with Pass Through and desk facing Flipper.

Freestanding. Open Unit with pass through and inward facing Flipper. Lockable Flipper. Order top separately. Height measurement doesn't include 15mm steel or 25mm MFC top. Components not included.



WIDTH



DEPTH



HEIGHT

OL308S014X *** **

800mm	475mm	1585mm
-------	-------	--------

Level 3 Open Unit with Pass Through and desk facing Box.

Freestanding. Open Unit with pass through and inward facing box. Order top separately.
Height measurement doesn't include 15mm steel or 25mm MFC top. Components not included.

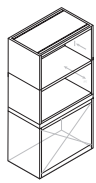

WIDTH



DEPTH



HEIGHT

OL308S015X *** ** ** 800mm 475mm 1585mm

Level 3 Open Unit with Pass Through and outward facing Box.

Freestanding. Open Unit with pass through and outward facing box. Order top separately.
Height measurement doesn't include 15mm steel or 25mm MFC top. Components not included.

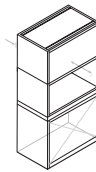

WIDTH

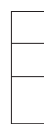

DEPTH

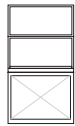

HEIGHT

OL308S016X *** ** ** 800mm 475mm 1585mm

Level 3 Open Unit with 2 Pass Through sections.

Freestanding. Open Unit with 2 pass through sections. Order top separately.
Height measurement doesn't include 15mm steel or 25mm MFC top. Components not included.

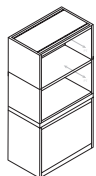

WIDTH

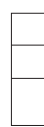

DEPTH



HEIGHT

OL308S017X *** ** ** 800mm 475mm 1585mm

Level 3 Open Unit with desk facing Flipper and Pass Through.

Freestanding. Open Unit with inward facing Flipper and pass through. Lockable Flipper. Order top separately.
Height measurement doesn't include 15mm steel or 25mm MFC top. Components not included.

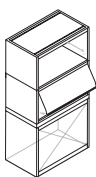

WIDTH

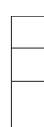

DEPTH



HEIGHT

OL308S018X *** ** ** 800mm 475mm 1585mm

Level 3 Tambour.

Freestanding. Tambour. Order top separately. Height measurement doesn't include 15mm steel or 25mm MFC top. Components not included.

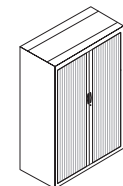

WIDTH



DEPTH



HEIGHT

FS158508 *** PL ** 000 800mm 475mm 1585mm

FS158510 *** PL ** 000 1000mm 475mm 1585mm

OLIO STORAGE TOPS



Pictured Right: 1600mm flyover MFC top with grain front to back.
OTPM475X1600MOK

HOW TO SPECIFY OLIO STORAGE TOPS



MFC STORAGE TOP CODE
(For example: 'OTPM475X1600')



MFC FINISH
(For example: 'MOK')

To add rectangular double flyover MFC top in white to 2x 800mm wide storage unit (pictured above) the code would be OTPM475X1600MOK. When specifying MFC tops for storage the grain direction can be selected to suit desk grain.

MFC tops add 25mm to the heights stated in this document.
Overall desk height and level 1 storage is 740mm.
Steel tops add 15mm to height
Steel tops are not available for level 1 storage units.

MFC Finishes/ Matching Edge

Light Oak	MOK
White	WHM
Beech	MOB
Maple	MOM
Grey	MOG
Walnut	MOW
Romano Cherry	RCM

MFC Finishes/ Contrasting Edge

White/ Oak edge
White/ Multiplex edge

OLIO DESKING & STORAGE

MFC STORAGE TOPS

Single Storage Top (Grain Direction Choice).

MFC top for storage unit. Width measurement references grain direction.

Fits all 800mm (or 1000mm) (w) x 475mm (d) x various height units.

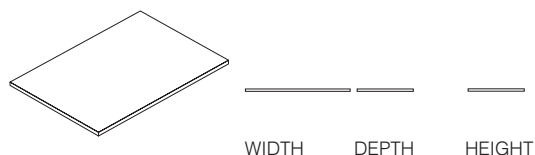

Front-to-Back

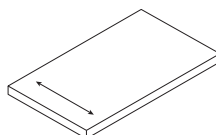

Side-to-side

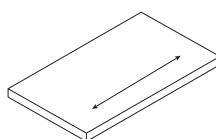

Grain Front to Back

OTPM475X800 ****	800mm	475mm	25mm
OTPM475X1000 ****	1000mm	475mm	25mm

Grain Side-to-side

OTPM800X475 ****	800mm	475mm	25mm
OTPM1000X475 ****	1000mm	475mm	25mm

Double Storage Top (Grain Direction Choice).

MFC top for 2x 800mm storage unit. Width measurement references grain direction.

Fits all 800mm (w) x 475mm (d) x various height units.

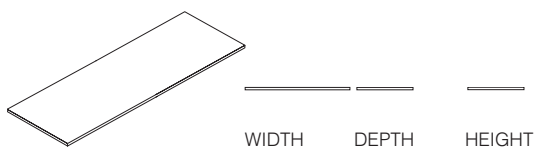

Front-to-Back

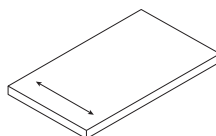

Side-to-side

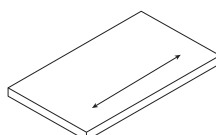

Grain Front to Back

OTPM475X1600 ***	1600mm	475mm	25mm
------------------	--------	-------	------

Grain Side-to-side

OTPM1600X475 ***	1600mm	475mm	25mm
------------------	--------	-------	------

Single Steel Top.

Not suitable for level 1 storage. Lateral storage (side filers and hinged door) has a separate top to tambours.

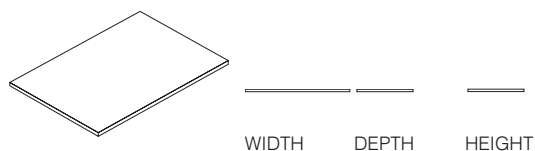

For Lateral Storage

OTPL800 ****	800mm	475mm	15mm
OTPL1000 ***	1000mm	475mm	15mm

For Tambour Storage

OTPT800 ***	800mm	475mm	15mm
OTPT1000***	1000mm	475mm	15mm

OLIO ACCESSORIES



Pictured Right: All white back to back cable tray. PBBTRAY1400JWS

HOW TO SPECIFY OLIO CABLE TRAYS



CABLE TRAY CODE
(For example: 'PBBTRAY1400')



STEEL COLOUR
(For example: 'JWS')

To add a 1400mm wide cable tray (pictured above) the code would be PBBTRAY1400JWS.

Modesty panels are only required on single and side-to-side desks.

Cable tray codes work on a similar system where the '****' code is replaced by the desired steel colour.

Steel Finishes

Silver	JOS	Regal Blue	RBS
Graphite	GGS	Signal Blue	SBS
Pale Grey	PGS	Ultramarine Blue	UBS
White	JWS	Tauben Blue	TGS
Black	BLS	Pastel Turquoise	PTS
Arrow Red	ARG	Pastel Mauve	PMS
Carmine Red	CRS	Khaki Green	KGS
Deep Orange	ORS		
Zinc Yellow	ZYS		
Fern Green	FGB		
Waterblue	WBS		
Sky Blue	SBB		

OLIO DESKING & STORAGE

CABLE TRAYS

Single Cable Trays.

Suitable for single and side-to-side desks.

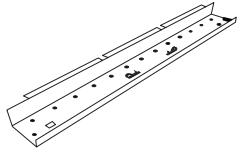

	WIDTH	DEPTH	HEIGHT
PSTRAY1200 ***	1200mm	N/a	80mm
PSTRAY1400 ***	1400mm	N/a	80mm
PSTRAY1600 ***	1600mm	N/a	80mm
PSTRAY1800 ***	1800mm	N/a	80mm

Double Cable Trays.

Suitable for back-to-back desks.

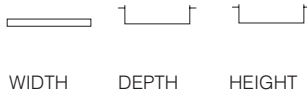
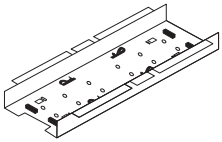

	WIDTH	DEPTH	HEIGHT
PBBTRAY1200 ***	1200mm	N/a	80mm
PBBTRAY1400 ***	1400mm	N/a	80mm
PBBTRAY1600 ***	1600mm	N/a	80mm
PBBTRAY1800 ***	1800mm	N/a	80mm

Suspended Modesty Panels.

Includes fixings.

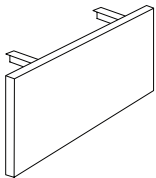

	WIDTH	DEPTH	HEIGHT
JMOD1200 *** P	1200mm	N/a	317mm
JMOD1400 *** P	1400mm	N/a	317mm
JMOD1600 *** P	1600mm	N/a	317mm
JMOD1800 *** P	1800mm	N/a	317mm

COMPONENTS

Front-to-Back Filing Rails for Drawers.

Available as a single (01) and a pack of 3 (03).

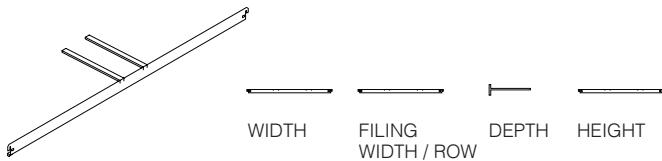

	WIDTH	FILING WIDTH / ROW	DEPTH	HEIGHT
FSLATFFS08FBBSL01	800mm	385mm x 2	N/a	N/a
FSLATFFS10FBBSL01	1000mm	385mm x 2	N/a	N/a
FSLATFFS08FBBSL03	800mm	385mm x 2	N/a	N/a
FSLATFFS10FBBSL03	1000mm	385mm x 2	N/a	N/a

Side-to-Side Filing Rails for Drawers.

Available as a single (01) and a pack of 3 (03).

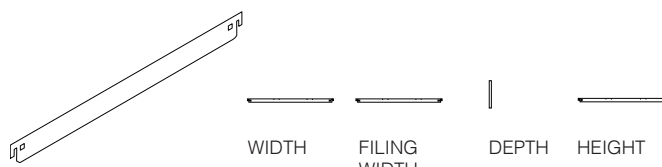

	WIDTH	FILING WIDTH	DEPTH	HEIGHT
FSLATFFS08SSBSL01	800mm	748mm	N/a	N/a
FSLATFFS10SSBSL01	1000mm	948mm	N/a	N/a
FSLATFFS08SSBSL03	800mm	748mm	N/a	N/a
FSLATFFS10SSBSL03	1000mm	948mm	N/a	N/a

Counterbalance Weights.

Recommended for Freestor lateral unit containing 1 or more drawers.
Compulsory for freestanding storage units.

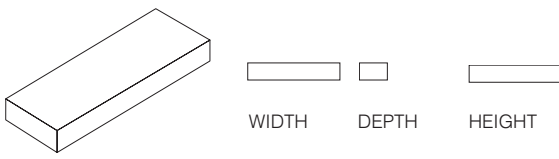

	WIDTH	DEPTH	HEIGHT
FSTORBAL08	800mm	N/a	N/a
FSTORBAL10	1000mm	N/a	N/a

Plain Shelf.

Available as a single (01) or a pack of 6 (06).

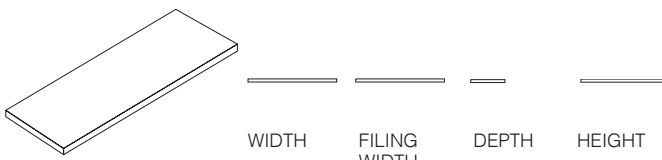

	WIDTH	FILING WIDTH	DEPTH	HEIGHT
FSLCPLS0840BLS01	800mm	748mm	405mm	13mm
FSLCPLS1040BLS01	1000mm	948mm	405mm	13mm
FSLCPLS0840BLS06	800mm	748mm	405mm	13mm
FSLCPLS1040BLS06	1000mm	948mm	405mm	13mm

Slotted Filing Shelf.

Available as a single (01) or a pack of 4 (04).

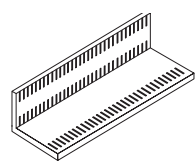

	WIDTH	FILING WIDTH	DEPTH	HEIGHT
FSLCFXS0840***01	800mm	748mm	405mm	172mm
FSLCFXS1040***01	1000mm	948mm	405mm	172mm
FSLCFXS0840***04	800mm	748mm	405mm	172mm
FSLCFXS1040***04	1000mm	948mm	405mm	172mm

Accessories.

You may want to order this item.

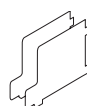

DIVIDERS

FSCDIV1508***05
FSCDIV1508***05
FSCDIV1508***15
FSCDIV1508***15

Pigeon Holes.

Order 3 per 800mm shelf with 4 dividers and 4 per 1000mm shelf with 5 dividers.

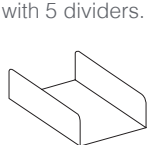

	WIDTH	DEPTH	HEIGHT
SCFPHUA4FL***04	226mm	330mm	100mm

Accessories.

You need to order these items.

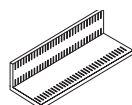

SLOTTED SHELF

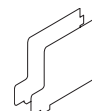

DIVIDERS

Select a Slotted Shelf FSCDIV1508***05

Lateral Plain Shelf with Integral Suspension Rail.

Available as a single (01) or pack of 4 (04). Fixed position.

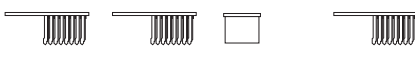
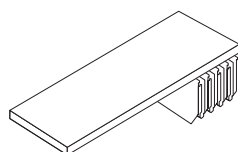

	WIDTH	FILING WIDTH	DEPTH	HEIGHT
FSLCULP0840BLS01	800mm	748mm	25mm	23mm
FSLCULP1040BLS01	1000mm	948mm	25mm	23mm
FSLCULP0840BLS04	800mm	748mm	25mm	23mm
FSLCULP1040BLS04	1000mm	948mm	25mm	23mm

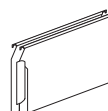

FILES

Accessories.

You need to order this item.

AZV
AZV
AZV
AZV

Coat Shelf.

Compatible with hinged door storage.

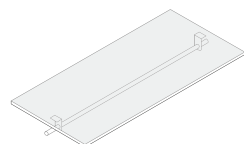

	WIDTH	DEPTH	HEIGHT
FSLCCS0840BLS01	800mm	25mm	23mm
FSLCCS1040BLS01	1000mm	25mm	23mm

OLIO DESKING & STORAGE

FABRIC SCREENS

Screen with 1 Additional Accessory Rail.

Desk mounted fabric screen. 405mm high.

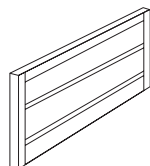

WIDTH



DEPTH



HEIGHT

Please Request SPB	1200mm	30mm	405mm
Please Request SPB	1400mm	30mm	405mm
Please Request SPB	1600mm	30mm	405mm
Please Request SPB	1800mm	30mm	405mm

Screen with No Additional Accessory Rail.

Desk mounted fabric screen. 405mm high.

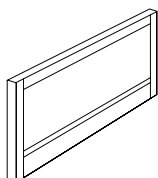

WIDTH



DEPTH



HEIGHT

Please Request SPB	1200mm	30mm	405mm
Please Request SPB	1400mm	30mm	405mm
Please Request SPB	1600mm	30mm	405mm
Please Request SPB	1800mm	30mm	405mm

PLEXIGLASS SCREENS

Screen with 1 Additional Accessory Rail.

Desk mounted Plexiglass screen. 405mm high.

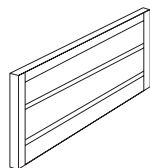

WIDTH



DEPTH



HEIGHT

Please Request SPB	1200mm	30mm	405mm
Please Request SPB	1400mm	30mm	405mm
Please Request SPB	1600mm	30mm	405mm
Please Request SPB	1800mm	30mm	405mm

Screen with No Additional Accessory Rail.

Desk mounted Plexiglass screen. 405mm high.

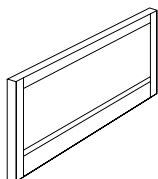

WIDTH



DEPTH



HEIGHT









Please Request SPB	1200mm	30mm	405mm
Please Request SPB	1400mm	30mm	405mm
Please Request SPB	1600mm	30mm	405mm
Please Request SPB	1800mm	30mm	405mm

Screen Parts

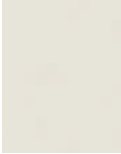
End Strip. (One)	JSCRENCVR405
Screen Posts	JSCRDSBKT30JOS
Top Link	JSCRTLJOS
Bottom Link	JSCRBLJOS

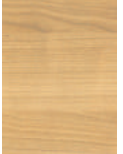





FINISHES





MFC TOPS

								
WHITE MFC WHM	OAK MFC MOK	BEECH MFC MOB	GREY MFC MOG	WALNUT MFC MOW	ROMANO CHERRY MFC RCM	MAPLE MFC MOM	WHITE MFC OAK EDGE WHO	WHITE MFC MULTIPLEX EDGE WHX





STEEL FINISHES

							
BLACK RAL9011 BLS	SILVER RAL9006 JOS	GRAPHITE RAL7024 GGS	PALE GREY RAL7035 PGS	WHITE RAL9016 JWS	ARROW RED RAL3001 ARG	CARMINE RED RAL3002 CRS	DEEP ORANGE RAL2011 ORS

						
ZINC YELLOW RAL1018 ZYS	FERN GREEN RAL6018 FGB	WATER BLUE RAL5021 WBS	SKY BLUE RAL5015 SBB	REGAL BLUE RAL5012 RBS	SIGNAL BLUE RAL5005 SBS	ULTRAMARINE BLUE RAL5002 UBS

			
TAUBEN BLUE RAL5014 TGS	PASTEL TURQ- UOISE RAL6034 PTS	PASTEL MAUVE RAL4009 PMS	KHAKI GREEN RAL6013 KGS

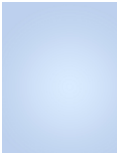
PLEXIGLASS SCREENS (STANDARD)

				
MANDARIN ORANGE 3717	CHILLI RED 4T50	ARCTIC BLUE 7T77	ELECTRIC BLUE 7T69	SAPPHIRE BLUE 7T28

Flexiform's standard aluminium framed screens to be upholstered in Lucia Fabric (Group 2).

Images for illustration only. Please request a sample before ordering.
Call 01274 706206 or email sarahs@flexiform.co.uk.



CYBER
ESSENTIALS

YORKSHIRE HQ

Flexiform
1392 Leeds Road
Bradford
West Yorkshire
BD3 7AE

t: 01274 706206

LONDON

Flexiform
1st Floor
45 Gee Street
London
EC1V 3RS

t: 02033 010436

SCOTLAND

Flexiform
2B Young Square
Brucefield Industry Park
Bellsquarry, Livingston
EH54 9BX

t: 01506 416410

Find us online:



Company Registration Number: 02542123

flexiform

www.flexiform.co.uk