

P.O. Box 405 • 939 West Quincy St.
Lakeland, FL 33802/33815
Phone: 863-688-7998
Fax: 863-683-9749
www.linchutes.com

Valiant Products, Inc.

Trash/Linen Chutes • Tenant Storage Lockers • Recycle Systems

Locker Installation Instructions

Note: Start with walls finished and floors swept clean and clear of debris and install lockers according to diagram provided.

1. Put door frames in area where they will be installed. Open doors to allow them to stand by themselves. Clamp door frames together making sure to keep door frame channel even with the neighboring unit's channel frame. A whole row of door frames can be assembled in this manner. Lockers channel can be bolted together with $\frac{1}{4}$ " bolts and nuts or by using $\frac{3}{4}$ " #10 self-tapping sheet metal screws. We recommend 3-4 fasteners per each side.
2. Bring partitions to assembled door frames. (Note: 2" leg rests on floor surface). Clamp a partition to the back flange of the door channel upright on the inside of the locker, being sure to maintain an even fit along the height of both parts. Fasten the partition to the door frame with self-tapping screws or $\frac{1}{4}$ " bolts and nuts. We recommend using 3-4 fasteners per partition. Partitions can be installed along entire row of assembled door frames in this manner. (Note: the middle cross angle piece should be faced to the inside of the locker.)
3. Secure lockers to floor and wall surfaces by the method best suited for wall and floor construction (free-standing units anchor to floor only). To ensure proper appearance and performance of lockers, doors will be secured to the wall at proper depth of the locker and partitions will be secured at the proper width of the locker while maintaining that both are plumb and square (a carpenter level works well in this step). Also, make sure that lockers measure 90° in the corners.
4. All lockers with backs will be installed after the lockers are assembled and anchored. Fasteners will protrude into the locker, not into that aisle way. When fastening backs to partitions, ensure that partitions are at proper locker width and are square and plumb. (Note: Double tier units, shelves can be used to ensure proper locker width, but should still be measured to maintain proper width).
5. Double tier units, the shelves will sit in the shelf support channel welded to the center of the partition.
6. Lockers with tops: tops are placed on the lockers so that none of the tops will extend over the edges of the units. The tops are made to overlap for added support and ease of installation. Wall angles, with punched holes to bolt exposed metal to, will be provided to support tops that start at a wall surface. Tops are then fastened to the locker surfaces with self-tapping screw or bolts/nuts.

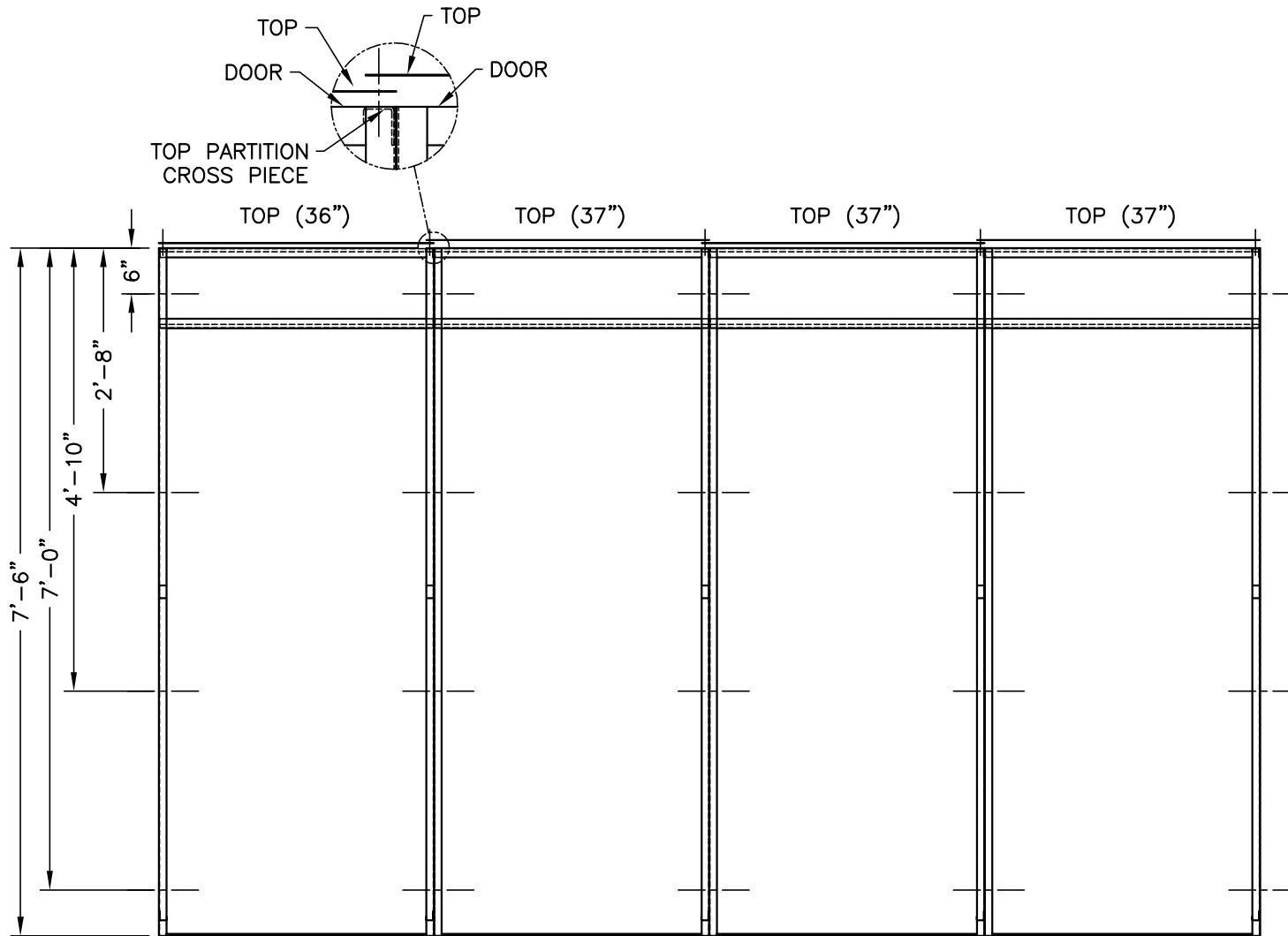

NOTE: 2x2 ANGLE TO BE MOUNTED TO BACK WALL AT SAME HEIGHT AS TOP OF LOCKER.
TOPS ARE SUPPORTED AT THE WALL BY SUPPLIED 2x2 ANGLE.

ELEVATION TOP ATTACHMENT POINTS

SINGLE TIER GANG SHOWN
3'-0" WIDE x 7'-6" HIGH USED FOR EXAMPLE

Valiant Products, Inc.
P.O. Box 405 • Lakeland, FL 33802
PH. (863) 688-7998
FAX (863) 683-9749
LICENSE #CS C033741

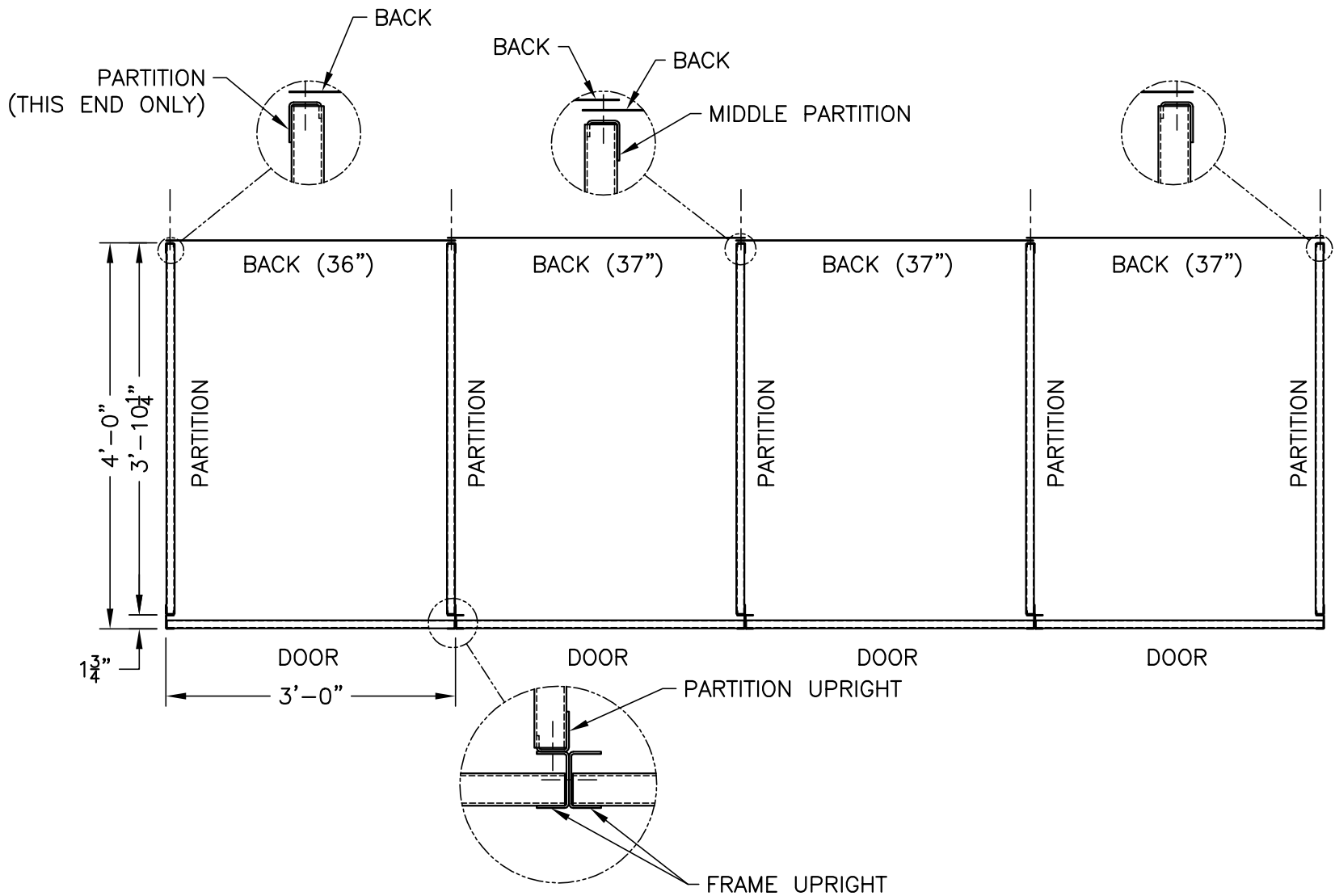

PLAN VIEW ATTACHMENT POINTS

SINGLE TIER GANG SHOWN

3'-0" WIDE x 4'-0" DEEP USED FOR EXAMPLE

Valiant Products, Inc.

P.O. Box 405 • Lakeland, FL 33802

PH. (863) 688-7998

FAX (863) 683-9749

LICENSE #CS C033741

Valiant Products, Inc.
P.O. Box 405 • Lakeland, FL 33802
PH. (863) 688-7998
FAX (863) 683-9749
LICENSE #CS C033741

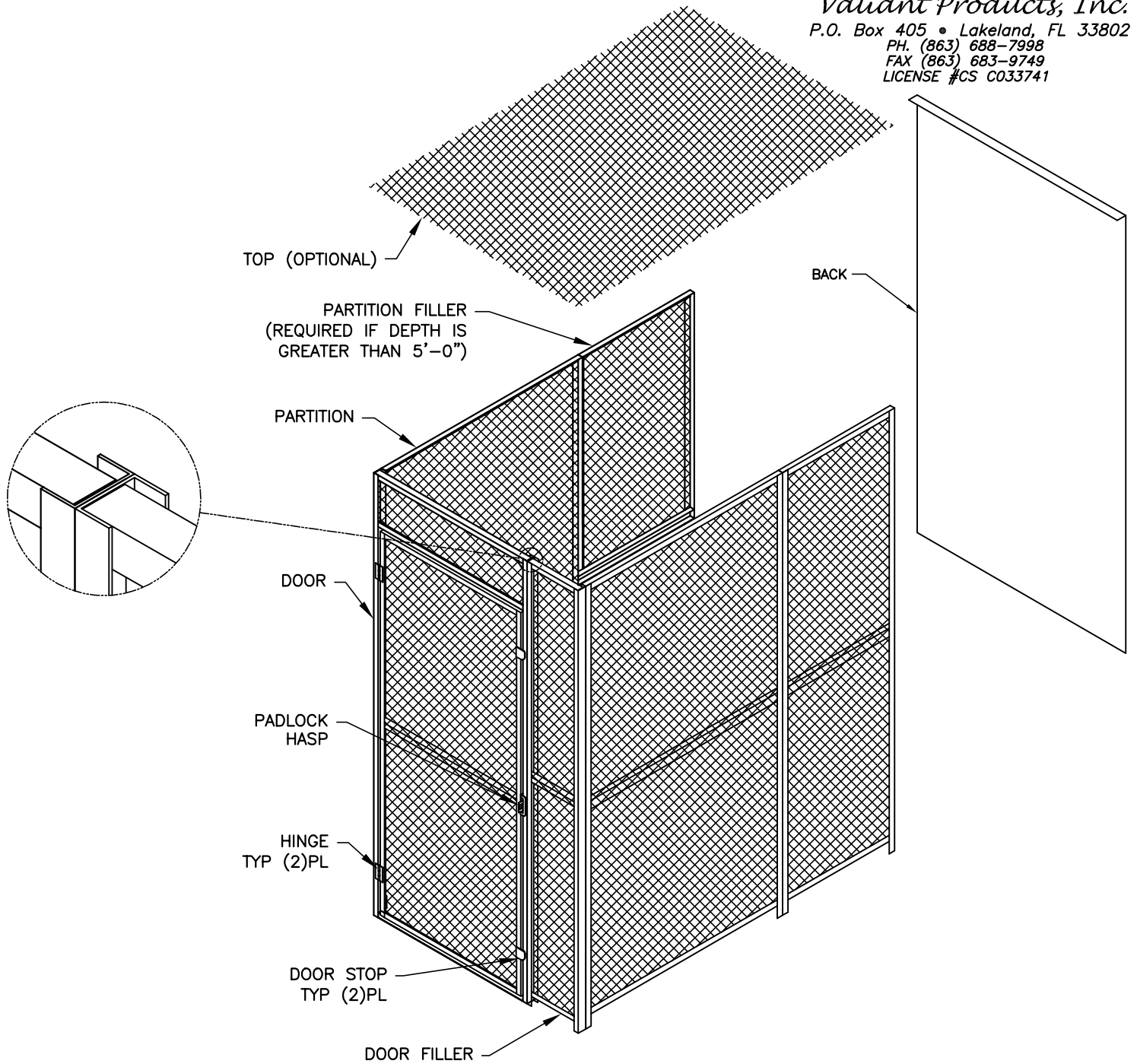

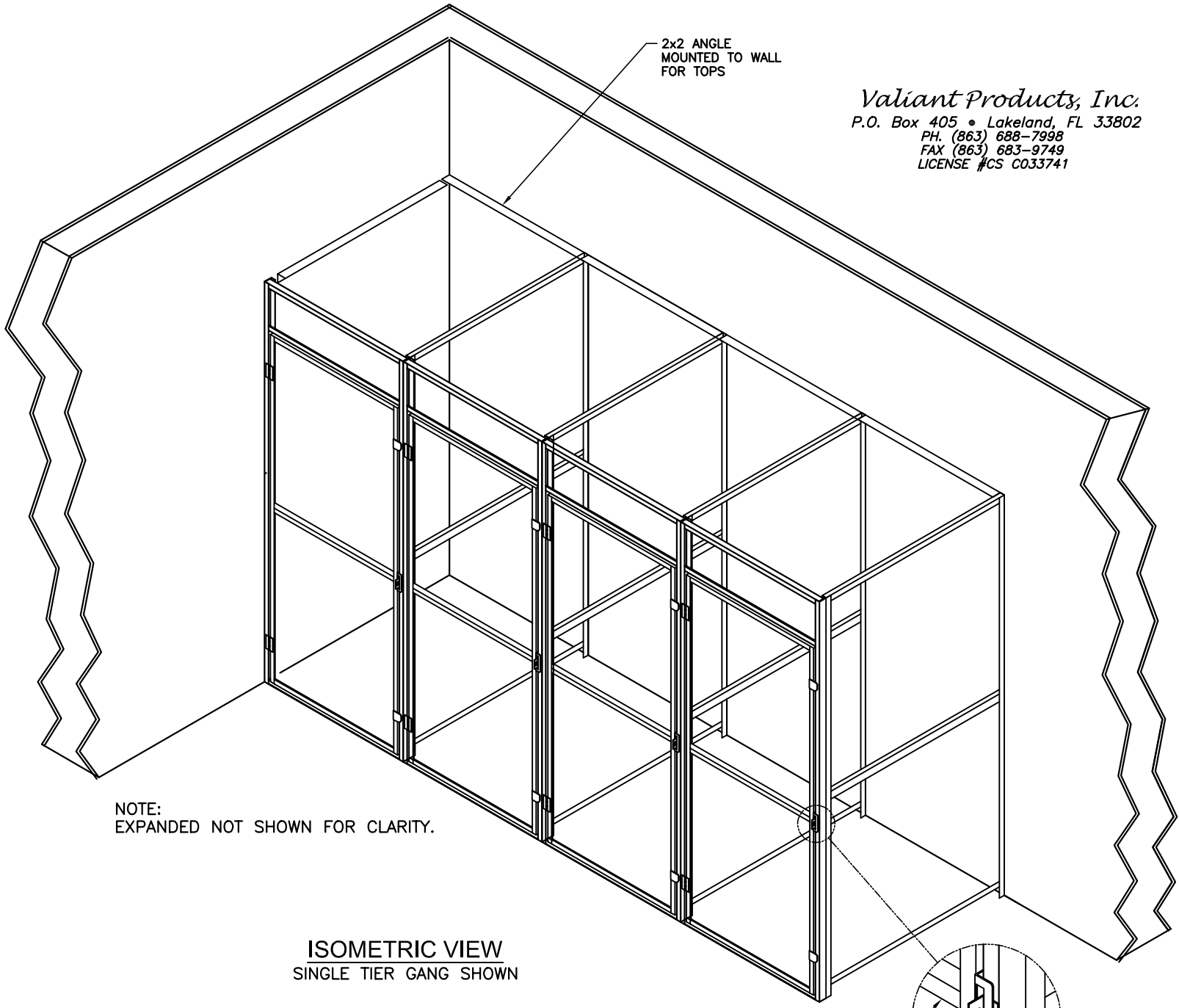

2x2 ANGLE
MOUNTED TO WALL
FOR TOPS

Valiant Products, Inc.
P.O. Box 405 • Lakeland, FL 33802
PH. (863) 688-7998
FAX (863) 683-9749
LICENSE #CS C033741

NOTE:
EXPANDED NOT SHOWN FOR CLARITY.

ISOMETRIC VIEW
SINGLE TIER GANG SHOWN

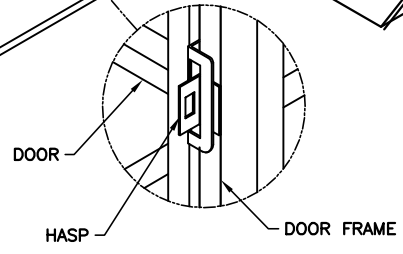

DOOR

HASP

DOOR FRAME

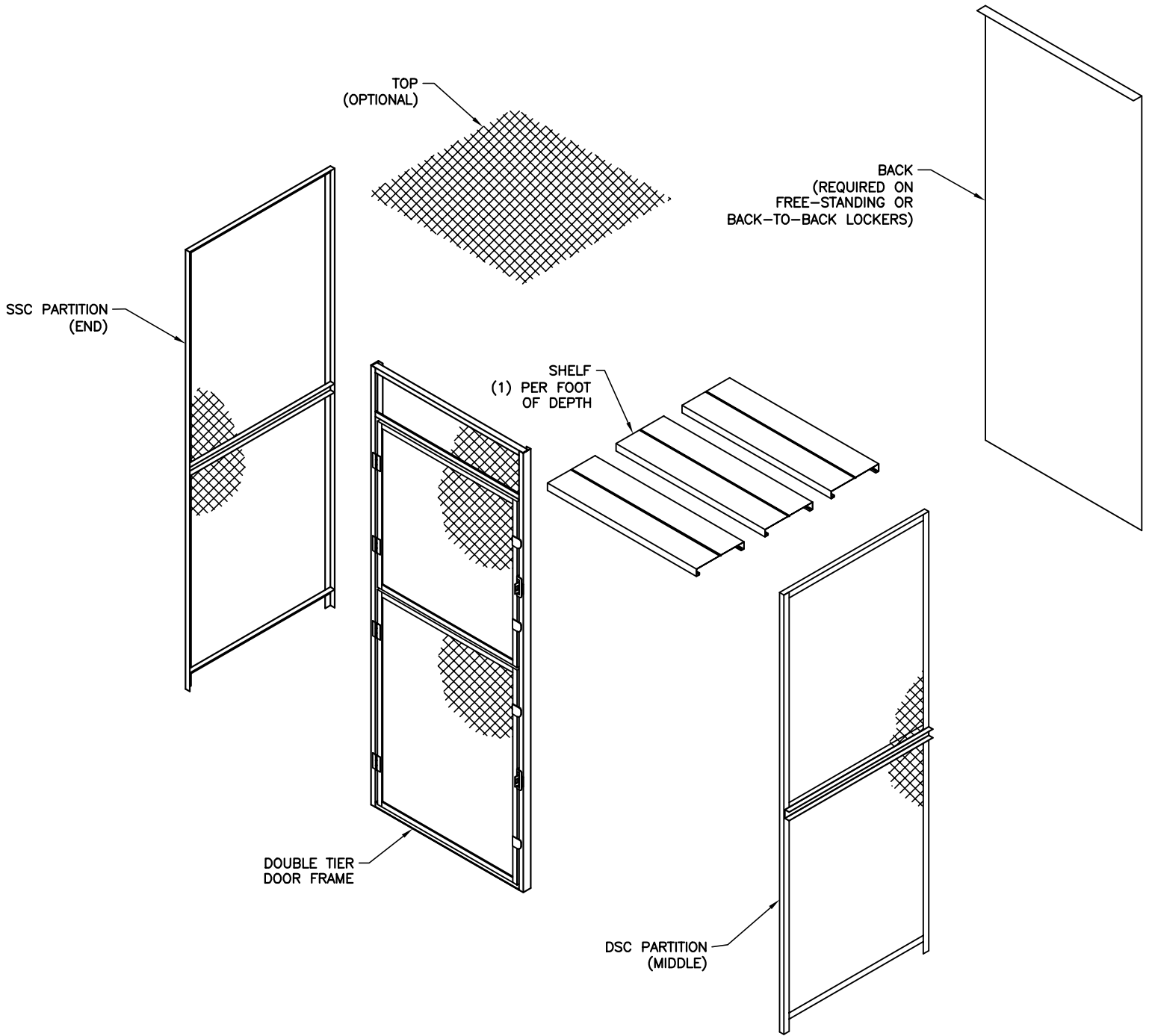

DOUBLE TIER EXPLODED VIEW
 3'-0" WIDE x 3'-0" DEEP USED FOR EXAMPLE

Valiant Products, Inc.
 P.O. Box 405 • Lakeland, FL 33802
 PH. (863) 688-7998
 FAX (863) 683-9749
 LICENSE #CS C033741

Valiant Products, Inc.
P.O. Box 405 • Lakeland, FL 33802
PH. (863) 688-7998
FAX (863) 683-9749
LICENSE #CS C033741

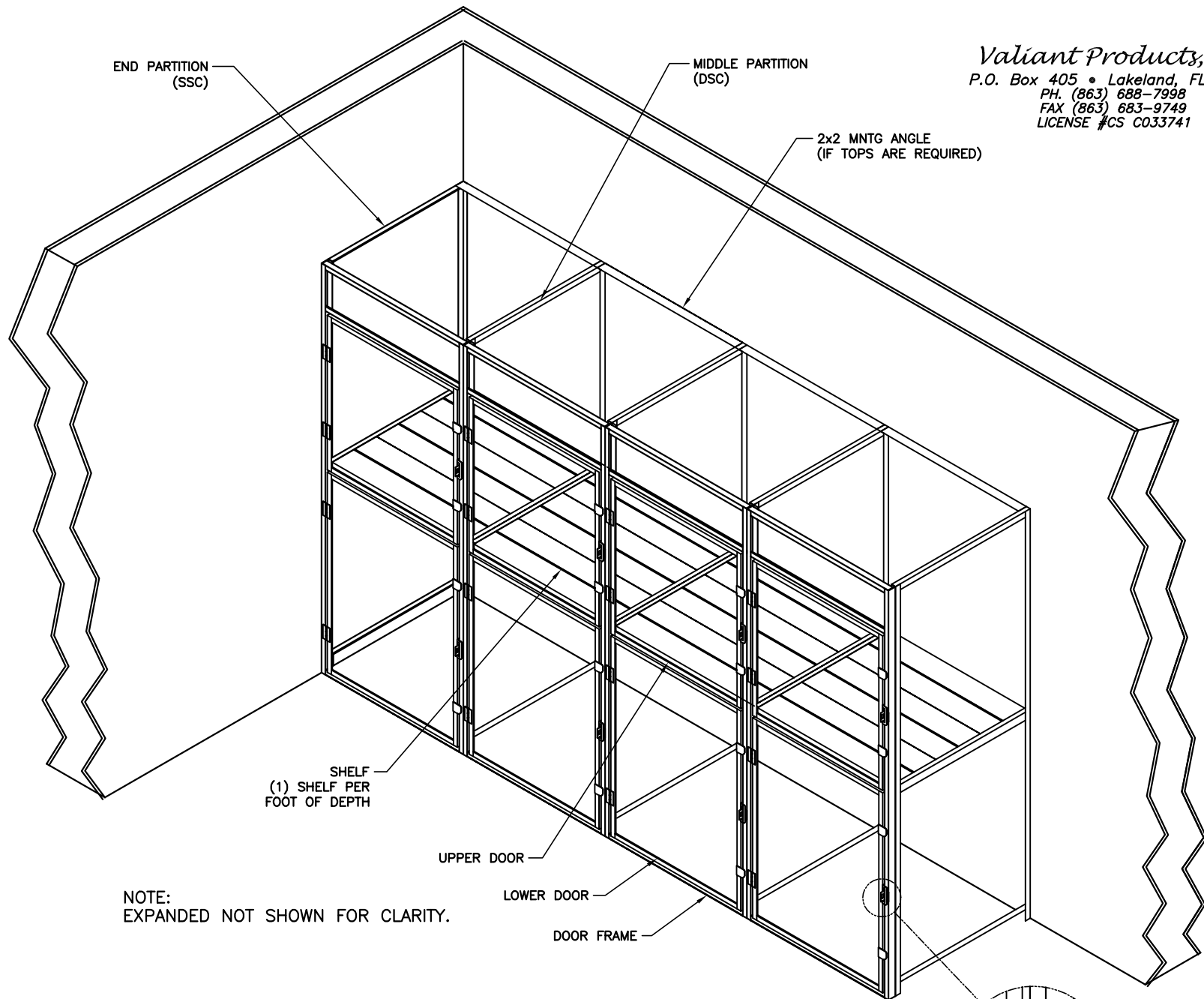

ISOMETRIC VIEW
DOUBLE TIER GANG SHOWN

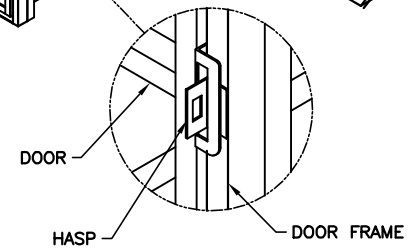

1. TEK-SCREW PARTITION TO BACKSIDE OF CHANNEL TO ADJOINING DOOR FRAME TYP (4)PL

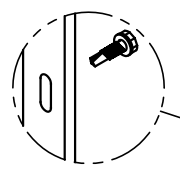

DETAIL
SCALE: 3" = 1'-0"

1. DRILL CONCRETE w/1/4" BIT
2. INSERT 1 1/4" LG. DRIVE PIN
3. HAMMER INTO PLACE

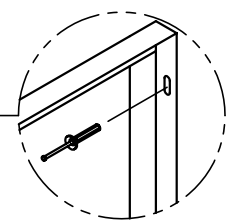

DETAIL
SCALE: 1 1/2" = 1'-0"

DOOR FRAME
(INNER DOOR NOT SHOWN FOR CLARITY)

1. DRILL CONCRETE w/1/4" BIT
2. INSERT 3/4" LG. DRIVE PIN
3. HAMMER INTO PLACE

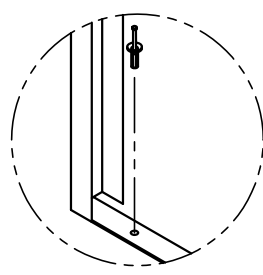

DETAIL
SCALE: 1 1/2" = 1'-0"

FLOOR STRAP

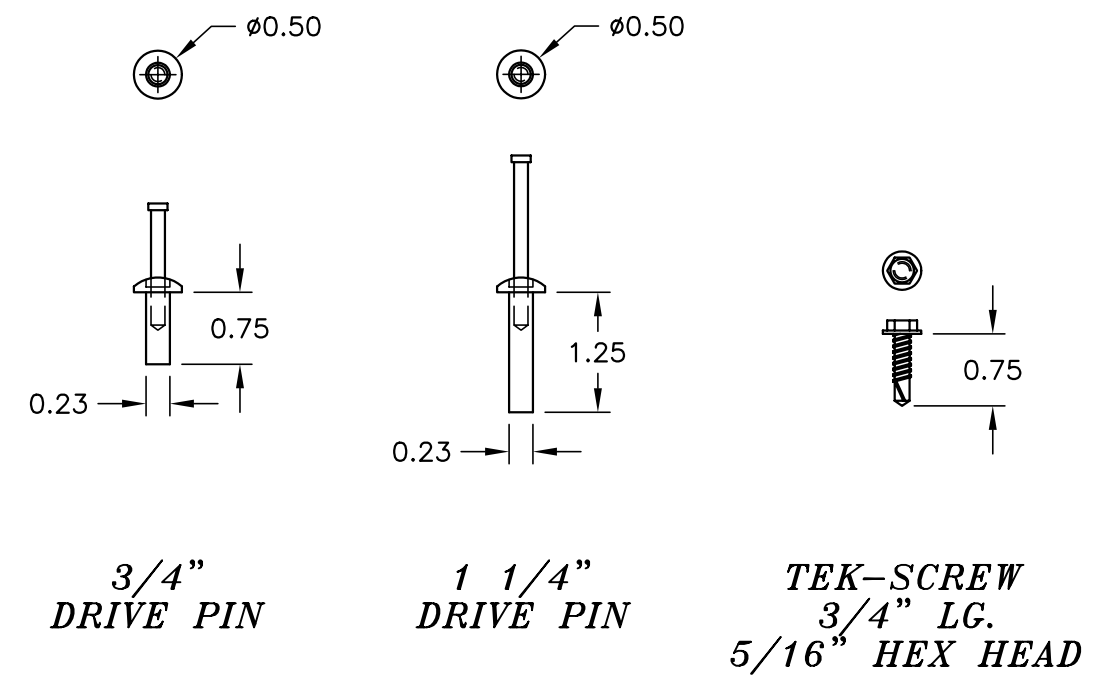

1/2 SIZE DETAILS

Valiant Products, Inc. P.O. Box 405 • Lakeland, FL 33802		PH. (863) 688-7998 FAX (863) 683-9749 LICENSE #CS C033741	
TITLE: STORAGE LOCKER INSTRUCTIONS		PROJECT: DETAIL LOCKER FASTENING DRIVE-PIN	
SIGNATURE	DATE	DRAWING NO.	REV.
DRAWN: SRM	19FEB04		—
CHK'D:			
APV'D:			
SCALE: 3/4" = 1'		DO NOT SCALE DRAWING	
		SHEET 1 of 1	

1. TEK-SCREW PARTITION TO BACKSIDE OF CHANNEL TO ADJOINING DOOR FRAME TYP (4)PL

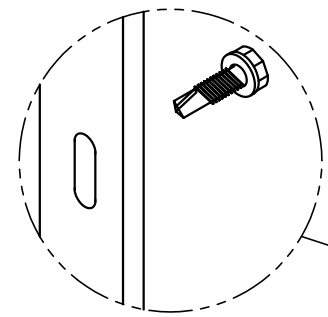

PARTITION

DETAIL

SCALE: 1 1/2" = 1'-0"

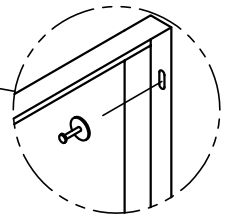

DETAIL

SCALE: 1 1/2" = 1'-0"

NOTE:
 NAILS ARE INSTALLED BY USING A POWDER ACTUATED REMINGTON NAIL GUN USING REMINGTON 22ga LOADS TO EMBED NAIL INTO SURFACE. 2 SHOTS MAY BE REQUIRED TO TOTALLY EMBED NAIL.

DOOR FRAME
 (INNER DOOR NOT SHOWN FOR CLARITY)

1. INSERT NAIL HEAD INTO GUN
2. PUT NAIL POINT INTO HOLE
3. FIRE NAIL GUN

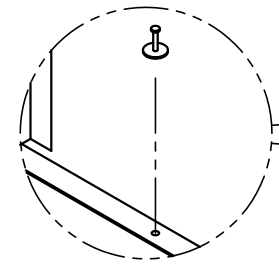

DETAIL

SCALE: 1 1/2" = 1'-0"

FLOOR STRAP

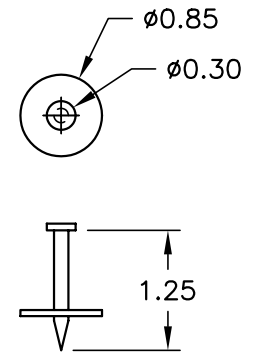

NAIL
 1 1/4" LG.
 w/WASHER

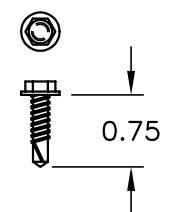

TEK-SCREW
 3/4" LG.
 5/16" HEX HEAD

1/2 SIZE DETAILS

Valiant Products, Inc. P.O. Box 405 • Lakeland, FL 33802		PH. (863) 688-7998 FAX (863) 683-9749 LICENSE #CS C033741	
TITLE: STORAGE LOCKER INSTRUCTIONS		PROJECT: DETAIL LOCKER FASTENING HAMMER NAIL	
SIGNATURE	DATE	DRAWING NO.	REV.
DRAWN: SRM	19FEB04		—
CHK'D:			
APV'D:			
SCALE: 3/4" = 1'		DO NOT SCALE DRAWING	
		SHEET 1 of 1	

TENANT STORAGE LOCKER MAINTENANCE

The Valiant lockers installed in your building have been manufactured and installed to be virtually free from maintenance. Valiant recommends the following to keep your lockers looking and operating like new.

1. **Clean the lockers** – Valiant recommends cleaning your lockers by vacuuming them first to release any built-up dust. Using a bucket of water mixed with a mild detergent, brush or sponge your lockers.
2. **Lubricate the hinges** – Every time after you clean your lockers, or on an annual basis, we recommend lubricating the hinges of your lockers with some type of lubricating spray applied sparingly to each hinge. You may use such products as WD-40®, lithium grease or a teflon spray. Wipe off any excess from the locker after completed.

DIVISION 10 EQUIPMENT

SECTION 10 WIRE MESH PARTITIONS

1. PRODUCTS

1.1. MANUFACTURERS:

- 1.1.1. Design is based on use of all steel ventilated Tenant Storage Lockers as provided by Valiant Products, Inc., P.O. Box 405, Lakeland, FL 33802, 800-659-1797, and the terminology used may include reference to that manufacturer's proprietary products. Such reference shall be construed only as establishing the quality of materials and workmanship to be used under this Section and shall not, in any way, be construed as limiting competition.
- 1.1.2. Product shall be those upon which design is based, or shall be equal products approved in advance by the Architect.

1.2. MATERIALS:

- 1.2.1. Steel Channel and Angle: Roll-formed from 14ga cold-rolled, pickled and oiled conforming to ASTM 1008/A 1008M-00
- 1.2.2. Expanded Metal: 1 ½ No. 13 (14ga) flattened expanded metal with a 75% open area and conforms to military specification MIL-M-17194C Type II Class 1.
- 1.2.3. Door Stops and Padlock Hasps: Fabricated from 12ga flat bar conforming to ASTM A36.
- 1.2.4. Hinges: To be 2 x 2 tight pin butt hinges conforming to ASTM A36.
- 1.2.5. Steel Sheet: 22ga galvanized paint-grip that conforms to ASTM A 653/A 653M-02a with a Z180 coating.
- 1.2.6. Steel Coil: 22ga steel that conforms to ASTM 1011/A A 1011M-00
- 1.2.7. Finish: To be "No-mar" polyester powder coat. Color to be machinery gray unless otherwise indicated. Optional colors are ivy green, sandalwood tan and jet black.

1.3. COMPONENTS:

- 1.3.1. **Doors:** Framed with 1" x 1 ¾" x 1" formed 14 gauge steel channel with 1 ½ No. 13 (14ga) flattened expanded metal panels.
- 1.3.2. **Partitions:** Framed with 1" x 1 ¼" formed 14 gauge steel angle with 1 ½ No. 13 (14ga) flattened expanded metal panels.
- 1.3.3. **Hardware:** Doors to be pre-hung in frames with transom and equipped with 2" x 2" steel tight pin butt hinges, door stops and padlock hasp, welded into position.
- 1.3.4. **Backs:** 22ga galvanized steel with a 2" break at the top for securing to top of unit, to be 1" shorter than the height of the unit for floor clearance. (Required on back-to-back runs and free-standing units)
- 1.3.5. **Tops:** 1 ½ No. 13 (14ga) flattened expanded metal cut to size of unit for securing to top of unit. (Recommended when ceiling height exceeds 8'-6")
- 1.3.6. **Shelves:** Roll-formed from 22ga coil with stiffening ribs for extra strength and rigidity.
- 1.3.7. **Unit Size:** See the drawings for unit sizes required.

1.4. GUARANTY:

- 1.4.1. The lockers shall conform to all applicable building codes and be manufactured in accordance with the best practices of the industry. Material and workmanship are to be guaranteed against defects for a period of one (1) year after delivery, other than that caused by normal wear and tear.

2. EXECUTION

2.1. Preparation, Installation, Adjusting and Cleaning

- 2.1.1. **Preparation:** Coordinate and furnish anchorages, setting drawings, diagrams, templates, instructions and directions for installaing anchorages, including inserts, sleeves, anchors and miscellaneous items having integral anchors embedded in wall and floor finish. Coordinatate delivery of such items to Project site.
- 2.1.2. **Installation:** Erect partitions plumb, rigid, properly aligned and securely fastened in place complying with Manufacturer's recommendations. Provide additional field bracing as required for rigid, secure installation.
- 2.1.3. **Adjusting and Cleaning:** Upon completion of the installation, adjust components for smooth operation without binding. Leave work in complete and proper operating condition. Remove and replace defective work. Touch up damaged finish after completing installation using field-applied paint to match color of shop-applied finish.

END OF SECTION