



Harrier 48 Autodrive VS ES IS

CODE476A OPERATOR MANUAL

Original Version (EN)
Issued: 28/01/2019

From Serial Number: 404000000 and Up
Part number: 3428-780 Rev B

CONTENTS

Introduction	5
Safety	6 - 9
General Safety	6
Safety Alert Symbol	6
Before Operation Safety	6 - 7
- General Safety	6
- Fuel Safety	7
During Operation Safety	7 - 8
- General Safety	7
- Slope Safety	8
After Operation Safety	8 - 9
- General Safety	8
Operation Safety	8
- Hauling Safety	8
Maintenance Safety	8
Changing the Battery Pack Safety	8
Safety & Instructional Decals	9
Product Overview	10
Product Specification	10
Setup	11 - 12
Delivery Checklist	11
Assembling and Unfolding the Handle	11
Grass Bag Assembly	11
Prevent Engine Damage	11
Engine Detail	12
Filling the Engine with Oil	12
Engine Oil Specifications	12
First Time Battery Charging	12
Before Operation	13 - 15
Fuel Type & Filling the Tank	13
Checking the Engine-Oil Level	13

Before Operation continued	
Adjusting the Cutting Height	14
Non Grassed Areas	14
Controls	14
Before Mowing	14
Battery Specification	15
Battery Charge Gauge	15
When to Charge the Battery Pack	15
How to Charge the Battery Pack	15
During Operation	16 - 17
Electric Start	16
Forward Travel	16
Shutting off the Engine	16
Parking	16
Turning	16
Trim Side Cutting	16
Vari-Pitch™ Cutting Technology	17
Heavy Growth	17
Grass Bag	17
Mowing without the Grass Bag	17
Friction Disc	17
After Operation	18
Cleaning the Mower	18
Folding the Handle	18
Maintenance Schedule	19
Maintenance	20 - 24
Preparing for Maintenance	20
Air Filter Service	20
Changing the Engine Oil	21
Servicing the Spark Plug	21
Remove & Replace the Blade	22

CONTENTS

Maintenance continued	
Blade Sharpening	2
Clutch Cable Adjustment	23
Securing Nuts & Bolts	23
Rear Deflector	23
Carburetor Adjustments	23
Blade Brake Test	23
Lubrication	24
Battery Disposal Directive	24
Lithium-Ion Battery Pack Disposal	24
Storage	25 - 26
Storage Safety	25
Preparing the Mower for Storage	25
Storage	25
Battery Pack & Charger Storage	25
Removing the Mower from Storage	26
Trouble Shooting	27
Warranty	28
EU Privacy Statement	29
Notes	29 - 32

INTRODUCTION

Thank you for purchasing a Hayter mower.

The following pages are designed to help you gain safe and efficient service from your mower.

This rotary-blade, walk-behind lawn mower is intended to be used by residential homeowners. It is designed primarily for cutting grass on well-maintained lawns on residential properties. Using this product for purposes other than its intended use could prove dangerous to you and bystanders.

This operator's manual should be regarded as part of the mower as it gives essential information regarding safety, operation, maintenance and specifications. If you misplace your operator's manual, contact your local Authorised Hayter Service Dealer for a replacement. Alternatively, visit www.hayter.co.uk/handbooks to download an electronic version.

To ensure maximum safety, best performance, and to gain knowledge of the mower, it is essential that you and any other operator read and understand the contents of this operator manual before the engine is started. If you are unsure of any procedure detailed in this operator manual then please contact your local Authorised Hayter Service Dealer for assistance.

Throughout this operator manual all references to left and right are as viewed from behind the handle, in the direction of forward travel.

For engine details related to your product, please refer to the engine handbook provided.

Hayter Limited have designed and tested this mower for reasonably safe service; however, failure to comply with the instructions in this operator manual may result in personal injury.

This mower is designed solely for use in a domestic grass cutting environment. Use in any other way is considered as contrary to the intended use.

Hayter Limited reserves the right to amend product specifications without prior notification.

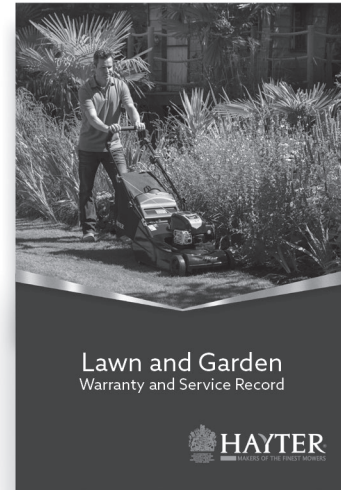

KEEP IT SAFE

You will find

- » Annual service record
- » Helpful lawnmower maintenance tips
- » Range of lawnmower accessories

If you did not receive a copy when you purchased your lawnmower, please contact your supplying dealer.

SAFETY

General Safety

This mower has been designed in accordance with EN ISO 5395-2:2017.

This product is capable of amputating hands and feet and of throwing objects. Always follow all safety instructions to avoid serious personal injury.

- Read, understand and follow the instructions and warnings in this Operator's Manual, on the mower and attachments before starting the engine.
- Use your full attention while operating the mower. Do not engage in any activity that causes distractions; otherwise, injury or property damage may occur.
- Do not put your hands or feet near moving parts of or under the mower. Keep clear of any discharge opening.
- Do not operate the mower without all guards and other safety protective devices in place and working on the mower.
- Keep bystanders and children out of the operating area. Do not allow children to operate the mower. Allow only people who are responsible, trained, familiar with the instructions, and physically capable to operate the mower.
- Stop the mower, shut off the engine, wait for all moving parts to stop and remove the electric start button before servicing, fuelling, or unclogging the mower.

Improperly using or maintaining this mower can result in injury. To reduce the potential for injury, comply with these safety instructions and always pay attention to the safety-alert symbol, which means Caution, Warning, or Danger - personal safety instruction.

Failure to comply with these instructions may result in personal injury or death.

You can find additional safety information where needed throughout this manual.

Safety Alert Symbol

This safety alert symbol indicates important safety messages. When you see this symbol be alert to the possibility of injury. Carefully read the following and inform others.

Failure to observe the following precautions may result in serious injury.

Before Operation Safety - General Safety

- **Always shut off the engine. Wait for all movement to stop, remove the electric start button and allow the mower to cool before adjusting, cleaning, storing or repairing it.**
- **Become familiar with the safe operation of the equipment, operator controls, and safety signs.**
- **Check that all guards and safety devices, such as deflectors and/or grass bag, are in place and working properly.**
- **Always inspect the mower to ensure that the blades, blade bolts, and cutting assembly are not worn or damaged.**
- **Inspect the area where you will use the mower and remove all objects that could interfere with the operation of the mower or that the mower could throw.**
- **Adjusting the cutting height may bring you into**

contact with the moving blade, causing serious injury.

- Shut off the engine, wait for all moving parts to stop and remove the electric start button.
- Do not put your fingers under the housing when adjusting the cutting height.

SAFETY

Before Operation Safety - Fuel Safety

Fuel is extremely flammable and highly explosive. A fire or explosion from fuel can burn you and others and can damage property.

- **To prevent a static charge from igniting the fuel, place the container and/or mower directly on the ground before filling, not in a vehicle or on an object.**
- **Fill the fuel tank outdoors, in an open area, when the engine is cold. Wipe up any fuel that spills.**
- **Do not handle fuel when smoking or around an open flame or sparks.**
- **Do not remove the fuel cap or add fuel to the tank while the engine is running or hot.**
- **If you spill fuel, do not attempt to start the engine. Avoid creating a source of ignition until the fuel vapours have dissipated.**
- **Store fuel in an approved container and keep it out of the reach of children.**

Fuel is harmful or fatal if swallowed. Long-term exposure to vapours can cause serious injury and illness.

- **Avoid prolonged breathing of vapours.**
- **Keep your hands and face away from the nozzle and the fuel-tank opening.**
- **Keep fuel away from your eyes and skin.**

During Operation Safety - General Safety

- Wear appropriate clothing, including eye protection; long trousers, slip-resistant, substantial

footwear; and hearing protection. Tie back long hair, secure loose clothing, and do not wear loose jewellery.

- Do not operate the mower while ill, tired, or under the influence of alcohol or drugs.
- The blade is sharp; contacting the blade can result in serious personal injury. Shut off the engine, wait for all moving parts to stop and remove the electric start button before leaving the operating position.
- When you release the engine stop lever, the engine should shut off and the blade should stop within 3 seconds. If not, stop using your mower immediately and contact a Hayter Authorised Service Dealer.
- Keep bystanders, especially small children, out of the operating area. Stop the mower if anyone enters the area.
- Always look down and behind you before moving the mower in reverse.
- Operate the mower only in good visibility and appropriate weather conditions. Do not operate the mower when there is the risk of lightning.
- Wet grass or leaves can cause serious injury if you slip and contact the blade. Avoid mowing in wet conditions.
- Watch for holes, ruts, bumps, rocks, or other hidden objects. Uneven terrain could cause the mower to overturn or cause you to lose your balance or footing.
- Use extreme care when approaching blind corners, shrubs, trees, or other objects that may block your view.
- Before leaving the operating position, shut off the engine, wait for all moving parts to stop and remove the electric start button.

- If the engine has been running the muffler will be hot and can severely burn you. Keep away from the hot muffler.
- If the mower strikes an object or starts to vibrate, immediately shut off the engine, wait for all moving parts to stop, remove the electric start button and disconnect the lead from the spark plug before examining the mower for damage. Make all necessary repairs before resuming operation.
- Check the grass bag components and the discharge chute frequently for any wear or deterioration and replace them with the manufacturer's recommended parts when necessary.
- Use accessories and attachments approved by Hayter Limited only.

During Operation Safety - Slope Safety



- Mow across the face of slopes; never up and down. Use extreme caution when changing direction on slopes.
- Do not mow on excessively steep slopes. Poor footing could cause a slip-and-fall accident.
- Mow with caution near drop-offs, ditches, or embankments.

SAFETY

After Operation Safety - General Safety

- Remove the electric start button when the mower is not in use.
- Clean grass and debris from the mower to help prevent fires. Clean up oil or fuel spills.
- Allow the engine to cool before storing the mower in any enclosure.
- Never store the mower or fuel container where there is an open flame, spark, or pilot light, such as on a water heater or on other appliances.

Operation Safety - Hauling Safety

- Remove the electric start button before loading the mower for hauling.
- Use care when loading or unloading the mower.
- Secure the mower from rolling.

Maintenance Safety

- Disconnect the spark plug lead from the spark plug and remove the electric start button before performing any maintenance procedure.
- Wear gloves and eye protection when servicing the mower.
- The blade is sharp; contacting the blade can result in serious personal injury. Wear gloves when servicing the blade.
- Never tamper with safety devices. Check their proper operation regularly.
- Tipping the mower may cause the fuel to leak.
- Fuel is flammable and explosive, and can cause

personal injury. Run the engine dry or remove the fuel with a hand pump; never siphon the fuel.

- To ensure optimum performance and continued safety certification of the mower, use only genuine Hayter replacement parts and accessories.
- Replacement parts and accessories made by other manufacturers could be dangerous, and such use could void the product warranty.

Charging the Battery Pack Safety

WARNING: Improper use of the battery and charger can result in an electrical shock, fire or explosion which can cause severe burns.

Remove the electric start button and battery pack from the engine battery tray before performing any maintenance.

Keep the battery pack and charger dry. Do not expose the battery pack to rain or wet conditions.

To reduce the risk of electrical shock, do not allow water to flow into the AC plug.

Do not short circuit; never place any object into the battery contacts.

Only charge Briggs & Stratton battery pack with the Briggs & Stratton battery charger.

Do not use Briggs & Stratton battery charger to charge any other types of batteries.

To reduce risk of damage to electric plug and cord, pull by plug rather than cord when disconnecting charger.

- An extension cord should not be used unless absolutely necessary. Use of improper extension cord could result in a risk of fire and electric shock.

If an extension cord must be used, make sure:

1. That pins on plug of extension cord are the same number, size, and shape as those of plug on charger;
 2. That the extension cord is properly wired and in good electrical condition; and
 3. That the cable is a minimum capacity of 3 amps.
- Do not operate charger with damaged plug or cord. The supply cord cannot be replaced. If the cord is damaged, the charger should be replaced immediately.
 - Do not operate charger if it has received a sharp blow, been dropped, or otherwise damaged in any way. If charger is damaged it must be replaced. Charger is not serviceable.
 - Do not disassemble charger; or attempt to service.
 - To reduce risk of electric shock, unplug charger from outlet before cleaning.
 - Do not short circuit; never place any object into the battery contacts.
 - The charger is not intended for use by persons (including children) with reduced physical, sensory or mental capabilities, or lack of experience and knowledge, unless they have been given supervision or instruction concerning use of the appliance by a person responsible for their safety.
 - Children should be supervised to ensure that they do not play with the charger.

SAFETY

Please ensure all Safety Decals are secured on the mower before using the product.
If any of the decals are missing or not secure, do not use the mower, contact your Authorised Hayter Service Dealer for replacements.

WARNING: Improper maintenance, use of non-conforming spare parts, or the removal or modification of the Safety Decals may cause death or serious injury.



Engine Stop

Moulded onto engine stop lever



Variable Speed Control

Printed on control



Engine Start

Moulded onto electric start button

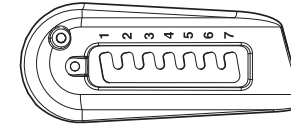

Height of Cut

Moulded in top cover



Easy Wash Port™

Located on top cover

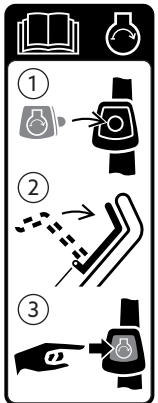

Read the Operator's Manual for more information on starting the engine.

1. Insert the electric start button into the ignition;
2. Engage the engine stop lever;
3. Push the electric start button to start the engine.

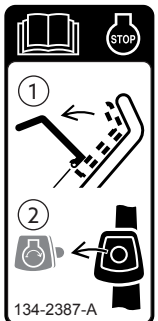

Read the Operator's Manual for more information on stopping the engine.

1. Disengage the engine stop lever.
2. Remove the electric start button from the ignition.

134-2387-A

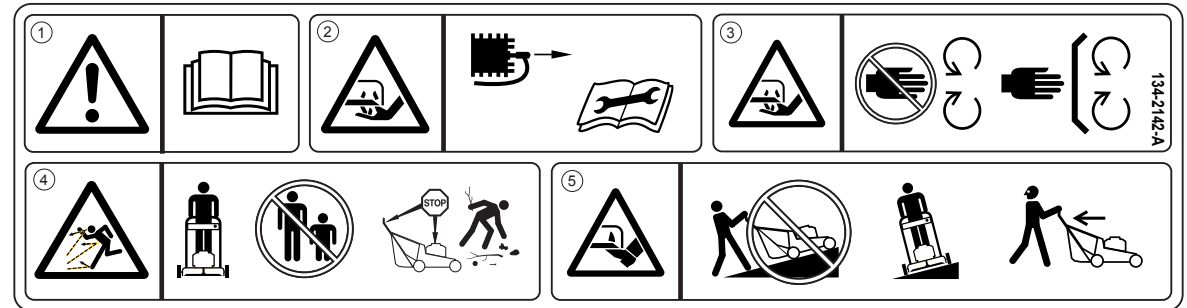

1. WARNING - Read Operator's Manual
2. Cutting/dismemberment hazard of hand, mower blade - disconnect the spark plug lead and remove the electric start button, read the instructions before servicing or performing maintenance.
3. Cutting/dismemberment hazard of hand, mower blade - stay away from moving parts; keep all guards and shields in place.
4. Thrown object hazard - keep bystanders out of the operating area of the mower and retrieve objects before resuming.
5. Cutting/dismemberment hazard of foot, mower blade - do not operate up and down slopes; operate side to side on slopes; look behind you when backing up.

PRODUCT OVERVIEW

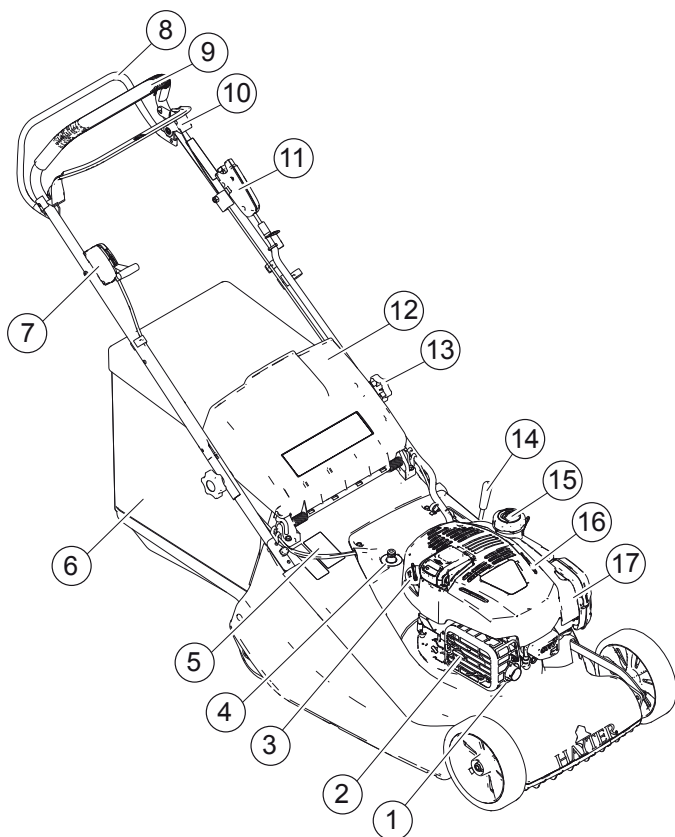

- | | |
|------------------------------|------------------------------|
| 1. Spark Plug and Lead | 10. Engine Stop Lever |
| 2. Exhaust Guard | 11. Electric Start Button |
| 3. Oil Fill and Dipstick | 12. Rear Deflector |
| 4. Easy Wash Port™ | 13. Handle Securing Knob (2) |
| 5. Serial Number Label | 14. Height of Cut Lever |
| 6. Grass Bag Assembly | 15. Fuel Tank and Cap |
| 7. Variable Speed Control | 16. Engine Cover |
| 8. Ground Drive Clutch Lever | 17. Air Filter |
| 9. Handle | |

PRODUCT SPECIFICATION

Code	476A
Model	Harrier 48 Autodrive VS ES IS
Weight (Net)	43.8 kg
Length	1562 mm
Width	532 mm
Height	1039 mm
Width of Cut	480 mm
Height of Cut	13 - 60 mm
Engine	Briggs & Stratton®
Engine Type	675EX InStart™
Engine Power Rating (Net)	2.61 kW
Fuel Type*	Unleaded fuel
Fuel Capacity	1 litre
Oil Type	SAE 30 engine oil
Oil Sump Capacity	0.45 litres

* A minimum of 87 octane / 87 AKI (91 RON).

* Fuel with up to 10% ethanol is acceptable.

* Do not use unapproved fuels, such as E15 and E85

SETUP

IMPORTANT: Remove and discard the protective plastic sheet that covers the engine and any other plastic or wrapping on the mower.

IMPORTANT: To prevent accidental starting, do not insert the electric start button into the electric start ignition until you are ready to start the engine.

Note: The battery will arrive in 'sleep mode'. Refer to Before operation - When to charge the Battery & How to Charge the Battery for charging instructions.

Delivery Checklist

Check that the following items have been supplied correctly.

1. Engine Handbook
2. Grass Bag Assembly
3. Parts List
4. Declaration of Conformity
5. Battery
6. Battery Charger

If any items are missing, contact your supplying Hayter dealer.

To prevent accidents cut off the long ribbon attached to the grassbag and discard.
(Refer fig.1)

Assembling and Unfolding the Handle

WARNING: Assembling and unfolding the handle improperly can damage the cables, causing an unsafe operating condition.

- Do not damage the cables when assembling and unfolding the handle.
- Ensure that the cables are routed inside of the handle.
- If a cable is damaged, contact a Hayter Authorised Service Dealer.

Unscrew the hand bolts sufficiently to allow the handle to pivot. Hold the engine stop lever in towards the handle and unfold the handle to the operating position, then release. Tighten both hand bolts to secure in position.
(Refer fig.2)

Grass Bag Assembly

Before first use, assemble the grass bag and frame. Slide the frame (1) into the grass bag (2), ensuring that the handle is above the grass bag as shown. Attach plastic clips (A) to the grass bag frame.
(Refer fig.3)

Raise the rear deflector, lower the grass bag and hook into position. Lower the deflector to rest on the grass bag.

Prevent Engine Damage

To prevent engine damage the engine is shipped without oil or fuel. The engine must be filled with the correct grade of oil and fuel before starting the engine.

Fig. 1



Fig. 2

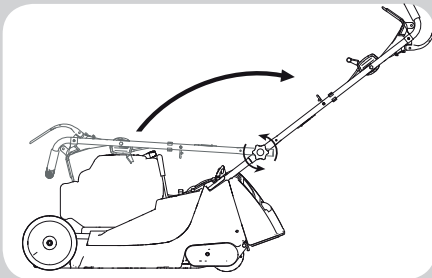
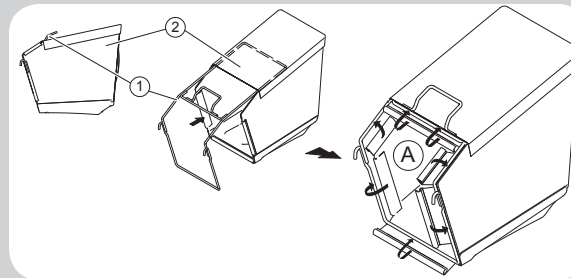

Fig. 3



SETUP

Engine Detail

NOTE: Disconnect the spark plug lead and remove the electric start button before performing any maintenance procedures.

WARNING: Improper maintenance, use of non-conforming replacement components, or the removal or modification of the engine may cause serious injury or death.

(Refer to fig 4)

Filling the Engine with Oil

IMPORTANT: Your mower does not come with oil in the engine. Before starting the engine, fill the engine with oil.

1. Move the mower to a level surface.
2. Remove the dipstick (1) by rotating the cap counterclockwise and pulling it out.
3. Slowly pour oil into the engine oil fill tube (3). Do not overfill. After adding oil, wait one minute and then check the oil level.
4. Insert and tighten the dipstick (1).
5. Remove the dipstick and check the oil level. Check

that the oil level is at the top of the full indicator (2) on the dipstick.

- If the oil level on the dipstick is too low, carefully pour a small amount of oil into the oil fill tube, wait 1 minute, and repeat steps 3 through to 5 until the oil on the dipstick is at the correct level.
- If the oil level on the dipstick is too high, drain the excess oil until the oil on the dipstick is at the correct level; refer to Oil Service.

6. Insert and tighten the dipstick securely.

(Refer fig.5)

IMPORTANT: If the oil level in the engine is too low or too high and you run the engine, you may damage the engine.

Engine Oil Specifications

Engine Oil Capacity	0.44 L (15 fl oz)
Oil viscosity	SAE 30 or SAE 10W-30 detergent oil
API service classification	SJ or higher if classified for service

First Time Battery Charging

Remove the terminal strip from the battery before inserting into the charger for the first time.

The battery requires a ten (10) second wake up before being fully charged. Refer to Before Operation - How to Charge the Battery Pack for further information on how to perform this operation.

Fig. 4

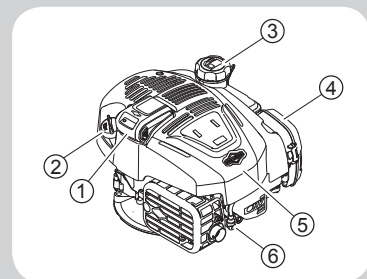

1.	Lithium-Ion Battery
2.	Oil Filler & Dipstick
3.	Fuel Tank & Filler Cap
4.	Air Filter
5.	Engine Cover
6.	Spark Plug And Lead

Fig. 5

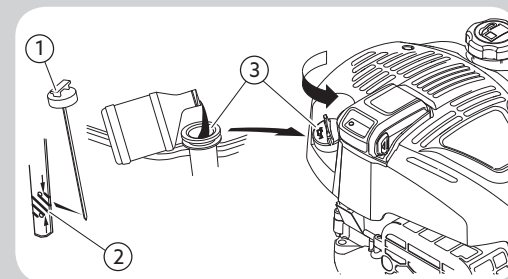

BEFORE OPERATION

Fuel Type & Filling the Tank

WARNING: Do not use unapproved fuels, such as E15 and E85. Do not mix oil in fuel or modify the engine to run on alternate fuels. Use of unapproved fuels will damage the engine components, which will not be covered under warranty.

IMPORTANT: To reduce starting problems, add fuel treatment (111-9368) to the fuel all season, mixing it with fuel less than 30 days old.

Fuel stabiliser and engine oil are both available to purchase from your Authorised Hayter Service Dealer.
111-9367 - Lawnmower Oil SAE 30 Hayter
111-9368 - Premium Fuel Treatment Hayter

Fuel must meet these requirements:

- Clean, fresh, unleaded.
- A minimum of 87 octane.
- Fuel with up to 10% ethanol is acceptable.

When adding fuel:

- Turn engine off and let engine cool at least 2 minutes before removing the fuel cap.
- Fill fuel tank outdoors or in well-ventilated area.

- Keep fuel away from sparks, open flames, pilot lights, heat, and other ignition sources.
- Check fuel lines, tank, cap, and fittings frequently for cracks or leaks. Replace if necessary.
- If fuel spills, wait until it evaporates before starting engine.

1. Clean the fuel cap area of dirt and debris. Remove the fuel cap.
2. Fill the fuel tank with fuel. To allow for expansion of the fuel, do not fill above the bottom of the fuel tank neck.
3. Reinstall the fuel cap.

(Refer fig.6)

Checking the Engine-Oil Level

Refer to Setup - Engine Oil Specifications to ensure you are using the correct grade of oil.

IMPORTANT: If the oil level in the engine is too low or too high and you run the engine, you may damage the engine.

Before adding or checking the oil, ensure the engine is level and the oil fill area is clear of debris.

To add oil:

1. Remove the dipstick (1) from the oil fill tube (3) and wipe with a clean cloth.
2. Insert back into the oil fill tube (3) and tighten the dipstick (1).
3. Remove the dipstick (1) and check the oil level. Check that the oil level is at the top of the full indicator (2) on the dipstick (1).
4. Re-insert the dipstick (1) into the oil fill tube (3) and tighten securely.

(Refer fig.7)

Fig. 6



Fig. 7

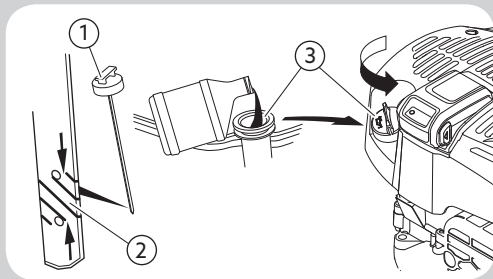

BEFORE OPERATION

Adjusting the Cutting Height

WARNING: Adjusting the cutting height may bring you into contact with the moving blade, causing serious injury.

- Shut off the engine, wait for all moving parts to stop and remove the electric start button.
- Do not put your fingers under the deck housing when adjusting the cutting height.

There are 7 cutting-height settings from 13 to 60mm.

To change the cutting height, hold the lever and pull it sideways to disengage it from the locking notch.

- Pull the lever backwards to raise the cutting height
- Push the lever forwards to lower the cutting height.

Finally release the lever at the required position and ensure it locks firmly into one of the setting notches. Always select a cutting height to suit the operating conditions. Prevent engine overload and blockages by avoiding low cuts in long grass. Be prepared to make two cuts when the grass is long. (Refer fig.8)

Non Grassed Areas

When moving the mower across non-grassed areas, stop the engine and set the mower to the maximum height of cut to protect the cutting mechanism. (Refer fig.8)

Controls

WARNING: Improper maintenance, use of non-conforming replacement components, or the removal or modification of the control cable(s) may cause serious injury or death.

IMPORTANT: To avoid damage to the cable, the variable speed control should only be operated whilst the engine is running.

Operate all control levers several times and ensure that the cables move freely. Check that the engine stop and ground drive clutch levers return freely to their rest position when released. (Refer fig.9)

Before Mowing

To prevent accidents, thoroughly inspect the area and remove all objects which when contacted by the

mower blade could become dangerous projectiles. Inspect the area for hidden obstructions which when contacted by the blade could risk health and safety or result in damage to the mower. Remember the location of these obstructions and ensure that you mow around them. (Refer fig.10)

Fig. 8

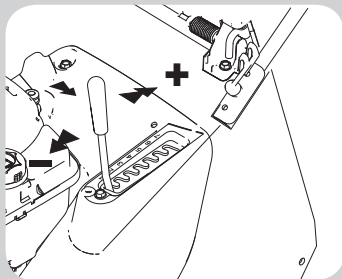

Fig. 9

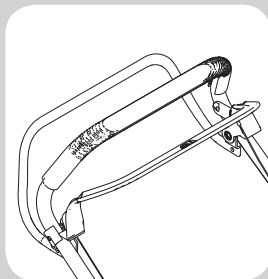

Fig. 10



BEFORE OPERATION

Battery Specification

Lithium-Ion Battery	
Lithium-Ion Battery Pack	10.8 V (10,8 V)
Charge Minutes	60
Charging Current	2 AMP
Charger AC Input (Variable)	90 - 240 V
Operating Temperature*	32 - 113°F (0 - 46°C)

Battery Charge Gauge

To check available charge, press the Battery Charge Gauge button. The display lights will indicate the approximate amount of charge remaining in the battery.

(Refer fig.11)

Display Lights	Available Charge
Four lights	78% to 100%
Three lights	55% to 77%
Two lights	33% to 54%
One light	10% to 32%
Flashing light	Less than 10%

Fig. 11

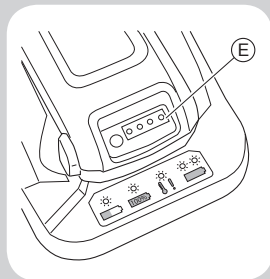

When to Charge the Battery Pack

⚠ WARNING: Improper use of the battery and charger can result in an electrical shock, fire or explosion which can cause severe burns.

The Lithium-Ion battery pack was partially charged before shipment. To maintain charge and to prevent damage while in storage, the battery pack is programmed to enter a "sleep mode".

As Required: To check available charge, press the Battery Charge Gauge button (H) and charge if required.

(Refer fig.11)

How to Charge the Battery Pack

⚠ WARNING: Keep battery pack and charger dry. Do not expose battery pack or charger to rain or wet conditions.

1. Connect battery charger to a mains supply socket.
2. Slide the battery pack (G) firmly into the battery charging bay (F). If the red charging light (A) does not come on, remove the battery pack (G) and reinstall. Make sure the battery pack (G) is firmly seated in the battery charging bay (F).

Fig. 12

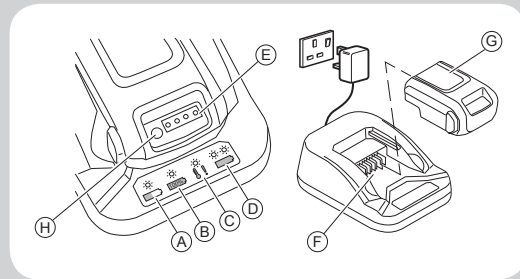

- Red light indicates battery pack is charging normally.
- Green light indicates battery pack is fully charged.
- FLASHING red light indicates the battery pack is either too hot or too cold and will not accept a charge. Leave the battery pack connected and when normal operating temperature* is reached it will automatically start charging.

*Refer to Setup - Battery Specification.

From "sleep mode", the battery will wake up in approximately ten (10) seconds.

3. A complete discharged battery pack will fully charge in approximately one (1) hour. The battery pack will stay fully charged if left on the charger.
4. When the green light indicates that the battery is fully charged, it can be removed from the charger.
5. To check available charge, press the Battery Charge Gauge button.
6. When not in use, disconnect the battery charger from the mains supply socket.

(Refer fig.12)

A	Red light - Charging normal	E	Battery charge gauge - Check available charge
B	Green light - Fully charged	F	Battery charger bay - Holder for battery whilst charging
C	Flashing red light - Battery pack too hot/cold and will not charge	G	Battery pack
D	Flashing red/green lights - Battery pack will not charge, replace	H	Battery fuel gauge button

DURING OPERATION

Electric Start

Firmly hold the engine stop lever against the handle (1) and push the electric start button (2) until you hear the engine start and then release the button. If the engine stop lever is released, the engine will stop.

(Refer fig.13)

NOTE: To prolong the life of the starter, do not crank the engine for more than 15 seconds in any one minute.

If the engine does not start after repeated attempts, contact your local Hayter Authorised Service Dealer or go to briggsandstratton.com.

To prevent engine damage do not operate the electric start button when the engine is running.

Forward Travel

Firmly hold the engine stop lever (1) against the handle (2) and push the electric start button (3). Squeeze the ground drive clutch lever (4) toward the handle and hold it to power the mower in a forward direction.

Ground speed may be adjusted by operating the variable speed control (5). Push forward to speed up and pull back to slow down.

(Refer fig.14)

When the ground drive clutch lever is disengaged the mower may be pushed. This feature is useful when mowing in confined areas.

Shutting off the Engine

To shut off the engine, release the engine stop lever (1) and ground drive clutch lever (2). Remove the electric start button (3).

(Refer fig.15)

Important: When you release the engine stop lever, the engine should shut off and the blade should stop within 3 seconds. If they do not, stop using your mower immediately and contact a Hayter Authorised Service Dealer.

Emergency stop: As above. If the engine fails to stop, remove the electric start button (1) and disconnect the spark plug lead (2).

(Refer fig.16)

Parking

Park on level ground.

Turning

To prevent accidents do not raise the front of the mower excessively when making a turn. Never raise the rear of the mower when the engine is running.

To make a wide turn, steer the mower with the handle in the direction required.

To make a tight turn release the ground drive clutch lever, apply downward pressure on the handle to raise the front wheels just above ground level and steer in the required direction.

Trim Side Cutting

Incorporation of a Trim Side allows you to cut right to the edge. This is ideal for mowing around borders, raised flower beds and retaining walls.

(Refer fig.17)

Fig. 13

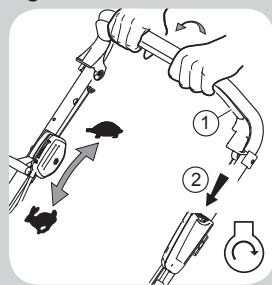

Fig. 14

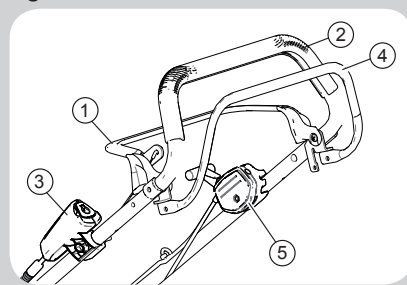

Fig. 15

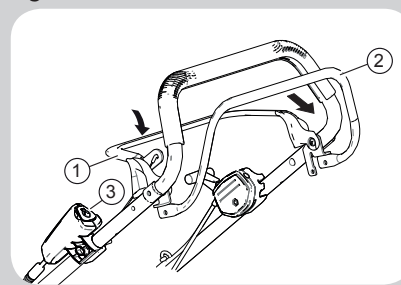

Fig. 16

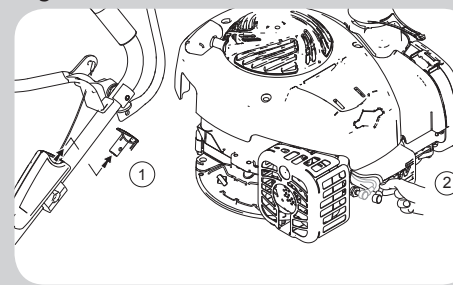
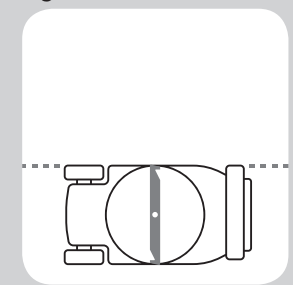

Fig. 17



DURING OPERATION

Vari-Pitch™ Cutting Technology

Vari-Pitch™ cutting technology automatically adjusts the cutter deck height at the rear of the mower, to increase air flow when cutting longer grass.

(Refer fig.18)

Heavy Growth

Areas of heavy growth should be mown without collecting the clippings. Refer to Mowing without the grass bag.

If collection is required, first mow the area without the grass bag, at the maximum height of cut setting. Allow the grass clippings to dry out and then mow the area at the maximum height of cut setting with the grass bag fitted. Refer to Adjusting the Cutting Height.

Reduce the height of cut and mow the area again as necessary until the required finish is obtained. To prevent damage to your lawn do not remove more than one third of grass height in one cut.

(Refer fig.19)

Grass Bag

Attaching the grass bag:

1. Raise and hold up the rear deflector (1)
2. Hook the grass bag into position (2).
3. Lower the rear deflector.

(Refer fig.20)

When collecting grass clippings it is important that the grass bag is emptied regularly to prevent blockages and engine overloading.

Good grass collection depends on good air flow through the grass bag. To empty the grass bag, pour out the grass clippings and shake the grass bag vigorously to clean the airways.

(Refer fig.21)

Mowing without the Grass Bag

Remove the grass bag and operate the mower with the rear deflector in the closed position.

(Refer fig.22)

Friction Disc

The blade is driven by the engine via a friction disc to help prevent damage occurring to the engine crankshaft and cutting mechanism when a hidden obstruction or overload is encountered.

(Refer fig.23)

Always stop the engine when a hidden obstruction or excessive vibration is encountered.

Remove the electric start button, disconnect the spark plug lead and examine the cutting mechanism.

ALWAYS replace a damaged blade. Consult your Authorised Hayter Service Dealer.

Fig. 18

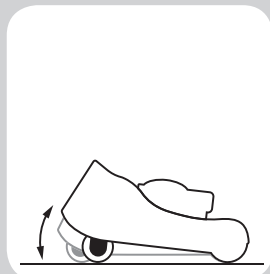

Fig. 19

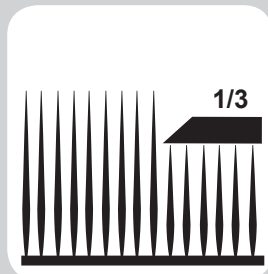

Fig. 20

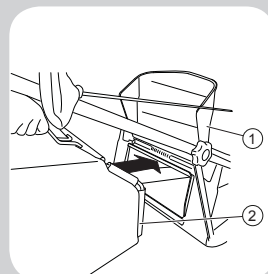

Fig. 21

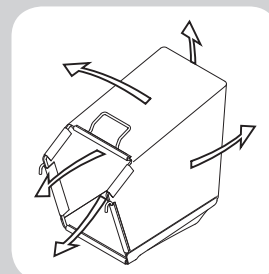

Fig. 22

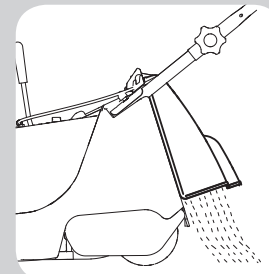
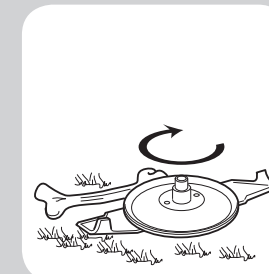

Fig. 23



AFTER OPERATION

Cleaning the Mower

WARNING: Improper maintenance, use of non conforming replacement components, or the removal or modification of the deck may cause death or serious injury.

WARNING: This mower may dislodge material from under the mower.

- **Wear eye protection**
- **Stay in the operating position (behind the handle) when the engine is running.**
- **Do not allow bystanders in the area.**

For best results clean the mower as soon as you have completed mowing.

1. Move the mower onto a flat surface.
2. Shut off the engine, wait for all moving parts to stop and remove the electric start button before leaving the operating position.
3. Lower the mower to its lowest cutting height setting; refer to Adjusting the Cutting Height.
4. Wash out the area under the rear deflector where the grass clippings go from the housing to the grass bag.

5. Attach a garden hose, that is already connected to a water supply to the easy wash port.

(Refer fig.24)

6. Turn the water on.
7. Start the engine and run it until no more clippings come out from under the mower.
8. Shut off the engine.
9. Shut off the water and disconnect the garden hose from the mower.
10. Start the engine and run it for a few minutes to dry the underside of the mower.
11. Allow the engine to cool before storing the mower in an enclosed area.

1. Remove the electric start button (2) from the electric starter (1).

(Refer fig.25)

2. Loosen the two handle securing hand bolts.
3. Fold the handle by rotating it forward.

(Refer fig.26)

Rotate the handle forward, refer to Setup - Assembling and Unfolding the Handle.

If a cable is damaged, contact a Hayter Authorised Service Dealer.

Folding the Handle

WARNING: Folding or unfolding the handle improperly can damage the cables, causing an unsafe operating condition.

IMPORTANT: Route the cables inside of the handle as you fold the upper handle.

Fig. 24

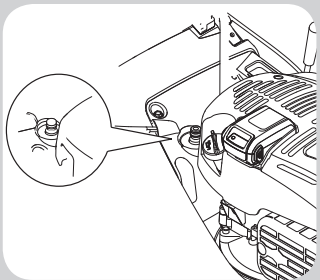

Fig. 25

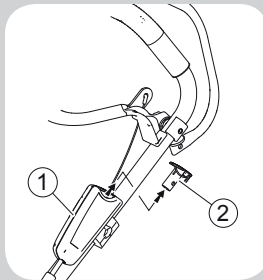
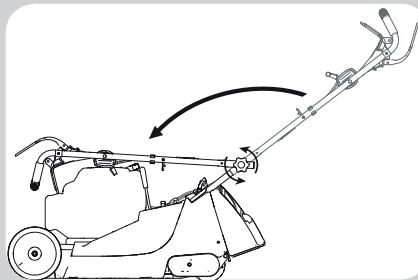

Fig. 26



MAINTENANCE SCHEDULE

Note: Determine the left and right sides of the mower from the normal operating position.

Recommended Maintenance Schedule

Maintenance Service Interval	Maintenance Procedure
Before each use or daily	<ul style="list-style-type: none">- Check the engine oil level.- Clean grass clippings and dirt from under the mower.- Check the condition of guards and safety devices.- Check the condition of the blade.- Check condition of grass bag and ensure airways are clear (replace if damaged).- Check the percentage of charge available in the battery and charge if necessary.
After very first 5 hours	<ul style="list-style-type: none">- Change the engine oil.- Check the percentage of charge available in the battery and charge if necessary.
Every 25 hours	<ul style="list-style-type: none">- Change the engine oil if continuously operating under heavy load or high ambient temperature.- Service the air filter.- Lubricate wheel bearings, pivot points and linkages.- Grease the inner control cables at point of entry and exit from their outer casing.- Check the clutch cable adjustment.- Sharpen the blade.
Every 50 hours	<ul style="list-style-type: none">- Change the engine oil- Clean the air filter.
Every 100 hours	<ul style="list-style-type: none">- Replace the spark plug.
Yearly	<ul style="list-style-type: none">- Replace the air filter; replace it more frequently in dusty operating conditions.- Replace the blade or have it sharpened (more frequently if the edge dulls quickly).- Clean the air-cooling system; clean it more frequently in dusty operating conditions.- Change the engine oil.
Yearly or before storage	<ul style="list-style-type: none">- Lubricate wheels, pivot points and linkages.- Empty the fuel tank before repairs as directed and before yearly storage.- Fully charge the battery before yearly storage.

Failure to follow this maintenance schedule could result in non warrantable failures.

MAINTENANCE

Preparing for Maintenance

IMPORTANT: Before tipping the mower to change the oil or replace the blade, allow the fuel tank to run dry through normal usage. If you must tip the mower prior to running out of fuel, use a hand fuel pump to remove the fuel. Always tip the mower onto its side, with the dipstick down.

WARNING: Tipping the mower may cause the fuel to leak. Fuel is flammable and explosive and can cause personal injury.

1. Shut off the engine and wait for all moving parts to stop.
2. Remove the electric start button.
3. Disconnect the spark plug wire from the spark plug.
4. After performing the maintenance procedure (s), connect the spark plug wire to the spark plug.

Air Filter Service

WARNING: Never start and run the engine with the air filter removed.

NOTE: Do not use pressurised air or solvents to clean

the filter. Pressurised air can damage the filter and solvents will dissolve the filter.

1. Press down on the latch tabs, on top of the air filter cover (1).
2. Open the cover (1).
3. Remove the filter (2).
4. Remove the pre-cleaner (3) from the filter. To loosen debris, gently tap the filter on a hard surface. If the filter is excessively dirty, replace with a new filter.
5. Wash the pre-cleaner in liquid detergent and water. Then allow it to thoroughly air dry. Do not oil the pre-cleaner.
6. Assemble the dry pre-cleaner to the filter.
7. Install the filter (2).
8. Close the cover (1).

(Refer to fig.27)

Fig. 27

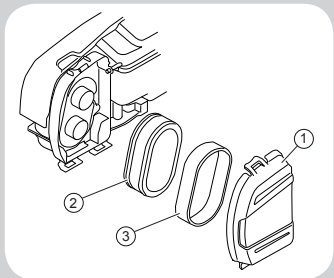

MAINTENANCE

Changing the Engine Oil

NOTE: Run the engine a few minutes to warm the oil before changing it. Warm oil flows better and carries more contaminants. Refer to Setup - Engine Oil Specifications to ensure you are using the correct grade of oil.

1. Move the mower to a level surface.
2. Drain the fuel by running the engine until the fuel tank is empty.
3. Shut off the engine, wait for all moving parts to stop and remove the electric start button.
4. Disconnect the spark plug lead from the spark plug.
5. Remove the dipstick (1) by rotating the cap counterclockwise and pulling it out.
6. Tip the mower onto its side (so that the air filter is up) to drain the used oil from the oil fill tube.

(Refer to fig.28)

7. After draining the used oil, return the mower to the operating position.
8. Refill with new oil (3) to the mark shown (2) with the recommended SAE viscosity grade. Refer to Setup - Engine Oil Specifications..

9. Wait for the oil to settle in the engine.
10. Wipe the dipstick clean with a clean cloth.
11. Insert the dipstick into the oil fill tube, but do not screw it in, then remove the dipstick.
12. Read the oil level on the dipstick.
 - If the oil level on the dipstick is too low, carefully pour a small amount of oil into the oil fill tube, wait 3 minutes, and repeat steps 8 through 10 until the oil level on the dipstick is correct.
 - If the oil level on the dipstick is too high, drain the excess oil until the oil level on the dipstick is correct.

(Refer to fig.28)

IMPORTANT: If the oil level in the engine is too low or too high and you run the engine, you may damage the engine.

13. Return the dipstick into the oil fill tube and tighten.
14. Recycle the used oil according to local authority guidelines.
15. After performing the maintenance procedure (s), insert the electric start button and connect the spark plug wire to the spark plug.

Servicing the Spark Plug

Improper maintenance, use of nonconforming replacement components, or the modification of the spark plug may cause death or serious injury.

IMPORTANT: Replace a cracked, fouled, or dirty spark plug. Do not clean the electrodes because grit entering the engine can damage the engine.

Replace the spark plug every season.

1. Shut off the engine and wait for all moving parts to stop.
2. Remove the electric start button.
3. Disconnect the wire from the spark plug.
4. Clean around the spark plug.
5. Remove the spark plug from the engine.

Check the spark plug gap (1 & 2) with a feeler gauge (3). If necessary, reset the gap to 0.76 mm. Install and tighten the spark plug, torque to 180 lb-in (20 Nm) .
(Refer to fig.29)

Fig. 28

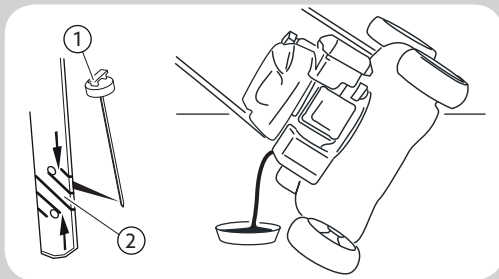
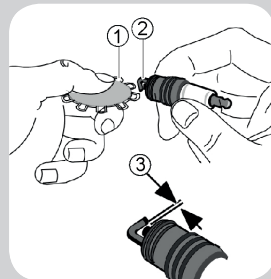

Fig. 29



MAINTENANCE

Remove & Replace the Blade

IMPORTANT: You will need a torque wrench to replace the blade properly. If you are uncomfortable performing this procedure or do not have a torque wrench, contact a Hayter Authorised Service Dealer.

WARNING: The blade is sharp; contacting the blade can result in serious personal injury. Wear gloves when servicing the blade.

Examine the blade regularly. If the blade is damaged or cracked, replace it immediately. If the blade edge is dull or nicked, have it sharpened and balanced, or replace it.

1. Refer to Preparing for Maintenance.
2. Tip the mower onto its side with the dipstick down.
3. Use a block of wood to hold the blade steady.
4. Remove the blade, saving all mounting hardware.

(Refer fig. 30)

5. Install the new blade (4) with the edges turned up, facing towards the mower housing. Secure the cutterblade (4) using the bolt (1), spring washer (2) and distance piece (3).

6. Tighten the blade bolt to the specified torque of 54 Nm. The blade will curve slightly when tightened against the friction disc.

(Refer fig. 31)

Blade Sharpening

A slightly worn blade may be re-sharpened. Both blade edges must be sharpened equally to ensure balance. Sharpen the blade every 25 mowing hours or more frequently if conditions require.

Remove the blade from the mower and clean using a brush and water. Inspect the blade for signs of damage. Sharpen both cutting edges with a flat file to restore performance.

(Refer fig.32)

Ensure that the blade is balanced. Use a screwdriver with a round shaft to support the blade through its centre hole. Hold the blade horizontal and then release. A balanced blade will remain horizontal.

(Refer fig.33)

If the blade is not balanced the heavy end will rotate downwards. Sharpen the heavy end until the blade is correctly balanced.

(Refer fig.34)

Fig. 30

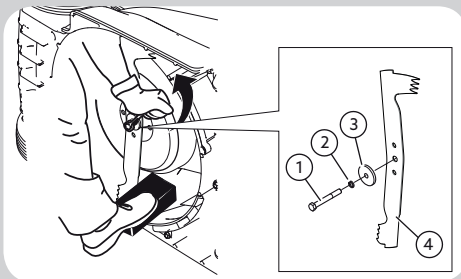

Fig. 31

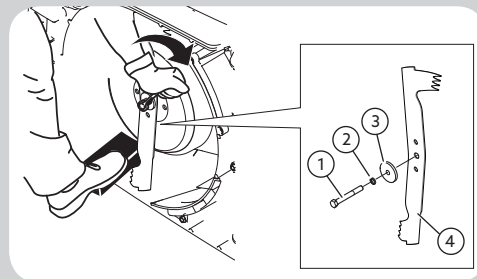

Fig. 32

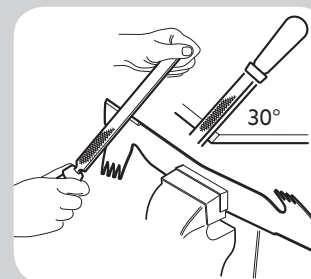

Fig. 33

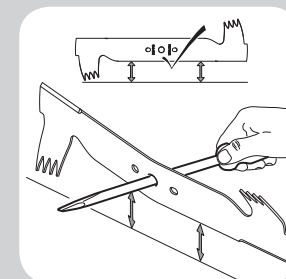
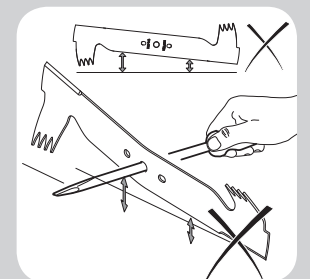

Fig. 34



MAINTENANCE

Clutch Cable Adjustment

At any time the operator feels that the mower is losing drive, check the following.

- Stop the engine.
- Pull the mower backwards at the same time progressively engage the clutch lever until the rear rollers lock, at this point the clutch lever should be 60 mm from the handle.
- If the distance between the clutch lever and handle is less than 60 mm regulate the engagement position using the black plastic cable adjuster (1) to regain the 60 mm distance.

Note this adjustment is approximate, at the nearest opportunity, a service should be carried out to ensure the spring on the clutch cable attached to gearbox is correctly set. This adjustment should be done using the black plastic cable adjuster (1).

(Refer fig.35)

With the clutch lever fully engaged, the cable should be adjusted to give a spring extension of 10 mm.

(Refer figs. 36 & 37)

Securing Nuts & Bolts

Regularly check that all securing nuts and bolts are tight. Replace missing or damaged items immediately.

Rear Deflector

WARNING: Improper maintenance, use of non conforming replacement components, or the removal or modification of the rear deflector may cause death or serious injury.

Remove grass debris from the rear deflector immediately after use and check its condition for signs of damage.

Carburetor Adjustments

Never make adjustments to the carburetor or engine speed. The carburetor was set at the factory to operate efficiently under most conditions.

Do not tamper with the governor spring, linkages, or other parts to change the engine speed detailed in the Product Specification section. If any adjustments are required contact your Hayter Authorised Service Dealer for service.

Blade Brake Test

The engine and blade are designed to stop within 3 seconds, after you release the engine stop lever. Ensure that the engine stop lever functions properly each time before you operate the mower.

If the blade does not stop within 3 seconds or there is a grinding or scraping, metal-to-metal noise when you release the engine stop lever, contact a Hayter Authorised Service Dealer.

This same recommendation applies if you observe heavy vibrations when using the mower.

Fig. 35

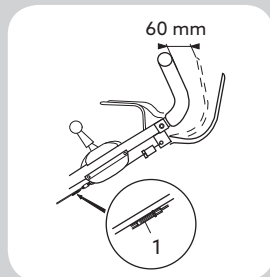

Fig. 36

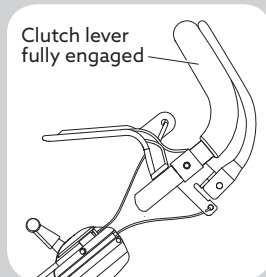
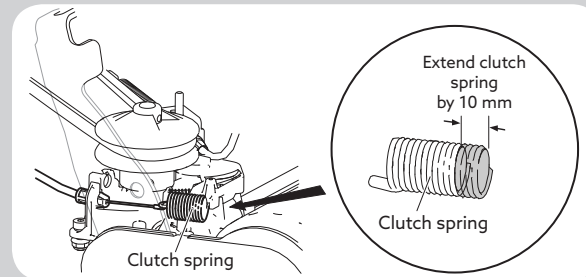

Fig. 37



MAINTENANCE

Lubrication

Lubricate the wheel bearings, pivot points and linkages with engine oil yearly or before storing mower away.

Apply a good quality medium grease to the inner control cables at the point of entry and exit from their outer casing.

Do not add lubricant or grease to the polymer rear roller bearings.

Battery Disposal Directive

PREVENT ENVIRONMENTAL DAMAGE.

The battery and charger have a separate collection mark. The mark indicates that the battery and battery charger must be taken to an authorised disposal site. They must not be disposed of with general waste.

EU Directive 2012/19/EU classifies these products as electrical or electronic equipment.

- The consumer has a critical role in returning waste electronic / electrical equipment for recycling and disposal.
- Recycling keeps these products out of the municipal waste stream.

- The crossed-out bin symbol is a reminder to follow these points.

(Refer fig.38)

Lithium-Ion Battery Pack Disposal

WARNING: Battery chemicals are toxic and corrosive. Fire or explosion can cause severe burns or death.

- Never burn or incinerate discarded or used battery packs as they may explode. Toxic fumes and materials are created when battery packs are burned.
- Do not use a battery that has been crushed, dropped or damaged.
- If liquid comes in contact with your skin, wash immediately with soap and water.
- If liquid gets in your eyes, flush with clean water for at least 30 minutes. See a doctor immediately.

Used and discarded battery packs will likely still carry a small electrical charge and should be handled with care.

Always dispose of discarded or used battery packs according to local regulations.

Please contact your local authority or dealer to ask for further details regarding the correct method of disposal.

Fig. 38



STORAGE

Storage Safety

Always shut off the mower, wait for all moving parts to stop, remove the electric start button and allow the mower to cool before adjusting, servicing, cleaning, or storing it.

Preparing the Mower for Storage

IMPORTANT: Old fuel in the fuel tank is the leading cause of hard starting. Do not store the fuel without fuel stabiliser more than 30 days, and do not store stabilised fuel beyond the duration recommended by the fuel-stabiliser manufacturer.

Remove the electric start button from the electric starter and store it in a memorable place.

- Clean grass clippings and dirt from under the mower.
- On the last refuelling of the year, add fuel stabiliser to the fuel as directed on the label.
- Dispose of any unused fuel properly. Recycle it according to local authority guidelines.
- Run the mower until the engine shuts off.
- Start the engine again and allow it to run until it shuts off. When you can no longer start the engine,

it is sufficiently dry.

- Remove the electric start button.
- Disconnect the wire from the spark plug.
- Remove the spark plug, add 30 ml (1 fl oz) of engine oil through the spark-plug hole, and pull the engine start cord slowly several times to distribute oil throughout the cylinder to prevent cylinder corrosion during the off-season.
- Loosely install the spark plug.
- Tighten all nuts, bolts, and screws.
- Lubricate the mower and treat metal parts with a water repellent anti-corrosion product.
- Cover the mower with a protective sheet and store it in a dry, ventilated area.

Storage

When storing your mower away, ensure that cables do not become snagged at the pivot points. Disengage the engine stop lever to prevent it being damaged through potential contact with the engine.

To store the handle, unscrew the two securing hand bolts sufficiently, to allow it to be pivoted forwards to rest against the mower.

(Refer fig.38)

Battery Pack & Charger Storage

When not in use, disconnect the battery and store in a cool, dry area. Wet, damp areas can cause corrosion of terminals and electrical contacts. Do not expose battery pack or charger to rain or wet conditions. If stored for long periods in high temperatures (120° F / 49° C), permanent damage to the battery pack can result. Check electrical terminals and contacts on battery packs and charger. Wipe with clean cloth or blow clean with compressed air. After storage, a normal charge may be required. To check available charge, press the Battery Charge Gauge button (E) and charge if required. Refer to Before Operation - Battery Charge Gauge.

Fig. 38

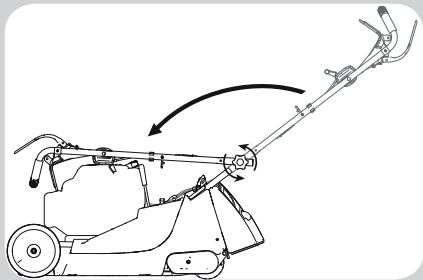

STORAGE

Removing the Mower from Storage

- Check and tighten all fasteners.
- Check the battery gauge and charge if required. Refer to Before Operation - How to Charge the Battery Pack.
- Install the electric start button.
- Remove the spark plug and spin the engine rapidly, by holding the engine stop lever against the handle, followed by pushing the electric start button, to blow the excess oil from the cylinder.
- Install the spark plug and tighten it with a torque wrench to 20 N·m (15 ft·lb).
- Perform any maintenance procedures; refer to Maintenance.
- Check the engine-oil level; refer to Checking the Engine-Oil Level.
- Fill the fuel tank with fresh fuel; refer to Filling the Fuel Tank.
- Connect the wire to the spark plug.

TROUBLE SHOOTING

PROBLEM	CAUSES	CORRECTIVE ACTION
Engine will not turn over	Engine stop lever released	Operate engine stop lever
	Electric start button removed	Insert electric start button
	Incorrect oil level	Check oil level
	Obstruction under deck	Remove obstruction
Engine smokes	Excess oil	Check oil level
	Air filter cartridge oil soaked or blocked	Service air filter
Engine runs then stops	Fuel starvation	Fill fuel tank
	Fuel cap vent blocked	Clean fuel cap vent
Engine will not start	Engine under load	Raise the height of cut
	Incorrect / contaminated fuel	Drain tank and fill with correct fuel
	Spark plug lead disconnected	Connect spark plug lead
	Electric start button removed	Insert electric start button
	Engine brake not released	Operate engine brake lever
	Faulty spark plug	Clean and adjust the gap or replace
Wiring fault	Check wiring	
Engine runs rough	Spark plug lead becoming disconnected in use	Connect spark plug lead
	Faulty spark plug	Clean and adjust gap or replace
	Air filter blocked	Service air filter
	Incorrect / contaminated fuel	Drain tank and fill with correct fuel
Engine vibrates excessively	Mounting bolt loose	Tighten bolt
	Blade bolt loose	Tighten bolt
	Blade out of balance	Balance blade
	Bent crankshaft	Consult your dealer

PROBLEM	CAUSES	CORRECTIVE ACTION
Uneven cut	Undulating ground conditions	Change direction of travel
	Blade worn	Sharpen blade
	Blade out of balance	Balance the blade
	Wheels/roller damaged	Inspect and replace as necessary
Discharge chute blocks	Grass is wet	Mow dry grass
	Cut height too low	Increase cut height
	Grassbag full	Empty grassbag
Mower is hard to push	No airflow through the grassbag	Clean the grassbag
	Cut height too low	Increase cut height
	Wheels/roller damaged	Inspect and replace as necessary
Mower will not self propel	Clutch out of adjustment	Adjust clutch cable
	Drive belt damaged	Replace drive belt
Poor grass condition	No airflow through the grassbag	Clean the grassbag
	Discharge chute blocked	Remove blockage
	Wet grass	Mow dry grass
	Grassbag full	Empty grassbag
Blade drive will not engage/disengage	Engine stop lever not fully forward	Push fully forward to disengage

WARRANTY

5 Year Warranty - Residential Use

90 Day Warranty - Commercial Use

Hayter Limited warrants to the original purchaser that this unit shall be free from defects in material and workmanship, under normal, residential use, for a period of five years from the date of purchase or, if used commercially, for a period of 90 days from the date of purchase. (Please note that a separate engine warranty is offered by the engine manufacturer and services are provided through their authorized network. Refer to the "Engine Warranty Statement" in the Engine Manual for details). To qualify for the 5 year warranty, you must have the machine serviced annually by a Hayter Authorised Service Dealer* within 12, 24, 36 and 48 months of the date of purchase. Please note that these services will be charged at a rate agreed between you and the Dealer. If the machine is not serviced annually, the warranty will automatically expire twelve months after the machine's most recent annual service.

Excluded from warranty include those items which are subject to normal wear and tear, including but not limited to tyres, wheels, cutterblades, belts, cables, grass bags, batteries and other consumable wearing parts.

Lifetime Crankshaft Warranty

All Hayter branded machines which are fitted with a genuine Hayter Friction Disc and Crank-Safe Blade Brake Clutch (integrated Blade Brake Clutch (BBC) + Friction Disc assembly) as original equipment and used by the original purchaser in accordance with recommended operating and maintenance procedures, are covered by a Lifetime Warranty against engine crankshaft bending. Machines fitted with friction washers, Blade Brake Clutch (BBC) units and other such devices are not covered by the Lifetime Crankshaft Warranty.

Lifetime Deck Warranty

Hayter Limited warrants to the original purchaser that the machine deck, consisting of the die cast structure to which the engine is secured, will not crack or break during normal use for the lifetime of the product with the original purchaser. If such damage occurs Hayter Limited shall, at our option, repair or replace the machine deck at no cost. Deck failure due to misuse or abuse and corrosion occurring due to lack of regular maintenance are not covered. Machines used commercially are excluded from this warranty.

Terms and Conditions

Hayter shall, at our option, repair or replace any part covered by warranty during the applicable period.

Your product must be registered within 14 days of purchase to qualify for the full benefit of the product warranty. Please go to www.hayter.co.uk/warranty-registration to complete this process.

This warranty does not apply to any unit that has been tampered with, altered, misused, abused or used for hire, and will become invalid if non-genuine Hayter parts are fitted. Minor mechanical adjustments are not covered unless they are due to defective material or workmanship. Consult the Operator's Manual or a Hayter Authorised Service Dealer for assistance when making these adjustments.

Making a Claim

To make a warranty claim, return the unit to a Hayter Authorised Service Dealer, along with proof of purchase stating the machine serial number and date of purchase and the service receipt(s) or stamped service card.

This warranty gives you specific legal rights and are in addition to any statutory rights to which you may be entitled. Your statutory rights are not affected by this warranty. If you need additional information concerning this written warranty, or assistance in obtaining services please email customer.care@hayter.co.uk, write to Hayter Limited, Customer Care Team, Spellbrook, Bishop's Stortford, Hertfordshire CM23 4BU or Tel Freephone 0800 616 298.

*Details of your local Hayter Authorised Dealer can be found on the Hayter website www.hayter.co.uk or contact: Freephone 0800 616 298.

EEA/UK Privacy Notice

Hayter's Use of Your Personal Information

Hayter Limited, and its parent, The Toro Company, respect your privacy. When you purchase our products, we may collect certain personal information about you, either directly from you or through your local retail outlet. We use this information to fulfil contractual obligations - such as to register your warranty, process your warranty claim or to contact you in the event of a product recall - and for legitimate business purposes - such as to gauge customer satisfaction, improve our products or provide you with product information which may be of interest. We may share your information with The Toro Company, its subsidiaries or affiliates, or with our dealers, retailers or other business partners in connection these activities. We may also disclose personal information when required by law or in connection with the sale, purchase or merger of a business. We will never sell your personal information to any other company for marketing purposes.

Retention of your Personal Information

We will keep your personal information as long as it is relevant for the above purposes and in accordance with legal requirements. For more information about applicable retention periods please contact legal@toro.com.

Hayter's Commitment to Security

Your personal information may be processed in the US or another country which may have less strict data protection laws than your country of residence. Whenever we transfer your information outside of your country of residence, we will take legally required steps to ensure that appropriate safeguards are in place to protect your information and to make sure it is treated securely.

Access and Correction

You may have the right to correct or review your personal data, or object to or restrict the processing of your data. To do so, please contact us by email at legal@toro.com. If you have concerns about the way in which Hayter Ltd has handled your information, we encourage you to raise this directly with us. Please note that European residents have the right to complain to your Data Protection Authority.

NOTES

NOTES

Hayter Limited

Spellbrook,
Bishop's Stortford,
Herts
CM23 4BU
England

Customer Care Help line: 0800 616 298

www.hayter.co.uk