

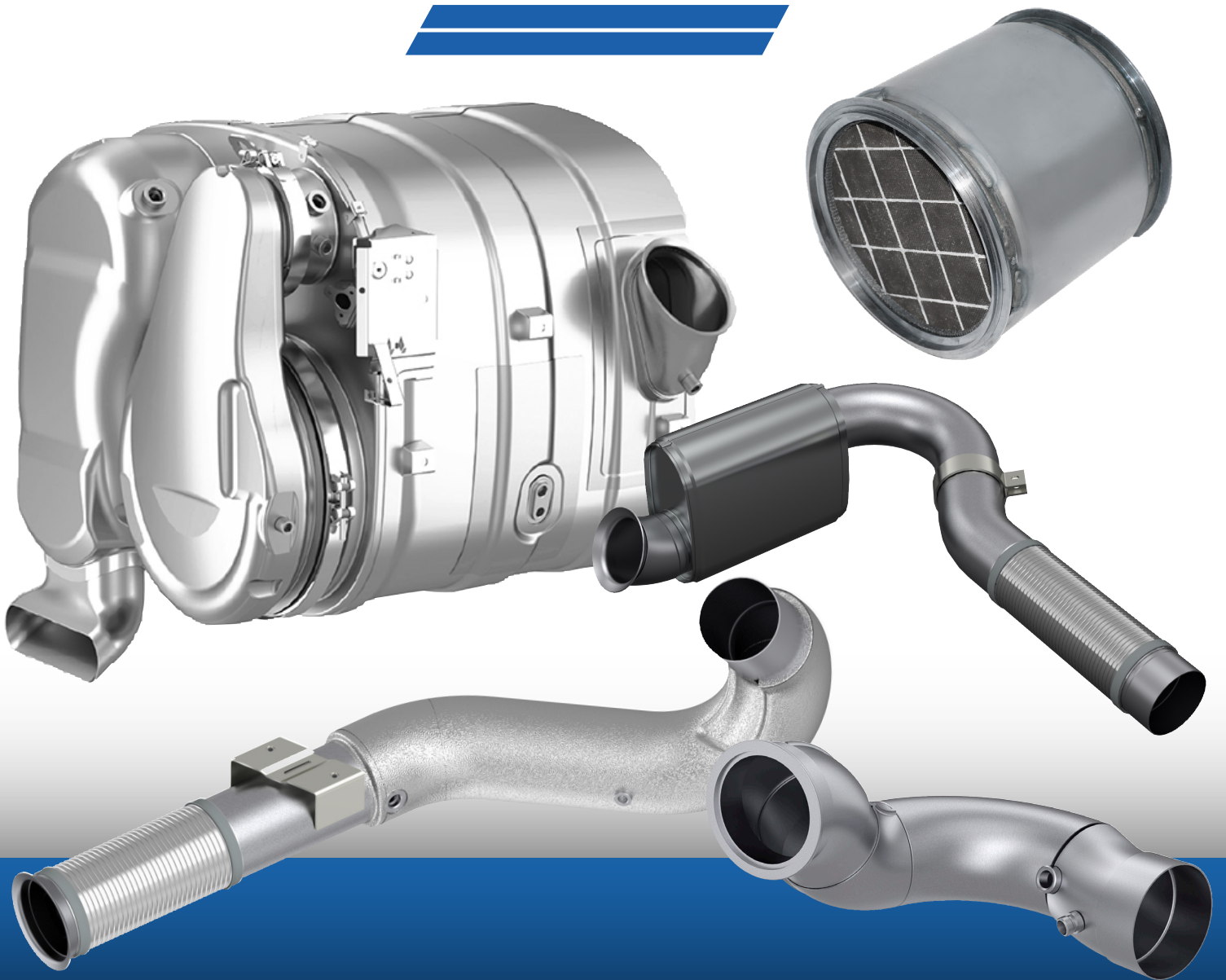

TRUCK & TRAILER PARTS LTD

OFFICIAL DISTRIBUTORS



TOP POPULAR PARTS

TOP POPULAR PARTS

DAF		LF	
Euro 6		Horizontal	
Type: PX5			
Capacity: 4.5Ltr			
			
Flexi Pipe			

3G Part No		DIN2AA003	
Clamp 1	Seal 1	Clamp 2	Seal 2
DIN2AL000	DIN2AL013	DIN2AL001	DIN2AL013

3G Part No		DIN2AE000	
Clamp 1	Seal 1	Clamp 2	Seal 2
DIN2AL001	DIN2AL013	DIN2AL001	DIN2AL013

3G Part No		DIN2AE000	
Clamp 1	Seal 1	Clamp 2	Seal 2
DIN2AL001	DIN2AL013	DIN2AL001	DIN2AL013

3G Part No		DIN2AI003	
------------	--	-----------	--

3G Part No		DIN2AI003	
------------	--	-----------	--

DAF		LF	
Euro 6		Horizontal	
Type: PX7			
Capacity: 6.7Ltr			
			
Flexi Pipe			

3G Part No		DIN2AA003	
Clamp 1	Seal 1	Clamp 2	Seal 2
DIN2AL000	DIN2AL013	DIN2AL001	DIN2AL013

3G Part No		DIN2AE000	
Clamp 1	Seal 1	Clamp 2	Seal 2
DIN2AL001	DIN2AL013	DIN2AL001	DIN2AL013

3G Part No		DIN2AE000	
Clamp 1	Seal 1	Clamp 2	Seal 2
DIN2AL001	DIN2AL013	DIN2AL001	DIN2AL013

3G Part No		DIN1JI001	
------------	--	-----------	--

3G Part No		DIN1JI001	
------------	--	-----------	--

3G Part No		DIN2AL017	
------------	--	-----------	--

3G Part No		DIN2AL017	
------------	--	-----------	--

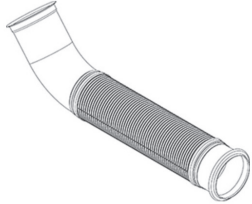
DAF		CF75	
Euro 3		Horizontal	
Type: PX5			
Capacity: 12.6Ltr			
			
Flexi Pipe			

3G Part No		DIN2AA000	
Clamp 1	Seal 1	Clamp 2	Seal 2
DIN21850		DIN21850	

3G Part No		DIN2AA000	
Clamp 1	Seal 1	Clamp 2	Seal 2
DIN21850		DIN21850	

DAF		CF75	
Euro 4/5			
Type: PR183,228,265			
Capacity: 9.2Ltr			
			
Middle Silencer			

3G Part No		DIN2AD022	
Clamp 1	Seal 1	Clamp 2	Seal 2
DIN21850		DIN21850	

3G Part No		DIN2AD022	
Clamp 1	Seal 1	Clamp 2	Seal 2
DIN21850		DIN21850	

3G Part No		DIN2AD022	
------------	--	-----------	--

3G Part No		DIN2AD022	
Clamp 1	Seal 1	Clamp 2	Seal 2
DIN21850		DIN21850	

3G Part No		DIN2AD022	
Clamp 1	Seal 1	Clamp 2	Seal 2
DIN21850		DIN21850	

TOP POPULAR PARTS

3G00161
1st March 2022

DAF		CF	
Euro 6		Horizontal	
Type: MX11			
Capacity: 10.8Ltr			
			
Flexi Pipe			
3G Part No		DIN2AA006	
Clamp 1	Seal 1	Clamp 2	Seal 2
DIN2AL002	DIN2AL003	DIN2AL004	DIN2AL005

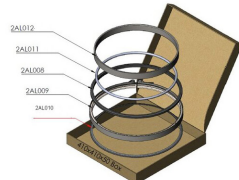
DAF		CF	
Euro 6		Horizontal	
Type: MX13			
Capacity: 12.9Ltr			
			
Seal & Clamp Kit for DIN2AI000			
Clamp & Gasket Kit			
3G Part No		DIN2AL038	

DAF		XF105	
Euro 4/5			
Type: MX300,340,375			
Capacity: 12.9Ltr			
			
Middle Silencer			
3G Part No		DIN2AD022	
Clamp 1	Seal 1	Clamp 2	Seal 2
DIN21850		DIN21850	

DAF		CF	
Euro 6		Vertical	
Type: PX7			
Capacity: 6.7Ltr			
			
Flexi Pipe			
3G Part No		DIN2AE008	
Clamp 1	Seal 1	Clamp 2	Seal 2
	DIN2AL006	DIN2AL004	DIN2AL005

DAF		CF	
Euro 6		Vertical	
Type: PX7			
Capacity: 6.7Ltr			
			
Supplied with Seal & Clamp Kit			
Catalyst Insert			
3G Part No		DIN2AI003	

DAF		XF	
Euro 6		Horizontal	
Type: MX11			
Capacity: 10.8Ltr			
			
Flexi Pipe			
3G Part No		DIN2AA006	
Clamp 1	Seal 1	Clamp 2	Seal 2
DIN2AL002	DIN2AL003	DIN2AL004	DIN2AL005

DAF		CF	
Euro 6		Vertical	
Type: MX11			
Capacity: 10.8Ltr			
			
Seal & Clamp Kit for DIN2AI000			
Clamp & Gasket Kit			
3G Part No		DIN2AL038	

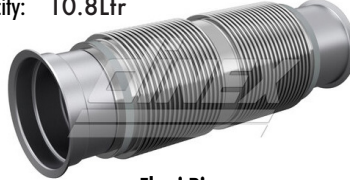
DAF		CF	
Euro 6		Vertical	
Type: MX11			
Capacity: 10.8Ltr			
			
Flexi Pipe			
3G Part No		DIN2AA006	
Clamp 1	Seal 1	Clamp 2	Seal 2
DIN2AL002	DIN2AL003	DIN2AL004	DIN2AL005

DAF		CF	
Euro 6		Vertical	
Type: MX11			
Capacity: 10.8Ltr			
			
Seal & Clamp Kit for DIN2AI000			
Clamp & Gasket Kit			
3G Part No		DIN2AL038	

DAF		CF	
Euro 6		Vertical	
Type: MX11			
Capacity: 10.8Ltr			
			
Seal & Clamp Kit for DIN2AI000			
Clamp & Gasket Kit			
3G Part No		DIN2AL038	

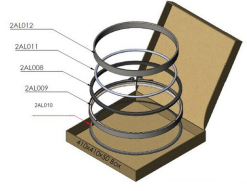
DAF		XF	
Euro 6		Horizontal	
Type: MX13			
Capacity: 12.9Ltr			
			
Seal & Clamp Kit for DIN2AI000			
Clamp & Gasket Kit			
3G Part No		DIN2AL038	

TOP POPULAR PARTS

IVECO Eurocargo
Euro 6 Horizontal
Type: Tector 7
Capacity: 4.5Ltr



Flexi Pipe

3G Part No		DIN2KA021	
Clamp 1	Seal 1	Clamp 2	Seal 2
DIN70819		DIN2KL018	



Seal & Clamp Kit for DIN2KI015
Clamp & Gasket Kit

3G Part No		DIN2KL017	
------------	--	------------------	--

IVECO Eurocargo
Euro 6 Horizontal
Type: Tector 5
Capacity: 6.7Ltr

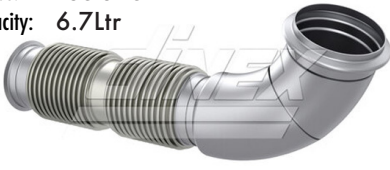

Flexi Pipe

3G Part No		DIN2KA019	
Clamp 1	Seal 1	Clamp 2	Seal 2
DIN70819		DIN2KL018	



Seal & Clamp Kit for DIN2KI015
Clamp & Gasket Kit

3G Part No		DIN2KL017	
------------	--	------------------	--

IVECO Trakker / Stralis
Euro 6 Horizontal
Type: Cursor 9
Capacity: 8.7Ltr
Type: Cursor 11
Capacity: 11.1Ltr

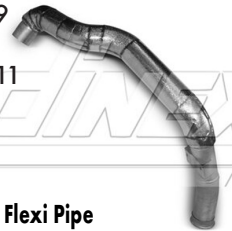

Flexi Pipe

3G Part No		DIN2KA000	
Clamp 1	Seal 1	Clamp 2	Seal 2
DIN29806		DIN2KL001	



Tailpipe

3G Part No		DIN2KG002	
Clamp 1	Seal 1	Clamp 2	Seal 2
DIN2KL002			

IVECO Stralis
Euro 6 Horizontal
Type: Cursor 11
Capacity: 11.1Ltr
Type: Cursor 13
Capacity: 12.9Ltr



Front Flexi Pipe

3G Part No		DIN2KA001	
Clamp 1	Seal 1	Clamp 2	Seal 2
DIN29806		DIN2KL001	

TOP POPULAR PARTS

MAN	TGL, TGM
Euro 6	Horizontal / Vertical
Type: D0834	
Capacity: 4.6Ltr	
Type: D0836	
Capacity: 6.9Ltr	
	
Supplied with Seal & Clamp Kit Catalyst Insert	
3G Part No	DIN41I003

MAN	TGS, TGX		
Euro 6	Horizontal		
Type:			
Capacity:			
			
Tail Pipe			
3G Part No	DIN4IA001		
Clamp 1	Seal 1	Clamp 2	Seal 2
DIN41L040		DIN41L046	

MAN	TGS, TGX		
Euro 6	Horizontal		
Type: D2066LF			
Capacity: 10.5Ltr			
Type: D2676LF			
Capacity: 12.4Ltr			
			
Flexi Pipe			
3G Part No	DIN4IA000		
Clamp 1	Seal 1	Clamp 2	Seal 2
DIN68835	DIN41L002	DIN68835	DIN41L002

MAN	TGS, TGX		
Euro 6	Vertical		
Type: D2066LF			
Capacity: 10.5Ltr			
Type: D2676LF			
Capacity: 12.4Ltr			
			
Flexi Pipe			
3G Part No	DIN4IA000		
Clamp 1	Seal 1	Clamp 2	Seal 2
DIN68835	DIN41L002	DIN68835	DIN41L002

MAN	TGL, TGM		
Euro 5	Horizontal		
Type: D0834LFL			
Capacity: 4.6Ltr			
Type: D0836LFL			
Capacity: 6.9Ltr			
			
Flexi Pipe			
3G Part No	DIN4IA005		
Clamp 1	Seal 1	Clamp 2	Seal 2
DIN99785		DIN99785	

MAN	TGL, TGM		
Euro 5	Vertical		
Type: D0834LFL			
Capacity: 4.6Ltr			
Type: D0836LFL			
Capacity: 6.9Ltr			
			
Flexi Pipe			
3G Part No	DIN4IA005		
Clamp 1	Seal 1	Clamp 2	Seal 2
DIN99785		DIN99785	

MAN	TGS, TGX		
Euro 5	Horizontal		
Type: D2066LF			
Capacity: 10.5Ltr			
Type: D2676LF			
Capacity: 12.4Ltr			
			
Flexi Pipe			
3G Part No	DIN4IA008		
Clamp 1	Seal 1	Clamp 2	Seal 2
DIN68835		DIN99715	

MAN	TGS		
Euro 5	Vertical		
Type: D2676LF			
Capacity: 12.4Ltr			
			
Flexi Pipe			
3G Part No	DIN4IA008		
Clamp 1	Seal 1	Clamp 2	Seal 2
DIN68835		DIN99715	

MAN	TGS, TGX		
Euro 4	Horizontal		
Type: D2066LF			
Capacity: 10.5Ltr			
Type: D2676LF			
Capacity: 12.4Ltr			
			
Flexi Pipe			
3G Part No	DIN4IA007		
Clamp 1	Seal 1	Clamp 2	Seal 2
DIN99714		DIN99714	

MAN	TGS		
Euro 4	Vertical		
Type: D2066LF			
Capacity: 10.5Ltr			
			
Flexi Pipe			
3G Part No	DIN4IA007		
Clamp 1	Seal 1	Clamp 2	Seal 2
DIN99714		DIN99714	

MAN	TGS, TGX		
Euro 4	Horizontal		
Type: D2066LF			
Capacity: 10.5Ltr			
Type: D2676LF			
Capacity: 12.4Ltr			
			
Front Pipe			
3G Part No	DIN4IA009		
Clamp 1	Seal 1	Clamp 2	Seal 2
DIN49939		DIN99714	

MAN	TGS, TGX		
Euro 4	Vertical		
Type: D2066LF			
Capacity: 10.5Ltr			
Type: D2676LF			
Capacity: 12.4Ltr			
			
Front Pipe			
3G Part No	DIN4IA009		
Clamp 1	Seal 1	Clamp 2	Seal 2
DIN49939		DIN99714	

TOP POPULAR PARTS

MERCEDES Actros
Euro 6 Horizontal
Type: OM471
Capacity: 12.8Ltr



Flexi Pipe

3G Part No		DIN5AA031	
Clamp 1	Seal 1	Clamp 2	Seal 2
DIN5AL011		DIN5AL028	

MERCEDES Atego
Euro 5 Horizontal
Type: OM904LA
Capacity: 4.25Ltr



Front Flexi Pipe

3G Part No		DIN5AA010	
Clamp 1	Seal 1	Clamp 2	Seal 2
DIN50810		DIN50945	

MERCEDES Atego
Euro 5 Horizontal
Type: OM904LA
Capacity: 4.25Ltr



Flexi Repair Pipe for DIN5AA010

3G Part No		DIN54270RK	
Clamp 1	Seal 1	Clamp 2	Seal 2
		DIN50945	

MERCEDES Atego
Euro 5 Horizontal
Type: OM906LA
Capacity: 6.4Ltr



Front Flexi Pipe

3G Part No		DIN5AA011	
Clamp 1	Seal 1	Clamp 2	Seal 2
DIN50810		DIN50945	

MERCEDES Axor
Euro 5 Horizontal
Type: OM926LA
Capacity: 7.2Ltr



Low Mounted Engine Front Flexi Pipe

3G Part No		DIN5AA012	
Clamp 1	Seal 1	Clamp 2	Seal 2
DIN50852		DIN58924	

MERCEDES Axor
Euro 5 Vertical
Type: OM926LA
Capacity: 7.2Ltr



Low Mounted Engine Front Flexi Pipe

3G Part No		DIN5AA012	
Clamp 1	Seal 1	Clamp 2	Seal 2
DIN50852		DIN58924	

MERCEDES Axor
Euro 5 Horizontal
Type: OM457LA
Capacity: 12.0Ltr



Flexi Pipe & Silencer

3G Part No		DIN5AA014	
Clamp 1	Seal 1	Clamp 2	Seal 2
DIN51894		DIN99714	

MERCEDES Axor
Euro 5 Vertical
Type: OM457LA
Capacity: 12.0Ltr



Flexi Pipe & Silencer

3G Part No		DIN5AA014	
Clamp 1	Seal 1	Clamp 2	Seal 2
DIN51894		DIN99714	

RENAULT Kerax, Premium
Euro 5
Type: DXi11
Capacity: 13.0Ltr

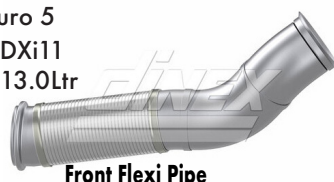

Front Flexi Pipe

3G Part No		DIN6GA001	
Clamp 1	Seal 1	Clamp 2	Seal 2

TOP POPULAR PARTS

SCANIA P, G, R, T
Euro 5 Horizontal
Type: DC13
Capacity: 12.7Ltr

Turbo Compound Pipe

3G Part No		DIN6LA008	
Clamp 1	Seal 1	Clamp 2	Seal 2

SCANIA P, R, T
Euro 5 Horizontal
Type: DC13
Capacity: 12.7Ltr

Flexi Pipe

3G Part No		DIN6LA000	
Clamp 1	Seal 1	Clamp 2	Seal 2
DIN68835		DIN68835	

SCANIA P, G, R
Euro 6 Horizontal
Type: DC9
Capacity: 9.3Ltr
Type: DC13
Capacity: 12.7Ltr

**Supplied with Seal & Clamp Kit
Catalyst Insert**

3G Part No		DIN6LI000	
------------	--	------------------	--

SCANIA P, G, R
Euro 6 Vertical
Type: DC13
Capacity: 12.7Ltr

**Supplied with Seal & Clamp Kit
Catalyst Insert**

3G Part No		DIN6LI000	
------------	--	------------------	--

SCANIA P, G, R
Euro 6 Horizontal
Type: DC13
Capacity: 12.7Ltr

Tail Pipe

3G Part No		DIN6LG002	
Clamp 1	Seal 1	Clamp 2	Seal 2
DIN68858			

SCANIA P, G, R
Euro 6 Horizontal
Type: DC16
Capacity: 16.3Ltr

Flexi Pipe

3G Part No		DIN6LA003	
Clamp 1	Seal 1	Clamp 2	Seal 2
DIN68835		DIN68835	

SCANIA P, G, R
Euro 6 Horizontal
Type: DC16
Capacity: 16.3Ltr

Flexi Pipe

3G Part No		DIN6LA003	
Clamp 1	Seal 1	Clamp 2	Seal 2
DIN68835		DIN68835	

SCANIA P, G, R
Euro 6 Vertical
Type: DC13
Capacity: 12.7Ltr

Rear Silencer

3G Part No		DIN6LC004	
Clamp 1	Seal 1	Clamp 2	Seal 2
DIN68858		DIN99925	

**Alternative to DIN6LA003
Flexi Pipe**

3G Part No		DIN6LA009	
Clamp 1	Seal 1	Clamp 2	Seal 2
DIN68835		DIN68835	

**Alternative to DIN6LA003
Flexi Pipe**

3G Part No		DIN6LA009	
Clamp 1	Seal 1	Clamp 2	Seal 2
DIN68835		DIN68835	

SCANIA P, G, R
Euro 6 Vertical
Type: DC13
Capacity: 12.7Ltr

Flexi Pipe

3G Part No		DIN6LE016	
Clamp 1	Seal 1	Clamp 2	Seal 2

Front Flexi Pipe

3G Part No		DIN6LE000	
Clamp 1	Seal 1	Clamp 2	Seal 2
DIN68835		DIN68858	

Tail Pipe

3G Part No		DIN6LG002	
Clamp 1	Seal 1	Clamp 2	Seal 2
DIN68835			

TOP POPULAR PARTS

VOLVO		FM	
Euro 5		Horizontal	
Type:	D8B		
Capacity:	9.4Ltr		
Type:	D11B		
Capacity:	10.8Ltr		
Type:	D13A		
Capacity:	12.8Ltr		
			
Flexi Pipe			
3G Part No		DIN8AA011	
Clamp 1	Seal 1	Clamp 2	Seal 2
DIN80921		DIN80921	

VOLVO		FM	
Euro 5		Vertical	
Type:	D8B		
Capacity:	9.4Ltr		
Type:	D11B		
Capacity:	10.8Ltr		
Type:	D13A		
Capacity:	12.8Ltr		
			
Flexi Pipe			
3G Part No		DIN8AA011	
Clamp 1	Seal 1	Clamp 2	Seal 2
DIN80921		DIN80921	

VOLVO		FH, FM	
Euro 5		Horizontal	
Type:	D13C		
Capacity:	12.8Ltr		
			
Flexi Pipe			
3G Part No		DIN8AA012	
Clamp 1	Seal 1	Clamp 2	Seal 2
DIN80921	DIN80920	DIN80921	

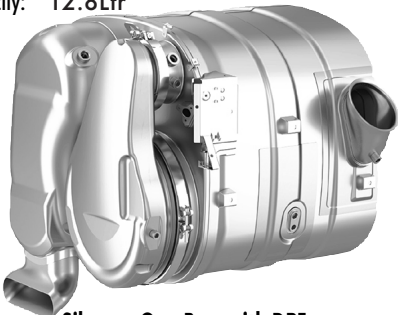
VOLVO		FH, FM	
Euro 6		Horizontal	
Type:	D11		
Capacity:	10.8Ltr		
Type:	D13		
Capacity:	12.8Ltr		
			
Silencer One Box with DPF			
3G Part No		DIN8AC000	
Clamp 1	Seal 1	Clamp 2	Seal 2
DIN80921	DIN78843	DIN80921	

VOLVO		FMX	
Euro 6		Vertical	
Type:	D13		
Capacity:	12.8Ltr		
			
Front Flexi Pipe			
3G Part No		DIN8AE013	
Clamp 1	Seal 1	Clamp 2	Seal 2
DIN80921		DIN80921	

VOLVO		FH, FM	
Euro 6		Horizontal	
Type:			
Capacity:			
			
Flexi Pipe			
3G Part No		DIN8AE024	
Clamp 1	Seal 1	Clamp 2	Seal 2
DIN80921		DIN80921	

VOLVO		FH, FM	
Euro 2, 3, 4			
Type:			
Capacity:			
			
Flexi Clamp 4" (102mm) Aluminium			
3G Part No		DIN99302R	

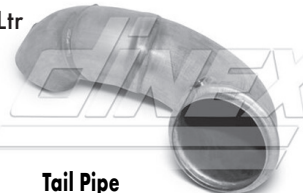
VOLVO		FH, FM	
Euro 6		Horizontal	
Type:	D13		
Capacity:	12.8Ltr		
			
Front Flexi Pipe			
3G Part No		DIN8AE035	
Clamp 1	Seal 1	Clamp 2	Seal 2
DIN80910	DIN8AL001	DIN80921	DIN78843
			
Tail Pipe			
3G Part No		DIN8AG000	
Clamp 1	Seal 1	Clamp 2	Seal 2
DIN80921			

VOLVO		FH, FM	
Euro 6		Horizontal	
Type:			
Capacity:			
			
Tail Pipe			
3G Part No		DIN8AG021	
Clamp 1	Seal 1	Clamp 2	Seal 2
DIN80921			