

Stellar® Service Cranes and TMAX™ Service Bodies

14530



TECHNICAL SPECIFICATION GUIDE



Our People. Our Products.

STELLAR® I4530 TECHNICAL SPECIFICATION GUIDE

SPECIFICATION INFORMATION

Crane Rating:	82,600 ft-lbs (11.42 ton-m)*
Standard Boom Length:	13' 4" (4.06 m) from CL of Crane
Boom Extension:	
• 1st stage:	Hydraulic 100" (254 cm)
• 2nd stage:	Hydraulic 100" (254 cm)
Max. Horizontal Reach:	30' (9.14 m) from CL of Crane
Max. Vertical Lift: (from crane base)	31' 9" (9.68 m)
Boom Elevation:	-10° to +80°
Stowed Height: (crane only)	43" (102.9 cm)
Mounting Space Required:	25" x 22" (63.5 x 55.9 cm)
Approximate Crane Weight:	3,100 lbs (1,406 kg)
Controls:	Radio control standard for all functions.
Winch	
• Rope Diameter:	1/2" (1.27 cm)
• Line pull speed:	60 ft/min (18.29 m)
• Max. single part line:	7,000 lbs (3,175 kg)
• Max. double part line:	14,000 lbs (6,350 kg)
Rotation:	400° power (worm gear)
Lifting Capacities:	14,000 lbs @ 5' (6,350 kg @ 1.52 m)** 2,750 lbs @ 30' (1,247 kg @ 9.14 m)**
Power Supply Required:	PTO & Pump 12 gpm @ 2600 psi (45.4 lpm @ 180 bars)
Min. Rec. Chassis (GVRW)	33,000

NOTE: All Stellar cranes meet ANSI B30.5 and OSHA 1910.180 specifications. Specifications subject to change without notification.

*Crane rating in Boost Mode. Normal crane rating is 70,000 ft-lbs (9.68 ton-m)

**Maximum capacities in Boost Mode.

DEFINING CHARACTERISTICS

Stellar® CDTplus™ (Crane Dynamics Technology Plus™)

The Stellar CDTplus control system is EXCLUSIVE TO STELLAR and features a NEW handheld transmitter with an over-molded rubber bumper system to maximize durability while keeping it lightweight. The new LCD display features operator feedback including real time load capacity, maximum distance with the current load, boom angle, and percentage of load. The boost feature allows a momentary increase in the capacity of the crane, and a Safe Mode to keep the crane and operator safe should a load indicating device fail to operate correctly. The new Stellar CDTplus remote handle features a rechargeable battery and an in-cab docking and recharging station.

Full Hydraulic Extension

This crane offer 30' of all hydraulic reach. No manual extensions.

Market Leading Boom Articulation

The Stellar CDTplus cranes offer -10 degrees to +80 degree. This gives the operator both easy reach to snatch block stowing and the best ability to load items into the load bed.

Quick Release Snatch Block Stow

The Stellar quick release snatch block stow is installed on the underside of the boom to easily stow your snatch block after use. Plus, its unique design gently releases the snatch block for use when the boom is raised at close to 60 degrees to ensure a safe and orderly deployment.

On-Demand Speed Control

The Stellar exclusive on-demand speed control ramps engine RPM up only when the crane is being used. When the crane is not used for 5 seconds engine RPM returns to idle. This lowers fuel consumption and reduces noise pollution in the work area.

Maximum Foot-Pound Rating

The Stellar CDTplus series cranes offers robust ft. lb. ratings during standard mode and increases that by 18% during "Boost" mode to help you get maximum lift when you need it most.

Planetary Winch

The planetary winch on every crane manufactured by Stellar was designed to match the capacity and hydraulic control system. It lifts the maximum crane load and offers the smoothest and fastest speeds in the market today to help keep your productivity at maximum levels.

400 Degree Rotation

Stellar uses a durable rotation system with a cast iron base and an internal mechanical stop to provide the most durable rotation system found in the industry.

Greaseable Pivot Bushings

Each pivot pin location on the CDTplus series crane includes bushings and grease zerks to provide for years of use.

Hexagonal Booms

Stellar Industries made the hexagonal boom design famous in the telescopic service crane market. The hexagonal boom design is optimized to deliver dramatically less boom flex and side to side movement than other boom designs on the market.

Flip Sheave with Bar Style Anti-Two Block

The Stellar CDTplus series is available standard with our patent pending flip sheave with a bar style ATB. The flip sheave allows for a shorter horse head profile which allows for boom placement in tight quarters, such as an equipment cab.

14530 CAPACITY CHART

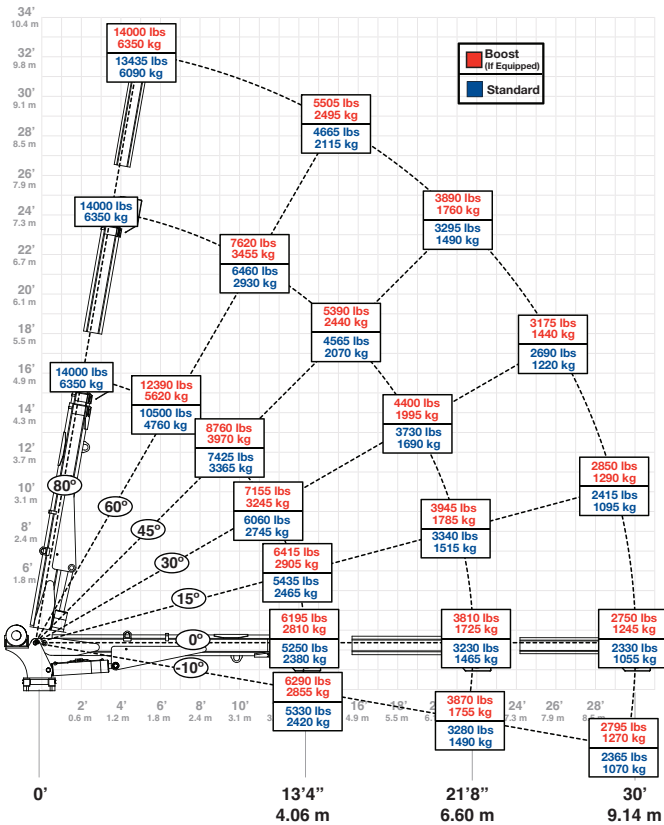

Weight of load handling devices are part of the load lifted and must be deducted from the capacity.

Maximum 1 - part line capacity is 7000 lbs. (3175 kg). For greater loads, use 2 - part line.

GEOMETRIC DIMENSIONS

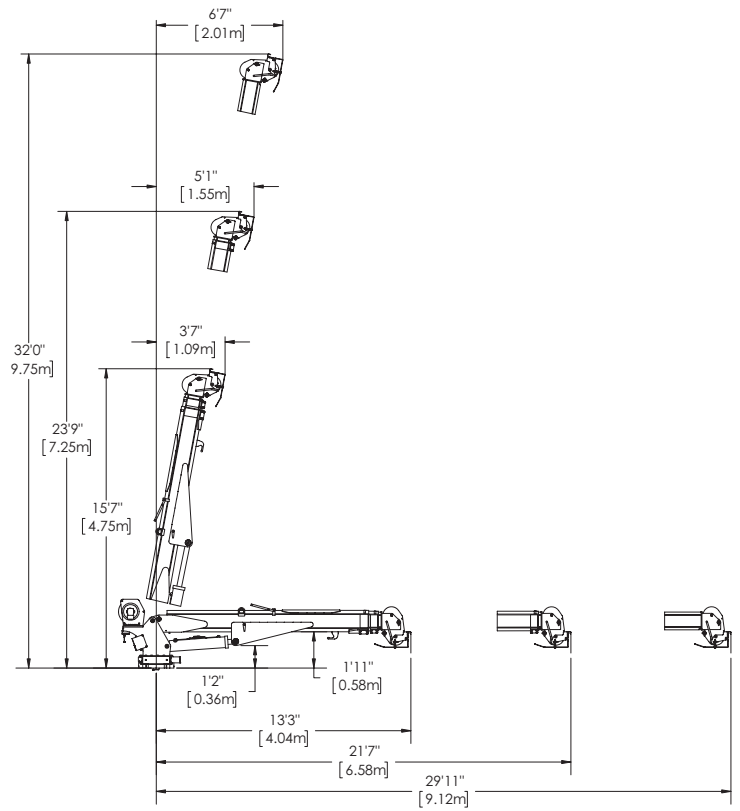

ROTATIONAL CLEARANCE

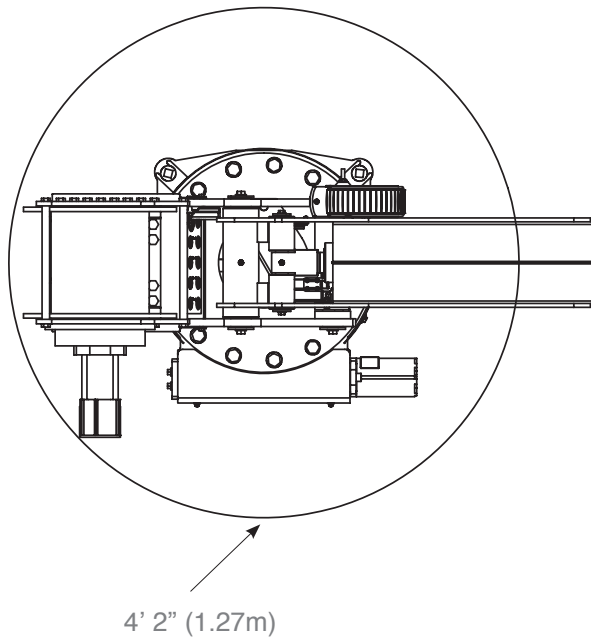

HOLE MOUNTING DETAIL

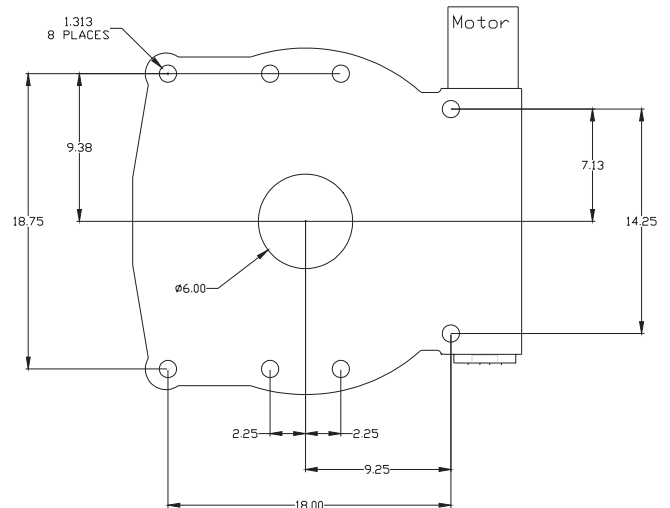

Stellar® TMAX3™ Service Body

Applicable Chassis: 33,000 GVWR Chassis and up

Crane Models: 14530

Cab to Axle: 120" (304.8 cm)

Body Length Nominal: 157" (398.78 cm)

Body Height: 52"/60" (132.1/152.4 cm)

Body Width: 96" (243.84 cm)

Compartment Depth: 22" (55.88 cm)

Floor Width: 50"/52" (127/132.1 cm)

Net Weight: 5,200 lbs (2,358.68 kg)

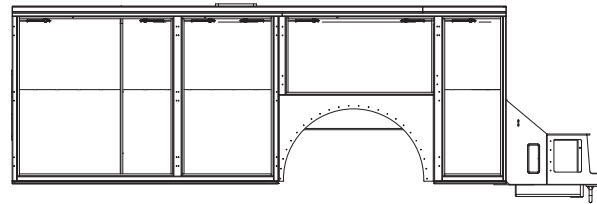
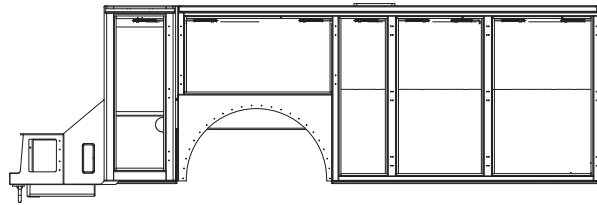

Optional Stellar® TMAX3T™ tandem body available.

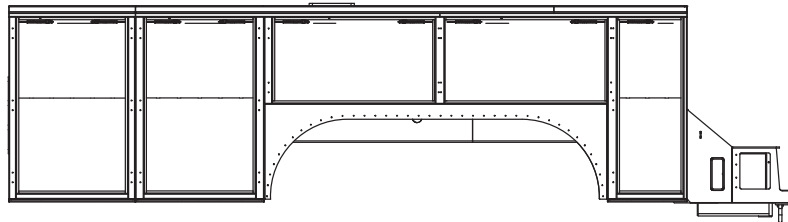
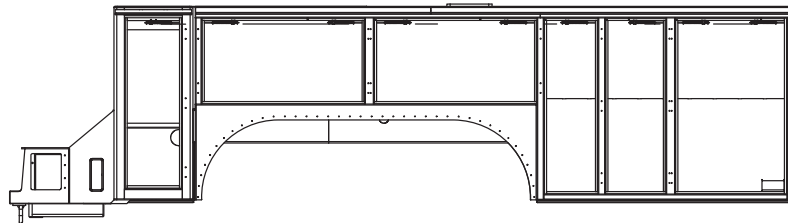

Your local distributor:



Our People. Our Products.

190 State Street
P.O. Box 169
Garner, IA 50438
Telephone: (641) 923-3741 • (800) 321-3741
Fax: (641) 923-2812
Internet: www.stellarindustries.com
Email: sales@stellarindustries.com

An Employee Owned Company.
Copyright © 2018 Stellar Industries, Inc.
STL000101 9/18